



Design of Riprap Revetment

HEC 11

Metric Version

Welcome
to HEC
11-Design
of Riprap
Revetment.



[Table of Contents](#)



[Preface](#)



[Tech Doc](#)



[U.S. - SI Conversions](#)

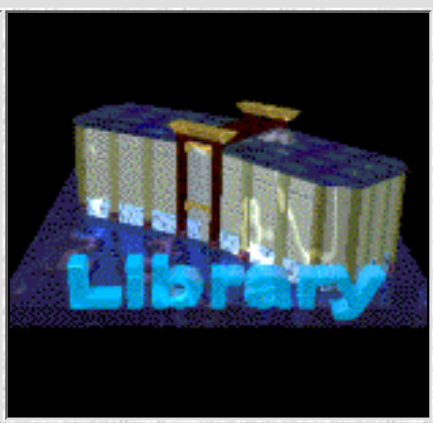

DISCLAIMER: During the editing of this manual for conversion to an electronic format, the intent has been to convert the publication to the metric system while keeping the document as close to the original as possible. The document has undergone editorial update during the conversion process.



[↻ List of Figures](#) [↻ List of Tables](#) [↻ List of Charts & Forms](#) [↻ List of Equations](#) [↻](#)



[Cover Page : HEC 11-Design of Riprap Revetment \(Metric\)](#)



[Chapter 1 : HEC 11 Introduction](#)

- ▶ [1.1 Scope](#)
- ▶ [1.2 Recognition of Erosion Potential](#)
- ▶ [1.3 Erosion Mechanisms and Riprap Failure Modes](#)



[Chapter 2 : HEC 11 Revetment Types](#)

- ▶ [2.1 Riprap](#)
 - ▶ [2.1.1 Rock Riprap](#)
 - ▶ [2.1.2 Rubble Riprap](#)
- ▶ [2.2 Wire-Enclosed Rock](#)
- ▶ [2.3 Pre-Cast Concrete Block](#)
- ▶ [2.4 Grouted Rock](#)
- ▶ [2.5 Paved Lining](#)



[Chapter 3 : HEC 11 Design Concepts](#)

- ▶ [3.1 Design Discharge](#)
- ▶ [3.2 Flow Types](#)
- ▶ [3.3 Section Geometry](#)
- ▶ [3.4 Flow in Channel Bends](#)
- ▶ [3.5 Flow Resistance](#)
- ▶ [3.6 Extent of Protection](#)
 - ▶ [3.6.1 Longitudinal Extent](#)
 - ▶ [3.6.2 Vertical Extent](#)
 - ▶ [3.6.2.1 Design Height](#)
 - ▶ [3.6.2.2 Toe Depth](#)



[Chapter 4 : HEC 11 Design Guidelines for Rock Riprap](#)

- ▶ [4.1 Rock Size](#)
 - ▶ [4.1.1 Particle Erosion](#)
 - ▶ [4.1.1.1 Design Relationship](#)
 - ▶ [4.1.1.2 Application](#)
 - ▶ [4.1.2 Wave Erosion](#)
 - ▶ [4.1.3 Ice Damage](#)
- ▶ [4.2 Rock Gradation](#)
- ▶ [4.3 Layer Thickness](#)

- ▶ [4.4 Filter Design](#)
 - ▶ [4.4.1 Granular Filters](#)
 - ▶ [4.4.2 Fabric Filters](#)
- ▶ [4.5 Material Quality](#)
- ▶ [4.6 Edge Treatment](#)
- ▶ [4.7 Construction](#)



[Chapter 5 : HEC 11 Rock Riprap Design Procedure](#)

- ▶ [5.1 Preliminary Data Analysis](#)
- ▶ [5.2 Rock Sizing \(Form 1\)](#)
- ▶ [5.3 Revetment Details](#)
- ▶ [5.4 Design Examples](#)
 - ▶ [5.4.1 Example Problem #1](#)
 - ▶ [5.5.2 Example Problem #2](#)



[Chapter 6 : HEC 11 Guidelines for Other Revetments](#)

- ▶ [6.1 Wire-Enclosed Rock](#)
 - ▶ [6.1.1 Mattresses](#)
 - ▶ [6.1.1.1 Design Guidelines for Rock and Wire Mattresses](#)
 - ▶ [6.1.1.2 Construction](#)
 - ▶ [6.1.2 Stacked Block Gabions](#)
 - ▶ [6.1.2.1 Design Guidelines for Stacked Block Gabions](#)
 - ▶ [6.1.2.2 Construction](#)
- ▶ [6.2 Pre-Cast Concrete Blocks](#)
 - ▶ [6.2.1 Design Guidelines for Pre-Cast Concrete Blocks](#)
 - ▶ [6.2.2 Construction](#)
- ▶ [6.3 Grouted Rock](#)
 - ▶ [6.3.1 Design Guidelines for Grouted Rock](#)
 - ▶ [6.3.2 Construction](#)
- ▶ [6.4 Concrete Pavement](#)
 - ▶ [6.4.1 Design Guidelines for Concrete Pavement](#)
 - ▶ [6.4.2 Construction](#)



[Appendix A : HEC 11 Suggested Specifications](#)

- ▶ [7.1 Riprap](#)
 - ▶ [7.1.1 Description](#)
 - ▶ [7.1.2 Materials](#)
 - ▶ [7.1.3 Construction Requirements](#)
 - ▶ [I. Minimum Quality Standards](#)
 - ▶ [II. Minimum Hydraulic Properties](#)
 - ▶ [7.1.4 Measurement for Payment](#)

▶ [7.1.5 Basis for Payment](#)

▶ [7.2 Wire-Enclosed Rock](#)

▶ [7.2.1 Description](#)

▶ [7.2.2 Materials](#)

▶ [7.2.3 Construction Requirements](#)

▶ [7.2.4 Measurement for Payment](#)

▶ [7.2.5 Basis for Payment](#)

▶ [7.3 Grouted Rock Riprap](#)

▶ [7.3.1 Description](#)

▶ [7.3.2 Materials](#)

▶ [7.3.3 Construction Requirements](#)

▶ [7.3.4 Measurement for Payment](#)

▶ [7.3.5 Basis for Payment](#)

▶ [7.4 Pre-Cast Concrete Blocks](#)

▶ [7.4.1 Description](#)

▶ [7.4.2 Materials](#)

▶ [7.4.3 Construction Requirements](#)

▶ [7.4.4 Measurement for Payment](#)

▶ [7.4.5 Basis for Payment](#)

▶ [7.5 Paved Lining](#)

▶ [7.5.1 Description](#)

▶ [7.5.2 Materials](#)

▶ [7.5.3 Construction Requirements](#)

▶ [7.5.4 Measurement for Payment](#)

▶ [7.5.5 Basis for Payment](#)

 [Appendix B : HEC 11 Stream Bank Protection Products and Manufacturers](#)

▶ [8.1 Gabions](#)

▶ [8.2 Cellular Blocks](#)

▶ [8.3 Bulkheads](#)

▶ [8.4 Filter Fabrics](#)

 [Appendix C : HEC 11 Design Charts and Forms](#)

 [Appendix D : HEC 11 Riprap Design Relationship Development](#)

▶ [10.1 Basic Relationship](#)

▶ [10.2 Design Relationship Calibration](#)

▶ [10.3 Conversion to a Velocity Based Procedure](#)

▶ [10.4 Comparison with Other Methods](#)

 [Glossary](#)









 [References](#)

 [Symbols](#)

 [Back to Table of Contents](#) 

-  [Figure 1. Particle Erosion Failure \(Modified from Blodgett \(6\)\)](#)
-  [Figure 2. Translational Slide Failure \(Modified from Blodgett \(6\)\)](#)
-  [Figure 3. Modified Slump Failure \(Modified from Blodgett \(6\)\)](#)
-  [Figure 4. Slump Failure \(Modified from Blodgett \(6\)\)](#)
-  [Figure 5. Dumped Rock Riprap](#)
-  [Figure 6. Hand-placed Riprap](#)
-  [Figure 7. Plated or Keyed Riprap](#)
-  [Figure 8. Broken Concrete Riprap](#)
-  [Figure 9. Rock and Wire Mattress Revetment](#)
-  [Figure 10. Gabion Basket Revetment](#)
-  [Figure 11. Pre-cast Concrete Block Mat](#)
-  [Figure 12. Grouted Riprap](#)
-  [Figure 13. Concrete Pavement Revetment](#)
-  [Figure 14. Channel Geometry Development](#)
-  [Figure 15. Longitudinal Extent of Revetment Protection](#)
-  [Figure 16. Wave Height Definition Sketch](#)
-  [Figure 17. Definition Sketch; Channel Flow Distribution](#)
-  [Figure 18. Typical Water Surface Profiles Through Bdge Constrictions for Various Types as Indicated \(Modified from Bradley \(40\)\)](#)
-  [Figure 19. Filter Fabric Placement](#)
-  [Figure 20. Typical Riprap Installation: Plan and Flank Detail](#)
-  [Figure 21. Typical Riprap Installation: End View \(bank protection only\)](#)
-  [Figure 22. Launching of Riprap Toe Material](#)
-  [Figure 23. Riprap Design Procedure Flow Chart](#)
-  [Figure 24. Riprap Size Form \(Form 1\); Example 1](#)
-  [Figure 25. Angle of Repose in Terms of Mean Size and Shape of Stone \(Chart 4\); Example 1](#)
-  [Figure 26. Bank Angle Correction Factor \(K1\) Nomograph \(Chart 4\); Example 1](#)
-  [Figure 27. Riprap Size Relationship \(Chart 1\); Example 1](#)

- [Figure 28. Correction Factor for Riprap Size \(Chart 2\); Example 1](#)
- [Figure 29. Material Gradation \(Form 3\); Example 1](#)
- [Figure 30. Roughness Evaluation \(Form 4\); Example 1](#)
- [Figure 31. Channel Cross Section for Example 2, Illustrating Flow and Potential Scour Depths](#)
- [Figure 32. Toe and Flank Details; Example 2](#)
- [Figure 33. Angle of Repose in Terms of Mean Size and Shape of Stone \(Chart 4\); Example 2](#)
- [Figure 34. Bank Angle Correction Factor \(K1\) Nomograph \(Chart 3\); Example 2](#)
- [Figure 35. Riprap Size Relationship \(Chart 1\); Example 2](#)
- [Figure 36. Correction Factor for Riprap Size \(Chart 2\); Example 2](#)
- [Figure 37. Riprap Size Form \(Form 1\); Example 2](#)
- [Figure 38. Material Gradation \(Form 3\); Example 2](#)
- [Figure 39. Revetment Schematic](#)
- [Figure 40. Rock and Wire Mattress Configurations: \(a\) Mattress with Toe Apron; \(b\) Mattress with Toe Wall; \(c\) Mattress with Toe Wall; and \(d\) Mattress of Variable Thickness](#)
- [Figure 41. Rock and Wire Mattress Installation Covering the Entire Channel Perimeter](#)
- [Figure 42. Typical Detail of Rock and Wire Mattress Constructed from Available Wire Fencing Materials](#)
- [Figure 43. Mattress Configuration](#)
- [Figure 44. Flank Treatment for Rock and Wire Mattress Designs: \(a\) Upstream Face; \(b\) Downstream Face](#)
- [Figure 45. Rock and Wire Revetment Mattress Installation](#)
- [Figure 46. Mattress Placement Underwater by Crane](#)
- [Figure 47. Pontoon Placement of Wire Mattress](#)
- [Figure 48. Typical Stacked Block Gabion Revetment Details: \(a\) Training Wall with Counterforts; \(b\) Stepped Back Low Retaining Wall with Apron; \(c\) High Retaining Wall, Stepped-Back Configuration; \(d\) High Retaining Wall, Batter Type](#)
- [Figure 49. Gabion Basket Fabrication](#)
- [Figure 50. Section Details for \(a\) Stepped Back and \(b\) Battered Gabion Retaining Walls](#)
- [Figure 51. Monoslab Revetment \(a\) Block Detail and \(b\) Revetment Detail](#)
- [Figure 52. Armorflex \(a\) Block Detail and \(b\) Revetment Configuration](#)
- [Figure 53. Petraflex \(a\) Block Detail and \(b\) Revetment Configuration](#)
- [Figure 54. Articulated Concrete Revetment](#)
- [Figure 55. Tri-lock Revetment](#)

-  [Figure 56. Grouted Riprap Sections: \(a\) Section A-A; \(b\) Section B-B; and \(c\) Section C-C](#)
-  [Figure 57. Required Blanket Thickness as a Function of Flow Velocity](#)
-  [Figure 58. Concrete Paving Detail: \(a\) Plan; \(b\) Section A-A; \(c\) Section B-B](#)
-  [Figure 59. Concrete Pavement Toe Details](#)
-  [Figure 60. Riprap Design Calibration](#)
-  [Figure 61. Comparison of Procedures for Estimating Stone Size on Channel Bank Based on Permissible Velocities](#)
-  [Figure 62. Comparison of Procedures for Estimating Stone Size on Channel Bank Based on Permissible Velocities: Effect of Stability Factor Illustrated](#)
-  [Figure 63. Comparison of Procedures for Estimating Stone Size on Channel Bank Based on Permissible Velocities: Effect of Flow Depth Illustrated](#)

 [Back to Table of Contents](#) 



Chapter 1 : HEC 11

Introduction

[Go to Chapter 2](#)

One of the hazards of placing a highway near a river or stream channel is the potential for erosion of the highway embankment by moving water. If erosion of the highway embankment is to be prevented, bank protection must be anticipated, and the proper type and amount of protection must be provided in the right locations.

Four methods of protecting a highway embankment from stream erosion are available to the highway engineer. These are:

- Relocating the highway away from the stream.
 - Moving the stream away from the highway (channel change).
 - Changing the direction of the current with training works.
 - Protecting the embankment from erosion.
-

1.1 Scope

This circular provides procedures for the design of riprap revetments to be used as channel bank protection and channel linings on larger streams and rivers (i.e., having design discharges generally greater than 1.5 m³/s). For smaller discharges, [HEC-15](#), "Design of Roadside Channels with Flexible Linings," should be used. Procedures are also presented for riprap protection at bridge piers and abutments, but for detailed design, [HEC-18](#) should be used.

It is important to recognize the differences between this circular and [HEC-15](#). [HEC-15](#) is intended for use in the design of small roadside drainage channels where the entire channel section is to be lined. By definition, these channels are usually included within the highway right-of-way, and the channel gradient typically parallels the highway. The procedures of [HEC-15](#) are applicable for channels carrying discharges less than 1.5 m³/s where flow conditions are sufficiently uniform so that average hydraulic conditions can be used for design. In contrast, the design guidelines in this circular apply to the design of riprap revetments on larger streams and rivers where design flow conditions are usually not uniform, and at times can be quite dynamic. Under these conditions, the assumptions under which the procedures of [HEC-15](#) were developed become invalid, and local flow conditions must be considered in the design process.

The emphasis in this circular is on the design of rock riprap revetments. The remaining sections in this chapter cover the recognition of erosion potential, and erosion mechanisms, and riprap failure modes. [Chapter 2](#) covers common riprap types. Although rock riprap is the primary

concern here, other riprap types such as gabions, rubble, pre-formed blocks, grouted riprap, and concrete slab revetments are covered. [Chapter 3](#) covers various design concepts related to the design of riprap revetments; subject areas covered include flow type, design discharge, section geometry (hydraulic vs. design), flow resistance, local conditions and the extent of protection. Design guidelines for rock riprap are presented in [Chapter 4](#); guidelines are provided for rock size, gradation, blanket thickness, and filter design, as well as for the construction and placement of rock riprap revetment. Guidelines for the design of other types of riprap are presented in [Chapter 6](#).

1.2 Recognition of Erosion Potential

Channel stabilization is essential to the design of any structure in the river environment. The identification of the potential for channel bank erosion, and the subsequent need for channel stabilization, is best accomplished through observation. Analytic methods are available for the evaluation of channel stability; however, they should only be used to confirm observations, or in cases where observed data are unavailable.

Observations provide the most positive indication of erosion potential. Observations can be based on historic information, or current site conditions. Aerial photographs, old maps and surveying notes, and bridge design files and river survey data that are available at State departments of transportation and at Federal agencies, as well as gaging station records and interviews of long-time residents can provide documentation of any recent and potentially current channel movement or instabilities.

In addition, current site conditions can be used to evaluate river stability. Even when historic information indicates that a channel has been relatively stable in the past, local conditions may indicate more recent instabilities. Local site conditions which are indicative of channel instabilities include tipping and falling of vegetation along the bank, cracks along the bank surface, the presence of slump blocks, fresh vegetation laying in the channel near the channel banks, deflection of channel flows in the direction of the bank due to some recently deposited obstruction or channel course change, fresh vertical face cuts along the bank, locally high velocities along the bank, new bar formation downstream from an eroding bank, local headcuts, pending or recent cutoffs, etc... It is also important to recognize that the presence of any one of these conditions does not in itself indicate an erosion problem; some bank erosion is common in all channels even when the channel is stable. A more detailed coverage of the analysis of stream stability through the use of historic and current observations is presented in Shen (1).

Analytic methods for the evaluation of channel stability can be classified as either geomorphic or hydraulic. It is important to recognize that these analytic tools should only be used to substantiate the erosion potential indicated through observation. Geomorphic relationships have been presented by many investigators, for example Leopold (2), and Lane (3). More recently these relationships have been summarized by Brown (4), and Richardson (5).

Hydraulic relationships for evaluating channel stability are based on an analysis of site

materials, and the ability of these materials to resist the erosive forces produced by a given design discharge. This approach uses channel shear stresses and local flow velocities to evaluate the stability of the materials through which the channel is cut. However, this technique only provides a point of reference for evaluating the channel's stability against particle erosion. Particle erosion is only one of several common erosion mechanisms which can cause channel bank instability. Erosion mechanisms will be discussed in the next section.

Complete coverage of geomorphic and hydraulic techniques for evaluating erosion potential is beyond the scope of this Circular. For additional information it is recommended that the reader refer to references 2-6.

1.3 Erosion Mechanisms and Riprap Failure Modes

Prior to designing a bank stabilization scheme, it is important to be aware of common erosion mechanisms and riprap failure modes, and the causes or driving forces behind bank erosion processes. Inadequate recognition of potential erosion processes at a particular site may lead to failure of the revetment system.

Many causes of bank erosion and riprap failure have been identified. Some of the more common include abrasion, debris flows, water flow, eddy action, flow acceleration, unsteady flow, freeze/thaw, human actions on the bank, ice, precipitation, waves, toe erosion, and subsurface flows. However, it is most often a combination of mechanisms which cause bank and riprap failure, and the actual mechanism or cause is usually difficult to determine. Riprap failures are better classified by failure mode. Blodgett (6) has identified classic riprap failure modes as follows:

- Particle erosion.
- Translational slide.
- Modified slump.
- Slump.

Particle erosion is the most common erosion mechanism. Particle erosion results when the tractive force exerted by the flowing water exceeds the bank materials ability to resist movement. In addition, if displaced stones are not transported from the eroded area, a mound of displaced rock will develop on the channel bed. This mound has been observed to cause flow concentration along the bank, resulting in further bank erosion.

Particle erosion can be initiated by abrasion, impingement of flowing water, eddy action/reverse flow, local flow acceleration, freeze/thaw action, ice, or toe erosion. Probable causes of particle erosion include:

- Stone size not large enough.
- Individual stones removed by impact or abrasion.
- Side slope of the bank so steep that the angle of repose of the riprap material is easily

exceeded.

- Gradation of riprap too uniform.

[Figure 1](#) illustrates riprap failure by particle erosion.

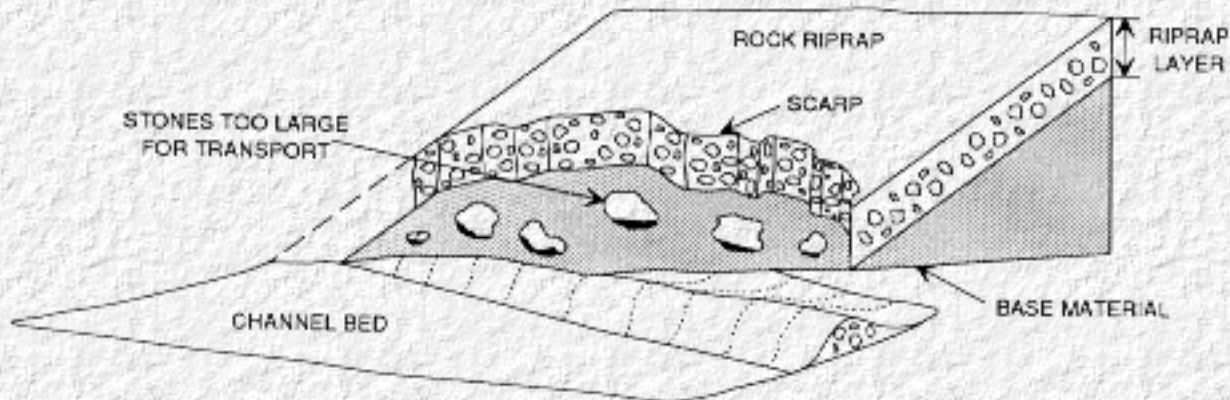

Figure 1. Particle Erosion Failure (Modified from Blodgett (6))

A translational slide is a failure of riprap caused by the downslope movement of a mass of stones, with the fault line on a horizontal plane. The initial phases of a translational slide are indicated by cracks in the upper part of the riprap bank that extend parallel to the channel. As the slide progresses, the lower part of riprap separates from upper part, and moves downslope as a homogeneous body. A resulting bulge may appear at the base of the bank if the channel bed is not scoured.

Translational slides are usually initiated when the channel bed scours and undermines the toe of the riprap blanket. This could be caused by particle erosion of the toe material, or some other mechanism which causes displacement of toe material. Any other mechanism which would cause the shear resistance along the interface between the riprap blanket and base material to be reduced to less than the gravitational force could also cause a translational slide. It has been suggested that the presence of a filter blanket may provide a potential failure plane for translational slides (6). Probable causes of translational slides are as follows:

- Bank side slope too steep.
- Presence of excess hydrostatic (pore) pressure.
- Loss of foundation support at the toe of the riprap blanket caused by erosion of the lower part of the riprap blanket (6).

[Figure 2](#) illustrates a typical translational slide.

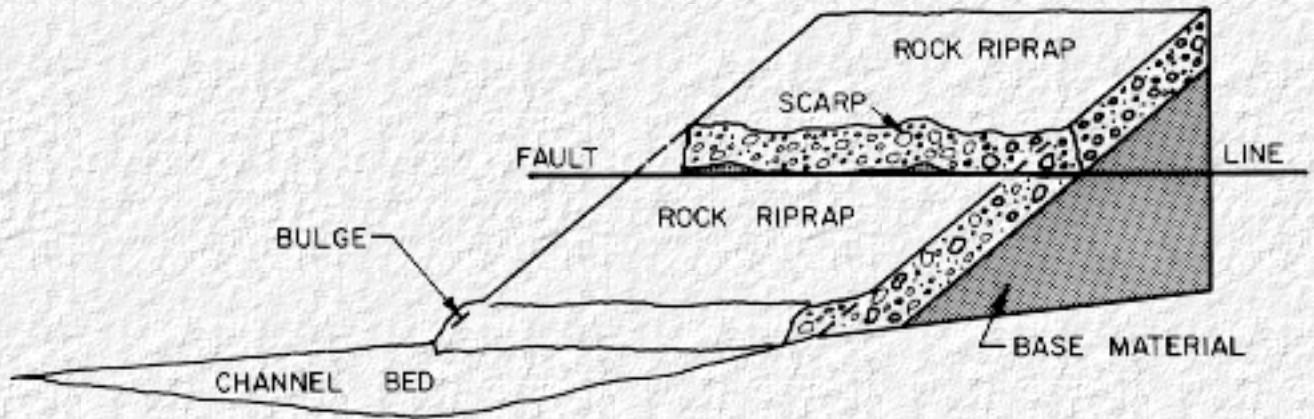

Figure 2. Translational Slide Failure (Modified from Blodgett (6))

The failure of riprap referred to as modified slump is the mass movement of material along an internal slip surface within the riprap blanket; the underlying material supporting the riprap does not fail. This type of failure is similar in many respects to the translational slide, but the geometry of the damaged riprap is similar in shape to initial stages of failure caused by particle erosion. Probable causes of modified slump are:

- Bank side slope is so steep that the riprap is resting very near the angle of repose, and any imbalance or movement of individual stones creates a situation of instability for other stones in the blanket.
- Material critical to the support of upslope riprap is dislodged by settlement of the submerged riprap, impact, abrasion, particle erosion, or some other cause (6).

[Figure 3](#) illustrates a modified slump failure.

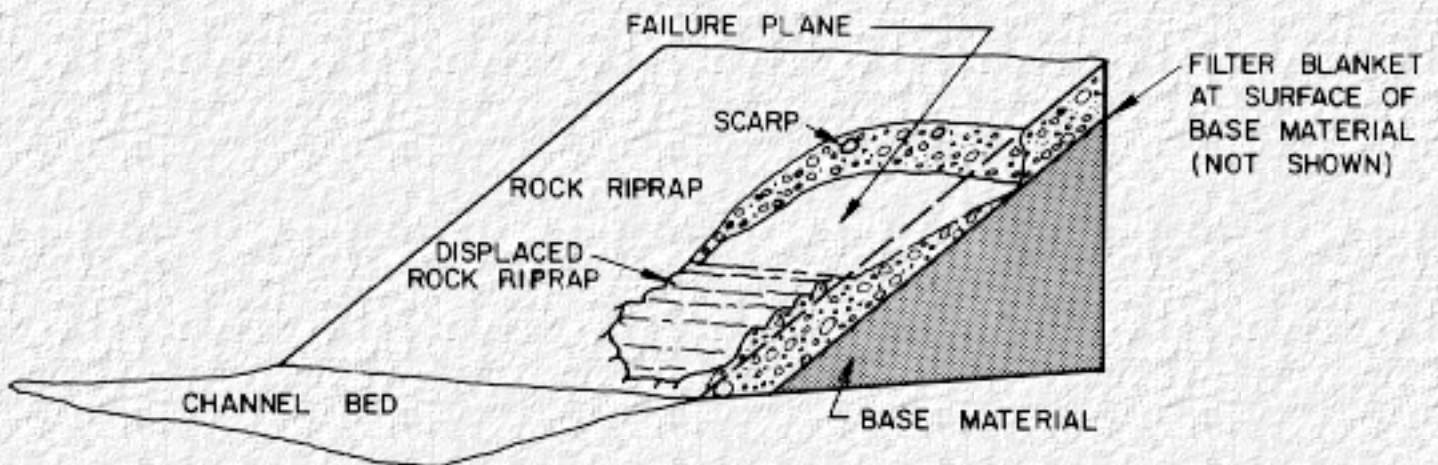

Figure 3. Modified Slump Failure (Modified from Blodgett (6))

Slump is a rotational-gravitational movement of material along a surface of rupture that has a concave upward curve. The cause of slump failures is related to shear failure of the underlying

base material that supports the riprap revetment. The primary feature of a slump failure is the localized displacement of base material along a slip surface, which is usually caused by excess pore pressure that reduces friction along a fault line in the base material. Probable causes of slump failures are:

- Nonhomogeneous base material with layers of impermeable material that act as a fault line when subject to excess pore pressure.
- Side slope too steep, and gravitational forces exceed the inertia forces of the riprap and base material along a friction plane (6).

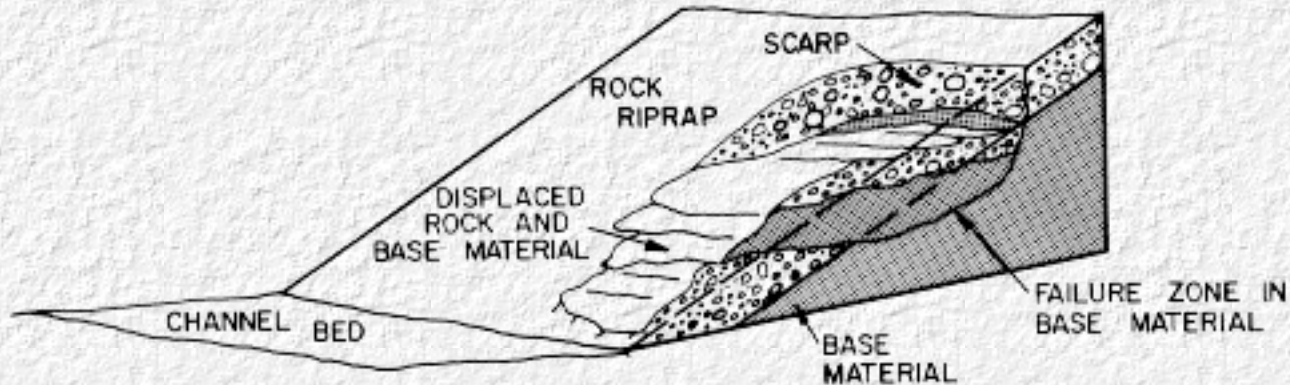

Figure 4. Slump Failure (Modified from Blodgett (6))

Additional details and examples explaining these erosion mechanisms or failure modes are available in reference 6. Note: that the riprap design guidelines presented in this circular apply to particle erosion only. Analysis procedures for other bank failure mechanisms are presented in reference 31.

[Go to Chapter 2](#)



Chapter 2 : HEC 11

Revetment Types

[Go to Chapter 3](#)

The types of slope protection or revetment discussed in this circular include:

- Rock riprap.
- Rubble riprap.
- Wire-enclosed rock (Gabions).
- Pre-formed blocks.
- Grouted rock.
- Paved Lining.

Descriptions of each of these revetment types are included in the sections. Note: wire-enclosed rock, pre-formed block, grouted rock, and concrete slab revetments listed above are rigid or of only limited flexibility, and do not conform to the definition of riprap. These revetments have been historically discussed with flexible riprap, and therefore are included in this circular.

2.1 Riprap

Riprap has been described as a layer or facing of rock, dumped or hand-placed to prevent erosion, scour, or sloughing of a structure or embankment. Materials other than rock are also referred to as riprap; for example, rubble, broken concrete slabs, and preformed concrete shapes (slabs, blocks, rectangular prisms, etc.). These materials are similar to rock in that they can be hand-placed or dumped onto an embankment to form a flexible revetment.

In the context of this circular, riprap is defined as:

"A flexible channel or bank lining or facing consisting of a well graded mixture of rock, broken concrete, or other material, usually dumped or hand-placed, which provides protection from erosion."

As described above, riprap is a flexible revetment. Flexibility of the riprap mass is due to individual particles acting independently within the mass. In the past, the term "riprap" has often been extended to include mortared and grouted riprap, concrete riprap in bags (sacked concrete), and concrete slab riprap, as well as other rigid revetments. However, the materials which make up these revetments are not singular; as a result, the entire revetment must act or move together. These revetment materials will not be considered as riprap here since they fall outside the definition given above.

2.1.1 Rock Riprap

Rock riprap is the most widely used and most desirable type of revetment in the United States. It is compatible with most environmental settings. The term "riprap" is most often used to refer to rock riprap. For purposes of description, rock riprap is further subdivided by placement method into dumped riprap, hand-placed riprap, and plated riprap.

Dumped riprap is graded stone dumped on a prepared slope in such a manner that segregation will not take place. Dumped riprap forms a layer of loose stone; individual stones can independently adjust to shifts in or movement of the base material. The placement of dumped riprap should be done by mechanized means, such as crane and skip, dragline, or some form of bucket. End dumping from trucks down the riprap slope causes segregation of the rock by size, reducing its stability, and therefore, should not be used as a means of placement. The effectiveness of dumped riprap has been well established where it is properly installed, of adequate size, and suitable size gradation. Advantages associated with the use of dumped rock riprap include:

- The riprap blanket is flexible and is not impaired or weakened by minor movement of the bank caused by settlement or other minor adjustments.
- Local damage or loss can be repaired by placement of more rock.
- Construction is not complicated.
- When exposed to fresh water, vegetation will often grow through the rocks, adding esthetic and structural value to the bank material and restoring natural roughness.
- Riprap is recoverable and may be stockpiled for future use. Note: that slope failure processes as discussed in [Chapter 1](#) will cause riprap damage.

One drawback to the use of rock riprap revetments is that they are more sensitive than some other bank-protection schemes to local economic factors. For example, freight/haul costs can significantly affect the cost of these revetments. [Figure 5](#) illustrates a dumped riprap installation.



Figure 5. Dumped Rock Riprap

Hand-placed riprap is stone laid carefully by hand or by derrick following a definite pattern, with the voids between the larger stones filled with smaller stones and the surface kept relatively even. The need for interlocking stone in a hand-placed revetment requires that the stone be relatively uniform in size and shape (square or rectangular).

Advantages associated with the use of hand-placed riprap include:

- The even interlocking surface produces a neat appearance and reduces flow turbulence at the water revetment interface.
- The support provided by the interlocking of individual stones permits the use of hand-placed riprap revetments on steeper bank slopes than is possible with the same size loose stone riprap.
- With hand-placed riprap, the blanket thickness can usually be reduced to 150 to 300 mm less than a loose riprap blanket, resulting in the use of less stone (25).

Disadvantages associated with hand-placed riprap include:

- Installation is very labor-intensive, resulting in high costs.
- The interlocking of individual rocks in hand-placed revetments results in a less flexible revetment; as mentioned above, a small shift in the base material of the bank can cause failure of large segments of the revetment.
- By their nature, hand-placed rock riprap revetments are more expensive to repair than are loose rock revetments.



Figure 6. Hand-placed Riprap

Plated or keyed riprap is similar to hand-placed riprap in appearance and behavior, but different in placement method. Plated riprap is placed on the bank with a skip and then tamped into place using a steel plate, thus forming a regular, well organized surface. Experience indicates that during the plating operation, the larger stones are fractured, producing smaller rock sizes to fill voids in the riprap blanket.

Advantages and disadvantages associated with the use of plated riprap are similar to those listed above for hand-placed riprap. As with hand-placed riprap, riprap plating permits the use of steeper bank angles, and a reduction in riprap layer thickness (usually 150-300 mm less than loose riprap). Experience also indicates that riprap plating also permits the use of smaller stone sizes when compared with loose riprap. Like hand-placed riprap, riprap plating results in a more rigid riprap lining than loose riprap. This makes it susceptible to failure as a result of minor bank settlement. However, plated riprap installation is not as labor-intensive as that of hand-placed riprap. [Figure 7](#) illustrates a plated riprap installation under construction.



Figure 7. Plated or Keyed Riprap

2.1.2 Rubble Riprap

Types of rubble which have been used as riprap include **rock spoils**, **broken concrete**, and **steel furnace slag**.

Rock spoils are often available from road cut or other excavation sites.

Broken concrete is available in areas undergoing widespread urban renewal involving the demolition of buildings and other structures made from concrete.

Steel furnace slag is sometimes available in the vicinity of steel smelting plants.

Because it is usually considered to be a waste material, rubble is a very economical riprap material. Advantages and disadvantages to the use of rubble are quite similar to those listed previously for rock riprap.

The successful use of rubble as riprap requires good control on material quality. The quality of a rubble material includes its shape, specific weight, gradation, and durability (resistance to weathering). The shape of rubble riprap is often a problem (particularly concrete rubble). The length to width ratio of any riprap material should be 1:3 or less (19) . Plating of rubble riprap will often break the material sufficiently to reduce the length to width ratio of most of the material to less than 1:3. The material's specific weight can be accounted for in the design procedure for sizing the material. However, in many instances the rubble material will not contain an appropriate mix of particle sizes to form an adequate riprap material. This can be overcome by a crushing operation, or by plating the rubble after placement. (As

indicated previously, riprap plating fractures the larger riprap material; the smaller fractured material then fills the voids between the larger material, improving the gradation of the final installation.) The recommended placement method for rubble riprap is plating.

The lack of adequate material durability can cause the failure of rubble riprap. Rock spoils consisting of a high percentage of shale or other materials consisting of weakly layered structures are not suitable. Also, materials subject to chemical breakdown or high rates of weathering are not suitable. [Figure 8](#) illustrates a site where broken concrete was used as the riprap material.



Figure 8. Broken Concrete Riprap

2.2 Wire-Enclosed Rock

Wire-enclosed rock, or gabion, revetments consist of rectangular wire mesh baskets filled with rock. These revetments are formed by filling pre-assembled wire baskets with rock, and anchoring to the channel bottom or bank. Wire-enclosed rock revetments are generally of two types distinguished by shape:

1. **Rock and Wire-Mattresses**, In mattress designs, the individual wire mesh units are laid end to end and side to side to form a mattress layer on the channel bed or bank. The gabion baskets comprising the mattress generally have a depth dimension which is much smaller than their width or length.
2. **Block Gabions**, On the other hand, are more equidimensional, having depths that are approximately the same as their widths, and of the same order of magnitude as their lengths. They are typically rectangular or trapezoidal in shape. Block gabion revetments are formed by stacking the individual gabion blocks in a stepped fashion.

As revetments, wire-enclosed rock has limited flexibility. They will flex with bank surface subsidence; however, if excessive subsidence occurs, the baskets will span the void until the stresses in rock-filled baskets exceed the tensile strength of the wire strands. At this point the baskets will fail.

The conditions under which wire-enclosed rock is applicable are similar to those of other revetments. However, their economic use is limited to locations where the only rock available economically is too small for use as rock riprap slope protection.

The primary advantages of wire-enclosed rock revetments include:

- Their ability to span minor pockets of bank subsidence without failure.
- The ability to use smaller, lower quality, and less dense, rock in the baskets.

The primary disadvantages of wire-enclosed rock revetments include:

- Susceptibility of the wire baskets to corrosion and abrasion damage.
- High labor costs associated with fabricating and filling the wire baskets.
- More difficult and expensive repair than standard rock protection.
- Less flexibility than standard rock protection.

Besides its use as a general bank revetment, wire-enclosed rock in the form of either mattresses or blocks is also used as bank toe protection. In some instances the wire-enclosed rock is used alone for protection of the bank also. In other cases, the wire-enclosed rock is used as toe protection along with some other bank revetment.

The most common failure mechanism of wire basket revetments has been observed to be failure of the wire baskets. Failure from abrasion and corrosion of the wire strands has even been found to be a common problem when the wire is coated with plastic. The plastic coating is often stripped away by abrasion from sand, gravel, cobbles, or other sediments carried in natural stream flows (particularly at and near flood stages). Once the wire has been broken, the rock in the baskets is usually washed away. To avoid the problem of abrasion and corrosion of the wire baskets, it is recommended that wire-enclosed rock revetments not be used on lower portions of the channel bank in environments subject to significant abrasion or corrosion.

An additional failure mechanism has been observed when the wire basket units are used in high-velocity, steep-slope environments. Under these conditions, the rock within individual baskets shifts downstream, deforming the baskets as the material moves. The movement of material within individual baskets will sometimes result in exposure of filter or base material. Subsequent erosion of the exposed base material can cause failure of the revetment system.

A common misconception with rock and gabion revetments is that a heavy growth of vegetation will occur through the stone and wire mesh. Experience indicates that in many cases there is not sufficient soil retained within the baskets to promote significant vegetative growth. The exception to this is in areas subjected to significant deposition of fine materials (such as in the vicinity of bars). In areas where the baskets are frequently submerged by an active flow, vegetative growth will not be promoted.

Wire-enclosed rock revetments are classified by geometry as mattress or block type

revetments. **Rock and wire mattress revetments** consist of flat wire baskets. The individual mattress sections are laid end to end and side to side on a prepared channel bed or bank to form a continuous mattress. The individual basket units are attached to each other and anchored to the base material. [Figure 9](#) illustrates a typical rock and wire mattress installation.

Block gabion revetments consist of rectangular wire baskets which are stacked in a stepped-back fashion to form the revetment surface. Gabion baskets are best used as bank protection where the bank is too steep for conventional rock riprap revetments. Gabion baskets can be stacked to form almost vertical banks (looking much like retaining walls) making them useful in areas where the banks cannot economically be graded to the stable slope required for other riprap types. [Figure 10](#) illustrates a typical block gabion installation.



Figure 9. Rock and Wire Mattress Revetment



Figure 10. Gabion Basket Revetment

2.3 Pre-Cast Concrete Block

Pre-cast concrete block revetments are a recent development. The pre-formed sections which comprise the revetment systems are butted together or joined in some fashion; as such, they form a continuous blanket or mat. The concrete blocks which make up the mats differ in shape and method of articulation, but share certain common features. These features include flexibility, rapid installation, and provisions for establishment of vegetation within the revetment. The permeable nature of these revetments permits free draining of the bank materials; the flexibility, although limited, allows the mattress to conform to minor changes in the bank geometry. Their limited flexibility, however, makes them subject to undermining in environments characterized by large fluctuations in the surface elevation of the channel bed and/or bank. Unlike wire-enclosed rock, the open nature of the pre-cast concrete blocks does promote volunteering of vegetation within the revetment.

The most significant drawbacks to the use of pre-cast concrete blocks are their limited flexibility and cost. As discussed above, their limited flexibility makes them subject to undermining in environments characterized by dynamic bed level fluctuations; failures have been observed where a corner or edge of the mattress is undercut, resulting in complete failure of the revetment. Pre-cast concrete block designs have also been shown to be expensive. For this reason, their use is usually limited to large rivers, areas where structures of significant value need to be protected, or where riprap is not readily available. [Figure 11](#) illustrates a revetment consisting of pre-cast, interlocking blocks.



Figure 11. Pre-cast Concrete Block Mat

2.4 Grouted Rock

Grouted rock revetment consists of rock slope-protection having voids filled with concrete grout to form a monolithic armor. Grouted rock is a rigid revetment; it will not conform to changes in the bank geometry due to settlement. As with other monolithic revetments, grouted rock is particularly susceptible to failure from undermining and the subsequent loss of the supporting bank material. Although it is rigid, grouted rock is not extremely strong; therefore, the loss of even a small area of bank support can cause failure of large portions of the revetment.

The use of grouted rock is usually confined to areas where rock of sufficient size for ordinary rock-slope protection is not economically available, or where a reasonably smooth revetment surface is desired (for reasons of safety or flow efficiency). The use of grouted rock can reduce the quantity of rock required; grouting anchors the rock, and integrates a greater material mass to resist the hydraulic forces it is exposed to. Also, if the embankment material is fine grained, grouting will eliminate the need for filter material that may be necessary with other rock slope-protection.

Grouting can double the cost per unit volume of stone. However, the ability to use smaller stones and thinner stone layers in grouted rock revetments than in ungrouted rock riprap offsets some of the additional cost of the grout. [Figure 12](#) illustrates a grouted riprap installation.



Figure 12. Grouted Riprap

2.5 Paved Lining

Concrete pavement revetments are cast in place on a prepared slope to provide the necessary bank protection. Like grouted rock, concrete pavement is a rigid revetment which does not

conform to changes in bank geometry due to a removal of foundation support by subsidence, undermining, outward displacement by hydrostatic pressure, slide action, or erosion of the supporting embankment at its ends. The loss of even small sections of the supporting embankment can cause complete failure of the revetment system. Concrete pavement revetments are also among the most expensive streambank protection designs. In the past, concrete pavement has been best utilized as a subaqueous revetment (on the bank below the water surface) with vegetation or some other less expensive upper-bank treatment.

Concrete pavement revetments are required in some instances. The implied structural integrity of the concrete pavements makes them resistant to damage from debris, ice, and other floating objects. Their smooth surface also makes them useful in situations where hydraulic efficiency is of prime importance. They can also be erected on steep bank angles, making them useful in situations where bank grading is not practical. When installed properly, concrete pavement can provide a long useful life, requiring only a minimum of maintenance. [Figure 13](#) illustrates a typical concrete slab revetment installation.



Figure 13. Concrete Pavement Revetment

[Go to Chapter 3](#)



Chapter 3 : HEC 11

Design Concepts

[Go to Chapter 4](#)

Design concepts related to the design of riprap revetments are discussed in this chapter.

Subjects covered include:

- Design discharge.
 - Flow types.
 - Section geometry.
 - Flow in channel bends.
 - Flow resistance.
 - Extent of protection.
-

3.1 Design Discharge

Design flow rates for the design or analysis of highway structures in the vicinity of rivers and streams usually have a 10 to 50-year recurrence interval. In most cases, these discharge levels will also be applicable to the design of riprap and other revetment systems. However, the designer should be aware that in some instances, a lower discharge may produce hydraulically worse conditions with respect to riprap stability. It is suggested that several discharge levels be evaluated to ensure that the design is adequate for all discharge conditions up to that selected as the design discharge for structures associated with the riprap scheme.

A discussion of techniques and procedures for the evaluation of discharge frequency (recurrence interval), risk, and least total economic cost is beyond the scope of this manual. These subjects are covered in detail in references 7 and reference 8 as well as numerous other hydrology texts.

3.2 Flow Types

Open channel flow can be classified from three points of reference. These are:

- Uniform, gradually varying, or rapidly varying flow.
- Steady or unsteady flow.
- Subcritical or supercritical flow.

These flow states, and procedures for identifying them are covered in most open channel flow texts (for example Chow (9), and Simons and Senturk (10)), as well as in numerous general references on open channel flow (for example U.S. Dept. of Agriculture (11), and Richardson et. al. (12)).

Design relationships presented in this manual are based on the assumption of uniform, steady, subcritical flow. These relationships are also valid for gradually varying flow conditions. While the individual hydraulic relationships presented are not in themselves applicable to rapidly varying, unsteady, or supercritical flow conditions, procedures are presented for extending their use to these flow conditions.

Rapidly varying, unsteady flow conditions are common in areas of flow expansion, flow contraction, and reverse flow. These conditions are common at and immediately downstream of bridge crossings. Supercritical or near supercritical flow conditions are common at bridge constrictions and on steep sloped channels.

It has been observed that fully developed supercritical flow rarely occurs in natural channels (13). However, steep channel flow, and flow through constrictions is often in a transitional flow state between subcritical and supercritical. Experimental work conducted by the U.S. Army Corps of Engineers (14) indicates that this transition zone occurs between Froude numbers of 0.89 and 1.13. When flow conditions are within this range, an extremely unstable condition exists in which the inertia and gravity forces are unbalanced. This causes excessive wave action, hydraulic jumps, localized changes in water-surface slope, and extreme flow turbulence.

Non-uniform, unsteady, and near supercritical flow conditions create stresses on the channel boundary that are significantly different from those induced by uniform, steady, subcritical flow. These stresses are difficult to assess quantitatively. The stability factor method of riprap design presented in [Chapter 4](#) provides a means of adjusting the final riprap design (which is based on relationships derived for steady, uniform, subcritical flow) for the uncertainties associated with these other flow conditions. The adjustment is made through the assignment of a stability factor. The magnitude of the stability factor is based on the level of uncertainty inherent in the design flow conditions.

3.3 Section Geometry

Riprap design procedures presented in this manual requires input channel cross-section geometry. The cross section geometry is necessary to establish the hydraulic design parameters (such as flow depth, topwidth, velocity, hydraulic radius, etc.) required by the riprap design procedures, as well as to establish a construction cross section for placement of the revetment material. When the entire channel perimeter is to be stabilized, the selection of an appropriate channel geometry is only a function of the desired channel conveyance properties and any limiting geometric constraints. However, when the channel bank alone is to be protected, the design must consider the existing channel bottom geometry.

The development of an appropriate channel section for analysis is very subjective. The intent is to develop a section which reasonably simulates a worst case condition with respect to riprap stability. Information which can be used to evaluate channel geometry includes current channel surveys, past channel surveys (if available), and current and past aerial photos. In addition, the effect channel stabilization will have on the local channel section must be considered.

The first problem arises when an attempt is made to establish an existing channel bottom

profile for use in design. A survey of the channel at the location of interest would seemingly provide the necessary geometry. However, it has been found that on an annual basis, the cross section area, hydraulic radius, topwidth, mean depth, and maximum depth vary from their long-term means by an average of plus 52 percent and minus 41 percent (15). This suggests that cross section data surveyed at a site during a given year may vary as much as 50 percent from the long-term mean. Therefore, a single channel profile is usually not enough to establish the design cross section.

In addition to current channel surveys, historic surveys can provide valuable information. A comparison of current and past channel surveys at the location provides information on the general stability of the site, as well as a history of past channel geometry changes. Often, past surveys at a particular site will not be available. If this is the case, past surveys at other sites in the vicinity of the design location can be used to evaluate past changes in channel geometry.

The final consideration must always be an evaluation of the impact channel stabilization will have on the channel geometry. Stabilizing a channel's banks will in most instances cause a deepening of the channel. This phenomenon is most notable at channel bends, but is also of significant concern in straight reaches. Bank stabilization has been observed to increase the maximum-to-average depth ratio to approximately 1.7 (15). The maximum-to-average depth ratio is computed using annual average or near bank-full stage conditions. The maximum-to-average depth ratio should be computed based on the current channel geometry. It should be assumed that the cross section will eventually develop to this condition. For the analysis, the section geometry should be deepened at the thalweg to a depth that would produce a maximum-to-average depth ratio of 1.7 or greater.

The process of developing an appropriate channel geometry is illustrated in [Figure 14a](#), [Figure 14b](#), and [Figure 14c](#). [Figure 14a](#) illustrates the location of the design site at position '2' along Route 1. The section illustrated in [Figure 14c](#) was surveyed at this location, and represents the current condition. No previous channel surveys were available at this site. However, data from several old surveys were available in the vicinity of a railroad crossing upstream (location 1). [Figure 14b](#) illustrates this survey data. The surveys in [Figure 14b](#) indicate that there is a trend for the thalweg of the channel to migrate within the right half of the channel. Since location 1 and 2 are along bends of similar radii, it can be reasonably assumed that a similar phenomenon occurs at location 2. A thalweg located immediately adjacent to the channel bank reasonably represents the worst case hydraulically for the section at location 2. Therefore, the surveyed section at location 2 is modified to reflect this. In addition, the maximum section depth (located in the thalweg) is increased to reflect the effect of stabilizing the bank. The maximum depth in the thalweg is set to 1.7 times the average depth of the original section. The final modified section geometry is illustrated in [Figure 14c](#). Note: it is assumed that the average depth before modification of the section is the same as the average depth after modification.

3.4 Flow in Channel Bends

Flow conditions in channel bends are complicated by the distortion of flow patterns in the vicinity of the bend. In long, relatively straight channels, the flow conditions are uniform, and symmetrical about the center line of the channel. However, in channel bends, the centrifugal forces and secondary currents produced lead to non-uniform and non-symmetrical flow conditions.

Two aspects of flow in channel bends impact the design of riprap revetments. First, special consideration must be given to the increased velocities and shear stresses that are generated as a result of non-uniform flow in bends. In the design relationship presented in [Chapter 4](#), this is accomplished by using the maximum cross section depth in place of an average hydraulic radius.

Superelevation of flow in channel bends is another important consideration in the design of riprap revetments. Although the magnitude of superelevation is generally small when compared with the overall flow depth in the bend (usually less than 0.3 m) it should be considered when establishing freeboard limits for bank protection schemes on sharp bends. The magnitude of superelevation at a channel bend may be estimated for subcritical flow by the following equation:

$$Z = C [(V_a^2 T)/(gR_o)] \quad (1)$$

where:

Z = superelevation of the water surface (m),

C = coefficient that relates free vortex motion to velocity streamlines for unequal radius of curvature,

V_a = mean channel velocity (m/s),

T = water-surface width at section (m),

g = gravitational acceleration (m/s^2),

R_o = the mean radius of the channel centerline at the bend (m).

The coefficient C has been recently evaluated (15). The value was found to range between 0.5 and 3.0, with an average of 1.5.

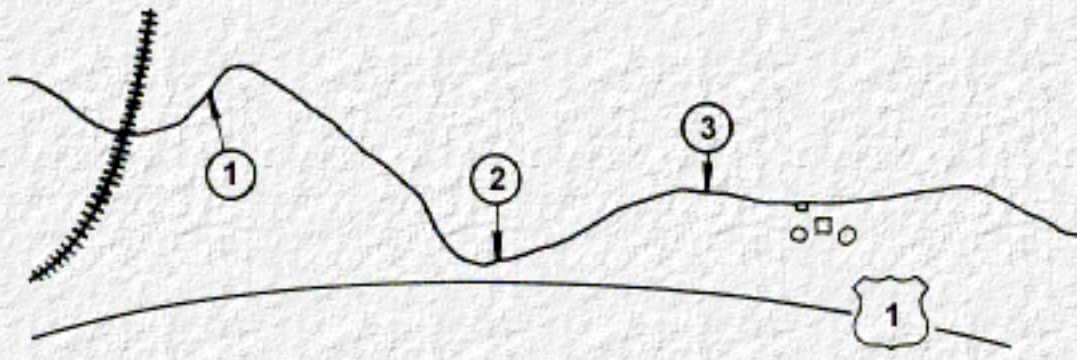

(a) Site Location

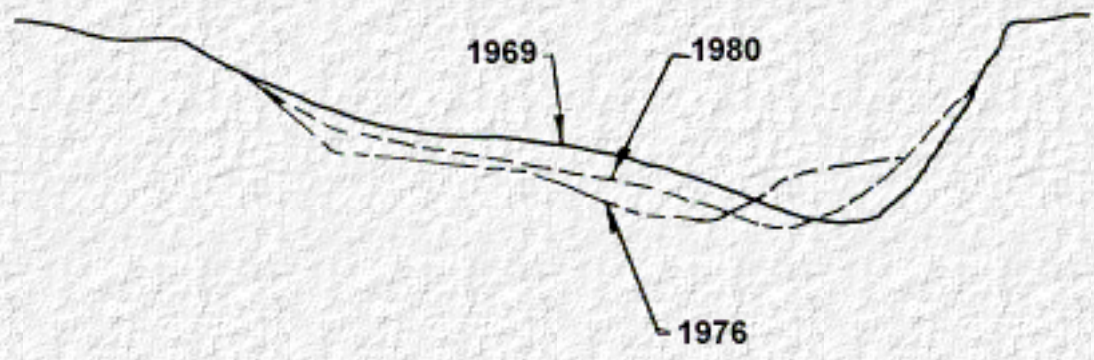

(b) Bottom profiles at location 1.

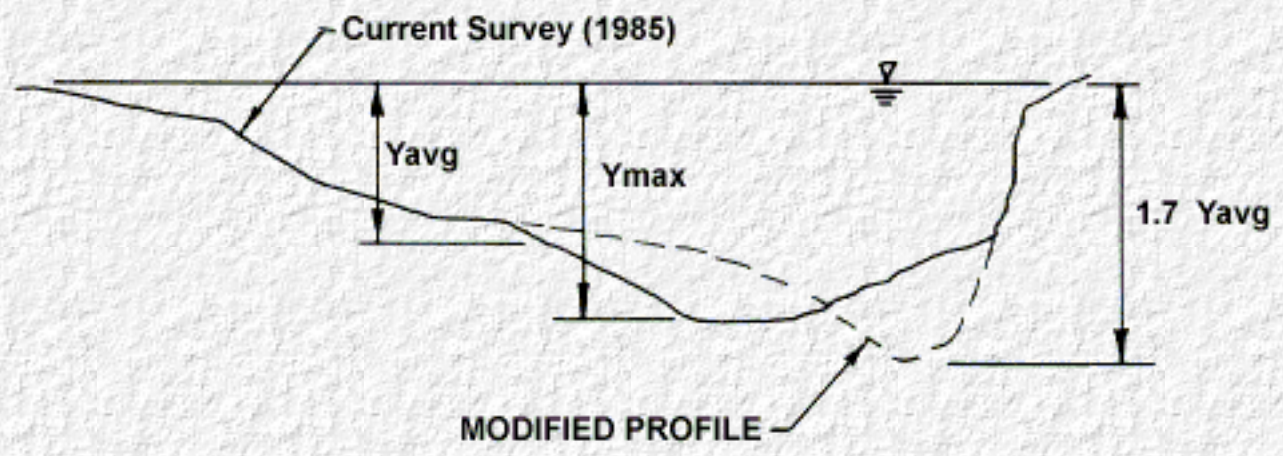

(c) Bottom profile and modified profile at location 2.

Figure 14. Channel Geometry Development

3.5 Flow Resistance

The hydraulic analysis performed as a part of the riprap design process requires the estimation of Manning's roughness coefficient. Roughness evaluation can be determined using comparative photographs (see reference 17 and 34), or resistance equations based on physical characteristics of natural channels (see reference 17 and 11). Physical characteristics upon which the resistance equations are based include the channel base material, surface irregularities, variations in section geometry, obstructions, vegetation, channel meandering, flow depth, and channel slope. In addition, seasonal changes in these factors must also be considered. Procedures for the evaluation of reach average roughness coefficients are detailed in reference 17, "Guide for Selecting Manning's Roughness Coefficients for Natural Channels." Additional guidance is provided here for the appropriate selection of a base 'n' to be used in the procedure.

The base 'n' is primarily a function of the material through which the channel is cut. References 17 and 11 present several methods for the establishment of a base 'n' including tabular listings, photographic comparisons, and computational methods. These methods are applicable for channels cut through natural materials. For riprap lined channels, [Equation 2](#), [Equation 3](#), and [Equation 4](#) are recommended. [Equation 2](#) and [Equation 3](#) provide estimates of Manning's roughness coefficient based on laboratory and natural channel data (5).

The following form can be used to calculate Manning's values:

$$n = \frac{0.1134 d_a^{0.167}}{0.749 + 1.85 \log\left(\frac{d_a}{D_{50}}\right)} \quad \text{for } 1.5 < d_a/D_{50} < 185 \quad (2)$$

$$n = 0.023 d^{0.167} \quad \text{for } 185 < d_a/D_{50} < 30,000 \quad (3)$$

where:

d_a = the average channel flow depth (m),

D_{50} = the median bed material size (m).

The accuracy of [Equation 2](#) and [Equation 3](#) are dependent on good estimates of median bed material size. On high gradient streams it is extremely difficult to obtain a good estimate of the median bed material size. For high gradient streams with slopes greater than 0.002 and bed material larger than .06 m (gravel, cobble, or boulder size material), it is recommended that the relationship given in [Equation 4](#) be used to evaluate the base 'n' (13).

$$n = 0.3225 S_f^{0.38} R^{-0.16} \quad (4)$$

where:

S_f = friction slope,

R = hydraulic radius, (m).

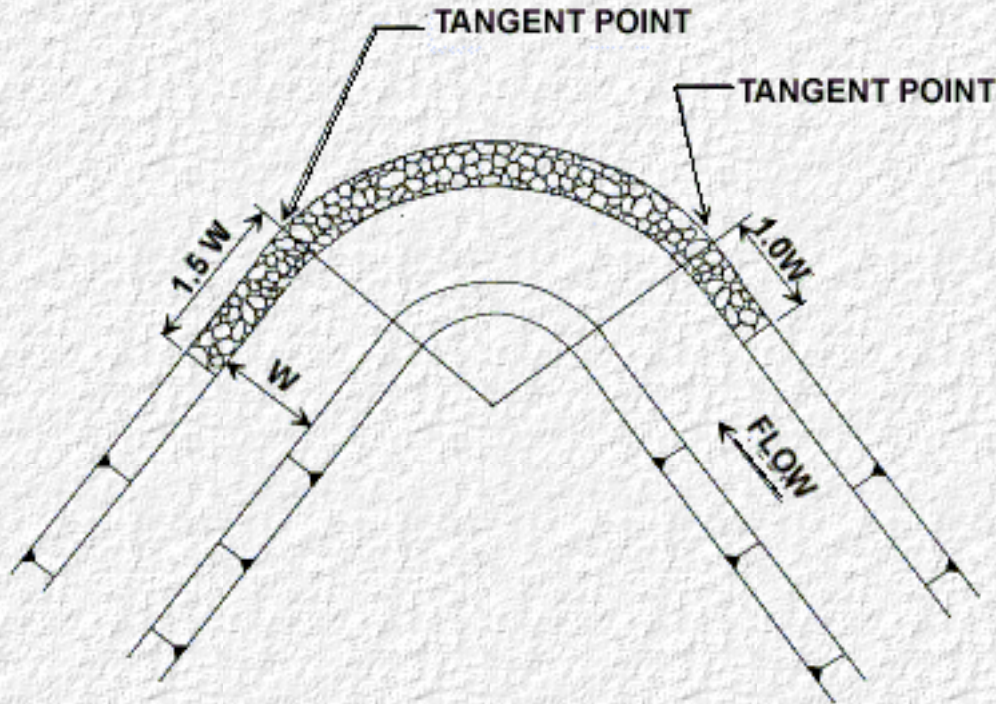

Figure 15. Longitudinal Extent of Revetment Protection

3.6 Extent of Protection

Extent of protection refers to the longitudinal and vertical extent of protection required to adequately protect the channel bank.

3.6.1 Longitudinal Extent

The longitudinal extent of protection required for a particular bank protection scheme is highly dependent on local site conditions. In general, the revetment should be continuous for a distance greater than the length that is impacted by channel-flow forces severe enough to cause dislodging and/or transport of bank material. Although this is a vague criteria, it demands serious consideration. Review of existing bank protection sites has revealed that a common misconception in streambank protection is to provide protection too far upstream and not far enough downstream.

One criterion for establishing the longitudinal limits of protection required is illustrated in [Figure 15](#). As illustrated, the minimum distances recommended for bank protection are an upstream distance of 1.0 channel width and a downstream distance of 1.5 channel widths from corresponding reference lines (see [Figure 15](#)). All reference lines pass through tangents to the bend at the bend entrance or exit.

This criterion is based on analysis of flow conditions in symmetric channel bends under ideal laboratory conditions. Real-world conditions are rarely as simplistic. In actuality, many site-specific factors have a bearing on the actual length of bank that should be protected. A designer will find the above criterion difficult to apply on mildly curving bends or on channels having irregular, non-symmetric bends. Also, other channel controls (such as bridge abutments) might already be producing a stabilizing effect on the bend so that only a part of the channel bend needs to be stabilized. In addition, the magnitude or nature of the flow event might only cause erosion problems in a very localized portion of the bend, requiring that only a short channel length be stabilized. Therefore, the above criteria should only be used as a starting point. Additional analysis of site-specific factors is necessary to define the actual extent of protection required.

Field reconnaissance is a useful tool for the evaluation of the longitudinal extent of protection required, particularly if the channel is actively eroding. In straight channel reaches, scars on the channel bank may be useful to help identify the limits required for channel bank protection. In this case, it is recommended that upstream and downstream limits of the protection scheme be extended a minimum of one channel width beyond the observed erosion limits.

In curved channel reaches, the scars on the channel bank can be used to establish the upstream limit of erosion. Here again, a minimum of one channel width should be added to the observed upstream limit to define the limit of protection. The downstream limit of protection required in curved channel reaches is not as easy to define. Since the natural progression of bank erosion is in the downstream direction, the present visual limit of erosion might not define the ultimate downstream limit. Additional analysis based on consideration of flow patterns in the channel bend may be required. Flow dynamics in channel bends are covered in detail in reference 18. Included are discussions of flow and erosion processes in channel bends, and how the flow dynamics change with flow magnitude, flow stage, and whether or not the flow event is occurring on the rising or falling limb of the runoff hydrograph.

As indicated previously, the extent of bank protection can also be influenced by existing channel controls. The most common situation encountered is the existence of a bridge somewhere along the bend. If the bridge has an abutment immediately adjacent to the channel bank, it will act as a control point with respect to channel stability. The location of the bridge abutment (or other channel control such as a rock outcrop) will usually define the downstream limit of active channel movement. If the control point does not cause significant flow contraction, or there is no significant flow expansion downstream of the control, the bank revetment should be terminated approximately one channel width downstream of the control. However, if significant flow contraction and/or expansion is occurring in the vicinity of the control, the protection should be continued downstream for a distance equal to four times the constricted channel width at the control.

3.6.2 Vertical Extent

The vertical extent of protection required of a revetment includes design height and foundation or toe depth.

3.6.2.1 Design Height

The design height of a riprap installation should be equal to the design highwater elevation plus some allowance for freeboard. Freeboard is provided to ensure that the desired degree of protection will not be reduced by unaccounted factors. Some such factors include:

- Wave action (from wind or boat traffic).
- Superelevation in channel bends.
- Hydraulic jumps.
- Flow irregularities due to piers, transitions, and flow junctions.

In addition, erratic phenomena such as unforeseen embankment settlement, the accumulation of silt, trash, and debris in the channel, aquatic or other growth in the channels, and ice flows should be considered when setting freeboard heights. Also, wave run-up on the bank must be considered.

The amount of freeboard cannot be fixed by a single, widely applicable formula. The impact from each of the items listed above must be considered individually, and their joint impact estimated to determine an adequate freeboard estimate. Guidance is available in the literature for computing elevations for some of the conditions listed above. Procedures for estimating the height of waves due to hydraulic jumps, and flow irregularities (due to piers, transitions, and flow junctions) are available in references 9 and 12, as well as most standard open channel flow texts. In addition, [Equation 1](#) can be used for estimating superelevation heights.

The prediction of **wave heights** from wind and boat generated waves is not as straightforward as other wave sources. [Figure 16](#) provides a definition sketch for the wave height discussion to follow. The height of boat generated waves must be estimated from observations. The height of wind generated waves is a function of fetch length, wind speed, wind duration, and the depth of the water body. Detailed procedures for estimating design wind speeds and durations, and for determining the controlling factors in the development of wind generated waves are provided in reference 20. In design situations where wind generated waves are considered to be of significant importance, it is recommended that the procedures of reference 20 be followed. The significance of wind generated waves can be estimated using [Chart 6](#) of [Appendix C](#).

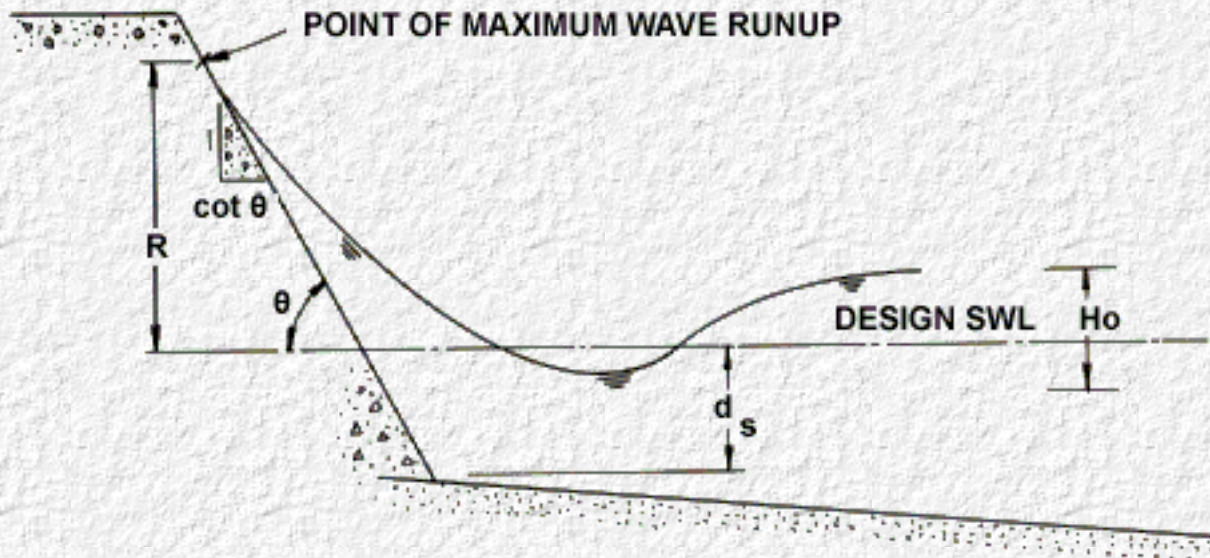

Figure 16. Wave Height Definition Sketch

[Chart 6](#) in [Appendix C](#) is provided as a tool for estimating wave heights due to wind generated waves. [Chart 6](#) is entered with estimates of the design wind speed, duration, and fetch length to determine an estimate of the generated wave height. The chart is limited to wind speeds of 72.4 km/h and fetch lengths of 16.1 km. If estimated wave heights from [Chart 6](#) are greater than .61 m, the procedures of reference 20 should be used to refine the design wave height. Note: that [Chart 6](#) is only intended to provide an initial estimate of wind generated wave heights.

Wind data for use in determining design wind speeds and durations is usually available from primary weather stations, airports, and major dams and reservoirs. The data is often incomplete, and is reported in varying formats. To get an initial estimate of wave heights from [Chart 6](#), a reasonable estimate of wind speed should be used. If the resulting estimated wave height is greater than .61 m, procedures in reference 20 should be used to refine wind speed estimates.

In addition to wave height estimates, it is necessary to estimate the magnitude of **wave runup**, which results when waves impact the bank. Detailed procedures for estimating wave runup are presented in references 14 and 20 . Wave runup is a function of the design wave height, the wave period, bank angle, and the bank surface characteristics (as represented by different revetment materials). Chapter 7 of reference 20 provides detailed procedures for estimating wave runup based on the factors described above. The detailed procedures of reference 20 are not justified for most highway applications. For wave heights less than 0.61 m, wave runup can be computed using [Chart 8](#) and [Table 9](#). Correction factors are provided in [Table 9](#) for reducing the runup magnitude for other revetment materials. The

correction factor from [Table 9](#) is multiplied times the wave height to get the resulting wave runup (R).

As indicated, there are many factors which must be considered in the selection of an appropriate freeboard height. As a minimum, it is recommended that a freeboard elevation of .30 to .61 m be used in unconstricted reaches, and .61 to .91 m in constricted reaches (These criteria are consistent with those presented by the Federal Emergency Management Agency). When computational procedures indicate that additional freeboard may be required, the greater height should be used. In addition, it is recommended that the designer observe wave and flow conditions during various seasons of the year (if possible), consult existing records, and interrogate persons who have knowledge of past conditions when establishing the necessary vertical extent of protection required for a particular revetment installation.

3.6.2.2 Toe Depth

The undermining of revetment toe protection has been identified as one of the primary mechanisms of riprap revetment failure. In the design of bank protection, estimates of the depth of scour are needed so that the protective layer is placed sufficiently low in the streambed to prevent undermining. The ultimate depth of scour must consider channel degradation as well as natural scour and fill processes.

Channel degradation is a morphologic change in a river system which is characterized by the general reduction in channel base level. A complete coverage of geomorphic analysis procedures is beyond the scope of this manual. Detailed coverage of this subject is included in references 4 and 5.

The relationships presented in [Equation 5](#) can be used to estimate the probable maximum depth of scour due to natural scour and fill phenomenon in straight channels, and in channels having mild bends. [Equation 5](#) is based on data presented by Blodgett (15). In application, the depth of scour, d_s , determined from [Equation 5](#) should be measured from the lowest elevation in the cross section. It is assumed that the low point in the cross section may eventually move adjacent to the riprap (even if this is not the case in the current survey).

The following form can be used to calculate D50:

$$\begin{aligned} d_s &= 3.66 \text{ m for } D_{50} < 0.0015 \text{ m,} \\ d_s &= 1.74 D_{50}^{-0.11} \text{ for } D_{50} > 0.0015 \text{ m,} \end{aligned} \tag{5}$$

where:

d_s = estimated probable maximum depth of scour (m)

D_{50} = median diameter of bed material (m)

The depth of scour predicted by [Equation 5](#) must be added to the magnitude of predicted degradation and local scour (if any) to arrive at the total required toe depth.

[Go to Chapter 4](#)



Chapter 4 : HEC 11

Design Guidelines for Rock Riprap

[Go to Chapter 5](#)

As defined in [Chapter 2](#), rock riprap consists of a well graded mixture of rock, broken concrete, or other material, dumped or hand placed to prevent erosion, scour, or sloughing of a structure or embankment. In the context of this chapter, the term rock riprap is used to refer to both rock and rubble riprap.

Rock riprap is the most widely used and desirable type of revetment in the United States. The term "riprap" connotes rock riprap. The effectiveness of rock riprap has been well established where it is properly installed, of adequate size and suitable gradation. Riprap materials include quarry-run rock, rubble, or other locally available materials. Performance characteristics of rock and rubble riprap are reviewed in [Section 2.1.1](#).

This chapter contains design guidelines for the design of rock riprap. Guidelines are provided for:

- Rock size,
- Rock gradation,
- Riprap layer thickness,
- Filter design,
- Material quality,
- Edge treatment, and
- Construction considerations.

In addition, typical construction details are illustrated. In most cases, the guidelines presented apply equally to rock and rubble riprap. Sample specifications for rock riprap are included in [Appendix A](#).

4.1 Rock Size

The stability of a particular riprap particle is a function of its size, expressed either in terms of its weight or equivalent diameter. In the following sections, relationships are presented for evaluating the riprap size required to resist particle and wave erosion forces.

4.1.1 Particle Erosion

In [Chapter 1](#), riprap failure modes were identified as particle erosion, translational slide, modified slump, and slump. Translational slide, modified slump, and slump are slope or soils processes. Particle erosion is a hydraulic phenomenon which results

when the tractive force exerted by the flowing water exceeds the riprap materials ability to resist motion. It is this process that the riprap design relationships presented in this section were developed for.

Two methods or approaches have been used historically to evaluate a materials resistance to particle erosion. These methods are:

1. Permissible velocity approach:

Under the permissible velocity approach the channel is assumed stable if the computed mean velocity is lower than the maximum permissible velocity.

2. Permissible tractive force (shear stress) approach.

The tractive force (boundary shear stress) approach focuses on stresses developed at the interface between flowing water and materials forming the channel boundary.

By Chow's definition, permissible tractive force is the maximum unit tractive force that will not cause serious erosion of channel bed material from a level channel bed (9) . Permissible tractive force methods are generally considered to be more academically correct; however, critical velocity approaches are more readily embraced by the engineering community.

4.1.1.1 Design Relationship

A riprap design relationship that is based on tractive force theory yet has velocity as its primary design parameter is presented in [Equation 6](#). The design relationship in [Equation 6](#) is based on the assumption of uniform, gradually varying flow. The derivation of [Equation 6](#) along with a comparison with other methods is presented in [Appendix D. Chart 1](#) in [Appendix C](#) presents a graphical solution to [Equation 6](#). [Equation 7](#) can be solved using [Chart 3](#) and [Chart 4](#) of [Appendix C](#).

The following form can be used to calculate D_{50} :

$$D_{50} = 0.00594 V_a^3 / (d_{avg}^{0.5} K_1^{1.5}) \quad (6)$$

where:

D_{50} = the median riprap particle size (m);

C = correction factor (described below);

V_a = the average velocity in the main channel (m/s);

d_{avg} = the average flow depth in the main flow channel (m); and

K_1 is defined as:

$$K_1 = [1 - (\sin^2 \theta / \sin^2 \phi)]^{0.5} \quad (7)$$

where:

θ = the bank angle with the horizontal; and

ϕ = the riprap material's angle of repose.

The average flow depth and velocity used in [Equation 6](#) are main channel values. The main channel is defined as the area between the channel banks (see [Figure 17](#)).

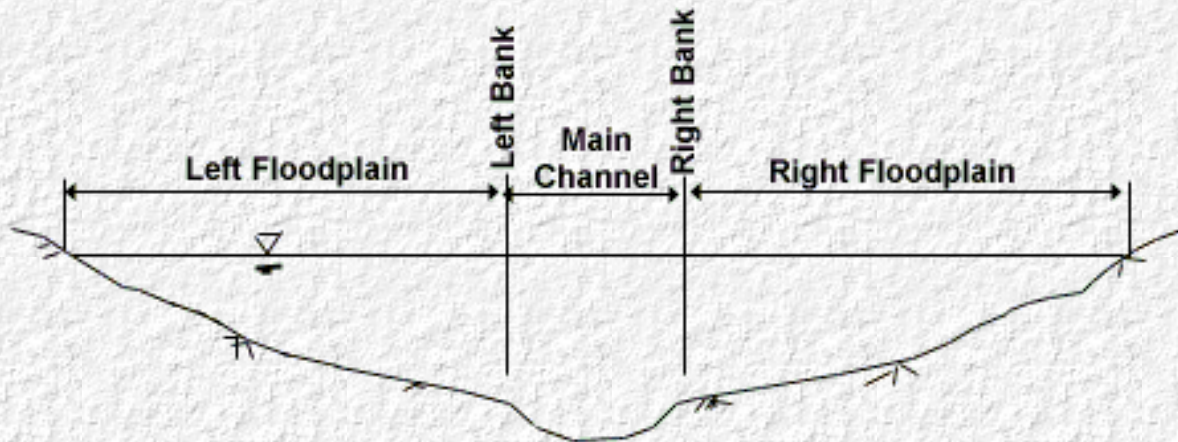

Figure 17. Definition Sketch; Channel Flow Distribution

[Equation 6](#) is based on a rock riprap specific gravity of 2.65, and a stability factor of 1.2. [Equation 8](#) and [Equation 9](#) present correction factors for other specific gravities and stability factors.

The following form can be used to calculate D_{50} :

$$C_{sg} = 2.12 / (S_s - 1)^{1.5} \quad (8)$$

where:

S_s = the specific gravity of the rock riprap.

$$C_{sf} = (SF / 1.2)^{1.5} \quad (9)$$

where:

SF = the stability factor to be applied.

The correction factors computed using [Equation 8](#) and [Equation 9](#) are multiplied together to form a single correction factor C. This correction factor, C, is then multiplied by the riprap size computed from [Equation 6](#)

to arrive at a stable riprap size. [Chart 2](#) in [Appendix C](#) provides a solution to [Equation 8](#) and [Equation 9](#) using correction factor C.

The stability factor, SF, used in [Equation 6](#) and [Equation 9](#) requires additional explanation. The stability factor is defined as the ratio of the riprap material's critical shear stress and the average tractive force exerted by the flow field. As long as the stability factor is greater than 1, the critical shear stress of the material is greater than the flow induced tractive stress, the riprap is considered to be stable. As mentioned above, a stability factor of 1.2 was used in the development of [Equation 6](#).

The stability factor is used to reflect the level of uncertainty in the hydraulic conditions at a particular site. [Equation 6](#) is based on the assumption of uniform or gradually varying flow. In many instances, this assumption is violated or other uncertainties come to bear. For example, debris and/or ice impacts, or the cumulative effect of high shear stresses and forces from wind and/or boat generated waves. The stability factor is used to increase the design rock size when these conditions must be considered. [Table 1](#) presents guidelines for the selection of an appropriate value for the stability factor.

Table 1. Guidelines for the Selection of Stability Factors

Condition	Stability Factor Range
Uniform flow; Straight or mildly curving reach (curve radius/channel width > 30); Impact from wave action and floating debris is minimal; Little or no uncertainty in design parameters.	1.0-1.2
Gradually varying flow; Moderate bend curvature (30 > curve radius/channel width > 10); Impact from waves or floating debris moderate.	1.3-1.6
Approaching rapidly varying flow; Sharp bend curvature(10 > curve radius/channel width); Significant impact potential from floating debris and/or ice; Significant wind and/or boat generated waves (.30 - .61 m)); High flow turbulence; Turbulently mixing flow at bridge abutments; Significant uncertainty in design parameters.	1.6-2.0

4.1.1.2 Application

Application of the relationship in [Equation 6](#) is limited to uniform or gradually varying flow conditions. That is in straight or mildly curving channel reaches of relatively uniform cross section. However, design needs dictate that the relationship also be applicable in nonuniform, rapidly varying flow conditions often exhibited in natural channels with sharp bends and steep slopes, and in the vicinity of bridge piers and abutments.

Research efforts to define stable riprap size relationships for nonuniform, rapidly varying flow conditions have been limited. Recently work by Wang and Shen (35) and Maynord (36) has shed some light on the variability of the Shields parameter for large particle sizes in high Reynold's Number flows. However, no definitive relationship has been presented.

To fill the need for a design relationship that can be applied at sharp bends and on steep slopes in natural channels, and at bridge abutments, it is recommended that [Equation 6](#) be used with appropriate adjustments in velocity and/or stability factor as outlined in the following sections.

Channel Bends: At channel bends modifications to the stability factor are recommended based on the ratio of curve radius to channel width (R/W) as indicated in the following:

R/W	Stability Factor
> 30	1.2
30 > R/W > 10	1.3 - 1.6
< 10	1.7

Steep Slopes: Flow conditions in steep sloped channels are rarely uniform, and are characterized by high flow velocities and significant flow turbulence. In applying [Equation 6](#) to steep slope channels, care must be exercised in the determination of an appropriate velocity. When determining the flow velocity in steep sloped channels, it is recommended that [Equation 4](#) be used to determine the channel roughness coefficient. It is also important to thoughtfully consider the guidelines for selection of stability factors as presented in [Table 1](#).

Bridge piers: The FHWA is currently evaluating various equations for selection of riprap at bridge piers. Present research indicates that velocities in the vicinity of the base of a pier can be related to the velocity in the channel upstream of the pier. For this reason, the interim procedure presented below is recommended for designing riprap at piers:

- Determine the D_{50} size of the riprap using the rearranged Ishbash equation to solve for stone diameter, for fresh water:

The following form can be used to calculate D_{50} :

$$D_{50} = \frac{1}{2} \frac{1.384 V^2}{(S-1)2g} \quad (10)$$

where:

D_{50} = average stone diameter (m),

V = velocity against stone (m/s) ,
 s = specific gravity of riprap material ,
 g = acceleration due to gravity m/s^2

To calculate V , first determine the velocity of flow just upstream of the pier. This may be approximated by the velocity in the contracted section. Then multiply this value by a factor of 1.5 to 2.0 to approximate the velocity of flow at the base of the pier. Note: preliminary research by FHWA indicates that a factor of about 1.5 may be a reasonable design value.

- Provide a mat width that extends horizontally at least two times the pier width measured from the pier face.
- Place the mat below the streambed a depth equivalent to the expected scour. The thickness should be three stone diameters or more.

Abutments: When applying [Equation 6](#) for riprap design at abutments a velocity in the vicinity of the abutment should be used instead of the average section velocity. The velocity in the vicinity of bridge abutments is a function of both the abutment type (vertical, wingwalled, or spillthrough), and the amount of constriction caused by the bridge. However, information documenting velocities in the vicinity of bridge abutments is currently unavailable. Until such information becomes available, it is recommended that [Equation 6](#) be used with a stability factor of 1.6 to 2.0 for turbulently mixing flow at bridge abutments. Note: the average velocity and depth used in [Equation 6](#) for riprap design at bridge constrictions for abutment protection is the average velocity and depth in the constricted cross section at the bridge. Flow profiles at bridge sections are nonuniform as indicated in [Figure 17](#). The recommended procedure for computing the average depth and velocity at bridge constrictions is:

1. Model the reach in the vicinity of the crossing using WSPRO (38), HEC-2 (39), or some other model with bridge loss routines.
2. Compute the average depth and velocity in the constriction as the average of the depth and velocity for modeled cross sections at the entrance to, and exit from the bridge constriction (in the vicinity of cross sections 2 and 3 as illustrated in [Figure 18](#)).

In instances where resources are not available to model flow conditions at the constriction as indicated above, normal depth and its associated flow velocity for the constricted section can be used.

As outlined above, the average section flow depth and velocity used in [Equation 6](#) are main channel values. The main channel is typically

defined as the area between the channel banks (see [Figure 17](#)). However, when the bridge abutments are located on the floodplain a sufficient distance from the natural channel banks so as not to be influenced by main channel flows, the average depth and velocity on the floodplain within the constricted section should be used in the riprap design relationship. Most standard computerized bridge backwater routines provide the necessary depths and velocities as a part of their standard output. If hand normal depth computations are being used, the computations must consider conveyance weighted effects of both floodplain, and main channel flows. See reference 5 or standard open channel hydraulics texts for appropriate procedures.

When there is no overbank flow and the bridge spillthrough abutment on the channel bank matches the slope of the main channel banks upstream and downstream, use the design procedure without modification.

4.1.2 Wave Erosion

Waves generated by wind or boat traffic have also been observed to cause bank erosion on inland waterways. The most widely used measure of riprap's resistance to wave is that developed by Hudson (24). The so-called Hudson relationship is given by the following equation:

The following form can be used to calculate Wave Erosion:

$$W_{50} = (\gamma_s H^3) / (2.20 [S_s - 1]^3 \cot\theta) \quad (11)$$

where:

H = the wave height; and the other parameters are as defined previously.

Assuming

$$S_s = 2.65 \text{ and } \gamma_s = 2647 \text{ kg/m}^3 = 25952 \text{ N/m}^3 \quad (12)$$

[Equation 11](#) can be reduced to:

$$W_{50} = 267.8 H^3 / \cot\theta$$

In terms of an equivalent diameter [Equation 12](#) can be reduced to:

$$D_{50} = 0.57H / \cot^{1/3}\theta \quad (13)$$

Methods for estimating a design wave height are presented in [Section 3.6.2](#).

[Equation 13](#) is presented in nomograph form in [Chart 7](#) of [Appendix C](#). [Equation 12](#) and [Equation 13](#) can be used for preliminary or final design when H is less than 1.52 m, and there is no major overtopping of the embankment.

4.1.3 Ice Damage

Ice can affect riprap linings in a number of ways. Moving surface ice can cause crushing and bending forces as well as large impact loadings. The tangential flow of ice along a riprap lined channel bank can also cause excessive shearing forces. Quantitative criteria for evaluating the impact ice has on channel protection schemes are unavailable. However, historic observations of ice flows in New England rivers indicate that riprap sized to resist design flow events will also resist ice forces.

For design, consideration of ice forces should be evaluated on a case by case bases. In most instances, ice flows are not of sufficient magnitude to warrant detailed analysis. Where ice flows have historically caused problems, a stability factor of 1.2 to 1.5 should be used to increase the design rock size. Note: the selection of an appropriate stability factor to account for ice generated erosive problems should be based on the designer's experience.

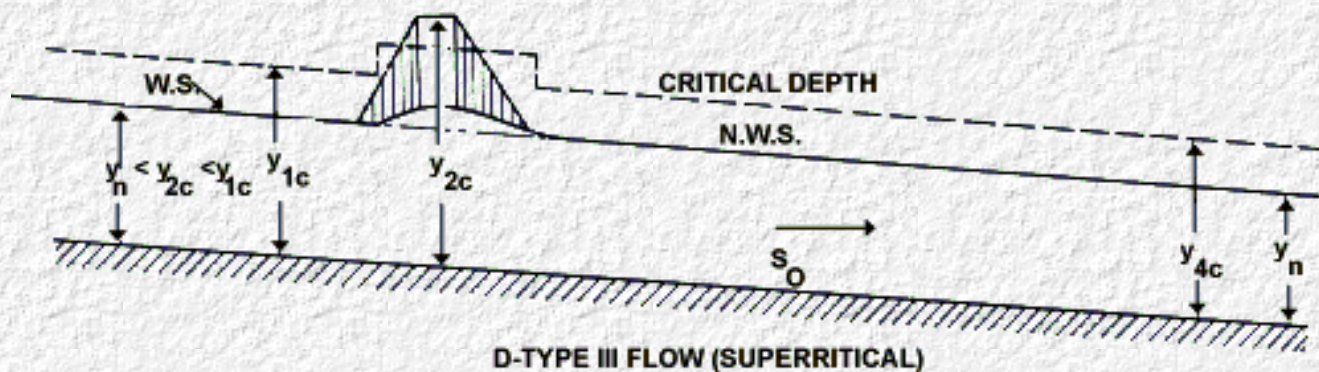
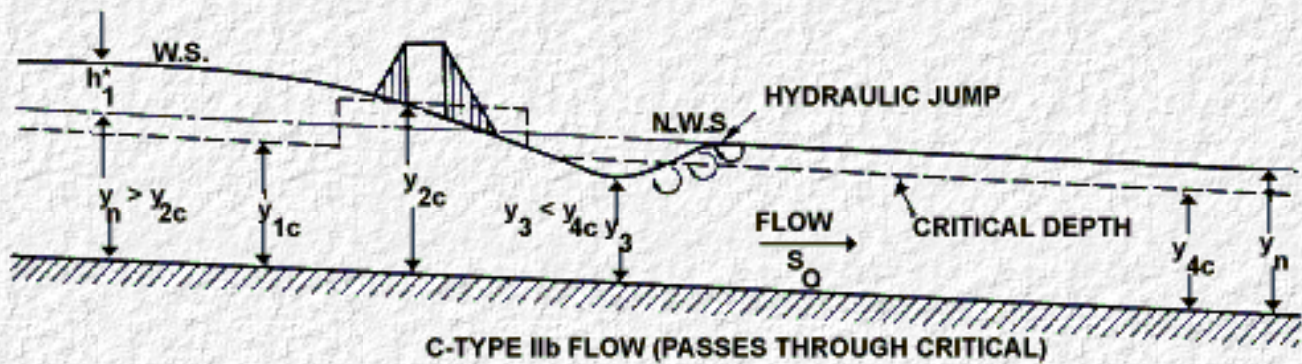
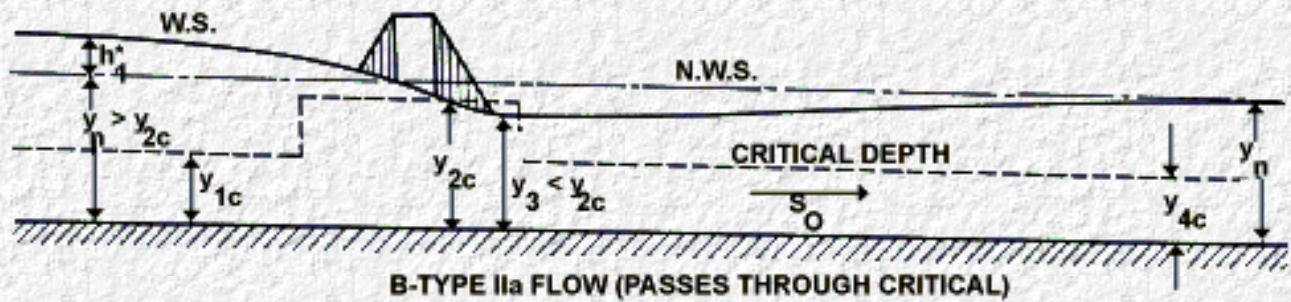
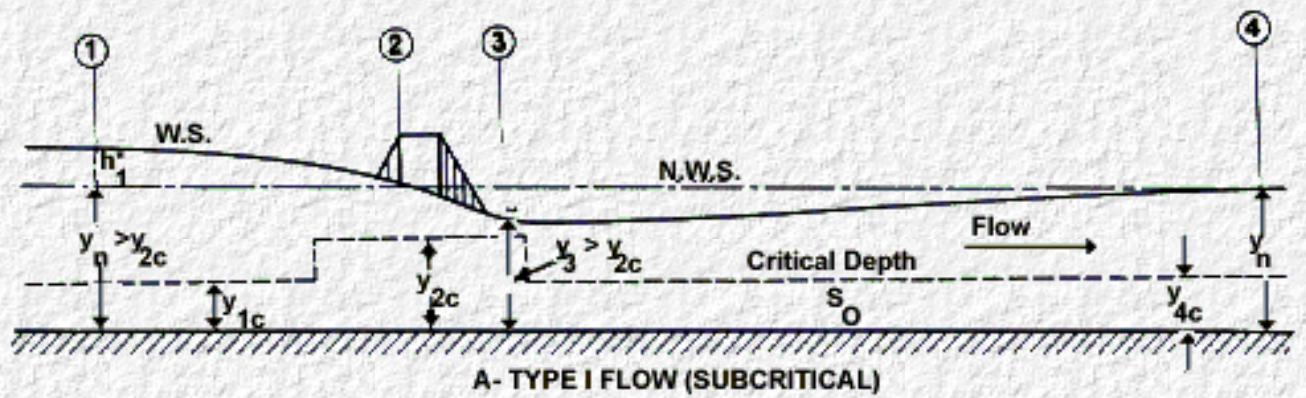

Figure 18. Typical Water Surface Profiles Through Bridge Constrictions for Various Types as Indicated (Modified from Bradley (40))

4.2 Rock Gradation

The gradation of stones in riprap revetment affects the riprap's resistance to erosion. The stone should be reasonably well graded throughout the riprap layer thickness. Specifications should provide for two limiting gradation curves, and the stone gradation (as determined from a field test sample) should lay within these limits. The gradation limits should not be so restrictive that production costs would be excessive. [Table 2](#) presents suggested guidelines for establishing gradation limits. [Table 3](#) presents six (6) suggested gradation classes based on AASHTO specifications. [Form 3 \(Appendix C\)](#) can be used as an aid in selecting appropriate gradation limits.

It is recognized that the use of a four point gradation as specified in [Table 2](#) might in some cases be too harsh a specification for some smaller quarries (4). If this is the case, the 85 percent specification can be dropped as is done in [Table 3](#). In most instances, a uniform gradation between D_{50} and D_{100} will result in an appropriate D_{85} .

Each load of riprap should be reasonably well graded from the smallest to the maximum size specified. Stones smaller than the specified 5 or 10 percent size should not be permitted in an amount exceeding 20 percent by weight of each load.

Table 2. Rock Riprap Gradation Limits

Stone Size Range (m)	Stone weight Range (kilograms)	Percent of Gradation Smaller Than
1.5 D_{50} to 1.7 D_{50}	3.0 W_{50} to 5.0 W_{50}	100
1.2 D_{50} to 1.4 D_{50}	2.0 W_{50} to 2.75 W_{50}	85
1.0 D_{50} to 1.4 D_{50}	1.0 W_{50} to 1.5 W_{50}	50
0.4 D_{50} to 0.6 D_{50}	0.1 W_{50} to 0.2 W_{50}	15

Table 3. Riprap Gradation Classes

Riprap Class	Rock Size ¹ (m)	Rock Size ² (kilograms)	Percent of Riprap Smaller Than
Facing	0.40	91	100
	0.29	34	50
	0.12	2.3	10
Light	0.55	227	100
	0.40	91	50
	0.12	2.3	10
0.23 Metric Ton	0.68	454	100
	0.55	227	50
	0.29	34	10

0.45 Metric Ton	0.87	907	100
	0.68	454	50
	0.55	227	5
0.91 Metric Ton	1.10	1814	100
	0.87	907	50
	0.68	454	5
1.81 Metric Ton	1.37	3629	100
	1.10	1814	50
	0.87	907	5

¹Assuming a specific gravity of 2.65.

²Based on AASHTO specifications for Highway Bridges (1983)

Gradation of the riprap being placed is controlled by visual inspection. To aid the inspector's judgment, two or more samples of riprap of the specified gradation should be prepared by sorting, weighing, and remixing in proper proportions. Each sample should weigh about 4,500 to 9,000 kg. One sample should be placed at the quarry and one sample at the construction site. The sample at the construction site could be part of the finished riprap blanket. These samples should be used as a frequent reference for judging the gradation of the riprap supplied.

An alternate gradation inspection procedure is to collect field samples of this riprap. Field samples should be collected at regular intervals; each sample should be evaluated to determine in place gradation.

4.3 Layer Thickness

All stones should be contained reasonably well within the riprap layer thickness to provide maximum resistance against erosion. Oversize stones, even in isolated spots, may cause riprap failure by precluding mutual support between individual stones, providing large voids that expose filter and bedding materials, and creating excessive local turbulence that removes smaller stones. Small amounts of oversize stone should be removed individually and replaced with proper size stones. The following criteria apply to the riprap layer thickness:

- It should not be less than the spherical diameter of the D_{100} (W_{100}) stone, or less than 1.5 times the spherical diameter of the D_{50} (W_{50}) stone, whichever results in the greater thickness.
- It should not be less than 300 mm for practical placement.
- The thickness determined by either 1 or 2 should be increased by 50 percent when the riprap is placed underwater to provide for uncertainties associated with this type of placement.
- An increase in thickness of 150-300 mm, accompanied by an appropriate increase in stone sizes, should be provided where riprap revetment will be subject to attack by floating debris or ice, or by waves from boat wakes, wind, or bedforms.

4.4 Filter Design

A filter is a transitional layer of gravel, small stone, or fabric placed between the underlying soil and the structure. The filter prevents the migration of the fine soil particles through voids in the structure, distributes the weight of the armor units to provide more uniform settlement, and permits relief of hydrostatic pressures within the soils. For areas above the water line, filters also prevent surface water from causing erosion (gullies) beneath the riprap. A filter should be used whenever the riprap is placed on noncohesive material subject to significant subsurface drainage (such as in areas where water surface levels fluctuate frequently and in areas of high groundwater levels).

The proper design of granular and fabric filters is critical to the stability of riprap installations on channel banks. If openings in the filter are too large, excessive flow piping through the filter can cause erosion and failure of the bank material below the filter. On the other hand, if the openings in the filter are too small, the build-up of hydrostatic pressures behind the filter can cause a slip plane to form along the filter resulting in massive translational slide failure.

4.4.1 Granular Filters

For rock riprap, a filter ratio of 5 or less between layers will usually result in a stable condition. The filter ratio is defined as the ratio of the 15 percent particle size (D_{15}) of the coarser layer to the 85 percent particle size (D_{85}) of the finer layer. An additional requirement for stability is that the ratio of the 15 percent particle size of the coarser material to the 15 percent particle size of the finer material should exceed 5 but be less than 40 (32). These requirements can be stated as:

$$\frac{D_{15}(\text{Coarser Layer})}{D_{85}(\text{Finer Layer})} < 5 < \frac{D_{15}(\text{Coarser Layer})}{D_{15}(\text{Finer Layer})} < 40 \quad (14)$$

The left side of the inequality in [Equation 14](#) is intended to prevent piping through the filter, the center portion provides for adequate permeability for structural bedding layers, and the right portion provides a uniformity criterion.

If a single layer of filter material will not satisfy the filter requirements, one or more additional layers of filter material must be used. The filter requirement applies between the bank material and the filter blanket, between successive layers of filter material if more than one layer is used, and between the filter blanket and the riprap cover. In addition to the filter requirements, the grain size curves for the various layers should be approximately parallel to minimize the infiltration of fine material from the finer layer to the coarser layer. Not more than 5 percent of the filter material should pass the No. 200 sieve. [Form 3 \(Appendix C\)](#) can be used as an aid in designing an appropriate granular filter.

The thickness of the filter blanket should range from 150 mm to 380 mm for a single

layer, or from 100 mm to 200 mm for individual layers of a multiple layer blanket. Where the gradation curves of adjacent layers are approximately parallel, the thickness of the blanket layers should approach the minimum. The thickness of individual layers should be increased above the minimum proportionately as the gradation curve of the material comprising the layer departs from a parallel pattern.

4.4.2 Fabric Filters

Synthetic fabric filters have found considerable use as alternatives to granular filters. Advantages and disadvantages of synthetic fabric filters are discussed below.

Advantages relevant to the use of fabric filters have been identified:

- Installation is generally quick and labor-efficient.
- Fabric filters are more economical than granular filters.
- Fabric filters have consistent and more reliable material quality.
- Fabric filters have good inherent tensile strength.
- Local availability of suitable granular filter material is no longer a design consideration when using fabric filters.

Disadvantages include:

- Filter fabrics can be difficult to lay under-water.
- Installation of some fabrics must be undertaken with care to prevent undue ultraviolet light exposure.
- The life of the fabric in a soil environment is as yet unproven over the lifetime of a normal engineering project.
- Bacterial activity within the soil or upon the filter can control the hydraulic responses of a fabric filter system.
- Experimental evidence indicates that when channel banks are subjected to wave action, non-cohesive bank material has a tendency to migrate downslope beneath fabric filters; this tendency was not observed with granular filters.
- Fabric filters may induce translational or modified slump failures when used under rock riprap installed on steep slopes (6).

Fabric filters have a definite advantage over granular filters in many applications. The primary justification is economic; the U.S. Army Corps of Engineers has found geotextiles to be more cost effective than granular filters in many instances. This is particularly true in areas where a good source of gravel is not convenient (25).

The function of fabric filters is to provide both drainage and filtration. In other words, the fabric must allow water to pass (drainage) while retaining soil properties (filtration). Therefore, both functions must be considered and must perform properly during the design life of the system. Despite their advantages, fabric filters, like granular filters, still require engineering design. Unless proper fabric piping resistance, clogging resistance, and construction strength requirements are

specified, it is doubtful that desired results will be obtained. Also, construction installation and monitoring must be provided to see that the materials have been installed correctly.

Detailed criteria for the design of fabric (geotextile) filters are presented in reference 26 provides a summary of the minimum criteria from reference 26 for noncritical and nonsevere applications (as described in the notes for [Table 8](#)). The quality and hydraulic properties criteria in [Table 8](#) are applicable for most riprap design situations. However, for critical applications, the more detailed criteria of reference 26 are recommended.

Filter fabric placement. To provide good performance, a properly selected cloth should be installed with due regard for the following precautions:

- Heavy riprap may stretch the cloth as it settles, eventually causing bursting of the fabric in tension. A 100-150 mm gravel bedding layer should be placed beneath the riprap layer for riprap gradations having D_{50} greater than 0.91 m.
- The filter cloth should not extend into the channel beyond the riprap layer; rather, it should be wrapped around the toe material as illustrated in [Figure 19](#).
- Adequate overlaps must be provided between individual fabric sheets. For class I revetments this can be as little as 300 mm, and may increase to as much as 0.91 m for large underwater revetments.
- A sufficient number of folds should be included during placement to eliminate tension and stretching under settlement.
- Securing pins with washers are recommended at .61 to 1.52 m intervals along the midpoint of the overlaps.
- Proper stone placement on the filter requires beginning at the toe and proceeding up the slope. Dropping stone from heights greater than 0.61 m can rupture fabrics (greater drop heights are allowable under water).

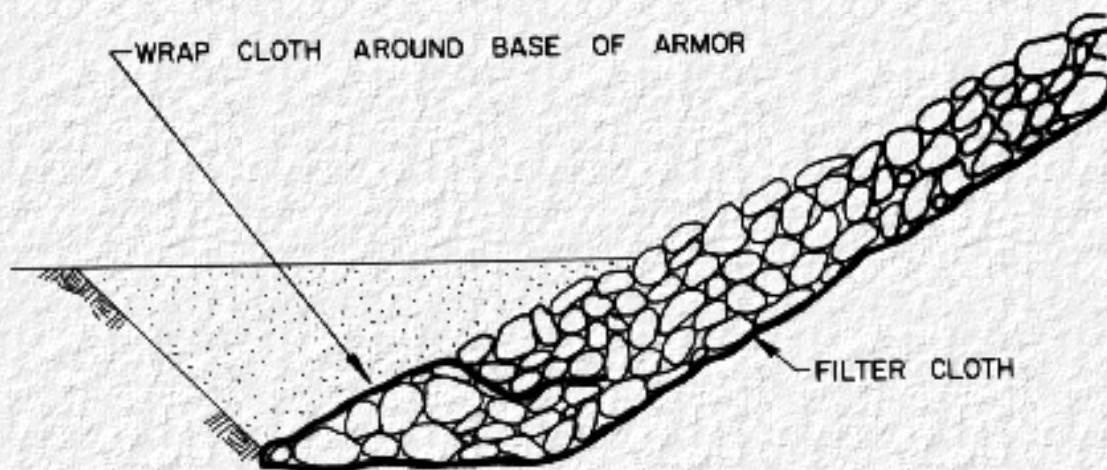

Figure 19. Filter Fabric Placement

4.5 Material Quality

Riprap consists of rock, broken concrete, or other rubble type materials. The most satisfactory type of riprap is rock riprap. Any of these forms of riprap can be used as long as adequate control is maintained on the materials quality and gradation. Gradation requirements were discussed in [Section 4.2](#).

Stone or other material used for riprap is exposed to environmental extremes. Therefore, the riprap should be hard, dense and durable. In addition, it should be resistant to weathering, free from overburden, spoil, shale and organic material. Rock or rubble that is laminated, fractured, porous, or otherwise physically weak is unacceptable as rock slope protection.

Stone shape is another important factor in the selection of an appropriate riprap material. In general, riprap constructed with angular material has the best performance. Round material can be used as riprap provided it is not placed on slopes greater than 1V:3H. Flat slab-like stones should be avoided since they are easily dislodged by the flow. Broken concrete must be adequately broken or fragmented before it is acceptable as a riprap material. An approximate guide to stone shape is that neither the breadth or thickness of a single stone should be less than one-third its length.

4.6 Edge Treatment

The edges of riprap revetments (head, toe, and flanks) require special treatment to prevent undermining.

Flanks: The flanks of the revetment should be designed as illustrated in [Figure 20](#). The upstream flank is illustrated in part (b) and the downstream flank in part (c) of [Figure 20](#). An alternative to the upstream flank section illustrated in part (b) is to fill the compacted fill area with riprap.

Toe: Undermining of the revetment toe is one of the primary mechanisms of riprap failure. The toe of the riprap should be designed as illustrated in [Figure 21](#). The toe material should be placed in a toe trench along the entire length of the riprap blanket as illustrated in [Figure 21](#). Where a toe trench cannot be dug, the riprap blanket should terminate in a thick, narrow stone toe at the level of the streambed (see alternate design in [Figure 21](#)). Care must be taken during the placement of the stone to ensure that the toe material does not mound and form a low dike; a low dike along the toe could result in flow concentration along the revetment face which could stress the revetment to failure. In addition, care must be exercised to ensure that the channel's design capability is not impaired by placement of too much riprap in a toe mound.

The size of the toe trench or the alternate stone toe is controlled by the anticipated depth of scour along the revetment. As scour occurs (and in most cases it will) the stone in the toe will launch into the eroded area as illustrated in [Figure 22](#). Observation of the performance of these types of rock toe designs indicates that the riprap will launch to a final slope of approximately 1V:2H. The volume of rock required for the toe must be equal to or exceed one and one-half

times the volume of rock required to extend the riprap blanket (at its design thickness and on a slope of 1V:2H) to the anticipated depth of scour. Establishing a design scour depth is covered in [Section 3.6.2.2](#).

4.7 Construction

Additional considerations related to the construction of riprap revetments include bank slope or angle, bank preparation, and riprap placement.

Bank slope: A primary consideration in the design of stable riprap bank protection schemes is the slope of the channel bank. For riprap installations, the maximum recommended face slope is 1V:2H.

Bank Preparation: The bank should be prepared by first clearing all trees and debris from the bank, and grading the bank surface to the desired slope. In general, the graded surface should not deviate from the specified slope line by more than 150 mm. However, local depressions larger than this can be accommodated since initial placement of filter material and/or rock for the revetment will fill these depressions. In addition, any large boulders or debris found buried near the edges of the revetment should be removed.

Riprap Placement: The common methods of riprap placement are hand placing; machine placing, such as from a skip, dragline, or some form of bucket; and dumping from trucks and spreading by bulldozer. Hand placement produces the best riprap revetment, but it is the most expensive method except when labor is unusually cheap. Steeper side slopes can be used with hand placed riprap than with other placing methods. Where steep slopes are unavoidable (when channel widths are constricted by existing bridge openings or other structures, and when rights-of-way are costly), hand placement should be considered. In the machine placement method, sufficiently small increments of stone should be released as close to their final positions as practical. Rehandling or dragging operations to smooth the revetment surface tend to result in segregation and breakage of stone, and can result in a rough revetment surface. Stone should not be dropped from an excessive height as this may result in the same undesirable conditions. Riprap placement by dumping and spreading is the least desirable method as a large amount of segregation and breakage can occur. In some cases, it may be economical to increase the layer thickness and stone size somewhat to offset the shortcomings of this placement method.

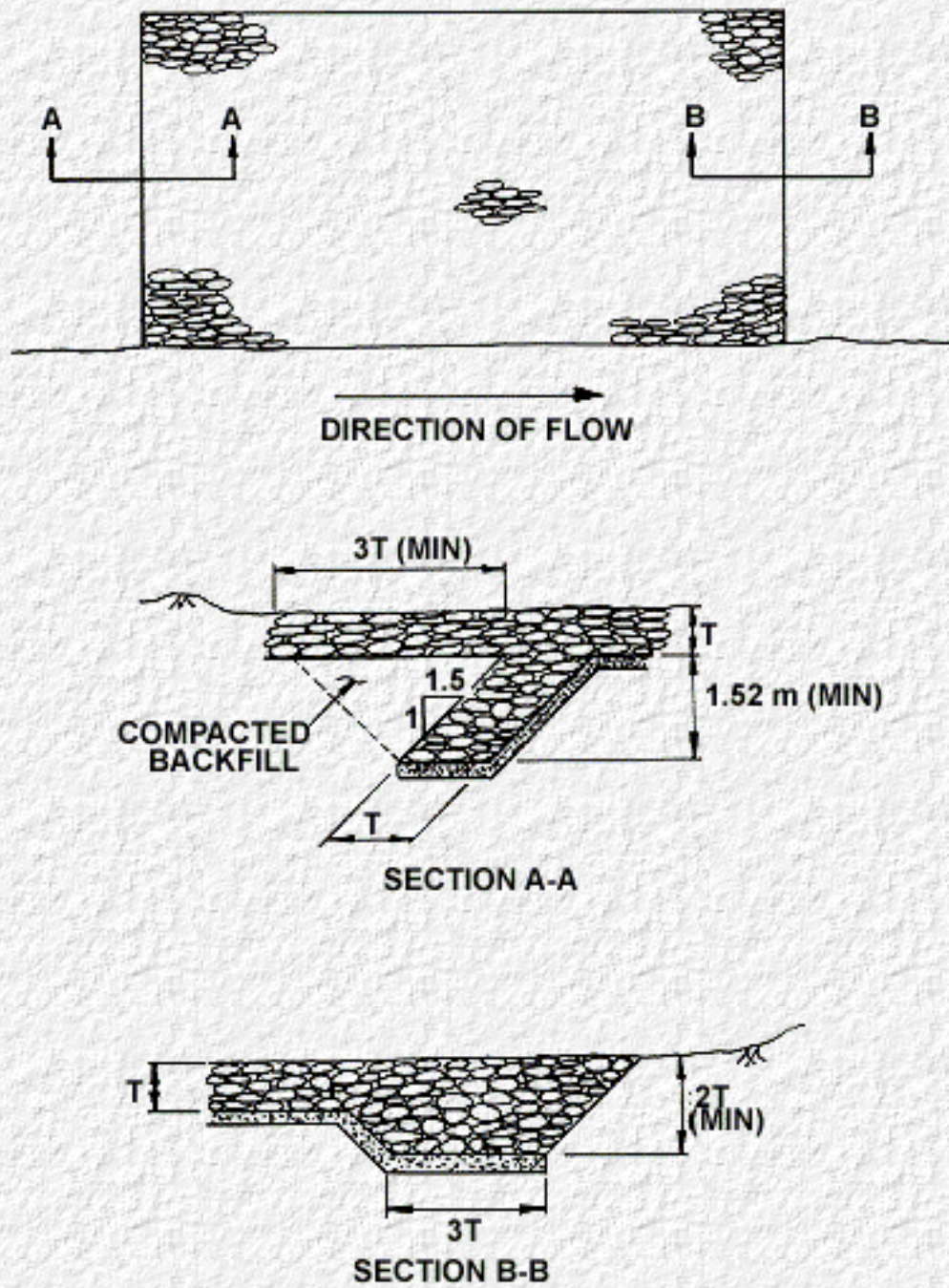

Figure 20. Typical Riprap Installation: Plan and Flank Detail

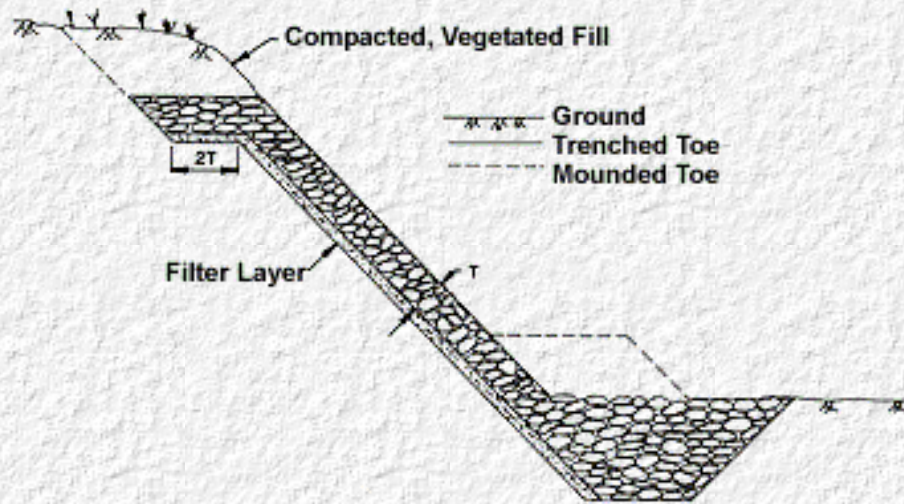

Figure 21. Typical Riprap Installation: End View (bank protection only)

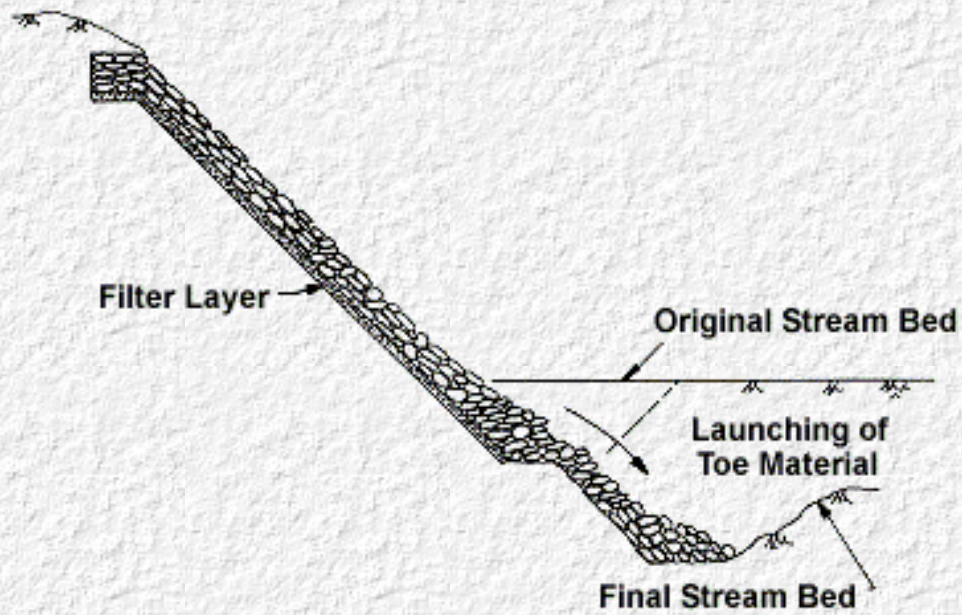

Figure 22. Launching of Riprap Toe Material



Chapter 5 : HEC 11

Rock Riprap Design Procedure

[Go to Chapter 6](#)

Rock riprap design procedure outlined in the following sections is comprised of three primary sections: preliminary data analysis, rock sizing, and revetment detail design. A section is devoted to each component. A flow chart of the design procedure is presented in [Figure 23](#). The individual steps in the procedure are numbered consecutively throughout each of the sections. Notes and miscellaneous comments are inserted between steps where additional explanation is required. Reference is made at each step to the section or chart that contains the information necessary for that step. [Form 1](#) and [Form 2](#) in [Appendix C](#) provide a useful format for recording data at each step of the analysis. The final section of this chapter presents design examples which demonstrate the design procedure presented.

5.1 Preliminary Data Analysis

- **Step 1.** Compile all necessary field data including (channel cross section surveys, soils data, aerial photographs, history of problems at site, etc.).
 - **Step 2.** Determine design discharge. [Section 3.1](#).
 - **Step 3.** Develop design cross section(s). [Section 3.3](#).
-

5.2 Rock Sizing (Form 1)

Note: The rock sizing procedures described in the following are designed to prevent riprap failure from particle erosion.

- **Step 4.** Compute design water surface.
 - When evaluating the design water surface, Manning's "n" should be estimated using procedures from [Section 3.5](#). If a riprap lining is being designed for the entire channel perimeter, an estimate of the rock size may be required to determine the roughness coefficient "n". ([Form 4](#)).

- B. If the design section is a regular trapezoidal shape, and flow can be assumed to be uniform, use design charts such as those in reference (37).
- C. If the design section is irregular or flow is not uniform, backwater procedures must be used to determine the design water surface. Computer methods such as WSPRO(38) and HEC-2 (39) are recommended.
- D. Any backwater analysis conducted must be based on conveyance weighting of flows in the main channel, right bank and left bank.

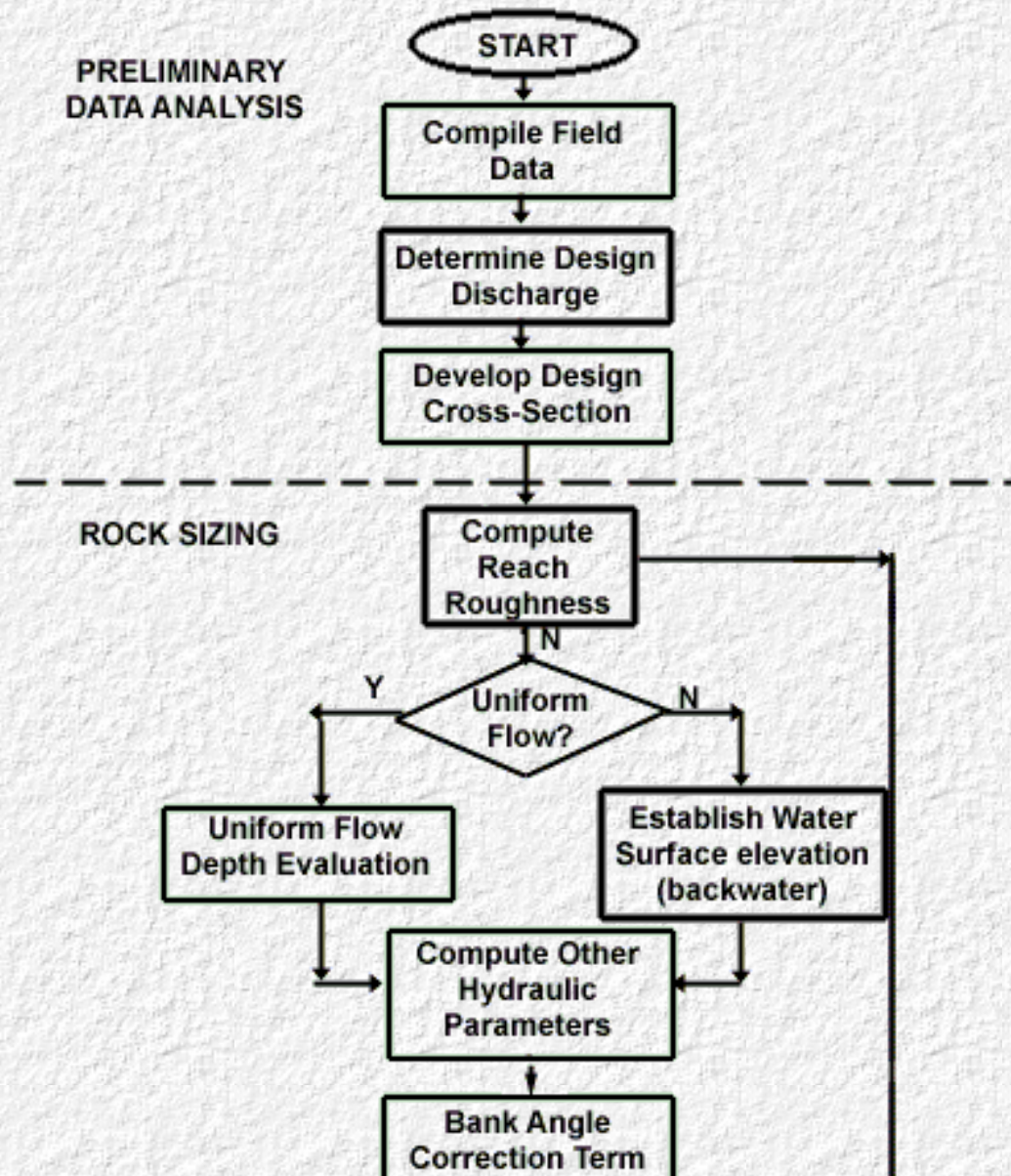

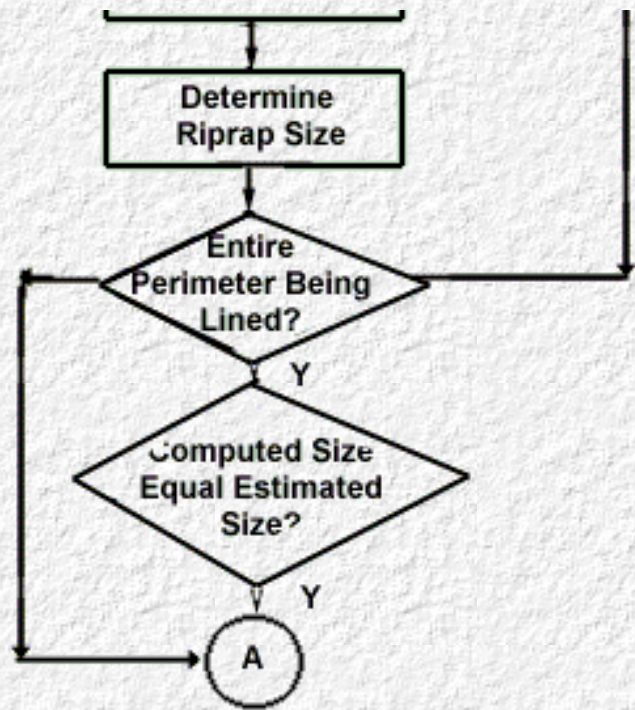

ROCK SIZING
(CONTINUED)

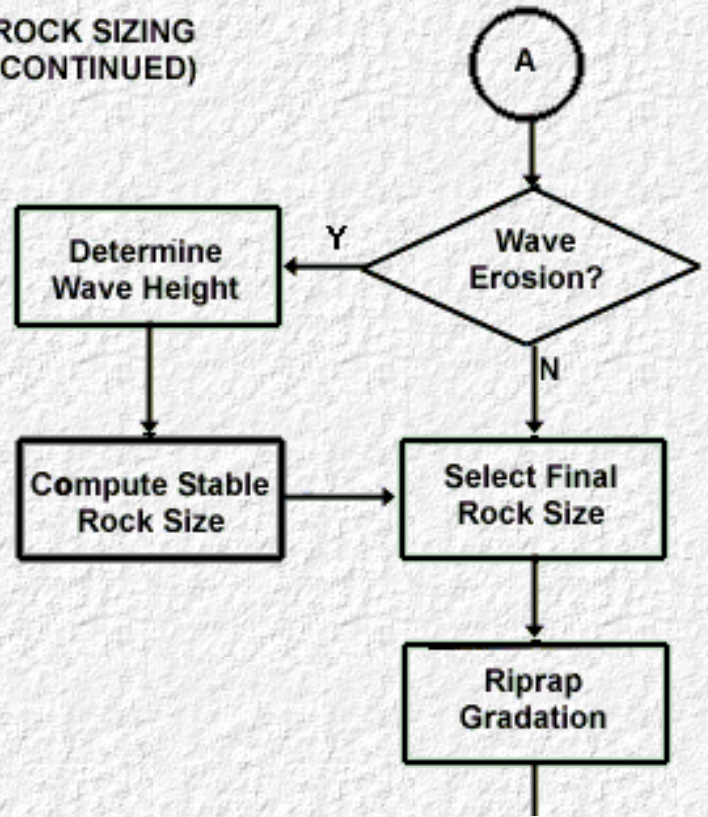

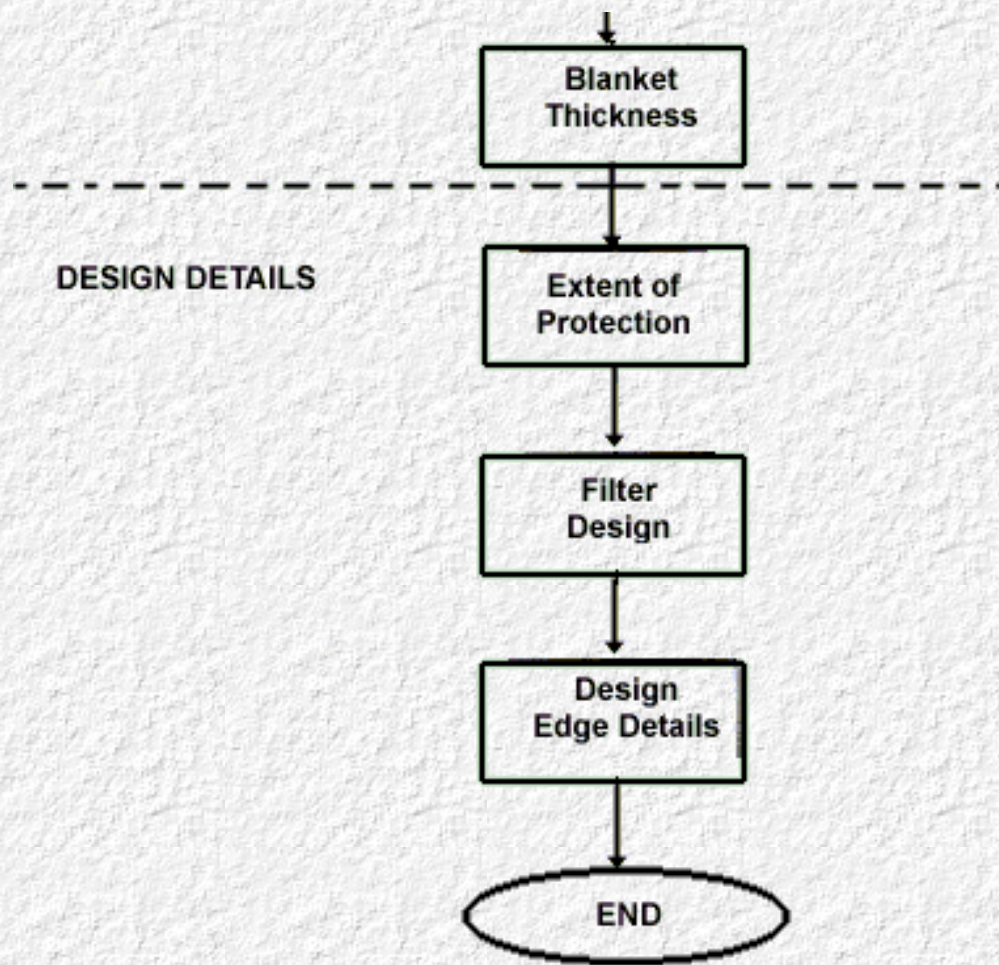

Figure 23. Riprap Design Procedure Flow Chart

Step 5. Determine design average velocity and depth.

. Average velocity and depth should be determined for the design section in conjunction with the computations of step 4. In general, the average depth and velocity in the main flow channel should be used.

B. If riprap is being designed to protect channel banks, abutments, or piers located in the floodplain, average floodplain depths and velocities should be used.

Step 6. Compute the bank angle correction factor K_1 [Section 4.1.1](#), [Equation 7](#), [Chart 3](#).

● **Step 7.** Determine riprap size required to resist particle erosion equation.

See [Section 4.1.1](#), [Equation 6](#), [Chart 1](#).

- . Initially assume no corrections.
- B. Evaluate correction factor for rock riprap specific gravity and stability factor ($C = C_{sg} C_{sf}$).
- C. If designing riprap for piers or abutments apply pier/abutment correction ($C_{P/A}$) or 3.38.
- D. Compute corrected rock riprap size as:

$$D'_{50} = C(C_{P/A})D_{50}$$

● **Step 8.** If entire channel perimeter is being stabilized, and an assumed D_{50} was used in determination of Manning's 'n' for backwater computations, return to step 4 and repeat steps 4 through 7.

● **Step 9.** If surface waves are to be evaluated: [Form 2](#).

- . Determine significant wave height (see [Section 3.6.2](#), and [Chart 6](#)).
- B. Use [Chart 7](#) to determine rock size required to resist wave action (see [Section 4.1.2](#), [Equation 12](#)).

● **Step 10.** Select final D_{50} riprap size, set material gradation (see [Section 4.2](#) and [Form 3](#)), and determine riprap layer thickness (see [Section 4.3](#)).

5.3 Revetment Details

● **Step 11.** Determine longitudinal extent of protection required [Section 3.6.1](#).

● **Step 12.** Determine appropriate vertical extent of revetment [Section 3.6.2](#).

● **Step 13.** Design filter layer. [Section 4.4](#). [Form 5](#).

Determine appropriate filter material size, and gradation.

Determine layer thickness.

5.4 Design Examples

The following design examples illustrate the use of the design methods and procedures outlined above. Two examples are given; Example 1 illustrates the design of a riprap lined channel section. Example 2 illustrates the design of riprap as bank protection. In the examples, the steps correlate with the design procedure outline presented above. Reference is also made to appropriate sections from the manual which outline procedures used. Computations are also shown on appropriate forms.

5.4.1 Example Problem #1

A 381 m channel reach is to be realigned to make room for the widening of an existing highway. Realignment of the channel reach will necessitate straightening the channel and reducing its length from 381 m to 305 m. The channel is to be sized to carry 141.6 m³/s within its banks. Additional site conditions are as follows:

- Flow conditions can be assumed to be uniform or gradually varying;
- The existing channel profile dictates that the straightened reach be designed at a uniform slope of 0.0049;
- The natural soils are gap graded from medium sands to coarse gravels as illustrated in the gradation curve of [Figure 29](#). The gradation curve indicates the following soil characteristics:
 1. $D_{85} = 0.032$ m
 2. $D_{50} = 0.018$ m
 3. $D_{15} = 0.001$ m
- K (permeability) = 3.5×10^{-4} m/s
- Available rock riprap has a specific gravity of 2.65.

Design a stable trapezoidal riprap lined channel for this site. Design forms and chart used in this example are reproduced in [Figure 24](#), [Figure 25](#), [Figure 26](#), [Figure 27](#), [Figure 28](#), [Figure 29](#), and [Figure 30](#).

Step 1. Compile Field Data

- See given information for this example.

- Other field data would typically include site history, geometric constraints, roadway crossing profiles, site topography, etc.

● **Step 2.** Design Discharge. See [Section 3.1](#).

- Given as 119 m³/s.
- Discharge in main channel equals the design discharge since entire design discharge is to be contained in channel as specified.

● **Step 3.** Design Cross Section. See [Section 3.3](#).

- As specified, a trapezoidal section is to be designed.
- Initially assume a trapezoidal section with 6.1 m bottom width and 1V:2H side slopes. See [Form 1](#).

● **Step 4.** Compute Design Water Surface.

(a) Determine roughness coefficient using [Form 4](#) (see [Section 3.5](#)).

Using procedures of reference 17

$$n = (n_b + n_1 + n_2 + n_3 + n_4) m$$

n_b : base channel "n"

$$\text{slope} = 0.0049 > 0.002$$

Therefore, use [Equation 4](#) for computation of the base n value.

$$n_b = 0.3225 S_f^{0.38} R^{-0.16}$$

assume $R = 2.43$ m

$$n_b = 0.037$$

n_1 : irregularity factor

$$n_1 = 0.00 \text{ smoothest Channel obtainable in natural materials}$$

n_2 : variation in cross section

$$n_2 = 0.00 \text{ size and shape of cross section constant}$$

n_3 : effect of obstructions

$n_3 = 0.00$ no obstructions

n_4 : amount of vegetation

$n_4 = 0.003$ minor (assumes some growth within riprap)

m : degree of meander

$m = 1.0$ straight reach

$n = (0.037 + 0.00 + 0.00 + 0.00 + 0.003)1$

$n = 0.040$

(b) Compute flow depth.

- Solve Manning's equation for normal depth (use computer programs, or charts and tables available in open channel hydraulics texts of procedure manuals).

$$Q = (1/n) A R^{2/3} S^{1/2}$$

$d = 3.60$ m Column 1 of [Form 1](#)

- Compute hydraulic radius to compare with the assumed value used in Step 4a (use computer programs, available charts and tables, or manually compute).

$$R = A/P$$

$$R = 47.9/22.2 = 2.16$$

$$R = 2.16 \text{ not equal to } R_{\text{assumed}} = 2.43$$

Therefore, return to Step 4a

$$n_b = 0.3225 (0.0049)^{0.38} (2.16)^{-0.16}$$

$$n_b = 0.038$$

$$n = (0.038 + 0.003)1 = 0.041$$

which is approximately equal to 0.040 used above, therefore,

$$d = 3.60 \text{ m (Column 1 of [Form 1](#))}$$

Step 5. Determine Design Parameters

$$A = 3.6(3.6(4) + 6.1 + 6.1)/2 = 47.8 \text{ m}^2 \text{ (Column 2 of [Form 1](#).)}$$

$$V_a = Q/A = 141.6/47.8 = 2.96 \text{ m/s (Column 3 of [Form 1](#).)}$$

$$d_a = d = 3.60 \text{ m (uniform channel bottom) (Column 4 of [Form 1](#))}$$

Step 6. Bank Angle Correction Factor. See [Section 4.1.1](#).

$$\theta = 1V:2H \text{ (Column 5 of [Form 1](#).)}$$

$$f = 41^\circ \text{ ([Figure 25](#))}$$

$$K_1 = 0.73 \text{ ([Figure 26](#))}$$

Step 7. Determine riprap size See [Section 4.1](#).

(a) Using [Chart 1 \(Figure 27\)](#)

for channel bed $D_{50} = 0.085 \text{ m}$ (Column 8 of [Form 1](#))

for channel bank $D_{50} = 0.131 \text{ m}$ (Column 8 of [Form 1](#))

(b) Riprap specific gravity = 2.65 (given) (Column 10 of [Form 1](#))

Stability factor = 1.2 (uniform flow, little or no uncertainty in design)

$$C = 1 \quad \text{[Chart 2, Figure 28](#).$$

(c) no piers or abutments to evaluate for this example, therefore

$$C_{p/a} = 1 \text{ (Column 12 of [Form 1](#))}$$

(d) Corrected riprap size

For channel bed

$$D'_{50} = D_{50} = 0.085 \text{ m (Column 13 of [Form 1](#))}$$

For channel banks

$$D'_{50} = D_{50} = 0.131 \text{ m (Column 13 of [Form 1](#))}$$

● **Step 8.** not applicable

● **Step 9.** Surface wave See [Section 4.1.2](#).

Surface waves determined not to be a problem at this site.

● **Step 10.** Select Design Riprap Size, Gradation, and Layer Thickness

D_{50} size: Recommend AASHTO Face Class riprap

$$D_{50} = 0.29 \text{ m (for entire perimeter) See [Figure 24](#) .}$$

Gradation: See [Form 1](#), [Figure 24](#) See [Section 4.2](#).

Layer thickness (T): See [Section 4.3](#).

$$T = 2 D_{50} = 0.58 \text{ m}$$

$$T = 0.58 \text{ m}$$

or

$$T = D_{100} = 0.40 \text{ m}$$

Use $T = 0.60 \text{ m}$ See [Figure 24](#).

● **Step 11.** Longitudinal Extent of Protection See [Section 3.6.1](#).

Riprap lining to extend along entire length of straightened reach.

● **Step 12.** Vertical Extent of Protection See [Section 3.6.2](#).

Riprap entire channel perimeter to top-of-bank.

Step 13. Filter Layer Design See [Section 4.4](#).

(a) Filter material size:

$$\frac{D_{15}[\text{coarser layer}]}{D_{85}[\text{Finer Layer}]} < 5 < \frac{D_{15}[\text{coarser layer}]}{D_{15}[\text{finer layer}]} < 40$$

For the riprap to soil interface:

$$\frac{D_{15}[\text{riprap}]}{D_{85}[\text{soil}]} = \frac{0.18}{0.032} = 6 > 5$$

and

$$\frac{D_{15}[\text{riprap}]}{D_{15}[\text{soil}]} = \frac{0.18}{0.001} = 180 > 40$$

Therefore, a filter layer is needed.

Try *50 mm* uniformly graded coarse gravel filter (gradation characteristics as illustrated in [Form 3](#), [Figure 29](#)).

For the filter to soil interface:

$$\frac{D_{15}[\text{filter}]}{D_{85}[\text{soil}]} = \frac{0.030}{0.032} = 0.94 < 5$$

and

$$\frac{D_{15}[\text{filter}]}{D_{15}[\text{soil}]} = \frac{0.030}{0.001} = 30 > 5 \text{ and } < 40$$

Therefore, filter to soil interface is OK.

For the riprap to filter interface:

$$\frac{D_{15}[\text{riprap}]}{D_{85}[\text{filter}]} = \frac{0.18}{0.061} = 3 < 5$$

$$D_{50} = 0.00594 V_a^3 / (d_{avg}^{0.5} K_1^{2.5})$$

D_{50} = Median Riprap Size (m)

V_a = Average velocity in main channel (m/s)

d_{avg} = Average depth in main channel (m)

K_1 = Bank angle correction term

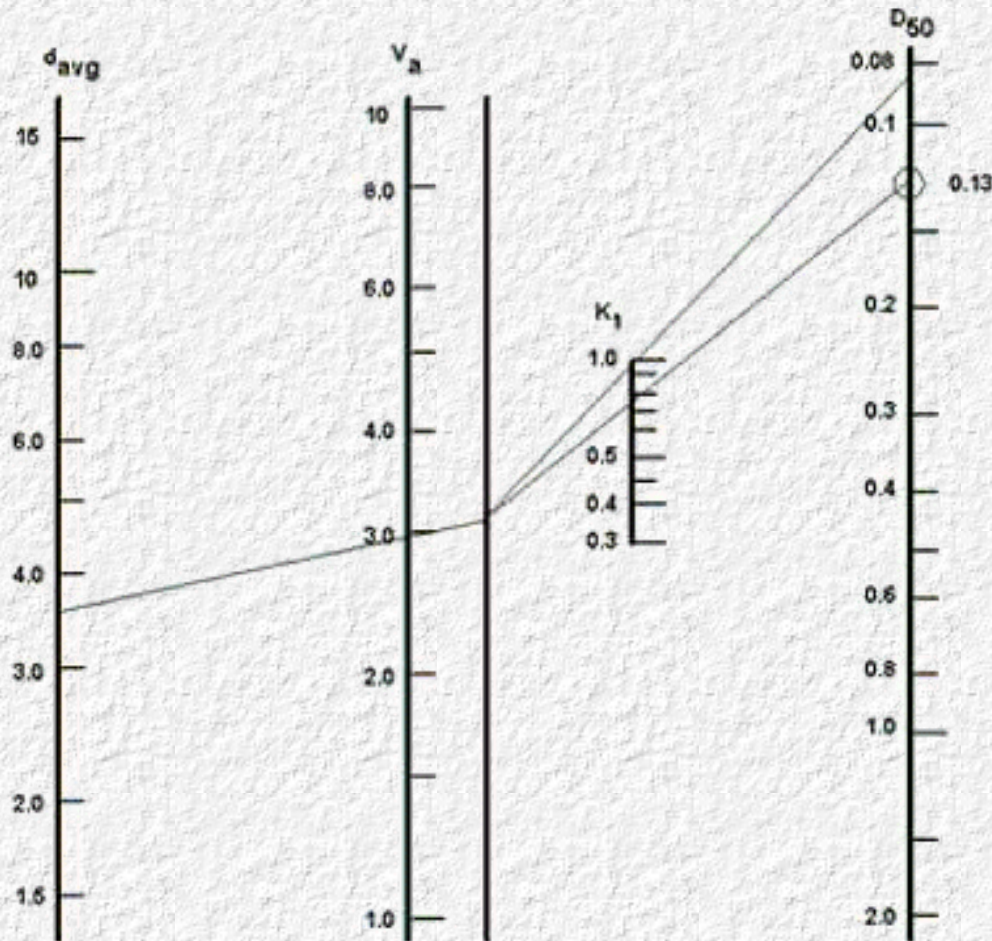

Example
Given:
 $V_s = 2.96 \text{ m/s}$
 $d_{50} = 3.5 \text{ m}$
 $K_s = 0.73$

Find:
 D_{50}

Solution:
 $D_{50} = 0.13 \text{ m}$

and

$$\frac{D_{15}[\text{riprap}]}{D_{15}[\text{filter}]} = \frac{0.18}{0.030} = 6 > 5 \text{ and } < 40$$

Therefore, the 50 mm filter material is adequate.

(b) Filter layer thickness:

Since soil gradation curve and filter layer gradation curve are not approximately parallel, use layer thickness of 200 mm.

 **Step 14.** Edge Details see [Section 4.6](#)

Line entire perimeter; edge details as per [Figure 20](#)
(also see sketch on [Form 1](#), [Figure 24](#)).

Project _____	Prepared by/date: _____ / _____
Description _____	Checked by/date: _____ / _____ sheet _____ of _____

Definition Sketch:

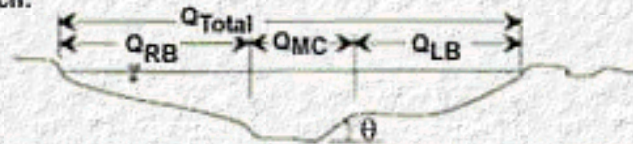

Q_{TOTAL} 141.6 m³/s Soil Characteristics
 Q_{MC} 141.6 m³/s D_{15} 0.0014 m
 Q_{LB} _____ D_{50} 0.012 m
 Q_{RB} _____ D_{85} 0.032 m

DEPTH of W.S. (m) 1	A (m ²) 2	V _a (m/sec) 3	d _a (m) 4	θ 5	ϕ 6	K ₁ 7	D ₅₀ (m) 8	SF 9	S _s 10	C 11	C _{P/A} 12	D ₅₀ (m) 13	Notes: 14
3.61	156.82	2.96	3.61	1V-2H	41°	0.73	0.131	1.2	2.65	1	N/A	0.131	Bank
							0.09	1.2	2.65	1	N/A	0.131	Bed

<p>Design Sketch:</p> <p>A cross-sectional diagram of a riprap channel. The channel has a bottom width of 6.1 m and a depth of 3.61 m. The side slopes are 1.22 m high. The angle of repose is indicated as T=0.61.</p>	<p>Riprap Characteristics:</p> <p>SIZE: THICKNESS: D_{50} 20₅₀ Class D_{100}</p> <p>AASHTO Use Gradation: Size (m) Percent Finer <u>0.40</u> 100 <u>0.20</u> 50 <u>0.12</u> 5-10</p>	<p>Fabric Characteristics:</p> <p>Granular:</p> <table style="width: 100%; border-collapse: collapse;"> <thead> <tr> <th>Size (m)</th> <th>Percent Finer</th> </tr> </thead> <tbody> <tr><td><u>0.061</u></td><td>85</td></tr> <tr><td><u>0.052</u></td><td>50</td></tr> <tr><td><u>0.030</u></td><td>15</td></tr> </tbody> </table> <p>Fabric: AOS* < _____ Perm > _____ Average Opening Size</p>	Size (m)	Percent Finer	<u>0.061</u>	85	<u>0.052</u>	50	<u>0.030</u>	15
Size (m)	Percent Finer									
<u>0.061</u>	85									
<u>0.052</u>	50									
<u>0.030</u>	15									

- | | | | |
|---------------------------------|------------------------------------|--|--|
| 1 Water Surface Elevation | 5 Bank Angle | 9 Stability Factor | 13 Correction $D_{50} = 8 + 11 \cdot 12$ |
| 2 Main Channel Flow Area | 6 Riprap Angle of Repose (chart 4) | 10 Riprap Specific Gravity | 14 Notes or Comments |
| 3 Main Channel Average Velocity | 7 Bank Angle Correction (chart 3) | 11 Riprap Size Correction Factor (chart 2) | |
| 4 Main Channel Average Depth | 8 Riprap Size (Chart 1) | 12 Pier/Abutment Correction (3.38 if applicable) | |

Figure 24. Riprap Size Form (Form 1); Example 1

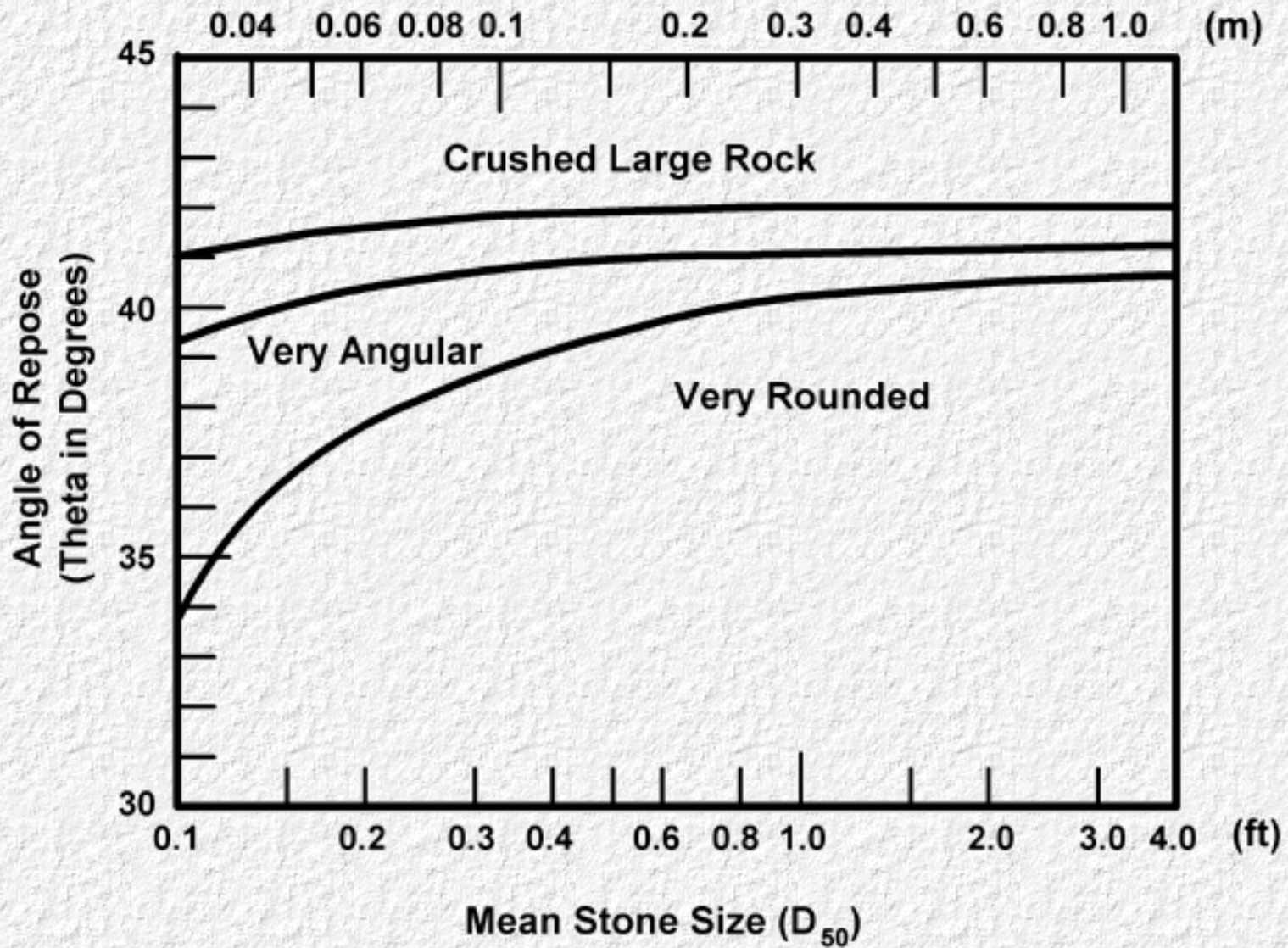
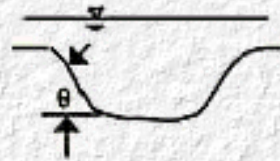

Figure 25. Angle of Repose in Terms of Mean Size and Shape of Stone ([Chart 4](#)); Example 1

The following charts may benefit from the following D_{50} Calculation form:



$$K_1 = \left[\frac{1 - \sin^2 \theta}{\sin^2 \phi} \right]^{0.5}$$

θ = Bank Angle with horizontal

ϕ = Material angle of repose (see chart 3)

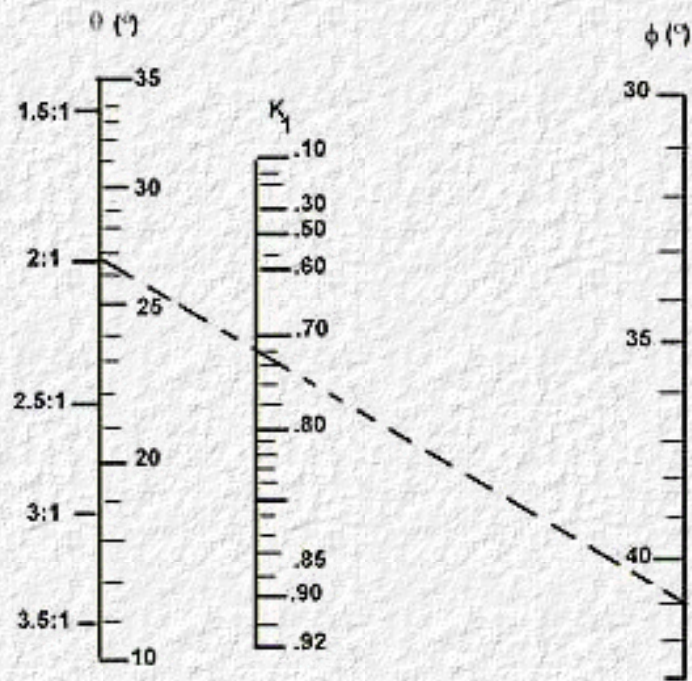

EXAMPLE 1:

Given:

$\theta = 1V:2H$
Very Angular
 $\phi = 41^\circ$

Find:

k_1

Solution:

$k_1 = 0.73$

Figure 26. Bank Angle Correction Factor (K_1) Nomograph ([Chart 3](#)); Example 1

$$D_{50} = 0.00594 V_a^3 / ([d_{avg}]^{0.5} [K_1]^{1.5})$$

D_{50} = Median Riprap Size (m)

V_a = Average velocity in main channel (m/s)

d_{avg} = Average depth in main channel (m)

K_1 = Bank angle correction term

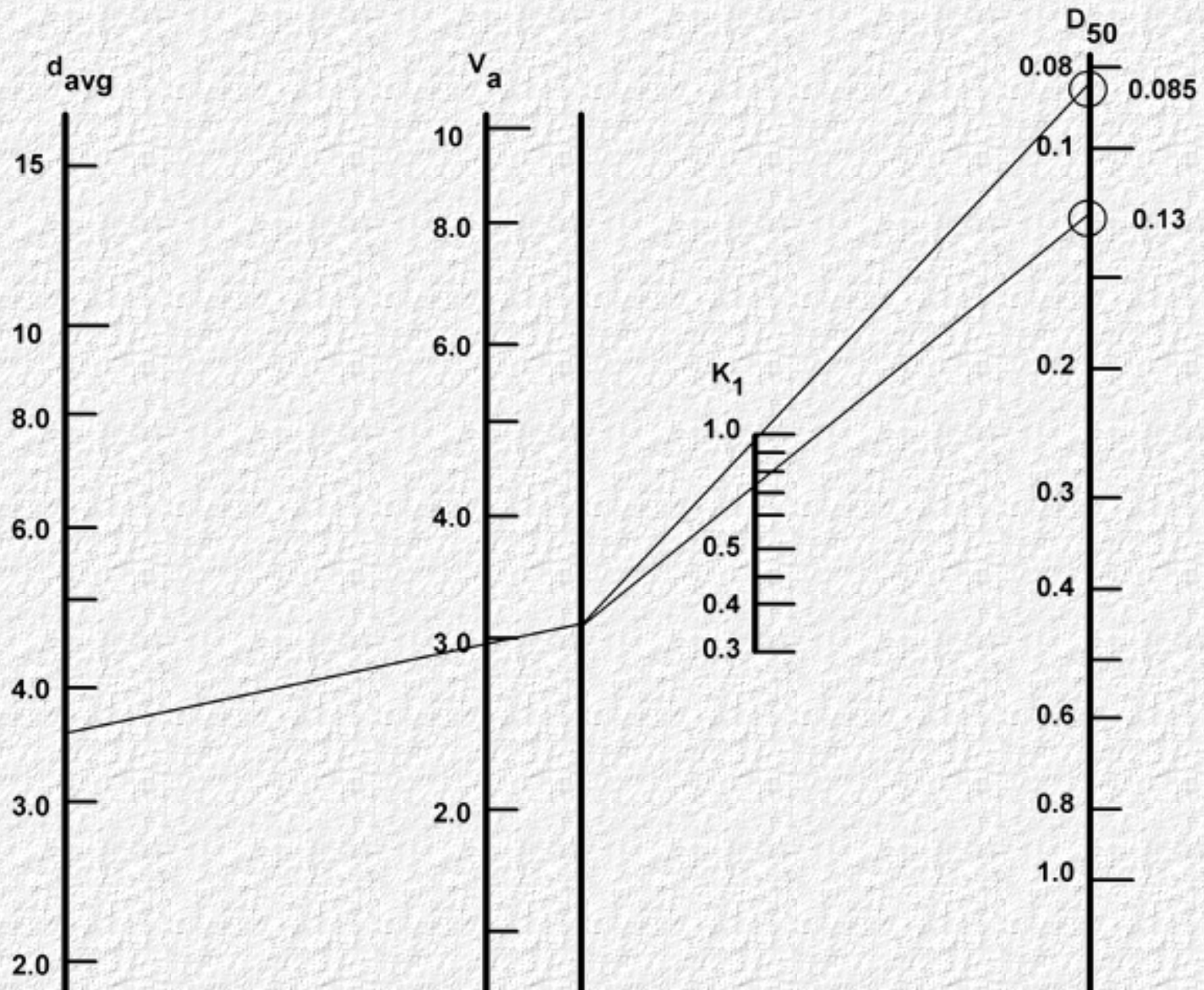

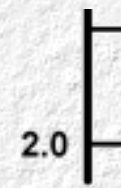
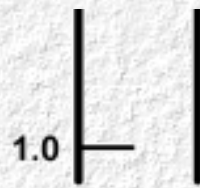
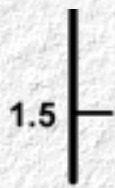

Example

Given:

$V_a = 2.96 \text{ m/s}$
 $d(\text{avg}) = 3.6 \text{ m}$
 $K_1 = 0.73$

Find:
 D_{50}

Solution:

$D_{50} = 0.13 \text{ m}$

Figure 27. Riprap Size Relationship ([Chart 1](#)); Example 1

$$C = 1.61 SF^{1.5} / (S_s - 1)^{1.5}$$

$C = D_{50}$ CORRECTION FACTOR

$SF =$ STABILITY FACTOR

$S_s =$ SPECIFIC GRAVITY OF ROCK

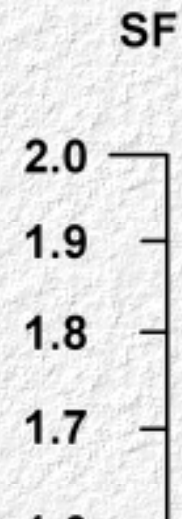
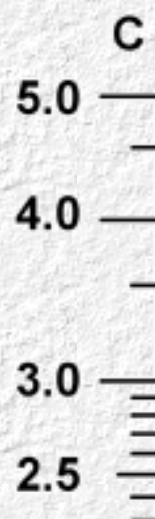
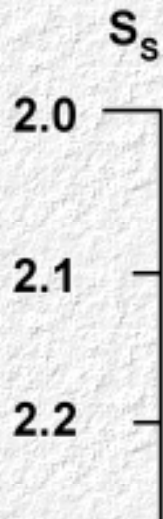

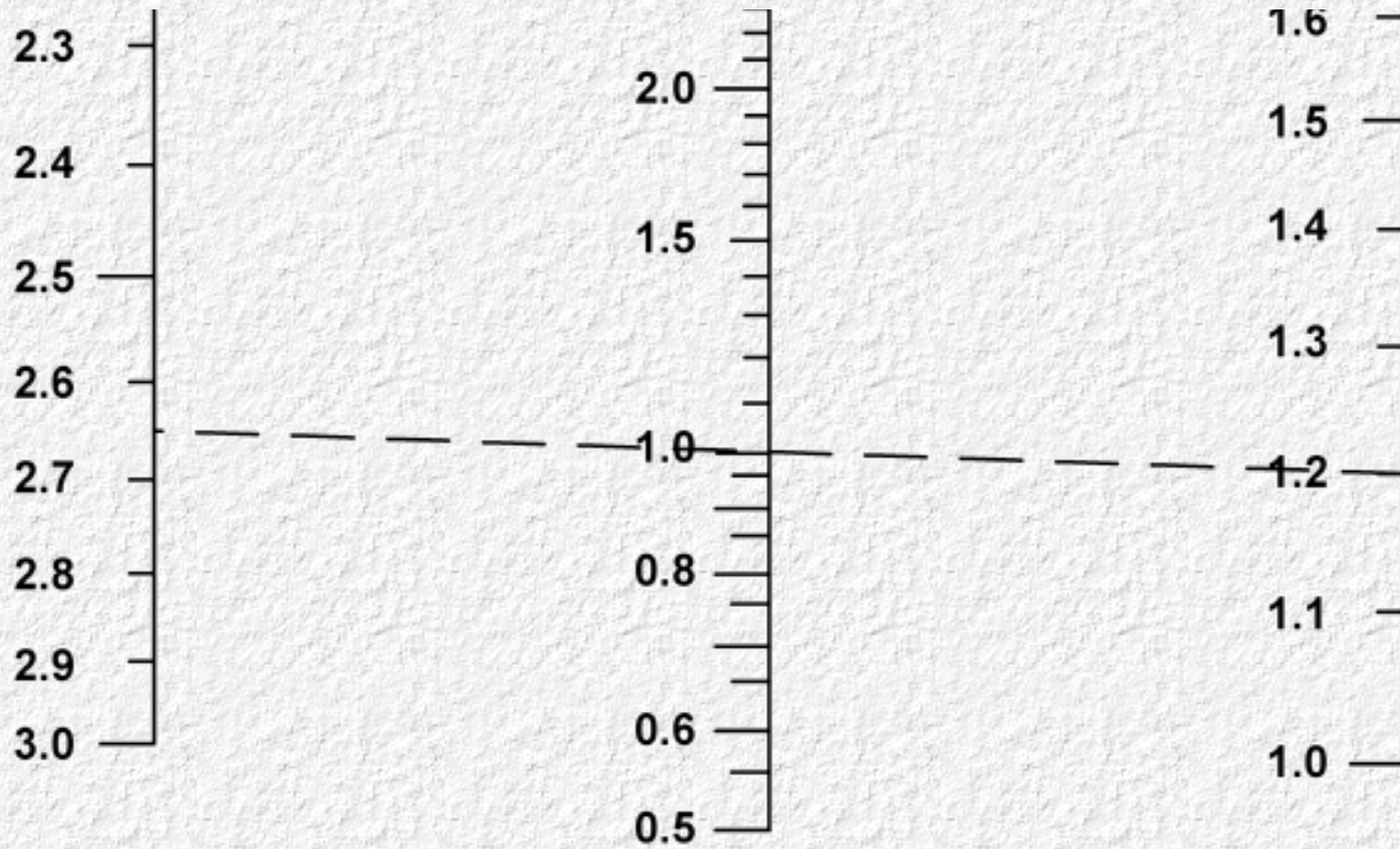

Example

Given:
 $S_s = 2.65$
 $SF = 1.2$

Find: C

Solution:
 $C = 1.0$

Figure 28. Correction Factor for Riprap Size ([Chart 2](#)); Example 1

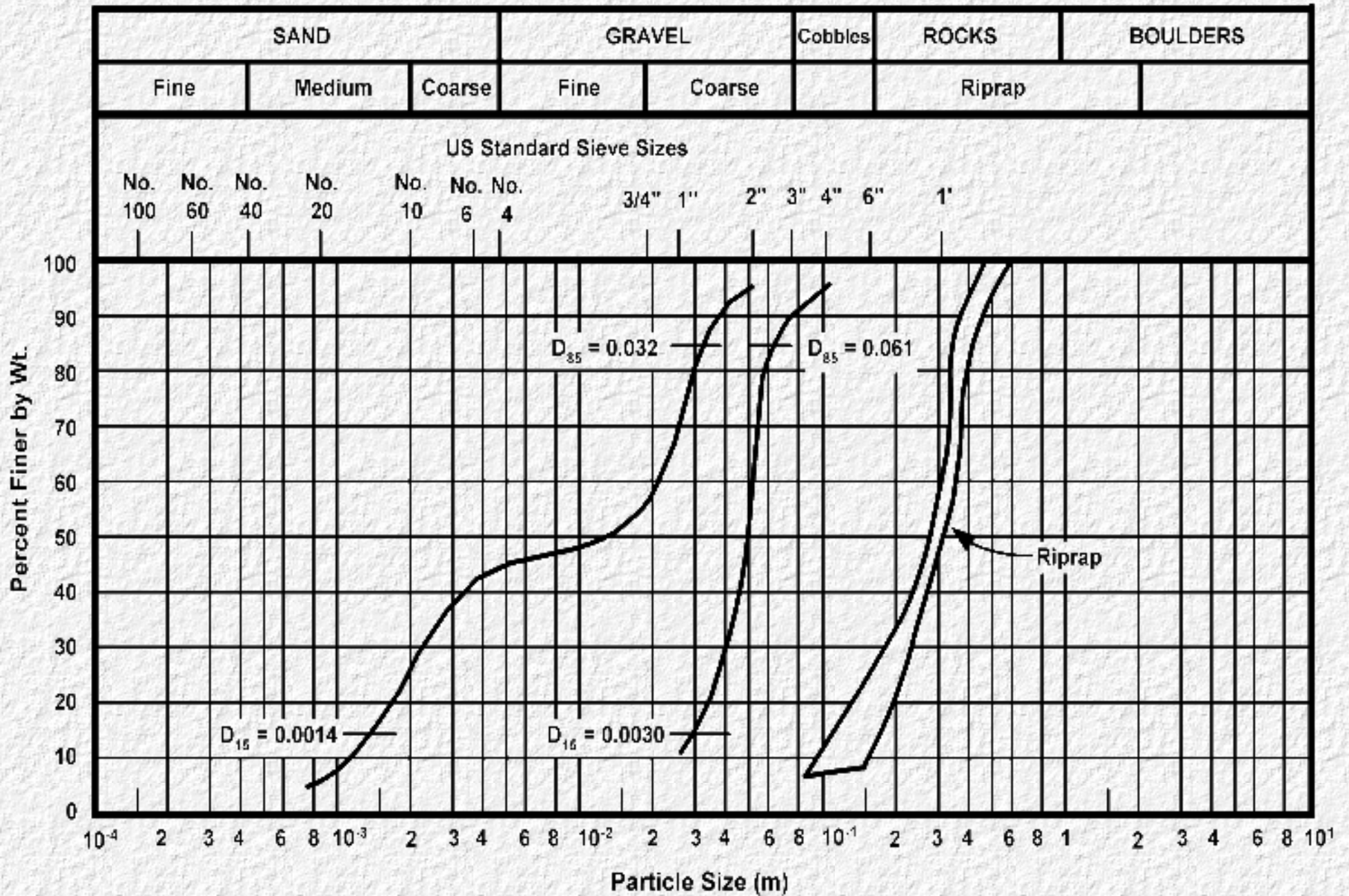

Figure 29. Material Gradation ([Form 3](#)); Example 1

PROJECT: Example 1	Prepared by/Date: _____
DESCRIPTION: _____	Checked by/ Date: _____
	Sheet _____ of _____

Adjustments to n

FACTOR	Condition Description	Adjustment
Base n, n_b (1,2)	Slope = 0.0049; equation 4	0.037
Irregularity, n_1 (2)	Smoothest channel available in natural materials	0.00
Alignment, n_2 (2)	Size and shape of cross section constant	0.00
Obstruction, n_3 (2)	No obstructions	0.00
Vegetation, n_4 (2)	Minor vegetation (some growth within the riprap)	0.003
Meander, m (2)	Straight reach	1.0
Weighted n plus adjustments (3)		0.040
Use n		0.040

$$n_b = \{0.382 (D_{50})^{0.5} / (1.092 d_a)\} \quad \text{for } 1.5 < d_a / D_{50} < 35$$

$$n_b = 0.0429 D_{50}^{0.167} \quad \text{for } 35 < d_a / D_{50} < 30.000$$

$$n_b = 0.3225 S_f R^{-0.16} \quad \text{for steep mountain streams}$$

(2) See reference (17)

(3) $n = m(n_1 + n_2 + n_3 + n_4)$

Figure 30. Roughness Evaluation ([Form 4](#)); Example 1

5.5.2 Example Problem #2

The site illustrated in [Figure 14](#) and discussed in [Section 3.3](#) is migrating laterally towards Route 1 (see [Figure 14a](#)). Design a riprap revetment to stabilize the active bank erosion at this site. Additional site conditions are as follows:

- flow conditions are gradually varying;
- channel characteristics are as described in [Section 3.3](#);
- Topographic survey indicates:
 1. channel slope = 0.0024

2. channel width = 91.4 m
 3. bend radius = 365.8 m
- channel bottom is armored with cobble size material having a D_{50} of approximately 0.15 m;
 - bank soils are silty sands as illustrated in the gradation curve of [Figure 38 \(Form 3\)](#). The gradation curve indicates the following soil characteristics:
 1. $D_{85} = 0.0013$ m
 2. $D_{50} = 0.0005$ m
 3. $D_{15} = 0.00014$ m

K (permeability) = 1×10^{-6} m/s

- Available rock riprap has a specific gravity of 2.60, and is described as angular.
- field observations indicate that the banks are severely cut just downstream of the bend apex; erosion was also observed downstream the bend exit and upstream to the bend quarter points;
- bank height along cut banks is approximately 2.7 m.

Design forms and charts used in this example are reproduced on the pages following this example.

● **Step 1. Compile Field Data.**

- See given information for this example.
- See site history given in [Section 3.3](#).

● **Step 2. Design Discharge.** See [Section 3.1](#).

- Given as $1,112 \text{ m}^3/\text{s}$.
- From backwater analysis of this reach, it is determined that the discharge confined to the main channel (Q_{mc}) is $982.6 \text{ m}^3/\text{s}$.

● **Step 3. Design Cross Section.** See [Section 3.3](#).

- Only the channel bank is to be stabilized; therefore, the channel section will consist of the existing channel with the bank graded to an appropriate angle to support the riprap revetment. [Figure 31](#) illustrates the existing channel section.
- To minimize loss of bank vegetation, and limit the encroachment of the channel on adjacent lands, a 1V:2H bank slope is to be used.

- As given, the current bank height along the cut banks is 2.7 m.

Step 4. Compute Design Water Surface.

(a) Determine roughness coefficient. See [Section 3.5](#).

Using procedures of [Form 4](#).

$$n = (n_b + n_1 + n_2 + n_3 + n_4)m$$

n_b : base channel "n"

$$\text{slope} = 0.0024 > 0.002$$

Therefore, use [Equation 4](#) for computation of the base n value.

$$n_b = 0.3225 S_f^{0.38} R^{-0.16}$$

assume $R = 3.05$ m

$$n_b = 0.028$$

n_1 : irregularity factor

$$n_1 = 0.005 \text{ minor - moderately eroded side slopes}$$

n_2 : variation in cross section

$$n_2 = 0.005 \text{ occasional shape changes cause flow shifting}$$

n_3 : effect of obstructions

$$n_3 = 0.000 \text{ no obstructions}$$

n_4 : amount of vegetation

$$n_4 = 0.000 \text{ no vegetation}$$

m: degree of meander

$$m = 1.1 \text{ minor to appreciable}$$

$$n = (0.028 + 0.005 + 0.005 + 0.000 + 0.000) 1.10$$

$$n = 0.042$$

This represents the average reach "n" used in the backwater analysis.

(b) Compute flow depth.

- Flow depth determined from backwater analysis. The maximum main channel depth was determined to be:

$$d_{\max} = 4.6 \text{ m} \quad \text{Column 1 of [Form 1](#)}$$

Hydraulic radius for main channel

$$R = 3.2 \text{ m (from backwater analysis)}$$

R_{assumed} (3 m) is approximately equal to R actual, therefore, "n" as computed is OK.

● **Step 5.** Determine Other Design Parameters.

From backwater analysis: (all main channel values).

$$A = 838.2 \text{ m}^2 \quad \text{Column 2 of [Form 1](#)}$$

$$V_a = 3.84 \text{ m/s} \quad \text{Column 3 of [Form 1](#)}$$

$$d_a = d = 3.66 \text{ m} \quad \text{Column 4 of [Form 1](#)}$$

● **Step 6.** Bank Angle Correction Factor. See [Section 4.1.1](#).

$$\theta = 1V:2H \quad \text{Column 5 of [Form 1](#)}$$

$$\phi = 41^\circ \quad \text{Column 6 of [Form 1](#) (from chart 4, Figure 33)}$$

$$K_1 = 0.73 \quad \text{Column 7 of [Form 1](#) (from chart 3, Figure 34)}$$

● **Step 7.** Determine riprap size. See [Section 4.1](#).

(a) Using [Chart 1 \(Figure 35\)](#).

$$D_{50} = 0.27 \text{ m} \quad \text{Column 8 of [Form 1](#)}$$

(b) Riprap specific gravity = 2.60 (given). Column 10 of [Form 1](#).

Stability factor = 1.6. Column 9 of [Form 1](#).

(gradually varying flow, sharp bend - bend radius to width = 4).

$C = 1.6$ See [Figure 36](#)

(c) no piers or abutments to evaluate for this example, therefore:

$C_{p/a} = 1$ Column 12 of [Form 1](#)

(d) Corrected riprap size:

$D'_{50} = D_{50} = (1.6)(1.0) = 0.44 \text{ m}$ Column 13 of [Form 1](#)

● **Step 8.** not applicable.

● **Step 9.** Surface waves. See [Section 4.1.2](#).

Surface waves determined not to be a problem at this site.

● **Step 10.** Select Design Riprap Size, Gradation, and Layer Thickness.

D_{50} size: Recommend AASHTO 0.23 Metric Ton class riprap

$D_{50} = 0.55 \text{ m}$

Gradation: See [Form 1](#), [Figure 37](#) See [Section 4.2](#)

Layer thickness (T): See [Section 4.3](#)

$T = 2 D_{50} = 2(0.55)$

$T = 1.10 \text{ m}$

or

$T = D_{100} = 0.68 \text{ m}$

Use $T = 1.10 \text{ m}$

● **Step 11.** Longitudinal Extent of Protection. See [Section 3.6.1](#).

Field observations indicate that the banks are severely cut just downstream of the bend apex; erosion was also observed downstream to the bend exit and upstream to the bend quarter points.

Establish longitudinal limits of protection to extend to a point 91.4 m (W) upstream of the bank entrance, and to a point 137 m (1.5 W) downstream of the bend exit.

Step 12. Vertical Extent of Protection. See [Section 3.6.2](#).

Riprap entire channel bank from top-of-bank to below depth of anticipated scour. Scour depth evaluated as illustrated in [Section 3.6.2.2](#):

$$d_s = 2.0 D_{50}^{-0.11} \quad (\text{Equation 5})$$

$$d_s = 2.0(0.55)^{-0.11} = 2.14 \text{ m}$$

Adding this to the observed maximum depth yields a potential maximum scour depth of:

$$4.6 + 2.1 = 6.7 \text{ m}$$

The bank material should be run to this depth, or a sufficient volume of stone should be placed at the bank toe to protect against the necessary depth of scour.

Step 13. Filter Layer Design. See [Section 4.4](#).

(a) Filter material size: [Form 5](#).

$$\frac{D_{15}[\text{coarser layer}]}{D_{85}[\text{Finer Layer}]} < 5 < \frac{D_{15}[\text{coarser layer}]}{D_{15}[\text{finer layer}]} < 40$$

For the riprap to soil interface:

$$\frac{D_{15}[\text{riprap}]}{D_{85}[\text{soil}]} = \frac{0.15}{0.0013} = 115 > 5$$

and

$$\frac{D_{15}[\text{riprap}]}{D_{15}[\text{filter}]} = \frac{0.15}{0.00014} = 1071 > 40$$

Therefore, a filter layer is needed.

Try 13 mm uniformly graded fine gravel filter (gradation characteristics as illustrated in [Form 3, Figure 38](#)).

For the filter to soil interface:

$$\frac{D_{15}[\text{filter}]}{D_{85}[\text{soil}]} = \frac{0.0047}{0.0013} = 3.7 < 5$$

and

$$\frac{D_{15}[\text{filter}]}{D_{15}[\text{soil}]} = \frac{0.0047}{0.00014} = 33.6 > 5 \text{ and } < 40$$

Therefore, filter to soil interface is OK.

For the riprap to filter interface:

$$\frac{D_{15}[\text{riprap}]}{D_{85}[\text{filter}]} = \frac{0.15}{0.03} = 5 \geq 5$$

and

$$\frac{D_{15}[\text{riprap}]}{D_{15}[\text{filter}]} = \frac{0.15}{0.0047} = 32 > 5 \text{ and } < 40$$

Therefore, the 13 mm filter material is adequate. See [Form 3, Figure 38](#) for soil, granular filter, and riprap gradation curves.

(b) Filter layer thickness:

Since soil gradation curve and filter layer, riprap, and bank soil are approximately parallel, use layer thickness of 200 mm.

(a) Flank details: See [Figure 32](#).

(b) Toe detail: See [Figure 32](#).

Anticipated scour depth below existing channel bottom at the bank (d'_s) is the depth of scour (computed in step 12) minus the current bed elevation at the bank: See [Figure 31](#).

$$6.7 - 3.2 = 3.5 \text{ m}$$

Rock quantity required below the existing bed:

$$R_q = 0.0283 d'_s (\sin^{-1} \theta)(T)(1.5)$$

where:

R_q =required riprap quantity per m of bank (m^2)

θ =the bank angle with the horizontal (degrees)

T =the riprap layer thickness (m)

$$R_q = (3.048) (2.24) (0.9144) (1.5) = 9.38 \text{ m}^2$$

A 1.83 m deep trapezoidal toe trench with side slopes of 1V:2H and 1V:1H, and a bottom width of 1.8 m contains the necessary volume.

[Figure 32](#) illustrates the resulting toe trench detail.

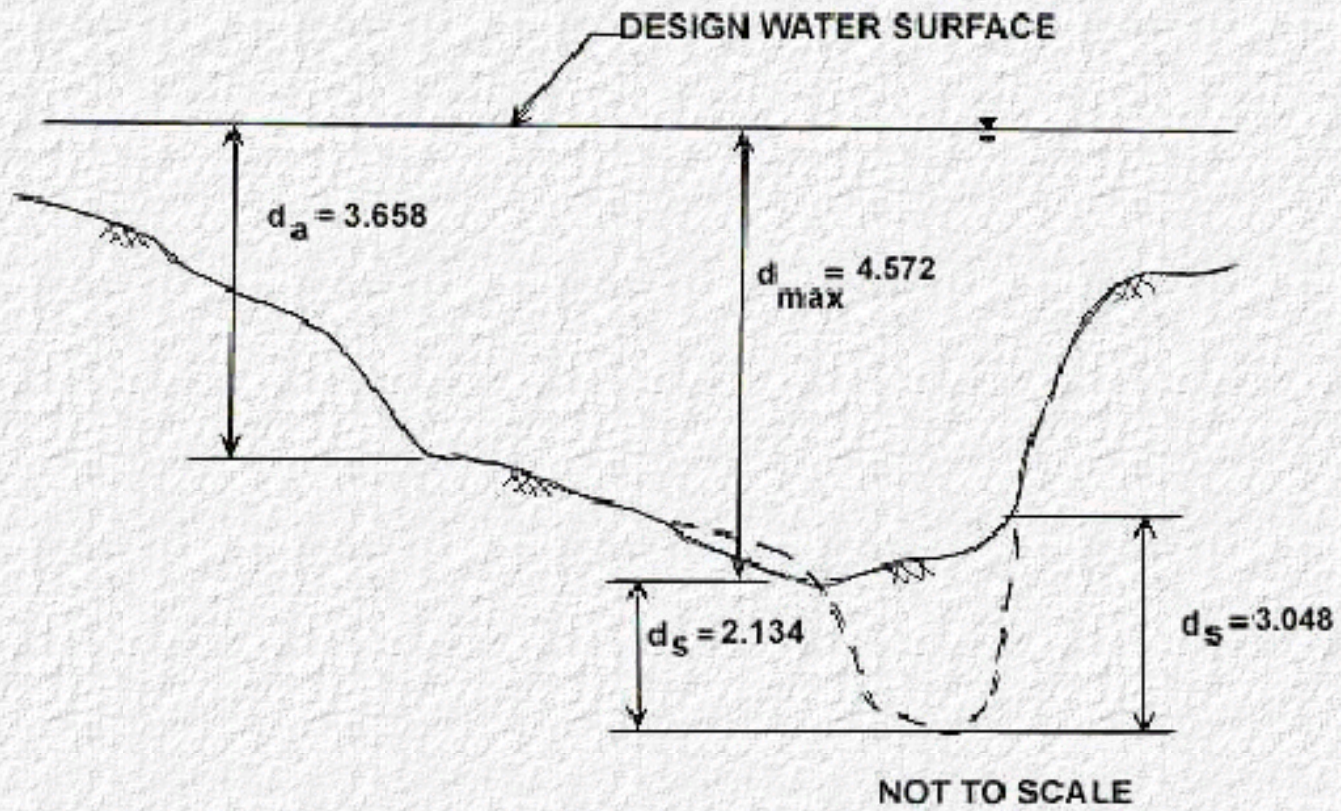
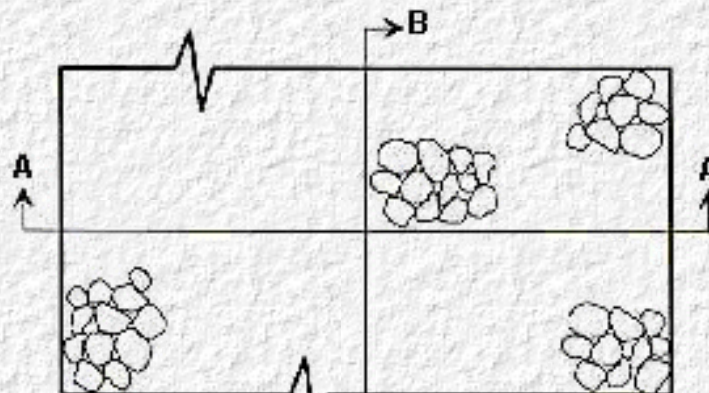

Figure 31. Channel Cross Section for Example 2, Illustrating Flow and Potential Scour Depths



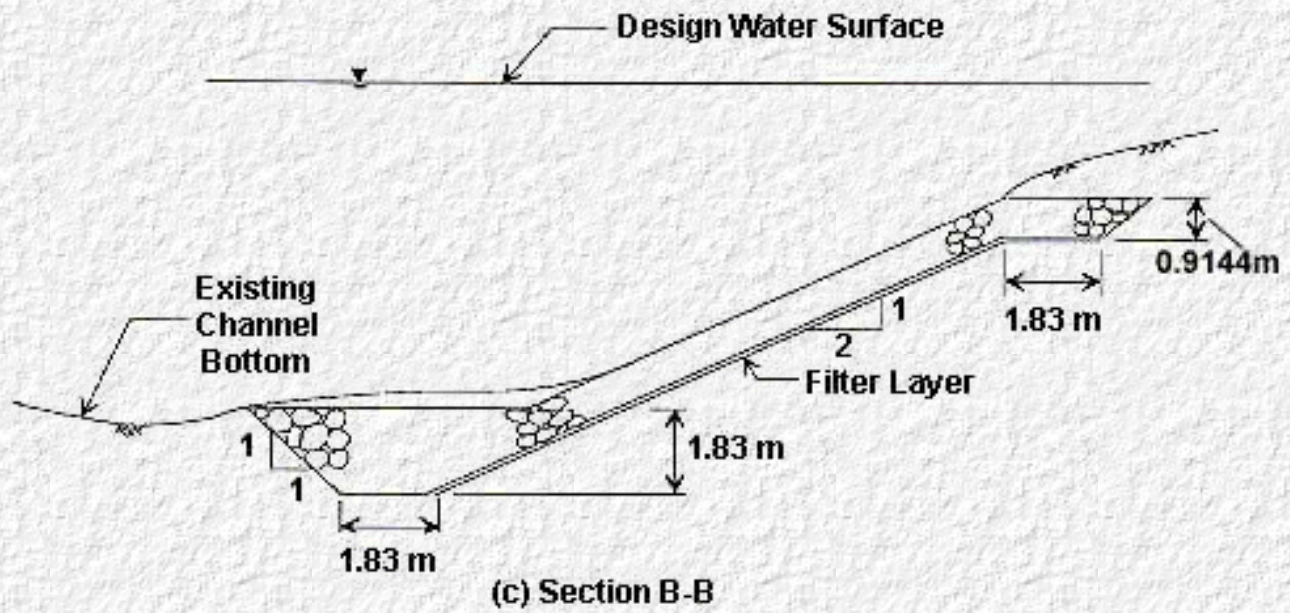
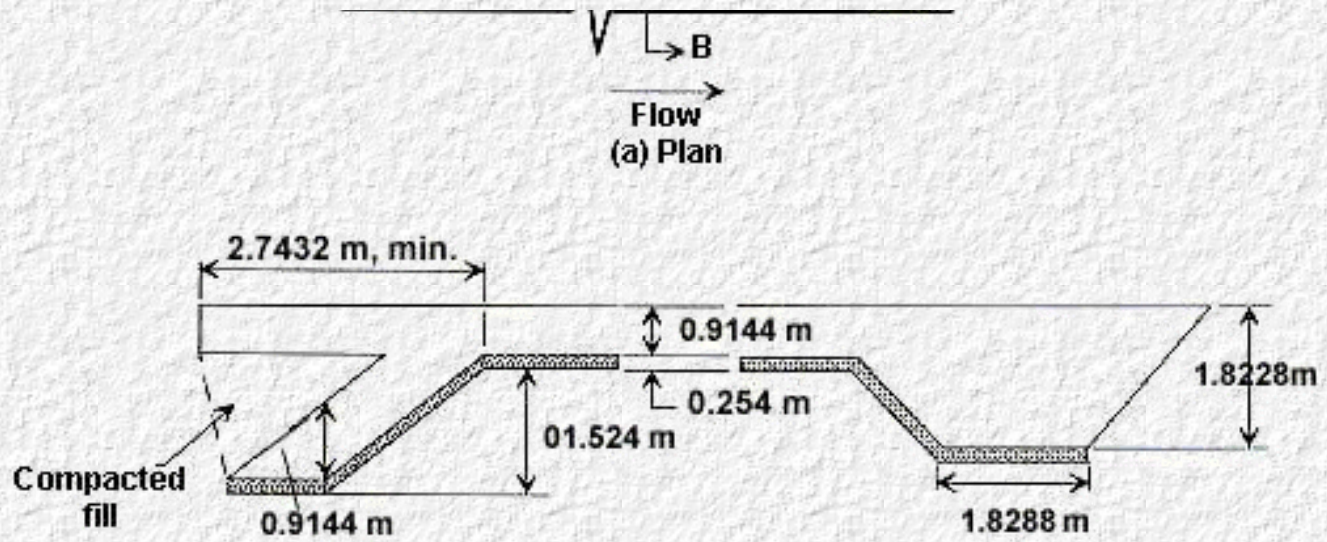

Figure 32. Toe and Flank Details; Example 2

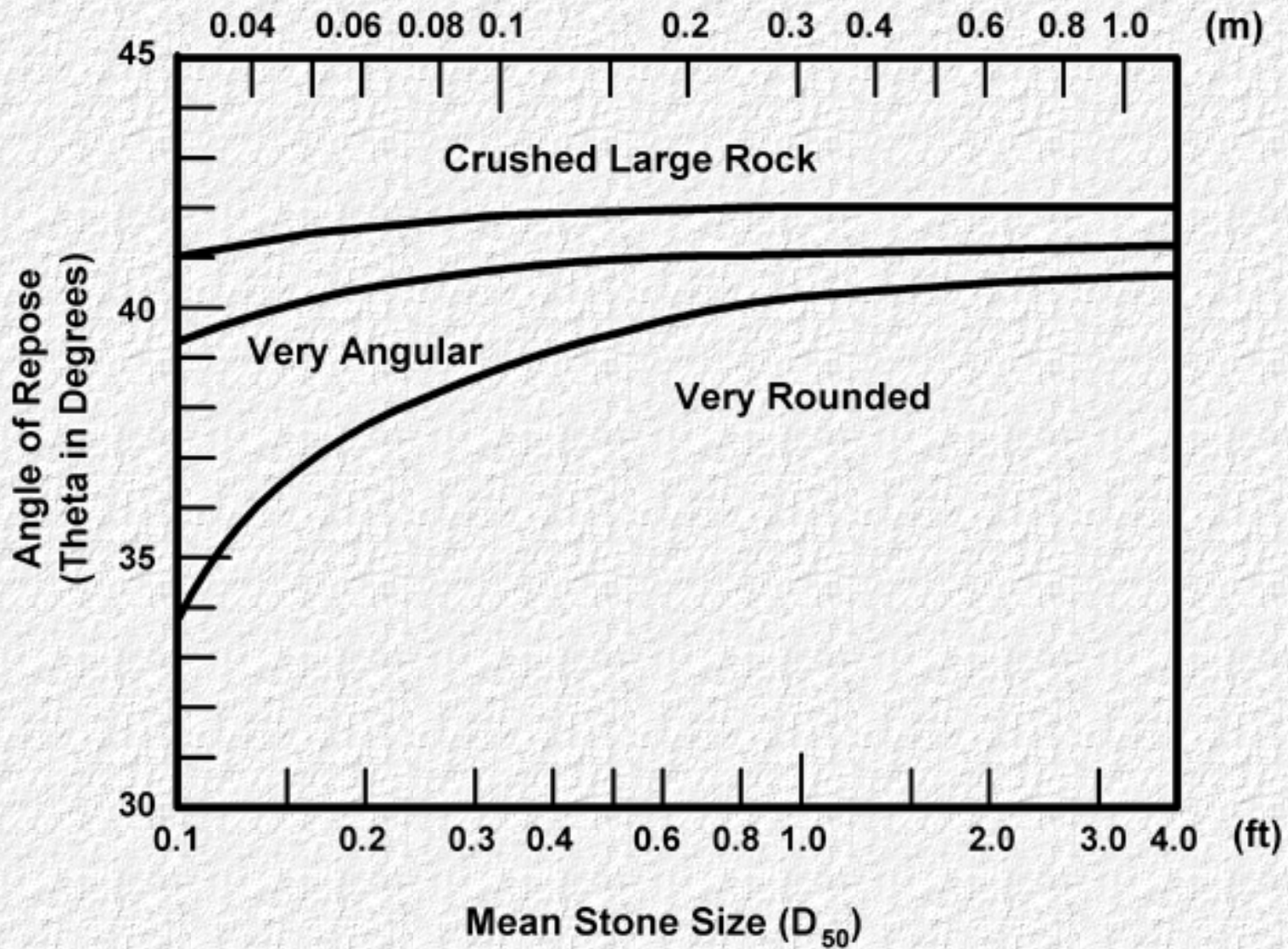

Figure 33. Angle of Repose in Terms of Mean Size and Shape of Stone ([Chart 4](#)); Example 2

The following forms may benefit from the D₅₀ Calculation form:



$$K_1 = \left[1 - \frac{\sin^2 \theta}{\sin^2 \phi} \right]^{0.5}$$

θ = Bank angle with horizontal

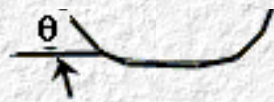

ϕ = Material angle of
Repose
(See Chart 4)

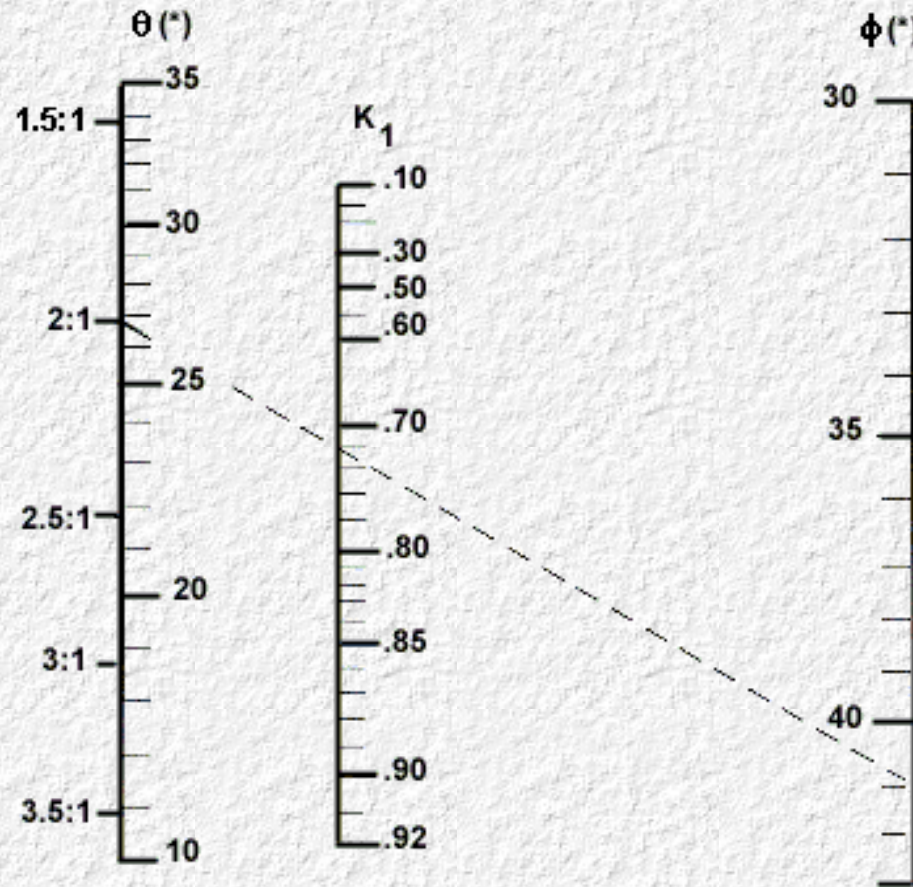

Example 1:

Given:
 $\theta = 1\sqrt{2}H$
 Very Angular
 $D_{50} = 0.56 \text{ m}$

Find:
 K_1

Solution:
 $K_1 = 0.73$
 $\phi = 41^\circ$

Figure 34. Bank Angle Correction Factor (K_1) Nomograph ([Chart 3](#)); Example 2

$$D_{50} = 0.00594 V_a^3 / (d_{avg}^{0.5} K_1^{1.5})$$

D_{50} = Median Riprap Size (m)

V_a = Average velocity in main channel (m/s)

d_{avg} = Average depth in main channel (m)

K_1 = Bank angle correction term

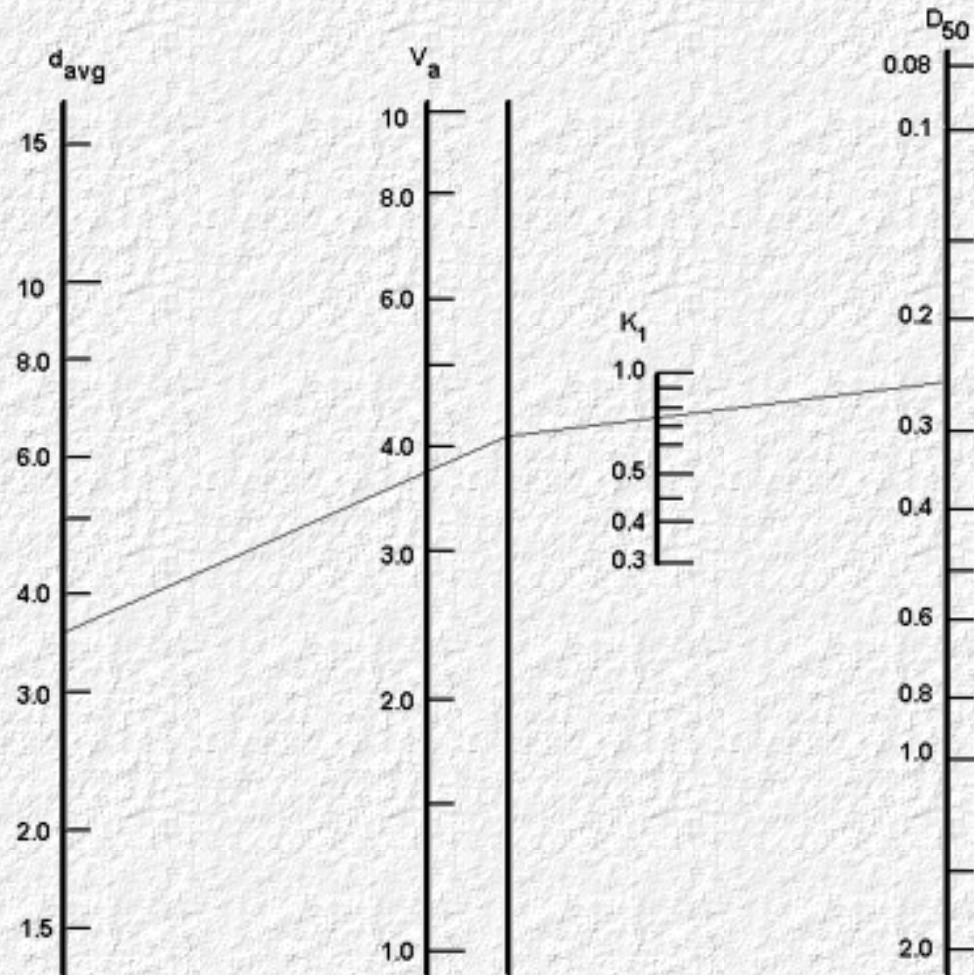

Example

Given:

$V_a = 3.84$ m/s

$d_{avg} = 3.66$ m

$K_1 = 0.73$

Find:

D_{50}

Solution:

$D_{50} = 0.27$ m

Figure 35. Riprap Size Relationship ([Chart 1](#)); Example 2

$$C = 1.61SF^{1.5} / (S_s - 1)^{1.5}$$

$C = D_{50}$ Correction Factor

SF = Stability Factor

S_s = Specific Gravity of Rock

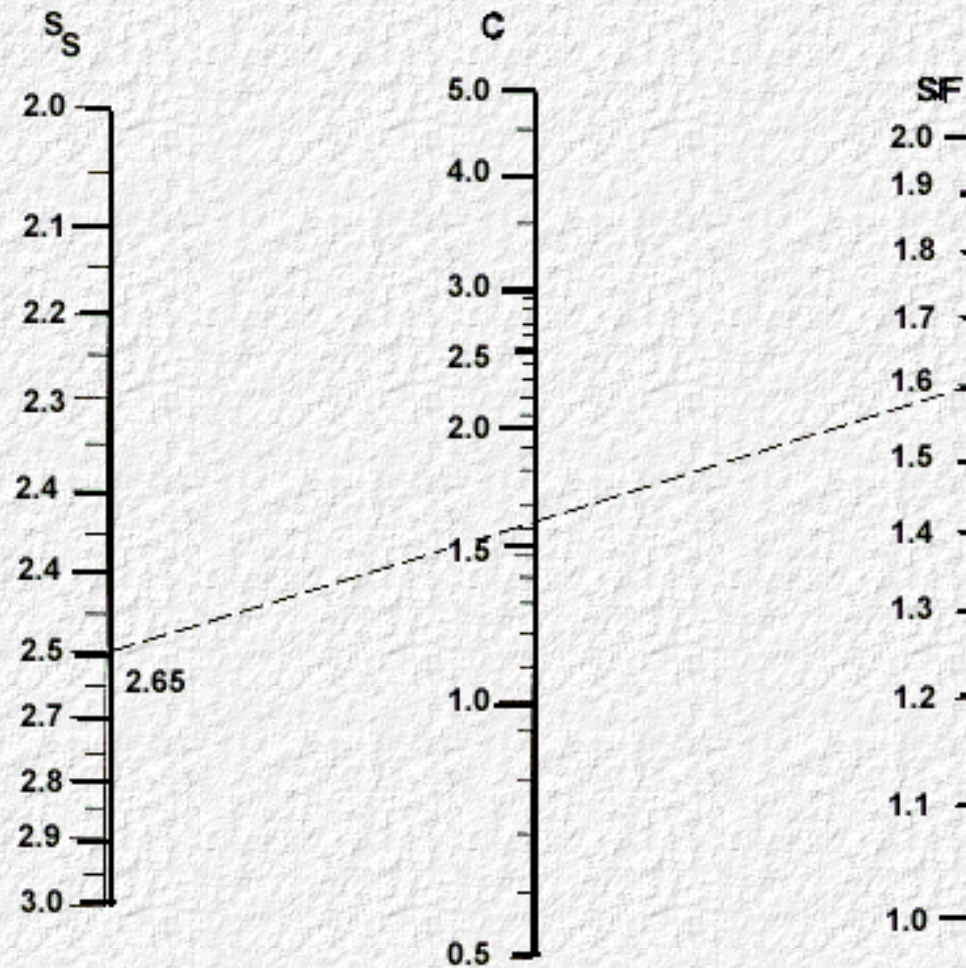

Example:

Given:
 $S_s = 2.65$

Find:
C

Solution:
C=1.6

S
SF = 1.60

Figure 36. Correction Factor for Riprap Size (Chart 2); Example 2

Project _____						Prepared by/date: _____ / _____					
Description _____						Checked by/date: _____ / _____					
						Sheet: _____ of _____					

Definition Sketch:

Soil Characteristics:
 D₁₅ _____
 D₅₀ _____
 D₈₅ _____

Depth or W.S. (m)	A _c (m ²)	V _a (m/sec)	d _s	θ	σ	K ₁	D ₅₀ (m)	SF	S _s	C	C _{P/A}	D ₅₀ (m)	Notes:
1	2	3	4	5	6	7	8	9	10	11	12	13	14
15	2750	12.6	12	1V:2H	41	0.73	0.9	1.6	2.6	1.6	1	1.44	Sharp Bend

Design Sketch:	RIPRAP CHARACTERISTICS:	FABRIC CHARACTERISTICS:
	Size: _____ Thickness: _____	Granular: Size: _____ Percent _____
	D ₅₀ <u>0.55 m</u> 2D ₅₀ <u>1.1 m</u> Class. <u>0.23 Ton</u> : D ₁₀₀ <u>0.7 m</u> Use: <u>1.1 m</u>	_____ 85 _____ 50 _____ 15
AASHTO Gradation: Size: _____ Percent _____	Fabric: AOS* < _____ Perm. > _____	AVERAGE OPENING SIZE
_____ m _____ Finer		
<u>0.695</u> 100		
<u>0.548</u> 50		
<u>0.289</u> 5-10		

1 Water Surface Elevation	5 Bank Angle	9 Stability Factor	13 Correction D ₅₀ = 8+11+12
2 Main Channel Flow Area	6 Riprap Angle of Repose (Chart 4)	10 Riprap Specific Gravity	14 Notes or Comments
3 Main Channel Average Velocity	7 Bank Angle Correction (Chart 3)	11 Riprap Size Correction factor (Chart 2)	
4 Main Channel Average Depth	8 Riprap Size (Chart 1)	12 Pier/Abutment Correction (3.38 if applicable)	

Figure 37. Riprap Size Form (Form 1); Example 2

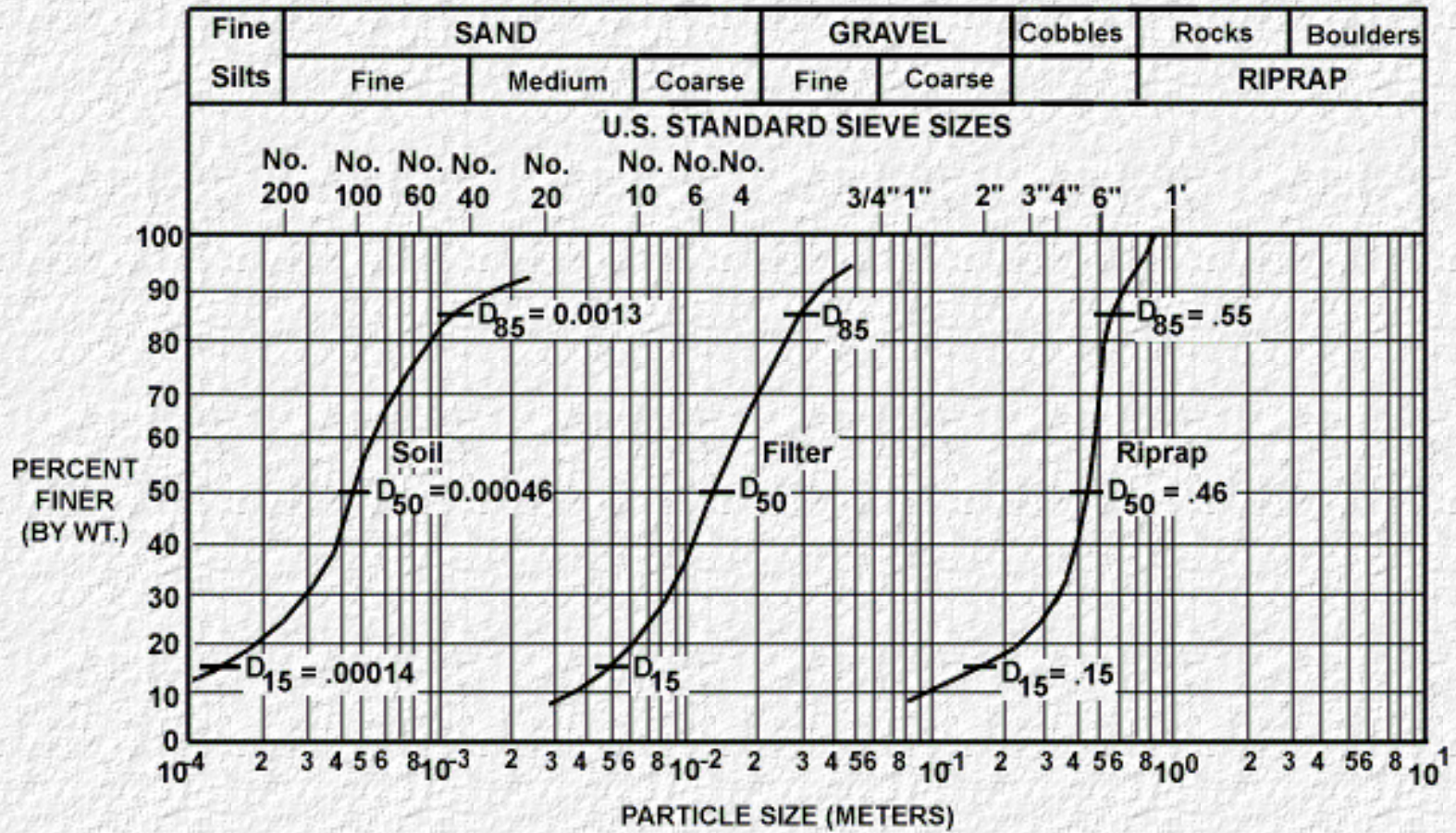

Figure 38. Material Gradation ([Form 3](#)); Example 2

[Go to Chapter 6](#)



Chapter 6 : HEC 11

Guidelines for Other Revetments

[Go to Appendix A](#)

This chapter contains design and construction guidelines for wire-enclosed rock, preformed block, grouted rock, and concrete pavement revetments. Sample specifications for each type of revetment can be found in [Appendix A](#).

[Figure 39](#) shows a revetment schematic illustrating the three typical design sections for bank and channel revetments. Section A-A is a mid-section profile characteristic of a typical design section as well as documenting the revetment toe and top details. Sections B-B and C-C are flank sections documenting the upstream and downstream edge details respectively. These three section references are used to provide design details for each of the revetments described below.

6.1 Wire-Enclosed Rock

As described in [Section 2.2](#), wire-enclosed rock (gabion) revetments consist of rectangular wire mesh baskets filled with rock. The most common types of wire-enclosed revetments are mattresses and stacked blocks. The wire cages which make up the mattresses and gabions are available from commercial manufacturers (see [Appendix B](#)). If desired, the wire baskets can also be fabricated from available wire fencing materials.

See [Section 2.2](#), for general performance characteristics of wire-enclosed rock revetments.

6.1.1 Mattresses

Rock and wire mattress revetments consist of flat wire baskets or units filled with rock that are laid end to end and side to side on a prepared channel bed and/or bank. The individual mattress units are wired together to form a continuous revetment mattress.

6.1.1.1 Design Guidelines for Rock and Wire Mattresses

Components of a rock and wire mattress design include layout of a [general](#) scheme or concept, [bank and foundation preparation](#), [mattress size and configuration](#), [stone size](#), [stone quality](#), [basket or rock enclosure fabrication](#), [edge treatment](#), [filter design](#). Design guidance is provided below in each of these areas.

General: Rock and wire mattress revetments can be constructed from commercially available wire units as illustrated in the details of [Figure 40](#) and [Figure 41](#), or from available wire fencing material as illustrated in [Figure 42](#). The use of commercially available basket units is the most common practice, and is also usually the least expensive approach.

Rock and wire mattress revetments can be used to protect either the channel bank (as illustrated in the sections of [Figure 40](#)) or the entire channel perimeter ([Figure 41](#)). When used for bank protection, rock and wire mattress revetments consist of two distinct sections: a toe section and upper bank paving (see [Figure 40](#)). As illustrated in [Figure 40](#), a variety of toe

designs can be used. These designs are detailed later.

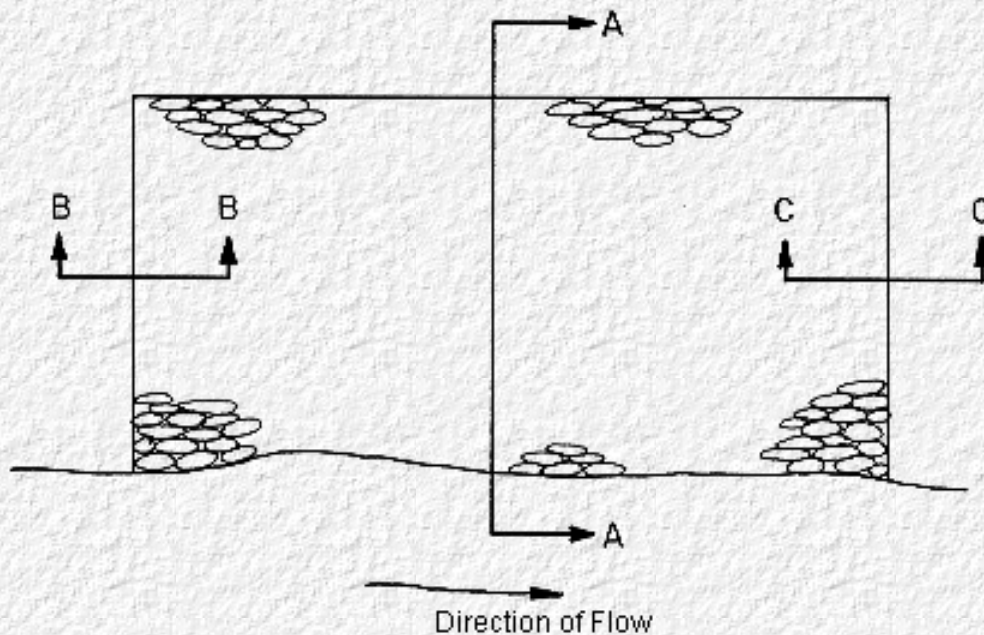

Figure 39. Revetment Schematic

The vertical and longitudinal extent of the mattress should be set based on guidelines provided in [Section 3.6](#). Emphasis in design should be placed on toe design, and filter design.

Bank and Foundation Preparation: Channel banks should be graded to a uniform slope. The graded surface, either on the slope or on the stream bed at the toe of slope on which the rock and wire mattress is to be constructed, should not deviate from the specified slope line by more than 150 mm.

All blunt or sharp objects (such as rocks or tree roots) protruding from the graded surface should be removed.

Large boulders near the outer edge of the toe and apron area should be removed.

Mattress Unit Size and Configuration: Individual mattress units should be a size that is easily handled on site. Commercially available gabion units come in standard sizes as indicated in [Table 4](#). Manufacturer's literature indicates that alternative sizes can be manufactured when required, provided that the quantities involved are of a reasonable magnitude.

The mattress should be divided into compartments so that failure of one section of the mattress will not cause loss of the entire mattress. Compartmentalization also adds to the structural integrity of individual gabion units. It is recommended that diaphragms be installed at a nominal 0.91 m spacing within each of the gabion units to provide the recommended compartmentalization (see [Figure 43](#)).

On steep slopes (greater than 3H:1V), and in environments subject to high stresses (in areas prone to high flow velocities, debris flows, ice flows, etc.), diaphragms should be spaced at minimum intervals of 0.61 m to prevent movement of the stone inside the basket (as described in [Chapter 2](#)).

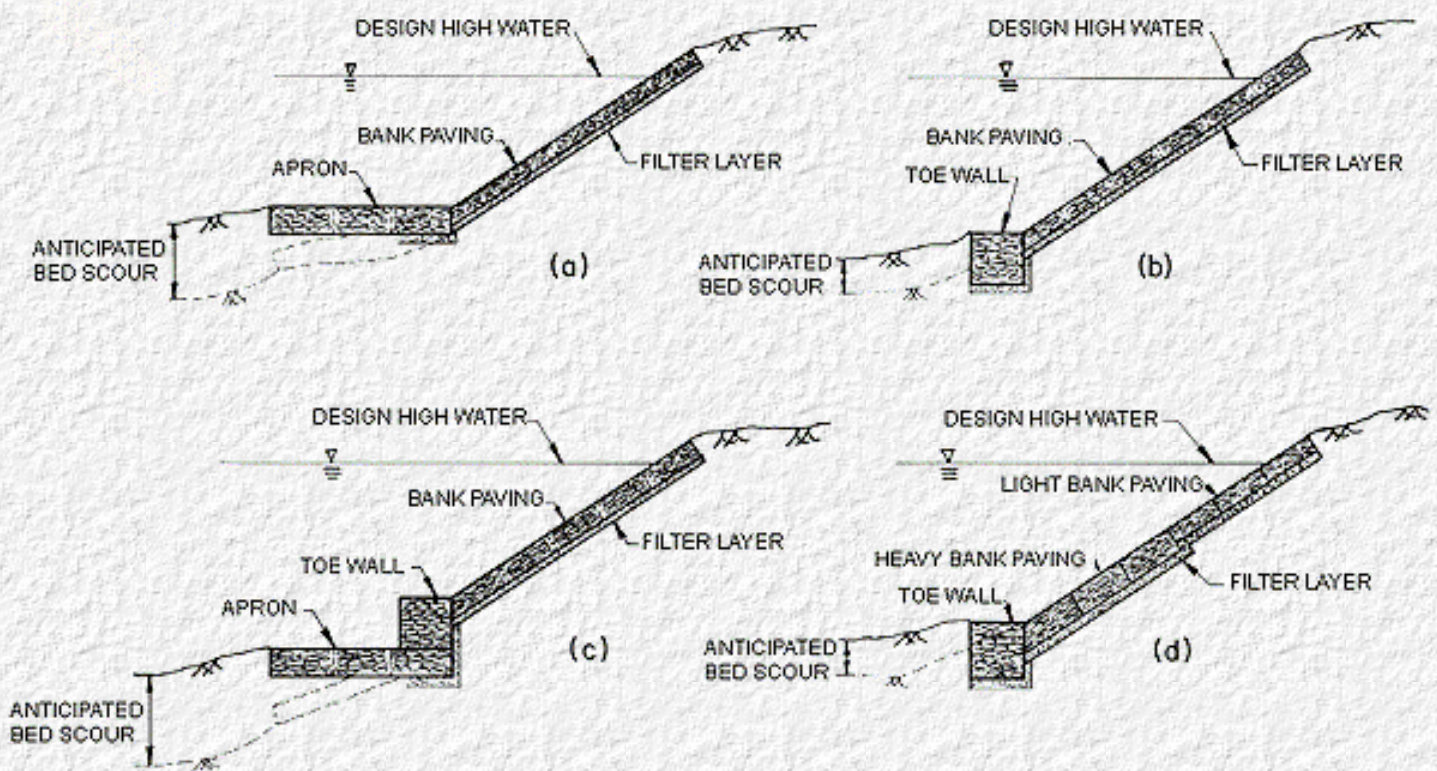

Figure 40. Rock and Wire Mattress Configurations: (a) Mattress with Toe Apron; (b) Mattress with Toe Wall; (c) Mattress with Toe Wall; and (d) Mattress of Variable Thickness (see section A-A of [Figure 39](#) for reference)

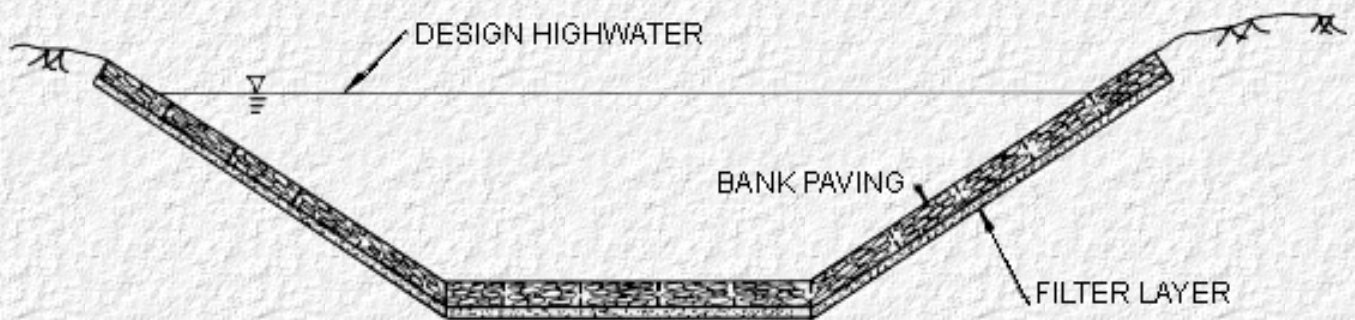

Figure 41. Rock and Wire Mattress Installation Covering the Entire Channel Perimeter (see section A-A of [Figure 39](#) for reference)

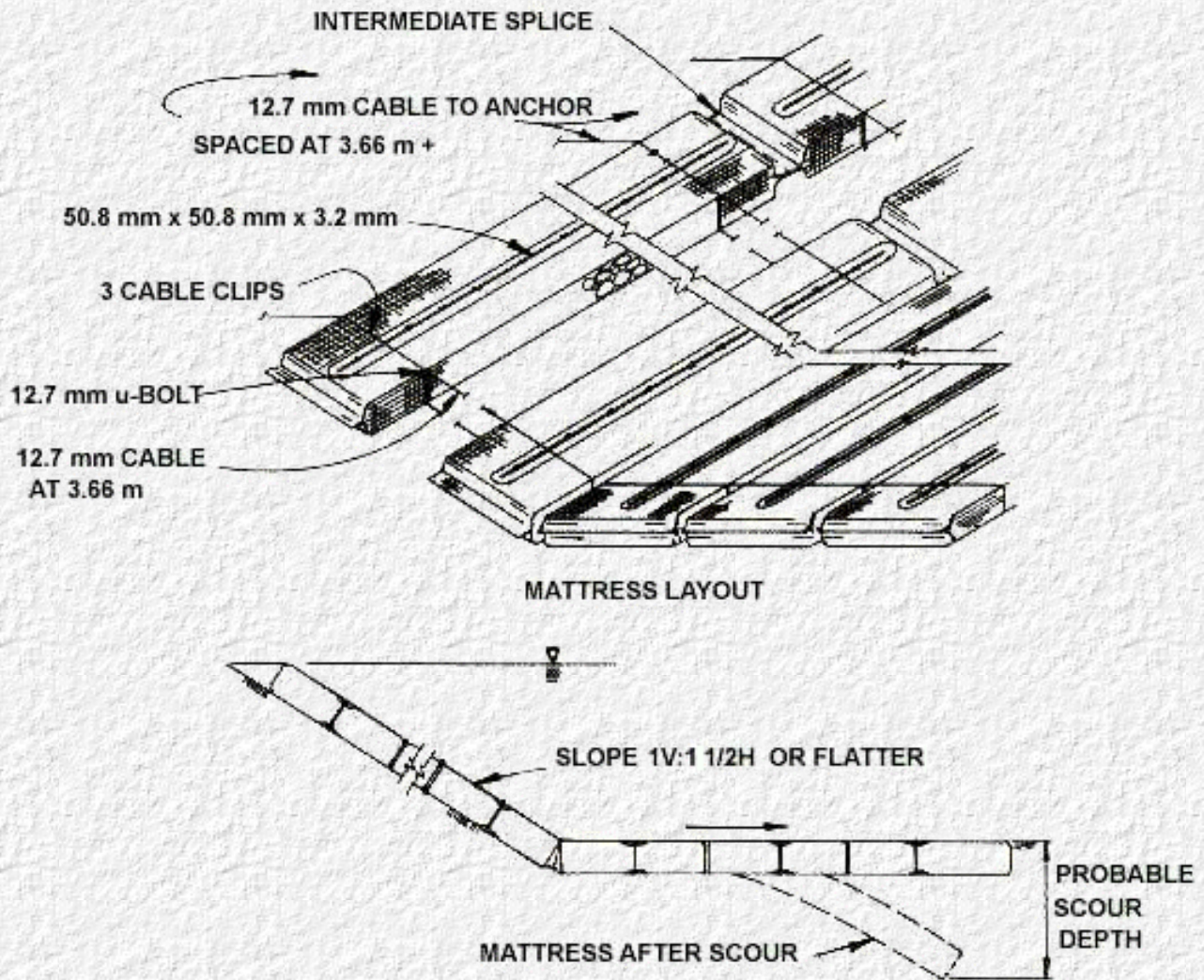

Figure 42. Typical Detail of Rock and Wire Mattress Constructed from Available Wire Fencing Materials (see section A-A of [Figure 39](#) for reference)

Table 4. Standard Gabion Sizes

Thickness (m)	Width (m)	Length (m)	Wire-Mesh Opening Size (mm x mm)
0.229	1.829	2.743	63.5 x 82.55
0.229	1.829	3.658	63.5 x 82.55
0.305	0.914	1.829	82.55 x 114.3
0.305	0.914	2.743	82.55 x 114.3
0.305	0.914	3.658	82.55 x 114.3
0.457	0.914	1.829	82.55 x 114.3
0.457	0.914	2.743	82.55 x 114.3
0.457	0.914	3.658	82.55 x 114.3
0.914	0.914	1.829	82.55 x 114.3
0.914	0.914	2.743	82.55 x 114.3
0.914	0.914	3.658	82.55 x 114.3

The thickness of the mattress is determined by three factors:

1. The erodibility of the bank soil
2. The maximum velocity of the water, and
3. The bank slope.

The minimum thickness required for various conditions is tabulated in [Table 5](#). These values are based on observations of a large number of mattress installations which assume a filling material in the size range of 76 to 152 mm.

The mattress thickness should be at least as thick as two overlapping layers of stone.

The thickness of mattresses used as bank toe aprons should always exceed 300 mm. The typical range is 300 to 510 mm. The thickness of mattress revetments can vary according to need by utilizing gabions of different depths as illustrated in [Figure 40d](#).

Stone Size: The maximum size of stone should not exceed the thickness of individual mattress units. The stone should be well graded within the sizes available, and 70 percent of the stone, by weight, should be slightly larger than the wire-mesh opening. For commercially available units, the wire-mesh opening sizes are listed in [Table 4](#).

Common median stone sizes used in mattress designs range from 76 to 152 mm for mattresses less than 0.31 m thick. For mattresses of larger thickness, rock having a median size up to 0.31 m is used.

Stone Quality: The stone should meet the quality requirements as specified for dumped-rock riprap given in [Chapter 4](#).

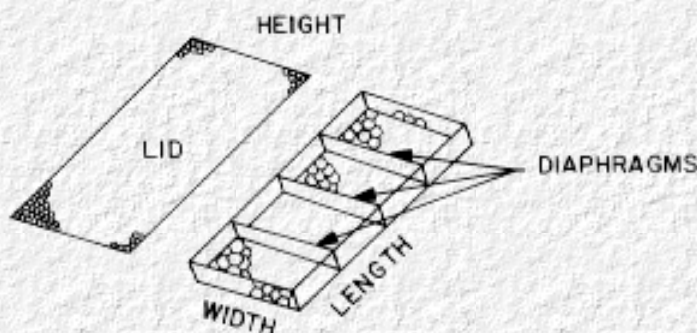

Figure 43. Mattress Configuration

Table 5. Criteria for Gabion Thickness

Bank Soil Type	Maximum Velocity (m/sec)	Bank Slope	Min. Required Mattress Thickness (mm)
Clays, heavy cohesive soils	3.048	< 3V:1H	228.6
	3.962-4.877	< 2V:1H	304.8
	any	< 2V:1H	> 457.2
Silts, fine sands	3.048	< 2V:1H	304.8

Shingle with gravel	4.877	< 3V:1H	228.6
	6.096	< 2V:1H	304.8
	any	< 2V:1H	> 457.2

Basket Fabrication: Commercially fabricated basket units are formed from galvanized steel wire mesh of triple twist hexagonal weave. The netting wire and binding wire is approximately No. 13-1/2 gage. The wire for edges and corners is approximately No. 12 gage. Manufacturer's instructions for field assembly of basket units should be followed.

Wire mattress units may also be fabricated from available fencing materials. The wire enclosure should be formed from galvanized woven-wire fencing of No. 9 or No. 12 gage galvanized wire. Ties and lacing wire should be No. 9 gage galvanized wire.

All wire used in the construction of the mesh rock enclosures (including tie wire) shall be zinc coated (galvanized) to ASTM A641-71A (1980); the minimum weight of the zinc coating shall be as follows:

<u>Nominal Diameter of Wire</u>	<u>Minimum Coating Weight</u>
2.2 mm	214 g/m ²
2.7 mm	244 g/m ²
3.4 mm	244 g/m ²

The adhesive of the zinc coating to the wire should be such that, when the wire is wrapped six turns around a mandrel measuring 4 times the diameter of the wire, it does not flake or crack to such an extent that any zinc can be removed by rubbing with bare fingers.

Galvanized wire baskets may be safely used in fresh water and in areas where the pH of the liquid in contact with it is not greater than 10. For highly corrosive conditions such as in salt water environments, industrial areas, polluted streams, and in soils such as muck, peat, and cinders, a polyvinyl chloride (PVC) coating must be used over the galvanizing. The PVC coating must have a nominal thickness of 0.55 mm and shall nowhere be less than 0.38 mm. It shall be capable of resisting deleterious effects of natural weather exposure and immersion in salt water, and shall not show any material difference in its initial characteristics with time.

Edge Treatment: The edges of rock and wire mattress revetment installations (the toe, head, and flanks) require special treatment to prevent damage from undermining. Of primary concern is toe treatment. [Figure 40](#) illustrates several possible toe configurations. [Figure 40a](#) illustrates a toe apron, [Figure 40b](#) illustrates a toe wall, and [Figure 40c](#) illustrates the use of a toe wall in combination with an apron. If a toe apron is used, its projection should be 1.5 times the expected maximum depth of scour in the vicinity of the revetment toe (see [Section 3.6.2](#)). In areas where little toe scour is expected, the apron can be replaced by a single-course gabion toe wall (see [Figure 40b](#)), which helps to support the revetment and prevent undermining. In cases where an excessive amount of toe scour is anticipated, both an apron and a toe wall can be used as illustrated in [Figure 40c](#).

To provide extra strength at the revetment flanks, it is recommended that mattress units having additional thickness be used at the upstream and downstream edges of the revetment (see [Figure 44](#)). It is further recommended that a thin layer of topsoil be spread over the flank units to form a soil layer to be seeded when the revetment installation is complete.

The head of rock and wire mattress revetments can usually be terminated at grade as illustrated in [Figure 40](#).

Filter Design: Individual mattress units will act as a crude filter as well as a pavement unit

when filled with overlapping layers of hand-size stones. However, it is recommended that the need for a filter be investigated, and if necessary, a layer of permeable membrane cloth (geotextile) woven from synthetic fibers, or a 102-mm to 152-mm layer of gravel be placed between the silty bank and the rock and wire mattress revetment to further inhibit washout of fines. For further discussion on filter materials, see [Chapter 4](#).

6.1.1.2 Construction

Construction details for rock and wire mattresses vary with the design and purpose for which the protection is provided. Typical details are illustrated in [Figure 40](#) , [Figure 41](#) , [Figure 42](#) , [Figure 43](#) , and [Figure 44](#). Rock and wire mattress revetments may be fabricated where they are to be placed, or at an off-site location. Fabrication at an off-site location requires that the individual mattress units be transported to the site; in this case extreme care must be taken so that moving and placing the baskets does not damage them by breaking or loosening strands of wire or ties, or by removing any of the galvanizing or PVC coating. Because of the potential for damage to the wire enclosures, off-site fabrication is not recommended.

On-site fabrication of rock and wire mattress revetments is the most common practice. As mentioned above, wire enclosures for mattress revetments can be purchased from commercial vendors (see [Appendix B](#)), or can be fabricated from galvanized woven fencing components. The economic advantages of commercial wire enclosure units (baskets) have almost eliminated on-site fabrication using wire fencing components except in special design situations. [Figure 42](#) illustrates details for a rock and wire mattress constructed from galvanized fencing components. [Figure 40](#) and [Figure 42](#) illustrate installations on a channel bank. [Figure 41](#) illustrates a similar installation where the entire channel perimeter is lined.

Installation of mattress units above the water line is usually accomplished by placing individual units on the prepared bank, lacing them together, filling them with appropriately sized rock, and then lacing the tops to the individual units. A typical installation is illustrated in [Figure 45](#). Where the mattress units must be placed below the water line in relatively shallow water, mattress units can be assembled at a convenient location and then be placed on the bank using a crane as illustrated in [Figure 46](#). For deep water installations, an efficient method of large-scale placement is to fabricate the mattress sections on a barge or pontoon and then launch them into the water at the shore line (see [Figure 47](#)).

6.1.2 Stacked Block Gabions

Stacked block gabion revetments consist of rectangular wire baskets which are filled with stone and stacked in a stepped-back fashion to form the revetment surface (see [Figure 48](#)). They are also commonly used at the toe of embankment slopes as toe walls which help to support other upper bank revetments and prevent undermining ([Figure 40](#)).

As illustrated in [Figure 48](#) the rectangular basket or gabion units used for stacked configurations are more equidimensional than those typically used for mattress designs. That is, they typically have a square cross section. Commercially available gabions used in stacked configurations include those listed in [Table 4](#) having 0.91 m widths and thickness. Other commercially available sizes can also be used in the stacked block configurations.

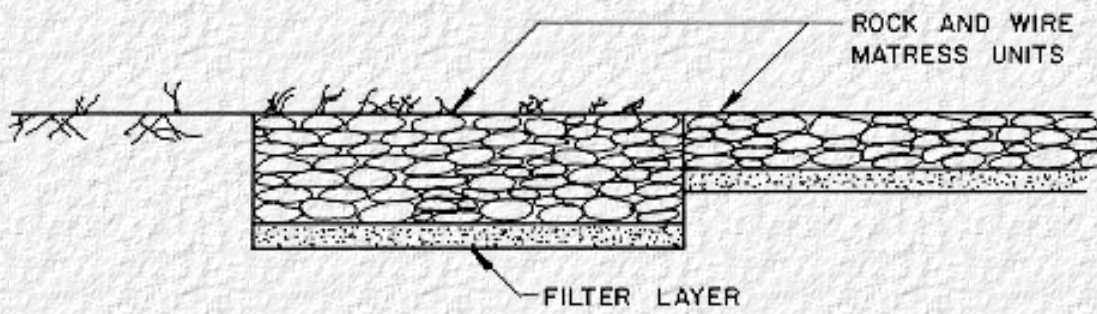

(a)

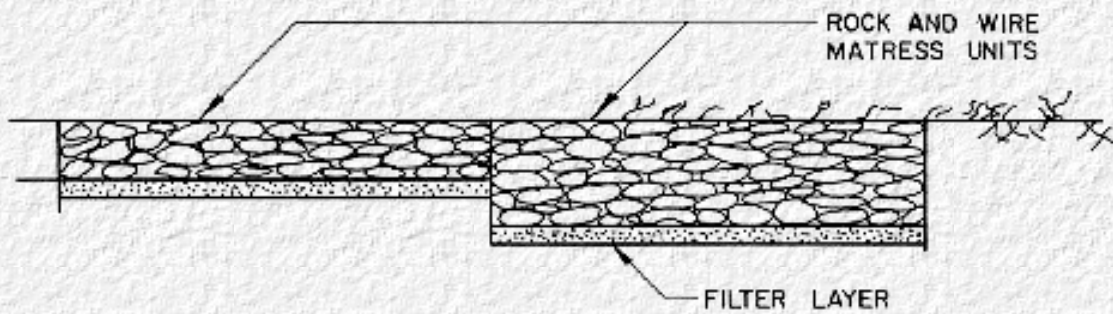

(b)

Figure 44. Flank Treatment for Rock and Wire Mattress Designs: (a) Upstream Face; (b) Downstream Face (see section B-B and C-C of [Figure 39](#) respectively for reference)

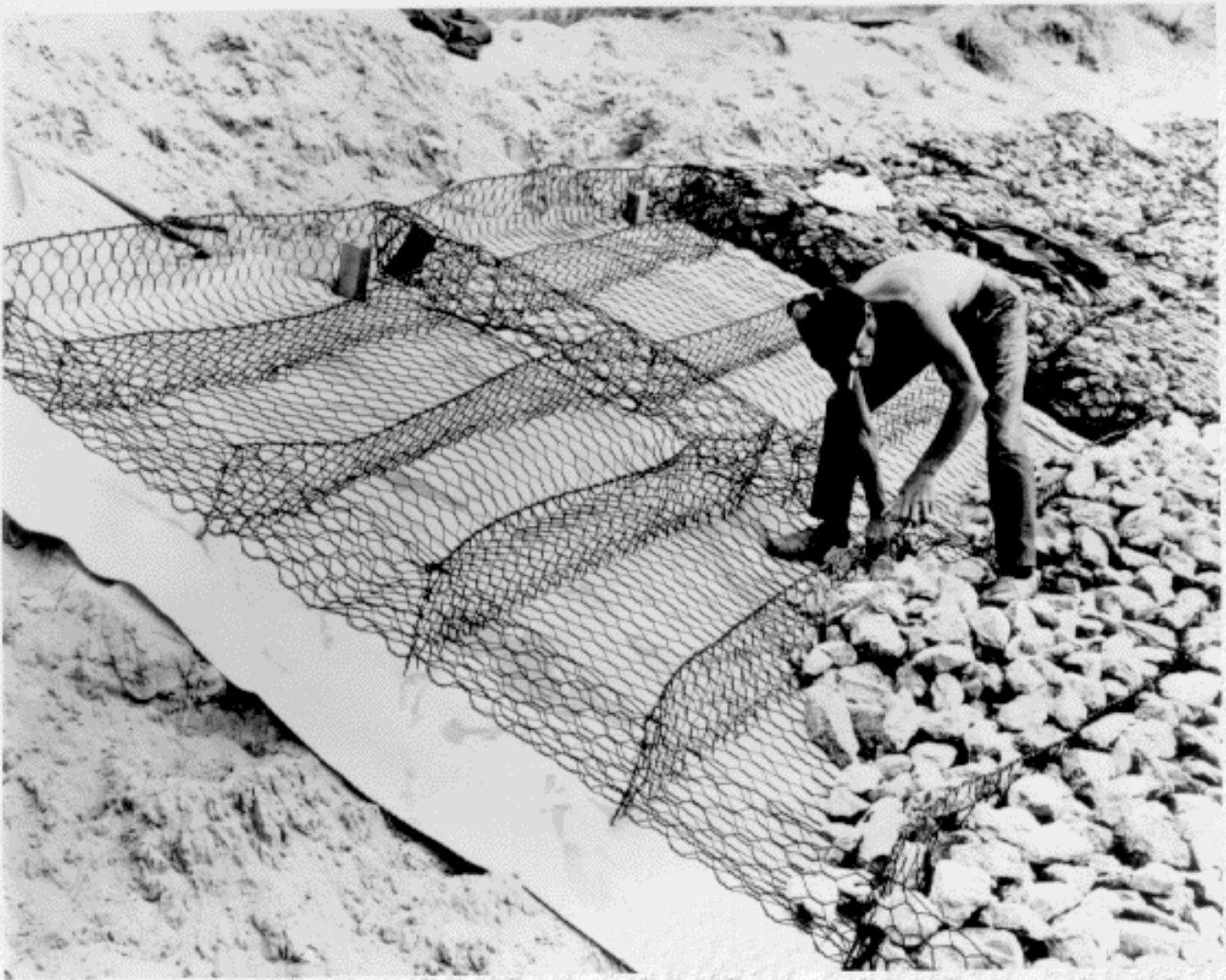

Figure 45. Rock and Wire Revetment Mattress Installation (courtesy, Maccaferri Gabions, Inc.)

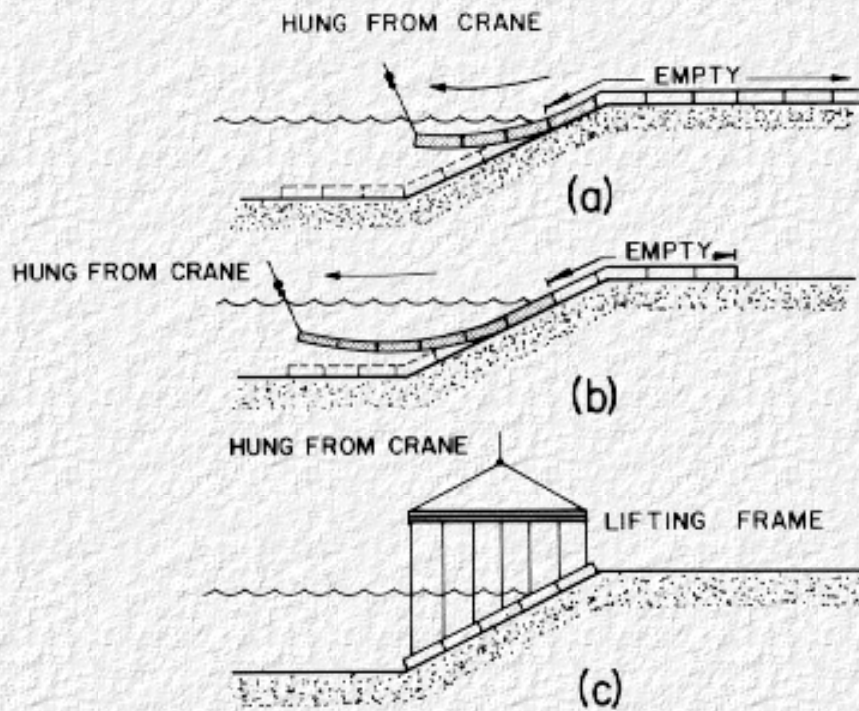

Figure 46. Mattress Placement Underwater by Crane

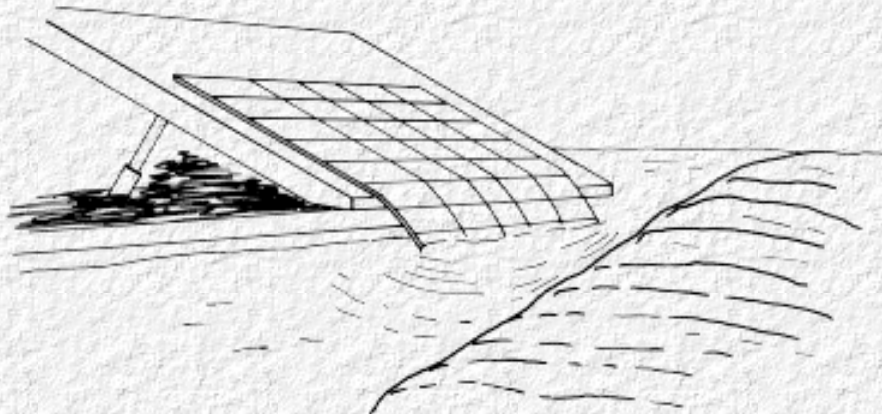

Figure 47. Pontoon Placement of Wire Mattress

Conceptually, the gabion units for stacked block configurations could also be fabricated from available fencing materials. However, the labor intensive nature of such an installation makes it impractical in most cases. Therefore, only commercially available units are considered in the following.

6.1.2.1 Design Guidelines for Stacked Block Gabions

Components of stacked gabion revetment design include layout of a [general](#) scheme or

concept, [unit size and configuration](#), [edge treatment](#), [backfill and filter considerations](#), and [basket or rock enclosure fabrication](#). Design guidelines for stone size and quality, and bank preparation are the same as those discussed for mattress designs. Design guidelines for the remaining areas are discussed below.

General: Stacked gabion revetments are typically used instead of gabion mattress designs when the slope to be protected is greater than 1H:1V or when the purpose of the revetment is for flow training. They can also be used as retaining structures when space limitations prohibit bank grading to a slope suitable for other revetments. Typical design schemes include flow training walls, [Figure 48a](#), and low or high retaining walls, [Figure 48b](#) and [Figure 48c](#) respectively.

Stacked gabion revetments must be based on a firm foundation. The foundation or base elevation of the structure should be well below any anticipated scour depth. Additionally, in alluvial streams where channel bed fluctuations are common, an apron should be used as illustrated in [Figure 48a](#) and [Figure 48b](#). Aprons are also recommended for situations where the estimated scour depth is uncertain.

Size and Configuration: Common commercial sizes for stacked gabions are listed in [Table 4](#). The most common sizes used are those having widths and depths of 0.91 m. Sizes less than 0.31 m thick are not practical for stacked gabion installations.

Typical design configurations include flow training walls and structural retaining walls. The primary function of flow training walls ([Figure 48a](#)) is to establish normal channel boundaries in rivers where erosion has created wide channel, or to realign the river when it is encroaching on an existing or proposed structure. A stepped-back wall is constructed at the desired bank location; counterforts are installed to tie the walls to the channel bank at regular intervals as illustrated. The counterforts are installed to form a structural tie between the training wall and the natural stream bank, and to prevent overflow from scouring a channel behind the wall. Counterforts should be spaced to eliminate the development of eddy or other flow currents between the training wall and the bank which could cause further erosion of the bank. The dead water zones created by the counterforts so spaced will encourage sediment deposition behind the wall which will enhance the stabilizing characteristics of the wall.

Retaining walls can be designed in either a stepped-back configuration as illustrated in [Figure 48b](#) and [Figure 48c](#), or a batter configuration as illustrated in [Figure 48d](#). Structural details and configurations can vary from site to site.

Gabion walls are gravity structures and their design follows standard engineering practice for retaining structures. Design procedures are available in standard soil mechanics texts as well as in gabion manufacturer's literature.

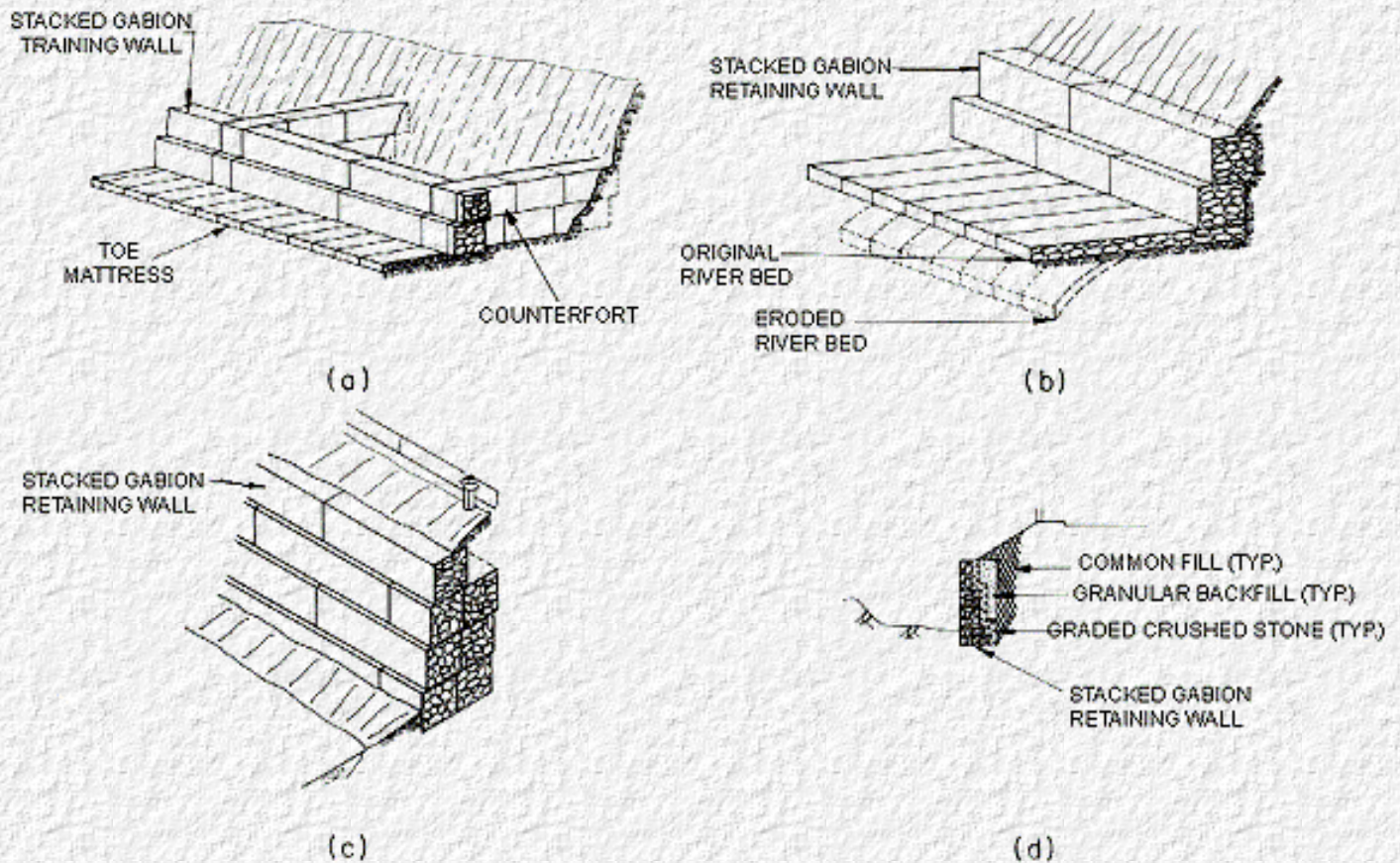

Figure 48. Typical Stacked Block Gabion Revetment Details: (a) Training Wall with Counterforts; (b) Stepped Back Low Retaining Wall with Apron; (c) High Retaining Wall, Stepped-Back Configuration; (d) High Retaining Wall, Batter Type

Edge Treatment: The flanks and toe of stacked block gabion revetments require special attention. The upstream and downstream flanks of these revetments should include counterforts, see [Figure 48a](#). The counterforts should be placed 3.7 to 5.5 m from the upstream and downstream limits of the structure, and should extend a minimum of 3.7 m into the bank.

The toe of the revetment should be protected by placing the base of the gabion wall at a depth below anticipated scour depths. In areas where it is difficult to predict the depth of expected scour, or where channel bed fluctuations are common, it is recommended that a mattress apron be used. The minimum apron length should be equal to 1.5 times the anticipated scour depth below the apron. This length can be increased in proportion to the level of uncertainty in predicting the local toe scour depth.

Backfill/Filter Requirements: Standard retaining wall design requires the use of selected backfill behind the retaining structure to provide for drainage of the soil mass behind the wall. The permeable nature of gabion structures permits natural drainage of the supported embankment. However, since material leaching through the gabion wall can become trapped and cause plugging, it is recommended that a granular backfill material be used, see [Figure 48d](#). The backfill should consist of a 51 to 305 mm layer of graded crushed stone backed by a layer of fine granular backfill.

Basket Fabrication: Commercially fabricated basket units are formed from galvanized steel

wire mesh of triple twist hexagonal weave. The netting wire and binding wire specifications are the same discussed for mattress units. Specifications for galvanizing and PVC coatings are also the same for block designs as for mattresses. [Figure 49](#) illustrates typical details of basket fabrication.

6.1.2.2 Construction

Construction details for gabion installations typically vary with the design and purpose for which the protection is being provided. Several typical design schematics were presented in [Figure 48](#) and [Figure 49](#). Design details for a typical stepped-back design and a typical batter design are presented in [Figure 50](#).

As with mattress designs, fabrication and filling of individual basket units can be done at the site, or at an off-site location. The most common practice is to fabricate and fill individual gabions at the design site. The following steps outline the typical sequence used for installing a stacked gabion revetment or wall:

- **Step 1.** Prepare the revetment foundation. This includes excavation for the foundation and revetment wall.
- **Step 2.** Place the filter and gabion mattress (for designs which incorporate this component) on the prepared grade, then sequentially stack the gabion baskets to form the revetment system.
- **Step 3.** Each basket is unfolded and assembled by lacing the edges together and the diaphragms to the sides.
- **Step 4.** Fill the gabions to a depth of 0.31 m with stone from 100 to 300 mm in diameter. Place one connecting wire in each direction and loop it around two meshes of the gabion wall. Repeat this operation until the gabion is filled.
- **Step 5.** Wire adjoining gabions together by their vertical edges; stack empty gabions on the filled gabions and wire them at front and back.
- **Step 6.** After the gabion is filled, fold the top shut and wire it to the ends, sides and diaphragms.
- **Step 7.** Crushed stone and granular backfill should be placed in intervals to help support the wall structure. It is recommended that backfill be placed at three-course intervals.

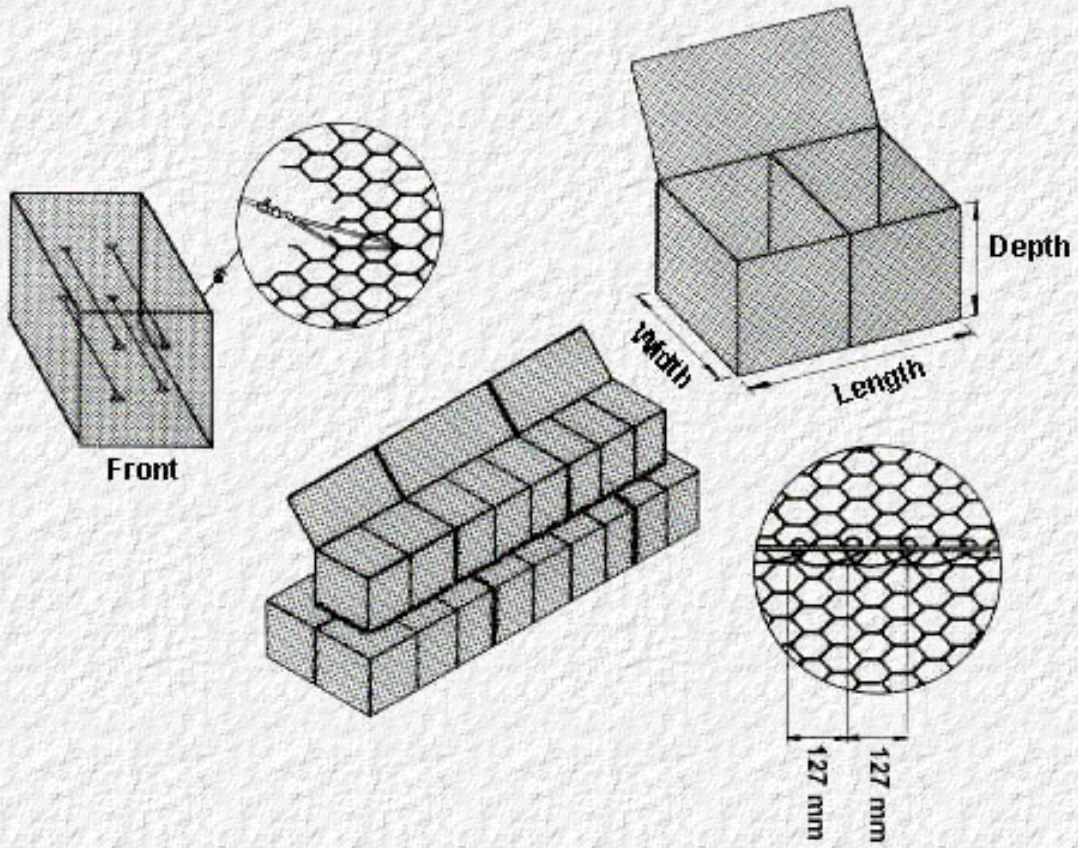

Figure 49. Gabion Basket Fabrication

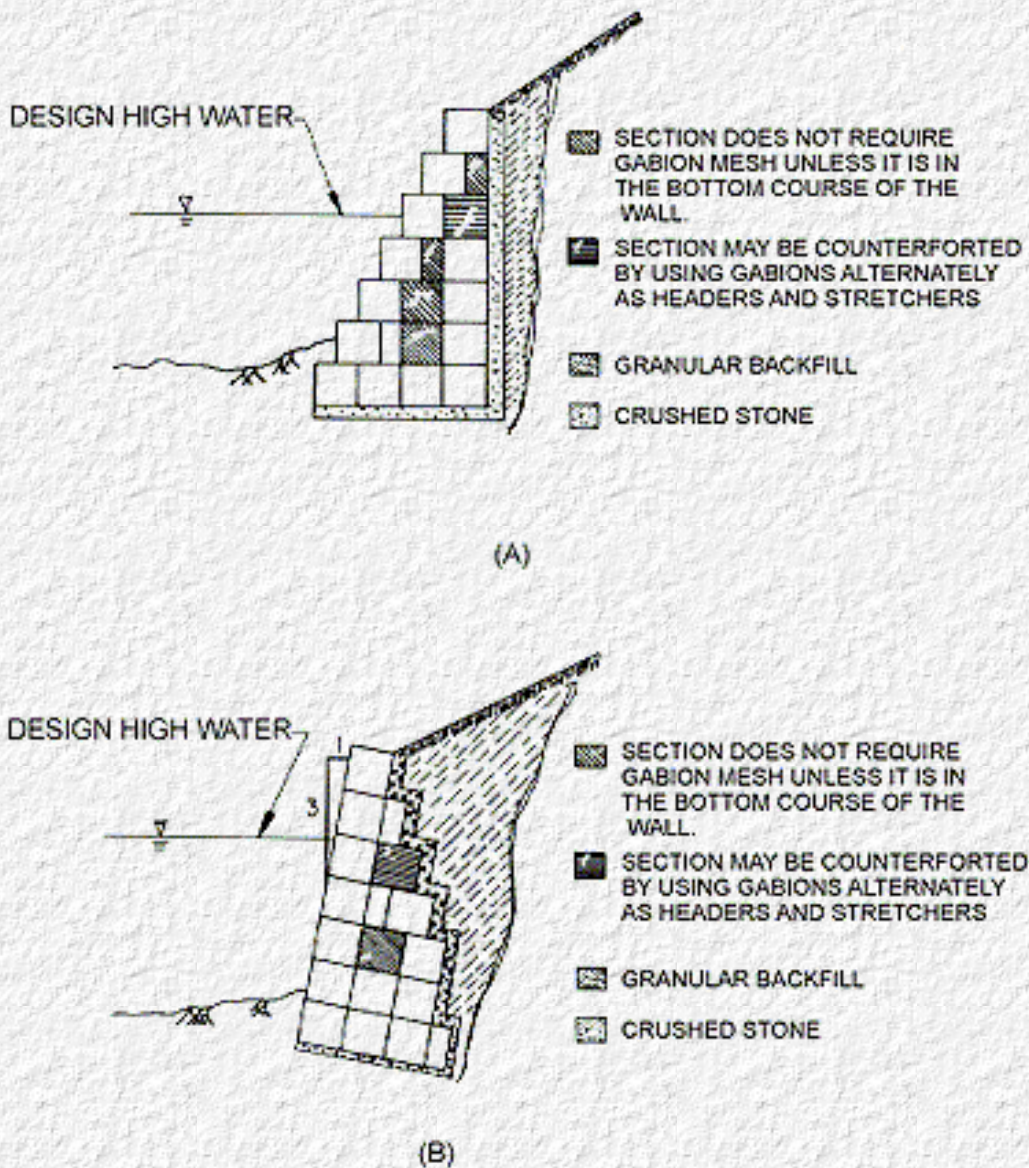

Figure 50. Section Details for (a) Stepped Back and (b) Battered Gabion Retaining Walls (see reference section A-A in [Figure 39](#))

6.2 Pre-Cast Concrete Blocks

Pre-cast concrete block revetments consist of preformed sections which interlock with each other, are attached to each other, or built together to form a continuous blanket or mat. The concrete blocks which make up the mats differ in shape and method of articulation, but share certain common features. These features include flexibility, rapid installation, and provisions for the establishment of vegetation within the revetment. Manufacturers of Pre-cast concrete block revetment units are listed in [Appendix B](#).

Pre-cast concrete block designs come in a number of shapes and configurations. [Figure 51](#), [Figure 52](#), [Figure 53](#), [Figure 54](#), and [Figure 55](#) illustrate several commercially available concrete block designs. Note: other manufacturers and designs are available.

Pre-cast block revetments are bound using a variety of techniques. In some cases the individual blocks

are bound to rectangular sheets of filter fabric (referred to as fabric carrier). Other manufacturers use a design which permits interlocking of individual blocks. Other units are simply butted together at the site. The most common method is to join individual blocks with wire cable or synthetic fiber rope.

See [Section 2.4](#) for a discussion of general performance characteristics of pre-cast concrete blocks.

6.2.1 Design Guidelines for Pre-Cast Concrete Blocks

Components of a pre-cast concrete block revetment design include layout of a [general](#) scheme or concept, [bank preparation](#), [mattress and block size](#), [slope](#), [edge treatment](#), [filter design](#), and [surface treatment](#). Design information is provided below in each of these areas.

General: As illustrated in [Figure 51](#), [Figure 52](#), [Figure 53](#), [Figure 54](#), and [Figure 55](#), pre-cast block revetments are placed on the channel bank as continuous mattresses. The vertical and longitudinal extent of the mattress should be set based on information provided in [Section 3.6](#). Emphasis in design should be placed on toe design, edge treatment, and filter design.

Bank Preparation: Channel banks should be graded to a uniform slope. Any large boulders, roots, and debris should be removed from the bank prior to final grading. Also, holes, soft areas, and large cavities should be filled. The graded surface, either on the slope or on the stream bed at the toe of the slope on which the revetment is to be constructed, should be true to line and grade. Light compaction of the bank surface is recommended to provide a solid foundation for the mattress.

Mattress and Block Size: The overall mattress size is dictated by the longitudinal and vertical extent required of the revetment system (see [Section 3.6](#)). Articulated block mattresses are assembled in sections prior to placement on the bank; individual mattress sections should be constructed to a size that is easily handled on site by available construction equipment. The size of individual blocks is quite variable from manufacturer to manufacturer. In addition, individual manufacturers usually have several standard sizes of a particular block available. Manufacturer's literature should be consulted when selecting an appropriate block size for a given hydraulic condition.

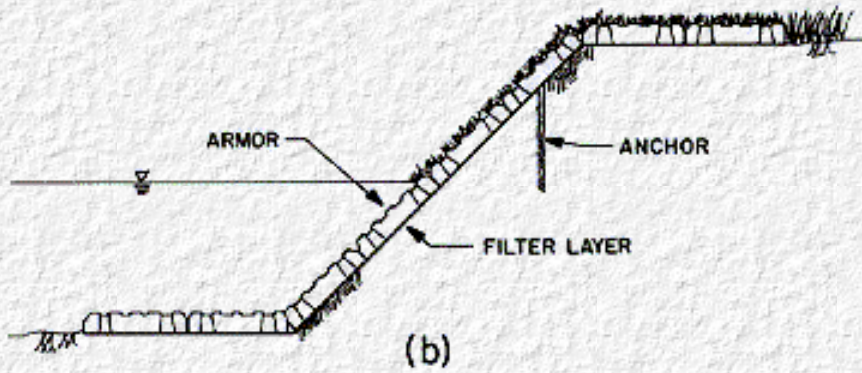
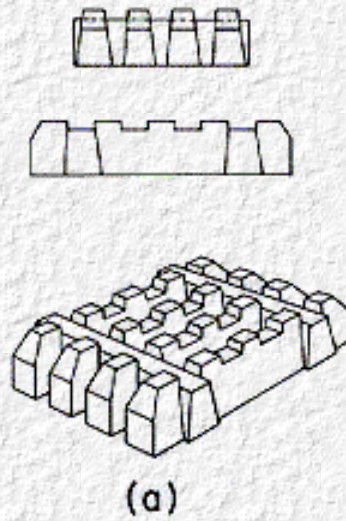

Figure 51. Monoslab Revetment (a) Block Detail and (b) Revetment Detail

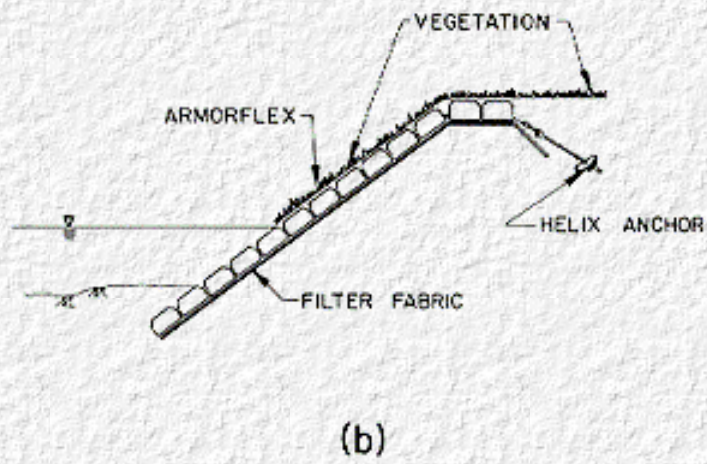
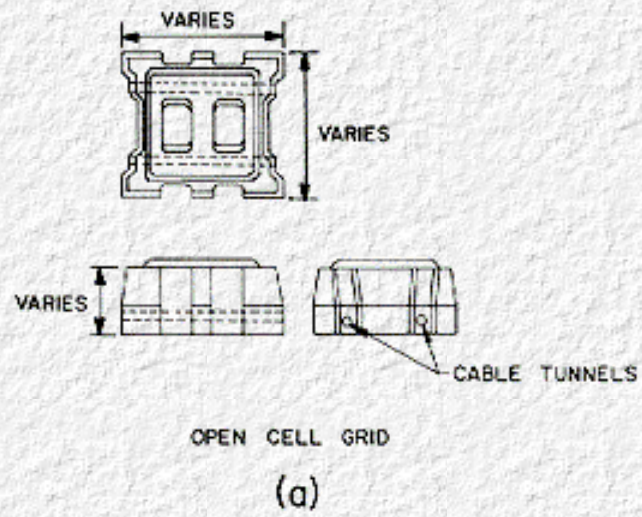
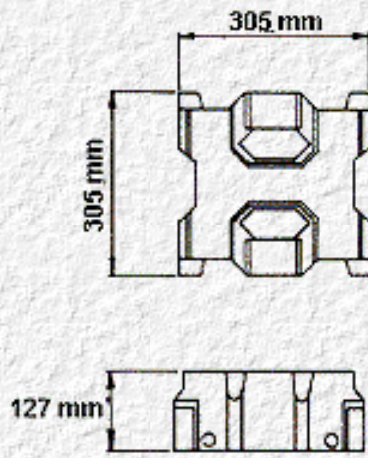
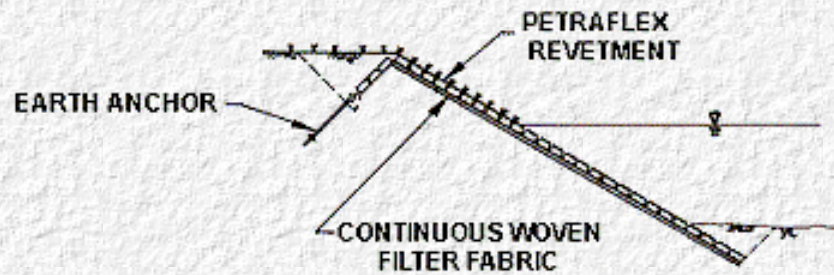

Figure 52. Armorflex (a) Block Detail and (b) Revetment Configuration



(a)



(b)

Figure 53. Petraflex (a) Block Detail and (b) Revetment Configuration (see reference section A-A, [Figure 39](#))

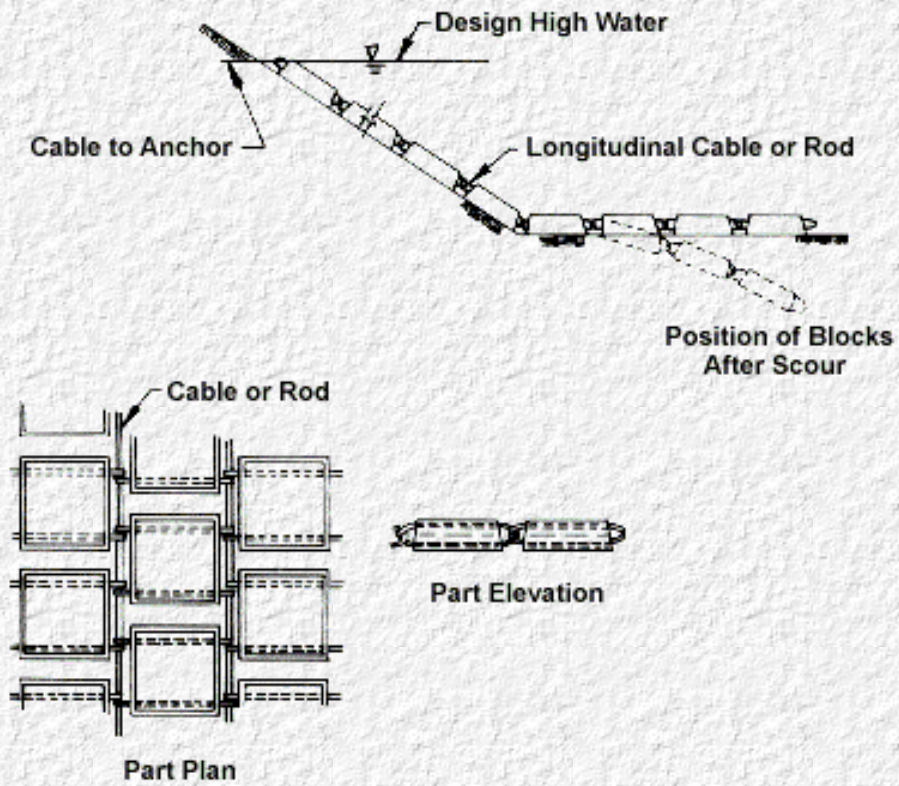

Figure 54. Articulated Concrete Revetment (see reference section A-A, [Figure 39](#))

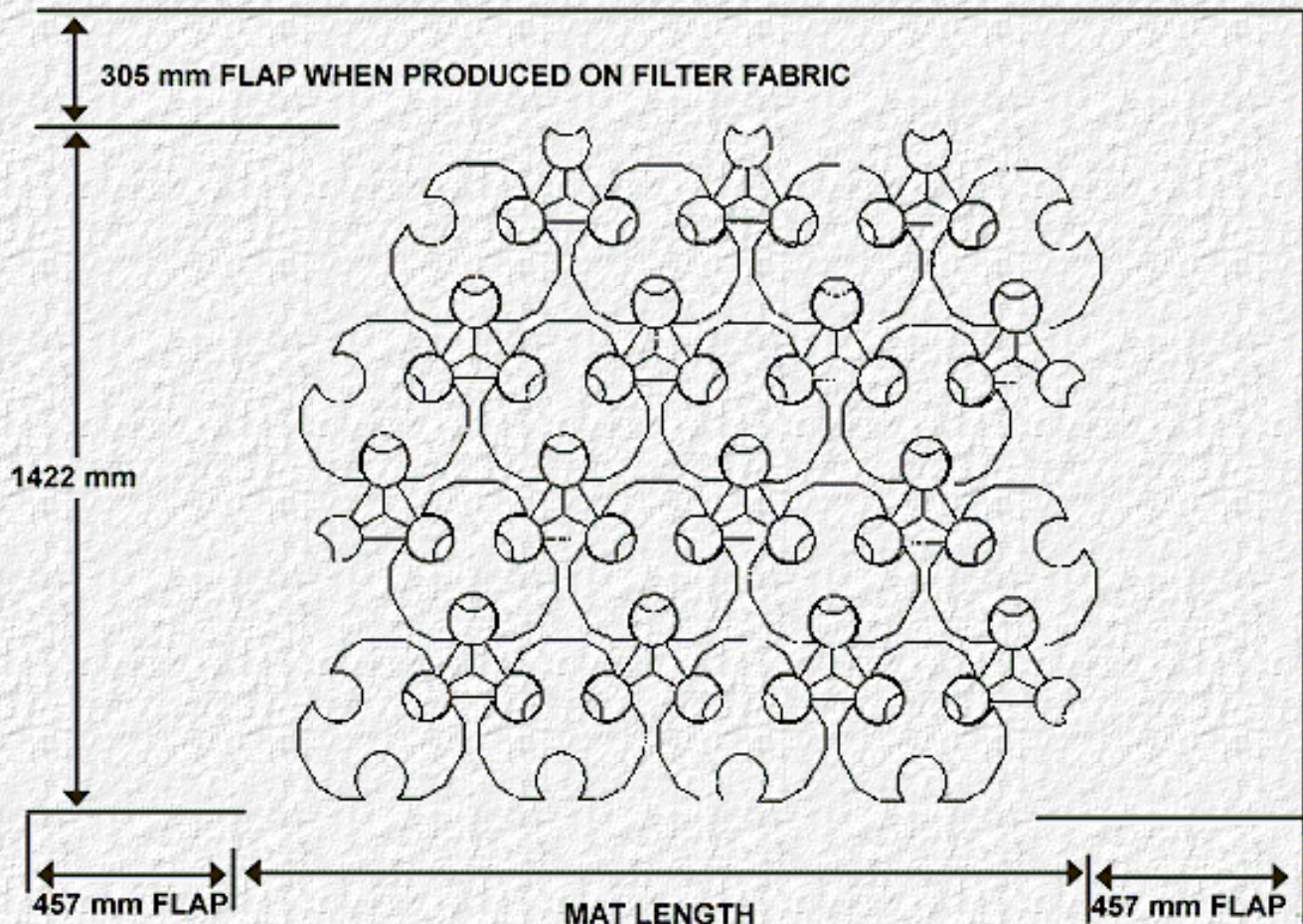

Figure 55. Tri-lock Revetment (see reference section A-A, [Figure 39](#))

Slope: Articulated pre-cast block revetments can be used on bank slopes up to 1V:1.5H. However, an earth anchor should be used at the top of the revetment to secure the system against slippage (see [Figure 52](#) and [Figure 53](#)).

Pre-cast block revetments that are assembled by simply butting individual blocks end to end (with no physical connection) should not be used on slopes greater than 1V:3H.

Edge Treatment: The edges of pre-cast block revetments (the toe, head, and flanks) require special treatment to prevent undermining. Of primary concern in the design of mattress revetments is the toe treatment. Two toe treatments have been used: an apron design as illustrated in [Figure 51](#) and [Figure 54](#), and a toe trench design as illustrated in [Figure 52](#) and [Figure 53](#). As a minimum, toe aprons should extend 1.5 times the anticipated scour depth in the vicinity of the bank toe (see [Section 3.6.2](#)). If a toe trench is used, the mattress should extend to a depth greater than the anticipated scour depth in the vicinity of the bank toe.

Two alternatives have also been used for edge treatments at the top and flanks. The edges can be terminated at-grade ([Figure 51](#), [Figure 52](#), and [Figure 54](#)) or in a termination trench. Termination trenches are recommended in environments subject to significant erosion (silty/sandy soils, and high velocities), or where failure of the revetment would result in significant economic loss. Termination trenches provide greater protection against failure from undermining and outflanking than do at-grade terminations. However, in instances where upper bank erosion or lateral outflanking is not expected to be a problem, grade terminations may

provide an economic advantage.

For articulated designs, earth anchors should be placed at regular intervals along the top of the revetment (see [Figure 52](#) to [Figure 53](#)). Anchors are spaced based on soil type, mat size, and the size of the anchors. See manufacturer's literature for recommended spacings.

Filter: Prior to installing the mats, a geotextile filter fabric should be installed on the bank to prevent bank material from leaching through the openings in the mattress structure. Although a fabric filter is recommended, graded filter material can be used if it is properly designed and installed to prevent movement of the graded material through the protective mattress. Information on filter design is presented in [Chapter 4](#).

Surface Treatment: The spaces between and within individual blocks located above the low water line should be filled with earth and seeded so that natural vegetation can be established on the bank (see [Figure 52](#) and [Figure 53](#)). This treatment enhances both the structural stability of the embankment and its aesthetic qualities.

6.2.2 Construction

Schematics of the types of pre-cast block revetments discussed above are provided in [Figure 51](#), [Figure 52](#), [Figure 53](#), [Figure 54](#), and [Figure 55](#). More detailed design sketches and information are available from individual manufacturers. Manufacturers also have available information on construction procedures. Some manufacturers will provide on-site advice and assistance in the installation of their systems.

Articulated preformed block revetments can be installed by construction crews using conventional construction equipment wherever a dragline or crane can be maneuvered. Construction procedures for most preformed block revetments are similar. After all site preparation work is completed, construction follows the following sequence:

- **Step 1.** Excavate toe, flank and upper bank protection trenches as required.
- **Step 2.** Place filter fabric and/or graded filter material on the prepared subgrade.
- **Step 3.** Individual mats are then attached to a spreader bar and lifted with a crane or backhoe for placement on the embankment slope. Mats are placed side by side on the bank until the entire prepared surface is covered.
- **Step 4.** Adjacent mats are secured to one another by fastening side connecting cables and end loops, or by pouring side connecting keys.
- **Step 5.** Optional anchors are placed at the top and flanks of the protection as required.
- **Step 6.** Backfill is then spread over the mats (and into the open cells or spaces between cells) and into the anchor trenches. Anchor trenches are then compacted, and the general backfill should be seeded and fertilized according to local seasonal conditions.

Non-articulated block revetments (i.e., where the blocks are butted together instead of being

physically attached) are constructed in a similar fashion, except that the individual blocks must be placed on the bank by hand, one at a time. This results in a much more labor-intensive installation procedure.

6.3 Grouted Rock

Grouted rock revetment consists of rock slope-protection having voids filled with concrete grout to form a monolithic armor. See [Section 2.4](#) for additional descriptive information and general performance characteristics for grouted rock. Sample specifications for components of grouted rock revetments are provided in [Appendix A](#).

6.3.1 Design Guidelines for Grouted Rock

Components of grouted rock riprap design include layout of a [general](#) scheme or concept, [bank preparation](#), [bank slope](#), [rock size and blanket thickness](#), [rock grading](#), [rock quality](#), [grout quality](#), [edge treatment](#), [filter design](#), and [pressure relief](#).

General: Grouted riprap designs are rigid monolithic bank protection schemes. When complete, they form a continuous surface. A typical grouted riprap section is shown in [Figure 56](#).

Grouted riprap should extend from below the anticipated channel bed scour depth to the design high water level plus additional height for freeboard (see [Section 3.6.2](#)). The longitudinal extent of protection should be as described in [Section 3.6.1](#).

During the design phase for a grouted riprap revetment, special attention needs to be paid to edge treatment, foundation design, and mechanisms for hydrostatic pressure relief. Each of these items is discussed below.

Bank and Foundation Preparation: The bank should be prepared by first clearing all trees and debris from the bank, and grading the bank surface to the desired slope. In general, the graded surface should not deviate from the specified slope line by more than 152 mm. However, local depressions larger than this can be accommodated since initial placement of filter material and/or rock for the revetment will fill these depressions.

Since grouted riprap is rigid but not extremely strong, support by the embankment must be maintained. To form a firm foundation, it is recommended that the bank surface be tamped or lightly compacted. Care must be taken during bank compaction to maintain a soil permeability similar to that of the natural, undisturbed bank material. The foundation for the grouted riprap revetment should have a bearing capacity sufficient to support either the dry weight of the revetment alone, or the submerged weight of the revetment plus the weight of the water in the wedge above the revetment for design conditions, whichever is greater.

Any large boulders or debris found buried near the edges of the revetment should be removed.

Bank Slope: Bank slopes for grouted riprap revetments should not exceed 1V:1.5H.

Rock Size and Blanket Thickness: Blanket thickness and rock size requirements for grouted riprap installations are interrelated. [Figure 57](#) illustrates a relationship between the design velocity and the required riprap blanket thickness for grouted riprap designs. The median rock size in the revetment should not exceed 0.67 times the blanket thickness. The largest rock

used in the revetment should not exceed the blanket thickness.

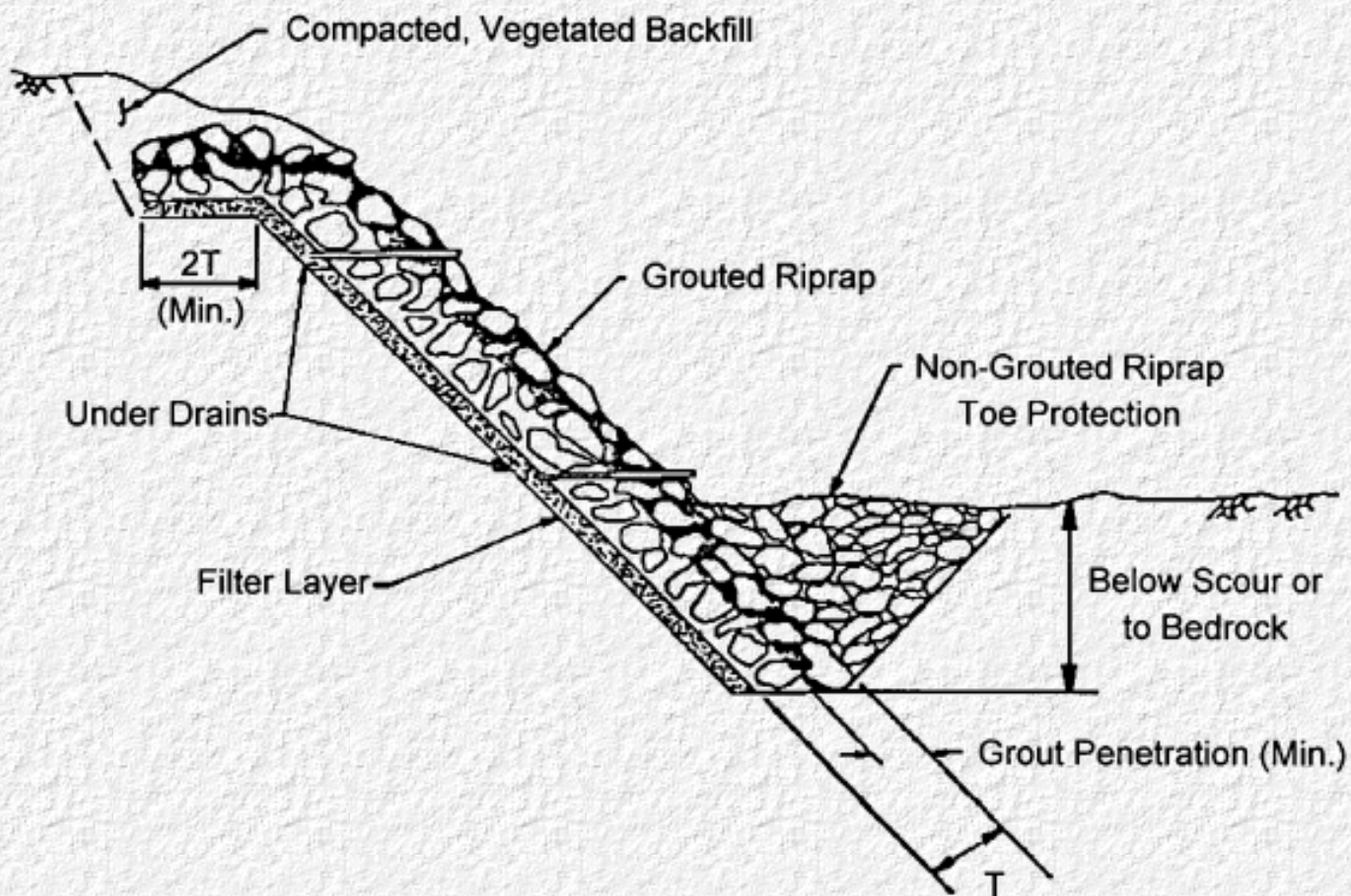

(a)

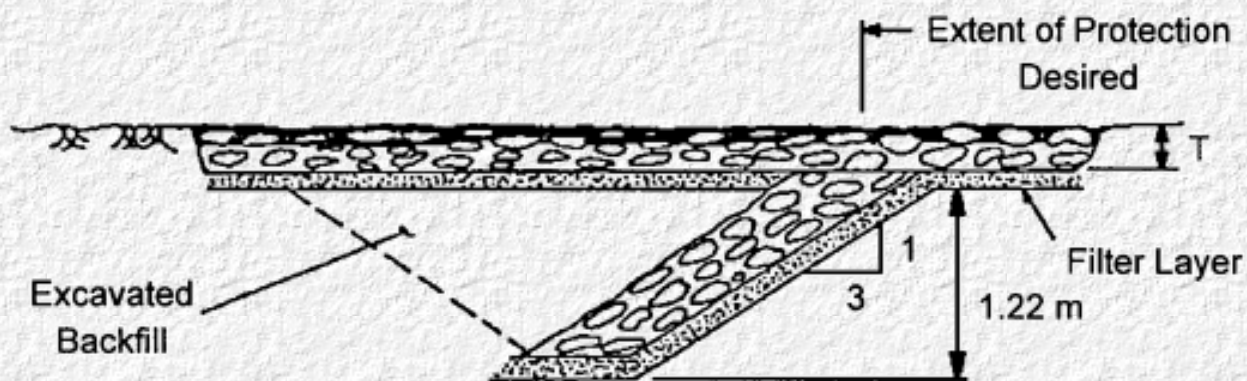

(b)

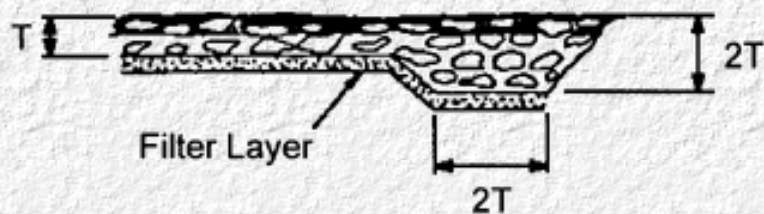

(Min.)

(c)

Figure 56. Grouted Riprap Sections: (a) Section A-A; (b) Section B-B; and (c) Section C-C (refer to [Figure 39](#) for section locations)

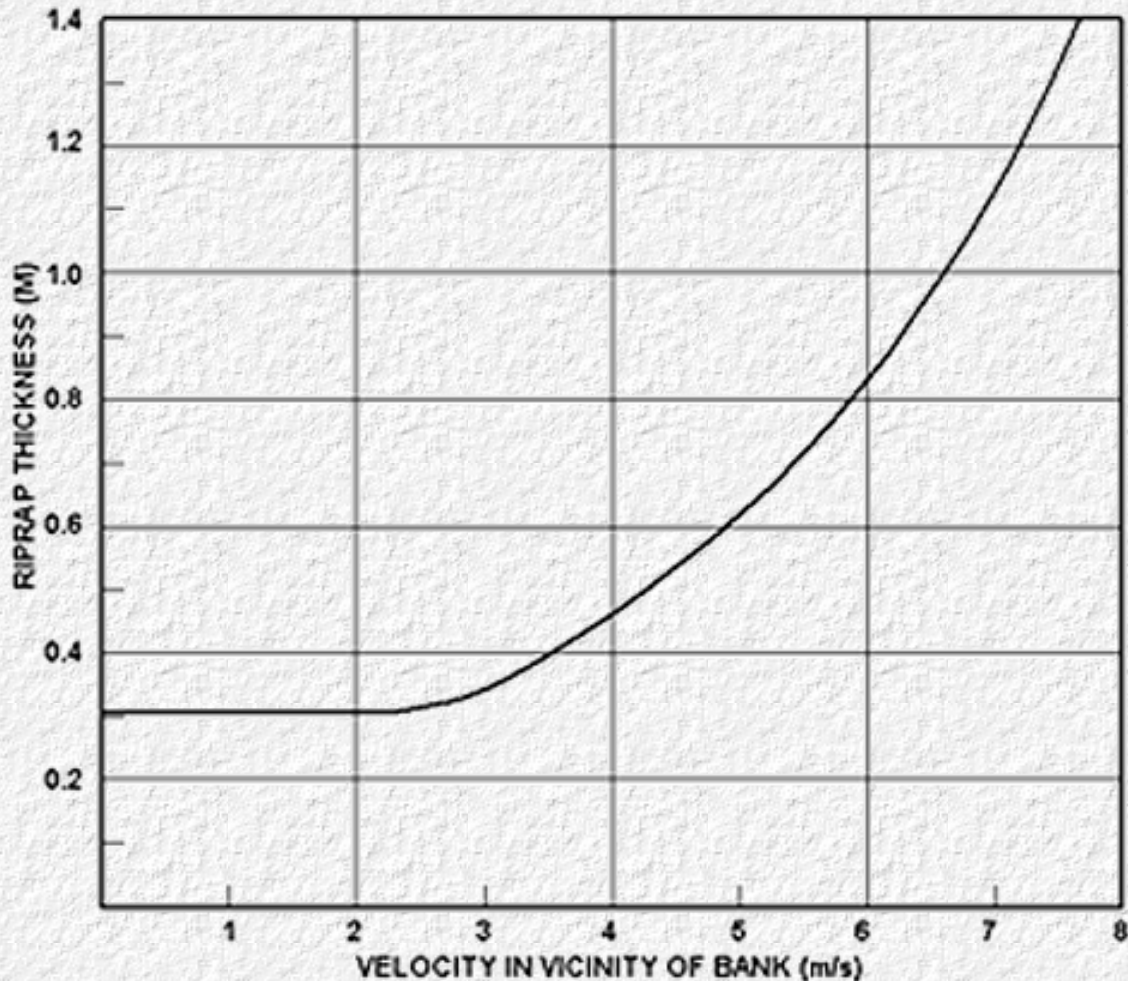

Figure 57. Required Blanket Thickness as a Function of Flow Velocity

Rock Grading: [Table 6](#) provides guidelines for rock gradation in grouted riprap installations. Six size classes are listed.

Rock Quality: Rock used in grouted rock slope-protection is usually the same as that used in ordinary rock slope-protection. However, the specifications for specific gravity and hardness may be lowered if necessary as the rocks are protected by the surrounding grout.

In addition, the rock used in grouted riprap installations should be free of fines in order that penetration of grout may be achieved.

Grout Quality and Characteristics: Grout should consist of good strength concrete using a maximum aggregate size of 19.05 mm and a slump of 76 to 102 mm. Sand mixes may be used where roughness of the grout surface is unnecessary, provided sufficient cement is added to give good strength and workability.

The volume of grout required will be that necessary to provide penetration to the depths shown

in [Table 6](#).

The finished grout should leave face stones exposed for one-fourth to one-third their depth and the surface of the grout should expose a matrix of coarse aggregate.

Edge Treatment: The edges of grouted rock revetments (the head, toe, and flanks) require special treatment to prevent undermining. The revetment toe should extend to a depth below anticipated scour depths or to bedrock. The toe should be designed as illustrated in [Figure 56a](#). After excavating to the desired depth, the riprap slope protection should be extended to the bottom of the trench and grouted. The remainder of the excavated area in the toe trench should be filled with ungrouted riprap. The ungrouted riprap provides extra protection against undermining at the bank toe.

To prevent outflanking of the revetment, various edge treatments are required. Recommended designs for these edge treatments are illustrated in [Figure 56](#), parts (a), (b), and (c).

Filter Design: Filters are required under all grouted riprap revetments to provide a zone of high permeability to carry off seepage water and prevent damage to the overlying structure from uplift pressures. A 154 mm granular filter is required beneath the pavement to provide an adequate drainage zone. The filter can consist of well-graded granular material or uniformly-graded granular material with an underlying filter fabric. The filter should be designed to provide a high degree of permeability while preventing base material particles from penetrating the filter, thus causing clogging and failure of the protective filter layer, [Chapter 4](#) contains more specific information for filter design.

Pressure Relief: Weep holes should be provided in the revetment to relieve hydrostatic pressure build-up behind the grout surface (see [Figure 56a](#)). Weeps should extend through the grout surface to the interface with the gravel underdrain layer. Weeps should consist of 76 mm diameter pipes having a maximum horizontal spacing of 1.8 m and a maximum vertical spacing of 3.0 m. The buried end of the weep should be covered with wire screening or a fabric filter of a gage that will prevent passage of the gravel underlayer.

6.3.2 Construction

Construction details for grouted riprap revetments are illustrated in [Figure 40](#). The following construction procedures should be followed:

- **Step 1.** Normal construction procedures include: bank clearing and grading , development of foundation, placement of the rock slope protection, grouting of the interstices, backfilling toe and flank trenches, vegetation of disturbed areas.
- **Step 2.** The rock should be wet immediately prior to commencing the grouting operation.
- **Step 3.** The grout may be transported to the place of final deposit by chutes, tubes, buckets, pneumatic equipment, or any other mechanical method which will control segregation and uniformity of the grout.
- **Step 4.** Spading and rodding are necessary where penetration is achieved by gravity flow into the interstices.

 **Step 5.** No loads should be allowed upon the revetment until good strength has been developed.

6.4 Concrete Pavement

Concrete pavement revetments are cast in place, or pre-cast and set in place on a prepared slope to provide a continuous, monolithic armor for bank protection. Cast-in-place designs are the most common of the two design methods. For additional descriptive information and general performance characteristics of concrete pavement, see [Section 2.4](#). Sample specifications for components of concrete pavement revetments are provided in [Appendix A](#).

6.4.1 Design Guidelines for Concrete Pavement

Components of concrete pavement revetment design include layout of a [general](#) scheme, [bank and foundation preparation](#), [bank slope](#), [pavement thickness](#), [pavement reinforcement](#), [edge treatment](#), [stub walls](#), [filter design](#), [pressure relief](#), and [concrete quality](#). Each of these components is addressed below.

General: Concrete pavement designs are ridged monolithic bank protection schemes. When complete they form a continuous surface. A design sketch of a typical concrete pavement is illustrated in [Figure 58](#). As illustrated in [Figure 58](#), typical concrete pavement revetment consists of the bank pavement, a toe section, a head section, cutoff or stub walls, weeps, and a filter layer.

Concrete pavements can be designed as light duty or heavy duty. The distinction between light and heavy duty concrete pavement is in the various dimensions labeled in [Table 7](#). [Table 7](#), documents the labeled dimensions for both light and heavy duty concrete pavements.

As indicated in [Figure 58](#), concrete pavements should extend vertically below the anticipated channel bed scour depth, and to a height equal to the design high water level plus additional height for freeboard (see [Section 3.6.2](#)). The longitudinal extent of protection should be as described in [Section 3.6.1](#).

An additional consideration in concrete pavement design is the surface texture. Depending on the smoothness required for hydraulics, a float or sand finish may be specified, or if roughness is desired, plans may call for a deformed surface obtained by grooving the surface after the initial set.

During the design phase for concrete pavement revetment, special attention needs to be paid to toe and edge treatment, foundation design, and mechanisms for hydrostatic pressure relief. Field experience indicates that inadequacies in these areas of design are often responsible for failures of concrete pavement revetments.

Bank and Foundation Preparation: The bank should be prepared by first clearing all trees and debris from the bank, and grading the bank surface to a slope not to exceed 1V:1.5H.

Continuity of the final graded surface is important. After grading, the surface should be true to grade, and stable with respect to slip and settlement. To form a firm foundation, it is recommended that the bank surface be tamped or lightly compacted. Care must be taken during bank compaction to maintain a soil permeability similar to that of the natural,

undisturbed bank material. After compaction, the bank surface should not deviate from the specified slope by more than several inches at any one point. This is particularly true if pre-cast slabs are to be placed on the bank.

Table 6. Recommended Grading of Grouted Rock Slope Protection

Rock Sizes		Classes (Percent Larger Than Given Rock Size)					
Equivalent Diameter(m)	Weight (Ton)	.9 ton	.45 ton	.23 ton	Light	Facing	Cobble
1.07	1.81	0-5					
0.84	0.9	50-100	0-5				
0.69	0.45		50-100	0-5			
0.53	0.23	95-100		50-100	0-5		
0.38	0.09		95-100		50-100	0-5	
0.30	0.03			95-100	95-100	50-100	0-5
0.15	0.01					95-100	95-100
Minimum Penetration of grout (mm)		609	457	498	254	203	152

Table 7. Dimensions for Concrete Slab

Revetment Class	DIMENSION											
	A	B	C	D	E	F	G	H	I	J	K	L
Light Duty	101mm	0mm	230mm	560mm	560mm	150mm	100mm	1220-1525mm	610-915mm	455mm	4750-6095mm	150mm
Heavy Duty	150mm	230mm	230mm	560mm	610mm	230mm	150mm	1220-1525mm	610-915mm	455mm	7620-9145mm	230mm

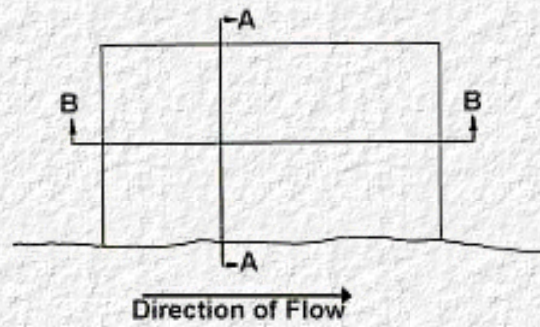

(A)

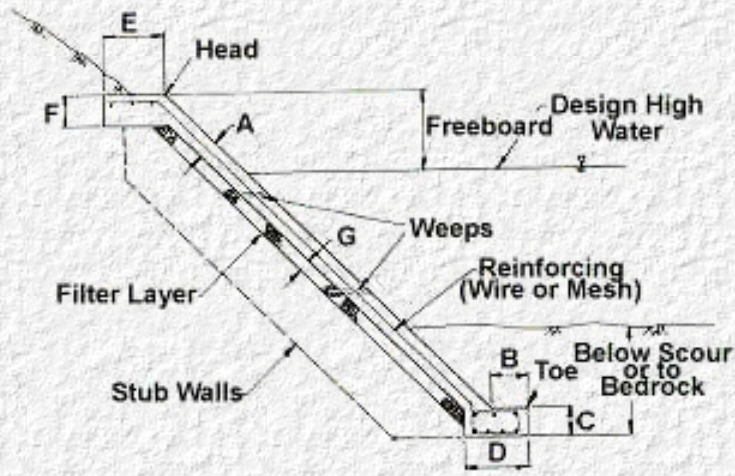

SECTION A-A

- Note: 1. All dimensions as indicated in table 7.
 2. Detail shown for stable soil conditions.
 For unstable soil conditions modify footing detail.

(B)

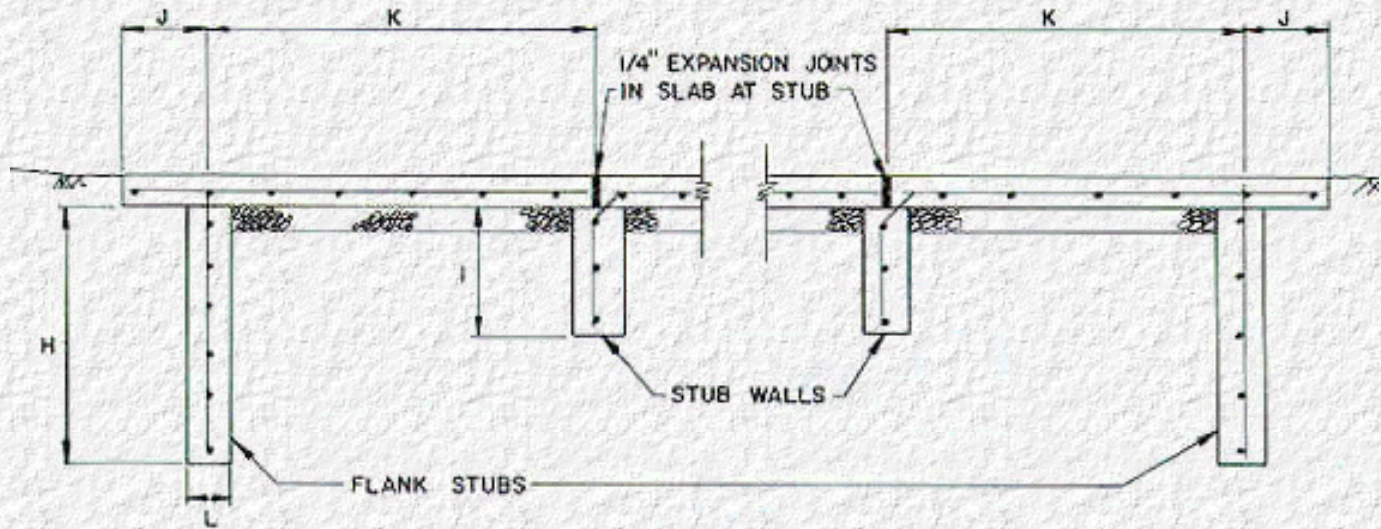

- NOTES: 1. All dimensions as indicated in Table 7

(c)

Figure 58. Concrete Paving Detail: (a) Plan; (b) Section A-A; (c) Section B-B

The foundation for the concrete pavement revetment should have a bearing capacity sufficient to support either the dry weight of the revetment alone, or the submerged weight of the revetment plus the weight of water in the wedge above the revetment for design conditions, whichever is greater.

Bank Slope: The bank slope for concrete pavements should not exceed 1V:1.5H.

Pavement Thickness: A pavement thickness of 100 to 150 mm is recommended. Pavement thickness of up to 100 mm is referred to as a light pavement, and 150 mm paving as heavy pavement.

Reinforcement: The purpose of reinforcement is to maintain the continuity of pavement by aggregate interlock even though cracks develop from shrinkage, thermal stresses, and flexural stresses.

Reinforcement may be either mesh or bar reinforcement. Typically, No. 6-gage wire mesh is used in 100 mm slabs, and 6.3 mm rebars are used in 150 mm slabs. Both size and spacing in each direction must be specified.

Concrete Quality: Concrete should be of good strength, and the concrete mixture shall be proportioned so as to secure a workable, finishable, durable, watertight, and wear resistant concrete of the desired strength. Class A (AASHTO classification) proportions are recommended. However, in some less critical design situations, Class B proportions may be used.

Edge Treatment: The edges of the concrete pavement (the toe, head, and flanks) require special treatment to prevent undermining. Section A-A in [Figure 58b](#) illustrates standard head and toe designs. The head of the pavement should be tied into the bank and overlapped with soil as illustrated to form a smooth transition from the concrete pavement to the natural bank material. This minimizes scour due to the discontinuity in this area. Also, this design seals off the filter layer from any water which overtops the revetment, thereby reducing the potential for erosion at this interface.

Section A-A also illustrates the standard toe design. The revetment toe should extend to a depth below anticipated scour or to bedrock. When this is not feasible without costly underwater construction, an alternative design should be considered. Several alternative designs are illustrated in [Figure 59](#), including a riprap filled toe trench, a toe mattress, and a sheet-pile toe wall. (Other types of toe retaining walls are also good alternatives.) In all but the latter case, the concrete pavement should extend a minimum of 1.5 m below the channel bed; the sheet-pile toe wall can be attached to the concrete pavement above, below, or at the channel bed level (see [Section 3.6.2.2](#)).

Section B-B [[Figure 58c](#)] illustrates flank treatment. At the upstream and downstream flanks, flank stubs are used to prevent progressive undermining at the flanks.

Stub Walls: As illustrated in [Figure 58c](#), stub walls should be placed at regular intervals. Stub walls provide support for the revetment at expansion joints; they also guard against progressive failure of the revetment.

Filter Design: Filters are required under all concrete pavement revetments to provide a zone of high permeability to carry off seepage water and prevent damage to the overlying structure from uplift pressures. A 100 to 150 mm granular filter is required beneath the pavement to

provide an adequate drainage zone. The filter can consist of well graded granular material or uniformly graded granular material underlain with an underlying filter fabric. The filter should be designed to provide a high degree of permeability while preventing base material particles from penetrating the filter, thus causing clogging and failure of the protective filter layer. [Chapter 4](#) contains more specific information for filter design.

Pressure Relief: Weep holes should be provided in the revetment to relieve hydrostatic pressure build-up behind the pavement surface (see [Figure 58](#)). Weeps should extend through the pavement surface and into the granular underdrain or filter layer. Weeps should consist of 76 mm diameter pipes having a maximum horizontal spacing of 1.8 m and a maximum vertical spacing of 3.0 m. The buried end of the weep should be covered with wire screening or filter fabric of a gage that will prevent passage of the gravel filter layer. Alternatively, a closed end pipe with horizontal slits can be used for the drain; in this case, the slits must be of a size that will not pass the granular filter material.

6.4.2 Construction

Design details for concrete slope pavement are illustrated in [Figure 58](#). The following construction procedures and specifications are given:

- Normal construction procedures include:
 - a. bank clearing and grading,
 - b. development of a foundation,
 - c. trenching and setting forms for stubs,
 - d. placing the filter layer,
 - e. forming for and placing the concrete pavement (including any special adaptations necessary for the revetment toe,
 - f. backfilling toe trenches (if required), and
 - g. vegetation of disturbed areas.
- The usual specifications for placing and curing structural concrete should apply to concrete slope paving.
- Subgrade should be dampened before placement of the concrete.
- Reinforcement must be supported so that it will be maintained in its proper position in the completed paving.
- If the slope is too steep to allow ordinary hand finishing, a 6.4 mm thickness of mortar may be applied immediately after the concrete has set.
- Slabs should be laid in horizontal courses, with cold joints without filler between courses. These joints should be formed with 20 mm lumber, which should be removed and the joint left open upon completion.
- Vertical expansion joints should run normal to the bank at 4.6 to 9.1 m intervals. These joints should be formed using joint filler.
- Headers or forms for use during screening or rodding operations must be firm enough and so spaced that adjustment will not be necessary during placement operations.

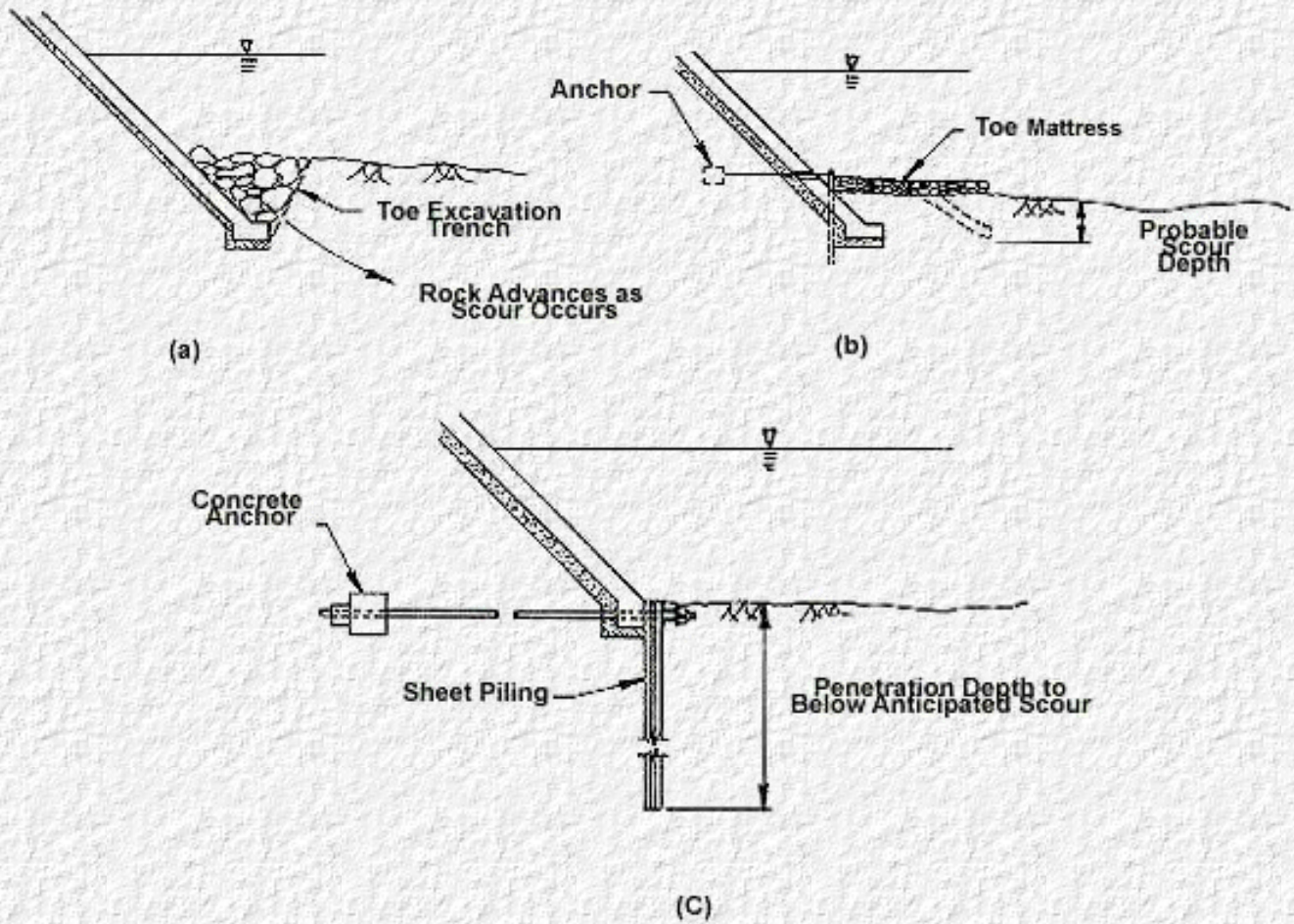

Figure 59. Concrete Pavement Toe Details

[Go to Appendix A](#)



Appendix A : HEC 11

Suggested Specifications

[Go to Appendix B](#)

This Appendix Contains suggested specifications for:

- rock riprap,
- wire-enclosed rock,
- grouted rock,
- pre-cast concrete block revetments, and
- paved lining.

These specifications are presented for the information of the designer, and should be modified as required for each individual design.

7.1 Riprap

7.1.1 Description

This work consists of furnishing materials and performing all work necessary to place riprap on bottoms and side slopes of channels, or as directed by the engineer.

The types of riprap included in this specification are:

- a. Rock Riprap:** Riprap consists of stone dumped in place on a filter blanket or prepared slope to form a well-graded mass with a minimum of voids.
 - b. Rubble:** Rubble refers to waste construction material used as riprap. Types of rubble include broken concrete, rock spoils, and steel furnace slag.
-

7.1.2 Materials

All materials shall meet the following requirements:

- a. Rock Riprap:** Stone used for riprap shall be hard, durable, angular in shape; resistant to weathering and to water action; free from overburden, spoil, shale and organic material; and shall meet the gradation requirements specified. Neither breadth nor thickness of a single stone should be less than one-third its length. Rounded stone or boulders will not be accepted unless authorized by special provisions. Shale and stone with shale seams are not acceptable. The minimum weight of the stone shall be $2,482 \text{ kg/m}^3$ as computed by multiplying the specific gravity (bulk-saturated-surface-dry basis, AASHTO Test T 85) times $1,000 \text{ kg/m}^3$.

The sources from which the stone will be obtained shall be selected well in advance of the time when the stone will be required in the work. The acceptability of the stone will be determined by service records and/or by suitable tests. If testing is required, suitable samples of stone shall be taken in the presence of the engineer at least 25 days in advance of the time when the placing of riprap is expected to begin. The approval of some rock fragments from a particular quarry site shall not be construed as constituting the approval of all rock fragments taken from that quarry.

In the absence of service records, resistance to disintegration from the type of exposure to which the stone will be subjected will be determined by any or all of the following tests as stated in the special provisions:

- When the riprap must withstand abrasive action from material transported by the stream, the abrasion test in the Los Angeles machine shall also be used. When the abrasion test in the Los Angeles machine (AASHTO Test T 96) is used, the stone shall have a percentage loss of not more than 40 after 500 revolutions.
- In locations subject to freezing or where the stone is exposed to salt water, the sulfate soundness test (AASHTO Test T 104 for ledge rock using sodium sulfate) shall be used. Stones shall have a loss not exceeding 10 percent with the sulfate test after 5 cycles.
- When the freezing and thawing test (AASHTO Test 103 for ledge rock procedure A) is used as a guide to resistance to weathering, the stone should have a loss not exceeding 10 percent after 12 cycles of freezing and thawing.

Each load of riprap shall be reasonably well-graded from the smallest to the maximum size specified. Stones smaller than the specified 10 percent size and spalls will not be permitted in an amount exceeding 10 percent by weight of each load.

Control of gradation will be by visual inspection. The contractor shall provide two samples of rock of at least 2.27 kilograms each, meeting the gradation specified. The sample at the construction site may be a part of the finished riprap covering. The other sample shall be provided at the quarry. These samples shall be used as a frequent reference for judging the gradation of the riprap supplied. Any difference of opinion between the engineer and the contractor shall be resolved by dumping and checking the gradation of two random truck loads of stone. Mechanical equipment, a sorting site, and labor needed to assist in checking gradation shall be provided by the contractor at no additional cost the State.

b. Rubble: Materials used as rubble riprap shall be hard, durable, angular in shape; resistant to weathering and to water action; free from overburden, spoil, shale and organic material; and shall meet the gradation requirements specified. Neither breadth nor thickness of a single unit should be less than one-third its length.

Extreme care must be exercised in the selection of rubble for use as riprap.

7.1.3 Construction Requirements

a. General: Slopes to be protected by riprap shall be free of brush, trees, stumps, and other objectionable materials and be dressed to smooth surface. All soft or spongy material shall be removed to the depth shown on the plans or as directed by the engineer and replaced with approved native material. Filled areas will be compacted as specified for embankments. A toe trench as shown on the plans shall be dug and maintained until the riprap is placed.

Protection for structured foundations shall be provided as early as the foundation construction permits. The area to be protected shall be cleared of waste materials and the surfaces to be protected prepared as shown on the plans. The type of riprap specified will be placed in accordance with these specifications as modified by the special provisions.

When shown on the plans, a filter blanket or filter fabric shall be placed on the prepared slope or area to be provided with foundation protection as specified in [Table 8](#) before the stone is placed.

I. Minimum Quality Standards

- . Fibers used in the manufacture of geotextiles shall consist of long chain synthetic polymers, composed of at least 85% by weight polyolafins, polyesters, or polyamides.
- B. Geotextiles with low resistance to ultraviolet degradation (more than 30% strength loss at 500 hours exposure ASTM D-4355) should not be exposed to sunlight for more than 7 days.

Geotextiles with higher resistance to ultraviolet degradation should not be exposed for more than 30 days. NOTE: Geotextiles can be manufactured or finished to resist degradation due to prolonged exposure to ultraviolet radiation, i.e., fabrics resistant to exposure for multi-year periods (from 5 to 25 years) are not uncommon.

- C. Physical Property Requirements are shown in [Table 8](#) below:

Table 8. Recommended Minimum Properties for Synthetic Fabrics (Geotextiles) Used in Noncritical⁽¹⁾ /Nonsevere Drainage⁽²⁾, Filtration, and Erosion Control Applications

Test Methods*	Drainage ⁽³⁾		Erosion Control ⁽³⁾	
	Class A ⁽⁴⁾	Class B ⁽⁵⁾	Class A ⁽⁶⁾	Class B ⁽⁷⁾

Grab Strength (TF #25 Method 1) (Min. in either principle direction.)	800 N	356 N	890 N	400 N
Elongation (TF #25 method 1) (Min. in either principle direction)	Not Specified	Not Specified	15%	15%
Puncture Strength (TF #25 Method 4)	800 N	111 N	800 N	178 N
Burst Strength (TF #25 Method 3)	2.0E06 Pa	(9.0E05 Pa)	2.2E06 Pa	1.0E06 Pa
Trapezoid Tear (TF #25 Method 2)	222 N	111 N	222 N	(133 N)
<i>*Test methods are in accordance with procedures outlined in the FHWA Geotextile Engineering Manual (26).</i>				

II. Minimum Hydraulic Properties

a. Piping Resistance (soil retention) ⁽⁸⁾

1. Soil with 50% or less particles by weight passing U.S. No. 200 Sieve⁽⁹⁾ ;

AOS⁽¹⁰⁾ less than 0.6mm (greater than #30 U.S. Std. Sieve)

2. Soil with more than 50% particles by weight passing U.S. No. 200 Sieve⁽⁹⁾;

AOS⁽¹⁰⁾ less than 0.3mm (greater than #50 U.S. Std. Sieve)

b. Permeability

K of fabric ⁽¹¹⁾ greater than K of soil

The contractor shall maintain the riprap until all work on the contract has been completed and accepted. Maintenance shall consist of the repair of areas where damaged by any cause.

B. Rock Riprap: Stone for riprap shall be placed on the prepared slope or area in a manner which will produce a reasonably well-graded mass of stone with the minimum practicable percentage of voids. The entire mass of stone shall be placed so as to be in conformance with the lines, grades, and thickness shown on the plans. Riprap shall be placed to its full course thickness at one operation and in such a manner as to avoid displacing the underlying material. Placing of riprap in layers, or by dumping into chutes, or by similar methods likely to cause segregation, will not be permitted.

The larger stones shall be well distributed and the entire mass of stone shall conform to the gradation specified by the engineer. All material going into riprap protection shall be so placed and distributed so that there will be no large accumulations of either the larger or smaller sizes of stone.

It is the intent of these specifications to produce a fairly compact riprap protection in which all sizes of material are placed in their proper proportions. Hand placing or rearranging of individual stones by mechanical equipment may be required to the extent necessary to secure the results specified.

Unless otherwise authorized by the engineer, the riprap protection shall be placed in conjunction with the construction of the embankment with only sufficient lag in construction of the riprap protection as may be necessary to allow for proper construction of the portion of the embankment protected and to prevent mixture of embankment and riprap. The contractor shall maintain the riprap protection until accepted, and any material displaced by any cause shall be replaced to the lines and grades shown on the plans at no additional cost to the State.

When riprap and filter material are dumped under water, thickness of the layers shall be increased as shown on the plans; and methods shall be used that will minimize segregation.

Notes:

1. Critical applications involve the risk of loss of life, potential for significant structural damage, or where repair costs would greatly exceed installation costs.
2. Severe applications include draining gap graded or pipable soil, high hydraulic gradients or reversing, or cyclic flow conditions.
3. All numerical values represent minimum average roll values, i.e., values measured for a sample (average of all specimen results) should meet or exceed specified values within a 2 sigma confidence level. These values are considerably lower than those commonly presented in manufacturers literature.
4. Class A Filtration and Drainage applications for fabrics are where installation stresses are more severe than Class B applications, i.e., very sharp angular aggregate is used, a heavy degree of compaction is specified, or depth of trench is greater than 3 m.
5. Class B Filtration and Drainage applications are those where fabric is used with smooth graded surfaces having no sharp angular projections, no sharp angular aggregate is used; compaction requirements are light, and trenches are less than 3 m in depth.
6. Class A Erosion Control applications are those where fabrics are used under conditions where installation stresses are more severe than Class B, i.e., stone placement height should be less than 0.91 m and stone weights should not exceed 113 kg. Field trials are required where stone placement height exceeds 0.91 m or where stone weight exceeds 113 kg.
7. Class B Erosion Control applications are those where fabric is used in structures or under conditions where the fabric is protected by a sand cushion or by "zero drop height" placement of stone.
8. Design values as determined by an engineering analysis which assure compatibility between soil, hydraulic conditions, and geotextile are recommended (especially for critical/severe applications). Problem soils where the above guidelines may not apply are silts and uniform sands with 85% passing the #100 sieve.
9. When protected soil contains particle sizes greater than #4 U.S. Std Sieve size, use only that gradation of soil passing the #4 U.S. Std. Sieve in selecting the fabric.
10. AOS determined for geotextiles according to TF #25 method 6.

7.1.4 Measurement for Payment

The quantity of riprap to be paid for, of specified thickness and extent, in place and accepted, shall be measured by the number of cubic yards as computed from surface measurements parallel to the riprap surface and thickness measured normal to the riprap surface. Riprap placed outside the specified limits will not be measured or paid for, and the contractor may be required to remove and dispose of the excess riprap without cost to the State.

7.1.5 Basis for Payment

The quantities determined, as provided in [Section 7.1.4](#) shall be paid for at the contract unit price per cubic yard shown in the bid schedule, which price shall be full compensation for furnishing all material, tools, and labor for the preparation of the subgrade; the placing of the riprap; and all other work incidental to finished construction in accordance with these specifications.

7.2 Wire-Enclosed Rock

7.2.1 Description

This work will consist of furnishing all materials and performing all work necessary to place wire-enclosed rock on bottoms and side slopes of channels or as directed by the engineer. Wire-enclosed rock consists of mats of baskets fabricated from wire mesh, filled with stone, connected together, and anchored to the slope. Details of construction may differ depending upon the degree of exposure and the service, whether used for revetment or used as a toe protection for the other types of riprap.

7.2.2 Materials

1. **Rock:** Rock used to fill the wire units shall meet the requirements of [Section 7.1.2](#), except for size and gradation of stone. Stone used shall be well-graded and 70 percent, by weight, shall exceed in least dimension the wire mesh opening. The maximum size of stone, measured normal to the slope, shall not exceed the mattress thickness.
2. **Wire enclosures:** The wire used to fabricate the mattress or block units shall be of the gage and dimensions shown on the plans.
3. **Lacing wire:** Ties and lacing wire shall be No. 9 gage galvanized unless otherwise specified.

7.2.3 Construction Requirements

Construction requirements shall meet those given in [Section 7.1.3](#). Wire enclosure segments shall be hand or machine formed to the dimensions shown on the plans. Enclosure segments shall be placed, laced, and filled to provide a uniform, dense, protective coat over the area specified.

Perimeter edges of wire-enclosed units are to be securely bound so that the joints formed by tying the edges have approximately the same strength as the body of the mesh. Wire-enclosed units shall be tied to their neighbors along all contacting edges at left 0.31 m intervals in order to form a continuous connected structure.

Mattresses on channel side slopes should be tied to the banks by anchor stakes driven 1.2 m into tight soil (clay) and 1.8 m into loose soil (sand). The anchor stakes should be located at the inside corners of basket diaphragms along an upslope (highest) basket wall, so that the stakes are an integral part of the basket. The exact maximum spacing of the stakes depends upon the configuration of the baskets; however, the following is the minimum spacing: stakes every 1.8 m along and down the slope for slopes 1V:2.5H and steeper, and every 2.7 m along and down the slope for slopes flatter than 1V:2.5H. Counterforts are optional with slope mattress linings. Slope mattress staking, however, is required, whether or not counterforts are used.

Channel linings should be tied to the channel banks with wire-enclosed riprap counterforts at least every 3.7 m. Counterforts should be keyed at least 300 mm into the existing banks with slope mattress linings and should be keyed at least 0.91 m by turning the counterfort endwise when the lining is designed to serve as a retaining wall.

7.2.4 Measurement for Payment

The quantity of wire-enclosed riprap of specified thickness and extent in place and accepted, shall be measured by the number of square yards obtained by measurements parallel to the revetment surface. Riprap placed outside the specified limits will not be measured or paid for, and the contractor may be required to remove and dispose of the excess without cost to the State.

7.2.5 Basis for Payment

The quantities determined, as provided in [Section 7.2.4](#) shall be paid for at the contract unit price per square yard shown in the bid schedule, which price shall be full compensation for furnishing all material, tools, and labor for preparation of the subgrade; placing the revetment; and all other work incidental to finished construction in accordance with these specifications.

7.3 Grouted Rock Riprap

7.3.1 Description

This work will consist of furnishing all materials and performing all work necessary to place grouted rock riprap on bottoms and side slopes of channels or as directed by the engineer. Grouted rock riprap consists of rock-slope protection having voids filled with concrete grout to form a monolithic armor.

7.3.2 Materials

All materials shall meet the following requirements:

- Rock: Stone used shall meet the requirements of [Section 7.1.2](#).
 - Grout: The grout shall be made of good strength concrete using a maximum aggregate size of 20 mm and a slump of 80-100 mm.
-

7.3.3 Construction Requirements

Construction requirements shall meet those given in [Section 7.1.3](#), and shall meet the following additional requirements:

- The rock shall be wet immediately prior to commencing the grouting operation.
 - The rock to be grouted shall be basically free of fines in order that penetration of grout be achieved.
 - The ends shall be protected by tying them into solid rock or forming smooth transitions with embankment subjected to lower velocities.
 - The grouted rock shall be founded on solid rock or below the depth of possible scour.
 - A foundation treatment shall be required if the foundation is not reasonably dry.
 - Weep holes shall be provided in the blanket to relieve any hydrostatic pressure behind the blanket.
 - The finished grout shall leave face stones exposed for one-fourth to one-third their depth and the surface of the grout shall expose a matrix of coarse aggregate.
 - The grout shall be transported to the place of final deposit by use of chutes, tubes, buckets, pneumatic equipment, or any other mechanical method which will control segregation and uniformity of the grout.
 - Spading and rodding shall be required where penetration is achieved by gravity flow into the interstices.
 - No loads shall be allowed upon the revetment until good strength has been developed.
-

7.3.4 Measurement for Payment

The quantity of grouted rock riprap to be paid for, of specified thickness and extent, in place and accepted, shall be measured by the number of cubic meters computed from surface measurements parallel to the riprap surface, and thickness measured normal to the riprap surface. Riprap placed outside the specified limits will not be measured or paid for, and the contractor may be required to remove and dispose of the excess riprap without cost to the State.

7.3.5 Basis for Payment

The quantities determined, as provided in [Section 7.3.4](#), shall be paid for at the contract unit price per cubic meter shown in the bid schedule, which price shall be full compensation for furnishing all material, tools, and labor for preparation of the subgrade; placing the stone; grouting the stone; and all other work incidental to finished construction in accordance with these specifications.

7.4 Pre-Cast Concrete Blocks

7.4.1 Description

This work consists of furnishing materials and performing all work necessary to place pre-cast concrete block revetment on bottoms and side slopes of channels or as directed by the engineer.

The types of pre-cast concrete blocks included in this specification are:

- Cellular pre-cast concrete blocks. Cellular blocks which interlock with each other in some manner when placed on the embankment slope, and allow vegetation to grow through the blocks.
 - Articulated concrete blocks. Concrete blocks held together by steel rods or cables and placed on the embankment slope
-

7.4.2 Materials

All materials shall meet the following requirements:

a. Cellular Pre-cast Concrete Blocks:

- Concrete: The concrete shall have a minimum compressive strength of 2.75E07 Pa in 28 days. Portland cement shall conform to ASTM C 150, Type I, II or V, depending on soil conditions. Aggregates shall conform to ASTM C 33 and be minus 10 mm. Mixing water shall be fresh, clean, and potable. In freeze-thaw areas, air entrapment of 5-1/2% to 8-1/2% shall be provided. Water reducing

admixtures and/or super-plasticizers are permitted and shall conform to ASTM C 494.

- Anchors : Anchors shall be corrosive-resistant and have provisions for attaching to the cellular mat.
- Filter: The cellular pre-cast concrete block revetment shall have filter blanket of gravel or fabric placed underneath the revetment. The filter shall meet the requirements given in [Chapter 4](#).

All materials shall conform to the specifications for concrete masonry in Standard Specifications for Highway Bridges (30).

b. Articulated Pre-cast Blocks:

- Concrete: The concrete used for fabrication of the blocks shall be Class A, using 7.8 sacks per cubic meter.
- Reinforcement: The wire mesh shall be attached to the bar reinforcement and the bar steel shall be in the indicated position shown on the plans. The wire mesh shall be 18 gage wire and the bar steel shall be 13 mm diameter. The longitudinal cable or rod linking the blocks shall be 20 mm diameter steel.
- Anchors : Anchors shall be corrosive-resistant and have provisions for attaching to the articulated mat.
- Filter : The articulated pre-cast concrete block revetment shall have a filter blanket of gravel or plastic placed underneath the revetment. The filter shall meet the requirements given in [Chapter 4](#).

7.4.3 Construction Requirements

Construction requirements shall meet those given in [Section 7.1.3](#), and shall meet the following requirements:

For cellular block revetment:

- All vegetation and debris shall be removed from the embankment.
- The slope shall be graded as evenly as possible.
- An anchor trench shall be dug at the top of slope to secure the mat system on the slope.
- A toe trench shall be dug at the bottom of the installation.
- A mat anchoring system shall be installed.
- A woven or non-woven geotextile filter fabric shall be placed on the graded slope (if the revetment does not come with a carrier fabric).
- The mats shall be attached to a spreader bar and lifted with a crane to place on the embankment slope.
- Mats shall be anchored by lapping at least 0.31 m of the mat in the anchor trench and fastening the cable loops to helix anchors that are driven into the trench. A minimum of two anchors per mat is required.

- Adjacent mats shall be secured to each other by fastening the protruding cables together along each side of the revetment mats.
- The anchor trenches shall be back-filled and compacted until flush with the top of the mats. The slope shall be back-filled with soil, fertilizer and seed.

The following are construction details for articulated concrete block revetment:

- The submerged bank shall be shaped prior to placement of the articulated concrete revetment.
- The blocks shall be placed together on a launching barge that is anchored over the underwater bank. Measuring parallel to the bank, a mattress up to 43 m wide shall be assembled by placing the blocks side by side on the launching barge and joining them with corrosion-resistant wire and clamps.
- The completed mattress shall be moved off the barge and sunk in place on the underwater bank by attaching the mattress to the bank and moving the barge towards the middle of the stream.
- The blocks shall be in alignment parallel to the toe of slope, and, if the embankment material is granular, the interstices between the blocks shall be filled with soil and seeded.
- Revetment shall be placed during the low-water season usually between mid-July and mid-December

All construction shall conform to the specifications for concrete masonry in Standard Specifications for Highway Bridges (30).

7.4.4 Measurement for Payment

The quantity of pre-cast concrete block revetment to be paid for, of specified thickness and extent, in place and accepted, shall be measured by the number of square yards as computed from surface measurements parallel to the revetment surface. Revetment placed outside the specified limits will not be measured or paid for, and the contractor may be required to remove and dispose of the excess revetment without cost to the State.

7.4.5 Basis for Payment

The quantities determined, as provided in [Section 7.4.4](#) shall be paid for at the contract unit price per square meter shown in the bid schedule, which price shall be full compensation for furnishing all material, tools, and labor for preparation of the subgrade; placing the revetment; and all other work incidental to finished construction in accordance with these specifications.

7.5 Paved Lining

7.5.1 Description

This work will consist of furnishing all materials and performing all work necessary to place concrete pavement revetment on bottoms and side slopes of channels or as directed by the engineer. Concrete pavement revetments are cast in place on a prepared slope to provide the necessary bank protection.

7.5.2 Materials

All materials shall meet the following requirements:

- Concrete: The concrete shall be of good strength. Class A proportions with six sacks is required.
- Reinforcement: The reinforcement shall be 60 mm rebars in 150 mm slabs. The spacing in each direction is specified on the plans.
- Filter: Concrete pavement shall have a filter blanket placed underneath the revetment. The filter shall meet the requirements given in [Chapter 4](#).

All materials shall conform to the specifications for concrete masonry in Standard Specifications for Highway Bridges (30).

7.5.3 Construction Requirements

Construction requirements shall meet those given in [Section 7.1.3](#), and shall meet the following requirements:

- The bank shall be well-compacted, true to grade and stable to maintain continuity: 0.15 m tolerance is allowed.
- Subgrade shall be dampened before placement of the concrete.
- Concrete slabs shall be cast in place on the prepared slope.
- Reinforcement shall be supported so that it will be maintained in its proper position in the completed paving.
- The slabs shall be laid in horizontal courses, and successive courses shall break joints with the preceding one.
- Horizontal joints shall be normal to the slope and shall be cold joints without filler. The joints extending up the slope shall be formed with 20 mm lumber, which shall be removed and the joint left open.
- Expansion joints shall be filled with joint filler.
- A deformed surface shall be required as shown on the plans.
- Headers or forms for use during screening or rodding operations shall be firm

enough and so spaced that adjustment will not be necessary during placement operations.

- A filter material shall be placed under the concrete slope pavement. The filter shall meet the requirements given in [Chapter 4](#).
- Weep holes shall be provided to assure drainage of the bank. Weep holes shall be placed where shown on the plans.
- The toe of slope pavement shall have a cutoff or stub wall.

All construction shall conform to the specifications for concrete masonry in Standard Specifications for Highway Bridges

7.5.4 Measurement for Payment

The quantity of concrete pavement to be paid for, of specified thickness and extent, in place and accepted, shall be measured by the number of square meters computed from surface measurements parallel to the riprap surface. Concrete pavement placed outside the specified limits will not be measured or paid for, and the contractor may be required to remove and dispose of the excess pavement without cost to the state.

7.5.5 Basis for Payment

The quantities determined, as provided in [Section 7.5.4](#), shall be paid for at the contract unit price per square meter shown in the bid schedule, which price shall be full compensation for furnishing all material, tools, and labor for preparation of the subgrade; placing of slabs; and all other work incidental to finished construction in accordance with these specifications.

[Go to Appendix B](#)



Appendix B : HEC 11

Stream Bank Protection Products and Manufacturers

[Go to Appendix C](#)

This Appendix Contains a listing of manufacturers of various stream bank protection products related to riprap and related revetments. The list is organized by product type. Although an attempt was made to identify as many commercial products as possible, the list is not exhaustive. The intent is to provide a representative sample of available products, and does not in any way represent an endorsement of specific products by this agency.

8.1 Gabions

<u>Company</u>	<u>Address</u>
Bekaert Gabions	4930 Energy Way Reno, NV 89502
Maccaferri Gabions, Inc	RR#2, Box 43A Williamsport, MD 21795
Terra Aqua Inc.	4930 Energy Way P. O. Box 7546 Reno, NV 89510

8.2 Cellular Blocks

<u>Company</u>	<u>Address</u>
ARMORTEC Incorporated	Suite 1990 Peachtree Corners Plaza Norcross/Atlanta, GA 30071
ERCO Systems, Inc.	P. O. Box 4133 New Orleans, LA 70178

Erosion Control Systems, Inc.

3349 Ridgelake Dr.
Suite 101
B. Metairie, LA 70002

Grass Pavers, Ltd.

3807 Crooks Road
Royal Oak, MI 48073

Kennross-Naue Canada, Ltd.

320 Alameda Drive
Palm Springs, FL 33461

Louisiana Industries

P. O. Box 5396
Bossier City, LA 71171

PETRAFLEX Inc.

P. O. Box 599
Channelview, TX 77530

8.3 Bulkheads

Company

ALCOA Marine Corporation

Address

8235 Pen Randal Place
Upper Marlboro, MD 20870

ARMCO Steel Corporation

419 Chanin Bldg.
815 Connecticut Ave., NW
Washington, DC 20006

GAF Corporation

140 W. 51st St.
New York, NY 10020

Kaiser Aluminum

300 Lakeside Dr.
Oakland, CA 94643

Spidel Foundations Harbor
and Marine Corporation

1055 North Shore Dr.
Benton Harbor, MI 49022

8.4 Filter Fabrics

Company

Address

Advance Construction Specialties Company

P.O. Box 17212
Memphis, TN 38117

American Excelsior Company

P.O. Box 249
Sheboygan, WI 5308

Carthage Mills, Inc.

124 W. 66th St.
Cincinnati, OH 45216

Celanese Fibers Marketing Company

1211 Avenue of the Americas
New York, NY 10036

DuPont

1007 Market St.
Wilmington, DE 19898

Gulf States Paper Corporation

P. O. Box 3199
Tuscaloosa, AL 35401

Johns-Manville

Ken-Caryl Ranch
P. O. Box 5108
Denver, CO 80217

Kennross-Naue Canada, Ltd.

320 Alameda Drive
Palm Springs, FL 33461

Koch Brothers, Inc.

35 Osage Avenue
Kansas City, KS 66105

Menardi-Southern

P. O. Box 12454
Houston, TX 77012

Monsanto Textiles Company

800 N. Lindbergh Blvd.
St. Louis, MO 63166

Ozite Corporation

1755 Butterfield Rd.
Libertyville, IL 60048

[Go to Appendix C](#)



Appendix C : HEC 11

Design Charts and Forms

[Go to Appendix D](#)

The charts, tables, and forms in this appendix have been modified for viewing and printing purposes

[Charts](#)

[Tables](#)

[Forms](#)

List of Charts

- [Chart 1. Riprap Size Relationship](#)
 - [Chart 2. Correction Factor for Riprap Size](#)
 - [Chart 3. Bank Angle Correction Factor \(\$K_1\$ \) Nomograph](#)
 - [Chart 4. Angle of Repose of Riprap in Terms of Mean Size and Shape of Stone](#)
 - [Chart 5. Conversion from Equivalent \$D_{50}\$ in Meters to \$W_{50}\$ in Kg](#)
 - [Chart 6. Nomograph of Deepwater Significant Wave Height Prediction Curves \(modified from reference 29\)](#)
 - [Chart 7. Hudson Relationship for Riprap Size Required to Resist Wave Erosion](#)
 - [Chart 8. Wave Run-Up on Smooth, Impermeable Slopes \(modified from reference 29\)](#)
-

Tables

- [Table 9. Correction for Wave Run-Up](#)
-

Forms

- [Form 1. Riprap Size-Particle Erosion](#)
 - [Form 2. Riprap Size-Wave Erosion](#)
 - [Form 3. Material Gradation](#)
 - [Form 4. Roughness Evaluation](#)
 - [Form 5. Filter Design](#)
-

[Go to Appendix D](#)



Appendix D : HEC 11

Riprap Design Relationship Development

[Go to Table of Contents](#)

This appendix presents the development of the velocity based riprap design relationship used in this version of [HEC-11](#). The relationship is based on shear stress theory, yet in its final form uses flow velocity and depth as its controlling parameters. In the development of the relationship, the basic relationship is presented, followed by a discussion of its calibration, and conversion to a velocity based procedure. The recommended procedure is then compared with previously developed riprap design relationships.

10.1 Basic Relationship

Two methods or approaches historically have been used to evaluate a materials resistance to particle erosion.

- Permissible Velocity Approach
- Permissible Tractive Force or Shear Stress

Permissible tractive force methods are generally considered to be more academically correct. However, critical velocity approaches are more rapidly embraced by the engineering community. Therefore, a design relationship for riprap design that is rooted in tractive force theory yet has velocity as its primary design parameter is needed.

The tractive force (boundary shear stress) approach focuses on stresses developed at the interface between the flowing water and the material forming the channel boundary. By Chow's definition, permissible tractive force is the maximum unit tractive force that will not cause serious erosion of channel bed material from a level channel bed. The basic premise underlying riprap design based on tractive force theory is that the flow induced tractive force should not exceed the permissible or critical shear stress of the riprap. The average tractive force or shear stress (S_o) exerted by the flowing water on the channel boundary is equal to:

$$\tau_o = \gamma RS \quad (15)$$

where:

- γ = the unit weight of water ;
- R = the hydraulic radius; and
- S = the energy grade line slope.

The riprap materials resistance to movement (its critical shear stress, (τ_c) is defined by the following relationship the form of which was first proposed by Shields (2):

$$\tau_c = K_1 SP (\gamma_s - \gamma) D_{50} \quad (16)$$

where:

SP = the Shields parameter;

γ_s = the unit weight of the riprap material;

γ = the unit weight of water;

D_{50} = the median riprap particle size; and

K_1 is defined as:

$$K_1 = [1 - (\sin^2\theta / \sin^2\phi)]^{0.5} \quad (17)$$

where:

θ = the bank angle with the horizontal; and

ϕ = the riprap material's angle of repose.

The ratio of the critical shear stress exerted by the flow field given in [Equation 16](#) and the riprap material's average tractive force as given in [Equation 15](#) is defined as the stability factor. As long as the stability factor is greater than 1, the critical shear stress of the material is greater than the flow induced tractive stress, and the material is considered stable.

Dividing [Equation 16](#) by [Equation 15](#), rearranging terms, and replacing the hydraulic radius (R) with the average flow depth (d_{avg}) yields the following relationship:

$$D_{50} / d_{avg} = (SF/SP) [S / K_1 / (S_s - 1)] \quad (18)$$

where:

SF = the stability factor

S_s = the specific gravity of the rock riprap.

[Equation 18](#) represents the basic form of the tractive stress relationship. In this form, the median riprap size is primarily a function of flow depth and slope.

10.2 Design Relationship Calibration

Calibration of the design relationship in [Equation 17](#) was accomplished using field data collected during the early 1980's by Mr. James Blodgett of the U.S. Geological survey (3). Mr. Blodgett evaluated riprap performance at 39 sites. At each site various hydraulic and geometric parameters were also determined. The data tabulated for each site is included in [Table 10](#). Of the 39 sites tabulated, only those indicating no damage or particle erosion were used. Also, several sites were eliminated due to a lack of complete data. The sites used in the analysis included sites 1, 2, 3, 4, 5, 6, 7, 8, 9, 10, 11, 12, 13, 14, 15, 16, 17, 22, 23, 24, 26, 27, 28, 30, 32, 33, 34, 35, 36, and 37. Of the 30 sites evaluated, 8 were unstable (exhibited particle erosion), and 23 were stable (no damage). Channel cross sections for each of the sites used in the analysis are presented in the data section at the end of this appendix.

The data tabulated in [Table 10](#) illustrate the hydraulic characteristics of the channel reaches evaluated. Water surface slopes ranged from 0.00006 to 0.0162; maximum flow depths ranged from 1.46 m to 14.8 m; average channel velocities ranged from 0.73 m/s to 3.81 m/s; discharges ranged from 36.3 m³/s to 2,180 m³/s; and the median (D₅₀) bank material size ranged from 0.15 m to 0.70 m. Channel geometries for these sections ranged from symmetric to severely skewed. In addition, each of the sites evaluated was in a reach exhibiting uniform, gradually varied flow conditions.

The data analysis consisted of compiling and plotting the cross section data (X-Y coordinate points), evaluating the data for correctness and consistency, computing the necessary hydraulic parameters from the data at each site, and then plotting several of the terms from [Equation 17](#) to evaluate the constants SF and SP. During the analysis, it was determined that the bank angle reported in [Table 10](#) was in error at several sites. The bank angle was corrected in the data section; the original values were left unchanged in [Table 10](#).

 [Click here to view Table 10. Site data](#)

The focus of the analysis was to evaluate the variables SP and SF. The field data are plotted in [Figure 60](#) as D_{50} / d_{avg} vs. $S/K_1/(S_s - 1)$. Stable sites are plotted as squares, and unstable sites as blackened squares. The numbers beside the plotted points are site numbers. The lines superimposed on the data represent various combinations of SF and SP; the slope of these lines equals SF/SP. The data used to build [Figure 60](#) are documented in [Table 12](#).

The data plotted in [Figure 60](#) support the use of a Shields parameter (SP) of 0.047, and a stability factor ranging from 1 to 2. Five of the eight unstable sites fall below the line representing a stability factor of 1. The remaining three sites plot between stability factors of 1.5 and 2.0. Sites 6 and 8 were located at or just downstream of sharp bends, suggesting that they may have been exposed to rather severe hydraulic conditions, thus justifying the higher plotting position with respect to stability factor. No explanation is apparent for site 24.

The data in [Figure 60](#) is limited. However, it does provide some information upon which guidelines for the selection of stability factors can be based. [Table 11](#) presents guidelines for the selection of an appropriate stability factor. The guidelines in [Table 11](#) are based in part on the data in [Figure 60](#), and in part on a comparison with other riprap design relationships (to be presented in a later section).

Table 11. Criteria for Selection of Stability Factors

Condition	Stability Factor Range
Uniform flow; Straight or mildly curving reach (curve radius/channel width > 30); Impact from wave action and floating debris is minimal; Little or no uncertainty in design parameters.	1.0-1.2
Gradually varying flow; Moderate bend curvature (30 > curve radius/channel width > 10); Impact from waves or floating debris moderate.	1.3-1.6

Approaching rapidly varying flow; Sharp bend curvature ($10 >$ curve radius/channel width); Significant impact potential from floating debris and/or ice; Significant wind and/or boat generated waves 0.31 - 0.60 m; High flow turbulence; Significant uncertainty in design parameters.

1.6-2.0

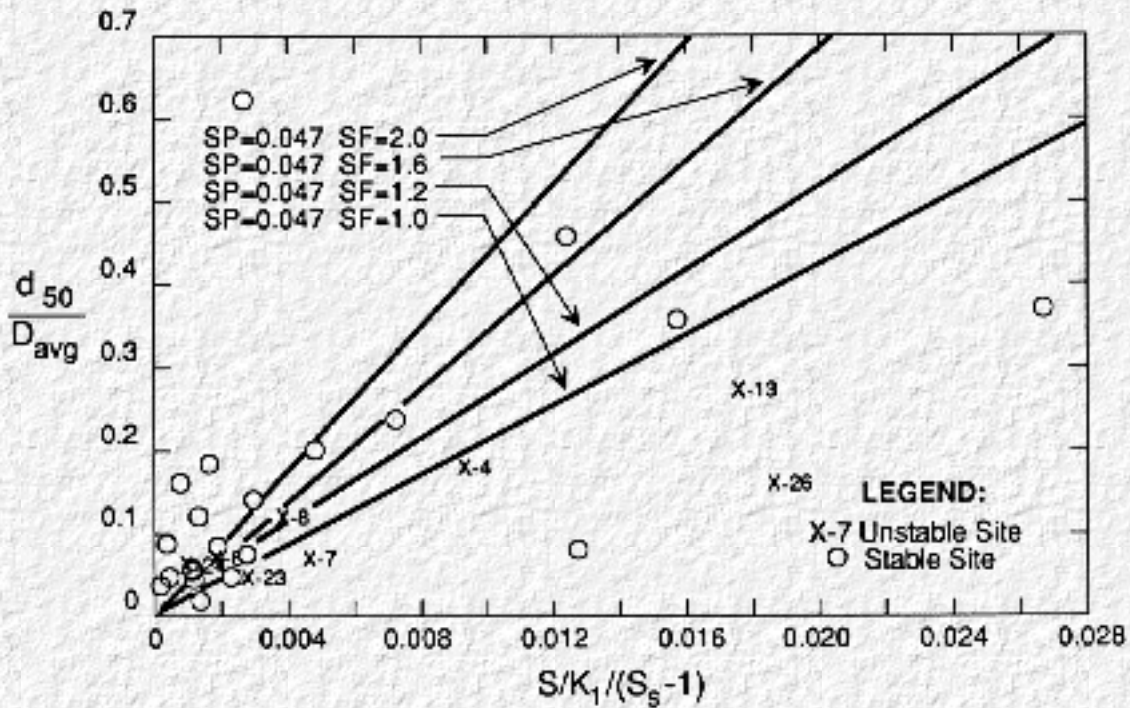

Figure 60. Riprap Design Calibration

[Click here to view Table 12. Riprap Relationship Calibration Data](#)

10.3 Conversion to a Velocity Based Procedure

As mentioned above, the engineering community is more comfortable with a velocity based relationship than one based on channel slope as given in Equation 18. Assuming uniform flow conditions, Equation 18 can be transformed to a velocity based relationship using Manning's equation to perform the transformation.

Manning's equation can be expressed as:

$$S = [(V n)/(R^{0.67})]^2 \tag{19}$$

where:

V = average channel velocity; and
n = Manning's roughness coefficient.

Manning's roughness coefficient, 'n', in Equation 19 can be related to particle size as given in

[Equation 20](#). [Equation 20](#) was developed by Anderson and others (4). An equation of this form was first proposed by Strickler in 1923 (5). The relationship has been utilized in studies of roughness by a number of other investigators including Norman (6), and Maynard (7).

$$n = 0.0482 D_{50}^{0.167} \quad (20)$$

Substituting [Equation 20](#) into [Equation 19](#) and replacing the hydraulic radius, R, with the average depth, d_{avg} , yields the following relationship for the energy slope:

$$S = (V^2 D_{50}^{0.333}) / (430.4 d_{avg}^{1.333}) \quad (21)$$

Substituting [Equation 21](#) into [Equation 18](#) and assuming a Shields parameter and stability factor of 0.047 and 1.2 respectively, and specific gravity of riprap of 2.65, results in the final design relationship given in [Equation 22](#). A correction factor (C_s) for riprap materials having specific gravity's other than 2.65 is given in [Equation 23](#). A correction factor (C_f) for stability factors other than 1.2 is given in [Equation 24](#). The coefficient derived from [Equation 23](#) and [Equation 24](#) are multiplied times the D_{50} riprap size resulting from equation [Equation 22](#).

$$D_{50} = 0.007 V^3 / (d_{avg}^{0.5} (K_1^{1.5})) \quad (22)$$

where:

V = average section velocity in the main flow channel (m/s);

d_{avg} = the average cross section depth in the main flow channel (m); and

K_1 = the bank slope correction term.

$$C_{fs} = 2.12 / (S_s - 1)^{1.5} \quad (23)$$

$$C_f = (SF/1.2)^{1.5} \quad (24)$$

10.4 Comparison with Other Methods

[Figure 61](#) and [Figure 62](#) illustrate a comparison of several velocity based riprap design methods. Included in the comparison are methods recommended by the California Division of Highways, Bureau of Public Roads, HEC-11 (1967 version), U.S. Bureau of Reclamation, the U.S. Army Corps of Engineers, and Blodgett and McConaughy (8). Superimposed on these curves is the relationship presented in [Equation 22](#). [Equation 22](#) is plotted assuming an average flow depth of 3.0 m, and stability factors as indicated. [Figure 62](#) shows the same comparison illustrating the effect of the flow depth in [Equation 22](#).

[Figure 61](#) and [Figure 62](#) also illustrate that the relationship of [Equation 22](#) falls within the range of relationships previously developed. However, it is more flexible than the others since it is based on flow depth as well as velocity.

[Figure 63](#) presents a comparison of the relationship given in [Equation 22](#) and the riprap design relationship of [HEC-15](#). Note that at a stability factor of 1, [Equation 22](#) and the design

relationship [HEC-15](#) differ by only a small amount.

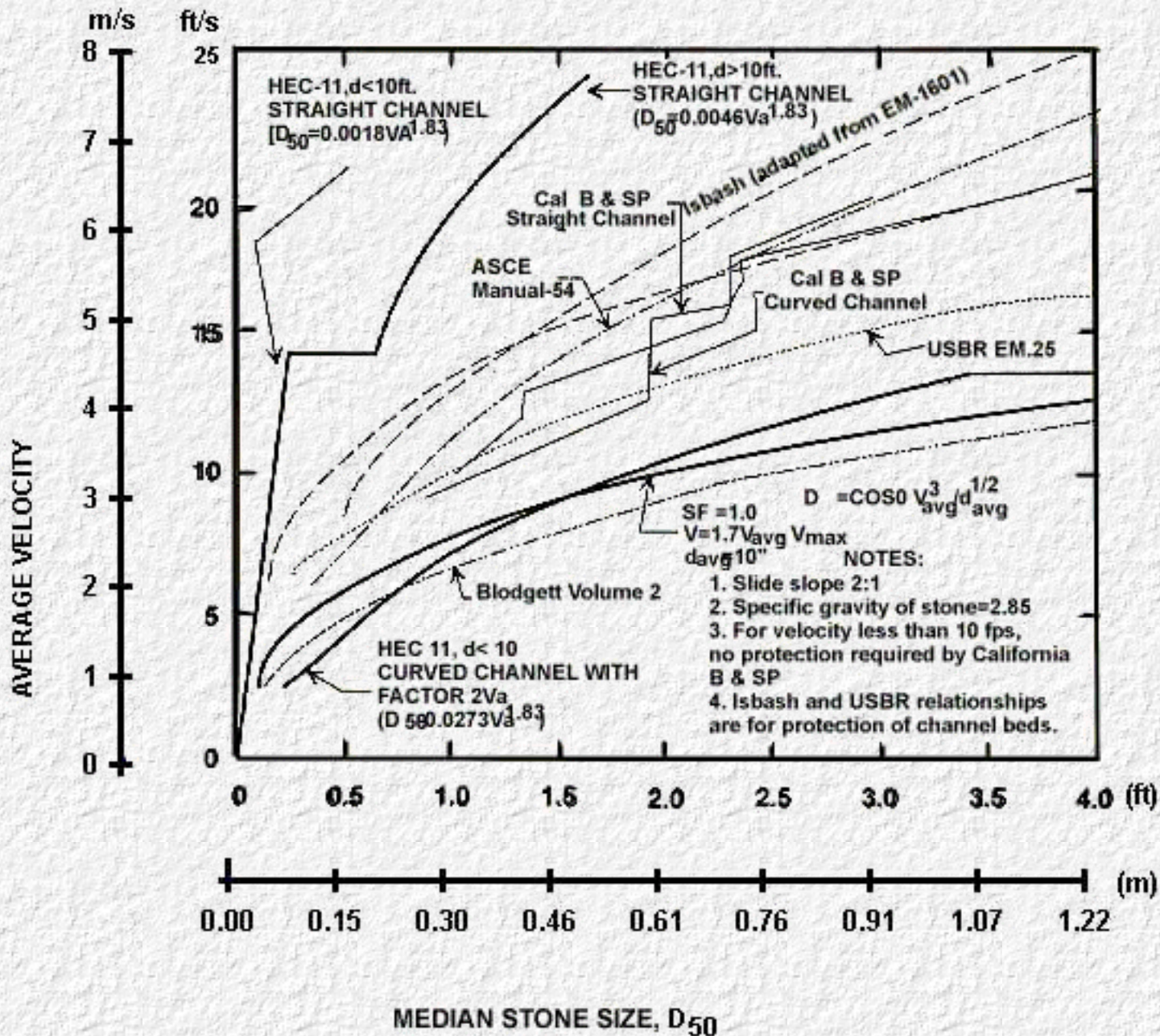

Figure 61. Comparison of Procedures for Estimating Stone Size on Channel Bank Based on Permissible Velocities (adapted from appendix A of HEC-11, Searcy, 1967)

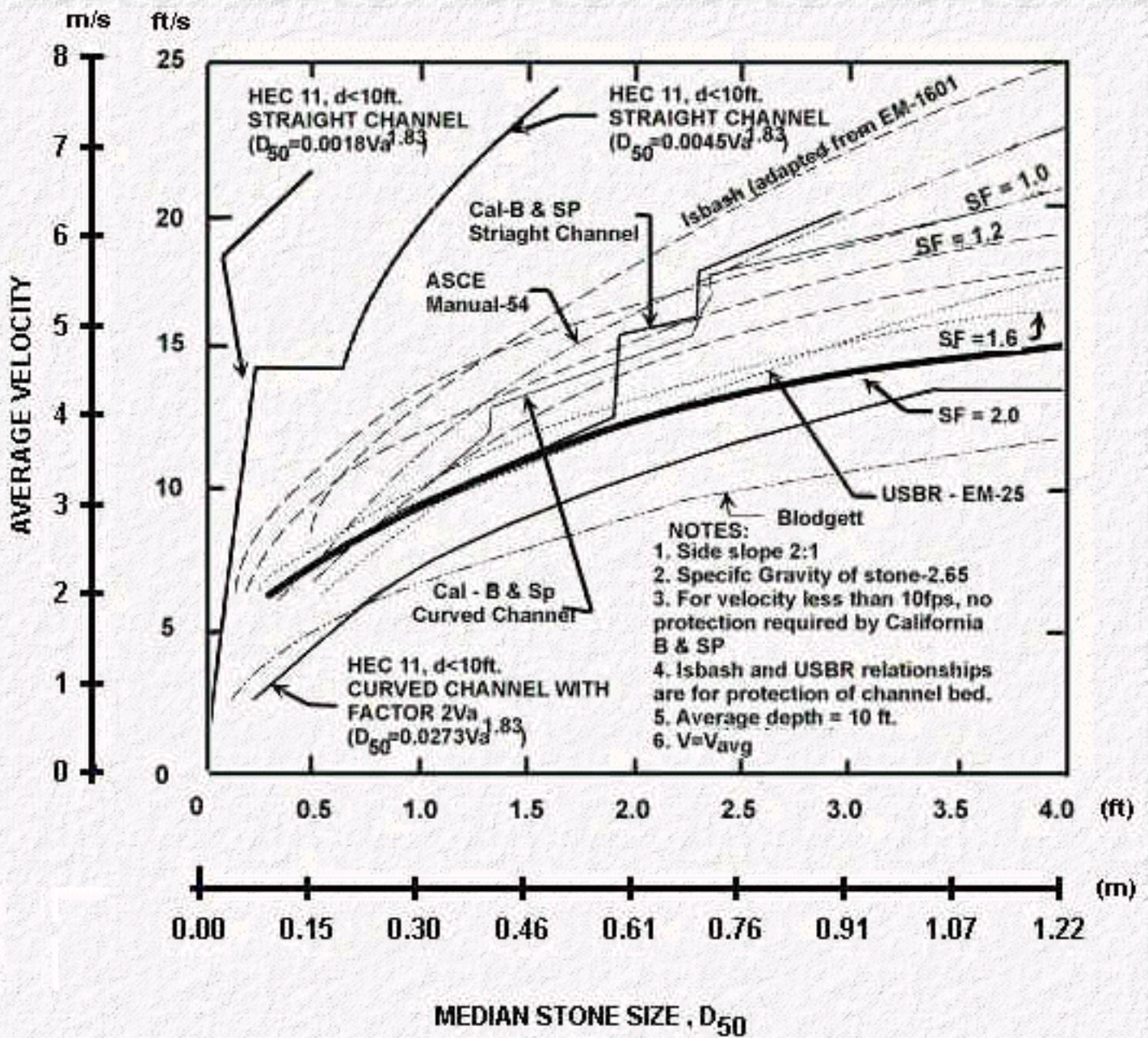

Figure 62. Comparison of Procedures for Estimating Stone Size on Channel Bank Based on Permissible Velocities: Effect of Stability Factor Illustrated (adapted from *National Engineering Handbook*)

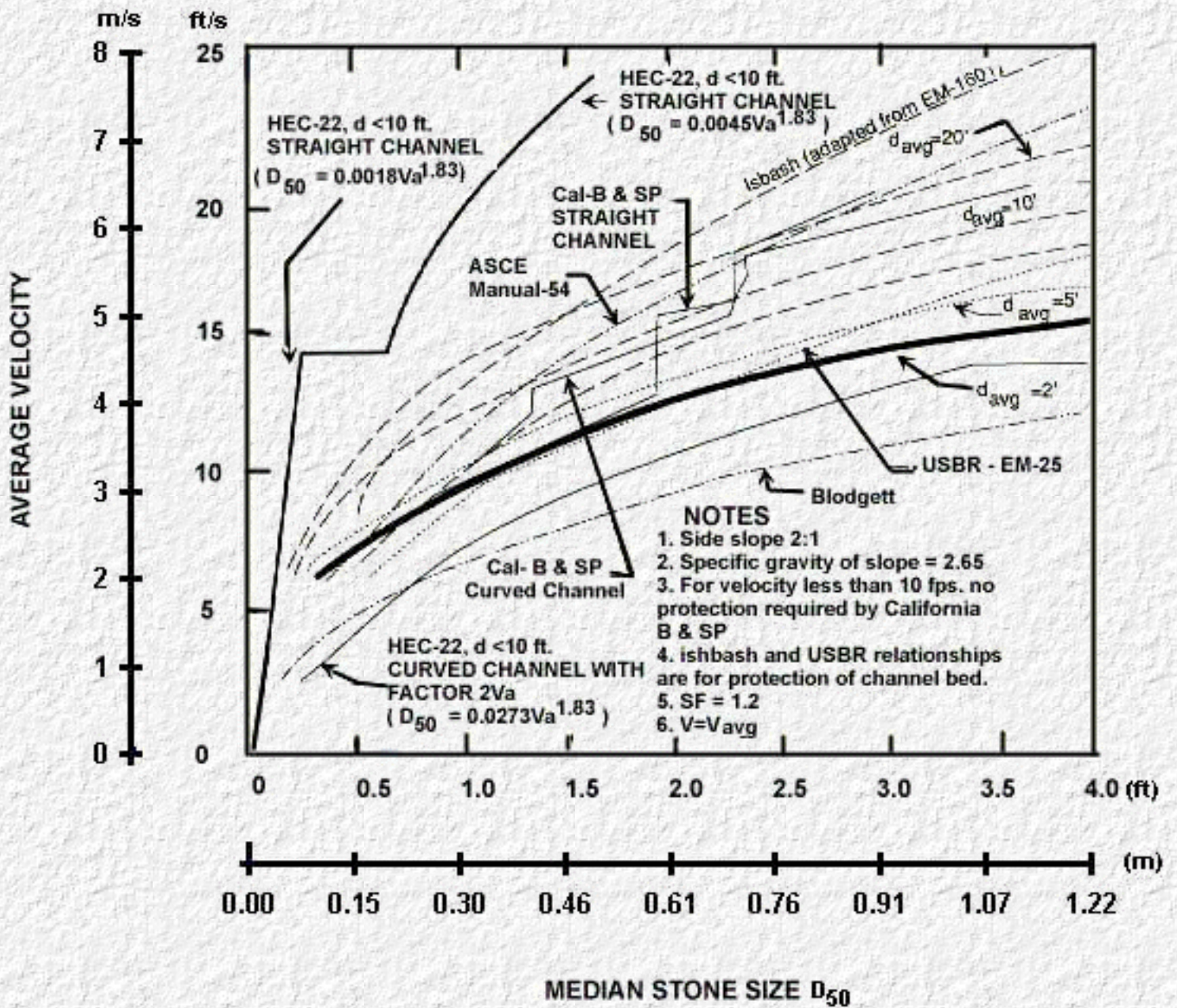

Figure 63. Comparison of Procedures for Estimating Stone Size on Channel Bank Based on Permissible Velocities: Effect of Flow Depth Illustrated (adapted from *National Engineering Handbook*)

[Go to Table of Contents](#)



List of Tables for HEC 11-Design of Riprap Revetment (Metric)



[Back to Table of Contents](#)



[Table 1. Guidelines for the Selection of Stability Factors](#)



[Table 2. Rock Riprap Gradation Limits](#)



[Table 3. Riprap Gradation Classes](#)



[Table 4. Standard Gabion Sizes](#)



[Table 5. Criteria for Gabion Thickness](#)



[Table 6. Recommended Grading of Grouted Rock Slope Protection](#)



[Table 7. Dimensions for Concrete Slab](#)



[Table 8. Recommended Minimum Properties for Synthetic Fabrics](#)



[Table 9. Correction for Wave Run-Up](#)



[Table 10. Site Data](#)



[Table 11. Criteria for Selection of Stability Factors](#)



[Table 12. Riprap Relationship Calibration Data](#)



[Back to Table of Contents](#)





Preface

[Go to Table of Contents](#)

Forward

This implementation package represents major revisions to the 1967 edition of Hydraulic Engineering Circular No. 11, "use of Riprap for Bank Protection." The manual has been expanded into a comprehensive design publication which includes recent research findings and revised procedures. The information in the manual should be of interest to the State and Federal Hydraulic Engineers and others responsible for the design of riprap. The manual has been adopted as HEC-11 in the Hydraulic Engineering Circular Series.

Copies of the manual are being distributed to the Federal Highway Administration and Regional and Division offices and to each state highway agency. Additional copies of the report can be obtained from the National Technical Information Service, 5280 Port Royal Road, Springfield, Virginia 22161.

Thomas O. Willet, Director
Office of Engineering

Stanely R. Byington, Director
Office of Implementation

Notice

This document is disseminated under the sponsorship of the Department of Transportation in the interest of information exchange. The United States Government assumes no liability for the contents or the use thereof.

The contents of this report reflect the views of the authors, who are responsible for the facts and the accuracy of the data presented herein. The contents do not necessarily reflect the policy of the Department of Transportation.

This report does not constitute a standard, specification, or regulation. The United States Government does not endorse products or manufacturers. Trade or manufacturers' names appear herein only because they are considered essential to the objective of this document.

[Go to Table of Contents](#)

[Go to Table of Contents](#)

1. Report No. FHWA-IP-89-016 HEC-11	2. Government Accession No.	3. Recipient's Catalog No.
4. Title and Subtitle DESIGN OF RIPRAP REVETMENT	5. Report Date March 1989	
7. Author(s) Scott A. Brown, Eric S. Clyde	6. Performing Organization Report No.	
9. Performing Organization Name and Address Surton Corporation 2190 Fox Mill Road Herndon, VA 22071	8. Performing Organization Report No.	
12. Sponsoring Agency Name and Address Office of Implementation, HRT-10 Federal Highway Administration 6200 Georgetown Pike McLean, VA 22101	10. Work Unit No. (TRAIS) 3D9C0033	11. Contract or Grant No. DTFH61-85-C-00123
15. Supplementary Notes Project manager: Thomas Krylowski Technical assistants: Phillip L. Thompson, Dennis L. Richards, J. Sterling Jones	13. Type of Report and Period Covered FINAL REPORT Mar. 1986-Sept. 1988	
16. Abstract This revised version of Hydraulic Engineering Circular No. 11 (HEC-11), represents major revisions to the earlier (1967) edition of HEC-11. Recent research findings and revised design procedures have been incorporated. The manual has been expanded into a comprehensive design publication. The revised manual includes discussions on recognizing erosion potential, erosion mechanisms and riprap failure modes, riprap types including rock riprap, rubble riprap, gabions, preformed blocks, grouted rock, and paved linings. Design concepts included are: design discharge, flow types, channel geometry, flow resistance, extent of protection, and toe depth. Detailed design guidelines are presented for rock riprap, and design procedures are summarized in charts and examples. Design guidance is also presented for wire-enclosed rock (gabions), precast concrete blocks, and concrete paved linings.	14. Sponsoring Agency Code	
17. Key Words Riprap, Revetments, Bank Protection, Gabions, Grouted Riprap, Riprap Design, Pre-cast Concrete Riprap, Paved Linings.	18. Distribution Statement This document is available to the public through the National Technical Information Service, Springfield, VA 22161	

19. Security Classif. (of this report)	20. Security Classif. (of this page)	21. No. of Pages	22. Price
Unclassified	Unclassified	169	

[Go to Table of Contents](#)

METRIC (SI*) CONVERSION FACTORS

Approximate Conversions to SI Units					Approximate Conversions to SI Units				
Symbol	When You Know	Multiply by	To Find	Symbol	Symbol	When You Know	Multiply by	To Find	Symbol
Length					Length				
in	inches	2.54	millimetres	mm	mm	millimetres	0.039	inches	in
ft	feet	0.3048	metres	m	m	metres	3.28	feet	ft
yd	yards	0.914	metres	m	m	metres	1.09	yards	yd
mi	miles	1.61	kilometres	km	km	kilometres	0.621	miles	mi
Area					Area				
in ²	square inches	645.2	millimetres squared	mm ²	mm ²	millimetres squared	0.0016	square inches	in ²
ft ²	square feet	0.0929	metres squared	m ²	m ²	metres squared	10.764	square feet	ft ²
yd ²	square yards	0.836	metres squared	m ²	km ²	kilometres squared	0.39	square miles	mi ²
mi ²	square miles	2.59	kilometres squared	km ²	ha	hectares	2.53	acres	ac
ac	acres	0.395	hectares	ha					
Mass Weight					Mass Weight				
oz	ounces	28.35	grams	g	g	grams	0.0353	ounces	oz
lb	pounds	0.454	kilograms	kg	kg	kilograms	2.205	pounds	lb
T	short tons (2000 lb)	0.907	megagrams	Mg	Mg	megagrams (1000 kg)	1.103	short tones	T
Volume					Volume				
fl oz	fluid ounces	29.57	millilitres	mL	mL	millilitres	0.034	fluid ounces	fl oz
gal	gallons	3.785	litres	L	L	litres	0.264	gallons	gal
ft ³	cubic feet	0.0328	metres cubed	m ³	m ³	metres cubed	35.315	cubic feet	ft ³
yd ³	cubic yards	0.0765	metres cubed	m ³	m ³	metres cubed	1.308	cubic yards	yd ³
Temperature (exact)					Temperature (exact)				
°F	Fahrenheit temperature	5/9 (after subtracting 32)	Celsius temperature	°C	°C	Celsius temperature	9/5 (then add 32)	Fahrenheit temperature	°F

These factors conform to the requirement of FHWA Order 5190.1A

*SI is the Symbol for the International System of Measurements

Table 10. Site Data (reference 6, table 7)

Site	Measurement Number	D ₅₀ (ft)	Specific Gravity G _s	Date of flood or survey	Corresponding discharge, Q (ft ³ /s)	Water Surface Slope S _w	Depth max. dm	Side Slope z	Area A (ft ²)	Velocity		Shear	Performance
										Mean V _a (ft/s)	Max V _m (ft/s)		
Sacramento River:													
Princeton, CA	1	0.48	2.95	2/17/83	71,200	0.00091	48.7	1.3:1	12,700	5.61	7.97	2.77	No Damage
Culusa, CA.	2	.67	2.77	12/22/81	40,600	.00006	47.0	1.9:1	10,300	3.93	6.17	.176	No Damage
Truckee River:													
Reno, NV.	3	2.1		6/14/83	6,550	.00625	11.0	1.5:1	780	8.40	12.95	4.29	No Damage
				3/13/83	7,230								
	4			12/20/81	8,690	.0089	13.8		946	9.19	--	7.66	Particle Erosion
Sparks, NV	5	.71	2.68	5/27/82	3,880	.0022	12.1	1.8:1	744	5.22	8.17	1.66	No Damage
	6			6/15/83	5,850	.00219	16.5	1.8:1	994	5.89	7.97	2.25	Particle Erosion
	7			12/20/81	8,670	.0055	17.2	1.8:1	1,420	6.10/	--	5.90	Particle Erosion
Pinole Creek @ Pinole, CA													
cross sec.3	8	.55	2.85	1/03/82	2,250	.0049	7.3	2:1	293	7.68	--	2.23	Particle Erosion
cross sec. 0.4	9	2.3	2.80	1/03/82	2,250	.0172	6.4	2.1:1	212	10.6	--	6.87	No Damage
Donner Creek @ Truckee, Ca	10	.68		6/13/83	613	.0062	5.6	2.1:1	112	4.63	7.43	2.52	No Damage
E.F. Carson River, near Markleeville, CA.	11	2.0	2.36	6/16/83	2,150	.01224	8.5	1.5:1	260	8.27	13.59	6.49	No Damage
Site	Measurement Number	D ₅₀ (ft)	Specific Gravity G _s	Date of flood or survey	Corresponding discharge, Q (ft ³ /s)	Water Surface Slope S _w	Depth max. d (ft ^m)	Side Slope z	Area A (ft ²)	Velocity		Shear (lb/ft ²)	Performance
										Mean V _a (ft/s)	Max V _m (ft/s)		
W. Walker River near Coleville, NV:													
@ #2	12	1.4		6/11/82	1,450	.0181	6.4	1.3:1	146	9.93	15.91	7.71	No Damage
@ #3	13	.8	2.61	6/10/82	1,280	.01636	4.8	1.5:1	140	9.14	16.69	4.90	Particle Damage

Russian River near Cloverdale, CA.	14	.69	2.78	1/13/83	28,800	.00312	12.3	2.1:1	6,833	4.22	--	2.39	No Damage
	15			12/31/81	6,970	.0018	9.7		1,140	6.11	9.46	1.09	No Damage

Cosumnes River @ Dillard Rd. near Sloughouse, CA:

@ #1	16	.78	2.79	3/13/83	26,100	.00073	24.6	2.3:1	9,975	2.62	--	1.12	No Damage
	17	--	--	12/22/82	18,800	.00076	20.4	--	7,301	2.52	--	.97	No Damage
@ #2	18	.7	--	3/13/83	26,100	.00073	24.5	1.6:1	6,750	3.87	--	1.09	Translat. slide
	19	.7	--	12/22/82	18,800	.00076	20.5	--	5,360	3.51	11	.97	Translat Slide
@ #3	20	.64	--	3/13/83	26,100	.00073	31.8	1.8:1	6,400	4.08	--	1.45	Slump
	21	--	--	12/22/82	18,800	.00076	27.8	--	5,070	3.71	--	1.32	Slump

Rillito Cr. @ T-100, AZ. (cross section 1)	22	.84	2.74	10/03/83	29,000	.0162	12.1	2:1	2,790	10.4	--	12.2	No Damage
---	----	-----	------	----------	--------	-------	------	-----	-------	------	----	------	-----------

above SPRR (cross section 3):	23	.51	2.69	10/03/83	29,000	.0038	12.5	2.5:1	3,870	7.49	--	2.96	Particle Erosion
--------------------------------------	----	-----	------	----------	--------	-------	------	-------	-------	------	----	------	------------------

Santa Cruz R @ I-19 (cross section 3)	24	.65	2.71	10/03/83	45,000	.0019	9.1	2.3:1	3,430	13.1	--	1.09	Particle Erosion
--	----	-----	------	----------	--------	-------	-----	-------	-------	------	----	------	------------------

@ I-19 cross section 1):	25	.84	--	10/03/83	45,000	.0011	9.5	1.9:1	2,780	16.2	--	.65	Particle Erosion
---------------------------------	----	-----	----	----------	--------	-------	-----	-------	-------	------	----	-----	------------------

Esperanza Creek:	26	1.0	2.63	10/03/83	12,700	.0171	8.1	1.5:1	743	17.1 / --	--	8.64	Translat. Slide & Particle Erosion
-------------------------	----	-----	------	----------	--------	-------	-----	-------	-----	-----------	----	------	------------------------------------

Santium River Near Albany, OR.	27	1.3	2.66	10/27/82	7,440	.002	21.5	2:1	2,180	3.41	5.20	.27	No Damage
	28			12/26/80	61,000	.0030	28.9	2:1	4,190	14.6	--	5.41	No Damage

Site	Measurement Number	D ₅₀ (ft)	Specific Gravity G _s	Date of flood or survey	Corresponding discharge, Q (ft ³ /s)	Water Surface Slope S _w	Depth max. d (ft ^m)	Side Slope z	Area A (ft ²)	Velocity		Shear (lb/ft ²)	Performance
										Mean V _a (ft/s)	Max V _m (ft/s)		

Hoh River near Forks, WA.:

Site #1 (old)	29 30	1.2	2.69	10/02/82 11/04/82	22,000 5,060	.00867 .0014	19.10 14.6	1.2:1 1.2:1	2,772 814	7.94 6.22/	-- 9.26	10.3 1.28	Particle Erosion No Damage
Site #1 (new)		1.3	2.59		DATA	NOT	AVAILABLE						Particle Erosion
Site #2	31 32	1.2	2.48	1/12/79 11/03/82	51,600 2,140	.00058 .006	20.9 9.4	1.6:1 1.6:1	4,943 608	10.44 3.52/	-- 5.57	.76 .35	Particle Erosion No Damage
Yakima R. @ Cle Elum, WA.	33 34	1.5 --	2.82 --	2/22/82 11/05/82	22,200 2,660	.0024 .0037	12.2 6.5	2:1 2:1	1,783 266	12.45 10.0	-- --	1.83 1.50	No Damage No Damage
Sacramento River @ E-10 near, Chico, CA.	35 36	.54	2.72	1/13/83 4/14/82	77,000 56,000	.000364 .00030	28.10 23.5	3:1 3:1	12,651 9,610	6.10 5.83	-- 7.92	.638 .44	No Damage No Damage
Sacramento River @ E-10 near Chico, CA.	37 38 39	.51 .51 .51	2.60 2.60 2.60	12/15/81 12/23/83 1/27/83	27,700 78,000 98,000	.00064 .00081 .00042	20.3 31.3 13.0	1.8:1 1.8:1 1.8:1	4,320 10,700 14,600	6.41 7.3 6.7	8.54 -- --	.600 1.58 .341	No Damage Particle Erosion Particle Erosion

Table 12. Riprap Relationship Calibration Data

Site	Meas. No.	d ₅₀ (ft)	Specific Gravity	Slope (ftft.)	Bank Angle	K ₁ * /K ₁ (S _s -1)	S/	Average Depth (ft)	d ₅₀ /D _{avg}	Per.
Sacramento @Princeton, CA .	1	0.48	2.95	0.00091	37.6	0.4105	0.001136	35.7	0.0134	ND
Sacramento @ Colusa, CA .	2	0.67	2.77	0.00006	27.8	0.7171	0.000047	27.6	0.0243	ND
Truckee River @Reno, NV.	3	2.1	2.65	0.00625	33.5	0.5653	.006700	9.6	0.2188	ND
Truckee River @ Sparks, NV.	5	0.71	2.68	0.0022	29.0	0.6892	0.001899	8.9	0.0798	ND
Pinhole CK. @ XS #4	9	2.3	2.8	0.0172	24.5	0.7848	0.012175	5.2	0.4423	ND
Donner Ck. @ Truckee, CA.	10	0.68	2.65	0.0062	24.5	0.7848	0.004787	3.4	0.2000	ND
E.F. Carson R. @ Markleeville	11	2	2.36	0.01224	33.5	0.5653	0.015919	5.7	0.3509	ND
Walker R., Coleville, NV. @ #2	12	1.4	2.65	0.0181	37.6	0.4105	0.026720	3.7	0.3784	ND
Russian R. Near Cloverdale, CA.	14	0.69	2.78	0.00312	24.5	0.7848	0.002233	14.7	0.0469	ND
Cosumnes R. @ Dillard Rd.	15	0.69	2.78	0.0018	24.5	0.7848	0.001288	5.8	0.1190	ND
	16	0.78	2.79	0.00073	23.5	0.8030	0.000507	19.9	0.0392	ND
#1	17	0.78	2.79	0.00076	23.5	0.8030	0.000528	18.7	0.0417	ND
Rillito Cr. @ CS #1	22	0.84	2.74	0.0162	26.6	0.7431	0.012528	10.1	0.0832	ND
Santiam R. Near Alpany, OR.	27	1.3	2.66	0.0002	26.6	0.7431	0.000162	14.0	0.0929	ND
	28	1.3	2.66	0.003	26.6	0.7431	0.002431	19.5	0.0667	ND
Hoh R. @ Site #1(old)	30	1.2	2.69	0.0014	39.8	0.2913	0.002843	9.0	0.1333	ND
Hoh R. @ Site #2(new)	32	1.2	2.48	0.0006	32.0	0.6106	0.000663	7.3	0.1644	ND
Yakima R. @ Cle Elum, Wa.	33	1.5	2.82	0.0024	26.6	0.7431	0.001774	7.9	0.1899	ND
	34	1.5	2.82	0.0037	26.6	0.7431	0.002735	2.4	0.6250	ND
Sacramento R. @ Peterson B.	35	0.54	2.72	0.000364	18.4	0.8817	0.000240	8.9	0.0607	ND
	36	0.54	2.72	0.0003	18.4	0.8817	0.000197	17.4	0.0310	ND
Sacramento R.@ E-10	37	0.51	2.6	0.00064	29.1	0.6868	0.000582	14.7	0.0347	ND
Truckee R.@ Reno, NV	4	2.1	2.65	0.0089	33.5	0.5653	0.009541	11.3	0.1858	PE
Truckee R.@ Sparks, NV.	6	0.71	2.68	0.00219	29.0	0.6892	0.001891	10.7	0.0664	PE
	7	0.71	2.68	0.0055	29.0	0.6892	0.004749	12.2	0.0581	PE
Pinhole Creek @ xs #3	8	0.55	2.85	0.0049	26.6	0.7431	0.003564	5.0	0.1100	PE
Walker R. @ xs #4	13	0.8	2.61	0.01636	33.5	0.5653	0.017974	2.9	0.2759	PE
Rillito Cr. @ CS #3	23	0.51	2.69	0.0038	21.8	0.8318	0.002703	10.4	0.0490	PE
Santa Cruz R. @ CS #3	24	0.65	2.71	0.0019	23.5	0.8030	0.001383	10.5	0.0619P	ER
Esperanza Creek	26	1	2.63	0.0171	33.5	0.5653	0.018556	6.8	0.1471	PE

Chart 1. Riprap Size Relationship

HEC -11 Chart-1

$$D_{50} = 0.00594V_a^3 / (d_{avg}^{1/2} K_1^{3/2})$$

D_{50} = Median Riprap Size (m)

V_a = Average Velocity in main channel (m/s)

d_{avg} = Average Depth in main channel (m)

K_1 = Bank angle correction term

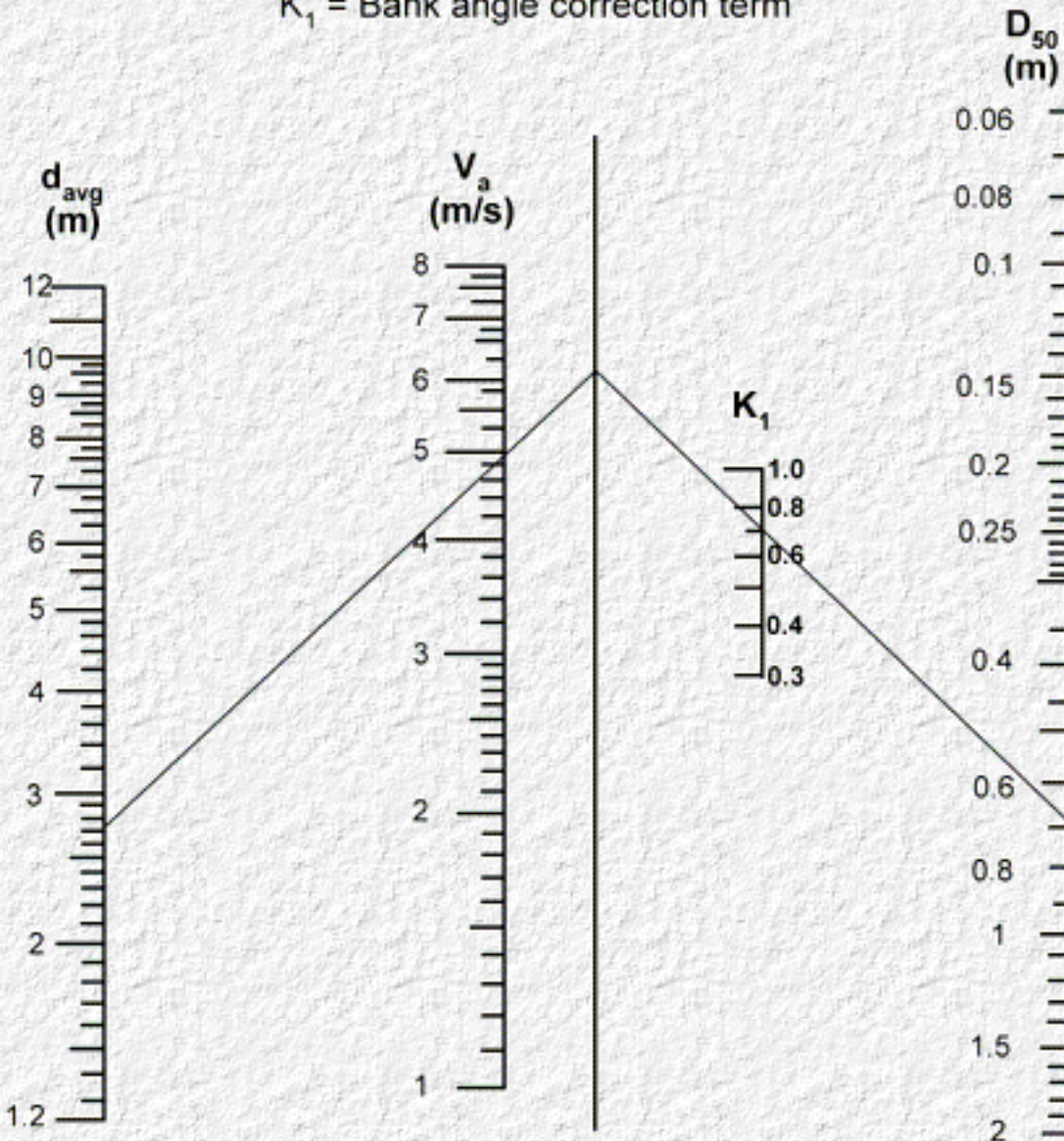

Example

Given:

$$V_a = 4.9 \text{ m/s}$$

$$d_{\text{avg}} = 2.75 \text{ m}$$

$$K_1 = 0.72$$

Find :

$$D_{50}$$

Solution

$$D_{50} = 0.69 \text{ m}$$

[Appendix C](#)

[Chart 2](#)

Chart 2. Correction Factor for Riprap Size

$$C = 1.61SF^{1.5} / (S_s - 1)^{1.5}$$

CORR=D₅₀ CORRECTION FACTOR
SF= STABILITY FACTOR
S_s = SPECIFIC GRAVITY OF ROCK

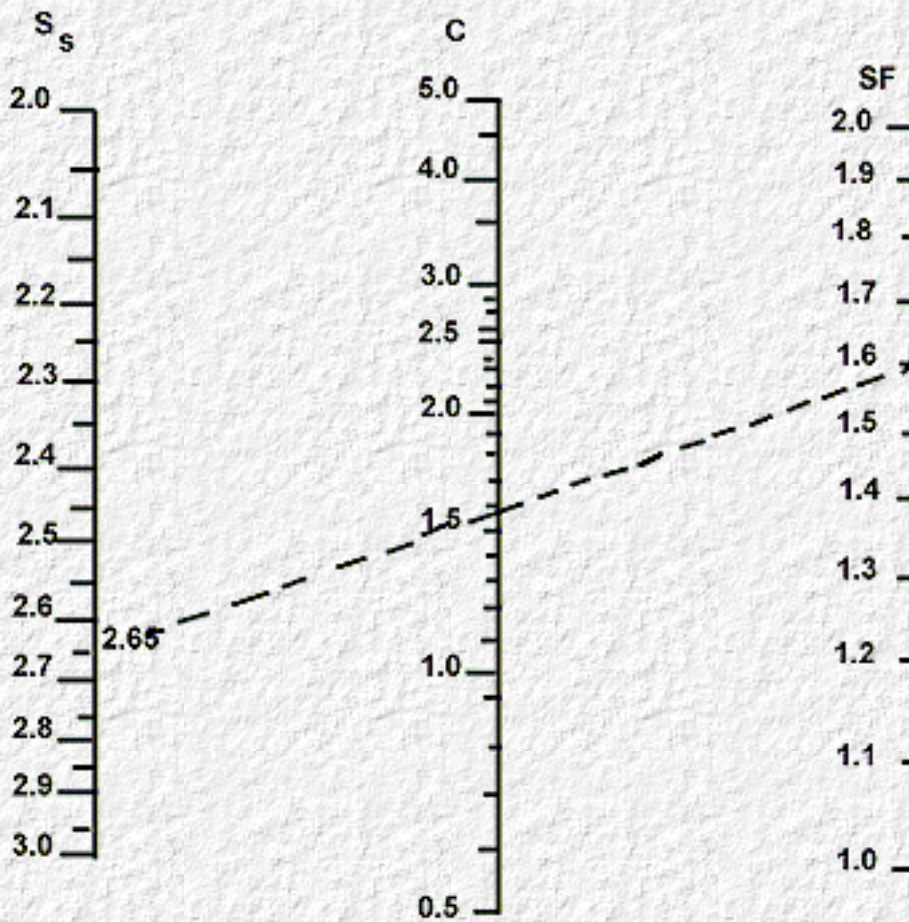

Example:

Given:
S_s = 2.65
SF = 1.60

Find:
C

Solution:
C = 1.59

Chart 3. Bank Angle Correction Factor (K_1) Nomograph

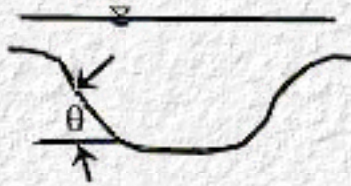

$$K_1 = \left[1 - \frac{\sin^2 \theta}{\sin^2 \phi} \right]^{0.5}$$

θ = Bank angle with horizontal
 ϕ = Material angle of Repose
 (See Chart 4)

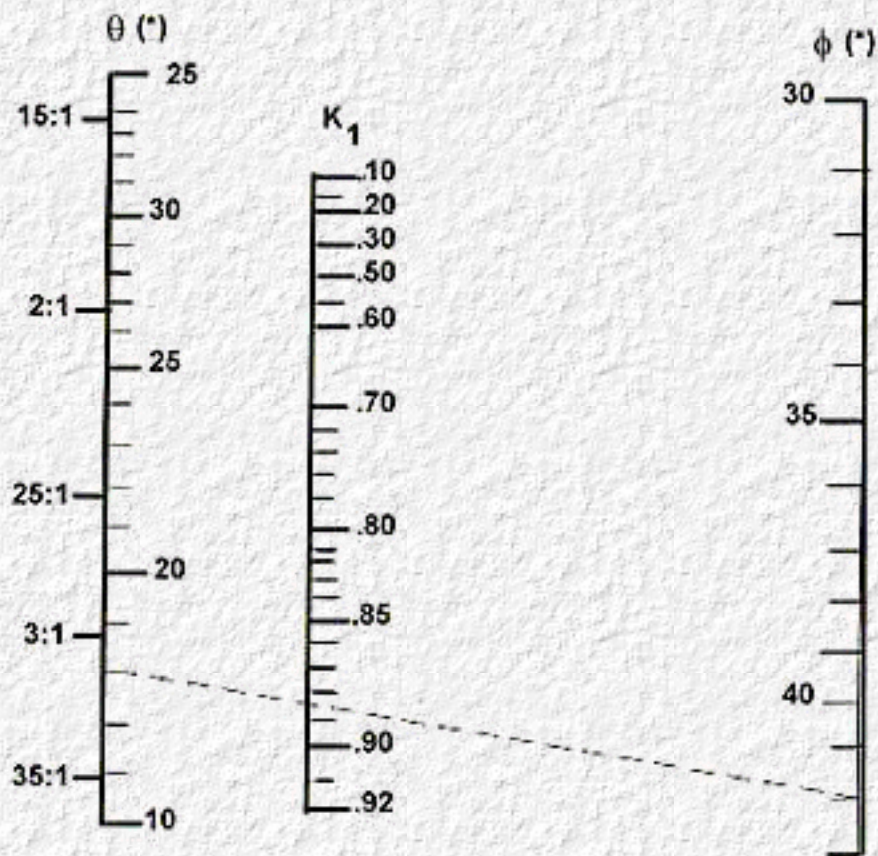

Example:

Given:
 $\theta = 18^\circ$
 Very Angular
 $D_{50} = 0.457 \text{ m}$

Find:
 K_1

Solution:
 $\phi = 42^\circ$
 $K_1 = 0.885$

Chart 4. Angle of Repose of Riprap on Terms of Mean Size and Shape of Stone

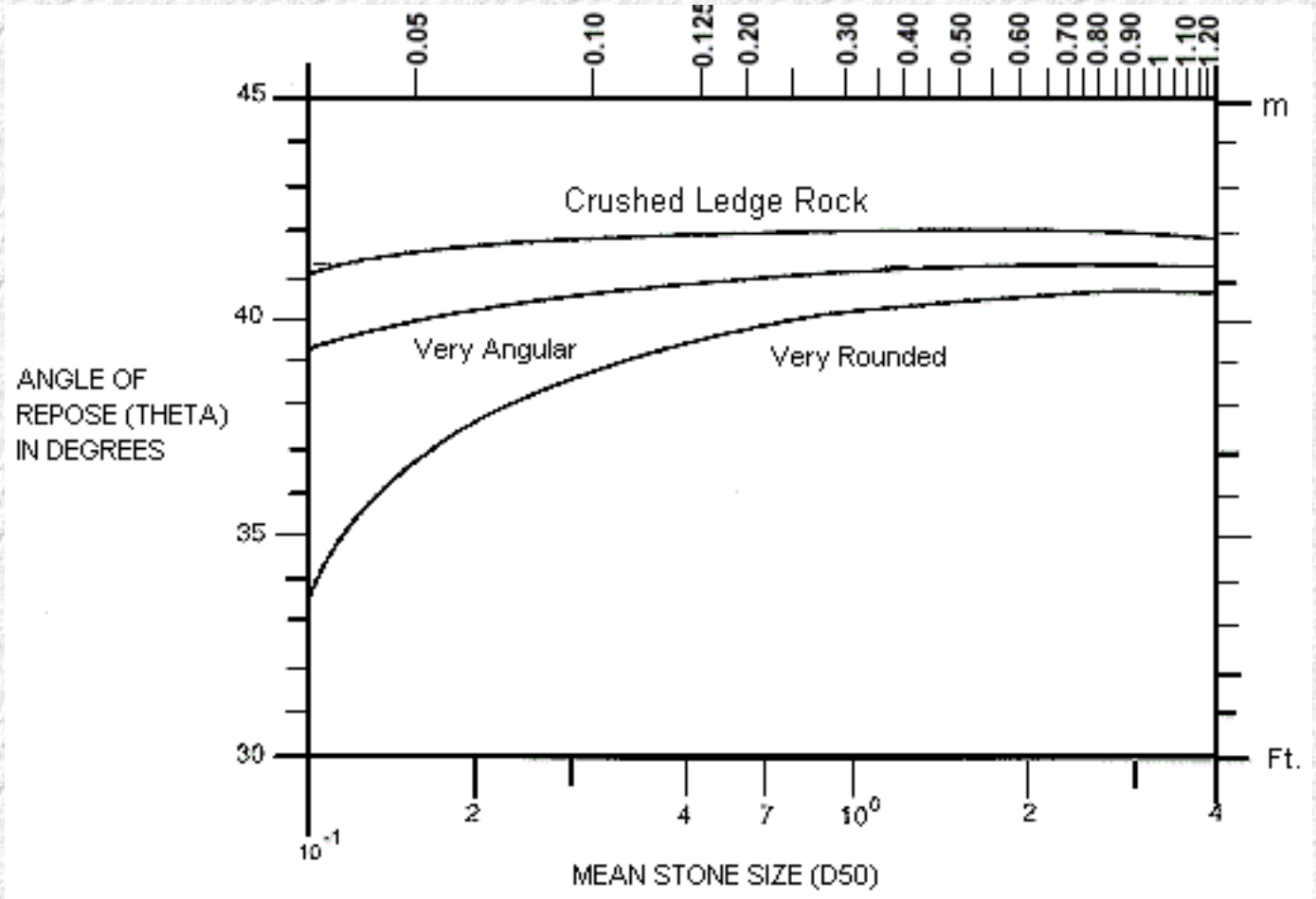
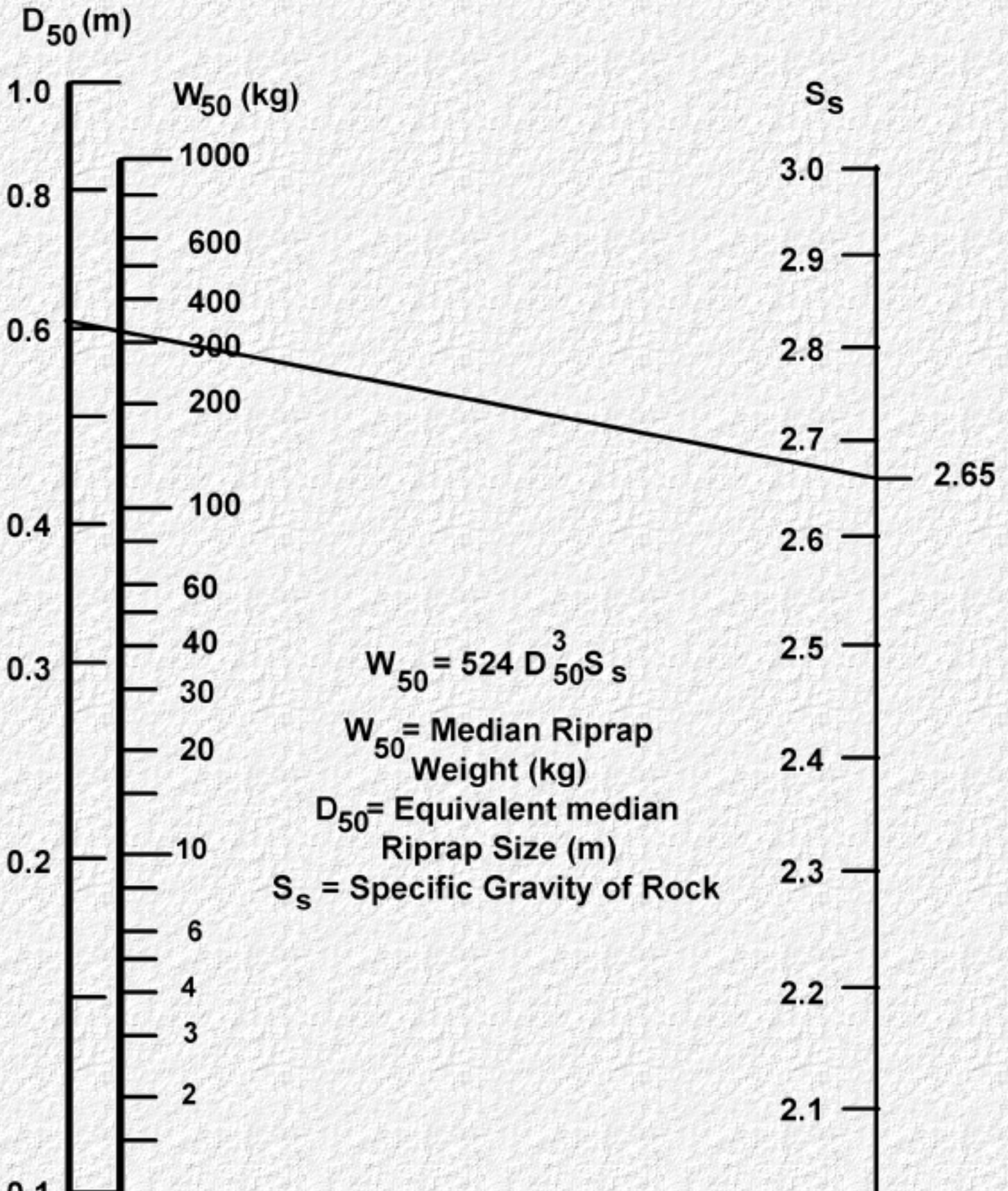

Chart 5. Conversion from Equivalent D_{50} in meters to W_{50} in kg



0.1
0.08

2.0

EXAMPLE

Given:

$$D_{50} = 0.610 \text{ m}$$

$$S_s = 2.65$$

Find

$$W_{50}$$

Solution

$$W_{50} = 315.2 \text{ Kg}$$

[Chart 4](#)

[Appendix C](#)

[Chart 6](#)

Chart 6. Nomograph of Deepwater Significant Wave Height Prediction Curves (modified from reference 29)

Metricated and English Charts Below:

- SIGNIFICANT HT. (m)
- - - PEAK SPECTRAL PERIOD (s)
- - - MIN. DURATION (min, hr)

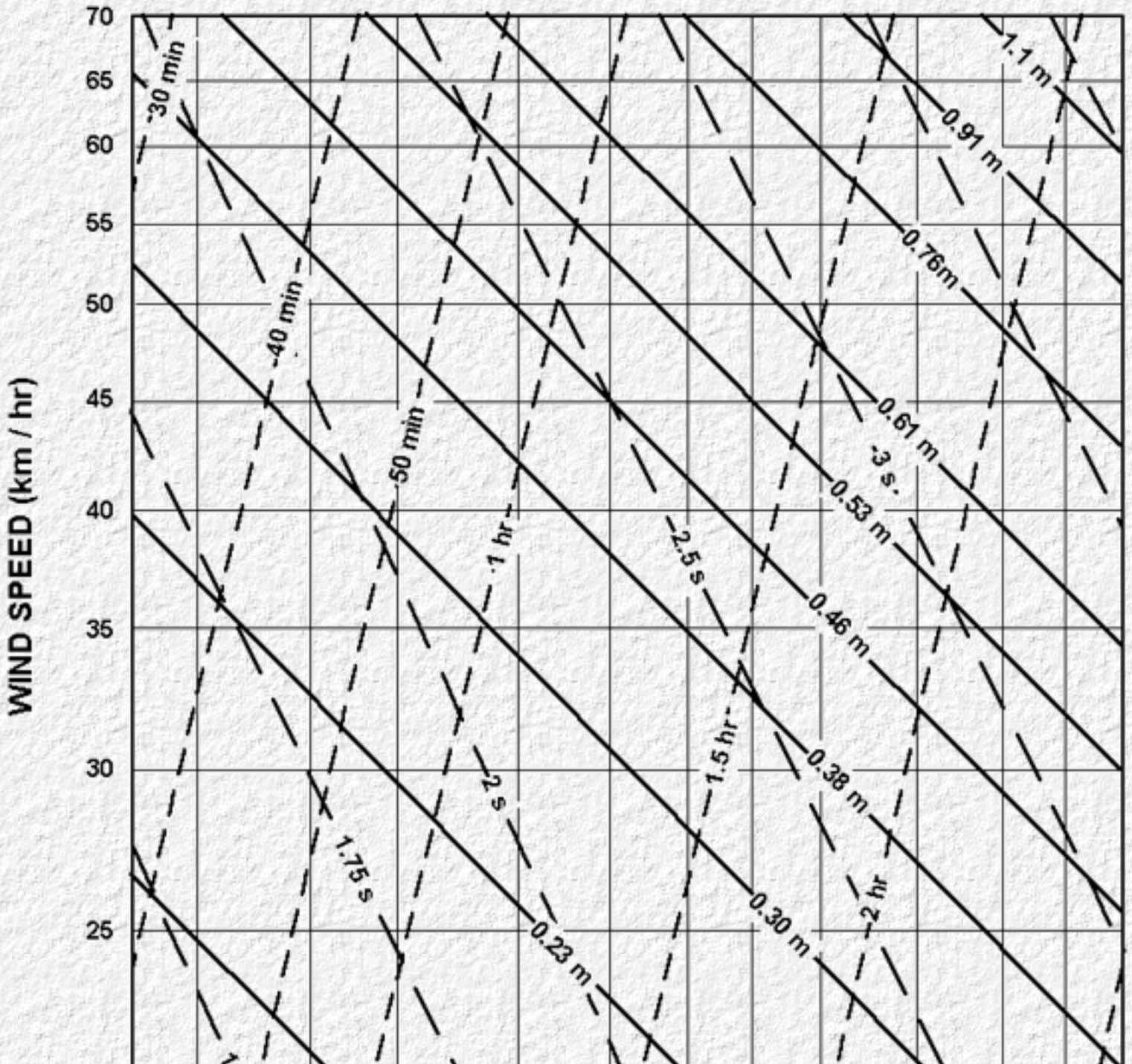

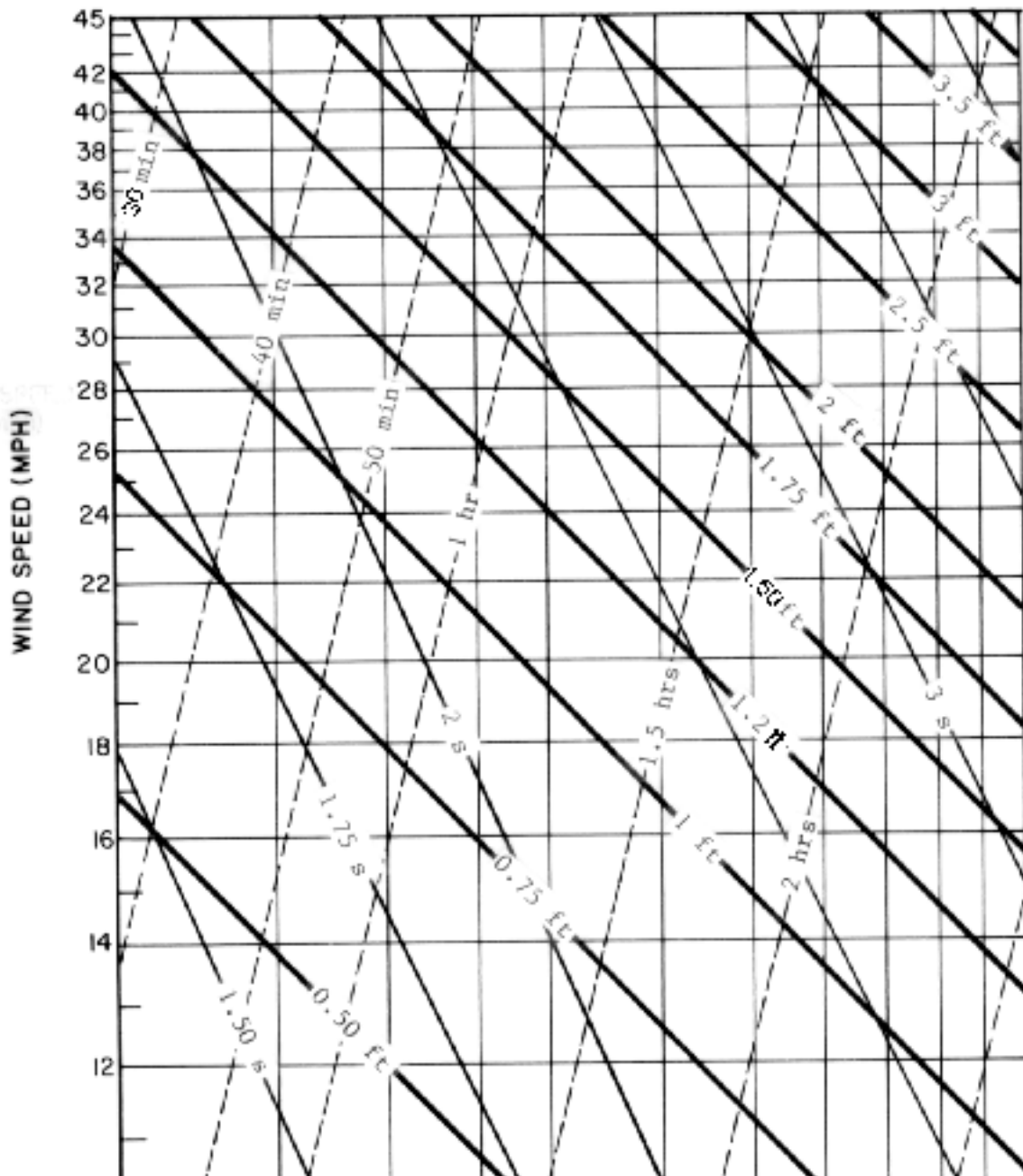
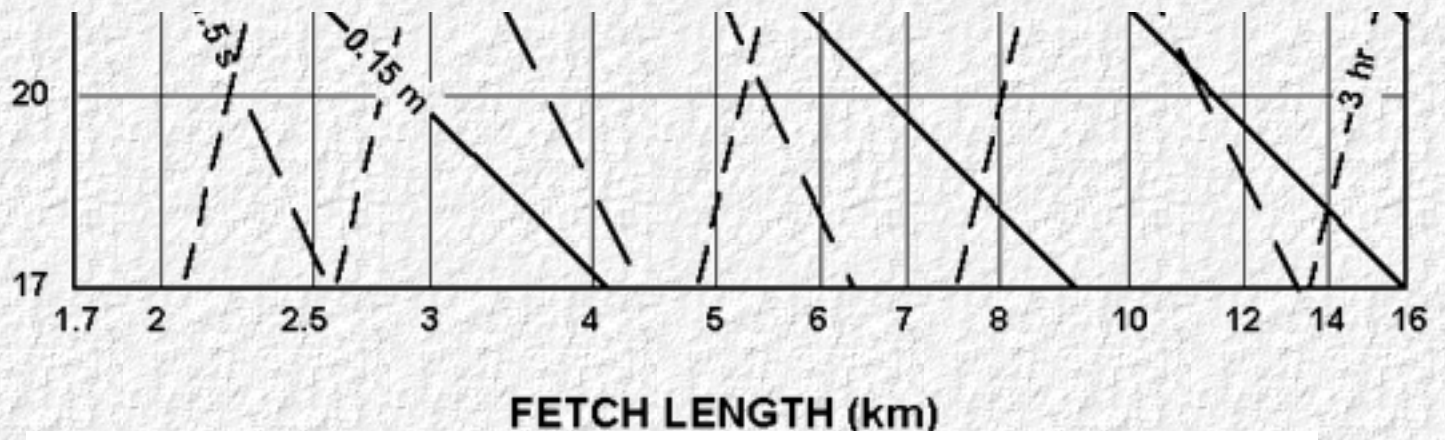

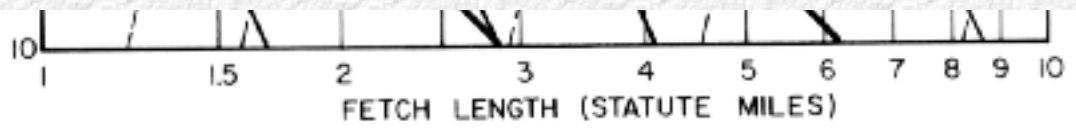

[Chart 5](#)

[Appendix C](#)

[Chart 7](#)

Chart 7. Hudson Relationship for Riprap Size Required to Resist Wave Erosion

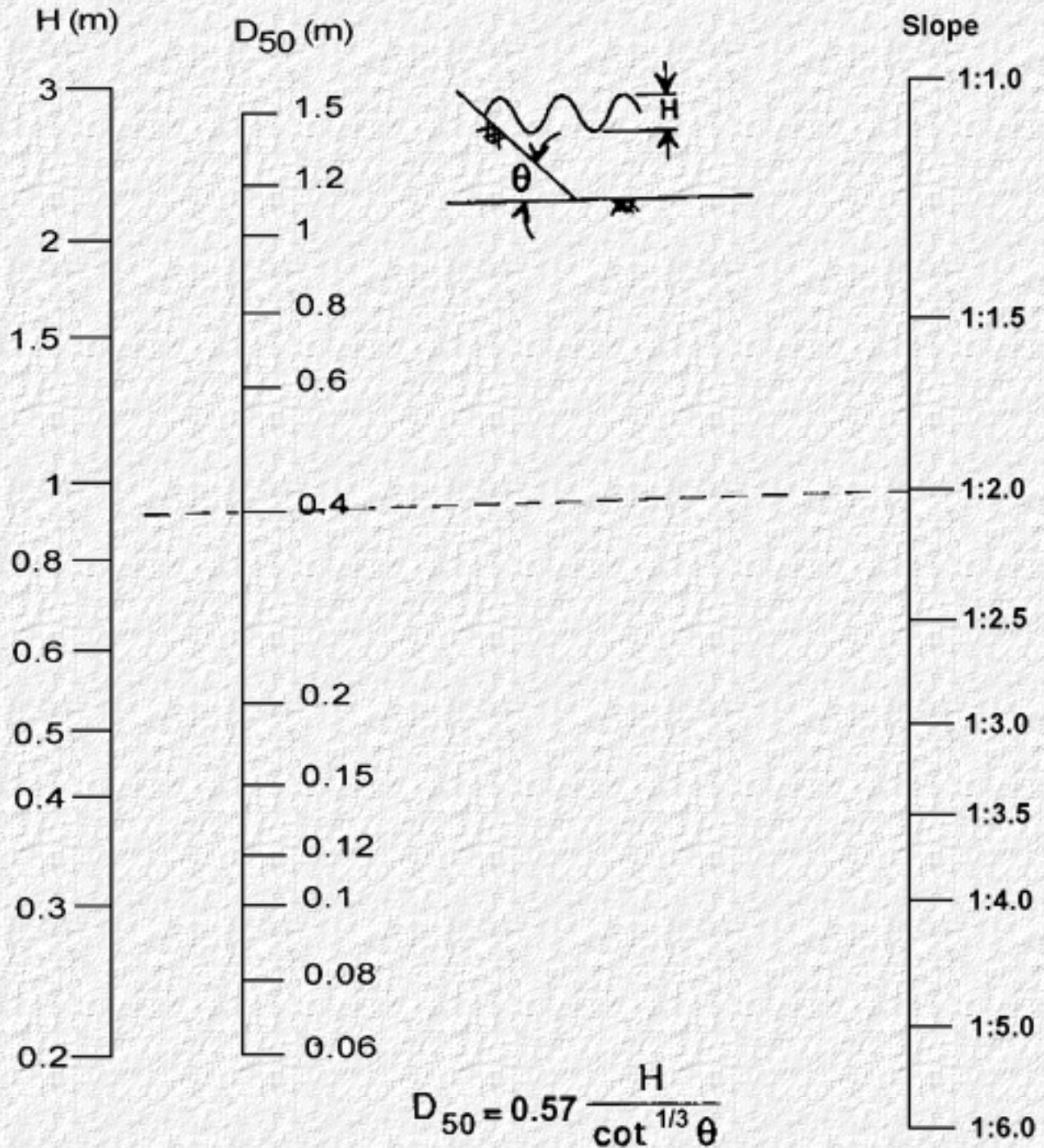

$$D_{50} = 0.57 \frac{H}{\cot^{1/3} \theta}$$

D_{50} = Median Riprap Size

H = Wave Height

θ = Bank Angle with Horizontal

Example

Given:

Slope = 1V:2H

H = 0.91 m

Find:

D_{50}

Solution:

$D_{50} = 0.4 \text{ m}$

[Chart 6](#)

[Appendix C](#)

[Chart 8](#)

Chart 8. Wave Run-up on Smooth, Impermeable Slopes (modified from reference 29)

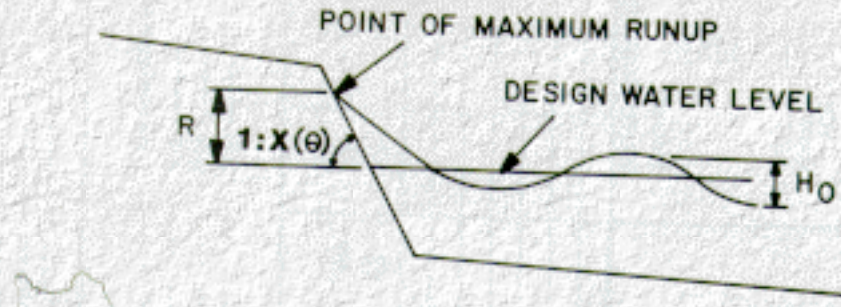

R = WAVE RUN UP HEIGHT (ft)
H₀ = WAVE HEIGHT (ft)
θ = BANK ANGLE WITH THE HORIZONTAL

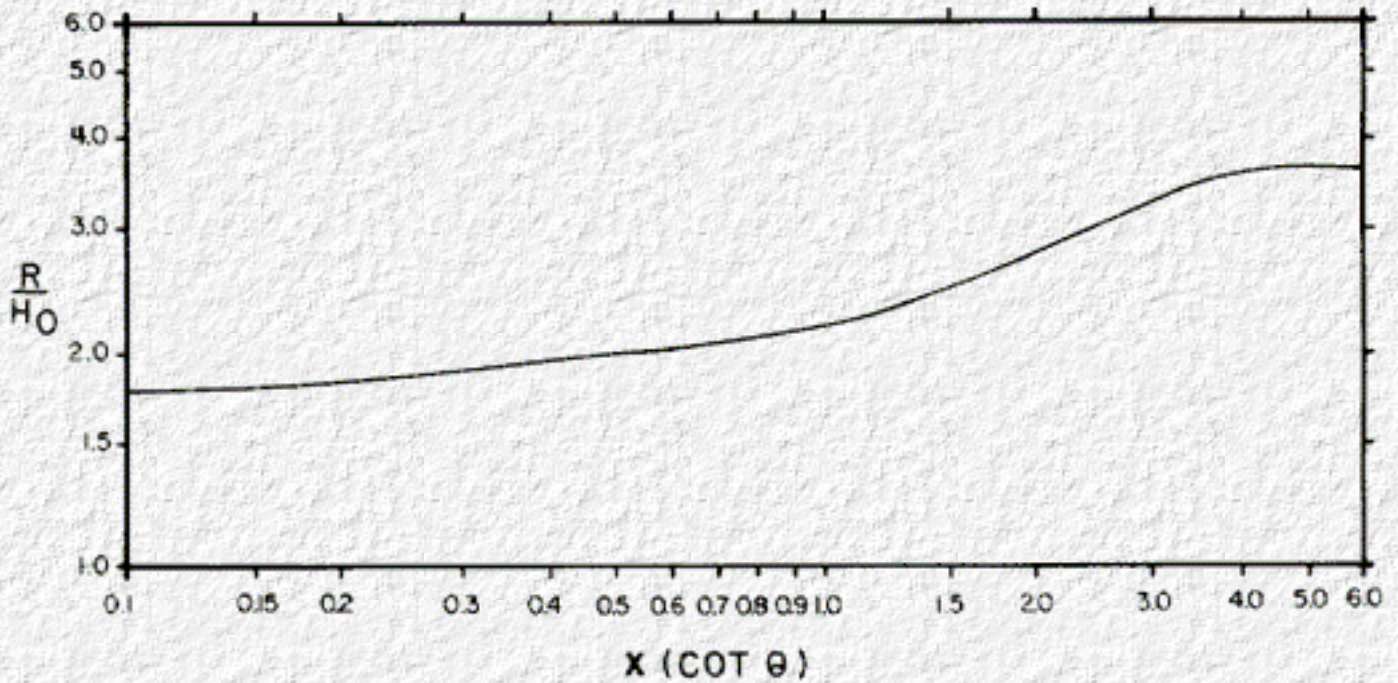

Table 9. Correction for Wave Run-Up

Slope Surface Characteristics	Placement Method	Correction factor
Concrete Pavement	--	1.00
Concrete Blocks (voids < 20%)	fitted	0.90
Concrete Blocks (20% < Voids > 40%)	fitted	0.70
Concrete Blocks (40% < Voids > 60%)	fitted	0.50
Gobi Blocks	fitted	0.85 - 0.90
Grass	--	0.85 - 0.90
Rock Riprap (angular)	random	0.60
Rock Riprap (round)	random	0.70
Rock Riprap (hand placed or keyed)	keyed	0.80
Grouted Rock	--	0.90
Wire enclosed rocks/Gabions	--	0.80

Form 2. Riprap Size-Wave Erosion

Project: _____ Description: _____	Prepared by date: _____ / _____ / _____ Checked by date: _____ / _____ / _____ Sheet _____ of _____
--------------------------------------	---

Wind Speed (mph)	Fetch (m)	H _b (m) ¹	e	R _v / H _o / 2	Corr. Factor ³	R _v (ft.) ⁴	D ₅₀ (ft.) ⁵

Riprap Size:
 D₅₀ _____ ft.
 Class _____

Revetment Thickness:
 2D₅₀ _____ ft.
 D₁₀₀ _____ ft.
 USE _____ ft.

1. Use Chart 6 or other method
2. Use Chart 9
3. See Table 9
4. 1,2,3
5. Use Chart 7

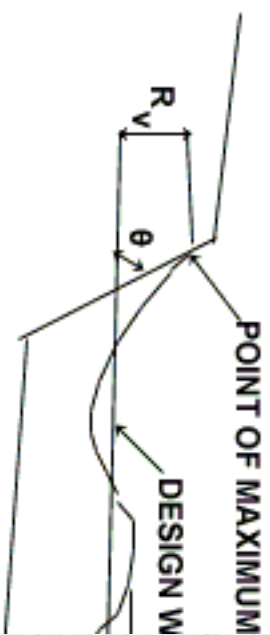

AASHTO GRADATION SIZE (ft.)	Percent Finer
_____	100
_____	50
_____	5-10

RUNUP

WATER LEVEL

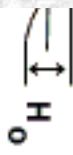

[Form 1](#)

[Appendix C](#)

[Form 3](#)

Form 3. Material Gradation

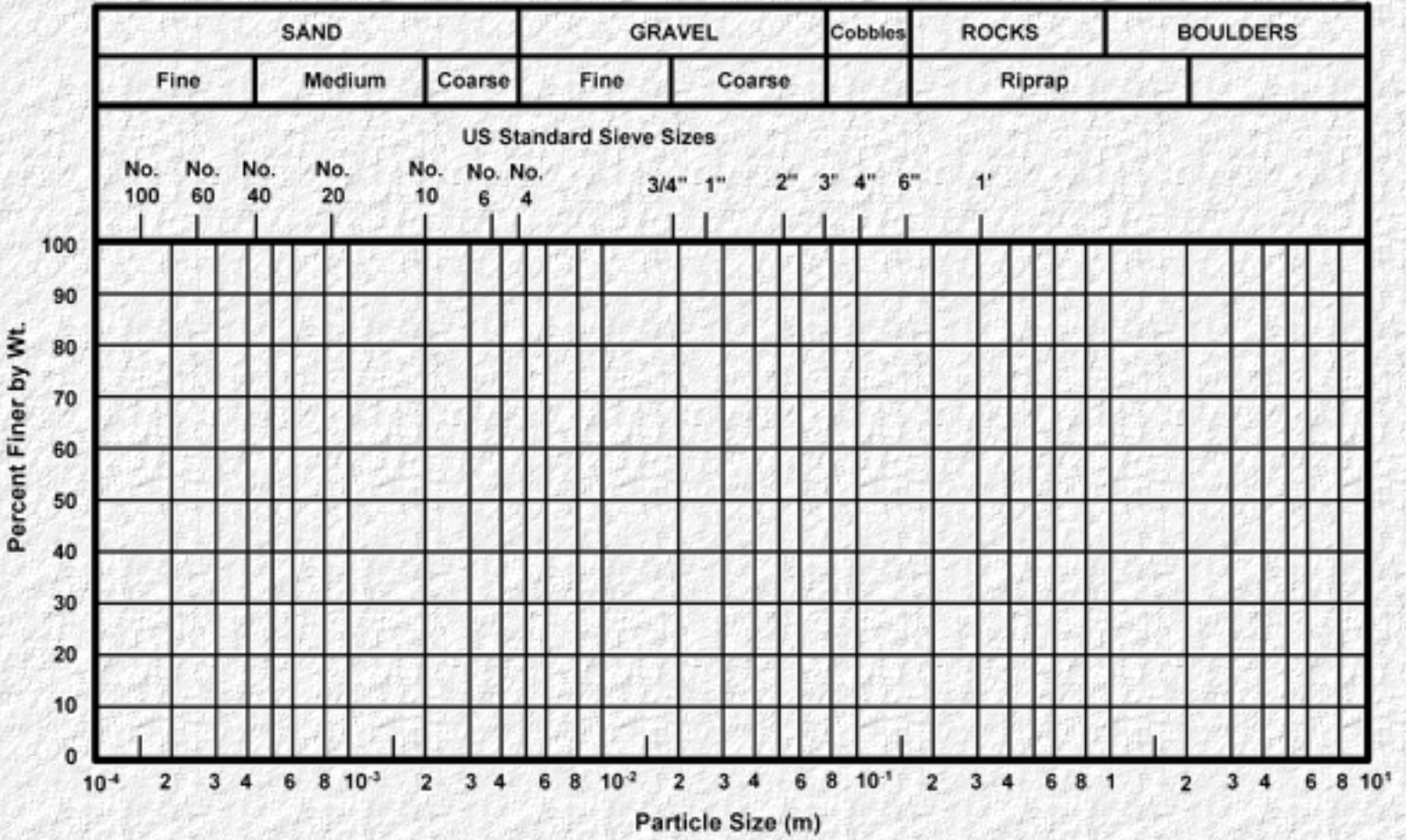

Form 4. Roughness Evaluation

PROJECT: _____ Prepared by/Date: _____
 DESCRIPTION: _____ Checked by Date: _____
 _____ Sheet _____

ADJUSTMENTS TO n

FACTOR	CONDITION DESCRIPTION	ADJUSTMEN
Base n, n _b ^(1,2)		
Irregularity, n _i ⁽²⁾		
Allignment, n _a ⁽²⁾		
Obstruction, n _o ⁽²⁾		
Vegetation, n _v ⁽²⁾		
Meander, m _m ⁽²⁾		
Weighted n plus adjustment (3)		
Use n		

(1) $n_b = [0.211(D_{50})^{0.5} / [0.333d_a]]$ For $1.5 < d_a / D_{50} < 35$
 $n_b = 0.0352 D_{50}^{0.167}$ For $35 < d_a / D_{50} < 30,000$
 $n_b = 0.039 S_f R^{-0.16}$ For Steep mountain Streams

(2) See Reference (17)
 (3) $n + m (n_1 + n_2 + n_3 + n_4)$



[Form 3](#)

[Appendix C](#)

[Form 5](#)

Form 5. Filter Design

Project: _____	Prepared by/ Date: _____ / _____
Description: _____	Checked by /Date _____ / _____
_____	Sheet _____ of _____

GRANULAR FILTER:

LAYER	DESCRIPTION	D ₁₅ ft.	D ₈₅ ft.	RATIO	$\frac{D_{15}^{Coarse}}{D_{85}^{Fine}}$	< 5 <	$\frac{D_{15}^{Coarse}}{D_{85}^{Fine}}$	< 40

SUMMARY:

LAYER DESCRIPTION	D ₁₅	D ₈₅	THICKNESS

FABRIC FILTER:

Physical Properties Class: _____

Hydraulic Properties

Piping Resistance < 50% Passing #200 AOS < 0.6 mm

<50% passing #200 AOS < 0.3 mm

Permeability Soil Permeability <Fabric Permeability

Selected Fabric Filter Specifications _____



[Form 4](#)

[Appendix C](#)



[Back to Table of Contents](#)



[Chart 1. Riprap Size Relationship](#)



[Chart 2. Correction Factor for Riprap Size](#)



[Chart 3. Bank Angle Correction Factor \(K1\) Nomograph](#)



[Chart 4. Angle of Repose of Riprap on Terms of Mean Size and Shape of Stone](#)



[Chart 5. Conversion from Equivalent D50 in meters to W50 in kg](#)



[Chart 6. Nomograph of Deepwater Significant Wave Height Prediction Curves \(modified from reference 29\)](#)



[Chart 7. Hudson Relationship for Riprap Size Required to Resist Wave Erosion](#)



[Chart 8. Wave Run-up on Smooth, Impermeable Slopes \(modified from reference 29\)](#)



[Form 1. Riprap Size-Particle Erosion](#)



[Form 2. Riprap Size-Wave Erosion](#)



[Form 3. Material Gradation](#)



[Form 4. Roughness Evaluation](#)



[Form 5. Filter Design](#)



[Back to Table of Contents](#)





[Back to Table of Contents](#)



[equation 1](#)



[equation 2](#)



[equation 3](#)



[equation 4](#)



[equation 5](#)



[equation 6](#)



[equation 7](#)



[equation 8](#)



[equation 9](#)



[equation 10](#)



[equation 11](#)



[equation 12](#)



[equation 13](#)



[equation 14](#)



[equation 15](#)



[equation 16](#)



[equation 17](#)



[equation 18](#)



[equation 19](#)



[equation 20](#)



[equation 21](#)



[equation 22](#)



[equation 23](#)



[equation 24](#)



[Back to Table of Contents](#)



GLOSSARY

- Angle of Repose** - The angle of slope formed by particulate material under the critical equilibrium condition of incipient sliding.
- Apparent Opening Size (AOS)** - A measure of the largest effective opening in a filter fabric or geotextile (sometimes referred to as engineering fabrics), as measured by the size of a glass bead where five percent or less by weight will pass through the fabric (formerly called the equivalent opening size, EOS).
- Composite Lining** - Combination of lining materials in a given cross section (i.e., riprap low-flow channel and vegetated upper banks).
- Depth of Flow** - The perpendicular distance from the bed of a channel to the water surface.
- Design Discharge** - Discharge at a specific location defined by an appropriate return period to be used for design purposes.
- Filter** - One or more layers of material placed below revetment to prevent soil piping and permit natural drainage.
- Filter, Granular** - A filter consisting of one or more layers of well-graded granular material.
- Filter, Fabric** - A filter consisting of one or more layers of permeable textile. Also referred to as geotextiles and engineering fabrics.
- Flexible Lining** - A channel lining material having the capacity to adjust to settlement; typically constructed of a porous material that allows infiltration and exfiltration.
- Flow, Critical** - Flow conditions at which the discharge is a maximum for a given specific energy, or at which the specific energy is minimum for a given discharge.
- Flow, Gradually Varied** - Flow in which the velocity or depth changes gradually along the length of the channel.
- Flow, Nonuniform** - Flow in which the velocity vector is not constant along every streamline.
- Flow, Rapidly Varied** - Flow in which the velocity or depth change rapidly along the length of the channel.

Flow, Steady	- Flow in which the velocity is constant in magnitude or direction with respect to time.
Flow, Subcritical	- Flow conditions below critical; usually defined as flow conditions having a Froude Number less than 1.
Flow, Supercritical	- Flow conditions above critical; usually defined as flow conditions having a Froude Number greater than 1.
Flow, Uniform	- Flow in which the velocity vector is constant along every streamline.
Flow, Unsteady	- Flow in which velocity changes in magnitude and direction with respect to time.
Flow, Varied	- Flow in which velocity or depth change along the length of the channel.
Freeboard	- Vertical distance from the top of the channel to the water surface at design condition.
Gabion	- Rectangular wire baskets filled with rocks used in the construction of a variety of erosion control structures. Also the name used for a number of these structures.
Geomorphology	- The study of the characteristics, origin, and development of land forms.
Hydraulic Radius	- Flow area divided by the wetted perimeter.
Hydraulic Resistance	- Resistance encountered by water as it moves through a channel, commonly described by a roughness coefficient such as Manning's n.
Incipient motion	- The condition that exists just prior to the movement of a particle within a flow field. Under this condition, any increase in any of the factors responsible for particle movement will cause motion.
Meander	- One curved portion of a sinuous or winding stream channel, consisting of two consecutive loops, one turning clockwise, and the other counterclockwise.
Median Diameter	- The midpoint in the size distribution of sediment such that half the weight of the material is composed of particles larger than the median diameter and half is composed of particles smaller than the median diameter.

Normal Depth	- The depth of a uniform channel flow.
Permeability	- The property of a material or substance which describes the degree to which the material is penetrable by liquids or gases. Also, the measure of this property.
Rigid Lining	- A lining material with no capacity to adjust to settlement; these lining materials are usually constructed of non-porous material.
Revetment	- A channel bank lining designed to prevent or halt bank erosion.
Revetment Toe	- The lower terminus of a revetment blanket; the base or foundation of a revetment.
Riprap	- A well-graded mass of durable stone, or other material that is specifically designed to provide protection from flow induced erosion.
Riprap, Dumped	- Consists of riprap placed by dumping
Riprap, Grouted	- Consists of riprap with all or part of the interstices filled with portland cement mortar to form a rigid lining.
Riprap, Wire-Enclosed	- Consists of wire baskets filled with stone, connected together and anchored to the channel bottom or sides.
Rock Windrow	- An erosion control technique that consists of burying or piling a sufficient supply of erosion-resistant material below or on the existing land surface along the bank, then permitting the area between the natural riverbank and the rock to erode until the erosion reaches and undercuts the supply of rock.
Rubble	- Broken fragments of rock or debris resulting from the decay or destruction of a building.
Shear Stress	- The force developed on the wetted area of the channel that acts in the direction of the flow, usually measured as a force per unit wetted area.
Shear Stress, Channel	- The average shear stress occurring in a channel section for a given set of hydraulic conditions.

Shear Stress, Permissible	- Shear stress at which the channel lining will fail.
Side Slope	- Slope of the sides of a channel; usually referred to by giving the horizontal distance followed by the vertical distance. For example, 1.5 to 1, or 1.5 : 1.0, meaning a horizontal distance of 1.5 feet (.46 m) to a 1 foot (.3 m) vertical distance.
Sieve Diameter	- The size of sieve opening through which the given particle will just pass.
Soil Piping	- The process by which soil particles are washed in or through pore spaces in filters.
Standing Waves	- Curved symmetrically shaped waves on the water surface and on the channel bottom that are virtually stationary.
Superelevation	- Local increases in water surface on the outside of a bend.
Thalweg	- Line following the deepest part of a streambed or channel.
Traction Force	- Force developed at the channel bed as a result of the resistance to flow created by the channel section. This force acts in the direction of flow, and is equal to the shear stress on the channel section multiplied by the wetted perimeter.
Uniform Flow	- The flow condition where the rate of head loss due to friction is equal to bed slope of the channel.
Velocity	- A measure of the speed of a moving substance or particle given in feet per second (m/s).
Velocity, Mean	- In hydraulics, the discharge divided by the cross sectional area of the flowing water.
Velocity, Permissible	- The velocity which will not cause serious erosion of the channel lining material.
Wave Runup	- The movement of water up a channel bank as a result of the breaking of a wave at the bank line; The extent and magnitude of the wave runup is a function of the energy in the wave.
Wave Downrun	- The down slope flow of water experienced immediately following a wave runup as the water flows back to the normal water elevation.

References

- 1. Shen, H. W. et al.,**
"Methods for Assessment of Stream-Related Hazards to Highways and Bridges,"
U.S. Department of Transportation, Federal Highway Administration, FHWA/RD-80/160, Washington, D.C., March 1981.
- 2. Leopold, L.B. et al.,**
Fluvial Processes in Geomorphology,
W. H. Freeman and Company, San Francisco, 1964.
- 3. Lane, E.W.,**
"Design of Stable Channels,"
Transactions, ASCE, Vol. 12, 1955.
- 4. Brown, S.A. et al.,**
"Stream Channel Degradation and Aggradation: Analysis of Impacts to Highway Crossings,"
U.S. Department of Transportation, Federal Highway Administration, FHWA/RD-80/159, Washington, D.C., March 1981.
- 5. Richardson, E.V. et al.,**
"Highways in the River Environment, Hydraulic and Environmental Design Considerations,"
prepared for Federal Highway Administration, National Highway Institute,
Office of Research and Development, Office of Engineering, September 1974.
- 6. Blodgett J.C., and McConaughy, C.E.,**
"Evaluation of Riprap Design Practices," Volume 2 of "Rock Riprap Design for Protection of Channels Near Highway Structures,"
U.S. Geological Survey, Water-Resources Investigations, Report 86-4128,
Prepared in cooperation with the Federal Highway Administration, 1986.
- 7. Masch, Frank D.,**
"Hydrology", HEC No. 19,
U.S. Department of Transportation, Federal Highway Administration, Washington, D.C., 1984.
- 8. Corry, M. L., Jones, J.S., and Thompson, P.L.,**
"Design of Encroachments of Flood Plains Using Risk Analysis", HEC No. 17,
U.S. Department of Transportation, Federal Highway Administration, Washington, D.C., 1981.
- 9. Chow, V.T.,**
Open-Channel Hydraulics,
McGraw-Hill, New York, 1959.
- 10. Simons, Daryl B., and Senturk, Fuat,**
Sediment Transport Technology,
Water Resources Publications, Fort Collins, Colorado, 1977.
- 11. U.S. Department of Agriculture**
Soil Conservation Service - Engineering Division, National Engineering Handbook - Section 5 - Hydraulics,
U.S. Department of Commerce National Technical Information Service
- 12. Richardson, E.V., Simons, D.B. et al.,**
"Highways in the River Environment, Hydraulic and Environmental Design Considerations,"
Prepared for Federal Highway Administration, National Highway Institute,
Office of Research and Development, Office of Engineering, September 1974.
- 13. Jarrett, R.D.,**
"Hydraulics of High-Gradient Streams,"
Journal of the Hydraulics division, ASCE, Vol. 110, No. 11, November 1984.

- 14. U.S. Army Corps of Engineers,**
"Hydraulic Design of Flood Control Channels,"
Engineers Manual EM-1110-2-1601.
- 15. Blodgett, J.C.**
"Hydraulic Characteristics of Natural Open Channels," Volume 1 of "Rock Riprap design for Protection of Stream Channels Near Highway Structures,"
U.S. Geological Survey, Water-Resources Investigations Report 86-4127,
prepared in cooperation with the Federal Highway Administration, 1986.
- 16. "Methods and Practices of the Geological Survey",**
U.S. Government Printing Office, Washington, D.C., 1943.
- 17. Arcement, G. J., and Schneider, V. R.,**
"Guide for Selecting Manning's Roughness Coefficients for Natural Channels and Flood Plains,"
FHWA-TS-84- 204, U.S. Department of Transportation, Federal Highway Administration, Washington, D.C., April 1984.
- 18. Brown, Scott A.**
"Streambank Stabilization Measures for Highway Engineers,"
U.S. Department of Transportation, Federal Highway Administration, FHWA/RD-84/100, July 1985.
(Available through National Technical Information Service, Springfield, VA 22161)
- 19. California Department of Public Works, Division of Highways,**
"Bank and Shore Protection in California Highway Practice," 1970.
- 20. U.S. Army Corps of Engineers,**
"Design of Coastal Revetments, Seawalls, and Bulkheads,"
Engineering Manual EM-1110-2-1614, April 1985.
- 21. Shields, A.,**
"Anwendung der Aehnlichkeits-Mechanik und der Turbulenzforschung auf die Geschiebebewegung, "
Preussische Versuchsanstalt fur Wasserbau und Schiffbau, Berlin, Germany, 1936.
- 22. Gessler, J.**
"Beginning and Ceasing of Sediment Motion," in River Mechanics,
Hsieh Wen Shen, ed., P.O. Box 606, Fort Collins, Colorado, 1971.
- 23. Brown, S. A.,**
"Calibration of a Riprap Design Method,"
Summary Report, Sutron Corporation Report No. SCR87-0001,
Federal Highway Administration Open File Report, Washington, D.C. 1987.
- 24. Hudson, R.Y.,**
"Laboratory Investigations of Rubble-Mound Breakwaters,"
Proceedings of the Waterways and Harbors Division, American Society of Civil Engineers, Vol. 85, No. WW3, 1959.
- 25. U.S. Army Corps of Engineers,**
"The Streambank Erosion Control Evaluation and Demonstration Act of 1974, Section 32, Public Law 93-251: Final Report to Congress,"
Main report and Appendices A through H, December 1981.
- 26. Christopher, Barry R., and Holtz, Robert D.,**
"Geotextile Engineering Manual,"
Prepared for the Federal Highway Administration, National Highway Institute, Washington, D.C., March 1985.
- 27. Galloway, B.M.,**
"Pavement and Geometric Design Criteria for Minimizing Hydroplaning,"
Texas Transportation Institute, Texas A&M University,
Prepared for the Federal Highway Administration, Report No. FHWA-RD-30, December 1979.
- 28. Chen, Y.H., and Cotton, G.K.,**

"Design of roadside Channels with Flexible Linings,"
Hydraulic Engineering Circular No. 15,
Prepared for the Federal Highway Administration, Washington, D.C., 1987.

29. Department of the Army,

"Shore Protection Manual",

Coastal Engineering Research Center, Waterways Experiment Station, Vicksburg, Mississippi, Fourth Edition, 1984.
(Available from the Superintendent of Documents, U.S. Printing Office, Washington, D.C.)

30. Standard Specifications for Highway Bridges,

American Association of State Highway and Transportation Officials, 13th edition, Washington, D.C., 1983.

31. Land slides: Analysis and Control Special Report 176 (1978)

Transportation Research Board National Academy of Sciences.

32. Department of the Army, Corps of Engineers,

Investigation of Filter Requirements for Underdrains, Waterways Experiment Station, Tech. Memo No. 183-1, Vicksburg, Miss., December 1941.

33. Anderson, A.G., Paintal, A.S., Davenport, J.T.,

"Tentative Design Procedure for Riprap Lined Channels,"

Highway Research Board, NCHRP Report Number 108, 1970.

34. Barnes, Harry H., Jr.,

"Roughness Characteristics of Natural Channels",

Geological Survey Water-Supply Paper, U.S. Department of the Interior, 1849.

35. Maynard, Stephen T.,

"Stable Riprap Size for Open Channel Flows,"

Dissertation submitted in partial fulfillment of the requirements for the degree of Doctor of Philosophy, Colorado State University, Fort Collins, Colorado, Summer 1987.

36. Wang, S.Y., Shen, H.W.,

"Incipient Sediment Motion and Riprap Design,"

Journal of the Hydraulics Division, ASCE, Vol. 111, No. 3, March 1985.

37. U.S. Department of Transportation,

"Design Charts for Open-Channel Flow," Hydraulic Design Series No. 3,

Federal Highway Administration, August 1961, reprinted November 1977.

38. FHWA/USGS Bridge Waterways Analysis Model: Research Report No. FHWA-RD-86- 108,

Washington D.C., 1986. Unpublished draft users manual for WSPRO.

39. Hydrologic Engineering Center,

HEC-2, Water Surface Profiles,

November 1976, Davis, CA

40. Bradley, Joseph N.,

"Hydraulics of Bridge Waterways,"

Hydraulic Design Series No.1, Federal Highway Administration, Second Edition, March 1978.

Appendix D References : Hec-11

1. Chow, V.T.,

Open-channel hydraulics,

McGraw-Hill, New York, 1959.

2. Shields, A.,

"Anwendung der Aehnlichkeits-Mechanik und der Turbulenzforschung auf die Geschiebebewegung,"

Preussische Versuchsanstalt fur Wasserbau und Schiffbau, Berlin, Germany, 1936.

3. Blodgett, J.C.,

"Hydraulic Characteristics of Natural Open Channels," Volume 1 of "Rock Riprap Design for Protection of Stream Channels Near Highway Structures,"

U.S. Geological Survey Water-Resources Investigation Report 86-4127,
Prepared in cooperation with the Federal Highway Administration, 1986.

4. Anderson, A.G., Paintal, A.S., and Davenport, J.T.,

"Tentative Design Procedure for Riprap-lined Channels"

National Cooperative Highway Research Program Report 108, Highway Research Board, 1970.

5. Strickler, Alfred,

"Some Contributions to the Problem of the Velocity Formula and Roughness Factors for Rivers, Canals, and Closed Conduits,"
Bern, Switzerland, Mitt. Eidgeno Assischen Amtes Wasserwirtschaft, 1923.

6. Norman, J.M.,

"Design of Stable Channels with Flexible Linings,"

U.S. Department of Transportation, Federal Highway Administration, Hydraulic Engineering Circular No. 15, 1975.

7. Maynard, S.T.,

"Practical Riprap Design,"

Miscellaneous Paper H-78-7, Hydraulics Laboratory,

U.S. Army Engineer Waterways Experiment Station, Vicksburg, Miss., 1978.

8. Blodgett, J.C., and McConaughy, C.E.,

"Evaluation of Riprap Design Procedures," Volume 2 of "Rock Riprap Design for Protection of Stream Channels Near Highway Structures,"

U.S. Geological Survey Water-Resources Investigation Report 86-4128
Prepared in cooperation with the Federal Highway Administration, 1986.

Symbols

[A](#), [C](#), [D](#), [G](#), [H](#), [K](#), [N](#), [P](#), [Q](#), [R](#), [S](#), [T](#), [V](#), [W](#), [Z](#), [MISC.](#)

To jump to a specific part of the alphabet, click on the above HotLinks!

Click the Back button to return to the top of this page.

(If the letter you are looking for does not appear in the HotLink list below, then there are no glossary entries for that letter!)

A

A = Flow area m^2

C

C = Coefficient that relates free vortex motion to velocity streamlines for unequal radius of curvature.

D

d_a = The average channel flow depth (m).

D_{50} = The median bed material size (m).

D_{15} = The fifteen (15) percent finer particle size (m).

D_{85} = the 85 percent finer particle size (m).

G

g = Gravitational acceleration (m/s^2).

H

H = The wave height (m).

K

K_1 = A correction term reflecting bank angle.

N

n = Manning's roughness coefficient.

n_c = Composite roughness.

n_1 = The roughness of the smoother lining in composite roughness evaluation.

n_2 = Roughness of rougher lining in composite roughness evaluation.

P

P = Total wetted perimeter of channel section.

P_{mc} = Wetted perimeter of channel bottom in the zone of main channel flow.

Q

Q_{mc} = Discharge in the zone of main channel flow (m^3/s).

Q_s = The sediment discharge.

R

R = The hydraulic radius (m).

R_o = The mean radius of the channel centerline at the bend (m).

S

S_f, S = Friction slope or energy grade line slope.

SF = The stability factor.

SP = The Shield's parameter.

S_s = The specific gravity of the riprap (solid) material

T

T = The topwidth of the channel between its banks (m).

V

V_a = Mean channel velocity (m/s).

W

W_{50} = The weight of the median particle (lb N)).

Z

Z = Superelevation of the water surface (m).

MISC.

γ = The unit weight of water (9807 N/m^3).

γ_s = The unit weight of the riprap (solid) material (N/m^3).

θ = The bank angle with the horizontal.

τ_d = The driving shear stress (N/m^2).

τ_r = The resisting shear stress (N/m^2).

ϕ = The riprap materials angle of repose.