

NATIONAL ACCIDENT SAMPLING SYSTEM

DATA COLLECTION, CODING AND EDITING MANUAL
1984 CONTINUOUS SAMPLING SYSTEM

VERSION NUMBER 7



U.S. DEPARTMENT OF TRANSPORTATION
NATIONAL HIGHWAY TRAFFIC SAFETY ADMINISTRATION
WASHINGTON, D.C. 20590

DECEMBER 1983

ACKNOWLEDGMENT

NASS DATA COLLECTION, CODING AND EDITING MANUAL

The first edition (Pilot Study-1978) of this manual was originally developed by Indiana University under a contract sponsored by the National Highway Traffic Safety Administration. The work was performed under the direction of staff at the National Center for Statistics and Analysis (NCSA).

The second and third editions (1979 and 1980 calendar year versions) of this manual were developed by Indiana University and Calspan Corporation in consultation with NASS staff at the NCSA. Final illustrations, editing, and production of camera ready copies were performed at Indiana University.

The fourth, fifth and sixth editions (the 1981, 1982 and 1983 calendar year versions) and the current edition (the 1984 calendar year version) were collaborated productions by the NASS Zone Centers: Indiana University, Calspan Corporation, Southwest Research Institute and Dynamic Science, Inc. The work was performed under the direction of NASS staff at the NCSA. Final illustrations, editing, and production of camera ready copies were performed at Indiana University.

The production of this and previous editions of the NASS Data Collection, Coding and Editing Manual could not have been made possible without contributions from many unidentified sources within the U.S. Department of Transportation, the NASS Zone Centers and PSU teams, and the transportation community.

TABLE OF CONTENTS

	<u>Page</u>
1.0 INTRODUCTION	1
1.1 Purpose of the Manual.	1
1.2 Overview	1
1.3 How to Use This Manual	2
2.0 DESCRIPTION OF THE SAMPLING FRAME.	5
2.1 Accidents Which Qualify for Study.	5
2.1.1 Common Questions and Answers About Incidents Which Qualify for Study19
2.2 Classifying the Accident by Type, Severity, Tow Status, and Disposition of the Injured21
2.2.1 Continuous Sampling System (CSS) and Nontowaway Study (NTS) Samples23
2.2.2 Common Questions and Answers Regarding Stratification24
3.0 OVERVIEW OF SAMPLING ACTIVITIES.27
3.1 Listing and Sampling Forms27
3.1.1 Case Load Assignment Sheet (CLAS)27
3.1.2 Case Load Worksheet (CLW)30
3.1.3 Stratification Record30
3.1.4 Accident Sampling Worksheet (SW).30
3.1.5 Sample Selection Within Stratum/Jurisdiction Form (SSSJ).30
3.2 Listing and Sampling Instructions.30
3.2.1 Contacting Police Jurisdictions30
3.2.2 Completing the Stratification Record.39
3.2.3 The NASS Automated Case Selection System.40
3.2.4 Completing the Worksheets41
3.3 Sampling Problems: How to Handle Them46
3.4 Beginning of Year Sampling Instructions.49
4.0 OVERVIEW OF INFORMATION TO BE COLLECTED ON CASES SAMPLED50
4.1 Sequencing of Case Materials50
4.2 Information Required on Field Forms (Mandatory Variables).52
4.3 Update Procedures for Hardcopy Field Forms53
4.4 Form Logs.55
4.4.1 Accident Log55
4.4.2 Pedestrian and Nonmotorist Log57
4.4.3 Non-Towaway Vehicle Log58
4.4.4 Vehicle Log58
4.4.5 Driver Log.59
4.4.6 Occupant Log.61
4.5 NASS Criteria for Acceptable Data Completion62
4.6 Special Procedures for Strata "Y" & "Z" Accidents.63
4.6.1 Procedure for Vehicle(s) in Case Strata "Y" & "Z"63
4.6.2 Procedure for Scene Reconstruction in Case Strata "Y" & "Z"63
4.6.3 Vehicles Not Affected by Procedures for Strata "Y" or "Z"65
4.6.4 Usage of Other NASS Forms in Nontowaway Strata "Y" or "Z"65
4.6.5 Selection of Vehicle Form and Scene Procedures When Towaway Status on Police Report Is Not Indicated or In Error.65
4.6.6 Interface with Special Studies.66

TABLE OF CONTENTS (continued)

	<u>Page</u>
5.0 SUBMISSION INSTRUCTIONS.67
5.1 Quality Control Checks for PSU Teams67
5.1.1 Quality Control Checks Prior to Remote Data Entry67
5.1.2 Quality Control Checks Resulting from Remote Data Entry68
5.1.3 Check to Make Sure Administrative Procedures are Being Followed.68
5.1.4 Check Sampling Procedures68
5.1.5 Check Data Collection Procedures.68
5.1.6 Check to Make Sure Updates Are Being Processed Properly68
5.1.7 Check Individual Effort and Accuracy in Collecting Evidence and Skill in Interpretation.68
5.2 Case Submission.68
5.3 Case Dropping Procedures71
6.0 CODING INSTRUCTIONS.73
Accident Form	
Pedestrian and Nonmotorist Form	
Vehicle Form (Vehicle for Non-Towaway Accident Form)	
Driver Form	
Occupant Form	
APPENDICES - Uniform Symbols for Scene Marking	
Uniform Symbols for Accident Diagramming	
Photography Instruction	

NASS DATA COLLECTION, CODING AND EDITING MANUAL

1.0 INTRODUCTION

1.1 Purpose of the Manual

In order to produce a national traffic accident data base for the evaluation of old and the development of new highway and vehicle safety standards and to identify highway safety needs, the National Accident Sampling System is being developed. Part of the final system will consist of 75 small teams of accident investigators situated throughout the 48 contiguous states and Hawaii. At each site (Primary Sampling Unit - PSU), the accident research team will investigate a probability sample of police reported accidents on a continuous basis (Continuous Sampling System - CSS). In addition, provision has been made for short term special studies (Special Studies Subsystem - SSS), ancillary studies and the study of minor and non-police reported accidents.

Zone Centers have been established to provide for the quality control of the CSS and special study data collected. Quality control is carried out through Zone Center site visits to the PSUs and through the review of accident case report materials received at the Zone Center. The Zone Centers provide quality control in the areas of sampling, completeness of data, reliability and validity of data. In addition, the Zone Centers provide data collection forms, coding manuals, annual team evaluations, training, extra PSU staff (when needed), and act as a communication link between the PSU teams and the NASS sampling and data processing contractors.

The purpose of this manual is to provide PSU team members, Zone Centers, the data processing contractor, sampling contractor, training contractors, and the National Center for Statistics and Analysis with a consistent, standardized set of instructions for sampling accidents and collecting, coding and editing the data.

1.2 Overview

The manual includes six substantive sections; each is summarized below.

Section 2.0 Description of the Sampling Frame describes the procedure for determining whether or not the incident reported on a police accident report (PAR) qualifies for inclusion in the study. In addition, the four independent variables by which one stratifies the accidents which qualify for study are explained. The two samples of NASS accidents, CSS and Nontowaway Study, are discussed.

Section 3.0 Overview of Sampling Activities describes the procedures for compiling the sampling frame list and selecting the accidents to be investigated. The twenty-two (22) strata into which the accidents are classified are defined in terms of the values of the four independent variables. Discussed are both the NASS Automated Case Selection System and the manual backup method, as well as the circumstances under which the manual procedures are to be used.

Section 4.0 Overview of Information to be Collected on Sampled Accidents describes the forms which are to be filled out on each accident, the different records (e.g., injury records), photographs and other information (e.g., crash runs), which make up a completed case report. Also discussed are the mandatory data items and forms which must be filled out before a case can qualify for submission. Procedures for filling out form logs are described. In addition, the NASS criteria for acceptable data completion are presented. Finally, the special procedures for handling Nontowaway Study accidents (strata "Y" & "Z") are included.

Section 5.0 Submission Instructions describes when and where to submit case reports. It also describes the Quality Control procedures to be used at the PSU sites.

Section 6.0 Coding Instructions provides the general instructions for collecting and coding the data called for in the field forms. Documentation for each data element includes variable name, element values (attributes), definitions where needed, data sources, collection method, reference materials (if needed), and remarks.

The Appendices contain some of the necessary references, including: (1) the Uniform Symbols for Scene Marking, (2) the Uniform Symbols for Accident Diagramming, and (3) the Photography Instructions.

Other references to be used in NASS not contained in this manual include: (1) the Third Edition of ANSI D16.1-1976, ANSI D6.1-1978; (2) the CRASH3 User's Manual; (3) SAE J224 MAR80; (4) Truck Deformation Classification (TDC) - SAE J1301; (5) the 1983 NASS Injury Coding Manual; (6) NATB books (see section 6.3, variable V61); (7) Passenger Car and Truck Investigators Manual (see section 6.3, variable V61); (8) the Branham Automobile Reference Book; (9) Diesel and Gasoline Truck Indices; (10) the Branham Motorcycle and Snowmobile Booklet; (11) the MVMA - Passenger Car Specifications (see section 6.3, variable V75); (12) Remote Data Entry System User's Manual; (13) NASS Automated Case Selection System User's Manual; (14) the NASS Accident Investigation Procedures Manual; (15) the Luminaire and Sign Support Special Study Coding and Field Procedures Manual; (16) the Longitudinal Barrier Special Study Coding and Field Procedures Manual; and, (17) the Crash Cushion Special Study Coding and Field Procedures Manual.

1.3 How to Use This Manual

This manual is designed to be updated periodically without the need for replacing the entire document. This will be accomplished via a system for adding, deleting, and changing pages. Additions will be inserted in their proper location and will be identified by a different month and year. Pages which are changed will have the same month and year identifier. Periodically, a NASS Data Collection, Coding and Editing Manual Update Directory will be printed and sent to each PSU team and Zone Center. This manual will indicate the date of the latest version of each page. It is important that all manuals be kept up-to-date and that the update directory is displayed in a place that provides easy access.

When potential data encoding problems are detected in the NASS Data Collection, Coding and Editing Manual or interpretations of specific circumstances (including NASS definitions) are required, the following procedures, outlined by NCSA, will be followed:

- (a) Potential problems that are identified at the team level will be sent to the cognizant Zone Center via the NASS message system.
- (b) The Zone Center will review the potential problem.
 - (1) If it is a misinterpretation of the manual, a clarification will be provided by the cognizant Zone Center via the NASS message system (with a telephone follow-up, if necessary).
 - (2) If the potential problem is determined to be valid, the cognizant Zone Center will broadcast the potential problem with a recommended solution to the other three (3) Zone Centers for review and concurrence. The final recommended solution will be sent to NCSA by the cognizant Zone Center for review and approval. This includes all additions, deletions, modifications or substantive interpretations that redefine, broaden or narrow the established definition of NASS variables or attributes.
- (c) Changes or interpretations which affect field data encoding and are approved by the NCSA will be given an effective implementation date and sent to Indiana University for inclusion in the NASS Coding Manual.

The above procedures were not established to restrict team or Zone Center operations but to ensure that program objectives and goals are not inadvertently changed (i.e., a variable is redefined beyond its intended purpose). When defining variables, NCSA must consider their operational utility within the restrictions of the data collection time frame and their intended purpose. Any diversions from these established procedures may destroy the data validity and/or result in serious analysis problems.

2.0 DESCRIPTION OF THE SAMPLING FRAME

2.1 Accidents Which Qualify for Study

The procedures for properly developing the list of motor vehicle accidents within the study area which qualify for investigation are shown in Figure 2-1 and described below.

Start with a Police Reported Incident--All incidents which meet the criteria of a motor vehicle accident, as defined in ANSI D16.1-1976 (section 2.3.20, page 10), and are (a) reported on the State accident form, or on local (surrogate) accident forms, (b) signed by a police officer, and (c) available through the police agency files, are to be considered for study. Other accident report forms, such as special driver report forms, that do not meet the requirements above are excluded from consideration.

Must Be Reported to the State--For an incident to qualify for the study, the police jurisdiction must send a copy of the Police Accident Report (PAR) to the State for inclusion in the State accident statistics. If a report will not be included in the state file, then the incident is not to be included in the list. If the investigator cannot determine whether or not an incident will be reported to the State, then he/she should include it in the list.

Must Involve a Harmful Event--If the incident does not involve property damage and/or personal injury, do not include it in the list. The presence of a Police Accident Report (PAR) creates a rebuttable presumption that a harmful event has occurred. It is the duty of the investigator to scrutinize any PAR which alleges the absence of a harmful event.

The Harmful Event Must Have Occurred as a Result of an Accident--An accident involves at least one harmful event (ANSI D16.1-1976, section 2.3.3, page 8) produced by an unstabilized situation (ANSI D16.1-1976, section 2.3.4, page 8). There are four (4) ways in which a harmful event occurs that is not a result of an accident. They are: (a) the harmful event results from a diseased condition, (b) the unstabilized situation was the result of deliberate intent, (c) the unstabilized situation was the result of legal intervention, or (d) the harmful event results from a cataclysm (ANSI D16.1-1976, section 2.3.5, page 8). To further clarify the meaning of each of these "intervening circumstances", consider the examples below.

Disease: Even if the unstabilized situation is initiated by a disease such as cerebral hemorrhage, heart attack, diabetic coma, or epileptic seizure, which affects the driver of a motor vehicle in transport, any subsequent harmful event which occurs is considered an accident. This includes any nonvehicular damage that this vehicle causes. The disease itself is not a harmful event for our classification as a traffic accident.

Deliberate Intent: A harmful event which has been intentionally produced does not fall within the definition of an unstabilized situation and, thus, is not an accident.

FIGURE 2-1

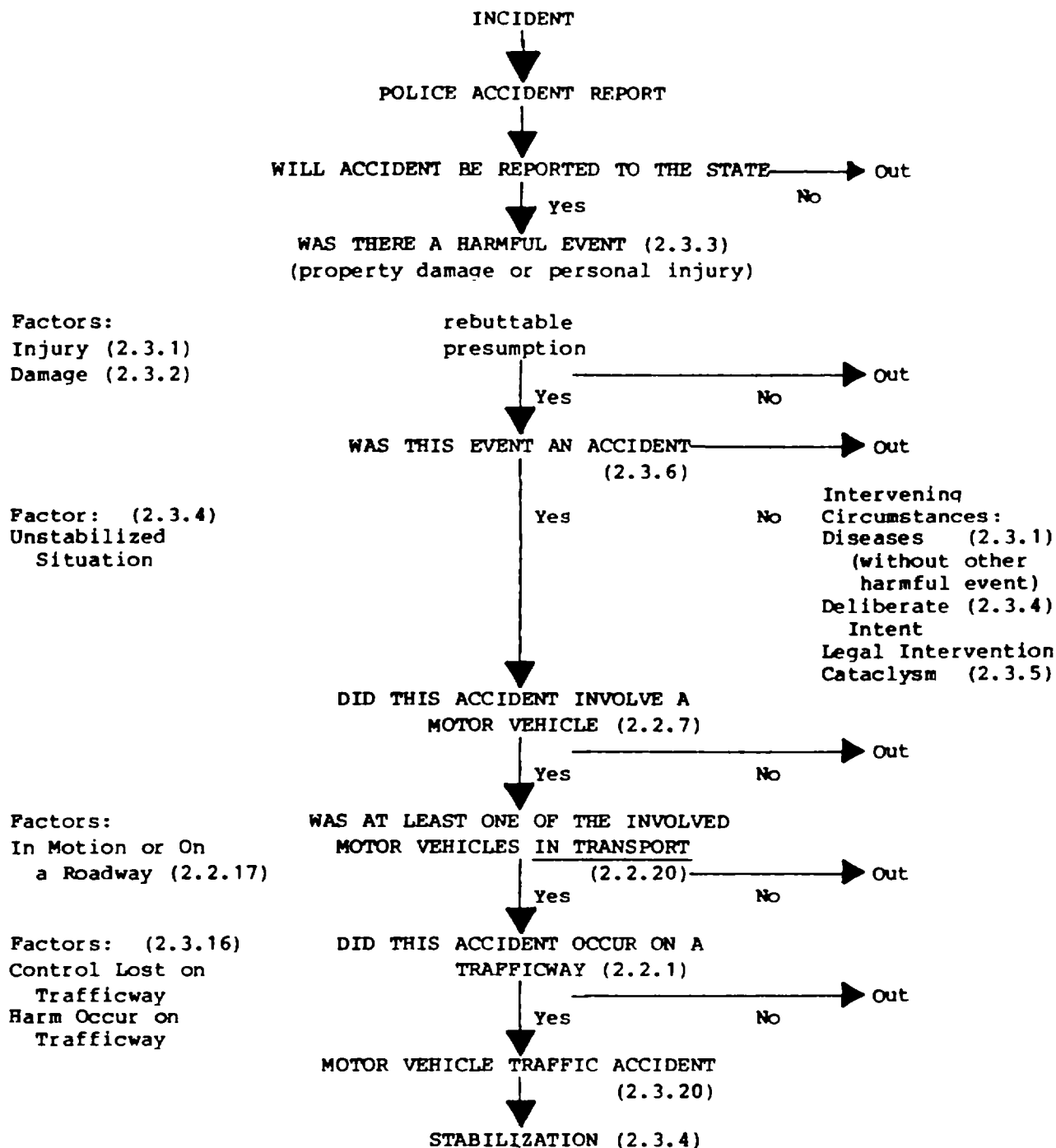

A motor vehicle traffic accident (MVTA) originates on a police accident report (PAR) filed with the state. It involves (a) a harmful event not directly resulting from a cataclysm, (b) produced by an unstabilized situation, (c) involving at least one motor vehicle, (d) in transport [in motion or on a roadway] such that (e) the harmful event occurred on a trafficway or the unstabilized situation originated on a trafficway.

A driver kills himself/herself (suicide) or self-inflicts injury by driving a motor vehicle: (1) against a fixed object, (2) into a body of water, or (3) otherwise misuses a motor vehicle in transport, and this intent is verified in some manner; such intentional events are not motor vehicle accidents. If during such intentional acts other injury or damage occurs that goes beyond the original intent, then these events are accidental and meet the specifications of a motor vehicle accident, unless the contrary can be clearly established.

Example 1: A driver who intends to commit suicide by driving head-on into another vehicle is involved in an accident, since any harmful event which results to the other vehicle or occupants goes beyond the original intent of the driver.

A person, having announced intent in some manner, causes death, injury, or damage by driving a motor vehicle against persons, motor or other road vehicles, or other property, with homicidal, injury, or damage inflicting intent; such intended acts are not motor vehicle accidents. If, in doing such intended acts, other injury or damage occurs that goes beyond the original intent (i.e., unintended consequences), these events are accidental and meet the specifications of a motor vehicle accident, unless the contrary can be clearly established.

Example 2: A driver (not connected with a law enforcement agency) who intentionally rams another vehicle, intending to inflict harm upon the other vehicle or its occupants, is not involved in an accident. In Example 1 above, if the driver intended to inflict harm upon the other vehicle or its occupants, as well as inflict harm upon himself/herself, then this also would not be an accident.

However, malicious mischief, such as throwing a rock toward a motor vehicle, dropping an object from an overpass, or rolling an object upon a trafficway, is not considered to be deliberate intent unless it is clearly established that the act was directed toward a specified person or motor vehicle.

For the purposes of NASS sampling (given limited information on a PAR), a first harmful event resulting from deliberate intent should not be classified as an accident, except where a subsequent harm occurs to a different vehicle or person such that the harm was an unintended consequence of the original event.

When in doubt, follow the instructions for listing the accident contained in Section 3.0 of this manual and call your Zone Center for guidance.

Legal Intervention: Legal intervention is a type of deliberate intent involving intentional acts by a law enforcement agent, officer, or other official. If in doing such intended acts, injury or damage occurs that goes beyond the original intent, then the other events are accidental and meet the specifications of a motor vehicle accident, unless the contrary can be clearly established. The following are examples of legal intervention and should not be classified as accidents:

- (a) A road block is set up to stop a lawbreaker, and the lawbreaker crashes into it, either intentionally or unintentionally.
- (b) A police unit cuts in front of another vehicle to force it to the curb or shoulder and, as a result, the two vehicles collide.
- (c) A vehicle loses control as a result of bullets fired into it from a police officer's gun, and crashes.

The following are examples of an accident:

- (d) A driver, other than a lawbreaker, crashes unintentionally into a roadblock.
- (e) A lawbreaker, while eluding the police, loses control of his vehicle and crashes into another vehicle.
- (f) A police car skids and crashes while chasing a law violator.

If in (c) above, the vehicle had created a harmful event with another vehicle or person, then the presumed unintended consequences of the action would qualify this situation as an accident.

One example which has previously been encountered is as follows: A prisoner jumps out of a police car and is injured. An officer in another car who observes this event, writes a report. Is this an accident? Yes. Although the prisoner exited the car intentionally, the subsequent injury (harmful event) occurred as an unintended consequence of the prisoner's escape attempt, thus constituting this event as an accident. It should be assumed that the injury was an unintended consequence of the prisoner's action unless the contrary can be clearly established.

For the purposes of NASS sampling, the same guidance as given above applies.

Cataclysm: ANSI D16.1-1976 lists the following events as catastrophic: a cloudburst, cyclone, earthquake, flood, hurricane, lightning, tidal wave, torrential rain, tornado, or volcanic eruption. If any one of these events was on-going at the time of the accident and produced the unstabilized situation which lead to the harm, then the event(s) is(are) not considered an accident. One key phrase is "on-going". Consider the following example: A motor vehicle in transport was overwhelmed by a landslide or an avalanche which was a direct result of a cataclysm, such as an earthquake, torrential rain, etc. This circumstance would not be considered an accident. However, this exclusion would not apply if a cataclysm were not in existence at the time of the event; nor would this exclusion apply if the motor vehicle was unintentionally driven against any fallen materials covering a trafficway as a result of any landslide or avalanche. As this example points out, the catastrophic event "exclusion" should occur very rarely.

Another key phrase is "produced the unstabilized situation". The situation in which a vehicle hydroplanes in a torrential rain and exits the

roadway, striking another motor vehicle or object, would fit the criteria for a NASS accident, but the situation in which a cloudburst/torrential rain washes a roadway out from under a vehicle travelling on a roadway would be excluded from the NASS sample. Remember, the cataclysm must be on-going at the time of the accident.

For the purposes of NASS sampling, list any accidents which you believe should be excluded under the cataclysm exception. Confirm their exclusion by relating the events to your Zone Center before drawing the sample.

If an official ruling or subsequent investigation reveals, after a case has been selected, that one of the exclusions applies, drop the case and notify your Zone Center. When dropping the case, The following procedure should be followed:

- (1) Call Zone Center to discuss dropping of case.
- (2) Submit all forms/slides, etc. initiated or completed for the case to the Zone Center. As a minimum, the PAR and an Accident form containing an explanation of the drop decision should be submitted.

Must Involve A Motor Vehicle as Defined by ANSI--If the police report which has been sampled does not involve at least one motor vehicle as defined by ANSI D16.1-1976 (section 2.2.7, page 5), then it should be returned to the file and not included in the list which qualifies for inclusion.

Example: A bicycle which runs off the road and hits a tree is not a motor vehicle accident and should not be included.

Must Involve a Motor Vehicle in Transport--Use the ANSI D16.1-1976 (section 2.2.20, page 7) definition to determine if the motor vehicles in the accident are in transport. There must be at least one motor vehicle in the accident in transport for the accident to qualify. (NOTE: Any driverless vehicle of which any portion is located on the roadway is considered as a vehicle in transport.)

Example 1: A bicyclist running into a car which is parked off the roadway does not constitute a motor vehicle accident for this study and would be excluded. If a police report has been filled out on such an incident, return the police report to the file because it does not qualify.

Example 2: Vehicles parked on roads of reduced width, such as can result from snow accumulation and incomplete snow removal, are to be considered in transport if any portion is on the roadway.

Must Involve a Motor Vehicle in Transport on a Trafficway--Exclude accidents which occur in places other than a trafficway. Examples of places which are not on the trafficway include parking lots (except entrances and roadways within parking lots which are customarily used to get from the entrance to a parking aisle) and private driveways. Review carefully the diagrams depicting rural, urban, and divided trafficways in Figures 2-2, 2-3 and 2-4.

Example: An abandoned vehicle, a portion of which is on the roadway is struck by a bicyclist, causing injury to the bicyclist: a police report is

filled out by an investigating officer. Is this a motor vehicle accident?
Yes it is. This is because there is a police reported incident involving
a motor vehicle in transport on a trafficway.

FIGURE 2-2

Example of a Rural Trafficway

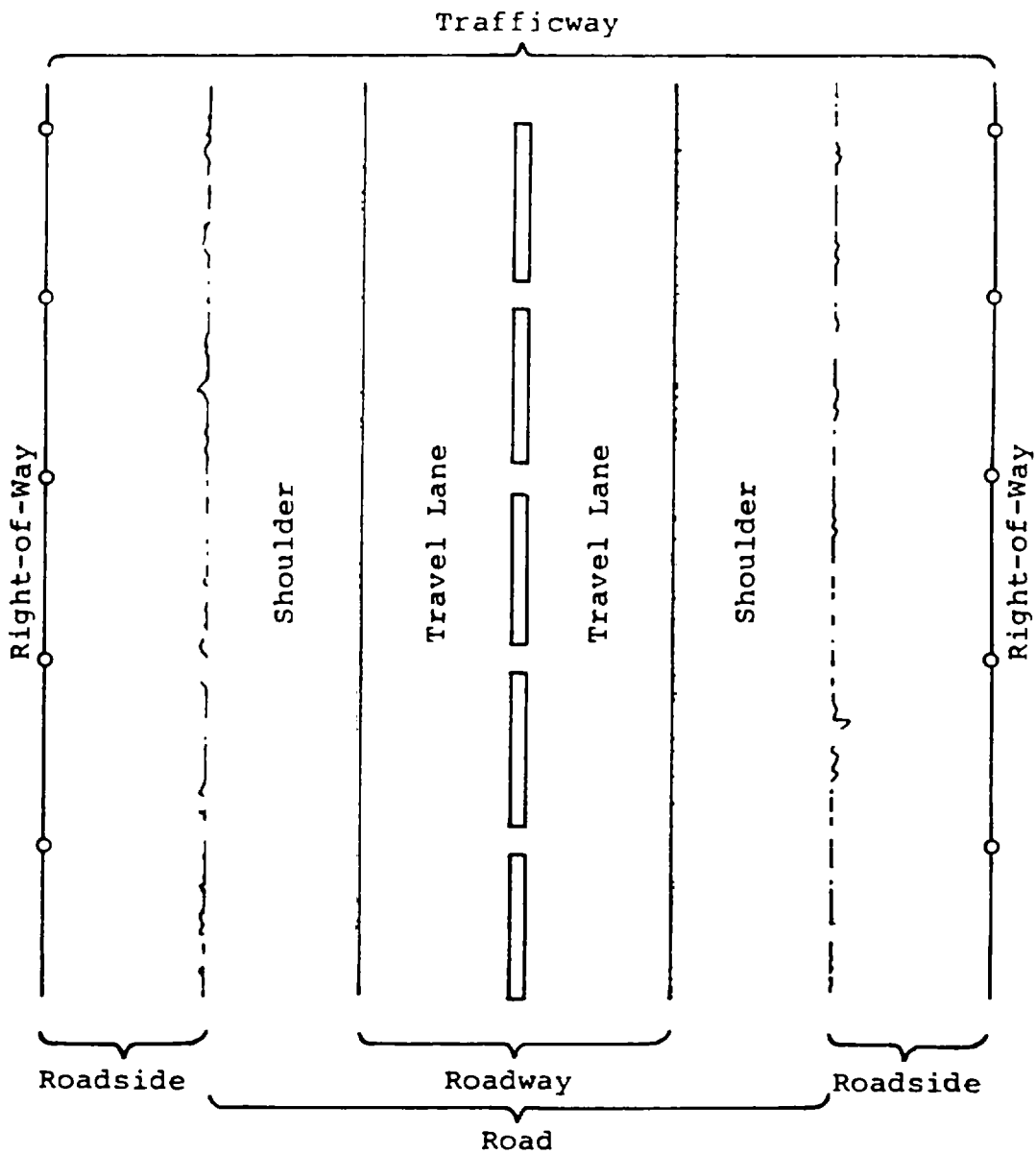
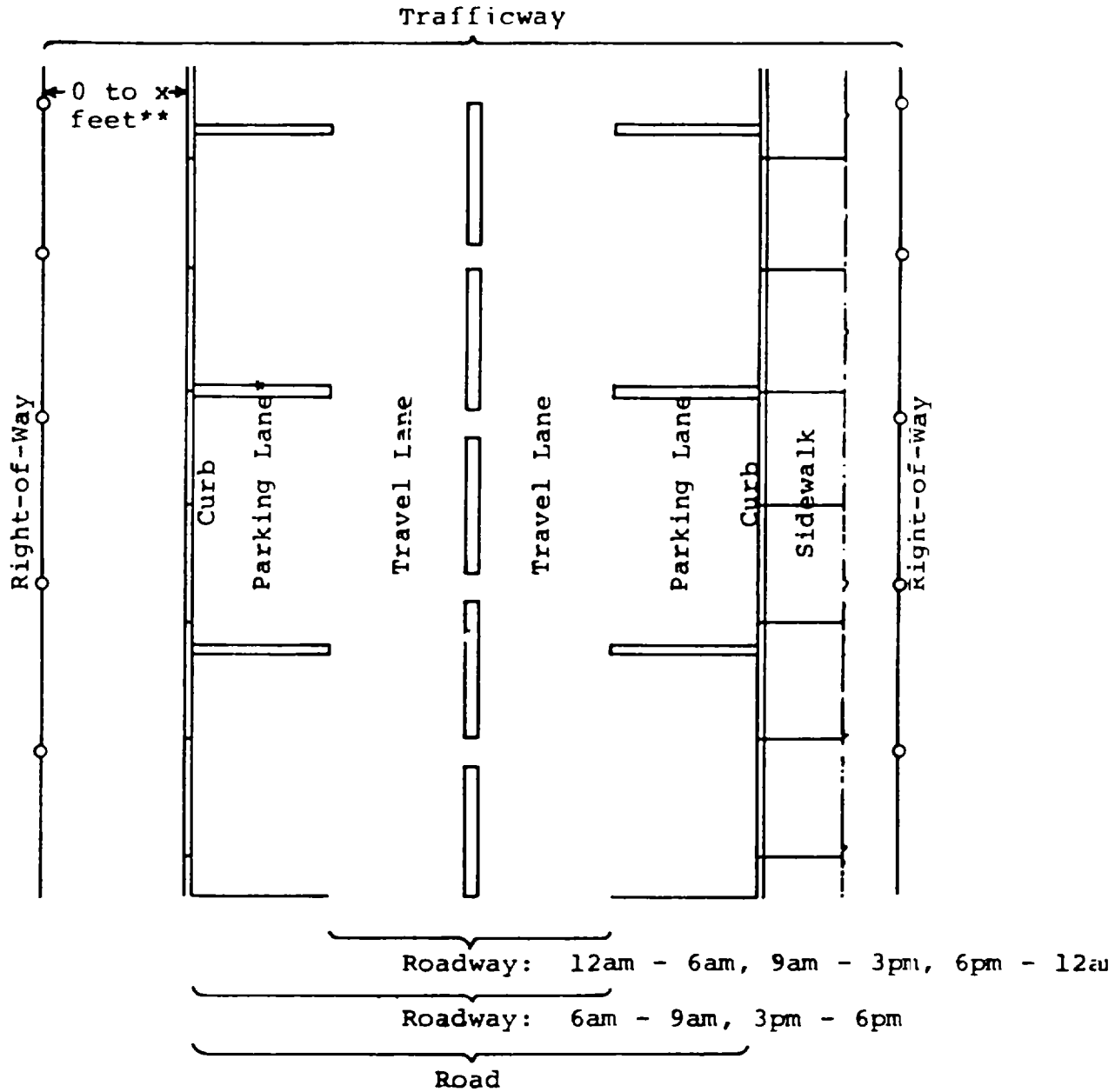

FIGURE 2-3

Example of an Urban Trafficway



* No parking allowed 6 to 9 a.m. or 3 to 6 p.m.

** The actual right-of-way in many cases will not be known. But it is clear that the trafficway always goes from curb to curb or from shoulder to shoulder.

FIGURE 2-4

Example of a Divided Trafficway

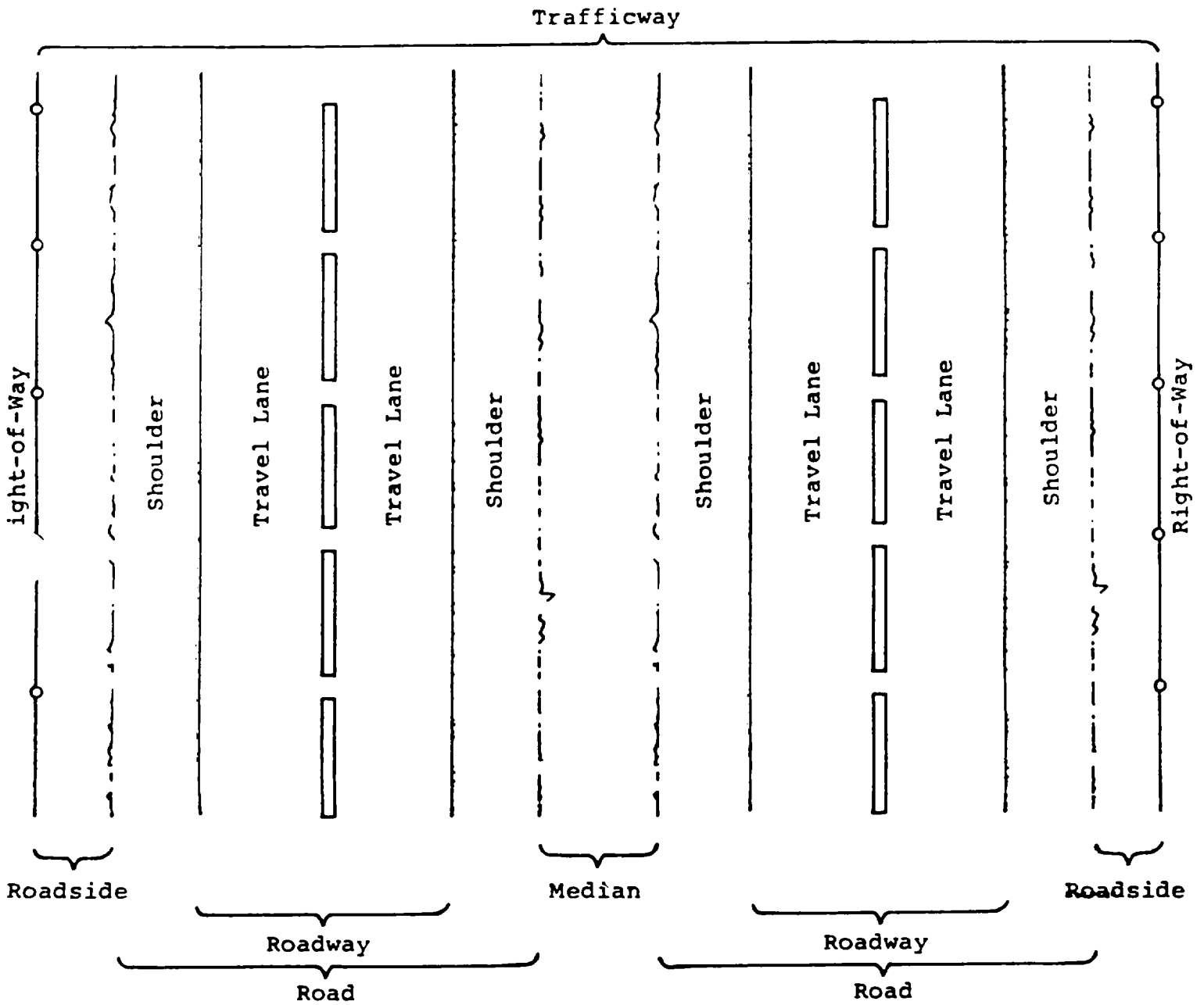

FIGURE 2-5

	<u>ANSI</u>
Person	2.1.1
Property	2.1.2
Transport device	2.1.3
Animal	- -
<u>Transport vehicle</u>	2.1.4
Aircraft	2.1.6
Watercraft	2.1.7
<u>Land vehicle</u>	2.1.8
Railway vehicle	2.2.4
<u>Road vehicle</u>	2.2.6
Motor vehicle	2.2.7
Other road vehicle	2.2.8
<u>In transport</u>	2.2.20
<u>Transport way</u>	2.1.5
Airway	2.1.9
Waterway	2.1.10
<u>Land way</u>	2.1.11
Railway	2.2.3
Private way	2.2.2
<u>Traffic way</u>	2.2.1
Road	2.2.19
Shoulder	2.2.18
Roadway	2.2.17
Roadside	- -
Median	- -
<u>Accidents</u>	2.3
Harmful event	2.3.3
Injury	2.3.1
Damage	2.3.2
Unstabilized situation	2.3.4
Cataclysm	2.3.5
<u>Accident</u>	2.3.6
<u>Transport accident</u>	2.3.7
Aircraft accident	2.3.8
Watercraft accident	2.3.9
Railway accident	2.3.11
<u>Road vehicle accident</u>	2.3.15
Motor vehicle accident	2.3.10
Other road vehicle accident	2.3.12
or	
<u>Traffic Accident</u>	2.3.16
Nontraffic accident	2.3.17
Nontraffic accident	2.3.18
Nontraffic accident	2.3.19
<u>Motor Vehicle Traffic Accident</u>	
	Traffic Accident Nontraffic Accident
Motor Vehicle	2.3.20 2.3.21
Other Road Vehicle	2.3.22 2.3.23

FIGURE 2-5 (Definitions)

TRANSPORT VEHICLE: (2.1.4) A transport vehicle consists of one or more devices or animals and their load. Such devices or animals must include at least one of the following: (1) a transport device, or a unit made up of connected transport devices, while idle or in use for moving persons or property from one place to another, (2) an animal or team of animals while in use for moving persons or property other than the animal or team itself from one place to another, or (3) a movable device such as construction, farm, or industrial machinery outside the confines of a building and its premises while in use for moving persons, the device itself, or other property from one place to another. If such a device or animal has a load, the load is part of the transport vehicle. Loads include any persons or property upon, or set in motion by, the device or animal; any persons boarding or alighting from the device or animal; any persons or property attached to and in position to move with the device or animal. If the load upon a transport device includes another transport device, the entire unit including the load is considered to be a single transport vehicle.

LAND VEHICLE: (2.1.8) A land vehicle is a transport vehicle which is neither an aircraft nor a watercraft.

ROAD VEHICLE: (2.2.6) A road vehicle is any land vehicle other than a railway vehicle.

MOTOR VEHICLE: (2.2.7) A motor vehicle is any motorized (mechanically or electrically powered) road vehicle not operated on rails.

OTHER ROAD VEHICLE: (2.2.8) An other road vehicle is any road vehicle other than a motor vehicle. Inclusions: animal-drawn vehicle (any type); animal harnessed to a conveyance; animal carrying a person; street car (not on rails); pedalcycle.

IN TRANSPORT: (2.2.20) The term "in transport" denotes the state or condition of a transport vehicle which is in motion or within the portion of a transport way ordinarily used for travel by similar transport vehicles. When applied to motor vehicles, "in transport" means in motion or on a roadway.

TRANSPORT WAY: (2.1.5) A transport way is any way or place reserved or commonly used for the operation of transport vehicles.

LAND WAY: (2.1.11) A land way is the space within property lines or other boundary lines of any transport way that is neither an airway nor a waterway.

TRAFFICWAY: (2.2.1) A trafficway is any land way open to the public as a matter of right or custom for moving persons or property from one place to another.

FIGURE 2-5 (Definitions - continued)

- ROAD:** (2.2.19) Road is that part of a trafficway which includes both the roadway and any shoulder alongside the roadway.
- SHOULDER:** (2.2.18) A shoulder is that part of a trafficway contiguous with the roadway for emergency use, for accommodation of stopped road vehicles, and for lateral support of the roadway structure.
- ROADWAY:** (2.2.17) A roadway is that part of a trafficway designed, improved, and ordinarily used for motor vehicle travel or, where various classes of motor vehicles travel or motor vehicles are segregated, that part of a trafficway used by a particular class. Separate roadways, may be provided for northbound and southbound traffic or for trucks and automobiles.
- HARMFUL EVENT:** (2.3.3) A harmful event is an occurrence of injury or damage.
- INJURY:** (2.3.1) An injury is bodily harm to a person. Exclusions: effects of diseases, such as cerebral hemorrhage, heart attack, diabetic coma, epileptic seizure.
- DAMAGE:** (2.3.2) Damage is harm to property that reduces the monetary value of that property. Inclusions: harm to wild animals, or birds, which have monetary value. Exclusions: harm to wild animals, or birds, which have no monetary value. Harm to a snowbank unless, for example, additional snow-removal costs are incurred because of the harm. Mechanical failure during normal operation (e.g., tire blowout, broken fan belt, or broken axle).
- UNSTABILIZED SITUATION:** (2.3.4) An unstabilized situation is a set of events not under human control. It originates when control is lost and terminates when control is regained or, in the absence of persons who are able to regain control, when all persons and property are at rest. Exclusions: (1) Deliberate intent--suicide, homicide, and other harmful events under human control do not imply the existence of an unstabilized situation. A set of unintended consequences of such acts might be an unstabilized situation. (2) Legal intervention--legal intervention is a type of deliberate intent involving intentional acts by a law-enforcing agent or other official.
- CATACLYSM:** (2.3.5) A cataclysm is a cloudburst, cyclone, earthquake, flood, hurricane, lightning, tidal wave, torrential rain, tornado, or volcanic eruption.
- ACCIDENT:** (2.3.6) An accident is an unstabilized situation which includes at least one harmful event not directly resulting from a cataclysm.
- TRANSPORT ACCIDENT:** (2.3.7) A transport accident is an accident (1) that involves a transport vehicle in transport and (2) in which the first harmful event is not produced by the discharge of a firearm or explosive device.
- ROAD VEHICLE ACCIDENT:** (2.3.15) A road vehicle accident is a transport accident that is either a motor vehicle accident or an other road vehicle accident.

FIGURE 2-5 (Definitions - continued)

MOTOR VEHICLE ACCIDENT: (2.3.10) A motor vehicle accident is a transport accident that (1) involves a motor vehicle in transport, (2) is not an aircraft accident or watercraft accident, and (3) does not include any harmful event involving a railway train in transport prior to involvement of a motor vehicle in transport.

OTHER ROAD VEHICLE ACCIDENT: (2.3.12) An other road vehicle accident is a transport accident that (1) involves an other road vehicle in transport and (2) is not an aircraft accident, watercraft accident, motor vehicle accident, or railway accident.

TRAFFIC ACCIDENT: (2.3.16) A traffic accident is a road vehicle accident in which (1) the unstabilized situation originates on a trafficway or (2) a harmful event occurs on a trafficway.

NONTRAFFIC ACCIDENT: (2.3.17) A nontraffic accident is a road vehicle accident which is not a traffic accident.

MOTOR VEHICLE TRAFFIC ACCIDENT: (2.3.20) A motor vehicle traffic accident is a motor vehicle accident which is a traffic accident.

In summary, each of the preceding questions is designed to focus your attention to the specific subset of transportation-related accidents characterized best as "motor vehicle traffic accident". In NASS, you investigate Motor Vehicle Traffic Accidents. To put this subset of accidents which qualify for study in perspective, see Figure 2-5. This figure outlines the major definitional sections of ANSI D16.1-1976 into meaningful groups and shows how the phenomenon of motor vehicle traffic accidents fits into the overall transportation accident picture. Accompanying Figure 2-5 are the primary ANSI definitions of interest to NASS. Figure 2-5 refers to these definitions. These definitions are provided here as both a reference source to you, the NASS investigator, as well as enabling you to understand the larger accident picture to which ANSI refers. Be sure to mark down in your memory the location in this manual of Figures 2-1 and 2-5; together, they can serve as a handy reference source to remind you of what constitutes a "NASS accident".

One sticky problem remains. Ideally, when you pick up a police report, that PAR should only be reporting about one accident. Unfortunately, this is not always true. There are practical and understandable reasons why this occurs. This manual would be remiss if it failed to discuss the issue of stabilization.

Stabilization--At times, one police report will contain more than one accident. This will happen when events constituting an accident have stabilized (see ANSI D16.1-1976, section 2.3.4, page 8) and units involved in the first sequence are subsequently involved in another accident sequence which is recorded on the same police report. If more than one accident is recorded on a police report, based on the ANSI definition of stabilized, then use the following protocol to determine which of the accidents is to be stratified and listed:

- (1) If injury is involved and you can determine the relative degree of injury between events and one event is of higher severity, then choose that event.
- (2) If injury is involved and you determine that the relative injury between events is approximately equal, then choose the first of the highest equal injury events.
- (3) If injury is involved but you cannot determine the relative injury between events, then choose the first event.
- (4) If no injuries, then choose the first event.

In those cases where an accident, by NASS criteria, other than the one reported on the PAR, is alluded to (e.g., in the narrative), there is a rebuttable presumption that this PAR is the only PAR that will be submitted to report both accidents. This presumption may be overridden if the investigator has knowledge of: (1) another PAR on file, (2) a statement in the narrative indicating that there is, or will be, another PAR, or (3) the dispatcher or other police personnel having knowledge of the accidents and indicating that there is, or will be, another report filed.

Example: The PAR narrative states: "Vehicle #1 had been struck by an unidentified vehicle that did not stop. As driver of Vehicle #1 opened door

to get out door caught rear wheels of trailer of Vehicle #2." There is no other mention of the unidentified vehicle which failed to stop anywhere else on the PAR. This PAR contains two separate accidents. The injury severity for both is "no injury"; therefore, the first is used for stratification purposes, independent of the police emphasis on the second.

Caution must be exercised when separating accidents on a PAR, however. At times, it will appear that two distinct events of an accident sequence should be considered separately. According to ANSI (D16.1, section 2.3.4, page 8), an unstabilization terminates "... when all persons and property are at rest ...". "Property" can refer to the damaged vehicles, separated components of the vehicles, or cargo. Often the interviews will be the only source for determining whether or not stabilization occurred before the second event.

Example: Two vehicles collide in the eastbound lanes of a divided trafficway. Cargo from one vehicle spills into the westbound lanes and another vehicle is damaged. If it can be determined that stabilization never occurred, that the cargo struck the vehicle, or the vehicle struck the moving cargo, the two harmful events would be considered one accident and all three vehicles considered applicable to the NASS case. If it should be discovered during the investigation that the cargo came to rest for a period of time prior to being struck by the third vehicle, then the events would be considered as two separate accidents.

2.1.1 Common Questions and Answers About Incidents Which Qualify for Study

Please find below a list of some common questions which arise when determining if an accident report qualifies for the NASS, CSS or Nontowaway Study sampling frames.

Question: Now that the snow is gone, the potholes remain. If a motor vehicle in transport hits a pothole, causing damage to a tire and wheel or to the exhaust system, is this an eligible case?

Answer: Yes, it is an eligible case. To be eligible, recall that, first, a police report must be filed and, second, that the criteria set forth in ANSI D16.1-1976 (section 2.3, pages 8-10), have been met. In essence, these criteria mandate that the following occurs: (a) a harmful event (damage or injury), (b) involving a motor vehicle, (c) in transport, and (d) that the unstabilized situation originated (i.e., control was lost) on a trafficway or the harmful event occurred on a trafficway. If the parties involved suffered damage to the wheels, suspension, exhaust system, or undercarriage of their vehicles, then you have a valid case; however, ANSI D16.1-1976 specifically excludes damage from mechanical failures during normal operation (section 2.3.2, page 8). The intent is to exclude a "blow-out" accident where the driver brings the vehicle safely to the side of the road without incurring other damage. This exclusion was not meant to exclude an accident where a "blow-out" led to other vehicle damage (e.g., ran into a tree) while the driver was attempting to regain control.

Question: A man driving a motor home slams on his brakes to avoid another vehicle in his lane; he succeeds. However, his young daughter is thrown

against the instrument panel and suffers possible injuries. Is this a motor vehicle accident?

Answer: It is a motor vehicle traffic accident involving one vehicle. The other vehicle is not involved.

Question: A car loses control on a trafficway, leaves the trafficway, and does damage to a private lawn. There is no damage to the car and the driver is not hurt. Is this a traffic accident?

Answer: Yes. It would also be a traffic accident if the motor vehicle left the scene before the police arrived (i.e., a hit-and-run vehicle). In these cases, the determining factor is whether or not the private citizen called the police (i.e., considered their lawn damaged), and if the police filed an accident report.

Question: A pulp wood truck is travelling down a public road with an insecure load; the load shifts and all of the wood falls off the truck. The wood bounces and rolls, and then strikes a fence on the side of the road, doing approximately \$500 worth of damage to the fence. There is no damage to anything except the fence and no other vehicles are involved; however, there is a police report made out on the accident. Does this accident qualify for NASS?

Answer: Yes, this situation does qualify for NASS. The harmful event is the damage to the fence.

Question: A power line falls onto a motor vehicle in transport, causing personal damage--is this an applicable case? A tree falls onto a motor vehicle as it was driving down the road--is this an applicable case?

Answer: Both of the above situations, plus many similar ones (e.g., rocks fell onto the vehicle), fall into the category of near cataclysmic events. ANSI D16.1-1976 excludes, from the definition of an accident (section 2.3.6, page 9), harmful events resulting from a cataclysm. To further define this exclusion, the cataclysm must have been on-going at the time the accident happened. Cataclysms are defined in ANSI D16.1-1976 (section 2.3.5, page 8). Therefore, to exclude the situation of an object (power line, rock, etc.) falling on a motor vehicle in transport, the cataclysm which caused the object to fall must have been on-going at the time of the accident. In terms of the specific questions, they are NASS accidents.

Question: We have a rare case where a bystander dropped his gun; it struck the ground and discharged. A bullet struck the windshield of a vehicle in transport. Should this accident be listed as a motor vehicle accident.?

Answer: No, this is a firearms accident. However, it is entirely possible that a firearms accident could trigger a traffic accident.

Question: A tow truck is towing a pickup. The pickup truck loses an axle, which subsequently strikes a vehicle parked in a parking lot. Is this a NASS accident?

Answer: Yes it is. A motor vehicle in transport loses part of its cargo (axle of pickup--a harmful event in itself), which strikes (harmful event) a vehicle not in transport. This would be an example of an other non-collision (A10, First Harmful Event, equal "07").

Question: A motor vehicle, parked in a driveway, slipped out of gear and rolled down the drive, across the street, and struck a tree on the other side. Is this an applicable accident?

Answer: It depends on the location of the vehicle when control was lost and the location when the harm occurred. To be an applicable accident, the control must have been lost on a trafficway or the harmful event must have occurred on a trafficway. If the vehicle was up in its driveway (i.e., outside of the trafficway--it must be clearly beyond the curb or any sidewalk boarding the curb), then control was lost (i.e., control is assumed lost when the gears slipped) off a trafficway. If the tree that was struck was off the trafficway (same as above), then it is not an applicable accident and whether the vehicle is on or off the roadway at impact is irrelevant. Given that you have to make a decision at the police station (must have a police report to start with), scrutinize the police report for any information which would help you in determining the locations of the key elements. If the police report is uninformative concerning these key elements, include the accident for sampling purposes. If selected, a review of the scene should determine whether or not the case remains.

2.2 Classifying the Accident by Type, Severity, Tow Status, and Disposition of the Injured

Before an accident is selected for study, it must be classified by type, injury severity, tow status, and disposition of the injured. The groups into which the accidents are classified are called strata and are the basis for the stratified sampling procedures (i.e., stratification with variable sampling fraction) described in Section 3.0.

Accident Type Classification--Accidents will be classified into five categories: pedestrian and nonmotorist, motorcycle, medium or heavy truck, light truck or van, or other motor vehicle. For the purpose of this study, pedestrians, pedalcyclists, occupants of nonmotor vehicles, and occupants of motor vehicles not in transport or not in transport on a trafficway, are considered as pedestrians and nonmotorists. To classify the accident by type, first classify each unit in the accident as a pedestrian and nonmotorist, motorcycle, medium or heavy truck, light truck or van, or other motor vehicle. These classifications are defined as follows:

Pedestrian or Nonmotorist - pedestrian; bicyclist; other cyclist; occupant of an animal related nonmotor vehicle transport device; occupant of vehicle not in transport; other nonmotorist. For full definitions of terms, see Vehicle Form variable V14.

Motorcycle - motorcycle; moped (motorized bicycle); other motorcycle (e.g., minibikes, motor scooters, sidecar cycle). For full definitions of terms, see Vehicle Form variable V14.

Medium or Heavy Truck - step van; straight truck over 10,000 lbs. GVWR; medium/heavy truck-based motor home; truck tractor pulling no trailer; truck tractor

pulling one or more trailers. For full definitions of terms, see Vehicle Form variable V14.

Light Truck or Van - pickup; van (passenger, cargo, van-based station wagon); van - commercial cutaway (includes multi-stop, parcel, truck based panel, etc.); truck based station wagon (e.g., Travelall, etc.); van and pickup-based motor home; truck-based utility (e.g., Blazer, Bronco - 78 on, Scout, etc.); cab chassis-based (includes rescue vehicles, light stake, dump, and tow trucks). For full definitions of terms, see Vehicle Form variable V14.

In addition, when the vehicle is known to be a truck (or van), but it is not known whether the vehicle is a light, medium, or heavy truck, then the default classification is "Medium or Heavy Truck".

Other Motor Vehicle - (OTHER VEHICLES) snowmobile; farm vehicle, except trucks; dune or swamp buggy; construction equipment other than trucks; (BUSSES) school bus; cross country; transit bus based (e.g., Jeep CJ-5, Pre-78 Bronco, etc.); large limousine, more than four doors; other automobile. For full definitions of terms, see Vehicle Form variable V14.

In addition, the accident type classification "Other Motor Vehicle" is used as the default classification when (1) no pedestrians or nonmotorists are present and (2) insufficient information exists regarding a vehicle to clearly identify its type (e.g., Chevrolet could mean passenger car, van, light truck, medium truck, or heavy truck).

Classify the accident according to the highest priority unit involved in the accident where pedestrians and nonmotorists are the highest priority followed by motorcycles, medium or heavy trucks, light trucks or vans, and finally, other motor vehicles. Examples are:

1. If a motorcycle strikes a pedestrian, classify the accident as a pedestrian and nonmotorist accident. The two units involved are a motorcycle and a pedestrian; of the units involved, the one with the highest priority is the pedestrian.
2. If a motorcycle strikes a heavy truck, classify the accident as a motorcycle accident.
3. If a medium or heavy truck strikes a light truck or van, classify the accident as a medium or heavy truck accident.
4. If a light truck or van strikes an automobile, classify the accident as a light truck or van accident.
5. If two automobiles collide, classify the accident as other motor vehicle accident.
6. If a medium or heavy truck strikes a motor vehicle not in transport (i.e., legally parked), with occupants (i.e., nonmotorists), classify the accident as a pedestrian and nonmotorist accident.
7. If a truck (of unknown size) strikes a stationary vehicle on a road shoulder with occupants, classify the occupants of the vehicle as nonmotorists

and classify the accident as a pedestrian and nonmotorist accident. If the same stationary vehicle above does not have occupants and is struck, the accident would be classified, using the default rule, as a medium or heavy truck accident.

Most Severe Police Reported Injury--Classify the accident according to its most severe police reported injury. Locate the injury in one of three classes: (1) fatal injury (K); (2) incapacitating injury (A); or (3) one of the following--non-incapacitating evident injury (B), possible injury (C), no injury (O), or unknown injury (U) [see ANSI D16.1-1976, section 3.1, page 21].

Transported vs. Nontransported Accidents--Minor injury accidents of all types (pedestrian and nonmotorist, motorcycle, heavy or medium truck, light truck or van, and other motor vehicle) will be subdivided into two categories: transported and nontransported. If a police accident report, with injuries no more severe than non-incapacitating ("B" injury), indicates that any of the pedestrian/nonmotorists or occupants of any vehicle went directly from the accident scene to a treatment facility (hospital, clinic, doctor's office, etc.), then the accident belongs in the "transported" category--strata C, G, L, O, or V. [It must be noted that for nontowaway light truck or van (stratum Y) or other motor vehicle accidents (stratum Z), no distinction between "transported" and "nontransported" is necessary; the strata are the same.] The means of transportation is not a consideration, nor is the length of stay at the facility. If the PAR does not indicate the disposition of the injured parties, stratify the accident "nontransported," but determine the final classification (A08, Final Stratification) through investigation. Also, if the PAR should erroneously report the disposition of the injured, correct on Final Stratification (A08).

Towaway vs. Nontowaway Accidents (also see Section 4.6.5 below)--For light truck or van and other motor vehicle accidents, classify B, C, O, or U severity accidents as towaway or nontowaway. If the police report indicates any in transport vehicle was towed, classify the accident as towaway. The distance towed and the reason for towing (e.g., vehicle towed from a ditch) are not considerations. If a police officer should neglect to indicate vehicle disposition (i.e., towaway or nontowaway), the final classification (A08, Final Stratification) is determined through investigation. In some areas where the PAR does not identify vehicle disposition, the stratum can be determined from other sources or from other information on the report (e.g., disabling damage to a vehicle). If an individual PSU must resort to the last method of selecting vehicle dispositions from a PAR, it should discuss the matter with its Zone Center prior to making a policy. Accidents classified as nontowaway become part of the Nontowaway Study (NTS) sample and are selected independently of the accidents in the Continuous Sampling System (CSS) sample. The procedures are explained in Section 3.0.

2.2.1 Continuous Sampling System (CSS) and Nontowaway Study (NTS) Samples

The NASS sampling frame is divided into two categories of accidents: (1) those that qualify for the Continuous Sampling System (CSS), and (2) those that qualify for the Nontowaway Study (NTS) sample.

The Nontowaway Study includes all NASS accidents of B, C, O, or U severity involving only light trucks or vans (i.e., excluding medium and heavy trucks) or other motor vehicles in which no in transport vehicle was towed from the scene. These accidents generally result in relatively minor property damage and no injuries. Thus, we do not need to collect as much information about this type of accident as we do about more serious types of accidents.

To limit the amount of resources expended on investigating nontowaway accidents, two procedures are to be followed:

1. The teams are to sample Nontowaway Study accidents separately from CSS accidents and at a lower rate.
2. The teams are to collect less vehicle information for the Nontowaway Study accidents that are selected. The teams will use a shortened version of the Vehicle Form. This subject is discussed in sections 4.6.1 and 4.6.5.

If the Nontowaway Study accidents and CSS accidents were sampled together from one list, the number of nontowaway accidents would be several times greater than needed. To reduce the number of nontowaway accidents selected, the teams are to sample them separately from the CSS accidents and at a much lower rate. On the average, each team will investigate about one to two nontowaway accidents per month.

2.2.2 Common Questions and Answers Regarding Stratification

Please find below some typical examples of questions involving the classification of accidents.

Question: A vehicle ran off the road, struck a small tree, and continued on, eventually striking a pedestrian. Would this be coded as an other motor vehicle accident, since ANSI requires that in a pedestrian accident (section 2.6.4, page 17), the first harmful event must involve a collision with a pedestrian?

Answer: In NASS we are concerned with what is defined in ANSI as a motor vehicle traffic accident (MVTA) (section 2.3.20, page 10). The components of a MVTA are: (a) a police report, (b) a harmful event, (c) from an unstabilized situation, (d) involving at least one motor vehicle, (e) in transport [in motion or on a roadway], such that (f) the harmful event occurred on a trafficway or the unstabilized situation originated on a trafficway. Beyond this, we are not concerned with subdividing accidents according to ANSI. Therefore, this accident should be classified as pedestrian accident. The first harmful event is not part of the sampling criteria. Remember that accident type, towing, injury severity, and disposition of the injured are the four independent measures used in deriving the stratification.

Question: Are persons in a train which hits a car considered as nonmotorists? If so, is the accident classified as a pedestrian and nonmotorist accident?

Answer: Trains, on their tracks, which strike or are struck by motor vehicles, are considered as stationary or nonstationary objects for the purposes of NASS. The persons on the train [including the operator(s)] are not considered to have been involved in the accident.

Question: When a hit-and-run accident occurs and no information is available about the striking vehicle, how do you classify the accident on the stratification record?

Answer: You consider this vehicle to have been an other motor vehicle. You then complete the stratification based upon this assumption. If you have information on the police report that indicates the hit-and-run vehicle was either a truck (light or heavy or medium) or a motorcycle, then you treat it appropriately for sampling purposes.

Question: How is a street cleaner classified?

Answer: If a street cleaner vehicle is encountered during stratification, stratify according to model type. Some of these vehicles are essentially straight trucks with the cleaning equipment on the rear bed--stratify these as heavy or medium trucks. Other street cleaning models are essentially special vehicles--stratify them as other motor vehicles. If you cannot determine which model type the vehicle falls under, stratify as other motor vehicle. However, remember that many cities buy only one type, this source could be used as a basis for clarification.

Question: How do you stratify a vehicle not in transport? The vehicle is unoccupied.

Answer: You ignore vehicles not in transport for sampling purposes (but not for CRASH program purposes, when impacted). If the vehicle had been occupied, then its occupants would be considered as nonmotorists and the pedestrian or nonmotorist strata would be used.

Question: It is, at times, difficult to determine whether or not the vehicle was on the roadway from simply reviewing a police accident report. Usually, the PAR merely states that the vehicle was parked. Unless one is familiar with the roadway, how do you determine if the vehicle was in transport or not?

Answer: Being familiar with the area can help a great deal in resolving these types of questions. In large urban areas, or even rural areas, this, of course, is not always going to be possible. First, look at the scene diagram provided by the police (if available). If parking lanes are indicated then you know the vehicle was not in transport. If the roadway is narrow and the roadway's width (where indicated) will not support two-way traffic (assuming the roadway was two-way), then the vehicle was in transport. If the police cite the driver for illegal parking, this is a strong indication that the vehicle was in transport (although caution should be exercised since the illegal parking could have occurred due to time violation, parking in yellow curbed areas in the middle of what otherwise would be considered a parking lane, parking by a fire hydrant, etc.). If the PAR does not contain sufficient helpful information, and you are not fa-

miliar with the area, then you must presume for stratification purposes (only), that the vehicle was not in transport.

Question: A vehicle had several persons riding on top of it. The police spotted the vehicle and started to give chase. The persons jumped off. In the process, one was injured. Is this person an occupant or a non-motorist? What about the vehicle and its occupants?

Answer: The persons riding on the roof do not fit the appended-to-the-vehicle-for-motion exclusion (e.g., person on a bicycle or skateboard who is holding onto the back of a vehicle for added motion) cited under variables 008, Occupant Number, and 014, Occupants Seat Position; therefore, these persons are occupants of the in transport vehicle. Regarding the injured person, if that injury (harmful event) occurred as a result of exiting from the vehicle, then stabilization did not occur for that person. Therefore, in addition to those in the vehicle, consider the person who was injured while jumping from the vehicle as an occupant also.

Question: A pickup truck was towing (pulling) a friend's passenger car to a service station. The car broke loose and impacted a tree. No damage occurred to the pickup. How would you stratify this accident?

Answer: In general, any motor vehicle on a roadway is in transport. An exception occurs where the vehicle is attached to another vehicle by means of a fixed linkage. The critical issue is whether or not the attached vehicle has any control over its movement. In this instance, the answer depends on how the car and truck were attached. If the car was attached by a tow bar or any other form of fixed linkage, then the car is considered a trailing unit and the accident is stratified as a truck accident. On the other hand, if the linkage was nonfixed (e.g., rope, chain, etc.), then the car was in transport and the accident is stratified as an other motor vehicle accident. A fixed linkage is defined as one which has the property of keeping the towed unit separated from the power unit by a distance which is essentially constant. Included within this definition are cradle linkages where the towed unit has two or more wheels off the ground.

3.0 OVERVIEW OF SAMPLING ACTIVITIES

The procedure for designating the sample of accidents will include the following four tasks:

- Task 1: Contact specified police jurisdictions on specified days to process the police accident reports (PARs);
- Task 2: Review PARs at the jurisdiction, listing and classifying them into accident categories (strata) using the NASS Stratification Record form;
- Task 3: Enter the listed PARs into the NASS Automated Case Selection System and identify, from the output, the applicable accidents to be investigated; and,
- Task 4: If the NASS Automated Case Selection System is not accessible, complete the Case Load and Sampling Worksheets, identifying from the list the accidents that are to be investigated for NASS. Note: in all circumstances, the listed PARs must be entered into the Automated Case Selection System sequentially by sampling date when it again becomes accessible.

The methods to be used by a team to accomplish each of these tasks depends on the PSU.

Most teams will perform these tasks on Monday and Thursday of each week. Other teams will perform these tasks on Tuesday and Friday of each week. Still other teams will sample more than twice a week. Section 3.2 discusses the Monday-Thursday example. However, the procedure to be followed is the same, regardless of the schedule.

The NASS sampling frame consists of two categories of accidents: (1) those that qualify for the Continuous Sampling System (CSS) sample and (2) those that qualify for the Nontowaway Study (NTS) sample. Accidents to be investigated are selected independently within each category. Section 3.2 describes the procedures to be used to sample from the two categories.

3.1 Listing and Sampling Forms

The Case Load Assignment Sheet (CLAS), the Case Load Worksheet (CLW), the Stratification Record, the Accident Sampling Worksheet (SW), and the Sample Selection within Stratum/Jurisdiction (SSSJ) form to be used in PSU 78 (Douglas County, Nebraska) are attached as examples. Note that the 1984 Sampling is not different from 1983.

3.1.1 Case Load Assignment Sheet (CLAS)

The Case Load Assignment Sheet provided is unique for the PSU (Table 3-1). It covers team activities for the periods specified on the right-front side of the form. Updated versions of the CLAS will be sent to you quarterly.

The CLAS lists the jurisdictions the team is to contact and specifies the days of the week on which the contacts are to be made. It also indicates the number

TABLE 3-1

CASE LOAD ASSIGNMENT SHEET

PSU: 78 Douglas County, NE

Period: January 4 - 22, 1982

	Contact Days*					
	Monday 4	Thursday 7	Monday 11	Thursday 14	Monday 18	Thursday 21
Number of CSS accidents to be selected	4	2	3	3	3	3
Number of NTS accidents to be selected	0	1	0	0	0	0
Random Number	.148	.880	.677	.702	.996	.070

Period: Jan. 25 - Feb. 12, 1982

	Contact Days*					
	Monday 25	Thursday 28	Monday 1	Thursday 4	Monday 8	Thursday 11
Number of CSS accidents to be selected	3	3	3	3	3	3
Number of NTS accidents to be selected	0	0	1	0	0	0
Random Number	.838	.036	.417	.962	.458	.778

Period: Feb. 11 - March 5, 1982

	Contact Days*					
	Monday 15	Thursday 18	Monday 22	Thursday 25	Monday 1	Thursday 4
Number of CSS accidents to be selected	4	2	3	3	3	3
Number of NTS accidents to be selected	0	0	0	1	0	0
Random Number	.541	.869	.379	.973	.553	.325

Period: March 8 - 26, 1982

	Contact Days*					
	Monday 8	Thursday 11	Monday 15	Thursday 18	Monday 22	Thursday 25
Number of CSS accidents to be selected	3	3	3	3	3	3
Number of NTS accidents to be selected	0	0	0	0	1	0
Random Number	.674	.907	.710	.709	.499	.493

CASE LOAD ASSIGNMENT SHEET

PSU: 78 Douglas County, NE

Period: March 29 - April 2, 1982

	Contact Days*					
	Monday 29	Thursday 1	Monday	Thursday	Monday	Thursday
Number of CSS accidents to be selected	3	3				
Number of NTS accidents to be selected	0	0				
Random Number	.384	.346				

*Contact to list all accidents added to jurisdiction files since the previous contact:

Monday
 Omaha
 Douglas County Sheriff
 Ralston
 Valley

Thursday
 Omaha
 Douglas County Sheriff

of CSS and Nontowaway Study (NTS) sample accidents to be selected and the random number to be used on each contact date. This information is used to complete the Case Load Worksheet.

3.1.2 Case Load Worksheet (CLW)

All teams will use the same Case Load Worksheet (Table 3-2). Make photocopies of the form provided for the use of the team. Instructions for completing the form are given in Section 3.2.4.

3.1.3 Stratification Record

All teams will use the same Stratification Record form (Table 3-3). Make photocopies of the form provided for the use of the team. Instructions for completing the form are given in Section 3.2.2.

3.1.4 Accident Sampling Worksheet (SW)

The forms provided are unique to the PSU: photocopy them for the use of the team. There are two sampling worksheets: one for the CSS accidents (Table 3-4a) and one for the Nontowaway Study (NTS) accidents (Table 3-4b). Instructions for completing the worksheets are given in Section 3.2.4.

Each worksheet lists the jurisdictions the team is to contact and specifies the days of the week on which the contacts are to be made. This information is also shown on the Case Load Assignment Sheet (CLAS).

3.1.5 Sample Selection Within Stratum/Jurisdiction Form (SSSJ)

All teams will use the same Sample Selection Within Stratum/Jurisdiction form (Table 3-5). Each team should keep at least one clean copy of the form in reserve and make photocopies as needed. Instructions for completing the form are given in Section 3.2.4.

3.2 Listing and Sampling Instructions

3.2.1 Contacting Police Jurisdictions

Contact each of the jurisdictions indicated on the Case Load Assignment Sheet (and also on the Sampling Worksheets) on the day(s) of the week specified. For most teams, the jurisdictions are given in two different visitation patterns. For example, some jurisdictions are to be contacted on Monday and Thursday, others are to be contacted on Monday or Thursday (i.e., only one visit each week). For this latter group, the team is to decide which of the days (Monday or Thursday) the jurisdiction will be contacted; once the decision is made, the jurisdiction should continue to be contacted on that day each week. If the team wishes to change the day of contact for any jurisdiction, notify your respective Zone Center and CTM for approval to implement the change.

The team should write the contact date in its indicated space on every sampling form (CLW, Stratification Record, SW, SSSJ) and must enter it in the Automated Case Selection System.

TABLE 3-2

CASE LOAD WORKSHEET

PSU: _____

Year: 1984

Computations to designate sample strata and jurisdictions	Contact Days and Dates					
	CSS	NTS	CSS	NTS	CSS	NTS
1. Number of sample accidents to be selected						
2. Random Number						
3. Total weighted accident count: (Col. 7 of last page of SW)						
4. First sampling interval: (3)/(1) (2 decimals)						
5. Number of listed accidents with weight greater than or equal to (4)						
6. If (5) is not zero, then go to step (1A); otherwise go to (7)						
1A. Remaining accidents to be selected: (1) - (5) =						
2A. Weighted accident count for accidents identified, in step (5)						
3A. Remaining weighted accident count: (3) - (2A) =						
4A. New sampling interval (3A)/(1A)						
5A. Number of remaining listed accidents with weight greater than or equal to (4A):						
6A. If (5A) is not zero, go to step (1B). Otherwise transcribe (4A) to (4) and go to step (7)						
1B. Remaining accidents to be selected: (1A) - (5A) =						
2B. Weighted accident count for accidents identified in step (5A)						
3B. Remaining weighted accident count: (3A) - (2B) =						
4B. Sampling interval (3B)/(1B)						
5B. Number of remaining listed accidents with weight greater than or equal to (4B)						
6B. If (5B) is not zero, then continue with steps similar to steps (1B) thru (6B); otherwise transcribe (4B) to (4) and go to step (7)						

TABLE 3-2

CASE LOAD WORKSHEET (Continued)

PSU: _____

Year: 1984

Computations to designate sample strata and jurisdictions	Contact Days and Dates					
	CSS	NTS	CSS	NTS	CSS	NTS
Transcribe to Column (9) of Sampling Sampling Worksheet						
7. First random cumulant: (2) * (4) =						
8. Second random cumulant: (7) + (4) =						
9. Third random cumulant: (8) + (4) =						
10. Fourth random cumulant: (9) + (4) =						
11. Fifth random cumulant: (10) + (4) =						
12. Sixth random cumulant: (11) + (4) =						
13. Seventh random cumulant: (12) + (4) =						
14. Eighth random cumulant: (13) + (4) =						

TABLE 3-3

MASS Stratification Record

PSU

Contact Date

Listed by

Jurisdiction	PAR		Pedestrian or Nonmotorist			Motorcycle			Heavy or Medium Truck			Light Truck or Van			Other Motor Vehicle									
	Date	Time	Number	B, C, D, U		B, C, D, U		B, C, D, U		B, C, D, U		B, C, D, U		B, C, D, U										
				A	Tran	Non- Tran	A	Tran	Non- Tran	A	Tran	Non- Tran	A	Tran	Non- Tran	A	Tran	Non- Tran						
(1)	(2)	(3)	(4)	A	B	C	D	E	F	G	H	J	K	L	M	N	P	O	R	S	T	V	W	Z
1																								
2																								
3																								
4																								
5																								
6																								
7																								
8																								
9																								
10																								
11																								
12																								
13																								
14																								
15																								

Total MASS accidents stratified on this page:

TABLE 3-4a

NASS
Continuous Sampling System (CSS)
Accident Sampling Worksheet

PSU: 78 - Douglas County, Nebraska
Accident Type: Pedestrian & Nonmotorist

Day: _____ Date: ____/____/____
(mo) (day) (yr)

Accident Severity	Contact Day(s)	Jurisdiction	Stratum	N ₁	N ₂	N ₁ N ₂	ΣN ₁ N ₂	Random Cumulants	Number of Accidents Sampled	Selected Cases	Case Number
(1)	(2)	(3)	(4)	(5)	(6)	(7)	(8)	(9)	(10)	(11)	(12)
K	M & Th	Omaha	A	8							
	M & Th	Douglas County Sheriff		8							
	M	Ralston		16							
	M	Valley		24							
A	M & Th	Omaha	B	8							
	M & Th	Douglas County Sheriff		8							
	M	Ralston		16							
	M	Valley		24							
B, C, O, U Transported	M & Th	Omaha	C	3							
	M & Th	Douglas County Sheriff		3							
	M	Ralston		6							
	M	Valley		9							
B, C, O, U Nontransported	M & Th	Omaha	D	3							
	M & Th	Douglas County Sheriff		3							
	M	Ralston		10							
	M	Valley		15							

Accident Type: Motorcycle

K	M & Th	Omaha	E	8							
	M & Th	Douglas County Sheriff		8							
	M	Ralston		16							
	M	Valley		24							
A	M & Th	Omaha	F	8							
	M & Th	Douglas County Sheriff		8							
	M	Ralston		16							
	M	Valley		24							
B, C, O, U Transported	M & Th	Omaha	G	6							
	M & Th	Douglas County Sheriff		6							
	M	Ralston		12							
	M	Valley		18							
B, C, O, U Nontransported	M & Th	Omaha	H	3							
	M & Th	Douglas County Sheriff		3							
	M	Ralston		10							
	M	Valley		15							
SUBTOTAL											

NASS
Continuous Sampling System (CSS)
Accident Sampling Worksheet

PSU: 78 - Douglas County, Nebraska
Accident Type: Heavy or Medium Truck

Day: _____ Date: ____/____/____
(mo) (day) (yr)

Accident Severity	Contact Day(s)	Jurisdiction	Stratum	N ₁	N ₂	N ₁ N ₂	Σ N ₁ N ₂	Random Cumulants	Number of Accidents Sampled	Selected Cases	Case Number
(1)	(2)	(3)	(4)	(5)	(6)	(7)	(8)	(9)	(10)	(11)	(12)
K	M & Th	Omaha	J	8							
	M & Th	Douglas County Sheriff		8							
	M	Ralston		16							
	M	Valley		24							
A	M & Th	Omaha	K	8							
	M & Th	Douglas County Sheriff		8							
	M	Ralston		16							
	M	Valley		24							
B, C, O, U Transported	M & Th	Omaha	L	8							
	M & Th	Douglas County Sheriff		8							
	M	Ralston		16							
	M	Valley		24							
B, C, O, U Nontransported	M & Th	Omaha	M	7							
	M & Th	Douglas County Sheriff		7							
	M	Ralston		14							
	M	Valley		21							

Accident Type: Light Truck or Van

K	M & Th	Omaha	N	8							
	M & Th	Douglas County Sheriff		8							
	M	Ralston		16							
	M	Valley		24							
A	M & Th	Omaha	P	8							
	M & Th	Douglas County Sheriff		8							
	M	Ralston		16							
	M	Valley		24							
B, C, O, U Towaway Transported	M & Th	Omaha	Q	4							
	M & Th	Douglas County Sheriff		4							
	M	Ralston		8							
	M	Valley		12							
B, C, O, U Towaway Nontransported	M & Th	Omaha	R	2							
	M & Th	Douglas County Sheriff		2							
	M	Ralston		4							
	M	Valley		6							
SUBTOTAL											

HASS
Continuous Sampling System (CSS)
Accident Sampling Worksheet

PSU: 78 - Douglas County, Nebraska
Accident Type: Other Motor Vehicle

Day: _____ Date: ____/____/____
(mo) (day) (yr)

Accident Severity (1)	Contact Day(s) (2)	Jurisdiction (3)	Stratum (4)	N_1 (5)	N_2 (6)	$N_1 N_2$ (7)	$\Sigma N_1 N_2$ (8)	Random Cumulants (9)	Number of Accidents Sampled (10)	Selected Cases (11)	Case Number (12)
K	M & Th	Omaha	S	7							
	M & Th	Douglas County Sheriff		7							
	M	Reister		14							
	M	Valley		21							
A	M & Th	Omaha	T	7							
	M & Th	Douglas County Sheriff		7							
	M	Reister		14							
	M	Valley		21							
B, C, O, U Towaway Transported	M & Th	Omaha	V	4							
	M & Th	Douglas County Sheriff		4							
	M	Reister		8							
	M	Valley		12							
B, C, O, U Towaway Nottransported	M & Th	Omaha	W	2							
	M & Th	Douglas County Sheriff		2							
	M	Reister		4							
	M	Valley		6							
SUBTOTAL											
TOTAL											

TABLE 3-4b
 NASS
 Nonoccupy Study (NYS)
 Accident Sampling Worksheet

PSU: 78 - Douglas County, Nebraska
 Accident Type: Light Truck or Van

Day: _____ Date: ____/____/____
 (mo) (day) (yr)

Accident Severity	Contact Day(s)	Jurisdiction	Stratum	N ₁	N ₂	N ₁ N ₂	Σ N ₁ N ₂	Random Counts	Number of Accidents Sampled	Selected Cases	Case Number
(1)	(2)	(3)	(4)	(5)	(6)	(7)	(8)	(9)	(10)	(11)	(12)
S, C, O, U Nonoccupy	M & Th	Omaha	Y	1							
	M & Th	Douglas County Sheriff		1							
	M	Relston		2							
	M	Valley		3							

Accident Type: Other Motor Vehicle

S, C, O, U Nonoccupy	M & Th	Omaha	Z	1							
	M & Th	Douglas County Sheriff		1							
	M	Relston		2							
	M	Valley		3							
TOTAL											

TABLE 3-5

NASS Sample Selection Within Stratum/Jurisdiction

PSU: _____

Computation to designate sample cases if, and only if, Column 6 of SW is greater than Column 10 of SW	Contact Date							
1. Random Number*								
2. Column (6) of SW								
3. Column (10) of SW								
4. Stratum/Jurisdiction (SJ) Interval (2)/(3) (use two decimals)								
5. First SJ Random Cumulant (4) x (1)								
6. Second SJ Random Cumulant (5) + (4)								
7. Third SJ Random Cumulant (6) + (4)								
8. Fourth SJ Random Cumulant (7) + (4)								

*For each contact date, fill in the random number from row 2 of the Case Load Worksheet. The same random number is to be used as many times as necessary.

NOTE 1: If the contact date shown on the CLAS falls on a holiday on which the police jurisdictions are closed and/or on which the team does not work, then the team will have to visit the jurisdictions on another date (usually the day before or the day after the holiday). In this instance, the team should enter the actual date of the sampling visit as the contact date rather than the date shown on the CLAS. The contact date is always the date on which the jurisdiction was actually visited. The team should use the random number originally assigned for that day.

NOTE 2: In certain designated PSU's (e.g., PSU 01 - Chicago), the contact date will always be the date shown on the CLAS.

On each visit to a jurisdiction, determine the accidents which qualify for NASS that have not been listed on a previous visit. If reliable information on the accident type and severity can be obtained via the telephone, the jurisdiction need not be visited for listing purposes. (Of course, if an accident is subsequently chosen for investigation, a visit will be required.)

The agencies to be visited on a given day should be contacted by the team in the most convenient way. Plan the trips generally so as to arrive last at the agency with the greatest expected number of PARs. At that time, because all accidents to be listed in the PSU for the day have been recorded, the NASS Automated Case Selection System (see 3.2.3 below) or the manually executed backup system--the Sampling Worksheets--can be completed to identify the accidents to be investigated. This will reduce to the fewest the number of copies of PARs that need be made. Also, the largest number of sample accidents will most likely be selected from the largest jurisdiction in the PSU.

3.2.2 Completing the Stratification Record

At each agency, designated on the last page of the CLAS, determine the PARs that are to be listed. Enter the jurisdiction name in column (1) of the Stratification Record. Sort the PARs in ascending order by date and time. [If the number of PARs is large, this sorting can be postponed until after the accidents have first been classified by type and severity. The sorting is only needed if the jurisdiction is selected. In this instance, only the accidents with the same type and severity (stratum) need be sorted (see section 3.2.4 below).]

After the PARs have been sorted, the Stratification Record is to be completed. At the top of the form, enter the PSU number and name, the contact date, and the name or initials of the team member making the visit.

Beginning with the earliest report, determine the stratum in which it belongs:

- a. Determine if a pedestrian or nonmotorist (see P08, Pedestrian or Nonmotorist's Type) was involved,
 - (1) If so, it belongs in one of the A-D strata.
 - (2) If not,
- b. Determine if a motorcycle (in transport) was involved,
 - (1) If so, it belongs in one of the E-H strata.
 - (2) If not,
- c. Determine if a heavy or medium truck (in transport) was involved,

- (1) If so, it belongs in one of the J-M strata.
- (2) If not,
- d. Determine if a light truck or van (in transport) was involved,
 - (1) If so, it belongs in one of the N, P-R, or Y strata.
 - (2) If not, it belongs in one of the S, T, V, W, or Z strata.

Next, determine the most severe injury experienced by any accident victim.

- e. If a fatality occurred, a "1" should be placed in the column ("K") indicating the appropriate accident type fatality stratum: A, E, J, N, or S.
- f. If no fatality occurred but an "A" (column) injury occurred, place a "1" in the appropriate row: B, F, K, P, or T.
- g. If neither a fatality ("K") nor an "A" injury occurred, determine if any victim was transported directly from the accident scene to a treatment facility to be examined for injuries.
 - (1) If so, a "1" should be placed in the "B, C, O, or U transported" column in the appropriate row: C, G, L, Q, Y, V, or Z.
 - (2) If not, a "1" should be placed in the "B, C, O, or U nontransported" column in the appropriate row: D, H, M, R, Y, W, or Z.
 (NOTE: Placement in strata Y or Z is not dependent on the transported issue.)
- h. If a light truck or van accident occurred and the severity is "B, C, O, or U", determine if any in transport vehicle was towed away:
 - (1) If so, place a "1" in strata Q or R.
 - (2) If not, place a "1" in strata Y.
- i. If an other motor vehicle accident occurred and the severity is "B, C, O, or U", determine if any in transport vehicle was towed away:
 - (1) If so, place a "1" in strata V or W.
 - (2) If not, place a "1" in strata Z.

(NOTE: Accidents in strata Y and Z qualify for the Nontowaway Study sample.)

Repeat the above procedure for each PAR. For each jurisdiction, the numbering within a column of the Stratification Record should begin at "1" for the first PAR entered, and increase for each additional PAR classified into that stratum.

After classifying all applicable PARs and entering 1, 2, 3, etc., in the appropriate column, draw a line across the sheet just below the last PAR for each jurisdiction. Write the word "total" in column (2), transcribe the highest number in each column into this row. Add these numbers. The sum should equal the number of PARs listed. If it does not, recheck your work.

All PARs that qualify for NASS should be listed on each contact date shown on the CLAS regardless of the number of accidents (to be investigated) to be selected on that date. If the number of CSS and/or Nontowaway Study accidents to be selected on that date is zero, the team must still list all the NASS PARs on the Stratification Record.

3.2.3 The NASS Automated Case Selection System

The Automated Case Selection System is the primary method for NASS sampling; it must be executed for each contact date listed on the Case Load Assignment

Sheet. Most teams are to execute the Automated Case Selection System on two occasions each week: Monday, after contacts at all jurisdictions scheduled for the day have been made, and on Thursday, after all contacts scheduled for that day have been made. A manual, giving instructions for use of the NASS Automated Case Selection System, is provided to each team. Any problems or difficulties that are not identified in the manual should be referred to your Zone Center.

When circumstances develop where the Automated Case Selection System is not accessible for a 24 hour period, cases may be selected for investigation by completion of the Accident Sampling Worksheet (SW). In these instances, the same PARs must be entered in the Automated Case Selection System sequentially by sampling date when the system again becomes available. The cases which were selected manually are to be checked against those selected by the automated system. The manual execution of the SW is a backup procedure to the NASS Automated Case Selection System. This procedure is discussed below in section 3.2.4.

The Automated Case Selection System must be executed on each contact date shown on the CLAS regardless of the number of accidents (to be investigated) to be selected on that date. If the number of CSS and/or Nontowaway Study accidents to be selected on that date is zero, the team must still enter all the accidents listed on the Stratification Record in the automated system.

3.2.4 Completing the Worksheets

The procedure to select accidents to be investigated consists of two parts. First, the CSS accidents are selected; then, the Nontowaway Study accidents are selected. The same algorithm is used for both samples of accidents. However, it must be executed separately for each sample.

The first task in the selection process is to complete the top portion of the Case Load Worksheet (CLW).

1. Print the PSU number and name in the space provided at the top of the form.
2. Enter the contact day and date (e.g., Monday, January 2) in the first unused box below the words "Contact Days and Dates." Note that the CLW consists of three columns, each divided in half. Each contact date requires one double column, the left-hand side for selecting CSS accidents and the right-hand side for selecting Nontowaway Study accidents.
3. From the Case Load Assignment Sheet (CLAS) transcribe the number of each type of accident to be selected on this date to row 1 of the CLW. Enter the number of CSS accidents to be selected in the left-hand column (under the notation "CSS") and the number of Nontowaway Study accidents to be selected in the right-hand column (under the notation "NTS").
4. Transcribe the random number for this contact date from the CLAS to row 2 of the CLW. The same random number will be used for both the left-hand and right-hand columns.

Variable Name: Driver Education (cont'd.)

There are three specific classes of drivers considered. These are: passenger vehicle drivers (including light trucks and vans), motorcycle drivers, and heavy truck drivers (GVWR over 10,000 lbs.).

The table below shows which attributes of this variable apply to the different driver classes.

Type	V14	D09	D16
Driver Not Present	Any	2	Blank
Automobile or Light Truck Driver Training	01-13,40-42,48-56,58,59,69,80-82,88	1	0-3,8,9
Motorcycle Driver Training	20,21,28,29	1	0,1,6,9
Heavy (and Medium) Vehicle Driver Training	30-32,38,39,70-75,77-79,81,83	1	0,1,4,5,7-9
Unknown	89,99	1	9

The type of driver training that heavy vehicle and motorcycle drivers receive is of particular interest. If the driver is driving a heavy vehicle then this variable measures the type of training the driver has received in vehicles over 10,000 lbs. GVWR. Since codes "4" (Truck driver training school), "5" (Motor carrier program - On-the-Job-Training), and "7" [Vocational training (CETA, Job Corp, other government sponsored training, etc.)] are assumed to use heavy vehicles, these codes are not applicable for motorcycle drivers or automobile or light truck drivers. Similarly codes "2" (High school driver training) and "3" (Commercial driver training) apply only to automobile or light truck drivers, and code "6" (Motorcycle driver training) applies only to motorcycle drivers. Code "8" (Other formal driver training (e.g., college, military, etc.) applies only to automobile or light truck drivers and heavy vehicle drivers. Codes "0" (No formal driver training) and "1" (In training at time of accident) must be applied within the context of the driver's status.

Code "0" (No formal driver training) should be used if a driver received no driver training for the class vehicle he/she was driving at the time of the accident.

Code "1" (In training at time of accident) means that the driver must have been enrolled in a formal driver training class when the accident occurred.

Code "3" (Commercial driver training) refers to organizations that provide passenger type vehicle driver training for a profit. It excludes nonprofit organizations, employee training programs, and rehabilitative programs which use passenger type vehicles. These should be coded as "8" (Other formal driver training).

- b. If the entry on row 5 of the CLW is not zero, and less than row 1, all accidents that made up the count are to be in the sample. These are identified as "Certainty Cases." Continue at row 1A of the CLW.
11. Enter on row 1A of the CLW, the remaining number of accidents to be selected. This is the difference between row 1 and row 5.
 12. Enter on row 2A of the CLW the total weighted accident count for the certainty cases identified in step 5 of the CLW; this is the total of the column (7) entries on the SW for the certainty accidents. After determining this total, delete (cross out) all column (7) entries on the SW for the certainty cases and determine a new total of the remaining column (7) entries. Enter this total on the last page of the SW at the foot of column (7).
 13. Enter on row 3A the remaining weighted accident count. This is the difference between the row 3 and the row 2A entries on the CLW. This result must equal the new total of the column (7) entries that you have just entered at the foot of column (7) of the SW. If it does not, recheck your work.
 14. Enter on row 4A of the CLW the second sampling interval. This is the quotient of the entry on row 3A to row 1A of the CLW. Show the quotient to two decimals.
 15. Examine again the entries in column (5) of the SW, and count the number of accidents that have values of W_i greater than or equal to the second sampling interval given on row 4A of the CLW. Enter this count on row 5A of the CLW.
 - a. If the entry on row 5A is zero, or greater than or equal to the entry on row 1A, then transcribe the entry on row 4A to row 4 of the CLW and go to row 7 on page 2 of the CLW for the next operation (step 21 of these instructions).
 - b. If the entry on row 5A of the CLW is not zero, and less than row 1A all accidents that made up the count are to be in the sample. These are also certainty cases. Continue at row 1B of the CLW.
 16. Enter on row 1B of the CLW the remaining number of accidents to be selected. That is row 1A minus row 5A.
 17. Enter on row 2B of the CLW the total weighted accident count for the certainty cases identified in step 5A of the CLW. This is the total of the column (7) entries on the SW for the certainty accidents. After determining this total, delete all column (7) entries on the SW for the certainty cases and determine a new total of the remaining column (7) entries on the SW. Enter this total on the SW at the foot of column (7).
 18. Enter on row 3B the remaining weighted accident count. This is the difference between the row 3A and row 2B entries on the CLW. This result must equal the new total of the column (7) entries that you have just entered at the foot of column (7) of the SW. If it does not, recheck your work.

19. Enter on row 4B of the CLW the third sampling interval. This is the quotient of the entry on row 3B to row 1B of the CLW. Show the quotient to two decimals.
20. Examine again the entries in column (5) of the SW and count the number of accidents that have values of W_i greater than or equal to the third sampling interval given on row 4B of the CLW. Enter this count on row 5B of the CLW.
 - a. If the entry on row 5B is zero, or greater than or equal to the entry on 1B, then transcribe the entry on row 4B to row 4 of the CLW and go to row 7 on page 2 of the CLW for the next operation (step 21 of these instructions).
 - b. If the entry on row 5B is not zero, and less than row 1B all accidents that made up the count are to be in the sample. These are also certainty cases. Continue on the back of this sheet with similar steps 1C - 6C, 1D - 6D, etc. as required.

The next steps involve determining the random cumulants using the CLW form:

21. Multiply row 4 (the sampling interval) by the row 2 random number. Record this product (to two decimals) in row 7, first random cumulant. Be sure that the correct sampling interval is used, i.e., if steps 1A - 6A were executed, then the entry on row 4A would have been transcribed to row 4. Similarly if steps 1B - 6B were executed, then the entry on row 4B would have been transcribed to row 4.
22. Repeatedly add the row 4 interval to the row 7 first cumulant to obtain the remaining cumulants, recording them in rows 8 through 14. Stop when the random cumulants exceeds the total of the column (7) SW entries.

The following step involves the Sampling Worksheet (SW).

23. Complete column (8) $N_i W_i$: Cumulate the column (7) entries on the SW; recording the cumulation in column (8); do not include any column (7) entries for the certainty cases. Thus, each value in column (8) is the sum of all column (7) entries for noncertainty accidents up to and including that row. The last entry in column (8) must equal the new total shown at the foot of column (7). If it does not, recheck your work.

Transcribe the Random Cumulants onto the Sampling Worksheet (SW) in the following way:

24. Column (9) Random Cumulants: Beginning with the first cumulant from the CLW and starting at the top of the worksheet, locate the first row in column (8) whose entry equals or exceeds the cumulant. Record the First Random Cumulant in column (9) of this row. Repeat this process--2nd, 3rd, etc., cumulant--until the last row has been reached. (NOTE: If the entry in column (8) is so large that more than one cumulant falls on that row, transcribed all the random cumulants that belong in that row.) At this point, the number of random cumulants transcribed into column (9) should equal the number of accidents to be sampled as given in row 1A or

1R--where certainty cases exist, or row 1--where certainty cases do not exist--of the CLW. If not, recheck your work.

25. Column (10) Number of Accidents Sampled: Record the number of cumulants (1 or more) appearing in column (9) for the row.
26. Column (11) Selected Cases: Examine the column (6) entry for all rows now having an entry in column (10) (i.e., for which accidents are to be selected).
 - a. If the entry in column (6) is less than or equal to the entry in Column (10), then all accidents in the stratum from that jurisdiction are to be investigated. Transcribe the entry in column (6) to column (11).
 - (1) If the entry in column (6) is greater than the entry in column (10), a further step of sampling is required. In this case, the following must be done on the NASS Sample Selection within Stratum/Jurisdiction (SSSJ) form:
 - (a) Write the date of contact in the first available column heading of the SSSJ. Transcribe the random number from row 2 of the CLW for this contact date to row 1 of the SSSJ. Finally, transcribe column (6) of the SW to row 2 of SSSJ and column (10) of the SW to row 3 of SSSJ for the appropriate contact date.
 - (b) Divide row 2 by row 3 to form the stratum/jurisdiction (SJ) interval. Record this quotient in row 4.
 - (c) Multiply row 4 by row 1 to get the first SJ random cumulant. Record this product in row 5.
 - (d) Repeatedly add the row 4 SJ interval to the row 5 cumulant and obtain the remaining cumulants. Record these in rows 6 through 8, stopping when the random cumulant exceeds row 2.
 - (2) Round the random cumulants that do not exceed row 2 (SSSJ) up (e.g., 3.1 and 3.8 both are rounded up to 4), and transcribe the numbers, in their ordinal form (e.g., 1st, 2nd, etc.) onto the Sampling Worksheet, column (11). To identify the selected accidents, examine the stratum entires for the jurisdiction given on the Stratification Record. These numbers run from one up to the number which occurred [SW - column (6)] and uniquely identify a PAR number, date and time. If you have not previously sorted the PARs in ascending order by date and time, then do so before continuing. (See section 3.2.2 for instructions). Choose the accident or accidents whose sequential number (on the Stratification Record) matches the rounded random cumulant (SSSJ - row 5) or cumulants (rows 5, 6, etc.). Indicate the number of the accident (e.g., by date and time) in column (11).
27. Column (12) Case Number: Starting at the top of the Sampling Worksheet, assign a case number to each selected accident [i.e., whenever there is an entry in column (11)]. Enter the case number in column (12).

The case number is composed of two parts: a three-digit consecutive number followed by the stratum letter of the accident. Assign the next unused consecutive number to the first selected accident and continue. Assign case numbers in stratum/jurisdiction order (i.e., as listed on the Sampling Worksheet). If the entry in column (10) is greater than one (i.e., more than one accident was selected from the same stratum/jurisdiction combination), then assign the case numbers in the order of their sequential numbers on the Stratification Record--column (11).

3.3 Sampling Problems: How To Handle Them

The following section describes problems that sometimes arise in sampling and outlines ways to address them. A critical element in each case is time, that is, the longer the period between the occurrence of the problem and the implementation of some corrective action, the less likely are our chances of resolving it. If a problem occurs which is not listed below, the investigator should inform his/her CTM or the NCSA Sampling person at once.

Problem 1

A team member performs the sampling procedures correctly but picks up the wrong PAR at the police jurisdiction and investigates the wrong accident. Zone Center discovers the error when it receives hard copy.

Action:

Case 1 - If the incorrect PAR comes from the same stratum and jurisdiction as the correct PAR then the Zone Center should accept the data for the case. However, the team should be notified that it made an error.

Case 2 - If the incorrect PAR comes from a different stratum or jurisdiction than the correct PAR, then the data for that case should be deleted from the file. The Zone Center should tell the team to 1) obtain a copy of the correct PAR and 2) code the data forms using information from the PAR and all other available data sources (i.e., medical record, scene inspection, interview, etc.) Information that can not be obtained will be coded as unknown. The team will enter the data on RDE and send the hard copy to the Zone Center.

Problem 2

A team member lists and stratifies accidents correctly, but the PAR for the selected case is missing when the investigator returns to the police jurisdiction after sampling.

Action:

Case 1 - After all attempts to locate the PAR have been exhausted unsuccessfully, call the Zone Center to have the case deleted. If the

determination is made on the same day or after the contact day and the next contact day has not yet passed, add an extra case to the next contact day's sampling load and notify NHTSA immediately. In any event, the next consecutive contact day is not to pass without notifying NHTSA and the Zone Center.

Case 2 - If the determination is made after two consecutive contact days have passed, call the sampling person at NCSA for instructions and notify the Zone Center.

Problem 3

Team member does not find any CSS accidents to list.

Action:

This is not really a problem. The automated case selection system will not select any CSS cases for investigation since any fraction of zero is zero. The team should (1) call the Zone Center and tell what happened, and (2) write "No CSS Cases Listed" on the sampling printout.

Problem 4

Team member lists some CSS accidents, but fewer than or equal to the number of CSS cases to be selected on that day.

Action:

If the number of accidents listed is less than the number to be selected, the automated system will result in at least one 'multiple hit' (i.e., an accident selected more than once). Therefore, when the number of accidents to be selected is less than the number of accidents listed, the number of accidents requested must equal the number listed. When this circumstance occurs, the Zone Center and the NCSA sampling person should be notified.

NOTE: Multiple hits may occur in other situations. If one does occur, (e.g., if the automated case selection system selects fewer cases than were requested), the Zone Center and the NCSA sampling person should be notified.

Problem 5

Team member does not find any nontowaway cases to list on a day on which it is supposed to select one.

Action:

The team should (1) write "No N-T SS Cases Listed" on the sampling printout and (2) call the Zone Center. The Zone Center should call the NCSA

sampling person for instructions. The Zone Center instructions will include having the team select a nontowaway case on its next contact date.

Problem 6

Team member can't list and select case(s) on the designated contact date due to extreme weather conditions, (in particular snow hazards).

Action:

Visit the assigned police jurisdictions on the next possible day, using the same random number originally assigned.

NOTE: Whenever you select the sample on a day other than the contact date listed on the Caseload Assignment Sheet you should use the originally assigned random number.

Problem 7

Team member lists and selects accidents properly according to the information on the PARs. However, upon visiting the scene it is determined that the location falls outside of the sample jurisdiction.

Action:

This is not really a problem. Any case that is identified by the PAR as being a valid NASS case and qualifies for NASS study with the one exception of its location (not discernable at the time it was listed) should be investigated.

Problem 8

Team member lists and selects accidents properly according to the information on the PARs. However, during the investigation it is determined that the case does not meet the criteria for accidents which qualify for NASS study (Section 2.1 of the Coding and Editing Manual).

Action:

Case 1 - If the determination is made on the same day or after the contact day, or if investigations have already begun on the other selected cases, notify the Zone Center and headquarters immediately. Also add an extra case to the next contact day's requirement. Make a note on the sampling sheet explaining the additional case before sending it in. In this case the sampling interval for the day on which the case was dropped will be changed by headquarters before compiling the analysis file.

It is extremely important that when problem 7 & 8 arise that the Zone Center and Headquarters are notified immediately, and explanatory notes made on the sampling sheets. Dropped cases should also be reported to headquarters at the end of each calendar year along with the reasons why they were dropped.

3.4 Beginning of Year Sampling Instructions

At the beginning of a new CSS calendar year, some accidents that occurred in the previous year will be listed during the stratification of PAR's at your police jurisdictions and possibly selected for investigation. If the selected accident has an accident date of the current CSS calendar year, then follow the normal CSS sampling instructions.

If a selected accident has an "Accident Date" of the previous CSS calendar year, then the case should be handled as follows:

1. The automated system will assign a consecutive CSS case number from the previous year.
2. Use the forms from the previous year to record all case information.
3. Because the accident occurred in the previous year, the case report must be submitted with the December (of the previous year) submission.

If your PSU has been assigned new police jurisdiction(s) as of the new calendar year from which to sample, then for those new jurisdictions, list only those accidents which occur in the new CSS calendar year.

4.0 OVERVIEW OF INFORMATION TO BE COLLECTED ON CASES SAMPLED

For each case sampled, please include in the case report a copy of the police report, newspaper photos and articles, correspondence, collision diagram with diagram log, slides (including index), the applicable continuous sampling subsystem data collection forms with field logs, medical injury records, driver records, CRASH and PDF output.

4.1 Sequencing of Case Materials

Case report forms and miscellaneous materials are to be sequenced in conformity with the guidelines depicted in Figure 4-1. There are eight distinct groupings which may exist with each case, and while the number of groupings may vary with each accident, it is important for the case reviewer (team or Zone Center) that the composition of the eight groups be maintained.

The first group contains the police report, newspaper photographs, articles, and other miscellaneous, non-NASS generated materials. This group will give the Zone Center reviewer a general appreciation of the accident from non-NASS sources and facilitates review of sampling. The documents in this group should be bound with either a paper clip or stapled. The group will appear in every case, although it will often be composed only of the police report.

The second group contains the Accident Collision Diagram with Accident Collision Diagram Log, slides, and the slide index; thus, it provides the reviewer with a general overview of the case based upon the NASS investigation. Differences between the two versions (Non-NASS and NASS) are to be expected periodically, and preliminary review of this and the preceding group will alert the reviewer to those differences and their eventual resolution in the final NASS version. This group should appear in every case, bound together with a paper clip.

Third, the Accident Form with the Accident Log on the back of the last page forms a group which will appear in every case.

Fourth, all Pedestrian and Nonmotorist Forms (with logs) should be grouped together, beginning with pedestrian and nonmotorist number 1. Official injury information obtained for any pedestrian or nonmotorist should be identified by a pedestrian or non-motorist number then stapled to the back of the respective form. This will collate the injury data to the pedestrian or nonmotorist and save time which might be lost searching through the various forms to make the correct association. Pedestrian and Nonmotorist forms will appear only in cases where applicable; it is desirable to use a paper clip to bind the forms in this group if there are more than one.

The fifth group contains a Vehicle Form, the state vehicle registration record, the Driver Form, the state driver record for that driver, forms for all the occupants contained in the vehicle, and any official injury documents for those occupants. The first form in this group is the Vehicle Form (with log), or Vehicle For Non-Towaway Accident Form (with log), for this vehicle which has any state vehicle registration records stapled to the back of it. The Driver Form appears next and will have any state driver record stapled to the back of it. This will be followed by the first Occupant Form (with log) for this vehi-

FIGURE 4-1

SEQUENCE OF CASE MATERIALS

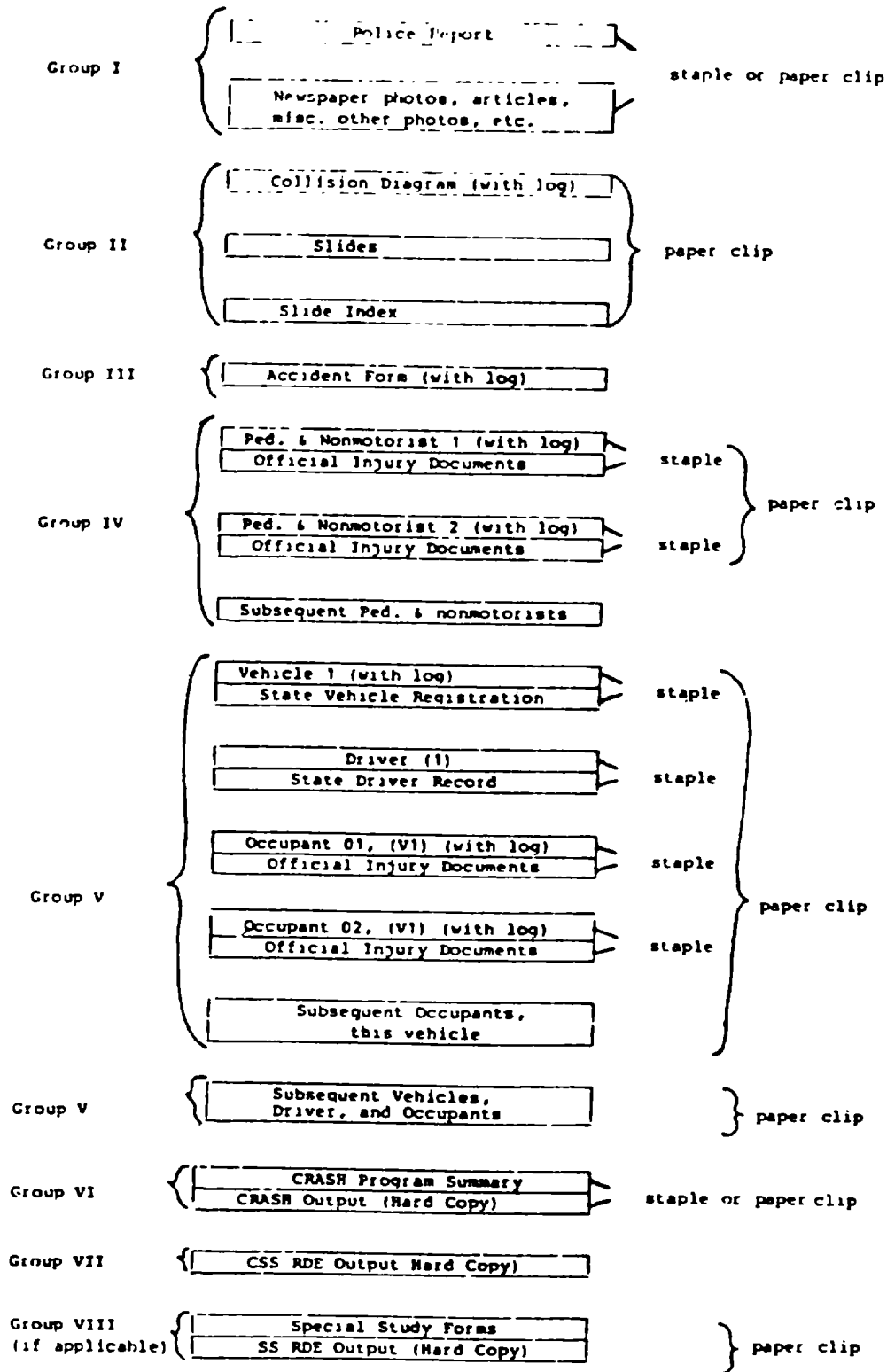

cle which has any official injury documents stapled to the back of it. All additional Occupant Forms (with logs) will follow in numeric order [Occupant 02 (V1), Occupant 03 (V1), etc.]. At least one group of this type will appear in every MASS case. All the forms associated with this group should be bound together with a paper clip. Additional vehicles, registration records, their drivers, state driver records, occupants, and official injury documents should be grouped in a similar manner. Thus, each group may be thought to represent a vehicle and its occupants; and, each such group physically distinguishes one vehicle and its occupants from any other.

The sixth group is composed of the CPASH Program Summary and the CRASH Output (hard copy), if the program has been exercised for the collision. Upon reviewing the above forms and having become familiarized with the accident, the reviewer is then prepared to evaluate both the appropriateness of using the program and the viability of the various inputs on the CRASH Program Summary. These two items, the summary and any output (always include the input data), should be bound together with a paper clip.

The seventh group is composed of the Remote Data Entry (RDE) output.

Finally, the eighth group is composed of any Special Study forms completed for the accident and the hard copy of the Special Study Remote Data Entry Output. These should be bound together with a paper clip.

4.2 Information Required on Field Forms (Mandatory Variables)

Case Identification Variables--When using the remote data entry system to enter the field data, certain information is required on each field form (log data are not entered) before it will be accepted. Every field form submitted must have a Primary Sampling Unit Number, a Case Number-Stratification, Record Number, Transaction Code, Version Number, and Investigator I.D. Number. The Record Number and Version Number will be preprinted on each of the forms. Team members should fill out the Primary Sampling Unit Number, Case Number-Stratification, Transaction Code Number, and the Investigator I.D. Number.

Accident Form--For each accident investigated, one Accident Form must be filled out. The additional mandatory information needed on this form is the Date, Number of Vehicle Forms Submitted, and Number of Pedestrian & Nonmotorist Forms Submitted.

Pedestrian and Nonmotorist Form--If a Pedestrian and Nonmotorist Form is submitted, the only additional mandatory data item is the Pedestrian or Nonmotorist's Number.

Vehicle Form--For each accident investigated, at least one Vehicle Form (or Vehicle For Non-Towaway Accident Form) must be submitted. The additional mandatory information to be included on this form consists of the assigned Vehicle Number and the Number of Occupant Forms Submitted.

Driver Form--For every Vehicle Form there must be included one Driver Form. The additional mandatory data items to be filled out on the Driver Form are Vehicle Number and Driver Presence in Vehicle.

Occupant Form--When Occupant forms are filled out, Vehicle Number and Occupant Number must always be present.

Treatment of Missing Cases--When accident-involved drivers, vehicles, occupants, pedestrians, or nonmotorists cannot be located or interviewed and all data items are missing, the appropriate form must be filled out with missing data codes and submitted with the case. One exception to this rule is permitted. In accidents which involve a bus, complete an Occupant Form for every person where information can be obtained (i.e., either through the police or leads which subsequently develop). For those occupants where no information exists, no Occupant Form is required. Once again, this exception is for busses only.

4.3 Update Procedures for Hard Copy Field Forms

Data elements which may be updated in the hard copy case report are restricted to certain variables which appear on either the Pedestrian and Nonmotorist, Vehicle, Driver, and Occupant Forms. No other data will be updated if it is acquired after the initial submission of the case. Note that for RDE, any variable except for the mandatory variables may be updated before the case is forwarded to the Zone Center. Update records have been developed for the variables which are allowable hard copy update candidates. Update records which have been specially designed to accommodate these variables are not to be included with the initial submission of the case; instead, they are retained at the PSU and filled out partially upon initial case submission then completed when the update information arrives. On the original case form all data variables which the investigator intends to update should be coded with any available appropriate information or the code designating "unknown". In addition, the variable number should be circled. This will "signal" that an attempt will be made to update that data variable. In the case of injury updates, the "Update Candidate" circle should be marked in the affirmative. This procedure applies only to those data variables on the Pedestrian and Nonmotorist, Vehicle, Driver, or Occupant Forms, which are designated below as candidates for updating.

The investigator is to complete the required sections prior to initial case submission so that the subsequently acquired information may be associated with the right case and vehicle/pedestrian or nonmotorist/occupant number. The newly acquired information should be entered on the front of the Update Forms and any supporting documents attached to the back.

Pedestrian and Nonmotorist Update Record--This form is to be used when the investigator expects to receive data regarding alcohol tests, working days lost, injuries or treatment received by any pedestrian/nonmotorist, and the data were not obtained from the hospital, private physician, pedestrian, etc., before the initial submission. The additional information required on this form allows the investigator to update variables A08, P09, P10, P20, P21, P22, P28 through P69, P73, and P74, based on subsequent receipt of official or interviewee data where necessary. These data would be difficult to update without recorded knowledge regarding the initial coding of Final Stratification (A08), Treatment - Mortality (P20), Hospital Stay (P21), Working Days Lost (P22), injury data (P28-P69), Alcohol Test Results (P73), and Time of Death (P74). The data on the specific injuries coded on the initial submission

(P28-P69) may be combined with the new injury data using the NASS injury coding rules to revise the injury coding on the updated version. Also, it is suggested that a copy of the sketch of the involved motor vehicle (page 3A, 3B, etc., of the Vehicle Form) be made prior to the initial submission, so that the investigator will be able to check for specific components contacted by the pedestrian when coding the injury sources on the update form.

Vehicle Update Record--This form is to be used to update both the Vehicle for Non-Towaway Accident Form as well as the Vehicle Form. It is to be used if Vehicle Model Year (V11), Vehicle Make (V12), Vehicle Model (V13), Body Type (V14), Vehicle Identification Number (V61), Registration of Vehicle (V62), or Vehicle Curb Weight (V75) have not been determined prior to submission of the case. Additionally, A08, Final Stratification can be updated if Vehicle type changes based on the acquisition of new information. It should be noted that this update form was initiated to allow investigators to obtain data from running vehicle registrations through cooperating agencies.

Driver Update Record--This form is to be used if Alcohol Test Results (D33), License Source (D34), Compliance with License Restrictions (D35), Driver License Status (D36), Driver License Type Compliance (D37), Driver License Restriction (D38, D39), or convictions/suspensions/revocations/accidents (D40-D44) are not known at the time of initial submission.

Occupant Update Record--This form is similar to the Pedestrian and Nonmotorist Update Record with the exception that there exists the need to identify both the vehicle and occupant number. It should be used when the investigator expects to receive data after the initial submission. Additional information required on this form prior to initial case submission allows the investigator to update variables A08, O09, O10, O20, O21, O22, O28-O69, and O71, based on subsequent receipt of official or interviewee data. These data would be difficult to update without recorded knowledge regarding the initial coding of Final Stratification (A08), Treatment - Mortality (O20), Hospital Stay (O21), Working Days Lost (O22), injury data (O29-O69), and Time of Death (O71). This information may then be combined with the new injury data using the NASS injury coding rules to revise the variables on the updated version. Also, it is suggested that a copy of the interior sketch (page 7 of the Vehicle Form) be made prior to the initial submission, so that the investigator will be able to check for specific components contacted by the occupant when coding the injury sources on the update form.

Update Filing and Submission Instructions--The investigator must complete each of the sections on the above forms, as required, prior to the initial submission. This allows the new information (update form) to be associated with the corresponding field form in the initial submission, and allows the originally coded data to be combined with the new data (using the NASS injury coding rules).

All update records may then be stored in a three-ring binder and segregated into three sections: (1) Vehicle Update Record Forms, (2) Driver Update Record Forms, and (3) Pedestrian and Nonmotorist and Occupant Update Record Forms. Each new addition of an update record may then be indexed by case number, vehicle number, pedestrian or nonmotorist number, and occupant number. They may also be partially cross-indexed alphabetically based on the name of the

driver, pedestrian/nonmotorist or occupant in the appropriate section. This will facilitate the processing of inquiries from Zone Centers as well as the retrieval of the update record when the driver record or official medical data is received.

The name of the individual and any other descriptive information, unique to the team, which may identify the individual should be sanitized from the Pedestrian or Nonmotorist Update Record, Driver Update Record, and/or the Occupant Update Record and the attached reports after the information from the latter has been included on the update record.

Update records should be accumulated, packaged in an individual Zone Center approved size manilla envelope (but not one envelope for each update), which identifies the PSU and is boldly marked: UPDATES, and sent to the Zone Center on a periodic basis according to the schedule in Section 5.2. If the updates are not obtainable by the due date, the reasons the updates could not be obtained are to be indicated on the update record and sent to the Zone Center. All updates or reasons the updates were not obtainable must be submitted to the Zone Center within 120 days of the date the case was sampled.

The update records, described above, will be attached by the Zone Center to the corresponding forms included in the initial submission to the Zone Center.

4.4 Form Logs

The field forms (Accident, Pedestrian and Nonmotorist, Vehicle, Driver, and Occupant) have a unique log printed on the back of the last page. These logs provide information with respect to the acquisition and processing of accident data in the NASS system as well as the quality of data collected. This information is used to establish reasonable acquisition expectations, to identify and evaluate Zone Center quality control effectiveness, and to provide complete and timely feedback to team members. Careful examination of the logs will reveal that minimal effort is required for the investigator to answer the questions, particularly if the entries are made in conjunction with, and at the time, the particular task is accomplished. The form logs also contain sections which will be completed by the Zone Center during the review process.

4.4.1 Accident Log

The sections to be completed by the PSU are identified under the heading "Completed by Team" or "For Team Use". The block at the top of the page labeled "Forms: For Team Use" is an area where the investigator accounts for the number of forms which are required and ultimately included with the case. The information in this section is transcribed to the front of the case envelope before submission to the Zone Center. Many of the forms which are needed under the required component of this section may be identified early in the investigation; thus, this section will serve to aid the investigator in determining the status of the case while it is in progress. At the time of the initial submission, or final submission (if there are to be no updates for the case), the investigator uses this section to verify that the number of forms included in the case report equals the number of forms required, with the exception of medicals. The number of medicals (Official Medical Data) required should reflect the number of people who were treated in a hospital, medical

clinic, etc. This is true independent of the ability of the PSU to obtain the data. The number of medicals included in the case report will reflect the number of medicals (on a per person basis) which are included in the case at the time of initial submission.

The block marked "Completed by Team" is to be filled out by the appropriate investigator as the different activities described are completed. Each of Questions 1 through 14 (discussed below) must be completed before the case is submitted. Questions 1 through 6, commonly called the "header data" is coded the same as Variables A01 through A06 on the Accident Form. Question 7, Date of Accident, is filled in with the same month, day, and year as is designated under variable A07 on the Accident Form. Question 8, Date Sampled (listed), is the contact day listed on the Case Load Assignment Sheet (CLAS), unless the contact date was a holiday, in which case the date the case was actually listed would be coded. Question 9, Date Scene Field Work Completed, is the date the investigator locates and inspects the accident scene. Question 10, Completing Person, is to be filled in with the number of the investigator who located and inspected the scene, and who will assume responsibility for the completeness and overall quality of the case. The status of the scene location, mapping of the scene and the quality of the scene drawing is documented under Question 11. Question 12, Date Case Released to Zone Center, is filled in with the date the RDE "release" transaction was completed. Cases are to be released before they are forwarded to the Zone Center. The status of the case upon submission to the Zone Center is recorded under Question 13. If the case is complete and requires no updates, box (1) is checked. If the case is to be updated, box (2) is checked, and if the case was dropped, box (3) is checked and the reason noted. Question 14, Are Special Studies Applicable, is used to record the status of special studies. For each special study included with the case, a "1" is placed in the column for the number of that special study. The remaining special study columns are coded with "0". If the special study is not applicable to the PSU, code the appropriate columns "8." This supersedes the instructions on the 1984 CSS Accident Data forms. The remainder of the Accident Log is completed by the Zone Center quality review staff and is identified under the heading "Completed By Zone Center". This section is completed by the case reviewer as the case report flows through the quality review process. Each of Questions 15-29 must be completed for the case to complete the quality review process.

Question 15, Date Hardcopy Received at Zone Center, is filled in with the date the hardcopy arrives at the Zone Center. Question 16, Type of Review, is coded "1" if the case involves an all variable review. If only select (or key) variables from the case are reviewed, Question 16 is coded "2". Alternatively, if the review process involves reviewing a given percentage of the investigators cases (i.e., key case review) a "1" is coded for those cases reviewed and a "2" is coded for those cases not reviewed. Question 17, Date Review Completed, is filled in with the date that all quality review associated with the case is completed. Question 18, Reviewed By, is to be filled in with the number of the person who is primarily responsible for the review of the case and made the assessment that the review is complete. Question 19, Case Status, is coded "1" if the review is completed and all updates are received and incorporated. If the review is not completed or all updates not received, Question 19 is coded "2". Question 20, Date Case Released to Master File, is filled in with the date the RDE "approval" transaction was completed. The remaining Accident Log

Questions 21-29 are completed by the Zone Center using the criteria indicated for each data code for that question. If the review process involves reviewing a given percentage of the investigator's cases, Questions 21-29 are not completed for cases coded "2" under Questions 16, Type of Review.

4.4.2 Pedestrian and Nonmotorist Log

Each attempt to contact the involved pedestrian or nonmotorist is recorded on the interview contact record portion of the log, which is non coded and is provided on the back of page 7 of the field form as an aid to the investigator. The date and time of the contact (military), along with the initials of the contacting investigator, manner of contact, and result of contact are to be recorded for each attempt. A detailed listing of the codes to be used for the different "manners" and "results" of the contact are presented below the contact record. The final attempt (whether successful or not) should be coded in Questions 8 through 12 of the log. If multiple interviews are obtained, the investigator may use the interviewee contact record to document them, yet only the contact of the principle interviewee should be documented in Questions 8 through 12. Questions 1 through 7 are coded the same as Variables P01 through P07 on the Pedestrian and Nonmotorist Form. Question 8, Manner of Last Contact Attempt, is coded with the methodology used in the last attempt to obtain an interview. Question 9, Result of Last Contact Attempt, records the degree of success in obtaining an interview. Responses "01" through "05" and "10" reflect no personal contact. Responses "06" through "08" reflect unsatisfactory contact attempts. Response 09 reflects unsuccessful attempts to obtain an interview for reasons other than that which is documented in the other codes, and Responses "11" and "12" reflect a completed interview. Question 10, Date Interview Completed, is coded with the month and the date a successful interview was conducted. If no interview is obtained (i.e. Question 9 = 01 - 10) then this question and Question 11 are coded "0's." Question 11, Completing Person, is the investigator's I.D. number who completed the interview. Question 12, Source of interview data, tells us the source of the Pedestrian/Nonmotorist data obtained during the interview. The objective in NASS is to interview the Pedestrian/Nonmotorist him/herself -- response 2 (same person). If an interview cannot be obtained with the pedestrian/nonmotorist him/herself, certain surrogates may provide all the data necessary to complete the form. For example, question 12 also identifies other persons who may provide this information if the pedestrian/nonmotorist is fatally injured, incapacitated, or for other reasons cannot be or refuses to be interviewed. Question 13, Reasons Medical Data Not Obtainable, describes not only the disposition of medical data, but also if the investigator was not able to obtain the data. Codes "02" through "07" provide reasons why, while code "09" reflects a large lag time (greater than 120 days from date sampled) in obtaining the record. If the official medical injury data are requested but not received at the time of case submission and Question 13 is coded as "08" (To be updated), then the investigator should complete a Pedestrian and Nonmotorist Update Record Form. This completes the information required from the team. The remaining questions are filled out by the Zone Center.

Question 14, Date Medical Record Update Received, is filled in with the date the medical update record arrives at the Zone Center. Question 15, Reviewed By, is filled in with the number of the person who completes the medical update review. The remaining questions, 16-17, are completed by the Zone Center using

the criteria indicated for each data code for that question. If the review process involves reviewing a given percentage of the investigator's case, Questions 15-16 are not completed for cases coded "2" under Accident Log Question 16, Type of Review.

4.4.3 Non-Towaway Vehicle Log

The Non-Towaway Vehicle Log must be completed for all vehicles which are sampled in the nontowaway strata "Y" or "Z". The original stratification (i.e., the character in the case number) is used in making this determination. The only questions filled out on the Non-Towaway Vehicle Log by the team are Questions 1 through 8. Questions 1 through 7 are coded the same as Variables V01 through V07 on the Vehicle for Non-Towaway Accident Form. Question 8 determines if vehicle registration information has been obtained at the time the case is submitted to the Zone Center. If Question 8 is coded as "8", (To be updated), then the investigator must complete a Vehicle Update Record Form. If the vehicle is inspected and/or all the updatable information is completed, then Question 8 is coded "0". Question 8 is coded "1" if the vehicle registration is requested and received before case submission to the Zone Center. Code "2" is used if the PAR reports the vehicle as hit and run with no identification. Codes "3-6" are used if a registration record is requested and returned without information on the vehicle. Code "7" is used for non-NASS states and foreign governments for which there is not currently an established relationship for obtaining vehicle registration records. Code "9" is used if an update record is received after the quarterly close out of a file. This completes the information required from the team. The remaining questions may be completed by the Zone Center.

Question 21, Date Official Record Received, is filled in with the date the update record arrives at the Zone Center. Question 22, Reviewed By, is filled in with the I.D. Number of the person who completes the update review.

4.4.4 Vehicle Log

The Vehicle Log must be completed for all vehicles which fall in a sampling stratum other than "Y" or "Z". All questions (1-15) on the log should be completed by the investigator for each vehicle. Questions 1 through 7 should be coded the same as Variables V01 through V07 on the Vehicle Form. Question 8 determines if vehicle registration information has been obtained at the time of case submission to the Zone Center. If it is coded as "8", (To be updated) then the investigator must complete a Vehicle Update Record Form. If the vehicle is inspected and/or all the updatable information is completed, then Question 8 is coded "0". Question 8 is coded "1" if the vehicle registration is requested and received before case submission to the Zone Center. Code "2" is used if the PAR reports the vehicle as hit and run with no identification. Codes "3-6" are used if a registration record is requested and returned without information on the vehicle. Code "7" is used for non-NASS states and foreign governments for which there is not currently an established relationship for obtaining vehicle registration records. Code "9" is used if an update record is received after the quarterly close out of a file. Questions 9 and 10 determine the lag time between the date the accident was sampled (Accident Form Log) and the date the vehicle was inspected as well as the number of the investigator who completes the vehicle inspection. If a vehicle inspection is not

completed, questions 9 and '0 should be coded "0's." Question 11 identifies the reasons why a vehicle inspection could not be completed. Question 12, Reason Highest Total Delta V Unknown, identifies the reasons why the CRASH or other reconstruction programs could not be utilized (the negative codes "3" through "9" are prioritized for coding). Question 13, Confidence in CRASH Results (for Highest Delta V), allows the investigator to judge the quality of the CRASH output as well as the data input. Question 14 identifies cases where a secondary impact has been CRASHed and recorded in its appropriate non-coded location. Question 15, Data Obtained for This Vehicle's Most Severe Impact: Regardless of Usage, allows the investigator to encode the overall quality of the data related to this vehicle (i.e., CDC or TDC, CRUSH, Profile or Damage sketch, and Trajectory data). This completes the information required from the team. The remaining vehicle log questions, 16-22, are completed by the Zone Center.

Questions 16-20 are completed using the criteria indicated for each data code for that question. If the review process involves reviewing a given percentage of the investigator's cases, Questions 16-20 are not completed for cases coded "2" under Accident Log Question 16, Type of Review. Question 21, Date Official Record Update Received, is filled in with the date the update record arrives at the Zone Center. Question 22, Reviewed By, is filled in with the I.D. number of the person who completes the update review.

4.4.5 Driver Log

The investigator should be sure that each question (1-14) has been addressed for each driver before completing the log. Questions 1 through 7 are coded the same as Variables D01 through D07 of the Driver Form. Question 8 records the occupant number assigned to the driver. If no driver was present, code "00". Question 9, Type of Driver Interview Data Obtained, enables us to know what type of interview information was obtained. Response "0" (Driver not present) means that there was no driver in the vehicle when it was impacted. Response "1" (No data obtained) means no driver or surrogate interview was obtained. Response "2" (Driver history only) means that an interview was obtained with a person who only had knowledge regarding the driver's background and driving history (i.e., a person who can answer questions D10 through D15 (page 1) and D16 and D17 (page 4) on the Driver Form). Response "3" (Accident circumstances only) means that an interview was obtained with a person who has knowledge regarding the circumstances surrounding the particular accident this driver was involved in (i.e., a person who can provide answers to some or all of the questions asked on pages 2, 3, and 4 of the Driver Form) but who cannot provide any information regarding the driver's background or history (i.e., variables D10 through D17). Response "4" (Driver history and accident circumstances) means that an interview was obtained with a person knowledgeable regarding both the driver's background and history and the circumstances of the accident.

Question 10, Source of Driver Data, tells us the source of the driver data obtained during the interview. Needless to say, the objective in NASS is to interview the driver him/herself--response "2" (Driver). In certain instances (e.g., driver is fatally injured or incapacitated) another person or persons may provide the information. This question (10) allows us to identify the person. Response "0" (Driver not present) means that there was no driver in

the vehicle when it was impacted. Response "1" (No data obtained) means that no driver or legitimate surrogate interview was obtained. Response "3" (Other occupant) is used if the data source was an occupant of the vehicle operated by the driver under consideration. The occupant may also have been a relative or friend of the driver. In any case, the person's occupant status takes precedence over whatever personal relationship existed. Response "4" (Relative or friend) is used whenever the data source is a relative or friend of the driver and the source was not involved in the accident. Use response "5" (Eyewitness) when the interviewee witnessed the accident. If the person was also a relative or friend, then response "5" (Eyewitness) takes precedence. Response "6" (Combination of 3, 4, or 5) is appropriate when the interview data was obtained from more than one person such that: (1) the driver was not one of the persons, and (2) the interviewees were from different categories. For example, if the data are obtained from two or more relatives or friends, then code "4" (Relative or friend) should be used. If the data are obtained from the driver and another person, then code "1" (Driver). When code "1" (Driver) is used under Question 10, indicate in Question 9 the type of driver data obtained from the actual driver. When codes "3" through "6" are used for Question 10, indicate the total data obtained ("2", "3", or "4") for Question 9 from all persons participating.

The valid combinations for Questions 9 and 10 are shown in the table below.

Q u e s t i o n			
9	10	9	10
0,1	0,1	3	2,3,5,6,7
2	2,4,or7	4	2,3,6,7

Question 11, Result, encodes the success or failure in obtaining an interview, as well as documenting the reasons why no interview was obtained. Responses "00" and "11"- "12" mean that no interview was required or required interview obtained, respectfully, while Responses "01" through "05" and "10" reflect no personal contact. Responses "06" through "08" reflect unsatisfactory contact, while response "09" reflects unsuccessful attempts to obtain an interview for reasons other than that documented in the previous codes. For Questions 12 and 13, the investigator records the date the interview was conducted and the I.D. number of the investigator completing the interview. If an interview is not conducted, questions 12 and 13 are coded "0's." Question 14 documents with responses "2" through "7" and "9" the reasons why official driver records were not obtained. Response "0" (Driver not present) means there was no driver in the vehicle at the time of the impact. Response "1" (Records obtained) is coded if the driver record was obtained and coded in the appropriate variables. Code "8" (To be updated) means that the official records were not received prior to the initial submission of the case. In this case the investigator must also complete a Driver Update Record Form. This completes the information required of the team. The remaining Driver Log questions, 15-16, are completed by the Zone Center. Question 15, Date Official Driver Record Update Received,

is filled in with the date the update record arrives at the Zone Center. Question 16, Reviewed By, is filled in with the I.D. Number of the person who completes the update review.

4.4.6 Occupant Log

Each attempt to contact the involved occupant is recorded on the interview contact record portion of the log which is non-coded and is provided on the back of page 7 of the field form as an aid to the investigator. The date and time of the contact (military), along with the initials of the contacting investigator, manner of contact, and result of contact are recorded for each attempt. A detailed listing of the codes used for the different "manners" and "results" of the contact are presented below the contact record. The final attempt (whether successful or not) should be coded in Questions 10 through 12 of the log. If multiple interviews are obtained, the investigator may use the interviewee contact record to document them, yet only the contact of the principle interviewee should be documented in Questions 8 through 12. Questions 1 through 8 are the same as Variable 001 through 008 on the same Occupant Form. Question 9 records if the occupant was also the driver of the vehicle. Question 10, Manner of Last Contact Attempt, is coded with the methodology used in the last attempt to obtain an interview. Question 11, Result of Last Contact Attempt, records the degree of success in obtaining an interview. Responses "01" through "05" and "10" reflect no personal contact. Responses "06" through "08" reflect unsatisfactory contact code. Response "09" reflects unsuccessful attempts to obtain an interview for reasons other than that which is documented in the other codes, and responses "11" and "12" reflect a completed interview. Question 12, Date Interview Completed, is coded with the month and date a successful interview was conducted. If no interview is obtained (i.e., Question 11 = 01 - 10) then this question and Question 13 are coded "0's." Question 13, Completing Person, is the investigator's I.D. number who completed the interview. Question 14, Source of Interview Data, tells us the source of the occupant data obtained during the interview. The objective in NASS is to interview the occupant him/herself -- response 2 (same person). If an interview can not be obtained with the occupant him/herself, certain surrogates may provide all the data necessary to complete the form. For example, question 14 also identifies other persons who may provide this information if the occupant is fatally injured, incapacitated, or for other reasons cannot be or refused to be interviewed. Question 15, Reason Medical Data Not obtainable, describes not only the disposition of medical data, but also if the investigator was not able to obtain the data. Codes "02" through "07" provide reasons why, while code "09" reflects a large lag time (greater than 120 days from the date sampled) in obtaining the record. If the official medical injury data are requested but not received at the time of case submission and Question 13 is coded as "08" (To Be Updated), then the investigator should complete an Occupant Update Record Form. This completes the information required from the team. The remaining Occupant Log questions, 16-19, are completed by the Zone Center. Question 16, Date Medical Record Update Received, is filled in with the date the update record arrives at the Zone Center. Question 17, Reviewed By, is filled in with the I.D. number of the person who completes the update review. Questions 18-19 are completed by using the criteria indicated for each data code for that question. If the review process involves reviewing a given percentage of the investigators cases, Questions 18-19 are not completed for cases coded "2" under Accident Log Question 16, Type of Review.

4.5 NASS Criteria for Acceptable Data Completion

The data completion criteria are used as a standard among all PSUs when determining the minimum acceptable data for completion of a case.

Scene Inspections: The Accident Collision Diagram, with at least a sketch of the physical plant, and slides of the scene are required. No excuse is acceptable. If the photo slides did not turn out, a return visit to the scene is made.

Vehicle Inspections: To be credited as "inspected", slides of the damaged vehicle must be submitted as well as the required measurements. If the vehicle has been repaired prior to the inspection, photo slides of the repaired vehicle and damaged components (where circumstances permit) along with a completed form are required. Crush dimensions and a CDC/TDC must be provided when data permit. If there is no measurable damage (i.e., in certain pedestrian or non-motorist type accidents), slides of the vehicle and a completed Vehicle Form will suffice. Inspections are not normally required for "Y" or "Z" strata vehicles. However, for some special studies "Y" and "Z" strata vehicle inspection may be required.

Interviews: If the driver, pedestrian, nonmotorist or occupant was contacted and an appropriate form completed (i.e., the information provided is sufficient enough to support that a partial or complete interview was obtained), and submitted, it is recorded as an interview. An interview with either a driver, occupant, relative, or friend is acceptable as a surrogate interview for other occupants--this refers to the occupant interview section of the Occupant Form. Police officers or occupants of other involved vehicles who know the victim only because of the accident cannot be considered as surrogates and, therefore, are not considered as an interview.

The driver interview section of the Driver Form must be completed through an interview with the driver. However, if an interview cannot be obtained because the driver is fatally injured or incapacitated, the driver history can be obtained from a relative or friend but accident circumstances must be provided by an occupant of the same vehicle or an eyewitness (including occupants of uninvolved vehicles). Also, if the driver is not present in the vehicle, accident circumstances must be provided by an occupant of the same vehicle or an eyewitness.

Official Driver Records: A paper copy or teletype of an official driver record is acceptable. The record must be attached to the case. Other procedures must be established with and previously authorized by the Zone Center with CTM concurrence to be acceptable.

Official Medical Data: A copy of a hospital records department or other clinical institute final discharge medical summary is required. Copies of an emergency room or other abbreviated and advanced medical reports are acceptable with prior Zone Center approval only if established relations dictate (i.e., hospital will not or does not provide a more comprehensive medical report). Copies of physician reports are acceptable when appropriate (i.e., PAR reports victim as injured but driven to private physician). Substitute procedures,

including handwritten or transcribed information are acceptable only with the prior approval of the Zone Center with CTM concurrence. Only official copies of autopsy reports are acceptable. Reports from lay coroners and certificates of death are not considered official medical records.

Finally, before alternative methods for acquiring official records (i.e., handwritten copies or telephone transcripts of medical data and driver records) are authorized, all avenues for obtaining the hard copy must be exhausted. Therefore, establishment of PSU relations will be closely monitored by each Zone Center to ensure that teams do not default to alternative methods because they are easier to establish.

4.6 Special Procedures for Strata "Y" and "Z" Accidents

4.6.1 Procedure for Vehicle(s) in Case Strata "Y" or "Z"

Do not photograph or inspect any vehicle from an accident sampled in these strata. Instead, the data obtained for these vehicles will be entered on an abbreviated vehicle form, essentially requiring no field effort. This Vehicle For Non-Towaway Accident ("Y" or "Z") Form is only one page in length and has 14 variables. The PAR and vehicle registration data will be primary sources of information for this form. Vehicle registration records must be requested for each vehicle in every "Y" or "Z" case. The Vehicle Identification Number on the registration record will supply make/model and body type information. If the registration record is unobtainable (e.g., unregistered vehicle), or if the registration or VIN does not supply sufficient information, the investigator may rely on the PAR information to code these variables. If the registration record is insufficient and the police report is not clear on year, make, model, or body type, the investigator may obtain this information from the driver interview. However, you should not collect any data for variables not on the abbreviated vehicle form, inspect, or photograph the vehicle simply because it is readily available.

The CRASH program is not to be exercised for vehicles in strata "Y" or "Z" since the vehicle procedures and forms unique to these cases have no provision to store any results, and the field inputs for the program will not be collected.

4.6.2 Procedure for Scene Reconstruction in Case Strata "Y" or "Z"

General scene diagrams will be required for these cases, but it is neither necessary nor encouraged that they include representations of the vehicles at their pre-, at-, and post-crash positions. It is only necessary that you locate the first harmful event on the general diagram of the scene. This should be done by drawing an "X" within a circle at the appropriate location. An arrow representing the path of the vehicle prior to impact and leading to the first harmful event should also be included on the diagram. Examples of expected diagrams for accidents in Nontowaway strata "Y" or "Z" are included (Figure 4-2).

Please note that it is still necessary for the investigator to respond to the scene in order to collect the environmental data on both the Accident and Driver Forms for these "Y" and "Z" accidents. The field work at the scene will

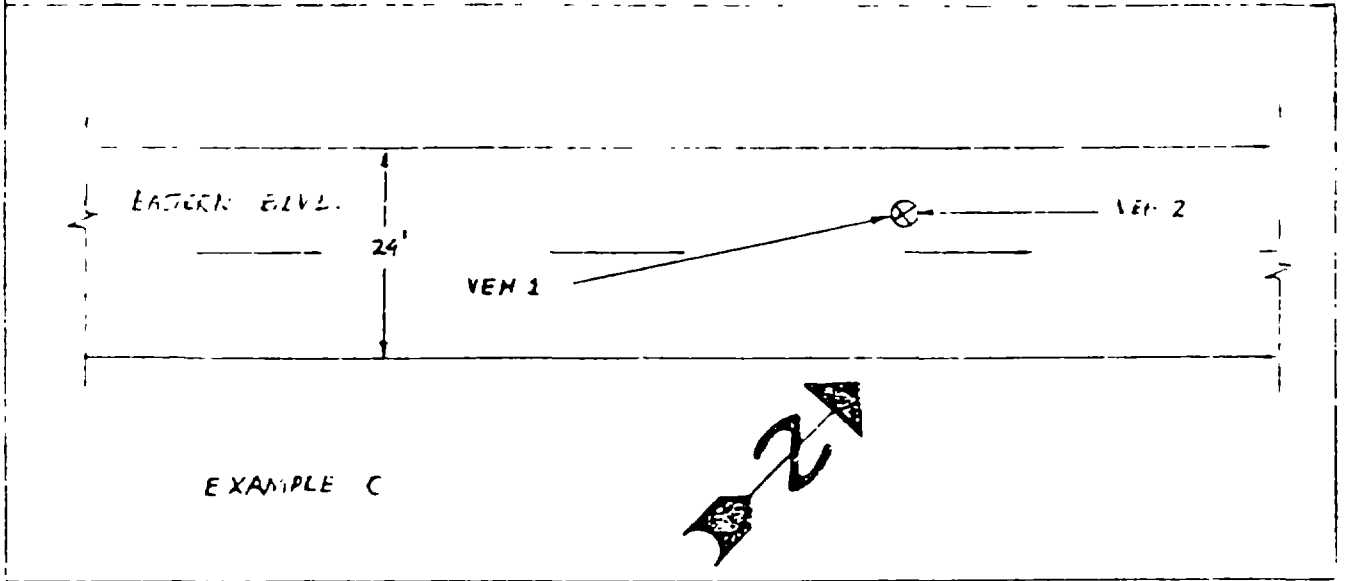
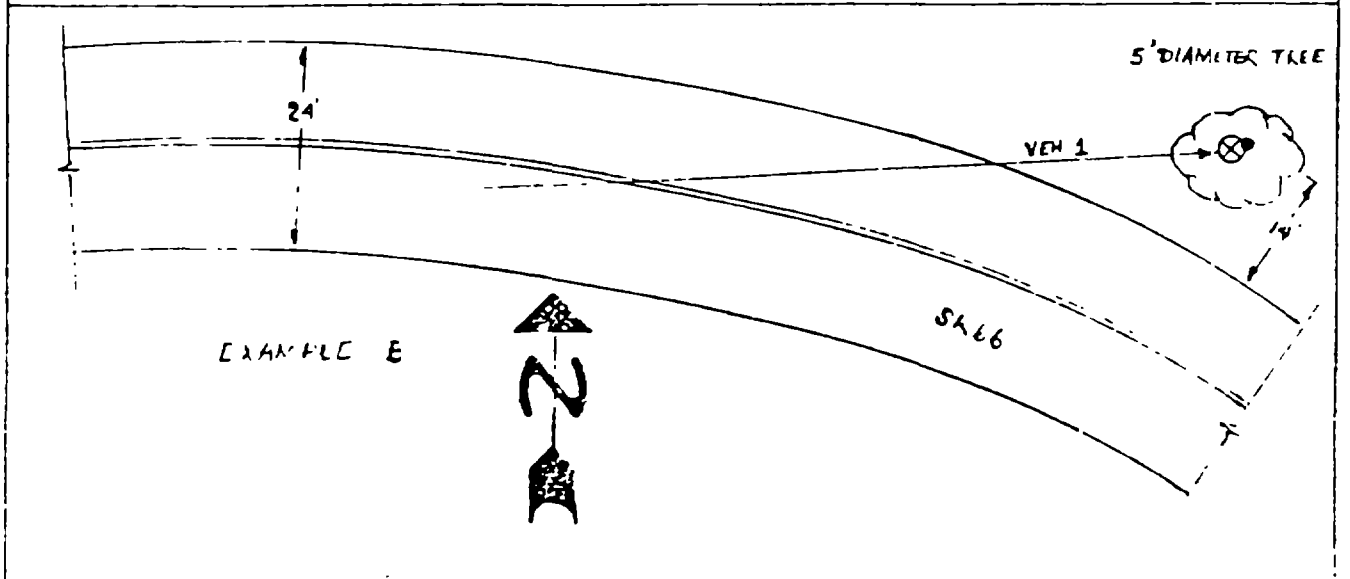
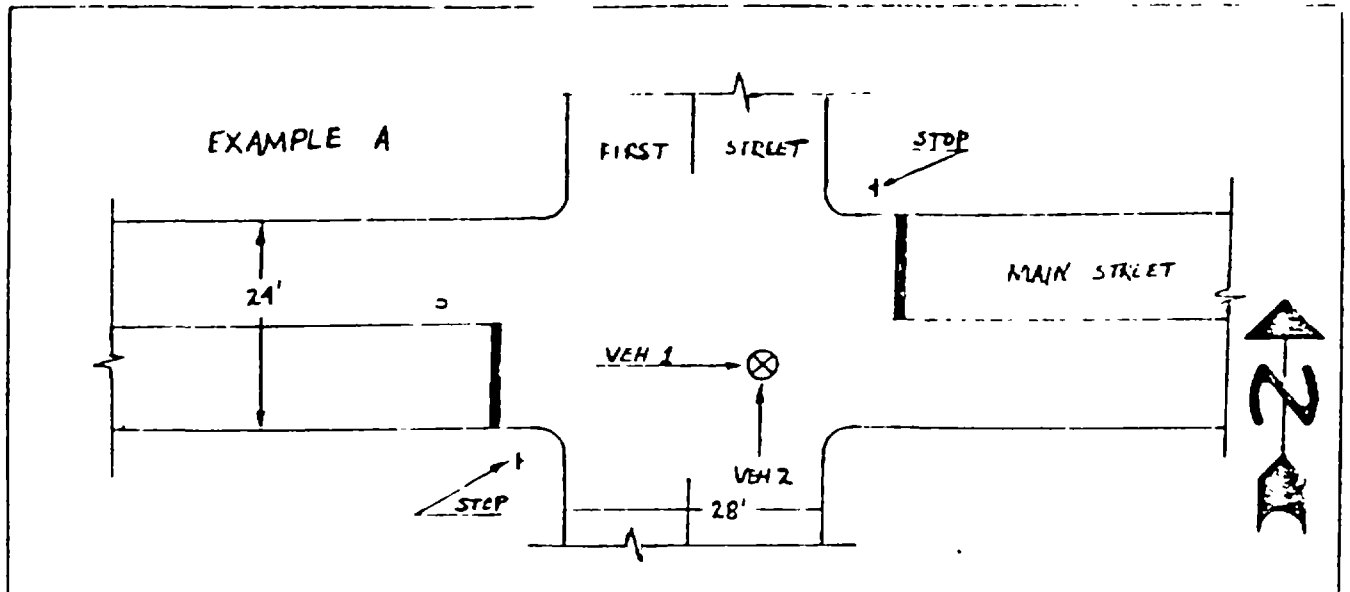

also provide the data for the general diagram (e.g., lane widths, etc.). Physical evidence (e.g., skid marks, etc.) should be noted on the diagram, but not measured. Finally, a photograph should be taken along the pre-impact path of each vehicle and oriented toward the location of the first harmful event. Additional photographs are to be taken to depict the type of roadway(s) involved if the coverage leading to the first harmful event was too narrow to represent the entire scene.

4.6.3 Vehicles Not Affected by Procedures for Strata "Y" or "Z"

The full Vehicle Form (pages 1-9) should be applied in its entirety and the vehicles inspected as well as photographed whether or not they were towed if the accident has been stratified (last character of variable A02) as an "A", "B", "C", "D", "E", "F", "G", "H", "J", "K", "L", "M", "N", "P", "O", "R", "S", "T", "V", or "W". In other words, the abbreviated single page Vehicle For Nontowaway Accident Form and the instructions to neither inspect, photograph, nor locate vehicles at their pre-, at-, or post-crash positions applies only to vehicles in Nontowaway (Police - B, C, O, U) strata "Y" or "Z". Please keep in mind that you will not have independent data regarding restraint usage and occupant contact points when the abbreviated form is used; therefore, you must carefully query the occupants to elicit this information for later use on the Occupant Form.

4.6.4 Usage of Other NASS Forms in Nontowaway Strata "Y" or "Z"

All other forms--Accident, Pedestrian and Nonmotorist, Driver, and Occupant--are to be applied in their entirety as applicable without regard to the stratification of the case.

4.6.5 Selection of Vehicle Form and Scene Procedures When Towaway Status on Police Report Is Not Indicated or In Error

The full Vehicle Form must be filled out and vehicles inspected for all Medium and Heavy Truck cases, strata "J", "K", "L", or "M" regardless of towing status. Light Truck or Van or Other Motor Vehicle type accidents which have police rating of B, C, O, or U, on the most severely injured occupant are to be

stratified as "Q", "R", "V", "W", "Y", or "Z", based on the vehicle towing criterion. If the police report is designed to address the issue of towing but does not explicitly state whether any vehicle was towed, the investigator is to consider this a Nontowaway and stratify the accident in either the "Y" or "Z" stratum, depending on the accident type (Light Truck or Van versus Other Motor Vehicle). The investigator should then follow the procedures under Section 4.6.1 and 4.6.2, even if it is subsequently learned that one of the vehicles was towed and the police report was in error (e.g., by failing to make an entry with respect to the issue of towing). This rule also applies where the police indicate all the vehicles were driven from the scene by stating just that, marking through the section dealing with removal of the vehicle (if this is interpreted as inapplicable or vehicle driven from scene), etc.

Conversely, in the above accidents where the police indicate that at least one of the vehicles was towed, the accident should be stratified in either the "Q", "R", "V" or "W" stratum, depending on the accident type (Light Truck or Van

versus Other Motor Vehicle). Once it has been stratified in a stratum other than "Y" or "Z", the Vehicle Form is applicable for each vehicle in the accident, even if it is subsequently determined that none of the vehicles was towed and the police report was in error. Special instructions are provided to PSU's (e.g., Chicago) where the issue of towing is not routinely within the scope of the police report.

4.6.6 Interface with Special Studies

Special studies SS6 through SS9 will be applicable to all strata. SS10 will only apply to "A", "B", "C" and "D" strata cases.

5.0 SUBMISSION INSTRUCTIONS

5.1 Quality Control Checks for PSU Teams

Please find below a list of quality control checks to be made by PSU teams.

5.1.1 Quality Control Checks Prior to Remote Data Entry

Each case should be reviewed by a person other than the originating investigator prior to entering them via RDE. This effort tends to minimize encoding errors resulting from values which are either illegal or legal but incorrect. The non-coded items in the case should also be checked. The primary investigator is to be informed (preferably in writing) of any problems detected during this review and that investigator is to assume the responsibility for their resolution. Some suggested areas where problems may occur are as follows:

- Has the case passed an inhouse case review?
- Are all official records and slides present?
- Check slides and official records to make sure they correspond to the case submitted (slides and police report shouldn't be placed next to each other because the photocopied police report tends to "bleed" on the slide folders).
- Have portions of update record forms been filled out where needed?
- Do the control charts properly reflect how much of the case report has been completed?
- Make sure medical reports are properly sanitized.
- Are all data collection forms present?
- Include forms for all persons and vehicles, even if they have not been interviewed or inspected.
- Are the logs properly completed on the forms?
- Make sure case materials are sequenced properly and the case report envelope is stamped and properly identified.
- Check non-coded data for correctness and its interface with coded data.
- Check to make sure that the coded data are properly and legibly entered on the data collection forms.
- Have "+"s or "-"s been circled for V80, V81 and V85 on the Vehicle Form?

5.1.2 Quality Control Checks Resulting from Remote Data Entry

Inconsistencies, out-of-range values, and other error diagnostics encountered during the RDE are explained in Section 3, Tables A-1 through A-9, and Section 4 of the Remote Data Entry (RDE) System User's Manual. All errors detected by the computer edits are corrected by the PSU before the case is forwarded to the Zone Center--unless the Zone Center is notified and suggests shipment of an incompletely entered case.

5.1.3 Check to Make Sure Administrative Procedures are Being Followed

- Are control charts and activity logs (when used) updated weekly?
- Are monthly reports and sampling materials sent to the Zone Center?
- Are manuals up-to-date and properly displayed?
- Are needed supplies in stock (e.g., film, etc.)?

5.1.4 Check Sampling Procedures

- Periodically review sampling procedures in team meetings.
- Document any problems in the monthly report.

5.1.5 Check Data Collection Procedures

- Periodically review procedures. Document when meetings are held and any problems discovered with the data collection procedures or forms. Indicate problems in the monthly report or over Message System to your Zone Center. Keep a file of problems encountered and go over them with a Zone Center representative during the next Zone Center site visit.

5.1.6 Check to Make Sure Updates Are Being Processed Properly

- Are the vehicle record, driver record, and medical update records filed by case number?
- Do Zone Center and PSU records agree (see Zone Center list of outstanding updates)?

5.1.7 Check Individual Effort and Accuracy in Collecting Evidence and Skill in Interpretation

- Discuss data collection procedures and efficient ways to execute them in team meetings. Discuss how much follow-up effort is needed for obtaining interviews and think about methods other than the phone and personal contact for obtaining more interviews (e.g., letters).

5.2 Case Submission

The final date for the remaining submission of December 1983 cases (exclusive

of updates) is 3 February 1984. All remaining updates for 1983 cases are to be submitted by 13 April. This will allow the Zone Centers approximately three weeks to review and enter this new information (updates) on the 1983 version of RDF before it becomes inaccessible to them, as well as the PSUs, on 4 May 1984.

Cases acquired in 1984 shall be submitted to the Zone Centers on an approximate bi-weekly basis. The materials for each case are to be ordered in the recommended format discussed in section 4.1; each case is to be packaged in a separate envelope with the appropriate identification and account of contents on the front of the envelope. These procedures will provide uniformity across teams and, in turn, reduce the variation encountered by the Zone Center upon receipt of the cases. Furthermore, the bi-weekly submission will minimize the peaks and valleys in the Zone Center case review workload.

Submission Schedule--Cases shall be submitted on an approximate bi-weekly basis beginning 6 January 1984, according to the schedule (Table 5-1). Essentially, there will be at least one month to make the initial submission of any case. All cases are to be submitted within 5 weeks, following the date on which they were sampled. This means that the maximum time available to submit a case will be 35 days from the date of sample. Interviews, vehicle inspections, and scenes not completed in the allowed time period will not be updated.

Those variables which are allowed updates, but have not been completed within the time available for the initial case submission, should be documented on the appropriate record and submitted as updates in accordance with the schedule.

Cases which are completed (i.e., no updates needed) prior to elapsing of the available time period, should be submitted on the next, earliest case submission.

Case Envelope--PSUs should consult with their Zone Centers as to the correct envelope size. The case envelope belongs inside the shipping envelope. The information below belongs on the case envelope, not on the covering shipping material. The PSU number, case number, accounting of case materials, and the status of the case at the time of submission, as shown below, are to be entered in the upper right hand corner of the envelope when the envelope is positioned with its flap on the underside and to the right.

PSU # _____ CASE # _____

CASE COMPLETE CASE TO BE UPDATED

FORMS: Police _____

	<u>Required</u>	<u>Included</u>
Accident.	_____	_____
Collision Diagram	_____	_____
Non-Occupant.	_____	_____
Vehicle	_____	_____
Driver.	_____	_____
Occupants	_____	_____
Medicals.	_____	_____
CRASH	_____	_____
Slides (Number)	_____	_____

Table 3-1. WQSS 1984 CPSS 5 (MCS-10A) 50-FRQ-11

(Dates batches of Material Must Be Submitted Ev)

Cases Sampled or in Before	Material Submitted on or Before	Material Received at Zone Center by	Case Review Completed By	Dates Must Be Received by	Case Master File Approval Ev
12/ 8 /1983	12/30/1983	1/ 5/1984	1/20/1984	3/ 9/1984	3/26/1984
12/16/1983	1/12/1984	1/20/1984	2/ 3/1984	3/23/1984	3/31/1984
12/23/1983	1/27/1984	2/ 3/1984	2/17/1984	4/ 6/1984	4/13/1984
1/13/1984	2/12/1984	2/17/1984	3/ 2/1984	4/22/1984	4/29/1984
1/27/1984	2/24/1984	3/ 3/1984	3/16/1984	5/ 4/1984	5/11/1984
2/12/1984	3/ 9/1984	3/16/1984	3/30/1984	5/18/1984	5/25/1984
2/24/1984	3/23/1984	3/30/1984	4/13/1984	5/11/1984	5/18/1984
3/ 5/1984	4/ 6/1984	4/13/1984	4/27/1984	5/25/1984	6/22/1984
3/23/1984	4/28/1984	4/27/1984	5/11/1984	5/29/1984	7/ 1/1984
4/ 6/1984	5/ 4/1984	5/11/1984	5/25/1984	7/12/1984	7/20/1984
4/28/1984	5/13/1984	5/25/1984	6/ 8/1984	7/27/1984	8/ 3/1984
5/ 4/1984	6/ 1/1984	6/ 6/1984	6/22/1984	8/18/1984	8/27/1984
5/18/1984	6/13/1984	6/22/1984	7/ 6/1984	8/24/1984	9/12/1984
6/ 1/1984	6/25/1984	7/ 6/1984	7/20/1984	9/ 7/1984	9/14/1984
6/15/1984	7/13/1984	7/20/1984	8/ 3/1984	9/21/1984	9/28/1984
6/29/1984	7/27/1984	8/ 3/1984	8/17/1984	10/ 5/1984	10/13/1984
7/13/1984	8/ 13/1984	8/17/1984	9/31/1984	10/13/1984	10/23/1984
7/27/1984	8/24/1984	9/12/1984	9/14/1984	11/ 2/1984	11/ 9/1984
8/ 8/1984	8/ 7/1984	8/14/1984	9/25/1984	11/15/1984	11/22/1984
8/24/1984	9/21/1984	9/28/1984	12/12/1984	11/30/1984	12/ 7/1984
9/ 7/1984	10/ 5/1984	10/13/1984	12/26/1984	12/14/1984	12/21/1984
9/21/1984	10/19/1984	10/26/1984	11/ 9/1984	12/28/1984	1/ 4/1985
10/ 5/1984	11/ 2/1984	11/ 9/1984	11/23/1984	1/11/1985	1/18/1985
10/19/1984	11/16/1984	11/23/1984	12/ 7/1984	1/25/1985	2/ 1/1985
11/ 2/1984	11/30/1984	12/ 7/1984	12/21/1984	2/ 8/1985	2/15/1985
11/16/1984	12/14/1984	12/21/1984	1/ 4/1985	2/22/1985	3/ 1/1985
11/30/1984	12/28/1984	1/ 4/1985	1/20/1985	3/ 8/1985	3/15/1985
12/14/1984	1/12/1985	1/16/1985	2/ 1/1985	3/22/1985	3/29/1985
12/28/1984	1/25/1985	2/ 1/1985	2/15/1985	4/ 5/1985	4/12/1985
1/12/1985	1/29/1985	2/ 4/1985	2/18/1985	4/ 9/1985	4/15/1985
1/26/1985	2/ 8/1985	2/15/1985	3/ 1/1985	4/13/1985	4/20/1985

CPSS MATERIAL NOT SUBMITTED BY THE ABOVE DATES WILL BE CONSIDERED INCOMPLETE.

Table 5-1a: WASS 1984 FILE CLOSURE SCHEDULE

Cases Sampled on or Before	Bioprost Checks	MDG File Closure	Quarterly Report Due Date	Annual Report Due Date
12/ 2/1983				
12/16/1983				
12/30/1983	4/27/1984	5/11/1984	3/16/1984	4/ 5/1984
1/13/1984				
1/27/1984				
2/10/1984				
2/24/1984				
3/ 9/1984				
3/23/1984				
4/ 5/1984	8/ 2/1984	8/17/1984	6/22/1984	
4/20/1984				
5/ 4/1984				
5/18/1984				
5/ 1/1984				
6/15/1984				
6/29/1984	12/26/1984	11/ 9/1984	9/14/1984	
7/13/1984				
7/27/1984				
8/10/1984				
8/24/1984				
9/ 7/1984				
9/21/1984				
10/ 5/1984	2/ 1/1985	2/15/1985	12/21/1984	
10/19/1984				
11/ 2/1984				
11/16/1984				
11/30/1984				
12/14/1984				
12/28/1984				
12/31/1984	4/29/1985	5/13/1985	3/18/1985	4/ 8/1985
1/11/1985				

A rubber stamp, ink pad, and ink have been provided. This information will help the Zone Center effectively sort the case at the inception of the quality control process; the standardized envelopes will facilitate storage and retrieval.

Case update records should be submitted in the same type of envelope. Identify the PSU and boldly mark the front of the envelope: **UPDATES**. The updates will be removed from the envelope and collated with the original forms in their respective cases by the Zone Center.

Shipment of Cases--The envelopes containing the individual cases which are eligible for shipment, according to the schedule shown in Table 5-1, should be packaged in a box or other suitable container and mailed to the Zone Center. The PSU should provide an acknowledgement of delivery card, return receipt, or similar confirmation to ensure the shipment was received by the Zone Center.

The mailing addresses for the Zone Centers are as follows:

ZOA, Central	Institute for Research in Public Safety Attention: NASS Receiving SPEA Building/Indiana University Bloomington, Indiana 47405
ZOB, Northern	Mr. John W. Garrett Manager, Accident Research Division Calspan Field Services, Inc. P.O. Box 400 Buffalo, New York 14225
ZOC, Southern	Southwest Research Institute NASS Southern Zone Center Attention: Marilyn Reeves P.O. Drawer 28510 San Antonio, Texas 78284
ZOD, Western	Dynamic Science, Inc. 8531 East Florence Avenue Downey, California 90240

5.3 Case Dropping Procedures

The following procedure for dropping cases should be adhered to for all NASS cases:

1. Call your Zone Center for approval. Let it be known that a case is being dropped and give the reason why.
2. Send a follow-up message informing the Zone Center of the case to be dropped. Include in the message the case number and the reason the case is being dropped.

3. Send the dropped case to the Zone Center. Each dropped case is to be sent to the Zone Center in a separate standard envelope.

A. The outside of the envelope should be labeled as follows:

-PSU stamp, on the upper right-hand corner, filled out with the PSU no. and case no.

-Written in large letters is: DROPPED (under the PSU stamp).

-The date of Zone Center approval to drop the case.

-The persons who gave Z.C. approval to drop the case.

B. Inside the envelope should be:

-PAR

-Accident Form with the following variables filled out:

Accident Data

A01-PSU number

A02-Case Number Stratification

A06-Investigator I.D. Number

A07-Date

A17-Time

Accident Log

A1-PSU Number

A2-Case Number-Stratification

A4-Transaction Code

A6-Investigator I.D. Number

A7-Date of Accident

A8-Date Sampled

A10-Completing Person

A13-Case Status

-Code 3 (Case dropped) Reason: Give a detailed explanation of the reason case was dropped.

-General, any other materials completed prior to dropping the case (i.e., slides)

6.0 CODING INSTRUCTIONS

This section provides the general instructions for collecting and coding the data called for in the field forms. Documentation for each data element includes variable name, element values (attributes), definitions where needed, data sources, collection methodology, reference materials (if needed), remarks, consistency checks, and special processing information.



Accident Data

1. Primary Sampling Unit Number 1 2

2. Case Number: Stratification 3 4 5 6

3. Record Number 7

4. Transaction Code 8

5. Version Number 9

6. Investigator I.D. Number 10

IDENTIFICATION

7. Date (Month, Day, Year) 11 12 13 14 15 16

___/___/8 4

8. Final Stratification
Mark the box which indicates this accident's final stratum.
Code the box's letter in the space provided.

ACCIDENT TYPE	Most Severe Police Reported Injury*			
	K	A	B, C, O or U	
			TRANSPORTED	NONTRANSPORTED
Ped or Nonmotorist	A	B	C	D
Motorcycle	E	F	G	H
Medium or Heavy Truck	J	K	L	M
Light Truck or Van	TOWAWAY	N	P	Q
	NONTOWAWAY	N	P	Y
Other Motor Vehicle	TOWAWAY	S	T	V
	NONTOWAWAY	S	T	Z

9. Blank (This variable is left blank so that numbering consistency can be maintained with the 1983 CSS.) 17

10. First Harmful Event

Non-Collision

___(01) Overturn

___(02) Fire or explosion

___(03) Immersion

___(04) Gas inhalation

___(05) Fell from vehicle

___(06) Injured in vehicle

___(07) Other non-collision

Collision With:

___(08) Pedestrian

___(09) Pedalcyclist

___(10) Railway train

___(11) Animal

___(12) Motor vehicle in transport (same roadway)

___(13) Motor vehicle in transport (other roadway)

___(14) Parked motor vehicle

___(15) Other type nonmotorist _____

___(16) Thrown or falling object

___(17) Boulder

___(18) Other object (not fixed)

Collision with Fixed Object:

___(19) Building

___(20) Impact attenuator/Crash Cushion

___(21) Bridge pier or abutment

___(22) Bridge parapet end

___(23) Bridge rail

___(24) Guardrail

___(25) Concrete traffic barrier

___(26) Other longitudinal barrier _____

___(27) Highway/Traffic sign post

___(28) Overhead sign support

___(29) Luminaire/Light support

___(30) Utility pole

___(31) Other post, pole, or support _____

___(32) Culvert

___(33) Curb

___(34) Ditch

___(35) Embankment - earth

___(36) Embankment - rock, stone or concrete

___(38) Fence (wooden, wire, chain link, etc.)

___(39) Wall (stone, rock, metal, etc.)

___(40) Fire hydrant

___(41) Shrubbery

___(42) Tree

___(43) Other fixed object _____

___(44) Pavement surface irregularity (pothole, grooved, grates)

___(99) Unknown

*Code 37 is omitted to maintain consistency with the Fatal Accident Reporting System (FARS).

11. Manner of Collision (Based on First Harmful Event)

(0) Not collision with vehicle in transport

(1) Rear-end

(2) Head-on

(3) Rear-to-rear

(4) Angle

(5) Sideswipe, same direction

(6) Sideswipe, opposite direction

(9) Unknown

25

12. Relation to Roadway (location of first harmful event)

(1) On roadway

(2) On shoulder

(3) In median

(4) On roadside

(5) Outside right-of-way

(6) Off roadway – location unknown

(7) In parking lane

(8) Gore

(9) Unknown

26

13. Number of Vehicle Forms Submitted

_____ Code only the number of motor vehicles in transport for which a VEHICLE FORM was submitted.

27 28

14. Number of Pedestrian & Nonmotorist Forms Submitted

_____ Code only the number of pedestrians and/or non-motorists for which a PEDESTRIAN & NONMOTORIST FORM was submitted

29 30

15. Police Reported Accident Severity

(0) No injury (0)

(1) Possible injury (C)

(2) Nonincapacitating injury (B)

(3) Incapacitating injury (A)

(4) Killed (K)

(5) Injury, severity unknown

(6) Died prior to accident

(9) Unknown

31

16. Hit and Run

(0) No hit-and-run

(1) Hit motor vehicle (in transport)

(2) Hit pedestrian or nonmotorist

(3) Hit parked vehicle or object

32

AMBIENT CONDITIONS

17. Time

_____ Code reported military time of accident.
(NOTE: midnight = 2400)

(9999) Unknown

33 34 35 36

18. Light conditions

(1) Daylight

(2) Dark

(3) Dark, but lighted

(4) Dawn

(5) Dusk

(9) Unknown

37

19. Atmospheric Conditions

(1) No adverse atmospheric related driving conditions

(2) Rain

(3) Sleet

(4) Snow

(5) Fog

(6) Rain and fog

(7) Sleet and fog

(8) Other (e.g., smog, smoke, blowing sand or dust, etc.)

(9) Unknown

38

ADMINISTRATIVE ITEMS

20. Land Use
(NOTE: Use FHWA required individual state definitions for the roadway segment on which the accident occurred)

(1) Urban

(2) Rural

(9) Unknown

39

21. Federal Aid System

(1) Interstate

(2) Other federal aid primary

(3) Federal aid secondary

(4) Federal aid urban arterial

(5) Federal aid urban collector

(6) Nonfederal aid arterial

(7) Nonfederal aid collector

(8) Nonfederal aid local

(9) Unknown

40

22. Class Trafficway

(1) Interstate

(2) Other U.S. Route

(3) Other State Route

(4) County Road

(5) Local Street

(8) Other _____

(9) Unknown

41

23. Roadway Function Class
 (1) Principal arterial-interstate
 (2) Principal arterial-other urban freeway or expressway
 (3) Principal arterial-other
 (4) Minor arterial
 (5) Urban Collector
 (6) Major rural collector
 (7) Minor rural collector
 (8) Local road or street
 (9) Unknown 42

24. Relation to Junction
 (01) Non-junction
 (02) Three leg intersection
 (03) Four leg intersection
 (04) More than four leg intersection
 (05) Rotary or traffic circle
 (06) Intersection related
 (07) Channel
 (08) Area of merge/divergence related
 (09) Entrance or exit ramp
 (10) Interchange area
 (11) Driveway, alley access related
 (12) Railroad grade crossing
 (13) Crossover related
 (99) Unknown 43 44

25. School Bus Related
 (0) No
 (1) Yes 45

26. Right or Left Turn on Red Related
 (0) No
 Right turn related
 (1) Yes – turn permitted
 (2) Yes – turn prohibited
 Left turn related
 (3) Yes – turn permitted
 (4) Yes – turn prohibited
 (9) Unknown 46

ENVIRONMENTAL DATA

27. Number of Travel Lanes
 (1) One (5) Five
 (2) Two (6) Six
 (3) Three (7) Seven or more
 (4) Four (9) Unknown 47

28. Median Type
 (0) No Median
 (1) Curbed
 (2) Positive Barrier
 (3) Unprotected
 (9) Unknown 48

29. Median Width
 (00) No median
 Code actual measured value up to 96 feet.
 (97) 97 feet and above
 (99) Unknown 49 50

30. Access Control
 (1) Full
 (2) Partial
 (3) Uncontrolled
 (9) Unknown 51

31. Trafficway Flow
 (0) Not physically divided (two way traffic)
 (1) Divided trafficway – median strip without traffic barrier
 (2) Divided trafficway – median strip with traffic barrier
 (3) One way trafficway
 (9) Unknown 52

32. Interchange Geometry
 (0) No interchange
 (1) Full diamond
 (2) Partial diamond
 (3) Full cloverleaf
 (4) Partial cloverleaf
 (5) Trumpet
 (6) Directional
 (8) Other: _____
 (9) Unknown 53

33. Shoulder Presence
 (0) No shoulder
 (1) One shoulder
 (2) Two shoulders
 (9) Unknown 54

34. Roadway Alignment
 (1) Straight
 (2) Curve
 (9) Unknown 55

35. Roadway Profile
 (1) Level slope
 (2) Grade ($\geq 2\%$) measurement:
 (3) Hillcrest
 (4) Sag ($v = \text{_____}$) / ($h = \text{_____}$)
 (9) Unknown 56

36. Roadway Surface Type

- (1) Concrete
- (2) Bituminous
- (3) Brick or block
- (4) Slag, gravel or stone
- (5) Dirt
- (8) Other _____
- (9) Unknown

57

37. Roadway Surface Condition

- (1) Dry
- (2) Wet
- (3) Snow or slush
- (4) Ice
- (5) Sand, dirt or oil
- (8) Other _____
- (9) Unknown

58

38. Traffic Control Device

- (00) No controls
- Not at railroad grade crossing
- Highway traffic signals
- (01) Traffic control signal (on colors) without pedestrian signal
- (02) Traffic control signal (on colors) with pedestrian signal
- (03) Traffic control signal (on colors) not known whether or not pedestrian signal
- (04) Flashing traffic control signal
- (05) Flashing beacon
- (06) Flashing highway traffic signal, type unknown or other than traffic control or beacon
- (07) Lane use control signal
- (08) Other highway traffic signal
- (09) Unknown highway traffic signal
- Regulatory signs
- (20) Stop sign
- (21) Yield sign
- (28) Other regulatory sign
- (29) Unknown type regulatory sign
- School Zone Signs
- (30) School speed limit sign
- (31) School advance or crossing sign
- (38) Other school related sign
- (39) Unknown type school zone sign
- Warning Signs
- (40) Warning sign
- Miscellaneous Controls
- (50) Officer, crossing guard, flagman, etc.
- At railroad grade crossing
- Active Devices
- (60) Gates
- (61) Flashing lights
- (62) Traffic control signal
- (63) Wigwags
- (64) Bells
- (68) Other train activated device
- (69) Active device, type unknown

Passive Devices

- (70) Crossbucks
- (71) Stop sign
- (72) Other railroad crossing sign
- (73) Special warning device - watchman, flagged by crew.
- (78) Other passive device
- (79) Passive device, type unknown

Miscellaneous Controls

- (80) Grade crossing controlled type unknown

Whether or not at railroad grade crossing

- (98) Other
- (99) Unknown

59 60

39. Traffic Control Device Functioning

- (0) No traffic control
- (1) Traffic control not functioning
- (2) Traffic control functioning - functioning improperly
- (3) Traffic control functioning properly
- (9) Unknown

61

40. Accident Occurrence in School Zone

- (0) No
- (1) Yes
- (9) Unknown

62

41. Speed Limit

- (00) No statutory limit
- _____ m.p.h. - Code actual posted or statutory speed limit.
- (99) Unknown

63 64

42. Restriction of Roadway at Scene (NOTE: The Restriction must have existed prior to this accident.)

- (0) No restrictions
- (1) Narrow bridge (as defined)
- (2) Previous accident on roadway
- (3) Maintenance, repair or construction activity on roadway.
- (4) Roadway immersion (e.g., standing water)
- (8) Other roadway obstruction: _____
- (9) Unknown

65

(NOTE: If more than one restriction exists they should be coded in the order in which they are numbered.)

LOG RESPONSES

KEY TO SLIDE(S) QUALITY CONTROL CHECKS

SUBJECT QUALITY – EXTERIOR SLIDES

- (1) Good – Slide coverage is complete in that it includes all areas of all vehicles (whether or not damaged); it is possible to generate an accurate CDC and check damage measurements if applicable.
- (2) Fair – Slide coverage is only broad enough (for at least one vehicle) to include the areas which were reportedly damaged (areas which are reportedly undamaged are not shown); it is possible to generate a reasonable CDC and check damage measurements if applicable.
- (3) Poor – Slide coverage excludes one or more areas of reported damage (for at least one vehicle); it is difficult to generate an accurate CDC and check damage measurements if applicable.
- (0) No Slides

NOTE: The location of the vehicles is considered at the time the slides were taken. If another vehicle or object obscured the damaged area so it could not be photographed, then that vehicle(s) should be categorized (1) or (2) based on the slides taken. If a damaged area could have been photographed but was not, then that vehicle(s) should be categorized (3).

SUBJECT QUALITY – INTERIOR SLIDES

- (1) Good – Slides show all areas of contact, probable contact and/or possible occupant contact areas; all intrusion, probable intrusion and/or possible intrusion areas; vehicle interior components (instrument panel, headers, roof areas, seat belts, etc.) and all occupant seated positions.
- (2) Fair – Slides show only contact and intrusion areas or an overall view of the vehicle interior; probable areas of contact and/or intrusion, relevant vehicle interior components and relevant occupant seated positions are omitted for at least one vehicle.
- (3) Poor – Obvious and/or probable contact and intrusion areas are not photographed for at least one vehicle.
- (0) No Slides

SUBJECT QUALITY – SCENE SLIDES

- (1) Good – Slides show all necessary roadways and physical evidence including all objects contacted.
- (2) Fair – Slides show general area of accident site and objects contacted; additional pictures would have been helpful.
- (3) Poor – Slides do not adequately show area of impact or path of travel off-road, or at least one object definitely contacted was omitted.
- (0) No Slides

SLIDE QUALITY – FOR ALL PICTURES

- (1) Good – All areas in the vast majority of all of the slides are clearly defined; the subject has proper framing and exposure.
- (2) Fair – All areas in most of the slides are distinguishable but some camera adjustment could have been made.
For example
 - (a) underexposed (too dark)
 - (b) overexposed (too light)
 - (c) out of focus (usable slide)
- (3) Poor – The area photographed in many of the slides cannot be seen. Examples of some failures are:
 - (a) underexposed (too dark)
 - (b) overexposed (too light)
 - (c) out of focus (usable slide)
 - (d) flash not used
 - (e) flash reflection
 - (f) distance
- (0) No Slides

Accident Data

43 Additional Restriction of Roadway at Scene
(NOTE See question 42 note above.)

(0) No additional Restrictions

(2) Previous accident on roadway

(3) Maintenance, repair, or construction activity on roadway

(4) Roadway immersion (e.g., standing water)

(5) More than two restrictions

(8) Other roadway restriction

(9) Unknown

66

SPECIAL STUDIES - INDICATORS

Information Collected From This Accident As A Part of the Special Studies Subsystem

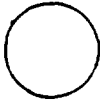
 NO - Code 0 for each of questions 44 through 53

If YES - Check (✓) each of the studies from the list to the right that were indicated, code 1 for the checked studies and 0 for the studies not checked

44	<input type="checkbox"/> SS6-Emergency Medical Service	67
45	<input type="checkbox"/> SS7-Pole	68
46	<input type="checkbox"/> SS8-Longitudinal Barrier	69
47	<input type="checkbox"/> SS9-Crash Cushion	70
48	<input type="checkbox"/> SS10-Pedestrian Typing	71
49	<input type="checkbox"/> SS11-Honda Civic	72
50	<input type="checkbox"/> SS12	73
51	<input type="checkbox"/> SS13	74
52	<input type="checkbox"/> SS14	75
53	<input type="checkbox"/> SS15	76

NOTE Leave blank any special studies which are not in effect for this PSU at the time this case is sampled

Empty section for additional notes or data.

FORMS: For Team Use

Police: _____	Accident	Collision Diagram	Pedestrian & Nonmotorist	Vehicle	Driver	Occupant	Medical	CRASH Summary	Slides (Number)
Required: _____	1	_____	_____	_____	_____	_____	_____	_____	_____
Include: _____	_____	_____	_____	_____	_____	_____	_____	_____	_____

COMPLETED BY TEAM

1. Primary Sampling Unit Number 1 2

2. Case Number - Stratification 3 4 5 6

3. Record Number 7

4. Transaction Code 8

5. Version Number 9

6. Investigator I.D. Number 10

7. Date of Accident 11 12 13 14 15 16

8. Date Sampled (listed) 17 18 19 20 21 22

9. Date Scene Field Work Completed 23 24 25 26 27 28

10. Completing Person 29

11. Status of Accident Diagram

____(1) Scene not located. Reason: _____

____(2) Scene located and roadway data mapped on sketch but insufficient data even to produce a scaled diagram of the collision events.

____(3) Diagram completed. 30

12. Date Case Released to Zone Center 31 32 33 34 35 36

13. Case Status

____(1) Case Complete - No Updates Required

____(2) Case to be Updated

____(3) Case Dropped. Reason: _____ 37

14. Are Special Studies Applicable (If No code "0" If Yes code "1")

SS6 SS7 SS8 SS9 SS10 SS11 SS12 SS13 SS14 SS15

38 39 40 41 42 43 44 45 46 47

COMPLETED BY ZONE CENTER

15. Date Hardcopy Received at Zone Center 48 49 50 51 52 53

16. Type of Review

____(1) Reviewed

____(2) Not reviewed 54

17. Date Review Completed 55 56 57 58 59 60

18. Reviewed By 61 62

19. Case Review Status

____(1) Complete ____ (2) Not complete 63

20. Date Case released to Master File 64 65 66 67 68 69

(See back of page 4 for responses to questions 21-26)

21. Subject Quality - Scene Slides 70

22. Slide Quality - Scene Slides 71

23. Subject Quality - Vehicle Interior Slides 72

24. Slide Quality - Vehicle Interior Slides 73

25. Subject Quality - Vehicle Exterior Slides 74

26. Slide Quality - Vehicle Exterior Slides 75

27. Physical Evidence Documentation

____(0) No physical evidence present at scene

Yes-physical evidence visible in slides or noted by investigator

____(1) Complete - all physical evidence (skidmarks, gouges, fluid spills, contacted objects, etc.) is documented using standard investigator techniques.

____(2) Partial - Documentation is adequate, however, certain physical evidence is incorrectly noted or overlooked.

____(3) Incomplete - Documentation is poor Physical evidence is generally missed or incorrectly documented and contacted objects are overlooked.

____(4) None - no documentation of physical evidence 76

28. Vehicle Dynamics

____(1) Complete - Vehicle dynamics represent point of impact, headings and locations and final rest of vehicle(s).

____(2) Partial - Vehicle dynamics only represents an overview of the accident configuration Vehicle input is missing or improbable for at least one vehicle.

____(3) Incomplete - Vehicle dynamics are incorrect, improbable or missing.

____(4) Vehicle dynamics are approximated (or Y or Z Strata) 77

29. Roadway Measurement/Furniture Documentation

____(1) Complete - All necessary roadway measurements and roadside furniture are documented.

____(2) Partial - Only basic measurements and furniture are documented. More information would have been helpful

____(3) Incomplete - Necessary measurements and/ or roadside furnitures are not documented 78



Accident Collision Diagram

Primary Sampling Unit Number ____

Reference Point: _____

Case Number ____

Reference Line: _____

Item	Distance and Direction from Reference Point	Distance and Direction from Reference Line

Delete Street Names After Case Review

A C C I D E N T C O L L I S I O N D I A G R A M

Indicate



North

Variable Name: Primary Sampling Unit Number

Format: 2 columns - numeric

Beginning
Column 01

VALUES =====	STRATA =====	DESCRIPTION =====
01, 03, 31, 34, 35	1	Central City, one of the 10 largest 1970 SMSA's
36, 51, 63, 76, 85	2	Central city, one of the 11th - 60th largest 1970 SMSA'S
08, 09, 28, 32, 79	3	Suburban, one of the 17 largest 1970 SMSA'S; low gas sales
06, 29, 37, 38, 61	4	Suburban, one of the 18th - 60th largest SMSA'S: high gas sales
10, 33, 39, 52, 56. 80	5	Suburban, one of the 18th - 60 largest 1970 SMSA's, or PSU within 61st - 119th largest SMSA's not containing a central city
04, 27, 57, 82, 87	6	PSU within 61th - 119th largest SMSA's containing a central city
02, 30, 55, 58	7	PSU containing towns with 1977 population over 19,718; low gas sales
07, 11, 26, 59, 81	8	PSU containing towns with 1977 population over 19,718; high gas sales
12, 53, 54, 60, 62	9	PSU with no town with 1977 population over 19,718; low gas sales
05, 13, 14, 76, 83,	10	PSU with no town with 1977 population over 19,718; high gas sales

Each of the ten strata comprises approximately one tenth of the 1977 U.S. population. they are not exactly the same size. Consequently when the ten strata are subdivided into fifty substrata, greater equality among the fifty is possible without requiring each of the ten strata to be divided into the same number of substrata. In the fifty PSU design one PSU has been selected from each of these approximately equal substrata.

Variable Name: Case Number--Stratification

Format: 4 columns - alphanumeric

Beginning Column 3

Element Values:

Level 1 Range: Case Number--001 through 999
 Stratification--A-Z EXCEPT I, O, U, X

Source: Assigned by Automated Sampling System or team according to sampling procedures.

Remarks:

Once a case is selected, the alphabetic character representing this accident's stratum cannot be changed.

The case number is composed of two parts: the first three digits are a consecutive number assigned by the Automated Sampling System or the team ranging from 001 to 999; the second part is the letter of the column in which it is categorized on the NASS Stratification Record (A-Z, except I, O, U, X).

No consecutive numbers should be skipped. If a case must be deleted, the number should not be reused. The letter need not correspond to the letter coded in the Final Stratification (A)B).

Case numbers 001-500 are reserved for cases selected under the basic CSS (including nontowaway) sampling procedure.

Case numbers 501-999 are reserved for those cases selected because of special study requirements.

This variable is a mandatory variable and cannot be changed.

Accident Type	Most Severe Police Reported Injury			
	K	A	B, C, O, U	
			Transported	Nontransported
Pedestrian & Nonmotorist	A	B	C	D
Motorcycle	E	F	G	H
Heavy or Medium Truck	J	K	L	M
Light Truck or Van	towaway	N	O	R
	nontowaway	N	Y	Y
Other Motor Vehicle	towaway	S	V	W
	nontowaway	S	Z	Z

Variable Name: Transaction Code

Format: 1 column - numeric

Beginning
Column 8

Element Values:

- 1 Original case
- 2 Change to existing case
- 3 Delete existing case

Source: Remote Data Entry instructions.

Remarks:

Use code "1" (Original case) for initial submission. RDE (Remote Data Entry) automatically updates the code thereafter.

This variable is a mandatory variable and cannot be changed.

ACCIDENT FORM

A06

Variable Name: Investigator I.D. Number

Format: 1 column - numeric

Beginning
Column 10

Element Values:

Level 1 Range: 1 through 9

Source: Zone center.

Remarks:

The person to whom the case has been assigned is to enter his/her unique number. Subsequent forms will reflect the unique number for the person completing the specific forms.

It is preferred that the person to whom the case has been assigned should also complete this information on the Accident Form and assume responsibility for the quality of the entire case.

Each investigator's unique number is assigned by the PSU's Zone Center.

This variable is a mandatory variable and cannot be changed.

Variable Name: Date (Month, Day, Year)

Format: 6 columns - numeric

Beginning
Column 11

Element Values:

Month

01 January	07 July
02 February	08 August
03 March	09 September
04 April	10 October
05 May	11 November
06 June	12 December

Day

Level 1 Range: 01 through 31

Year

84 1984 (precoded value)

Source: Police report.

Remarks:

This variable is a mandatory variable and cannot be changed.

If the PAR indicates (usually a hit-and-run) that the accident occurred between some p.m. and a.m. time (e.g., 8:00 p.m. and 6:00 a.m.) on either a preceding or following day, code the accident as occurring on the following day. If a range of days is indicated (e.g., between Sunday and Friday) code the last date of the range (e.g., Friday).

Variable Name: Final Stratification

Format: 1 column - alphanumeric

Beginning Column 17

Element Values:

A Ped & Nonmotorist	Police K
B Ped & Nonmotorist	Police A
C Ped & Nonmotorist	Police B, C, O, or Unknown and Transported
D Ped & Nonmotorist	Police B, C, O, or Unknown and Nontransported
E Motorcycle	Police K
F Motorcycle	Police A
G Motorcycle	Police B, C, O, or Unknown and Transported
H Motorcycle	Police B, C, O, or Unknown and Nontransported
J Heavy or Medium Truck	Police K
K Heavy or Medium Truck	Police A
L Heavy or Medium Truck	Police, B, C, O, or Unknown and Transported
M Heavy or Medium Truck	Police, B, C, O, or Unknown and Nontransported
N Light Truck or Van towaway or nontowaway	Police K
P Light Truck or Van towaway or nontowaway	Police A
Q Light Truck or Van towaway	Police B, C, O, or Unknown and Transported
R Light Truck or Van towaway	Police B, C, O, or Unknown and Nontransported
S Other Motor Vehicle towaway or nontowaway	Police K
T Other Motor Vehicle towaway or nontowaway	Police A
V Other Motor Vehicle towaway	Police B, C, O, or Unknown and Transported
W Other Motor Vehicle towaway	Police B, C, O, or Unknown and Nontransported
Y Light Truck or Van nontowaway	Police B, C, O, or Unknown and Transported or Nontransported
Z Other Motor Vehicle nontowaway	Police B, C, O, or Unknown and Transported or Nontransported

Variable Name: Final Stratification (cont'd.)

Source: Investigator determined--inputs include sampling procedures, vehicle inspections, vehicle registrations, interviews, and police report (injuries).

Remarks:

The Final Stratification represents how the case should be stratified, given the final information regarding accident type, towing, and transportation available to the investigator. Medical records information can be used to determine transportation but not to adjust police reported injury severity. The type of forms in the case should, therefore, be consistent with this stratification with the exception of the Vehicle Form. The initial stratification (A02, Case Number--Stratification) determines whether you use the short or long vehicle form. Consequently, this variable's value may be different from the stratification for selection purposes in A02, Case Number--Stratification. In other words, differences may occur when it is subsequently learned that the contents of the police report were: (1) incorrectly stratified, (2) inadequate and led to false but necessary assumptions at the time of initial stratification, or (3) in error: (a) for Q or R versus Y, or V or W versus Z cases, where the actual "towed" status was different than reported by the police; or (b) for C, G, L, Q, or V versus D, H, M, R, or W cases respectively, where the actual "transported" status was different than reported by the police. Examples of the four situations are:

1. The PAR indicates that a motorcycle was struck by an automobile. The motorcyclist received an "A" injury. The investigator incorrectly stratified the accident in stratum "T" instead of stratum "F".
2. The PAR indicated only that a Honda struck a Chevrolet, producing an "A" injury to the Honda driver. The investigator correctly followed the NASS instructions (see Section 2.2, page 19) and stratified the accident in stratum "T". Subsequent investigation revealed that the Honda was a motorcycle, the Chevrolet was a pickup truck, the truck was not in transport, and the truck contained a nonmotorist who was not injured. The motorcyclist was transported from the scene to a treatment facility. In this instance, stratum "R" should be chosen for this variable.
- 3.(a)(1) The PAR indicated a car-light truck collision resulting in only minor (nonincapacitating) injuries, with neither driver requiring transportation, and the car being reported as towed. Subsequent investigation revealed that the car's driver told the police officer that he would call a wrecker but instead, after the officer left the scene, took a crowbar and altered the damage enabling the vehicle to be driven. In this instance, stratum "Y" instead of "R" should be coded for this variable.

ACCIDENT FORM

A08
(3)

Variable Name: Final Stratification (cont'd.)

- (2) The PAR indicated a car-bus collision resulting in no injuries. Neither vehicle was indicated as "towed". Subsequent investigation revealed that the car's driver had been taken into custody and that a wrecker had, in fact, been called. Stratum "W" instead of "Z" is the correct code. (NOTE: In no instance is the investigator to alter the Final Stratification based upon towing that occurred after a vehicle had left the accident scene.)
- (b)(1) The PAR indicated a motorcycle collision resulting in possible ("C") injury. No indication regarding the issue of transport was provided on the PAR. Using the default rule the accident was stratified as a nontransport--stratum "H". It was subsequently learned that the motorcyclist was examined at an emergency room directly following the accident. In this instance, stratum "G" should be coded for this variable.
- (2) The PAR indicated a car-truck collision resulting in minor (possible) injuries to the occupants with one passenger transported to the hospital. Neither vehicle was indicated as towed. The accident was initially stratified as "L" since the default rule requires that unknown truck types be considered as "heavy or medium". Subsequent investigation revealed that the truck was a pickup, the car which was mired was towed back onto the roadway before being driven away, and that all occupants were treated at the scene and not transported. Stratum "R" is the correct code.

Subsequent medical injury information (with one exception) is never used to alter the case's Final Stratification (A08). Stratification is based on the accident's most severe police reported injury. However, it is possible that the police could update the PAR between the time the PAR was stratified and when it was picked up. For example, a person might have been listed originally with incapacitating injuries (A15, Police Reported Accident Severity, equal to "3"). The person later dies (A15 = 4), and the PAR is changed accordingly. When determining the value for this variable, use the latest information that is on the PAR at the time it is obtained from the police agency and becomes a part of this case.

For the purposes of this variable both towing and transportation status can be determined from other NASS variables. For towing to be indicated (strata Q,R,V, or W) there should exist at least one Vehicle Form where V10, Manner of Leaving Scene, has been coded as either "2" (Towed - due to vehicle damage) or "3" (Towed - not due to vehicle damage). In the case of transportation (strata C,G,L,Q, or V), there should exist at least one Pedestrian and Nonmotorist Form or Occupant Form where Treatment - Mortality (P20 or O20) has been coded "1" (Fatal), "3" (Hospitalization), or "4" (Transported and released). This relation holds except in those cases where (a) code "3"

ACCIDENT FORM

A08
(4)

Variable Name: Final Stratification (cont'd.)

(P20 or O20 equals Hospitalization) is appropriate but the person was not "transported" directly from the scene to a medical treatment facility, and (b) code "4" (P20 or O20 equals Transported and released) is not appropriate because the person refused treatment at the facility [see Remarks for P20 or O20, Treatment - Mortality, code "6" (No treatment)]. It must be understood that the reason for using "transportation" as a stratifying criterion is that it serves to further discriminate accidents along the "severity" continuum; thus, codes "3" and "4" serve the intended purpose. Obviously, the presence of a code "1" (Fatal) or "2" (Fatal - ruled disease) for P20 or O20 should indicate a Police Reported Accident Severity Code (A15) greater than B,C,O, or U; however, it cannot be predicted with certainty what type of codes (see Remarks section for A15 regarding the prioritization) will be assigned to persons who are ruled dead as a result of disease. Therefore, any persons with a Treatment - Mortality (P20 or O20) code of "2" (Fatal - ruled disease) will be ignored for the purposes of Final Stratification (A08). Also, since some NASS fatalities [code "1" (Fatal)] may not have been coded K or A, this code must also be considered on the "transportation" issue.

For four of the five categories, a direct mappable relationship exists between the stratification's "accident type" and the Body Type (V14) associated with the accident-involved, in transport, motor vehicles. The relations are:

Pedestrian & Nonmotorist--vehicle type is irrelevant. The presence of a pedestrian or nonmotorist overrides the type of vehicles involved. See Number of Pedestrian & Nonmotorist Forms Submitted (A14) remarks section.

Motorcycle--at least one accident-involved motor vehicle in transport must have a Body Type (V14) coded as a "20"- "29", and there must be no pedestrian or nonmotorist involved.

Heavy or Medium Truck--at least one accident-involved motor vehicle in transport must have a Body Type (V14) coded as "70"- "79", no motor vehicles in transport may have a Body Type coded as "20"- "29", and there must be no pedestrian or nonmotorist involved.

Light Truck or Van--at least one accident-involved motor vehicle in transport must have a Body Type (V14) coded as "40"- "69", no motor vehicles in transport may have a Body Type coded as a "20"- "29" or as "70"- "79", and there must be no pedestrian or nonmotorist involved.

Other Motor Vehicle--all accident-involved motor vehicles in transport must have a Body Type (V14) coded as a "01-13", "30-39", "80-89", or "99" [see Hit & Run (A16) remarks section], and there must be no pedestrian or nonmotorist involved.

ACCIDENT FORM

A09

Variable Name: Blank - Variable deleted from 1984 CSS

This variable is left blank so that numbering consistency can be maintained with the 1983 CSS.

Variable Name: First Harmful Event

Format: 2 columns - numeric

Beginning
Column 23

Element Values:

Non-Collision

- 01 Overturn
- 02 Fire or explosion
- 03 Immersion
- 04 Gas inhalation
- 05 Fell from vehicle
- 06 Injured in vehicle
- 07 Other non-collision

Collision with

- 08 Pedestrian
- 09 Pedalcyclist
- 10 Railway train
- 11 Animal
- 12 Motor vehicle in transport - same roadway
- 13 Motor vehicle in transport - other roadway
- 14 Parked motor vehicle
- 15 Other type nonmotorist
- 16 Thrown or falling object
- 17 Boulder
- 18 Other object (not fixed)

Collision with Fixed Object

- 19 Building
- 20 Impact attenuator/Crash cushion
- 21 Bridge pier or abutment
- 22 Bridge parapet end
- 23 Bridge rail
- 24 Guardrail
- 25 Concrete traffic barrier
- 26 Other longitudinal barrier
- 27 Highway/Traffic sign post
- 28 Overhead sign support
- 29 Luminaire/Light support
- 30 Utility pole
- 31 Other post, pole, or support
- 32 Culvert
- 33 Curb

Variable Name: First Harmful Event (cont'd.)

- 34 Ditch
- 35 Embankment - earth
- 36 Embankment - rock, stone or concrete
- 37*
- 38 Fence (wooden, wire, chain link, etc.)
- 39 Wall (stone, rock, metal, etc.)
- 40 Fire hydrant
- 41 Shrubbery
- 42 Tree
- 43 Other fixed object
- 44 Pavement surface irregularity (pothole, grooved, grates)
- 99 Unknown

* Code 37 is omitted to maintain consistency with the Fatal Accident Reporting System (FARS)

Source: Investigator determined--inputs include the police report, scene inspection, vehicle inspections, and driver interviews.

Remarks:

Definitions: see ANSI D16.1-1976, sections 2.3.1 through 2.3.6, pages 8-9. These sections define: injury, damage, harmful event, unstabilized situation, cataclysm, and accident, respectively.

Every motor vehicle traffic accident consists of a series of events. In classification by type, one of the events must be selected before further classification can be made. For uniformity in classification, the "First Harmful Event" is the first property damage or injury-producing event that can be determined to have happened in the accident.

The basis of this classification is the information acquired (scene inspection, interview, etc.) during the NASS investigation. Police reports may prove helpful in selecting the appropriate code, but are not the sole determinant for code selection (i.e., the investigator may select a code which is different from the one indicated by the police report, given the discovery of additional data).

Code "01" (Overturn) includes uncontrolled motorcycles which first contact the ground or pavement surface. Motorcycles which first impact pedestrians, nonmotorists, vehicles, animals, trains, or other objects, are coded "08" through "43". Although a motorcycle can overturn, it cannot be coded (as defined in NASS) as a rollover. For a motorcycle whose First Harmful Event is overturn (A10 equals 01), V71, Rollover, must be coded "0" (No).

Variable Name: First Harmful Event (cont'd.)

Code "07" (Other non-collision) is used whenever a vehicle jackknife is the First Harmful Event. Also included are instances when a vehicle sets an object in motion that strikes or is struck by a vehicle before the object stabilizes. Examples include dislodged cargo, spewed gravel, etc. It may be used in other situations subject to consultation with the Zone Centers.

Code "08" (Pedestrian) refers to any person who is on a trafficway or on a sidewalk or path contiguous with a trafficway, and who is not in or on a nonmotorist conveyance. A nonmotorist conveyance is defined as any human-powered device by which a nonmotorist may move, or by which a pedestrian or nonmotorist may move another nonmotorist, other than by pedaling. A nonmotorist conveyance includes the following: baby carriage, coaster wagon, ice skates, roller skates, push cart, scooter, skate board, skis, sled, wheel chair, rickshaw, etc. Excluded are pedalcyclists.

Code "09" (Pedalcyclist) refers to any occupant of a pedalcycle (see ANSI D16.1-1976, section 2.2.16, page 6).

Code "12" (Motor vehicle in transport - same roadway) includes all initial impacts between two motor vehicles in transport which occur: (1) in a junction, or (2) not in a junction but on the same roadway. In the latter instance, neither vehicle departed its roadway prior to impact.

Code "13" (Motor vehicle in transport - other roadway) includes only those initial impacts when two motor vehicles in transport collide because one of the vehicles departed its roadway and entered, without previous harm, another roadway. One example of this phenomena occurs when a vehicle crosses through a median and strikes a vehicle in the opposing roadway. A second example involves the situation where a vehicle leaves the roadway and enters an intersecting roadway outside of the junction. This category is to be distinguished from the situation where a motor vehicle in transport leaves its roadway and strikes a motor vehicle not in transport. This latter situation is coded as "14" (Parked motor vehicle).

Code "14" (Parked motor vehicle) includes all initial impacts between a motor vehicle in transport and a motor vehicle neither on a roadway nor in motion.

Code "15" (Other type nonmotorist) refers to a person who is not a pedestrian or a pedalcyclist. See variable P08 (Pedestrian or Nonmotorist's Type), attributes "4" and "8". [NOTE: If the first harmful event occurs with a motor vehicle not in transport which contains a nonmotorist (P08 = 5, Occupant of vehicle not in transport), use code "14" (Parked motor vehicle) above.]

Code "16" (Thrown or falling object) refers to any object which (1) is

Variable Name: First Harmful Event (cont'd.)

thrown [intentionally (subject to the malicious mischief exception to the deliberate intent exclusion--page 7) or unintentionally] and impacts an in transport vehicle, or (2) falls onto, into, or in the path of an in transport motor vehicle. However, objects set in motion by an in transport vehicle are to be coded under code "07" (Other non-collision). If a tree limb falls from a tree and is contacted by a car, use this code. If a tree limb falls from a tree trimming truck and is struck before it stabilizes, use code "07". If a boy maliciously throws a tree limb off of an overpass into traffic below, use this code.

Code "17" (Boulder) is used when an in transport motor vehicle contacts any large (not defined but at least larger than grave?) stationary rock.

Code "18" [Other object (not fixed)] refers to an initial impact between a motor vehicle in transport and any other object that is moving or not anchored prior to the accident. Included in this category is an initial collision between a motor vehicle in transport, which leaves its roadway, and a motor vehicle in motion off any trafficway. An example of this situation is where a vehicle loses control and contacts a snowmobile in motion off the trafficway.

Code "20" (Impact attenuator/Crash cushion) should be used when the first harmful event is with any of the devices included on continuation pages (7) through (13).

Code "21" (Bridge pier or abutment) is used when the initial contact was with any part of a structural member of the bridge that supports the overpass structure (this includes side walls used to retain earth). See Figure 8.

For contact to the "front face" of an overpass structure (e.g., the top of the cargo area of a truck strikes the front of a bridge with a low clearance) code "43" (Other fixed object).

Code "22" (Bridge parapet end) is used when the initial contact was with the end structure of the bridge rail (including the end structure of concrete type railings). See Figure 8.

Code "23" (Bridge rail) is used when the initial contact was with any portion of the bridge rail except for the parapet end. See Figure 8.

If the initial impact was with an impact attenuator protecting a bridge support, then "20" (Impact attenuator) should be used. Contact with the underside of the bridge deck is coded "43" (Other fixed object).

Included within the meaning of bridge structure are supports for railway underpasses, including those for mass transit type trains.

Variable Name: First Harmful Event (cont'd.)

Code "24" (Guardrail) is used whenever the initial impact is with a guardrail which is located on the roadside. Guardrails include, but are not limited to, "W" beams, thrie beams, cable guardrails and box beams. Guardrails which are located in gore areas (ANSI D16.1-1976, section 2.5.20, page 15), are coded "24" (guardrail), although they are used to redirect traffic at a ramp area. If the trafficway is undivided, the guardrail can be located on either side of the road. Guardrails which are located in a median (and do not function as a guard for a fixed object) should be coded "26" (other longitudinal barrier).

Code "25" (Concrete traffic barrier) is used whenever an impact occurs with a longitudinal barrier which is composed entirely of concrete. Use this code regardless of whether the barrier is a permanent fixture or a temporary installation, such as at a construction site. Concrete traffic barriers located on a bridge with a "closed" median is not considered a bridge rail. Concrete traffic barriers located on the outer road edges of a bridge are considered bridge rails. Examples of concrete traffic barriers are shown in figure 9, #6 and #7.

Code "26" (Other longitudinal barrier) is used whenever an impact occurs with a longitudinal barrier that does not meet the criteria for codes "23", (bridge rail), "24", (guardrail), or "25" (concrete traffic barriers), except when a guardrail functioning as a guard for a fixed object is located in the median (e.g., guardrail protecting a bridge pier located in the median is coded "24"). Examples of median barriers (other longitudinal barriers) are illustrated in Figure 9, #1 - #5.

Codes "27" (Highway/Traffic sign post), "28" (Overhead sign support), "29" Luminaire/(light support), and "30" (Utility pole) are distinguished by the nature of the object supported. Use code "27" if the impact occurs to a support for a highway or traffic sign. Use code "28" if the impact occurs with anything that supports a sign under which vehicles travel. Use code "29" if the pole's primary function is to support a street light. Use code "30" if the pole's primary function is to support utility lines.

Code "31" (Other post, pole, or support) if the impact occurs with (1) a traffic signal pole, (2) any nonhighway or nontraffic sign (e.g., a private sign), (3) a mail box post, (4) a delineator post, or (5) any other type post, pole, or support. Code "31" should not be used when the initial impact was with any supporting structure of a bridge (see codes "21" through "23" above).

Code "32" (Culvert) is a man made structure that allows passage over a drainage area and is that part of the structure which is intended to channel flow through the structure and maintain the stability/integrity of the road

Variable Name: First Harmful Event (cont'd.)

hed. If the structure has a portion above the road surface which is of sufficient height to engage above the wheels of an errant passenger vehicle and redirect it, that part of the structure is considered a bridge rail (code "23"). A ditch (code "34") ends where a culvert begins and resumes on the opposite side of the culvert.

Code "34" (Ditch) is a man made structure for drainage purposes. When the sides of the ditch are approximately of equal height it makes no difference which side of the ditch was struck; however, if the struck side is substantially higher than the other side, code the impact with the struck side as an embankment (codes "35" and "36"). Substantial means that an embankment existed had the ditch not been present.

Codes "35" (Embankment - earth) and "36" (Embankment - rock, stone or concrete) should be used only when damage or injury results from impacting the embankment. For example, the first harmful event for a motorcyclist who travels up an embankment, loses control, and falls over should be coded ground (code "43", Other fixed object). These codes are used if, for example, the motorcyclist, car, etc., sustains direct damage from impacting the embankment.

Code "43" (Other fixed object) refers to any fixed object which is anchored and not moving and not specifically mentioned above. This includes ground and pavement; however, ground or pavement are not to be coded when the first event is an overturning ("01"). All motor vehicles (including motorcycles) may overturn. For Object Contact (V26, V35, V44, V53), ground (pavement) (V26, V35, V44, V53 = 60) could be coded for an overturned vehicle, but not on this variable (A10). Collisions which may be classified using this code include (but are not limited to): (1) vehicles which sustain undercarriage damage by straddling the pavement and shoulder and impacting a prominent pavement lip, or (2) free falls or vaults from the road surface to the ground or pavement without excessive roll action prior to impact.

Medians are handled as follows. If the median contains a physical barrier, then code "25" (Concrete traffic barrier) or "26" (Other longitudinal barrier). However, to use these codes the barrier type fixed object must have been the cause of the initial harm. Commonly encountered types are illustrated in Figure 9 [A10 page (15)] Other median barriers may be encountered; therefore, the investigator should be sure to photograph them for verification when uncertain.

Where the median is curbed, paved, gravel, or grass only, then do not use these codes. If the median is depressed and the impact occurs with the ground, then code "35" (Embankment - earth), "36" (Embankment - rock, stone or concrete) or "43" (Other fixed object), whichever is most appropriate.

ACCIDENT FORM

A10

(7)

Variable Name: First Harmful Event (cont'd.)

If the initial harmful event is with a raised, paved area (concrete or bituminous), the code "33" (Curb), should be used. This is true even if a barrier is anchored in the raised, paved area.

Tunnels are handled according to the following rules. If the impact is external (i.e., the impact is to the hill or mountainside), code embankment (codes "35" or "36"). If the impact is to the tunnel entrance (i.e., not protected by guardrails or bridge rails that lead into a tunnel or impact attenuators), then code "43" (Other fixed object). Code "39" (Wall) should be used if the plane of the tunnel is broad or wide enough that the tunnel entrance functions as a wall, and contact is made with this wall. External impacts to impact attenuators should be coded "20".

Internal or external impacts to: (a) median barriers should be coded either "25" (Concrete traffic barrier) or "26" (Other longitudinal barrier); (b) guardrails should be coded "24" (Guardrail); (c) curbs (raised, paved medians) or walks should be coded "33" (Curb); or (d) the tunnel wall should be coded "39" [Wall (stone, rock, metal, etc.)]. If contact is made with a bridge that leads into a tunnel, code "22" (Bridge parapet end) or "23" (Bridge rail).

Variable Name: First Harmful Event (cont'd.)

Fitch Inertial Barrier - This barrier consists of plastic barrels in which the upper portion is filled with sand. The barrels are clustered at the highway hazard as shown in Figure 1 and, on impact, vehicle energy is attenuated by displacement of sand.

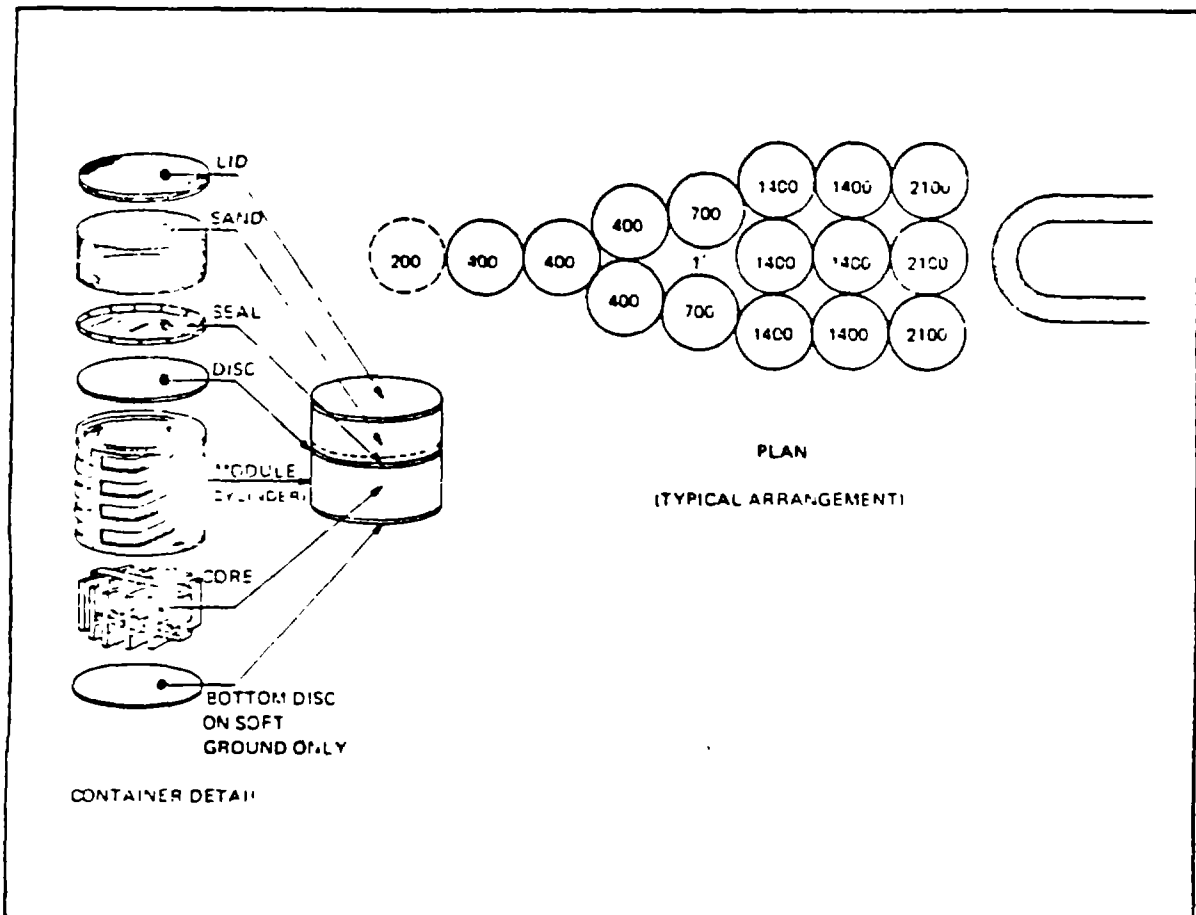

FIGURE 1

Variable Name: First Harmful Event (cont'd.)

Torshok Barrier - This barrier consists of a U-shaped (in overhead view) arrangement of protective tubular railing surrounding axially loaded cylinders supported from the highway hazard. Energy absorption is achieved through the compression of the axially loaded cylinders and energy attenuation through the deformation of a steel torus placed between the cylinders (Figure 2).

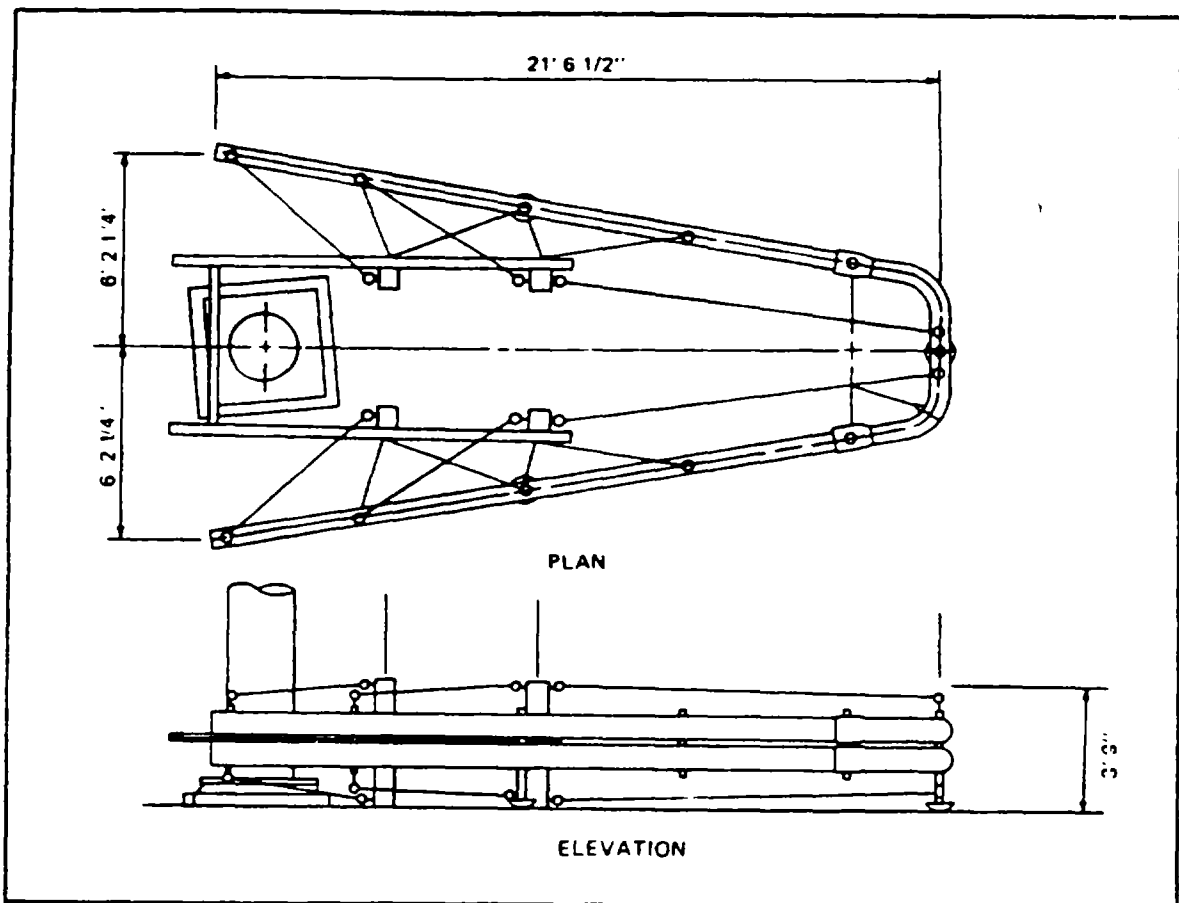

FIGURE 2

Variable Name: First Harmful Event (cont'd.)

Hi-DRO Cushion Crash Barrier - This system consists of plastic cylinders filled with water which are grouped in modular clusters. Energy attenuation is achieved by forcing water out of the plastic cylinders (Figure 3). Overlapping fender (contact) panels are provided as a contact surface and for vehicle guidance.

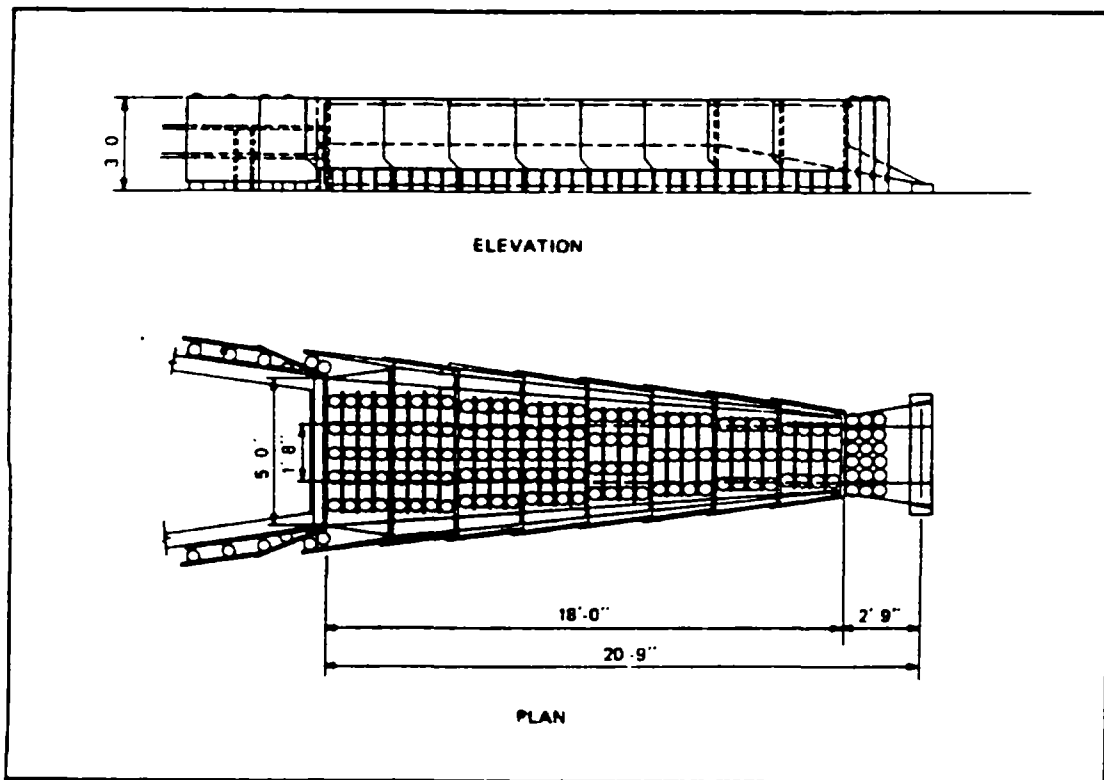

FIGURE 3

Variable Name: First Harmful Event (cont'd.)

Modular Crash Cushion (Steel Drum) - This barrier consists of modular clusters of 55 gallon steel drums at a highway hazard site. Fender panels are provided, and energy attenuation is achieved by successive crushing of the drums upon impact (Figure 4).

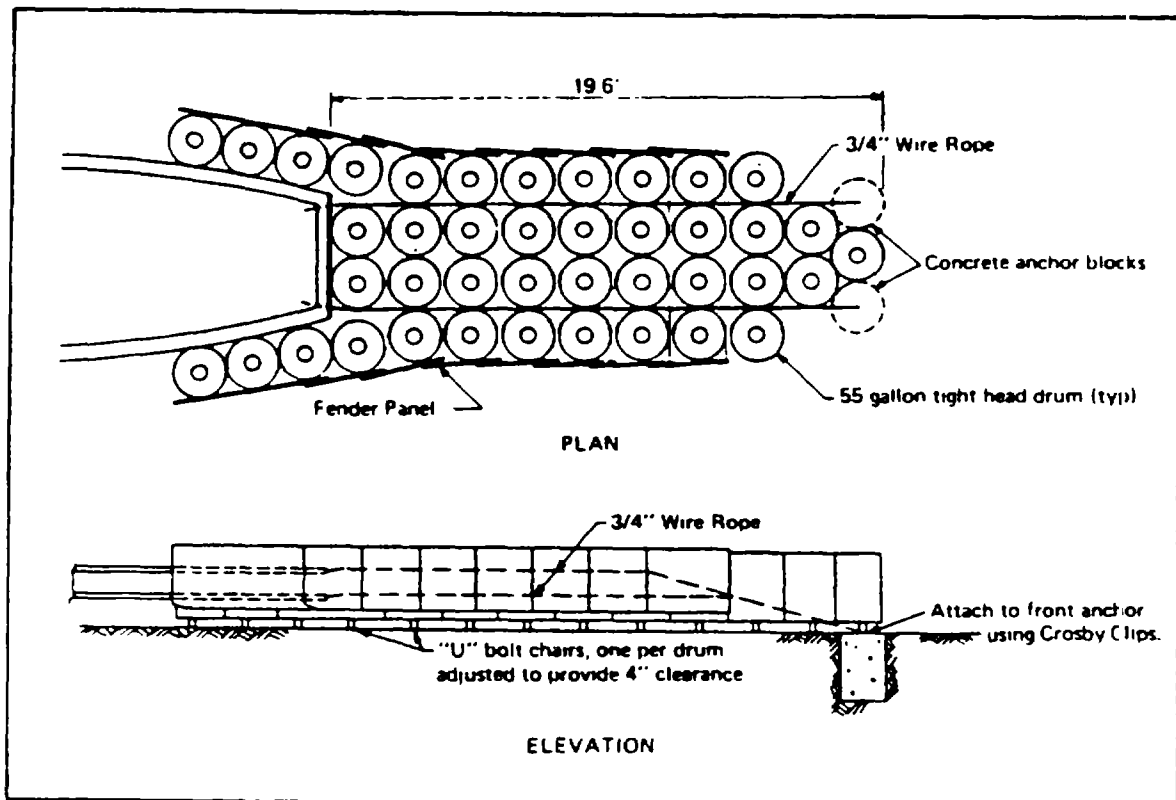

FIGURE 4

Variable Name: First Harmful Event (cont'd.)

Vermiculite Concrete Barrier - This barrier consists of a grouping of light-weight cellular concrete modules at the highway hazard site. Energy attenuation is achieved through successive crushing of these concrete modules. Fender panels may also be present (Figure 5).

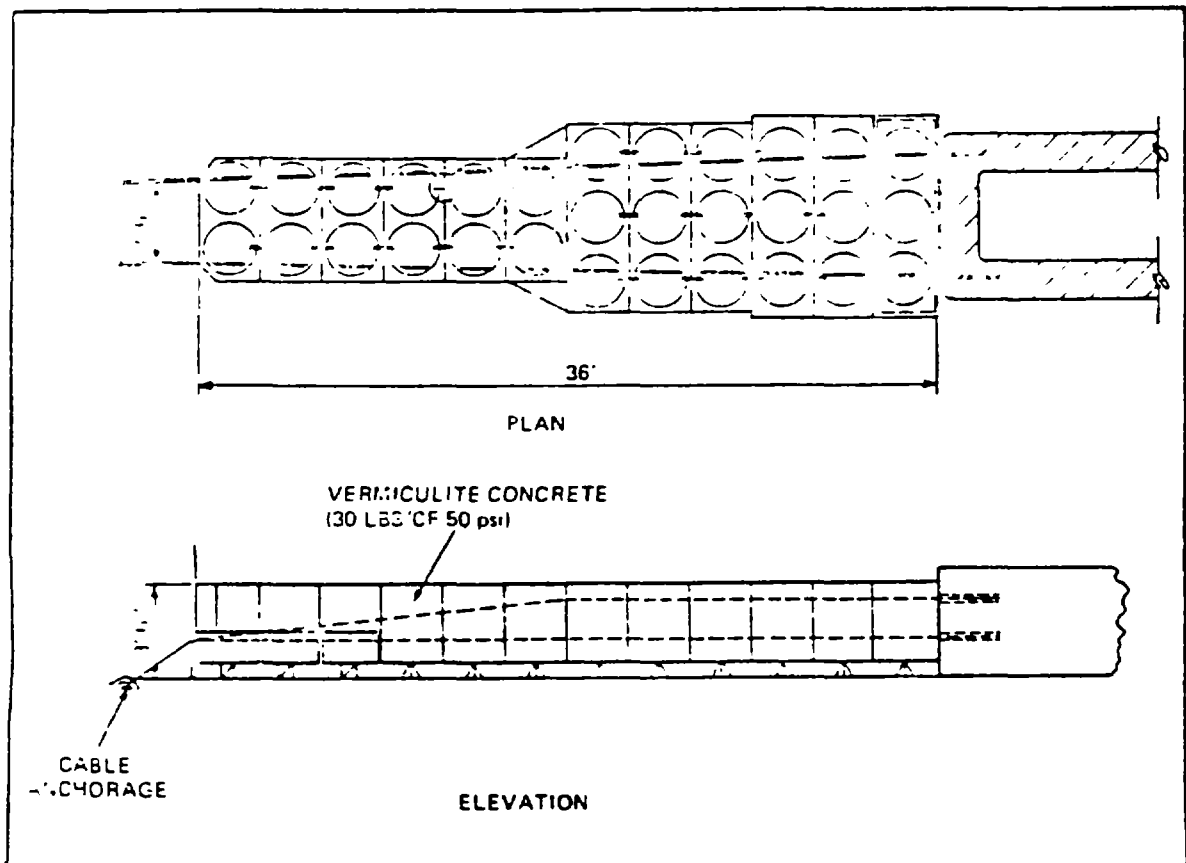

FIGURE 5

Variable Name: First Harmful Event (cont'd.)

Van Zelm Dragnet System - This barrier consists of a net device for vehicle contact which is attached to a steel tape. Each end of the tape is, in turn, run through a Metal Bender which exerts a constant restraining force on the tape as it is pulled through the device, thus, arresting vehicle progress (Figure 6).

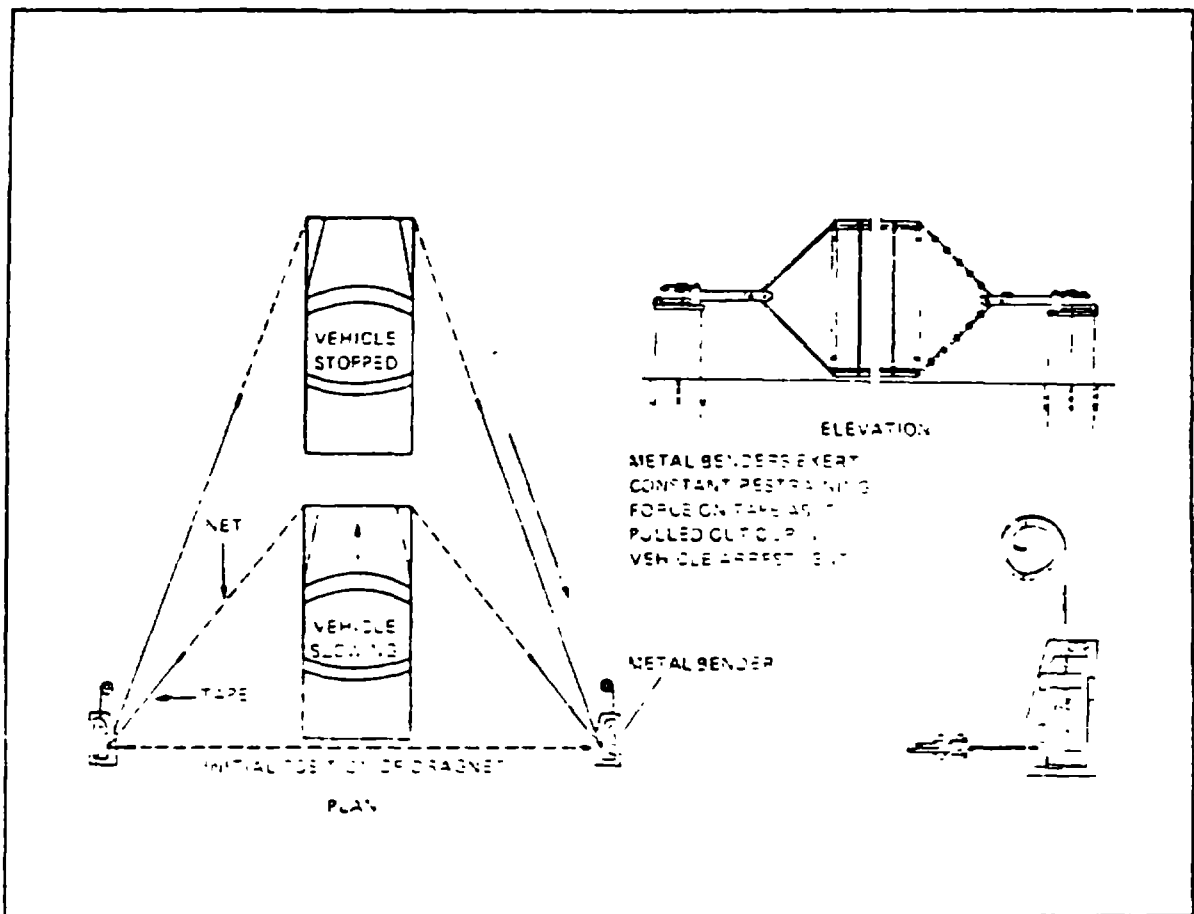

FIGURE 6

Variable Name: First Harmful Event (cont'd.)

Goodyear Automobile Tire Cushion - This barrier consists of long runs of discarded tires which are joined together at a highway hazard site. Energy attenuation is achieved by successive collapse of the tires upon impact (Figure 7).

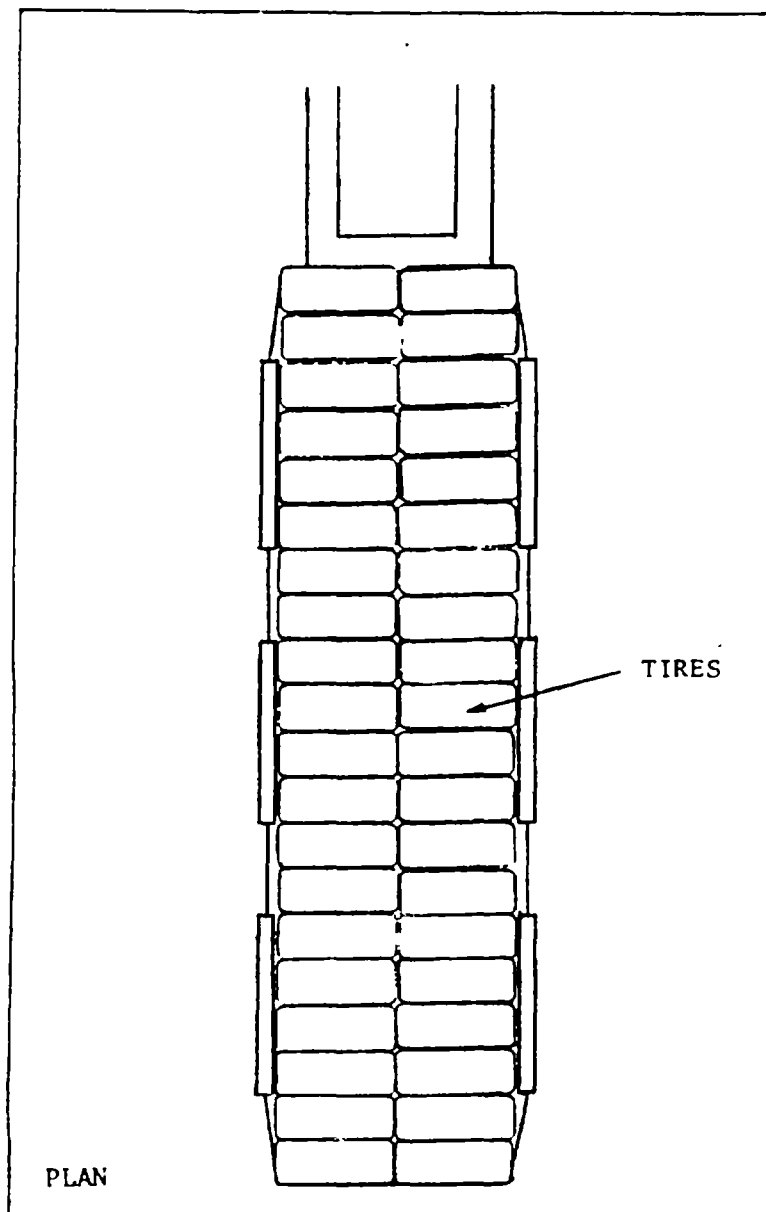
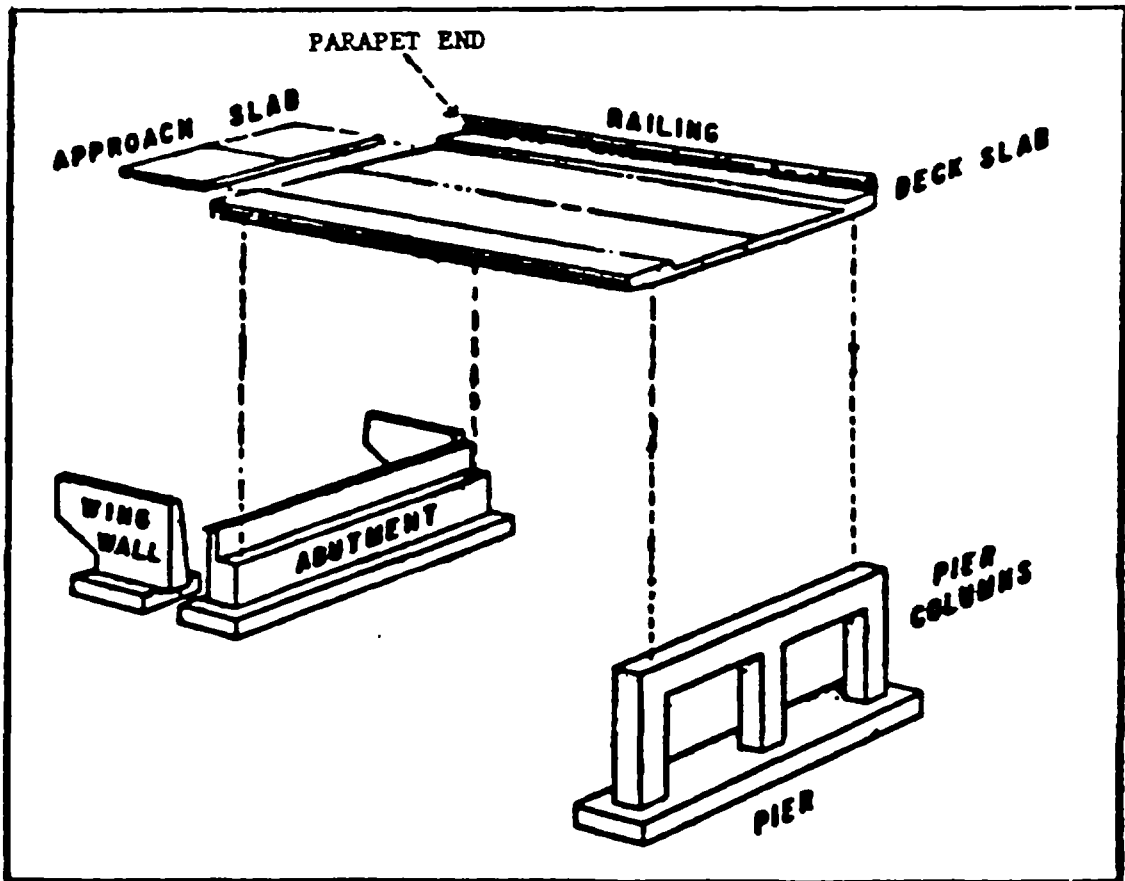

FIGURE 7

Variable Name: First Harmful Event (cont'd.)

Bridge Components



● **INDIVIDUAL** components of a bridge collectively become the bridge.

FIGURE 8

COMMON TYPES OF MEDIAN BARRIERS

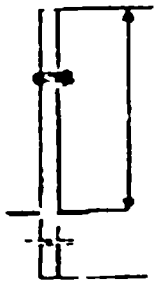
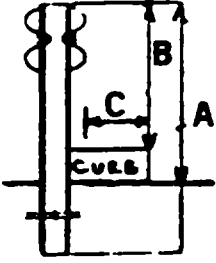
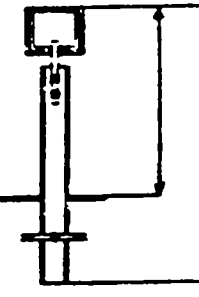
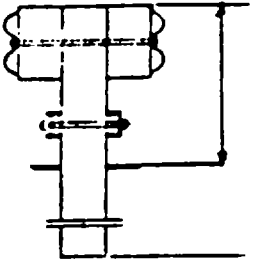
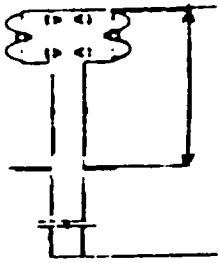
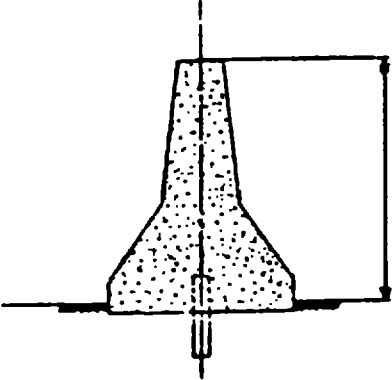
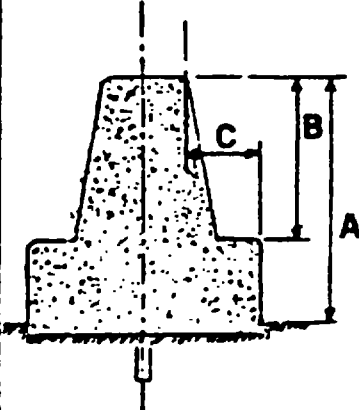
			
<p>MB1 CABLE 1</p>	<p>MB2 "W" BEAM 2</p>	<p>MB3 BOX BEAM 3</p>	<p>MB4W BLOCKED-OUT "W" BEAM (Wood Post) 4</p>
			
<p>MB4S BLOCKED-OUT "W" BEAM (Steel Post) 5</p>	<p>CONCRETE BARRIER 6</p>	<p>CONCRETE BARRIER 7</p>	

Variable Name: Manner of Collision (Based on First Harmful Event)

Format: 1 column - numeric

Beginning
Column 25

Element Values:

- 0 Not collision with vehicle in transport
- 1 Rear-end
- 2 Head-on
- 3 Rear-to-rear
- 4 Angle
- 5 Sideswipe, same direction
- 6 Sideswipe, opposite direction
- 9 Unknown

Source: Investigator determined--inputs include the police report, scene inspection, vehicle inspections, and driver interviews.

Remarks:

Code "0" (Not collision with vehicle in transport) means First Harmful Event (A10) was not coded as "12" or "13".

Code "1" (Rear-end) refers to a collision between the rear of one vehicle and the front of another vehicle.

Code "2" (Head-on) refers to a collision where the front end of one vehicle collides with the front end of another vehicle.

Code "3" (Rear-to-rear) refers to a collision where the rear of one vehicle collides with the rear of another vehicle.

Code "4" (Angle) refers to those collisions which are known but cannot be classified with any other code. Included here, also, are endswipes.

Code "5" (Sideswipe, same direction) refers to collisions where the primary direction of force for the two motor vehicles is such that there is minimal side engagement of the two vehicles travelling in the same direction. The resulting damage is primarily restricted to sheet metal involvement with no significant structural engagement (i.e., no frame or A, B, C, etc., pillar engagement which halts the sideswipe). At least one vehicle must be contacted in the side (L or R in column 3 of the CDC) and column 6 of the same CDC must equal S.

ACCIDENT FORM

A11
(2)

Variable Name: Manner of Collision (Based on First Harmful Event) [cont'd.]

Code "6" (Sideswipe, opposite direction) refers to collisions where the primary direction of force for the motor vehicles is such that there is minimal side engagement of the two vehicles travelling in opposite directions. The resulting damage is primarily restricted to sheet metal involvement with no significant structural engagement (i.e., no frame or A, B, C, etc., pillar engagement which halts the sideswipe). At least one vehicle must be contacted in the side (L or R in column 3 of the CDC) and column 6 of the same CDC must equal S.

Variable Name: Relation to Roadway (Location of First Harmful Event)

Format: 1 column - numeric

Beginning
Column 26

Element Values:

- 1 On roadway
- 2 On shoulder
- 3 In median
- 4 On roadside
- 5 Outside right-of-way
- 6 Off roadway - location unknown
- 7 In parking lane
- 8 Gore
- 9 Unknown

Source: Investigator determined--inputs include the police report, scene inspection, vehicle inspections, and driver interviews.

Remarks:

On this variable, code the location of the First Harmful Event (A10) in accordance with the attribute which best describes the location.

Code "1" (On roadway) refers to that part of the trafficway designated, improved and ordinarily used for motor vehicle travel (Definition: ANSI D16.1-1976, section 2.2.17, page 6). In addition, code on roadway ("1") if the impact occurs with a bridge structure (see remarks section for A10, First Harmful Event, codes "21"- "23") that is on a roadway and was designed to allow motor vehicles to move in (change lanes) between the supporting piers. Note: This code may not be used when a vehicle in transport on a roadway impacts another vehicle (not in transport) or its cargo where it protrudes onto the roadway (e.g., side mirrors or a door opened from a parked vehicle in an implicitly designated parallel parking lane).

Code "2" (On shoulder) refers to that part of a trafficway contiguous with the roadway for emergency use, for accommodation of stopped vehicles, and for lateral support of the roadway structure (Definition: ANSI D16.1-1976, section 2.2.18, pages 6-7).

Code "3" (In median) refers to the area of separation between two adjacent roadways on the same trafficway and is not a "gore" (see below). More than one "median" may exist on the same trafficway. Code "3" (In median) if the First Harmful Event (A10) occurs in the separation between two roadways.

ACCIDENT FORM

A12

(2)

Variable Name: Relation to Roadway (Location of First Harmful Event) [cont'd.]

Also, use this code if the first harmful event occurs with a curb which is part of a curbed median (see also the discussion of medians in the remarks section for A10, First Harmful Event). In addition, code in median ("3") if the impact occurs with a bridge structure (see note above) that was designed to separate (or has the same secondary effect) opposing lanes of travel or prevent motor vehicles from changing lanes.

Code "4" (On roadside) refers to a location off the road, but inside the right-of-way (Definition: ANSI D16.1-1976, section 2.2.19, page 7). For example, a guardrail, tree, mailbox, etc., could be coded "4" (On roadside) since the shoulder is assumed to end where the object begins. Code "4" (On roadside) is used when a vehicle strikes a curb which is contiguous with either the roadway or a parking lane at the location of the impact.

Code "6" (Off roadway - location unknown) refers to a location off the roadway, but its relationship to the right-of-way is not known.

Code "7" (In parking lane) is used when an in transport vehicle enters a designated, implicit or explicit, parallel parking lane area on the road prior to impacting another vehicle or object in that same area [e.g., if you have determined that a struck motor vehicle was in a parking lane and, therefore, not in transport, code "7" (In parking lane) should be used]. If a collision occurs on the road in a nonparallel designated parking area (e.g., angular parking), then this code should be used.

Code "8" (Gore) refers to the area of land that is found between two roads which split, one from the other or join, one to the other (Definition: ANSI D16.1-1976, section 2.5.20, page 15). Normally one of the roads will be a ramp (see A24, Relation to Junction, code "08")--entrance or exit, at-grade or not at-grade. Code "8" (Gore) is used if the First Harmful Event (A10) occurs in the triangulated type area formed by the boundaries of the "roads", measuring along them a distance of 200 feet from the beginning of their physical separation, and a line between these two points. See ANSI D16.1-1976, Figure 1, page 16 for an example gore (shaded) area where it is assumed that the distance measured along each of the roads is 200 feet.

Code "8" (Gore) takes precedence over on roadside, outside right-of-way, or off roadway - location unknown (codes "4" through "6"). But, if a vehicle departs the road into the gore area but does not have its first harmful event until after it passes through the gore area, but before it enters any other road, then one of codes "4" (On roadside), "5" (Outside right-of-way), or "6" (Off roadway-location unknown) should be used.

Variable Name: Number of Vehicle Forms Submitted

Format: 2 columns - numeric

Beginning
Column 27

Element Values:

Level 1 Range: 01 through 30

Source: Investigator determined--inputs include police report, scene inspection, driver interviews, and other interviewees.

Remarks:

Each accident must have at least one Vehicle Form or Vehicle Form Non-Towaway Accident Form submitted. For every form there must be one Driver Form. The value recorded must equal the number of Vehicle Forms or Vehicle Form Non-Towaway Accident Forms present in the case.

This variable is a mandatory variable and cannot be changed.

A form must be submitted for each in transport motor vehicle involved in the accident. For example, one vehicle is towing another by a nonfixed linkage (e.g., rope, chain, etc.). Both vehicles are involved in the accident. A form is required for both vehicles. Whereas, if the linkage was fixed (see V07, Vehicle Number, for a definition of "fixed linkage"), only the power unit would be considered in transport.

Hit and run accidents (see variable A16, Hit and Run, for the meaning of this phrase for NASS purposes) occasionally cause some confusion on this variable. A vehicle form is filled out for each in transport vehicle involved in the accident independent of the amount of information collected on the vehicles by the police. Parked vehicles may or may not require a form depending on whether or not they were in transport. A thorough discussion of the sampling frame is found in section 2.0 of the Introduction (pages 5 through 23).

Variable Name: Number of Pedestrian & Nonmotorist Forms Submitted

Format: 2 columns - numeric

Beginning
Column 29

Element Values:

Level 1 Range: 00 through 25

Source: Investigator determined--inputs include police report, scene inspection, driver interviews, and other interviewees.

Remarks:

If any pedestrian or nonmotorist was present in the accident, then the accident (Final Stratification, A08) must be classified as a pedestrian and nonmotorist accident. The value recorded must equal the number of pedestrians and/or nonmotorists for which a form was submitted.

This variable is a mandatory variable and cannot be changed.

Variable Name: Police Reported Accident Severity

Format: 1 column - numeric

Beginning
Column 31

Element Values:

- 0 No injury (O)
- 1 Possible injury (C)
- 2 Nonincapacitating injury (B)
- 3 Incapacitating injury (A)
- 4 Killed (K)
- 5 Injury, severity unknown
- 6 Died prior to accident
- 9 Unknown

Source: Police report.

Remarks:

Select the numeric code which represents the most severely injured person on the police report submitted* with the case: occupant, pedestrian, or non-motorist.

If the police report contains a detailed description of the injuries but does not translate the injuries into the KABCO codes, use the police method for doing so. For example, injuries which are considered to be of an incapacitating nature are classified as "A" (code "3"); nonincapacitating evident injuries are "B" (code "2"); and possible injuries are "C" (code "1"). Property damage only is classified as "O" (code "0").

Code "5" (Injury, severity unknown) if the police report indicates "U" or in any other way communicates the idea that some person was injured but their severity is unknown. This code should not be used if any other person has an injury of known severity.

*It is possible that the police would have updated the PAR between the time it was stratified (A02, Case Number--Stratification) and when it was picked up. For example, a person might have been listed originally with incapacitating injuries ("3"). Later the person dies ("4"), and the PAR is changed accordingly. Therefore, use the latest information on the PAR at the time it was obtained from the police agency.

Variable Name: Police Reported Accident Severity (cont'd.)

Code "6" (Died prior to accident) should only be coded: (1) if the police explicitly so indicate that one of the persons died prior to the accident, and (2) no other persons involved in the accident received an injury.

The order of code precedence where more than one person is involved in the accident is as follows: "4", "3", "2", "1", "5", "6", "9", and "0".

Not all states use the KARCOU scheme. Listed below, by state, are alternative schemes; a mapping to the NASS scheme is provided.

State	PAP Code/Definition	NASS Scheme/Code
Alabama	K = Killed	K - 4
	A = Visible or carried from scene	A - 3
	B = Bruise/abrasion/swelling	B - 2
	C = No visibility - has pain/faint	C - 1
	Blank = No documentation of driver or occupant injury = No set unknown code	Blank - 0 - 9
Arizona	1 = No injury	O - 0
	2 = Possible injury	C - 1
	3 = Nonincapacitating injury	B - 2
	4 = Incapacitating injury	A - 3
	5 = Fatal	K - 4
	6 = Unknown	U - 5
California	1 = Fatal	K - 4
	2 = Severe wound/distorted member	A - 3
	3 = Other visible injury	B - 2
	4 = Complaint of pain	C - 1
	blank = Occupant present blank = Occupant not present	O - 0 - 9
Colorado*	5 = Fatal	K - 4
	4 = Evident - incapacitating	A - 3
	3 = Evident - nonincapacitating	B - 2
	2 = Possible injury	C - 1
	1 = No injury	O - 0

*There is a box at the top of the PAR indicating number of persons injured. If this box is marked 0 and the injury code is left "blank", assume "No injury". If the box is marked 1 (or more) pertaining to the vehicle occupants in question and the injury code is "blank", assume "Injured, severity unknown". If "blanks" are present in both the persons injured box and the injury code box, assume "Unknown".

Variable Name: Police Reported Accident Severity (cont'd.)

State	PAR Code/Definition			NASS Scheme/Code
Florida	1 = No injury			O - 0
	2 = Fatal "in 90 days" injury			K - 4
	3 = Incapacitating injury			A - 3
	4 = Nonincapacitating injury			R - 2
	5 = Possible injury			C - 1
	6 = Non-traffic fatality			K - 4
	= No set unknown code			- 9
Indiana	Nature of Most Severe Injury	Location of Most Severe Injury	Victim's Injury Status	
	1-11 Any Entry	1-12 Any Entry	6 Dead	K - 4
	1-11 Any Entry	1-12 Any Entry	2 Semiconscious 3 Incoherent 4 Unconscious	A - 3
	1 Severed 2 Internal 4 Severe Burn 7 Severe Bleed (Arterial) 8 Fracture/dislocation	1-12 Any Entry	1 Conscious 5 Shock 7 Refused Med	A - 3
	3 Minor Burn 6 Minor Bleed 10 Complaint of Pain 11 None Visible	3 Eye	1 Conscious 5 Shock 7 Refused Med	A - 3
	3 Minor Burn 6 Minor Bleed	1-2, 4-12 (Any EXCEPT Eye)	1 Conscious 5 Shock 7 Refused Med	R - 2
	5 Abrasion 9 Contusion/Bruise	1-12 Any Entry	1 Conscious 5 Shock 7 Refused Med	R - 2
	10 Complaint of Pain 11 None Visible	1-2, 4-12 (Any EXCEPT Eye)	1 Conscious 5 Shock 7 Refused Med	C - 1
	11 None Visible	Blank or Slashed	1 Conscious	O - 0
	Blank or Slashed	Blank or Slashed	Blank or Slashed	O - 0
	Unknown	Unknown	Unknown	U - 9

ACCIDENT FORM

A15
(4)

Variable Name: Police Reported Accident Severity (cont'd.)

State	PAR Code/Definition	NASS Scheme/Code
Iowa	1 = Fatal	K - 4
	2 = Major (incapacitating)	A - 3
	3 = Minor (bruises and abrasions)	B - 2
	4 = Possible (complaint of pain)	C - 1
	Ø = Unknown	U - 9
	Blank = No documentation of driver or occupants on back of PAR	O - 0
Louisiana	1 = Fatal	K - 4
	2 = Severe	A - 3
	3 = Noticeable	B - 2
	4 = Complaint of pain or momentary unconsciousness	C - 1
	5 = None	
Maryland	5 = Fatal	K - 4
	4 = Incapacitating	A - 3
	3 = Nonincapacitating	B - 2
	2 = Possible injury	C - 1
	1 = No injury/Damage only	O = 0
	Blank = No documentation of driver or occupants on front of PAR	
Massachusetts	K = Killed	K - 4
	A = Visible signs of injury, as bleeding wound or distorted member; or had to be carried from scene	A - 3
	R = Other visible injury, as bruises, abrasions, swelling, limping, etc.	B - 2
	C = No visible injury but complaint of pain or momentary unconsciousness	C - 1
	Blank = No documentation of driver or occupants on front of PAR	O - 0
	= No set unknown code	- 9
Missouri	A = Fatal	K - 4
	B = Disabling	A - 3
	C = Evident (not disabling)	B - 2
	D = Probable-not apparent	C - 1
	E = None apparent	O - 0
	F = Unknown	U - 9

Variable Name: Police Reported Accident Severity (cont'd.)

State	PAR Code/Definition			NASS Scheme/Code
Nebraska	4 = Fatal			K - 4
	3 = Incapacitating injury			A - 3
	2 = Nonincapacitating injury			B - 2
	1 = Possible injury			C - 1
	0 = No injury			O - 0
	blank = Occupant present			O - 0
	blank = Occupant not present			- 9
New Jersey	Location of Injury	Type of Injury	Victim's Condition	
	Any entry	Any entry	Killed	K - 4
	Any entry	Any entry	Incapacitated	A - 3
	Any entry	amputation, concussion, internal, fracture/dislocation	Moderate injury Complaint of pain	A - 3
	Eye	burn, bleeding, complaint of pain	Moderate injury Complaint of pain	A - 3
	Any entry	bleeding, contusion, bruise, abrasion	Moderate injury Complaint of pain	B - 2
	Any entry (except eye)	complaint of pain	Complaint of pain	C - 1
	-	-	-	O - 0
	U	U	U	- 9
	New York	Location of Injury	Type of Complaint	Victim's Status
Any entry		Any entry	Apparent death	K - 4
Any entry		Any entry	Unconscious, Semi-conscious, Incoherent	A - 3
Any entry		amputation, concussion, internal, severe bleeding, severe burn, moderate burn, fracture - dislocation	Shock, Normal	A - 3
Eye		minor bleeding, minor burn, complaint of pain	Shock, Normal	A - 3
All but eye		minor bleeding, minor burn	Shock, Normal	B - 2
Any entry		contusions-bruise, abrasion	Shock, Normal	B - 2
All but eye		complaint of pain	Shock, Normal	C - 1
-		-	-	O - 0
X		X	X	- 9

ACCIDENT FORM

A15
(6)

Variable Name: Police Reported Accident Severity (cont'd.)

State	PAR Code/Definition	NASS Scheme/Code
Pennsylvania	0 = No injury	O - 0
	1 = Death	K - 4
	2 = Major injury	A - 3
	3 = Moderate injury	B - 2
	4 = Minor injury [and] Type of Apparent Injury	
	- amputation	
	- bleeding	
	- broken bone(s)	B - 2
	- burns	
	- concussion	
- abrasions/bruises		
- other		
4 = Minor injury [and] Type of Apparent Injury		
- shock	C - 1	
- dizziness		
- complaint of pain		
Rhode Island	1 = Fatal injury at scene	K - 4
	2 = Visible signs of injury - bleeding or broken bones	A - 3
	3 = Other visible injury - bruises or abrasions	B - 2
	4 = No visible injury, but complaints of pain	C - 1
	Blank = No injury	O - 0
South Dakota	0 = No injury	O - 0
	1 = Fatal	K - 4
	2 = Incapacitating injury	A - 3
	3 = Nonincapacitating injury	B - 2
	4 = Possible injury	C - 1
Tennessee	4 = Dead at time of report	K - 4
	3 = Bleeding wound, distorted member	A - 3
	2 = Bruises, abrasions, swelling, limping, etc.	B - 2
	1 = Complaint of pain, no visible injury	C - 1
	Blank = No documentation of driver or occupants on front of PAR or on supplement	O - 0

ACCIDENT FORM

A15

(7)

Variable Name: Police Reported Accident Severity (cont'd.)

State	PAR Code/Definition	NASS: Scheme/Code
Washington	1 = No injury	O - 0
	2 = Dead at scene	K - 4
	3 = Dead on arrival	K - 4
	4 = Died in hospital	K - 4
	5 = Disabling injury	A - 3
	6 = Nondisabling injury	B - 2
	7 = Possible injury	C - 1
	blank = Unknown	- 9

As a general rule, if the PAR is "blank" where the injury severity is accessed and the person was at the scene during the police investigation, code "0" (No injury). If the PAR is "blank" and the person was not present during the police investigation, code "9" (Unknown).

ACCIDENT FORM

A16

Variable Name: Hit and Run

Format: 1 column - numeric

Beginning
Column 32

Element Values:

- 0 No hit-and-run
- 1 Hit motor vehicle (in transport)
- 2 Hit pedestrian or nonmotorist
- 3 Hit parked vehicle or object

Source: Primary source is the police report; the investigator can determine if the police report contains an omission or a commission and modify accordingly.

Remarks:

A hit-and-run may occur when a motor vehicle in transport has contact with: (a) another motor vehicle in transport, (b) a motor vehicle not in transport, (c) a motor vehicle not in transport which contains a nonmotorist, (d) a pedestrian, (e) pedalcyclist, (f) another nonmotorist, or (g) an object. Hit-and-run is only considered when a motor vehicle in transport, or its driver, departs from the scene; therefore, fleeing pedestrians and motor vehicles not in transport are excluded.

It does not matter whether the hit-and-run vehicle was striking or struck. The hit-and-run vehicle(s) is (are) the one(s) that departed prior to investigation by the police, or that vehicle which is abandoned at the scene when its occupant(s) fled from the area (see exceptions below). If the police report indicates that the vehicle was involved in a collision which was investigated, but there is little or no information on that vehicle because of its departure prior to police arrival on-scene, then "hit-and-run" should be indicated.

Exceptions to this "departed prior to investigation by the police" rule exist. One exception occurs if an occupant, or occupants, of a vehicle are taken, or go, directly from the scene to a medical treatment facility or physician. If doubt exists concerning the departure for treatment, assume hit-and-run. A second exception involves a driver who leaves the scene but furnishes name, address, vehicle make, model, and model year such that it is recorded on the PAR, and the PAR does not indicate hit-and-run. No hit-and-run (code "0") is to be coded in this instance independent of the truthfulness of the information provided. A third exception involves vehicles which set an object in motion such that (1) the object is contacted by another motor vehicle in transport before it stabilizes, and (2) the vehicle which set the object in motion leaves the scene without providing the pertinent information (compare with exception two above), and (3) the PAR does not indicate hit-and-run. In this instance code "0" (No hit-and-run) is to be

ACCIDENT FORM

A16
2)

Variable Name: Hit & Run (cont'd.)

used; however, if the PAR had indicated hit-and-run, then code "3" (Hit parked vehicle or object) should be used.

For sampling purposes (A02, Case Number--Stratification and A08, Final Stratification), if the type of vehicle is unknown (V14, Body Type, equals 99), then assume that the hit-and-run vehicle was an "other motor vehicle". If it is known from the police report that the vehicle is a light truck, medium or heavy truck, or motorcycle, then treat it accordingly for sampling.

Code "1" [Hit motor vehicle (in transport)] when a vehicle contacts another motor vehicle in transport and subsequently departs the scene. It makes no difference if the departing vehicle was at-fault. For this code to apply, at least two "in transport" motor vehicles must have been involved in the accident. Consider the following example situations; in each situation code "1" [Hit motor vehicle (in transport)] should be used.

Situation A: The last contacted vehicle in a rear-end collision sustains minor damage and departs.

Situation B: Vehicle 1 strikes vehicle 2, causing vehicle 2 to cross the center line and be struck by vehicle 3. Vehicle 3 departs.

Situation C: Vehicle 2 crosses the path of vehicle 1 and is struck. Vehicle 2 departs.

Situation D: Same as Situation B except that vehicle 1 departs.

Code "2" (Hit pedestrian or nonmotorist) when the hit-and-run vehicle contacts a pedestrian, pedalcyclist, motor vehicle not in transport which contains a nonmotorist, or another nonmotorist.

Code "3" (Hit parked vehicle or object) is used when contact occurs with: (1) an object (fixed or nonfixed), (2) a motor vehicle not in motion and off the roadway, or (3) a motor vehicle in motion and off the trafficway.

Where more than one category can be chosen (codes "1", "2", or "3"), record the category of lower numerical value.

When the presence of a hit-and-run vehicle is indicated (A16 equals codes "1"- "3"), the NASS investigator should include Vehicle and Driver Forms for each such vehicle. If the vehicle was known or assumed to have been in transport at the time of the accident, at least one Occupant Form should be completed. If it can be determined from a reliable source that a vehicle contained "x" number of occupants or nonmotorists (departed scene but was not in transport at time of impact) at the time of its involvement, then submit the appropriate number of forms (Occupant or Pedestrian and Nonmotorist). Although most of the variables on the forms will have element values which are unknown, the forms are necessary to document the presence of the vehicle(s) and its person(s).

ACCIDENT FORM

A16

(3)

Variable Name: Hit & Run (cont'd.)

Hit-and-run (codes "1" through "3") can also be used if it is alleged by one of the involved parties that another vehicle, not reported by the police, was involved in the accident. However, the allegation must be supported by statements to this effect from an unbiased witness or from the existing physical evidence. An unsupported claim by one of the parties that a hit-and-run vehicle was involved should be coded as no hit-and-run ("0").

If the PAR indicates the presence of a hit-and-run vehicle, but the NASS investigator learns during the investigation that the allegation of the involvement of a hit-and-run vehicle was fabricated, then any information about the fabricated vehicle can be dropped. Caution must be used in this instance. The dropping of a police-reported vehicle must be based on an interviewee's admission or upon reliable evidence collected. Suspicion of falsehood is not an acceptable justification.

Variable Name: Time

Format: 4 columns - numeric

Beginning
Column 33

Element Values:

Code reported military time of accident.

For example: 1200 - Noon
 2400 - Midnight

9999 Unknown

Source: Police report.

Remarks:

Code to the nearest minute (e.g., 10:19 p.m. = 2219 hours). The time coded is taken from the "accident time" block on the PAR (usually at the top of the first page). If this block is left blank, then 9999 (Unknown) is coded.

If the PAR indicates the accident occurred during some time interval (e.g., 8:00 p.m. to 6:00 a.m., or 8:00 a.m. to 5:00 p.m.), code "9999" (Unknown). However, if the interval was one hour or less, code the midpoint of the interval, e.g., 8:00 p.m. to 9:00 p.m., code "2030".

Variable Name: Light Condition

Format: 1 column - numeric

Beginning
Column 37

Element Values:

- 1 Daylight
- 2 Dark
- 3 Dark, but lighted
- 4 Dawn
- 5 Dusk
- 9 Unknown

Source: Primary source is the police report; secondary sources include driver interviews, other interviewees, and scene inspection.

Remarks:

If element nomenclature differ between the police report and the NASS form, translate the value from the police report into the appropriate NASS value.

If the police report indicates that it was dark only [the PAR having no response to indicate that it was dark, but lighted ("3")], the investigator may select the latter value if it is known that the scene was lighted (at the time) via luminaires or light standards specifically directed at the roadway.

If the police report does not indicate the light conditions (i.e., a failure to check any category), the investigator should select the most representative value when reasonably certain of what it might have been. However, the investigator, as a surrogate for the police in this example, should restrict the selection to "1", "2", or "3". In those cases where the police fail to indicate the condition and the investigator feels it might have been dusk or dawn (both being short, transitory light conditions), the investigator should code "9" (Unknown).

If the police report contains more than one coded, shaded, or checked response for light conditions (e.g., "dark" and "dusk"), then a secondary source of information is to be used. If no other information is available, then code unknown, ("9").

If the police report is in error, code "1", "2", or "3", but do so only when certain of gross error by police.

Variable Name: Atmospheric Condition

Format: 1 column - numeric

Beginning
Column 38

Element Values:

- 1 No adverse atmospheric related driving conditions
- 2 Rain
- 3 Sleet
- 4 Snow
- 5 Fog
- 6 Rain and fog
- 7 Sleet and fog
- 8 Other (e.g., smog, smoke, blowing sand or dust, etc.) (specify)
- 9 Unknown

Source: Primary source is the police report; secondary sources include driver interviews and other interviewees.

Remarks:

If element nomenclature differ between the police report and the NASS form, translate the value from the police report into the appropriate NASS value.

If the police report does not indicate the atmospheric condition (i.e., a failure to check any category), the investigator should select the most representative value when reasonably certain of what it may have been. The investigator will have information regarding the road surface condition (which is different from the atmospheric condition) on the Driver Form, page 4. This may be helpful, but not necessarily sufficient, to select an element value. Additional information may be obtained by asking this as a specific question on the Driver Form, page 2. The investigator should attempt to resolve the differences between drivers, if possible. In those cases where the police fail to indicate the condition, conflict among drivers cannot be resolved, and/or no interview was obtained, the investigator should code "9" (Unknown).

If the police report contains more than one coded, shaded, or checked response for atmospheric conditions, then a secondary source of information is to be used. If no other information is available, then code unknown ("9").

Code "3" (Sleet) includes hail.

Code "8" (Other) should not be used solely because of cloudy or overcast skies. The element values for this variable are oriented toward precipitation, or particle dispersion which may affect the driver's visual ability or the vehicle's controllability.

Variable Name: Land Use

Format: 1 column - numeric

Beginning
Column 39

Element Values:

- 1 Urban
- 2 Rural
- 9 Unknown

Source: FHWA required state maps.

Remarks:

Federal Highway Administration classification obtainable from the State Highway Department must be used. No other classification is available.

Do not use the police report for selecting this element value.

When the area type cannot be determined from the Federal Aid Classification and Functional Classification maps, contact the nearest FHWA office for their assistance. If FHWA is unable to assist, contact the nearest FARS representative since NASS is designed to be compatible with FARS on this issue. Refer problems in obtaining the FHWA classification to Contract Technical Managers (Definition: ANSI D16.1-1976, sections 2.5.1 and 2.5.2, pages 12-13).

Roadway Type
(Land Use, Federal Aid System, Roadway Function Class)

The contacts for determining roadway types have been established and are listed on the following pages. The procedure used to determine these contacts follows, for information purposes only.

Investigators should write or call the respective State contact to obtain copies of their Federal Aid Classification and Functional Classification maps or information in this regard.

WHERE: To determine the roadway type, the contractor must obtain copies of the Federal Aid Classification and Functional Classification maps which are located in the State Highway Departments--usually in their planning section.

HOW: The easiest, and quickest, way to determine the exact location of these maps is to contact the Federal Highway Administration's Division Planning and Research Engineer located in each State. These individuals would know who in the State Highway Departments to contact in order to obtain copies of the Federal Aid Classification and Functional Classification maps or information.

CAUTION: This highway classification is available from individual States only. The coder should not, under any circumstances, attempt to classify a roadway without examining the Federal Aid Classification and Functional Classification maps.

Contacts for Determining Roadway Type
Using Federal Aid/Roadway Functional Classifications

U.S. DOT

Federal Highway Administration
Planning & Research Engineer

State	Federal Highway Administration Planning & Research Engineer	State Contact
Alabama	Mr. Martin F. Kelly Planning & Research Engineer Federal Highway Administration 441 High Street Montgomery, Alabama 36104 FTS No. 534-7377	Mr. John Skinner Asst. Chief Engineer, Planning Alabama Highway Department State Highway Building Montgomery, Alabama 36130 Tel. 205-832-6112
Arizona	Mr. Nathan M. Banks Planning & Research Engineer Federal Highway Administration 3500 N. Central Ave., Suite 201 Phoenix, Arizona 85012 FTS No. 261-2481	Mr. Charles D. Anders Asst. Director, Transportation Planning Division Arizona Dept. of Transportation 206 South 17th Avenue Phoenix, Arizona 85007 Tel. 602-261-7431
Arkansas	Mr. William K. Perry Planning & Research Program Manager Federal Highway Administration Room 3128, Federal Office Building 700 West Capitol Avenue Little Rock, Arkansas 72201 FTS No. 740-5625	Mr. A. E. Johnson, Jr. Assistant Chief Engineer for Planning and Development Arkansas State Highway & Transportation Department P.O. Box 2261 9500 New Benton Highway Little Rock, Arkansas 72203 Tel. 501-569-2248
California	Mr. Michael A. Cook Planning & Research Chief Federal Highway Administration Federal Building P.O. Box 1915 Sacramento, California 95809 FTS No. 448-3246 or 448-3247	Ms. Ann Barkley Chief, Division of Transportation Planning Department of Transportation 1120 "N" Street Sacramento, California 95814 Tel. 916-332-7374
Colorado	Mr. Dallace W. Unger Transportation Planner Federal Highway Administration Bldg. 25, Denver Federal Center P.O. Box 25406 Denver, Colorado 80225 FTS No. 234-4633	Mr. Harvey R. Atchison Director, Division of Transporta- tion Planning State Department of Highways 4201 East Arkansas Avenue Denver, Colorado 80222 Tel. 303-757-9525
Florida	Mr. David P. Van Leuven Planning & Research Engineer Federal Highway Administration 223 W. College Avenue P.O. Box 1079 Tallahassee, Florida 32302 Tel. 904-224-8111	Mr. E. W. Elliott Director, Division of Transporta- tion Planning Florida Dept. of Transportation Haydon Burns Building 605 Suwannee Street Tallahassee, Florida 32301 T l. 904-488-3329

U.S. DOT
Federal Highway Administration
Planning & Research Engineer

Stat		State Contact
Illinois	Mr. H. Richards McLane Planning & Research Engineer Federal Highway Administration 320 West Washington Street Springfield, Illinois 62701 FTS No. 955-4636 or 955-4637	Mr. James P. Pitz Director, Office of Planning and Programing Illinois Dept. of Transportation Administration Building 2300 S. Dirksen Parkway Springfield, Illinois 62764 Tel. 217-782-2632
Indiana	Mr. Charles E. Basner Planning & Research Engineer Federal Highway Administration Federal Office Building 575 N. Pennsylvania Street Indianapolis, Indiana 46204 FTS No. 331-7487	Mr. E. Wayne Walters Deputy Director, Highway Development Indiana Department of Highways State Office Building 100 North Senate Avenue Indianapolis, Indiana 46204 Tel. 317-232-5535
Iowa	Mr. Edward J. Finn Planning & Research Engineer Federal Highway Administration 105 6th Street P.O. Box 627 Ames, Iowa 50010 FTS No. 862-8535	Mr. Ian MacGillivray Director, Planning and Research Division Iowa Department of Transportation 826 Lincoln Way Ames, Iowa 50010 Tel. 515-296-1660
Louisiana	Mr. Ed J. Foreman Planning & Research Program Manager Federal Highway Administration P.O. Box 3929 Baton Rouge, Louisiana 70821 FTS No. 687-0400 or 687-0394	Mr. Lacey A. Glascock Traffic and Director, Planning Division Department of Transportation and Development Office of Highways Capital Station P.O. Box 44245 Baton Rouge, Louisiana 70804 Tel. 504-342-7627 12v
Maryland	Mr. Marvin M. Ytkin Planning & Research Engineer Federal Highway Administration The Rotunda, Suite 220 711 West 40th Street Baltimore, Maryland 21211 FTS No. 922-4311	Mr. Clyde Pyers Director, Office of Transportation Planning Maryland Dept. of Transportation P.O. Box 8755 Baltimore-Washington Int'l. Airport Baltimore, Maryland 21240 Tel. 301-787-7333
Massachusetts	Mr. Phillip Robinson Transportation Planner Federal Highway Administration Transportation Systems Center 55 Broadway, 10th Floor Cambridge, Massachusetts 02142 FTS No. 837-2253 or 837-2255	Mr. James F. O'Halloran Acting Director, Bureau of Transportation Planning and Development Massachusetts Dept. of Public Works 100 Works Nashua Street Boston, Massachusetts 02114 Tel. 617-727-5120

U.S. DOT
Federal Highway Administration
Planning & Research Engineer

State	Planning & Research Engineer	State Contact
Michigan	Mr. Harry Krashen Planning & Research Engineer Federal Highway Administration Room 211, Federal Building P.O. Box 10147 Lansing, Michigan 48901 FTS No. 374-1865 or 374-1864	Mr. Sam Cryderman Deputy Director of Transportation Planning Michigan Dept. of Transportation State Highway Building 425 West Ottawa P.O. Box 30050 Lansing, Michigan 48909 Tel. 517-373-2240
Mississippi	Mr. Andrew Jenkins Planning & Research Engineer Federal Highway Administration Suite 105 666 North Street Jackson, Mississippi 39202 FTS No. 490-4232	Mr. Lowell T. Livingston Transportation Planning Engineer, Transportation Planning Division State Highway Department Highway Laboratory Building 412 Woodrow Wilson Avenue P.O. Box 1850 Jackson, Mississippi 39205 Tel. 601-354-7172
Missouri	Mr. Donald A. Sinclair Transportation Planner Federal Highway Administration 209 Adams Street P.O. Box 1787 Jefferson City, Missouri 65102 FTS No. 276-3541	Mr. Carl E. Klamm Division Engineer, Planning Missouri Highway and Transporta- tion Department State Highway Building 119 West Capitol Jefferson City, Missouri 65101 Tel. 314-751-3758
Nebraska	Mr. James J. Pipan Planning & Research Engineer Federal Highway Administration 100 Centennial Mall North Lincoln, Nebraska 68508 FTS No. 541-5521	Mr. C. F. Nutter Deputy State Engineer for Engineering Services Department of Roads P.O. Box 94759 Lincoln, Nebraska 68509 Tel. 402-473-4671
New Jersey	Mr. William Schmitt, Jr. Transportation Planner Federal Highway Administration Suburban Square Building 25 Scotch Road, 2nd Floor Trenton, New Jersey 08628 FTS No. 483-2285	Mr. Alfred H. Harf Acting Director of Transportation Planning and Research Department of Transportation 1035 Parkway Avenue Trenton, New Jersey 08625 Tel. 609-292-3160
New Mexico	Mr. Carl Armbrister Planning & Research Program Manager Federal Highway Administration 117 U.S. Court House Santa Fe, New Mexico 87501 FTS No. 476-6683	Mr. A. W. Gonzales Director, Planning Division New Mexico State Highway Dept. P.O. Box 1149 Santa Fe, New Mexico 87503 Tel. 505-983-0301

U.S. DOT
Federal Highway Administration
Planning & Research Engineer

State		State Contact
New York	Mr. Joseph C. Gardner, Jr. Transportation Planner Federal Highway Administration Leo W. O'Brien Federal Building 9th Floor Albany, New York 12207 FTS No. 562-7517 or 562-4219	Mr. Henry L. Peyrebrune Asst. Commissioner, Office of Public Transportation New York State Department of Transportation 1220 Washington Avenue Albany, New York 12232 Tel. 518-457-2320
North Carolina	Mr. John E. Tidwell, Jr. Planning & Research Engineer Federal Highway Administration 4th Floor, Federal Building 310 New Bern Avenue P.O. Box 26806 Raleigh, North Carolina 27601 FTS No. 672-4272	Mr. T. L. Waters Manager of Planning and Research Department of Transportation and Highway Safety Division of Highways State Highway Building Raleigh, North Carolina 27602 Tel. 919-733-3141
Pennsylvania	Mr. Robert A. Hall Supervisor Community Planner Federal Highway Administration 228 Walnut Street P.O. Box 1086 Harrisburg, Pennsylvania 17108 FTS No. 590-3472	Mr. Harvey Haack Deputy Secretary for Planning Department of Transportation Transportation & Safety Bldg. Forster Street, Room 615A Harrisburg, Pennsylvania 17120 Tel. 717-787-3154
Rhode Island	Mr. David Rosenfield Transportation Planner Federal Highway Administration Federal Building and USPO Exchange Terrace, Suite 250 Providence, Rhode Island 02903 FTS No. 838-4541	Mr. Joseph P. Arruda Chief of Transportation Planning, Division of Planning Department of Transportation State Office Building Smith Street Providence, Rhode Island 02903 Tel. 401-277-2694
South Dakota	Mr. David L. Toillion Transportation Planner Federal Highway Administration Federal Office Building P.O. Box 700 Pierre, South Dakota 57501 FTS No. 782-5241	Mr. Wallace Larsen Director, Division of Administration Department of Transportation Pierre, South Dakota 57501 Tel. 605-773-3265
Tennessee	Mr. Wright B. Aldridge Planning & Research Engineer Federal Highway Administration Federal Building, Room A926 U.S. Court House 801 Broadway Nashville, Tennessee 37203 FTS No. 852-5396	Mr. William C. Wallace Director, Office of Research and Planning Tennessee Dept. of Transportation James K. Polk Building 505 Deaderick Street Nashville, Tennessee 37219 Tel. 615-741-3421

U.S. DOT

Federal Highway Administration

State	Planning & Research Engineer	State Contact
Texas	Mr. Dennis W. Jones Planning & Research Program Manager Federal Highway Administration Room 826, Federal Office Building 300 East Eighth Street Austin, Texas 78701 FTS No. 734-5917	Mr. Phillip L. Wilson State Planning Engineer State Department of Highway & Public Transportation P.O. Box 5051 Austin, Texas 78703 Tel. 512-475-7346
Washington	Mr. Lyle P. Renz Transportation Planner Federal Highway Administration 501 Evergreen Plaza 711 South Capitol Way Olympia, Washington 98501 FTS No. 434-9485 or 434-9552	Mr. Robert S. Nielsen Asst. Secretary, Public Trans. and Planning Washington State Department of Transportation Highway Administration Building Maple Park at Franklin Olympia, Washington 98501 Tel. 206-753-6101
Wisconsin	Mr. Thomas Frank Planning & Research Engineer Federal Highway Administration 4502 Vernon Boulevard P.O. Box 5428 Madison, Wisconsin 53705 FTS No. 364-5973	Mr. Roger L. Schrantz Administrator, Division of Planning and Budget Department of Transportation Hill Farm 4802 Sheboygan Avenue Madison, Wisconsin 53402 Tel. 608-266-6479

Accident Level Versus Traffic Unit Level Environmental Data

There is a conceptual difference between the accident level and the traffic unit level environmental data. The accident level data are intended to represent the environment at the crash scene. In this sense, one can say that the accident level environmental variables represent at-crash data. On the other hand, the traffic unit level environmental variables are intended to provide the most representative description of the roadway environment that the driver (vehicle) had to cross just prior to the first harmful event. In this sense, one can say that the traffic unit level environmental variables represent the environment just prior to crash.

When determining either the accident or traffic unit level environmental data, the point of focus is at the location of the first harmful event. There are two mutually exclusive sets of locations in which the first harmful event can occur. They are: (1) in a junction (within the prolongation of the lines which form the boundary of the intersecting roadways) and (2) not in a junction. Recall that a junction is merely the area formed by the intersection of two roadways. Further, the roadways can be either a highway, road, or street, or one or both of the roadways can be an alley or driveway. In the latter case, there is a special rule for determining the accident level environment in a junction [see 2(a)(3) below]. Alleys and driveways can (in the vast majority of instances) be distinguished from highways, roads, and streets by the fact that the former are not named. Any exceptions to this "named rule" for distinguishing streets or roads from alleys or driveways should be handled on a case-by-case basis.

To determine the environmental variables, the investigator must begin by determining the location of the first harmful event. In the investigator's judgment, based upon review of the police report, scene inspection, participant interviews and, in some instances, vehicle inspection, the location of the first harmful event is either known or it is obscure. Let us deal with the latter situation first.

1. The location of the first harmful event is obscure. The investigator begins with the police report and adjusts the location determination based upon scene data, interviews, etc. However, if these additional sources fail to clarify the location, then the preponderance of the evidence from the police report must be relied upon. The two situations are as follows:

- (a) The police report depicts the accident as occurring in a junction. Upon review of the actual scene you are unsure as to whether or not the first harmful event actually did or did not occur within the prolongation of the lines forming the boundaries of the intersecting roadways; therefore, assume it did occur in a junction and proceed as if it did (i.e., follow the "in-a-junction" rules); or
- (b) The police report depicts the accident as occurring other than in a junction. Upon review of the actual scene you are unsure as to where the

first harmful event actually occurred. Follow the "not-in-a-junction" rules. However, if you do determine from the scene and other evidence that the location of the first harmful event was in a junction, then follow the "in-a-junction" rules.

2. The location of the first harmful event is known. The investigator either follows the rules pertaining to: (a) in-a-junction, or (b) not-in-a-junction to determine the roadway segment or segments for which the environmental variables are reported.

- (a) In-a-junction. First, determine the traffic unit level environmental variables for each in transport vehicle. Go independently to the mouth of the roadway that brought each vehicle into the junction. In the case of a vehicle abandoned in a junction, go to the mouth of the roadway that most likely brought the vehicle into the junction. Verify the identity of each involved roadway. The identity is needed so that each roadway's federal aid and functional classification can be subsequently determined from a map in-office. Collection of each roadway's classification is required so that the accident level comparison (below) can be accomplished. Next, follow the guidelines presented for variable D45 (Number of Travel Lanes) and determine the total number of lanes for each vehicle's roadway (at the mouth). Finally, determine for each of the remaining variables (D46-D49, D51-D59) the values for each vehicle that are most representative of the driver's (vehicle's) environment back along the vehicle's (driver's) path just prior to its involvement in the collision. The phrase "just prior" is purposely left vague since the decision rests with the investigator. However, the distance should only go so far as is needed to include those points of transition which are most representative of the environment. Your judgment will be evaluated on the basis of the reasonableness of your selections.

After completing the traffic unit level environmental variables for each roadway involved, proceed to the accident level environmental variables. Where multiple roadways were involved in the accident's first harmful event, select, according to the following rules, one of the roadways on which a vehicle involved in the first harmful event was travelling just prior to its entrance into the junction:

- (1) Choose the roadway with the higher (lower numerically) Federal Aid System (A21) classification. If the values are the same, then proceed to rule (2). In either case, record the value in variable A21, Federal Aid System.
- (2) Choose the roadway with the greater number of lanes (variable D45). If the number of lanes are the same, then proceed to rule (3).
- (3) Choose the roadway on which the most at-fault driver was travelling, except for alleys and driveways where the street used by the other vehicle is always chosen. (NOTE: This exception applies only to

in-a-junction accidents. If the first harmful event occurred outside the junction and on the driveway or alley, then the not-in-a-junction rules are followed and the driveway or alley is selected at the accident level.)

If all of the in transport vehicles involved in the accident's first harmful event came from the same roadway, then select that roadway. Once you have chosen the roadway, complete the accident level environmental variables (A27-A31, A33-A41) based on the values recorded for that roadway's traffic unit level environmental variables (D45-D49, D51-D59). The values will be nearly identical.

- (b) Not-in-a-junction. [NOTE: An accident whose Relation to Junction (A24) was listed as "intersection related" (code "06") is an example of an accident not in a junction.] Determine the traffic unit level environmental variables for each in transport vehicle before attempting to determine the accident level environmental variables. Since the location of the first harmful event is not in a junction, the investigator must proceed, in accordance with the guidance which follows, to determine both the traffic unit and accident level environmental variables.

If the first harmful event did not occur in a junction, then there are two mutually exclusive locations in which it did occur. These are: (1) off the roadway, or (2) on the roadway.

- (1) Off roadway: For each in transport vehicle involved in the first harmful event, return to the location where the vehicle was last on a roadway. For this determination, "on roadway" means that any part of the vehicle was in contact with the roadway. However, if a vehicle leaves one roadway and enters another roadway other than in the manner that the second roadway was designed to be travelled, ignore the second roadway and return to the location at which the first roadway was last departed. For example: (Situation A) Vehicle leaves roadway X, crosses a field and enters roadway Y. Vehicle crosses roadway Y laterally until it impacts (a) an object (e.g., median barrier), (b) another motor vehicle, or (c) an object on the other side of the roadway. In any of these cases, return to roadway X to record the vehicle's traffic unit level environmental variables. (Situation B) Vehicle leaves roadway X to short-cut traffic ahead. Vehicle, while attempting to merge longitudinally on roadway Y, impacts (a) an object--on or off the roadway, but on the trafficway, or (b) another motor vehicle. In either of these cases, consider the vehicle to be associated with roadway Y.

If a vehicle is in transport on a trafficway but not on a roadway (e.g., motorcyclist riding along on the shoulders or roadside), assign the vehicle to the roadway which best fits the vehicle's direction of travel. Use the point on the chosen roadway nearest the first harmful event.

Once you have determined the location where the vehicle last left the roadway (or each vehicle in the case of an accident involving multiple vehicles which leave their roadway prior to their involvement in the accident), the selection process for the proper values for the traffic unit level environmental variables is the same as for vehicles whose first harmful event was on the roadway. See (2) below for remaining instructions.

If a vehicle departed the roadway from a junction prior to the first harmful event, go to the mouth of the roadway that brought the vehicle into the junction to determine the traffic unit level environmental variables.

- (2) On roadway: Go to the location of the first harmful event [location where the vehicle last left the roadway if it occurred "off roadway" in (1) above]. Determine the number of lanes (D45) for each involved vehicle by selecting the value which provides the most representative description of the driver's roadway leading to this location. Make this determination, and all subsequent traffic unit level environmental determinations (D46-D49, D51-D59), by looking back along the vehicle's path just prior to the impact. The phrase "just prior" is purposely left vague since the decision rests with the investigator. However, the distance should only go so far as is needed to include those points of transition which are most representative of the environment. Your judgment will be evaluated on the basis of the reasonableness of your selections.

For the accident level environmental variables, use a generalized cross-section of the roadway at the location of the first harmful event or the location where the vehicle last left the roadway if it occurred "off roadway". Record Federal Aid System (A21) for the roadway at this location. In addition, determine the appropriate values for each of the remaining accident level environmental variables (A27-A31, A33-A41).

One special rule needs to be considered for the accident level determination. If the location of the first harmful event is one and the same as an area of transition (of any kind: straight-curve, level-grade, wet-dry, concrete-bituminous, etc.) record the transition according to the following rules:

- (01) Choose undivided over divided;
- (02) Choose other divisions over barrier division;
- (03) Choose partial control over full access control;
- (04) Choose no control over partial access controls;
- (05) Choose shoulders over no shoulders;
- (06) Choose two shoulders over one;
- (07) Choose curve over straight;
- (08) Choose grade over level;
- (09) Choose hillcrest or sag over grade;

- (10) Choose other surface types over concrete;
- (11) Choose gravel, dirt, brick or block over bituminous;
- (12) Choose gravel or dirt over brick or block;
- (13) Choose dirt over gravel;
- (14) Choose nondry surface conditions over dry;
- (15) Choose snow or slush over other nondry conditions;
- (16) Choose ice over wet or other conditions; and,
- (17) Choose wet over other conditions.

The location of the first harmful event and the subsequent selection of the accident level environmental variables can occur from a roadway that differs from any roadway on which an in transport vehicle was travelling. In this case the accident and driver level environmental variables may be different. This is true primarily in single vehicle collisions. An example of this occurs when a vehicle is attempting to negotiate a junction, and it impacts an object outside of the junction but on another roadway (different street or different leg of the same street but which has different attributes than the other leg). Further, in the opinion of the investigator, the former roadway is the one most representative of the vehicle's (driver's) environment just prior to the collision. (See next page for examples.) However, there is an exception to this general rule. This exception occurs when the other roadway would not qualify as a NASS roadway if it were not for the "throat" rule (see Variable A24, Relation to Junction, fifth page, paragraphs 5 and 6). In these instances, the accident level environmental variables should be the same as the traffic unit level environmental variables for the involved in transport vehicle.

The accident and traffic unit level variables may also differ where a vehicle was not attempting to negotiate a junction. Recall on sub-page (3) Situation A where a vehicle departed roadway X, prior to its junction with roadway Y, but enters roadway Y laterally before a harmful event occurs. If the vehicle impacts an object or a pedestrian or nonmotorist (see P08, Pedestrian or Nonmotorist's Type) on the road, then use roadway Y for the accident level and roadway X for the traffic unit level. However, if the object or pedestrian or nonmotorist was not impacted until after the vehicle crossed the road for roadway Y, then roadway X would be used at both the accident and traffic unit levels.

For those in transport vehicles not involved in the accident's first harmful event (but involved in the accident), determine the traffic unit level environmental variables for that vehicle from the area preceding the location where that vehicle sustained its initial damage or its occupants were initially injured.

EXAMPLE :

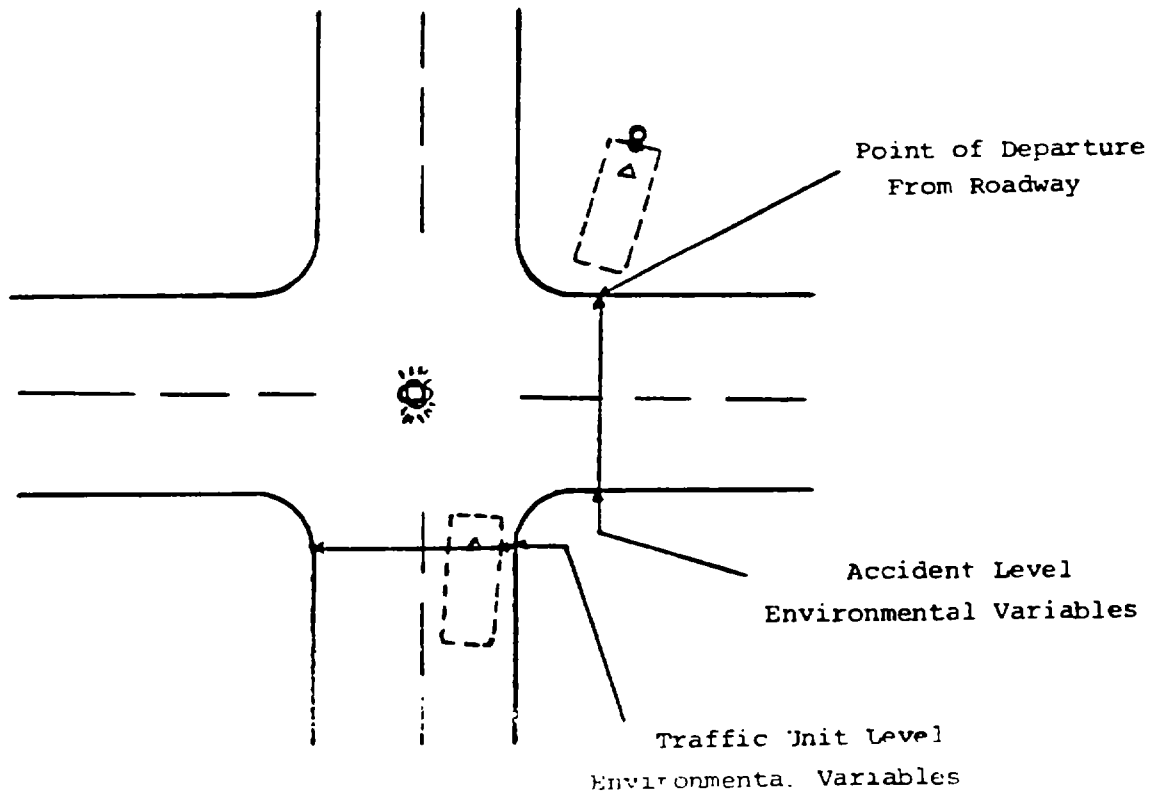
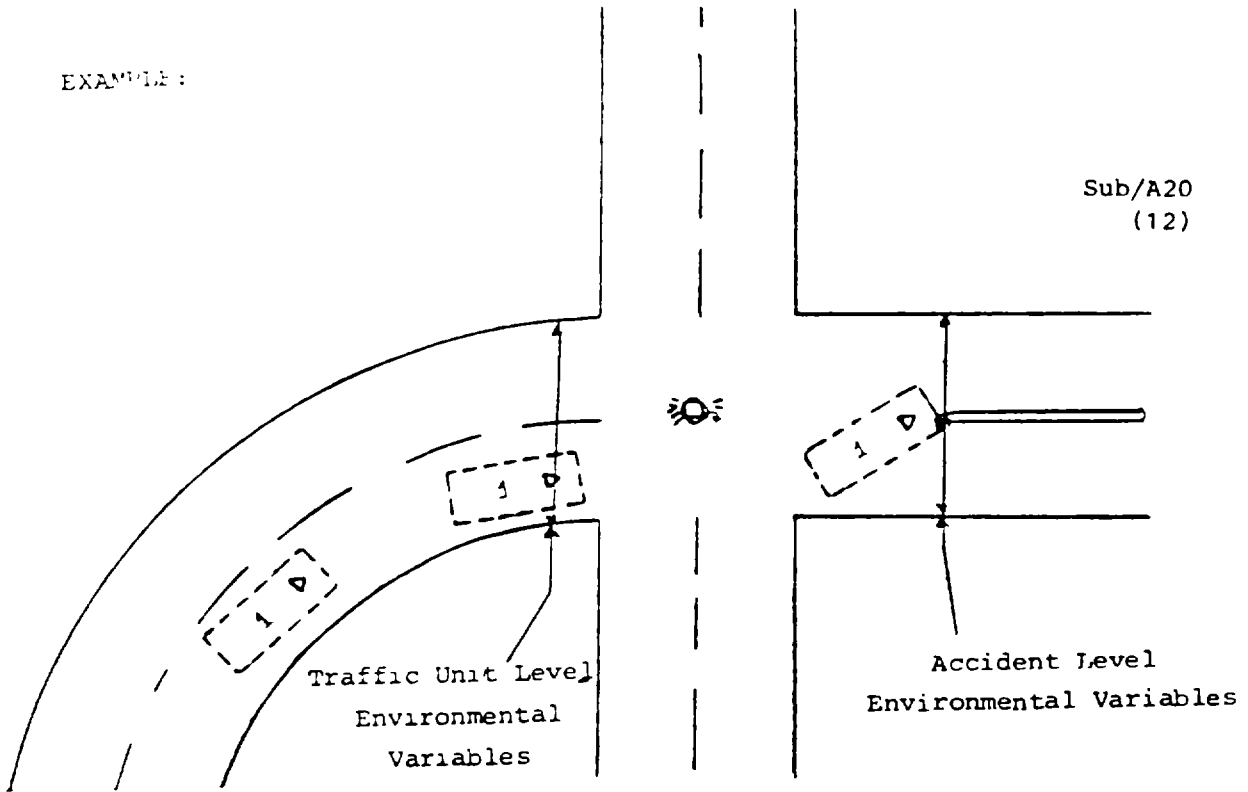

ACCIDENT FORM

A21

Variable Name: Federal Aid System

Format: 1 column - numeric

Beginning
Column 40

Element Values:

- 1 Interstate
- 2 Other federal aid primary
- 3 Federal aid secondary
- 4 Federal aid urban arterial
- 5 Federal aid urban collector
- 6 Nonfederal aid arterial
- 7 Nonfederal aid collector
- 8 Nonfederal aid local
- 9 Unknown

Source: FHWA required state maps.

Remarks:

The Federal Highway Administration classification obtainable from the State Highway Department must be used. No other classification source is available.

Do not use the police report for selecting this element value.

When the road classification cannot be determined from the Federal Aid Classification and Functional Classification maps, contact the nearest FHWA office for their assistance. If FHWA is unable to assist, contact the nearest FARS representative, since NASS is designed to be compatible with FARS on this issue. Refer problems in obtaining the FHWA classification to Contract Technical Managers.

Code "1" (Interstate) for on/off ramps that serve an interstate.

A ramp is defined in variable A24, Relation to Junction. Ramps which do not serve an interstate should be classified according to the highest level (lowest numerical) roadway which they connect.

Frontage roads and collector-distributor roads (see ANSI D16.1-1976, sections 2.5.18 and 2.5.19, page 14) are coded as classified on the maps. Frontage roads not classified on the maps should be coded "8" (Nonfederal aid local).

Code "8" (Nonfederal aid local) includes driveways or alleys when the roadway chosen to be associated with the first harmful event is a driveway or alley.

ACCIDENT FORM

A22

Variable Name: Class Trafficway

Format: 1 column - numeric

Beginning
Column 41

Element Values:

- 1 Interstate
- 2 Other U.S. route
- 3 Other state route
- 4 County road
- 5 Local street
- 8 Other (specify)
- 9 Unknown

Source: Investigator determined--based on definitions and scene inspection. Road signage is one of the primary inputs in the assignment of the correct attribute.

Remarks:

For a roadway to qualify as a NASS roadway in addition to meeting the definitions spelled out in Figure 2-5, page 14 (transport way, land way, trafficway, roadway--ANSI D16.1-1976, sections 2.1.5, 2.1.11, 2.2.1, and 2.2.17 respectively), the Agency (city, county, or state) responsible for maintaining the roadway must designate it at least as "open to local or through traffic". This means that accidents which occur in association with a roadway (or one of its lanes) that is unopen are not NASS accidents unless they occur in the junction of a roadway that is open and upon which an involved vehicle was travelling. If the roadway is being built or under construction (repair or maintenance) then the first harmful event must have been associated with that portion of the roadway designated as open. If the maintenance agency has designated the roadway as open then the condition (paved, gravel, etc.) of the road surface is not considered. If the roadway is being built, code the roadway according to its eventual classification.

If the road is serving as a DETOUR, then disregard temporary signage and code the roadway according to its permanent classification. In a few areas, even interstate roads most closely resemble local streets. If the roadway is permanently signed (at the time of the accident) as an interstate, other U.S. or other state route, then code it accordingly. Where a roadway is part of more than one class (e.g., section contains both state and U.S. signage), code its higher (lower numerically) class. Regarding interstates, white-on-green interstate business loop signs are informational signs and are to be ignored for classification purposes.

ACCIDENT FORM

A22

(2)

Variable Name: Class Trafficway (cont'd.)

Definitions:

Interstate system ("1") is any trafficway within the national system for interstate and defense trafficways.

Other U.S. route ("2"), numbered highway, is any trafficway within the U.S. trafficway system, excluding interstate trafficways.

Other state route ("3"), numbered highway, is any trafficway within the state trafficway system.

County road ("4") is any trafficway within a county trafficway system that does not fall within the interstate, U.S. route, or state route systems.

Local street ("5") is any trafficway within a city trafficway system that does not fall within the interstate, U.S. route, or state route systems.

Other road ("8") includes any alley or driveway.

Variable Name: Roadway Function Class

Format: 1 column - numeric

Beginning
Column 42

Element Values:

- 1 Principal arterial-interstate
- 2 Principal arterial-other urban freeway
or expressway
- 3 Principal arterial-other
- 4 Minor arterial
- 5 Urban collector
- 6 Major rural collector
- 7 Minor rural collector
- 8 Local road or street
- 9 Unknown

Source: FHWA required state maps. Do not use the police report for selecting this element value.

Remarks:

The Federal Highway Administration has established a roadway functional system classification scheme. The Functional Classification maps are obtainable only from the State Highway Department. Use the same contact that was used in obtaining your Federal Aid Classification maps.

FHWA has established a hierarchy of roadway functional systems. The basic functional systems are: (1) rural areas, (2) urbanized areas, and (3) small urban areas (under 50,000 in population). Each system is comprised of various functional categories. The categories are shown below.

<u>Rural Area</u>	<u>Urbanized & Small Urban Area</u>
Principal arterials	Principal arterials
Interstate	Interstate
Other	Other freeways and expressways
	Other
Minor arterial roads	Minor arterial streets
Collector roads	Collector streets
Major	
Minor	
Local roads	Local streets

ACCIDENT FORM

A23

(2)

Variable Name: Roadway Function Class (cont'd.)

One should be able to recognize how the present attributes evolved from these two categorizations.

When the road classification cannot be determined from the functional classification map(s), contact the nearest FHWA office for their assistance. The nearest FARS representative may also be able to assist with problems. Refer problems in obtaining the FHWA classification to your Contract Technical Manager.

Code "1" (Principal arterial-interstate) for on/off ramps that serve an interstate.

A ramp is defined in variable A24, Relation to Junction. Ramps which do not serve an interstate should be classified according to the highest categorial level (lowest numerical) roadway, within the functional system, which they connect. For example, a ramp which connects a local road to a minor arterial road (rural area) would be coded as "4" (Minor arterial).

Frontage roads and collector-distributor roads (see ANSI D16.1-1976, sections 2.5.18 and 2.5.19, page 14) are coded as classified on the maps. Frontage roads not classified on the maps should be coded "8" (Local road or street).

Code "8" (Local road or street) includes driveways or alleys when the roadway chosen to be associated with the first harmful event is a driveway or alley.

Variable Name: Relation to Junction

Format: 2 columns - numeric

Beginning
Column 43

Element Values:

- 01 Non-junction
- 02 Three leg intersection
- 03 Four leg intersection
- 04 More than four leg intersection
- 05 Rotary or traffic circle
- 06 Intersection related
- 07 Channel
- 08 Area of merge/divergence related
- 09 Entrance or exit ramp
- 10 Interchange area
- 11 Driveway, alley access related
- 12 Railroad grade crossing
- 13 Crossover related
- 99 Unknown

Source: Investigator determined--inputs include scene inspection, the police report, definitions, and driver interviews.

Remarks:

The element value selected is based on the location of the first harmful event. If the first harmful event occurs off the roadway, refer to the section at the point of departure to code this variable. In those off-roadway instances where the departure occurs from within a junction, code either "01" (Non-junction) or "06" (Intersection related). The latter code should be used if the junction was also an intersection (see definition below).

Junction is, in general, the area formed by the connection of two roadways. It includes: (1) all at-grade intersections (ANSI D16.1-1976 section 2.5.12, page 14), (2) connections between a driveway access or alley access and a roadway which is not a driveway access or an alley access, (3) connections between two alley accesses or driveway accesses, or (4) a connection between a driveway access and an alley access.

Intersection (codes "02" through "04") is a type of junction which: (1) contains a crossing or connection of two or more roadways not classified as a driveway access or alley access, and (2) is embraced within the prolongation of the lateral curb lines or, if none, the lateral boundary lines of the roadways. Where the distance along a roadway between two areas meeting

Variable Name: Relation to Junction (cont'd.)

these criteria is less than 10 meters (33 feet), the two areas and the roadway connecting them are considered to be parts of a single intersection. The measurement is made from inside-to-inside of the lateral curb/boundary lines. If the lines are not parallel, then the distance between them is measured along the shortest side of the roadway [see examples pages 3-7].

Should the first harmful event occur within the area formed by the prolongation of curb or edge lines of the approach legs of the intersection, it is to be classified as an intersection accident whether or not the collision which occurred was in any way related to the fact of being within an intersection.

Code "02" (Three leg intersection) includes any two leg intersections. To qualify for inclusion at least one of the two legs must be controlled by a regulatory sign (see A38, Traffic Control Device) or traffic signal; otherwise, treat the area as a sharp curve.

A rotary or traffic circle (code "05") is a specialized form of at-grade intersection. It is one through which traffic passes by entering and leaving a one-way roadway connecting all intersection approach legs and running continuously around a central island. Rotary intersections are commonly called traffic circles, but proper design can result in central islands of various rounded shapes. An example of a rotary intersection is shown below.

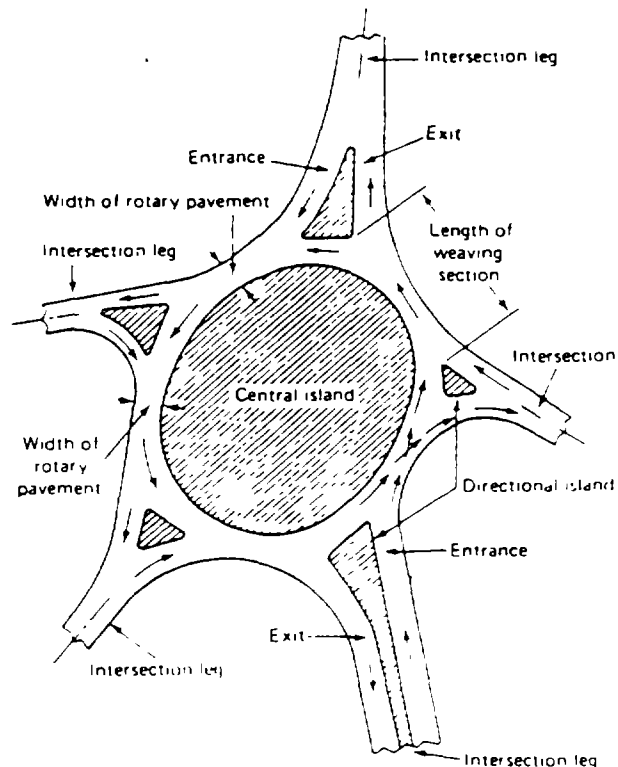

Variable Name: Relation to Junction (cont'd.)

Code "05" (Rotary or traffic circle) if the first harmful event occurs in the rotary roadway, in the central island, or on any directional islands which serve the rotary intersection.

3-Leq Intersections

The following examples, although not intended to be inclusive, are presented for the purpose of helping to clarify the meaning of "prolongation" as it is used with respect to junctions.

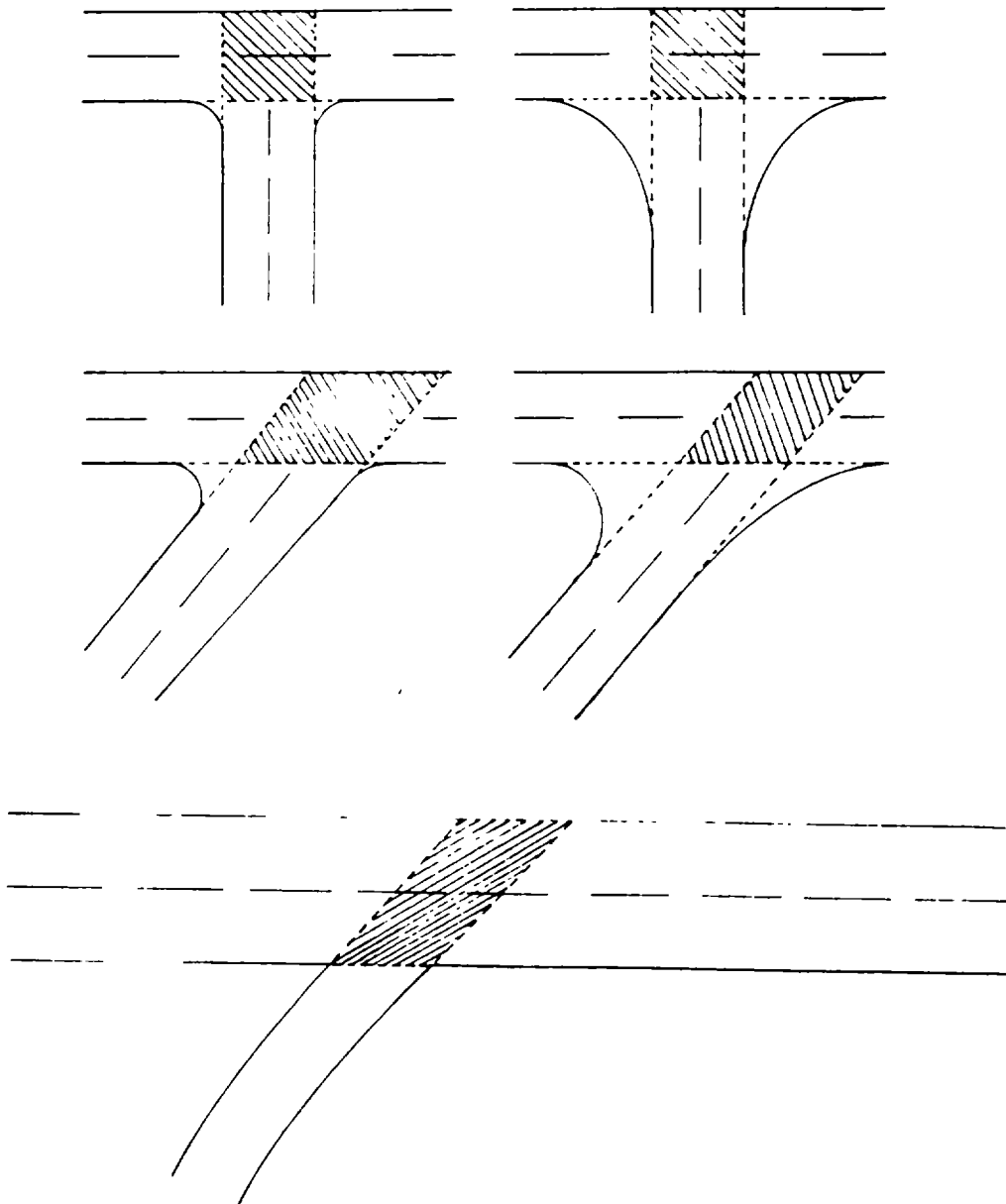

Variable Name: Relation to Junction (cont'd.)

The next example illustrates prolongation in the case of a diverging "Y" type (three leg) intersection (code "02"). Find the location along the Y's stem where the prolongation from the divergence is farthest from the apex. If the distance from the apex to a line perpendicular to the lateral boundary lines of the stem at the farthest point is greater than or equal to 16 meters (50 feet), then consider the first shaded area (vertical hash marks in the example) as the intersection. If the distance is less than 16 meters (50 feet), then add an additional 10 meters (33 feet)--second shaded area (diagonal hash marks in the example)--to the distance and consider both shaded areas as the intersection.

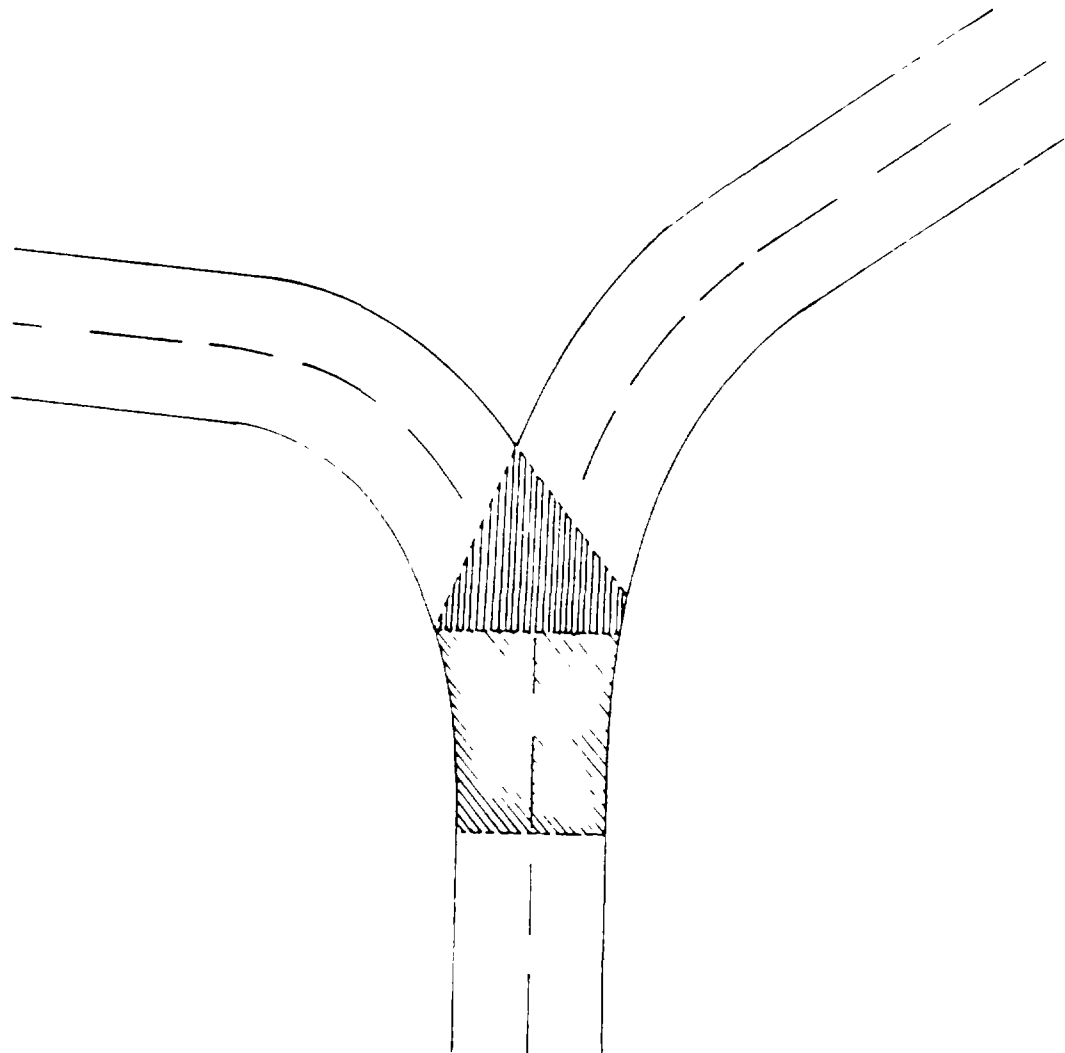

Variable Name: Relation to Junction (cont'd.)

Four-leg Intersections

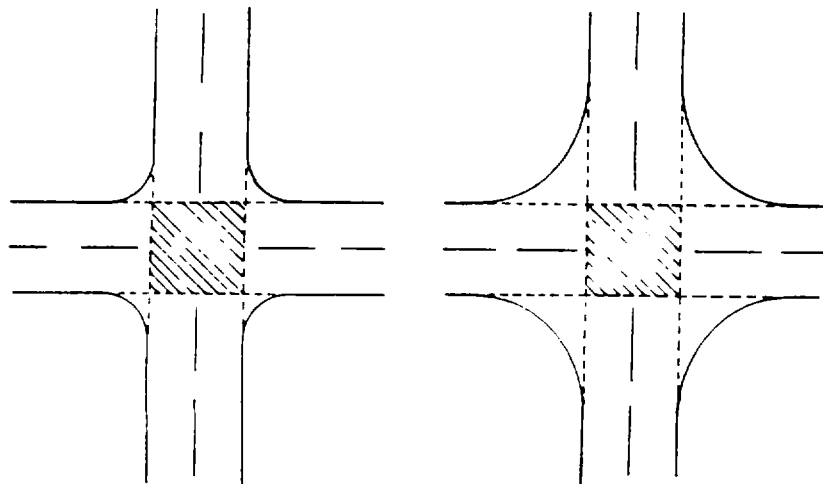
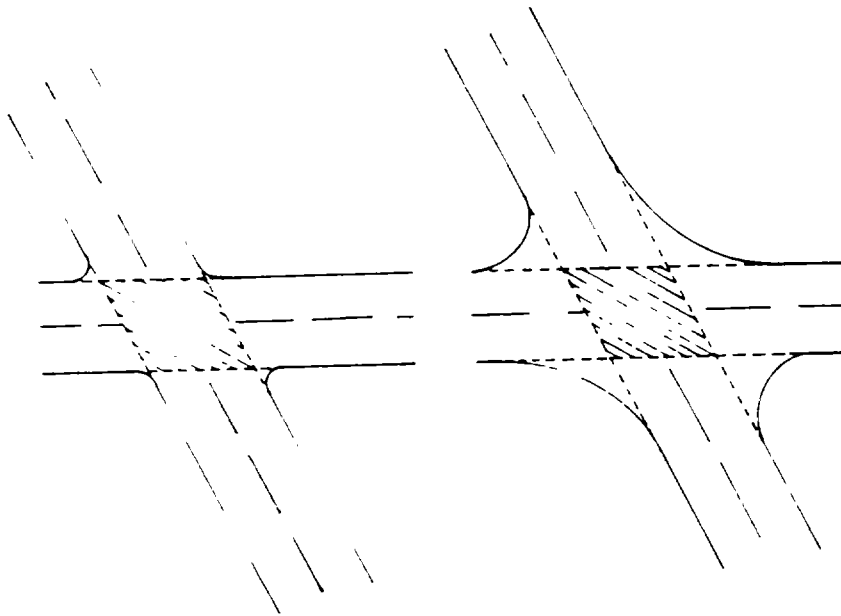

Variable Name: Relation to Junction (cont'd.)

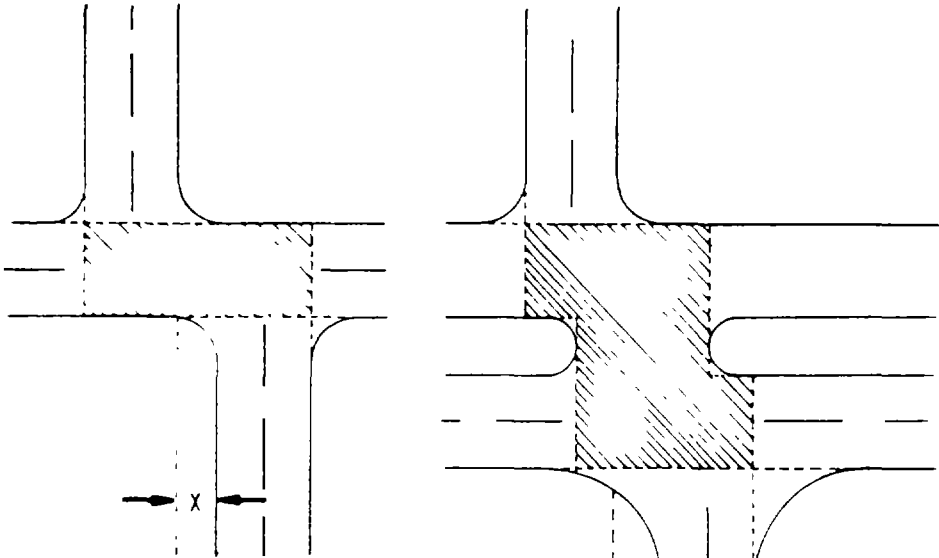

WHERE X IS LESS THAN OR EQUAL TO 10 METERS

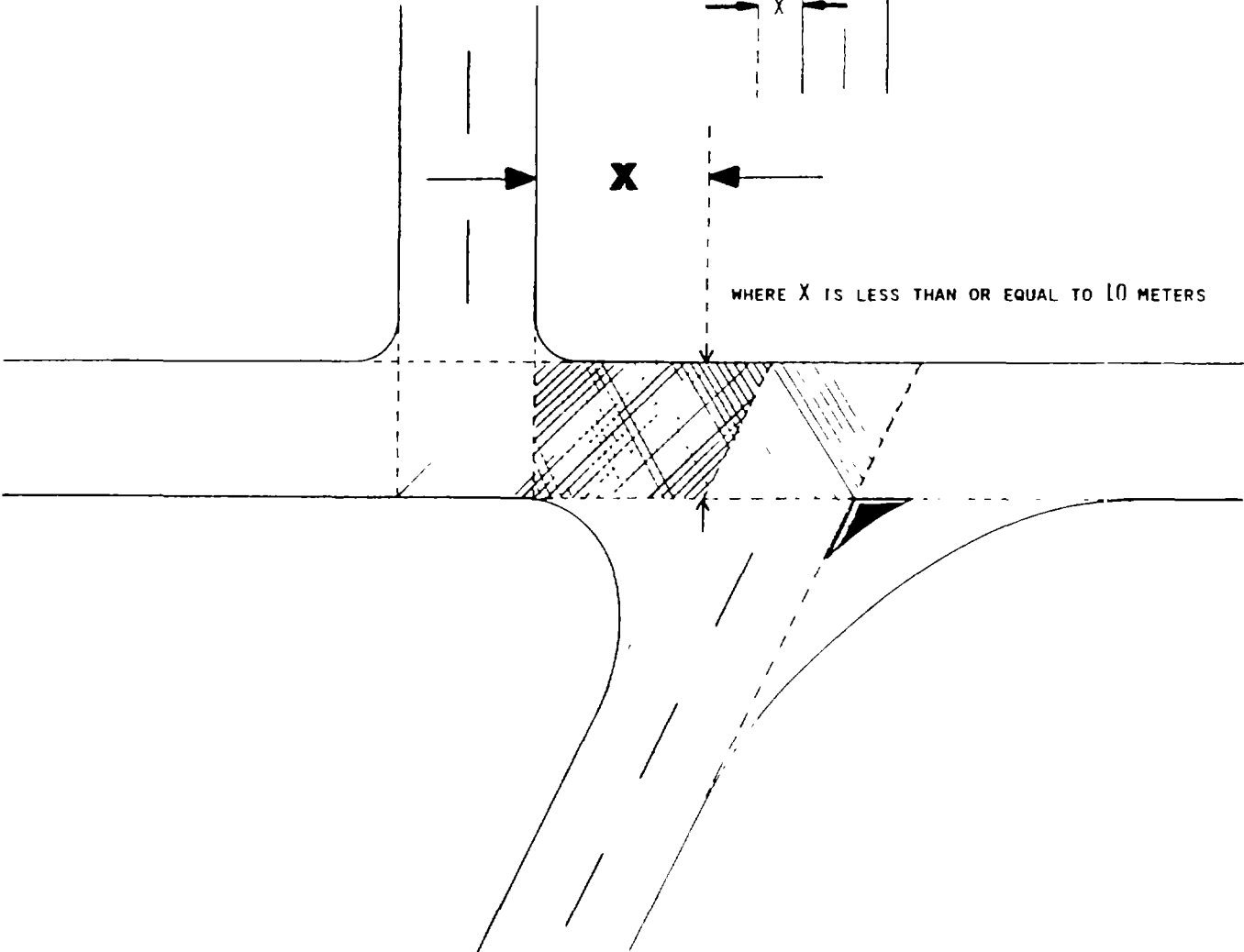

WHERE X IS LESS THAN OR EQUAL TO 10 METERS

Variable Name: Relation to Junction (cont'd.)

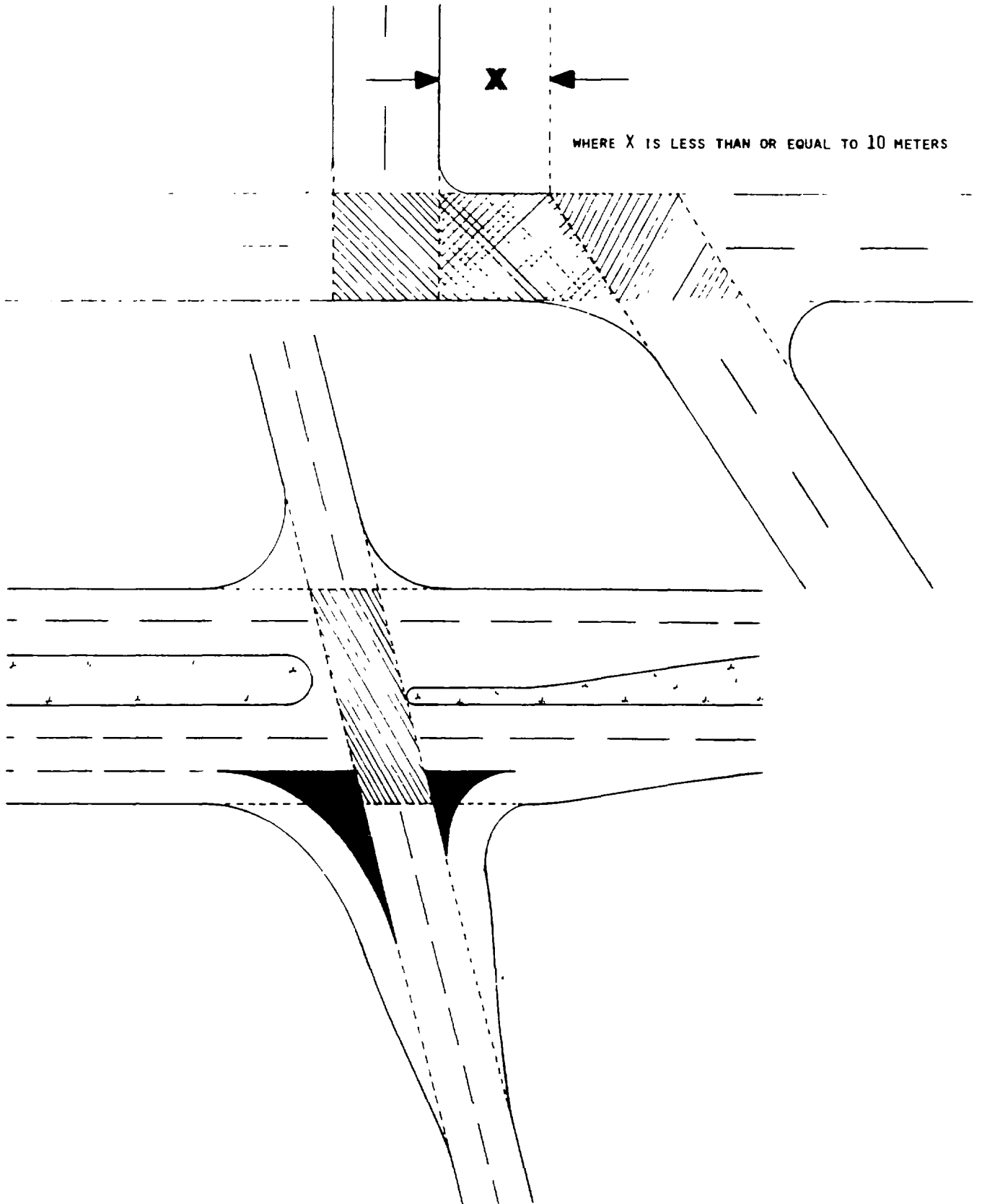

Variable Name: Relation to Junction (cont'd.)

Intersection related (code "06") means that the first harmful event (A10, First Harmful Event): (1) occurs on an approach to or exit from an intersection; and (2) results from an activity, behavior, or control related to the movement of traffic units through the intersection (for "traffic unit" see ANSI D16.1-1976, sections 2.2.26, 2.2.6, 2.1.8, and 2.1.4)

"Traffic units" above means any traffic unit (involved or not involved in the accident). If the first harmful event occurs outside but near an intersection and involves a vehicle which was engaged or should have been engaged in making a intersection related maneuver such as turning, then intersection related (code "06") must be coded. However, if the loss of control is unrelated to the intersection, then code non-junction ("01"). See examples, pages 17 - 19.

If an accident meets the criteria of intersection related ("06") but also meets the criteria for codes "07" through "13", then the appropriate code ("07" through "13") takes precedence. Remember, for codes "08" (Area of merge/divergence related), "11" (Driveway, alley access related), and "13" (Crossover related) to apply, a pedestrian, other nonmotorist associated with a nonmotorist conveyance, or road vehicle (ANSI D16.1-1976, section 2.2.6, page 5) must have been entering or exiting the appropriate area.

A channel (code "07") refers to any traffic lane that is directed into a path different than the through lanes by a traffic island. An island is defined as a raised or painted paved surface. The channel begins and ends at the extension of the island's lateral boundaries unless the channel is preceded or followed by an area of merge or divergence (see below). The diagrams below show examples of a channel.

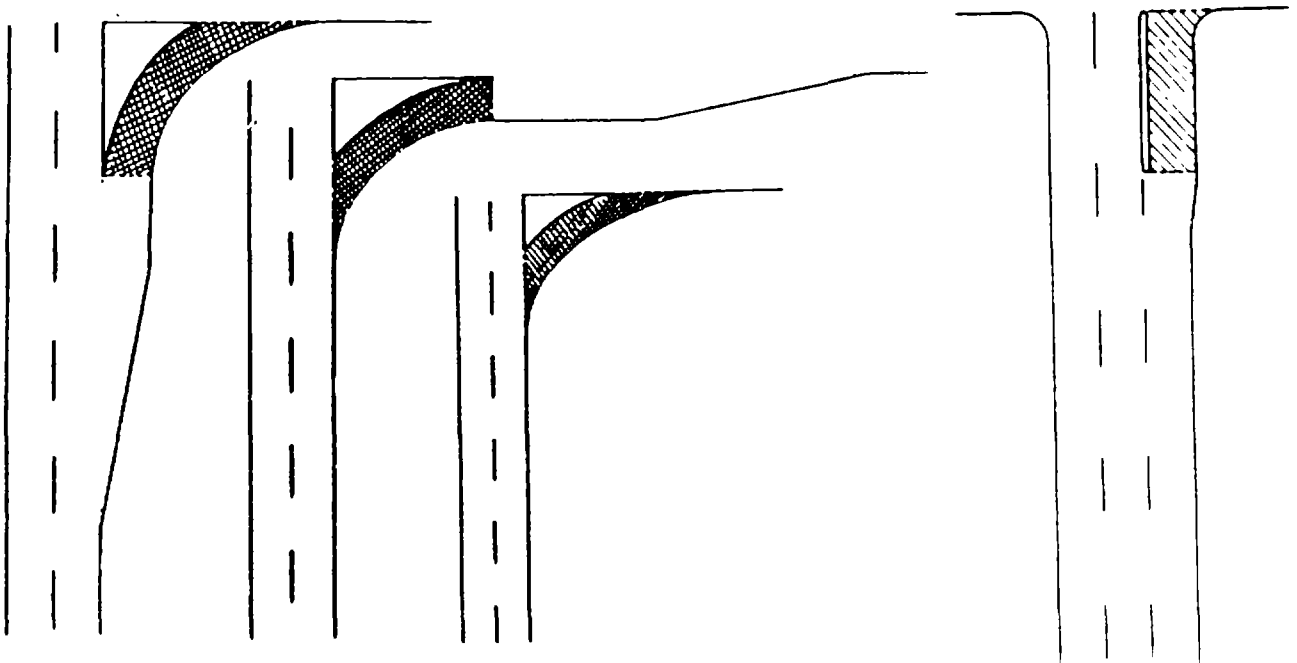

Variable Name: Relation to Junction (cont'd.)

Code "07" (Channel) if the first harmful event occurs in the channel or on the traffic island (if the vehicle enters or strikes the island from within the channel). See Code "09" (Entrance or exit ramp) for difference between code "07" channel and "09" (Entrance or exit ramp).

Code "08" (Area of merge/divergence related) refers to the area in and adjacent to an auxiliary lane which is (1) adjacent to the through lane(s) and (2) precedes (divergence) or follows (merge) a ramp (entrance or exit --at grade or not at grade) or channel. A divergence area extends longitudinally from where the auxiliary lane begins and ends where the ramp (see below) or channel (see above) begins. A merge area extends longitudinally from where the ramp or channel ends and ends where the auxiliary lane ends. Both areas extend laterally across the through lane(s), for traffic in the same direction, ending at a center line, median, or road edge/curb. In order to use this code at least one involved pedestrian, other nonmotorist associated with a nonmotorist conveyance (see variable P08, Pedestrian or Nonmotorist Type), or road vehicle (ANSI D16.1-1976, section 2.2.6, page 5), involved in the first harmful event, must be entering or exiting from the ramp or channel. Do not use this code if the accident was precipitated by the actions of a noncontact road vehicle or person.

If the location of the first harmful event (A10) meets the criteria for area of merge/divergence related (code "08") and also meets the criteria for an intersection (codes "02" through "04"), intersection related (code "06") or an interchange area (code "10"), then code "08" (Area of merge/divergence related) takes precedence.

Sketched below is an example of the prolongation associated with an area of merge or divergence.

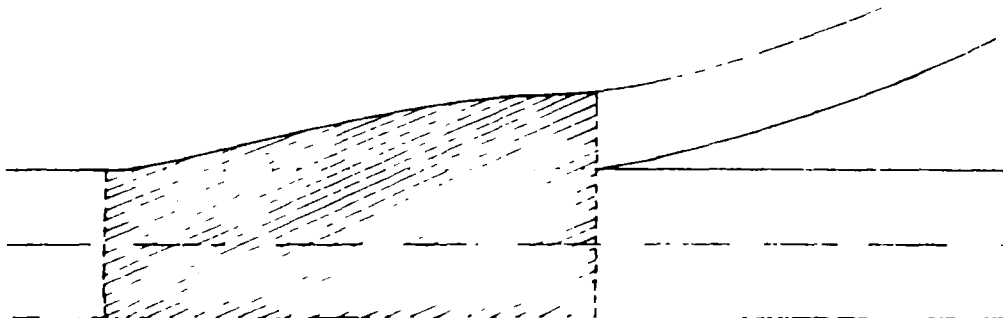

Variable Name: Relation to Junction (cont'd.)

An entrance or exit ramp (code "09") is a transition roadway: (1) which connects two roadways, (2) is used for entering or leaving through-traffic lanes, and (3) begins and ends at a gore or curb return. The widening of the roadway, where present, which allows one to diverge from or merge onto the through-traffic lanes is to be considered (1) as an additional lane associated with the connected roadway and (2) as an area of merge or divergence as discussed previously. A ramp can connect two roadways which cross (either at-grade or with a grade separation) or two which do not cross (e.g., frontage roads). A ramp can form an intersection with a roadway as well as diverge from or merge into one. A ramp can form a channelized intersection. A ramp can also split into two ramps.

If the first harmful event occurs while going into, within, or coming out of a channel, then code the Relation to Junction as intersection (codes "02" through "05"--rare), non-junction ("01"), channel ("07"), area of merge/divergence related ("08"), or intersection related ("06"), depending upon whether or not the intersection related criteria are met. On the other hand, if the first harmful event occurs in an entrance or exit ramp, then code "09" (Entrance or exit ramp) regardless of whether or not the first harmful event resulted from some action that would qualify as intersection related (code "06").

Some at-grade intersections are channelized; some at-grade intersections have ramps. A channel can be distinguished from a ramp (for an at-grade intersection) according to the following criteria (see accompanying figure). Measure the X and Y distances at the island. To be a ramp (code "09") the larger of X or Y must be greater than 16 meters (50 feet) and the smaller of X or Y must not be less than or equal to 10 meters (33 feet). Otherwise, the configuration constitutes a channel. A careful review of the table which accompanies the figure is in order.

Variable Name: Relation to Junction (cont'd.)

Relation to Junction	Channel	Ramp
Non-junction or Intersection related	B C	B C
Three leg or Four leg intersection--two streets	A	A
Three leg intersection--street and a ramp		F
Intersection related	F	
Channel	E	
Area of merge/divergence	D	D
Entrance or exit ramp		E

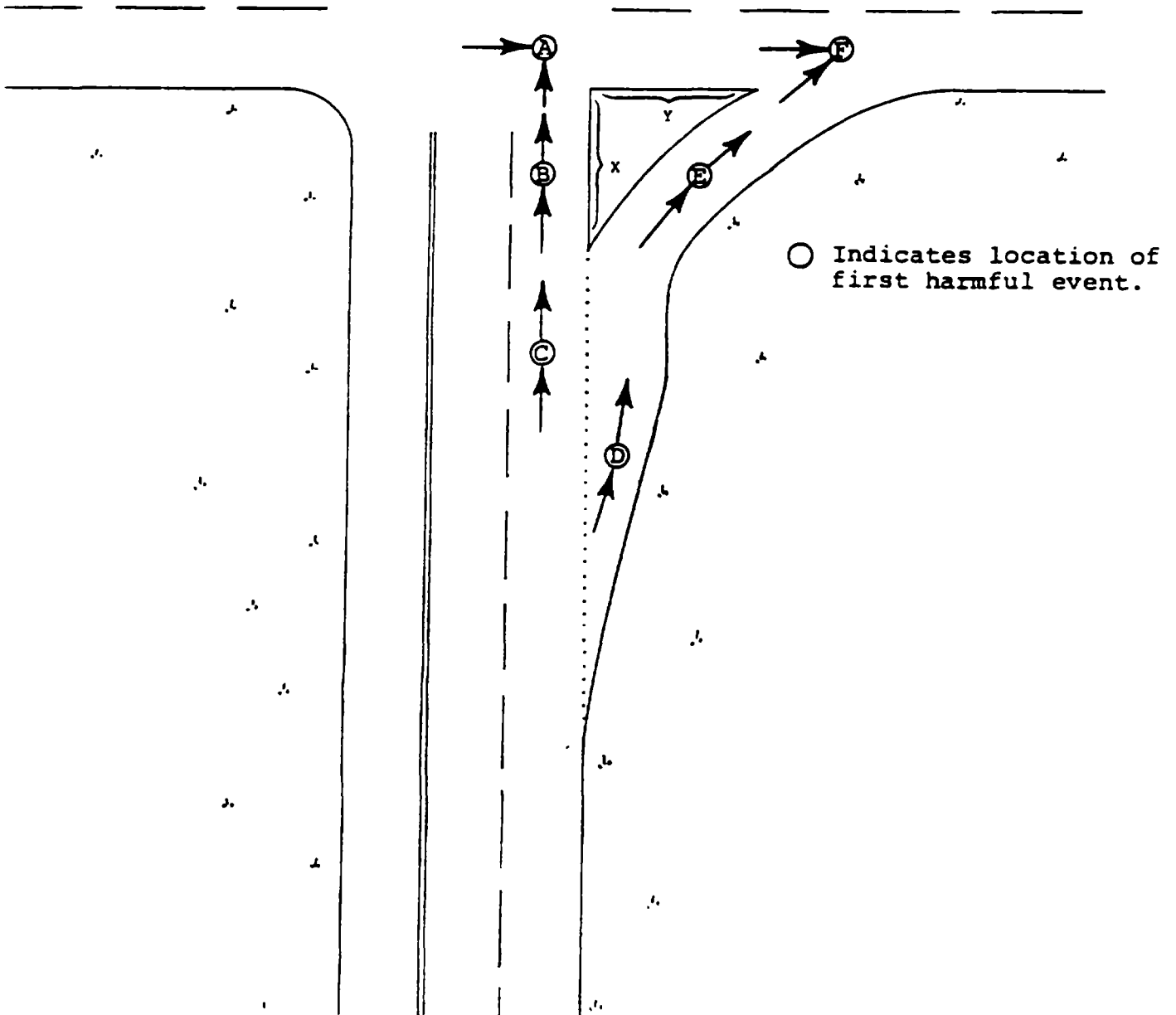

Variable Name: Relation to Junction (cont'd.)

An interchange area ("10") is the area around a grade separation (ANSI D16.1-1976, section 2.5.14, page 14) which involves at least two trafficways which are directly connected. Included within its boundaries are: (1) all ramps which connect the roadways, and (2) each roadway entering or leaving the interchange to a point 30 meters (100 feet) beyond the gore or curb return at the outermost ramp connection for the roadway. One may find included within an interchange area intersections, channels, areas of merge/diverge, ramps, driveway accesses, and, of course, roadway sections which are non-junction.

If the location of the First Harmful Event (A10) is in an interchange area and also is in an intersection, a channel, an area of merge/diverge, or on an entrance or exit ramp, then the intersection (codes "02) through "04"), channel ("07"), area of merge/diverge ("08"), or ramp ("09") takes precedence.

If a grade separation is present and the first harmful event occurs in and incidental to the junction of a ramp and a highway, then code interchange area ("10"). If the first harmful event meets the criteria of intersection related, interchange area ("10") is still used since it takes precedence.

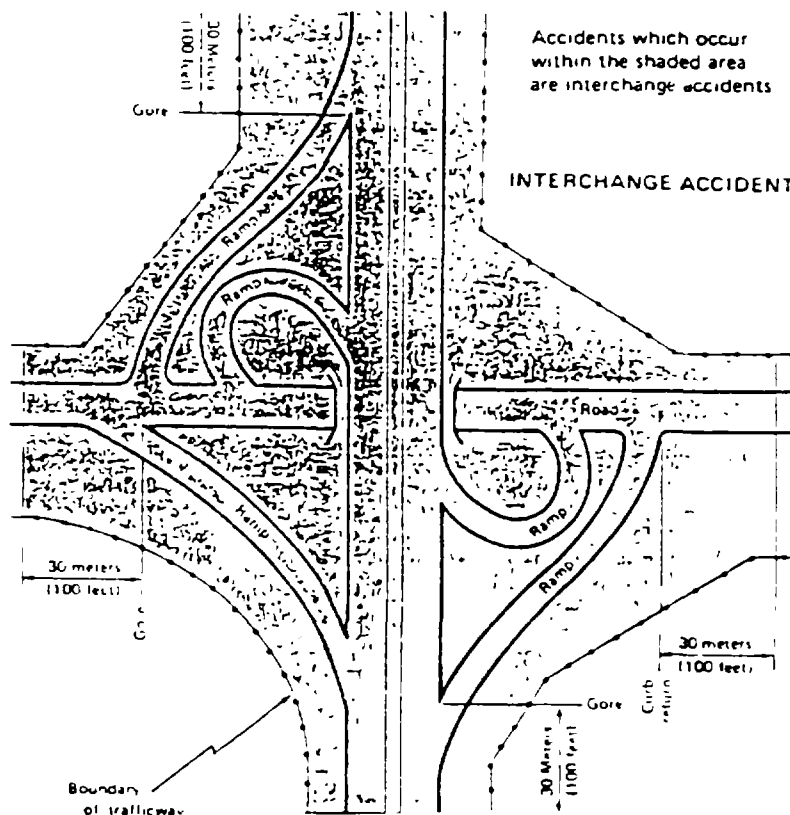

ACCIDENT FORM

A24
(13)

Variable Name: Relation to Junction (cont'd.)

Code "11" (Driveway, alley access related) is used when at least one traffic unit which may be an involved pedestrian, other nonmotorist associated with a nonmotorist conveyance (see variable P08, Pedestrian or Nonmotorist's Type), or road vehicle (ANSI D16.1-1976, section 2.2.6, page 5) was entering or exiting from the driveway or alley. Do not use this code if the accident was precipitated by the actions of a noncontact road vehicle or person.

Where a controlled driveway/alley access junction overlaps (inside-to-inside of lateral boundary lines is less than or equal to 10 meters) a three leg intersection, code "03" (Four leg intersection) should be used.

When an uncontrolled driveway/alley access junction is also within the prolongation of a three leg intersection (code "02") and the accident would meet the criteria of driveway, alley access related (code "11"), code either "02" (Three leg intersection) if the first harmful event was within the intersection junction, or "06" (Intersection related) if it was not.

For an uncontrolled driveway/alley access junction within ten (10) meters (33 feet) of a three or four leg intersection (inside-to-inside of lateral boundary lines), code "11" (Driveway, alley access related) only if the criteria above are met and the location of the first harmful event is not within the intersection. Driveway access (code "11") is a roadway providing access to property adjacent to a trafficway. Alley access (code "11") is an unnamed roadway providing access, in general, to the rear of houses or buildings, some of which may be further served by a driveway access.

Most driveways (but not all) are not roadways in NASS. Examples of non-NASS roadways are: driveways to service stations, residential dwellings, and most apartment complexes, hotels, motels, and other commercial establishments. There are two instances where driveways, which otherwise would not qualify as a NASS roadway, are to be considered as roadways (on the traffic unit level--Driver Form). These two instances occur when a vehicle is exiting the driveway and the location of the First Harmful Event (A10) is in either of the following two areas. The first area is the area within the junction itself formed with the driveway access, or it is on the crossing roadway sufficiently near the junction such that in the investigator's opinion the driveway best represents the driver's pre-crash environment. The second area considered is the "throat" of the driveway. In either instance, the investigator should use the driveway as the roadway described on the vehicle's Driver Form.

An accident is considered to have occurred in the throat if, at the junction of a trafficway and a private way (ANSI D16.1-1976, section 2.2.2, page 5), a motor vehicle in transport is either entering or exiting the private way such that any part of the vehicle is in contact (on or over) with the road

Variable Name: Relation to Junction (cont'd.)

(of the trafficway) (ANSI D16.1-1976, section 2.2.19, page 7) at the location of the first harmful event (on the private way). If the accident occurred in the throat, then code "11" (Driveway, alley access related) should be used. In cases where a pedestrian, other nonmotorist associated with a nonmotorist conveyance (see variable P08, Pedestrian or Nonmotorist's Type), or road vehicle (ANSI D16.1-1976, section 2.2.6, page 5) is crossing laterally a private way (e.g., a driveway) and the pedestrian, nonmotorist, or vehicle is on the trafficway of the street or highway (e.g., within the horizontal extension of a sidewalk), then the "road" requirement of the "throat" rule is extended to include all of the trafficway. The road was used because it is more operationally defined than the trafficway; however, pedestrians, for example, crossing driveways who are struck by a vehicle entering the street or highway would technically not have their first harmful event occurring in the "throat". For this reason, where the trafficway is clearly defined, the throat can be extended up the private way to include any first harmful events which occur on the trafficway.

In the paragraph above, it is stated that many driveways are not roadways in NASS (e.g., driveways to service stations, residential areas, etc.) unless the first harmful event occurs in a junction, near a junction, or the "throat" rule condition is satisfied. There are driveways, however, which constitute roadways in NASS without having to satisfy these conditions. Certain driveways within parking or shopping lots qualify if they satisfy the three criteria discussed below.

The phrase "open to the public as a matter of right or custom" (ANSI D16.1-1976, section 2.2.1, page 4) causes problems when the property is privately owned. One problem area centers around shopping centers. It has been stated many times that private ownership does not automatically disqualify a case for consideration as a NASS accident. The nature and extent of "land ways" (section 2.1.11, page 4) on private property, and the differences in accident reporting criteria by police, have brought about the narrowing of the definition of a trafficway (section 2.2.1, page 4) to that which can be operationally defined. In parking or shopping lots three criteria have been suggested:

- There must exist two or more contiguous lanes of travel that are clearly marked;
- The land way must intersect another land way inside the lot or center; and
- The junction of the internal land ways must have traffic controls (i.e., STOP or YIELD signs or markings).

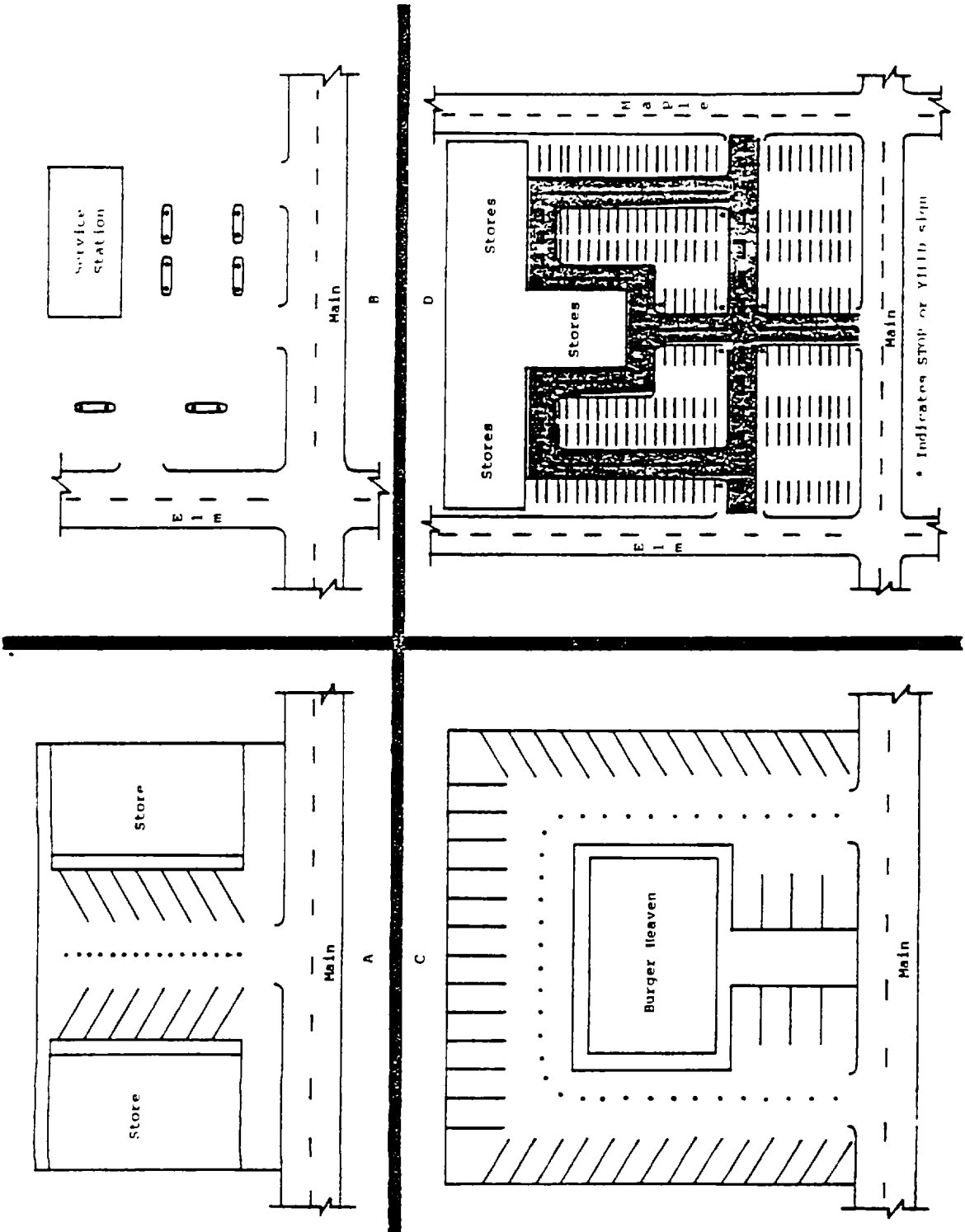

Variable Name: Relation to Junction (cont'd.)

The intent is to select those land ways which serve the purpose of getting traffic to and from the parking area; however, the fact that parking is allowed immediately adjacent to the land way does not disqualify it from consideration. The diagram on the preceding page (containing four schematics) does not attempt to cover the entire spectrum of possibilities but only to illustrate some common examples. For situations A, B, and C none of the land ways should be considered as trafficways, since the criteria are not met. However, a NASS accident could occur at each of these if it satisfied the "throat rule" above. In situation D the screened in areas are roadways since they meet the criteria.

A railroad grade crossing (code "12") is the area formed by the at-grade connection of a railroad bed and a roadway. The railroad bed is defined, for NASS purposes, as the area encompassed within: (1) eight feet either side of the center of a single set of tracks, or (2) eight feet beyond the centers of the outside sets in the case of multiple sets.

If the first harmful event occurs in the area formed by the connection of the railroad bed and the roadway, then code "12" (Railroad grade crossing) should be used.

A crossover (code "13") is a designated opening within a median used primarily for "U-turns". To be considered, the nearest lateral boundary line of the crossover must be greater than 10 meters (33 feet) from the nearest lateral boundary line of any roadway (highway, street, ramp, driveway, or alley) which intersects with either side of the roadways which the median divides.

Code "13" (Crossover related) should be used if the first harmful event occurred (1) in the junction of a crossover and a roadway, (2) on any leg of the roads which approach or exit from the crossover and which are just outside of the crossover junction itself (and subject to the provision below), or (3) in the crossover itself, and at least one involved pedestrian, other nonmotorist associated with a nonmotorist conveyance' (see variable P08, Pedestrian or Nonmotorist's Type), or road vehicle (ANSI D16.1-1976, section 2.2.6, page 5) was entering, in, or exiting from the crossover. Do not use this code if the accident was precipitated by the actions of a noncontact road vehicle or person.

Median cuts which are directly across from or within 10 meters (33 feet) of the nearest lateral boundary line of any roadway (highway, street, ramp, driveway, or alley) are considered extensions of the roadway and do not count as an additional leg of the junction. The area between the roadways

ACCIDENT FORM

A24
(17)

Variable Name: Relation to Junction (cont'd.)

which the median cut serves is considered part of the junction unless the roadways belong to separate trafficways. In this case, consider the area as a separate road segment. If the location of the first harmful event is in the median cut, code the appropriate response--"02" (Three leg intersection), "03" (Four leg intersection), or "11" (Driveway, alley access related).

ACCIDENT FORM

A24
(19)

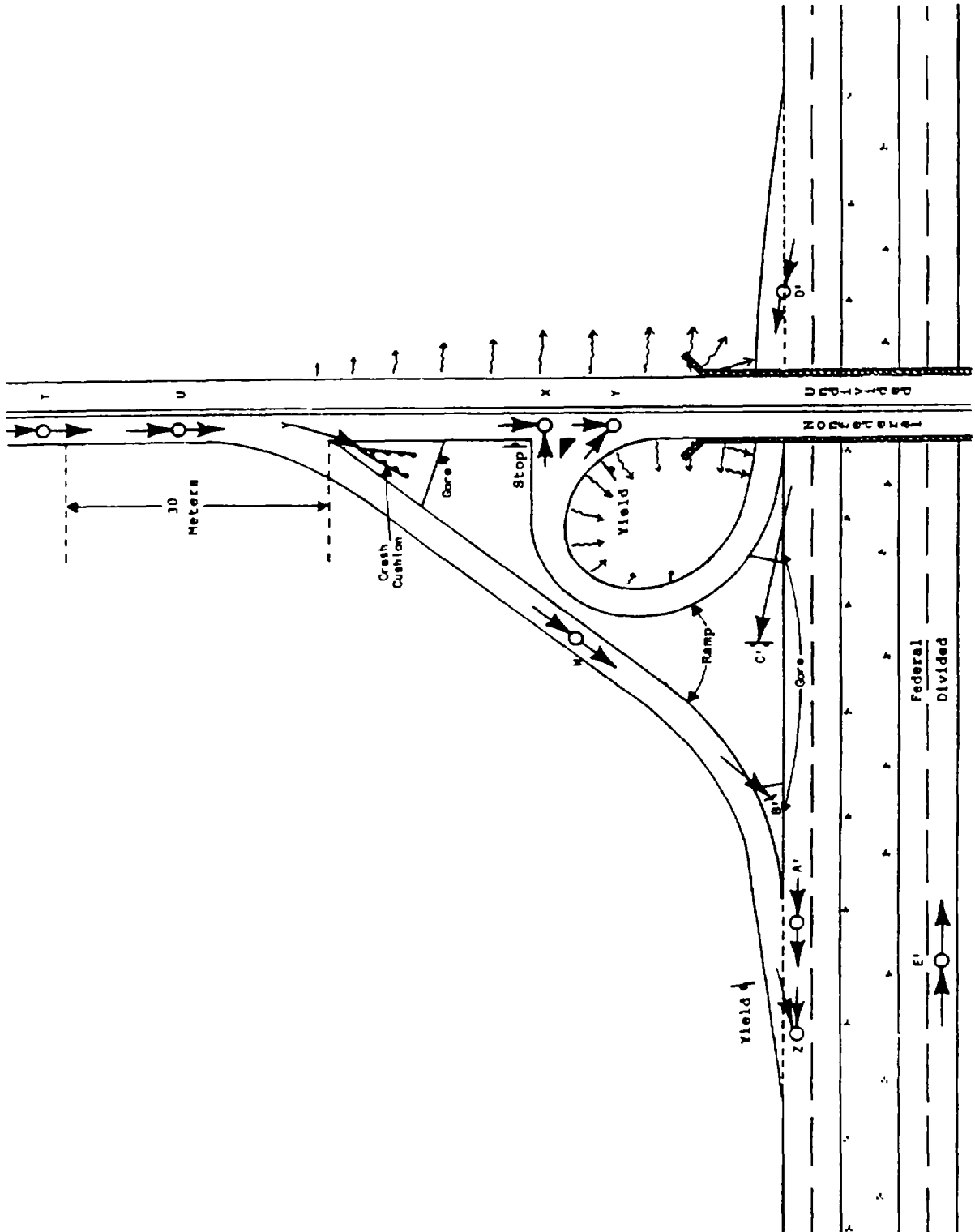

The table on this page and the two preceding pages of diagrams depict a number of exemplary accidents along with the appropriate codes for five accident variables.

Situation	A21 Federal Aid Class		A24 Relation to Junction										A27 Number of Lanes		A31 Trafficway Flow		A38 Traffic Control Device	
	Fed	Non Fed	Four leg	Three leg	Non-junction	Channel	Area of divergence/divergence related	Entrance/exit ramp	Inter-change area	Driveway alley access related	Railroad Crossing	Number	Divided	Undivided	Yes	No	Maybe	
A	✓		✓									6		✓				
B	✓								✓			1 or 2						
C	✓				★							6		✓				
D	✓								✓			6		✓				
E																		
F	✓				★							6					✓	
G		✓										2		✓				
H	✓											6		✓				
I	✓				†							6		✓				
J		✓				✓						1		✓			✓	
K		✓			✓							1		✓			✓	
L		✓										2		✓				
M		✓										2		✓				
N		✓										1		✓				
O		✓			★							2		✓			✓	
P		✓										2		✓				
Q		✓			★					✓		2		✓			✓	
R		✓			†							2		✓				
S		✓			†							4		✓				
T		✓			✓							2		✓				
U		✓										2		✓				
V		✓						✓				1 or 2		✓				
W		✓						✓				1		✓				
X		✓										1		✓				
Y		✓										2		✓				
Z		✓					✓					3		✓				
A'		✓										3		✓				
B'		✓										1		✓				
C'		✓										2		✓				
D'		✓										3		✓				
E'		✓					✓					2		✓				

*Although coded as non-junction in this example, it is recognized that the accident may have occurred due to some event or activity at an intersection (exclusive of the vehicle(s) in this accident). In those cases A24 (Relation to Junction) would be coded as "06" (Intersection related) rather than "01" (Non-junction), and A38 (Traffic Control Device) would be coded, given their existence and relationship to the accident, on the basis of the applicable code rather than "00" (No controls).

†Intersection related ("06") should be coded for A24 (Relation to Junction).

Variable Name: School Bus Related

Format: 1 column - numeric

Beginning
Column 45

Element Values:

0 No
1 Yes

Source: Investigator determined--inputs include police report, vehicle inspections, driver interviews, and other interviewees.

Remarks:

This variable applies to accidents in which a school bus (V14, Body Type, need not equal 30) was directly or indirectly involved, such as an accident involving children alighting from a school bus. The school bus does not have to be involved in the accident. If it cannot be determined that a school bus was involved, code "0" (No).

For the purpose of this variable, a school bus refers to a motor vehicle which satisfies the following criteria:

- externally identifiable to other traffic units as a school/pupil transport vehicle, the vehicle may be equipped with flashing lights, may have a sway stop arm and traffic may be required to stop for the vehicle when occupants enter or exit;
- operated, leased or owned by a public or private school-type institution;
- where the institution's students may range from pre-school through high school;
- whose occupants, if any, are associated with the institution; and,
- the vehicle is in operation at the time of the accident to and from the school or on a school-sponsored activity or trip.

Variable Name: Right or Left Turn on Red Related

Format: 1 column - numeric

Beginning
Column 46

Element Values:

- 0 No
- Right turn related
- 1 Yes - turn permitted
- 2 Yes - turn prohibited
- Left turn related
- 3 Yes - turn permitted
- 4 Yes - turn prohibited
- 9 Unknown

Source: Police report is used to determine if the accident is related to a right or left turn; police report and scene inspection are used to determine if the turn was permitted or prohibited.

Remarks:

Code "0" (No) is used if the PAR does not indicate that a right or left turn was involved. Investigator opinion about the relationship between the accident and a right or left turning maneuver is not a consideration. In addition, code "0" (No) must be coded if the location of the first harmful event was not at or near an on-colors (see remarks section for A38, Traffic Control Device) signalized junction (intersections, some driveways, etc.). Further, all turning movements indicated to have occurred on the green (i.e., not against the red) cannot qualify the accident for consideration.

Code "1", "2", "3", or "4" (Yes) if the PAR indicates that a turning maneuver occurred (1) at an on-colors signalized junction, (2) against the red, and (3) was related to the accident. Codes "1" or "2" (Right turn related) are used if a right turning maneuver was involved and codes "3" or "4" (Left turn related) if a left turning maneuver was indicated.

Given that a turning maneuver was related, the investigator determines from the police report, one's knowledge of state law and/or local ordinance (if applicable), and investigation of the scene whether or not a turn on red was permitted (codes "1" and "3") or prohibited (codes "2" and "4").

Code "9" (Unknown) is used if the PAR indicates the presence of a turning maneuver at an on-colors signalized junction but does not indicate whether or not the turning maneuver was related to the accident. For example, if

ACCIDENT FORM

A26
(2)

Variable Name: Right or Left Turn on Red Related (cont'd.)

the diagram on the PAR shows a vehicle making a turning maneuver at a signalized junction but does not definitively state anywhere that the turning movement was (1) against the red and (2) related to the accident, then unknown ("0") should be coded.

Variable Name: Number of Travel Lanes

Format: 1 column - numeric

Beginning
Column 47

Element Values:

- 1 One
- 2 Two
- 3 Three
- 4 Four
- 5 Five
- 6 Six
- 7 Seven or more
- 9 Unknown

Source: Primary source is scene inspection; secondary sources include the police report and driver interviews.

Remarks:

Code the value on the basis of the location of the first harmful event.

If the first harmful event occurs off the roadway, refer to the section at the point of departure to code this variable.

If the first harmful event is located in the junction of two or more roadways, report the number of lanes in accordance with the accident level versus traffic unit level environmental data discussion which preceded variable A21, Federal Aid System.

If the first harmful event is with the traffic island associated with the channel or ramp, code the number of lanes based on the location of the vehicle's entry onto the traffic island.

A roadway is that part of a trafficway where vehicles travel. A divided trafficway is composed of two or more roadways.

If traffic flows in both directions and is undivided, code the number of lanes in both directions. If the trafficway is divided into two or more roadways, code only the number of lanes for the roadway associated with the first harmful event.

ACCIDENT FORM

A27

(2)

Variable Name: Number of Travel Lanes (cont'd.)

If turn bays, acceleration, deceleration, or two-way left turn lanes exist and are physically located within the cross section of the roadway where the first harmful event occurred, they are to be included in the number of lanes. Channelized lanes, by their definition (see ANSI D16.1-1976, section 2.5.13), are separated from other through or turn related lanes. (NOTE: the separation normally will not involve a physical barrier.) Because channelized lanes are separated, they are not to be included. If the first harmful event occurs in a channel (see Remarks section A24, Relation to Junction), code the number of lanes in the channel. If the first harmful event is with the traffic island associated with the channel or the ramp, code the number of lanes based on the location of the vehicle's entry onto the traffic island. When the accident occurs in a junction and the assessment is made at the mouth, channelized lanes will be excluded. However, if the location of the first harmful event is back upstream from a channelized junction, then the lane may be counted if it came from a turn bay or lane.

The number of lanes counted includes any which are narrowed or rendered unusable by restrictions of the right-of-way cited in variables A42 (Restriction of Roadway at Scene) or A43 (Additional Restriction of Roadway at Scene). Only those lanes ordinarily used for motor vehicle travel should be considered when coding this variable (i.e., pedestrian/bicycle lanes are excluded).

In a number of instances, there will be uncertainty as to the number of lanes due to: (1) nonstandard roadway widths; (2) variability of width in the same roadway due to disrepair and other reasons; or (3) absence of lane lines, center lines, edge lines, etc. The number coded in these cases should represent the number of operational lanes based on customary or observed usage.

On a road that has legal parking such that the legal parking area ends short of the junction of the roadway with another roadway or drive, and the space left between the end of the legal parking area and the beginning of the junction can be utilized for turning by a vehicle on the roadway, do not consider this additional area as another travel lane (regardless of customary or observed usage in this instance). This area should be construed as additional width to the existing travel lane(s). The only time that another lane will be counted at a junction is when that space is expressly designated for turning [e.g., by lane (line or turn arrow) markings, signs, or signals].

The number of lanes for driveways, widemouth parking lots, etc. should be coded as follows: if it is possible to determine the number of lanes through either lane markings or observed or customary use, code the actual number of lanes present. If the number of lanes cannot be accurately established, use code "9" (Unknown).

ACCIDENT FORM

A27

(3)

Variable Name: Number of Travel Lanes (cont'd.)

If the vehicle was on a channel or an entrance or exit ramp (A24, Relation to Junction, codes "07" and "09" respectively), code the number of lanes for that roadway section (also see A28, Median Type, remarks).

If crossover related ("13") is coded for variable A24, Relation to Junction, then code the number of lanes in accordance with the location of the first harmful event as follows: (1) in or near the junction of a crossover and a roadway, code the number of roadway lanes; (2) in the crossover, code the highest number of lanes associated with a roadway from which a motor vehicle involved in the first harmful event entered the crossover.

Variable Name: Median Type

Format: 1 column - numeric

Beginning
Column 48

Element Values:

- 0 No median
- 1 Curbed
- 2 Positive barrier
- 3 Unprotected
- 9 Unknown

Source: Primary source is scene inspection; secondary sources include the police report and driver interviews.

Remarks:

The attribute is determined from the same roadway which was used to determine the Number of Travel Lanes (A27). It is associated with the location of the first harmful event. This means that if the accident occurred in a junction, then the rules for selecting the roadway must be followed.

The investigator selects the descriptor which identifies the environment at the crash site. (NOTE: If uncertainty exists concerning the location of the first harmful event, refer to point "1" in the accident level versus traffic unit level environmental data discussion, following A20, Land Use.)

In order to code this variable the investigator must first determine if the trafficway was divided at the point of assessment. A trafficway may be divided into two or more roadways. Any intentional separation (see exception below) of travel lanes, either opposing or lanes in the same direction, constitutes a division of a trafficway. Separations can be composed of physical barriers in addition to lateral distance. Further definitions help to describe medians: (1) Medians provide an insulating area between streams of moving traffic; (2) medians provide protection and control of cross and turning traffic; (3) medians provide a refuge for pedestrians.

Medians and gores (see remarks section for A12, Relation to Roadway, for definitions) separate roadways. A traffic island (associated with a channel) separates travel lanes but does not constitute a division of a trafficway because the associated channelized lane(s) is (are) not considered to be a separate roadway.

ACCIDENT FORM

A28
(2)

Variable Name: Median Type (cont'd.)

Entrance and exit ramps (see remarks section for A24, Relation to Junction, code "09" for definition) are considered separate (unique) roadways. Therefore, even though they are divided from their primary roadway [i.e., the one used for Federal Aid System (A21) classification purposes], their division is assessed independently. Ramps are not considered divided unless two ramps exist adjacent separated by a median (with or without a physical barrier). A ramp can divide into two ramps. A gore separates the ramps. The gore does not constitute a division.

Multiple medians could be present. If they are not, then this variable reports about the median that is present. If more than one is present and the first harmful event occurred in median (code "3" for A12, Relation to Roadway), then this variable reports about the median involved in the first harmful event. If more than one is present and the first harmful event did not occur in a median, then this variable reports about the first median encountered laterally to the left (with respect to normal traffic flow) from the first harmful event.

Physical division of roadways (e.g., concrete traffic barrier) overrides simple lateral division (e.g., grass median) therefore, code "2" (Positive barrier) takes precedence over codes "1" (Curbed) and "3" (Unprotected).

Code "0" (No median) if no medians are present independent of the presence of a gore or traffic island. Variable A29, Median Width, must equal "00" (No median), and variable A31, Trafficway Flow, must equal either "0" [Not physically divided (two way traffic)] or "3" (One way trafficway).

Code "1" (curbed) describes raised areas which are curbed including those protected by mountable curbs.

Code "2" (Positive barrier) refers to all concrete or other types of longitudinal barriers (i.e., all manufactured barriers). Also, bridge or underpass supporting structures and bridge rails take this code.

Code "3" (Unprotected) includes any vegetation, gravel, or paved flush--painted or unpainted--medians.

Vegetation, gravel median - includes trees, water, embankments, and ravines that separate a trafficway (i.e., nonmanufactured barrier).

Painted flush median can be described as solid painted lines spaced apart with the intent to divide a trafficway into two or more roadways. The intent to divide means to purposely create a safety zone between streams of traffic. Division does not occur when double no passing lines are separated

ACCIDENT FORM

A28

(3)

Variable Name: Median Type (cont'd.)

by a dashed center line or when double solid center lines are present and separated by no more than the width of a center line--allow a margin of error for poor workmanship. If a distance greater than the width of a painted line (about 4 inches) and not attributable to poor workmanship, exists between two painted (should be "solid") center lines, then a separation is considered to have occurred.

Variable Name: Median Width

Format: 2 columns - numeric

Beginning
Column 49

Element Values:

Code actual measured value up to 96 feet

00 No median

97 97 feet and above

99 Unknown

Source: Primary source is scene inspection; secondary sources include the police report and driver interviews.

Remarks:

The attribute is determined from the same roadway which was used to determine the Number of Travel Lanes (A27). It is associated with the location of the first harmful event. This means that if the accident occurred in a junction, then the rules for selecting the roadway must be followed.

The investigator selects the descriptor which identifies the environment at the crash site. (NOTE: If uncertainty exists concerning the location of the first harmful event, refer to point "1" in the accident level versus traffic unit level environmental data discussion, following A20, Land Use.)

Code "00" (No median) if no median (code "0") was coded for A28, Median Type.

Medians are measured to the nearest foot from the center of roadway edge line to edge line, where present, or roadway edge (best estimate) to roadway edge, where edge lines are absent. Inside shoulders are thus included since the shoulder (for NASS purposes) may be a variety of surface types and its exact width difficult to determine.

Code "01" (1 foot) includes all distances less than 1.5 feet.

In some instances estimation may be required because of physical difficulties in taking the measurement at the appropriate location. The investigator should always attempt to obtain as good an approximation as possible. In some cases a point nearby can be used. Other times the measurement may have to be made at a substantial distance (e.g., location of first harmful event is on a bridge spanning a river).

Variable Name: Access Control

Format: 1 column - numeric

Beginning
Column 51

Element Values:

- 1 Full
- 2 Partial
- 3 Uncontrolled
- 9 Unknown

Source: Primary source is scene inspection; secondary sources include the police report and driver interviews.

Remarks:

The attribute is determined from the same roadway which was used to determine the Number of Travel Lanes (A27). It is associated with the location of the first harmful event. If the roadway is an entrance or exit ramp, ANSI (D16.1-1976, section 3.7.3.4, pages 26-27) requires that the ramp be coded (full, partial, or uncontrolled) the same as the roadway of the higher (lower numerically) Federal Aid System classification (A21) which it connects. Determine which of the connected roadways is higher [if they are the same (A21), then choose the one that led to the ramp] and determine the value for this variable at the general area where the ramp connects with the roadway.

The investigator selects the descriptor which identifies the environment at the crash site. (NOTE: If uncertainty exists concerning the location of the first harmful event, refer to point "1" in the accident level versus traffic unit level environmental data discussion, following A20, Land Use.)

Code "1" (Full) refers to those situations where the authority to control access is exercised to give preference to through traffic by providing access connection with selected public roads only, by prohibiting crossings at-grade, or by prohibiting direct driveway connections.

Code "2" (Partial) refers to those situations where the authority to control access is exercised to give preference to through traffic to a degree that, in addition to access connections with selected public roads, there may be some crossings at-grade and some private driveway connections.

ACCIDENT FORM

A30
(2)

Variable Name: Access Control (cont'd.)

Code "3" (Uncontrolled) refers to those situations where the authority having jurisdiction over a highway, street, or road, does not limit the number of points of ingress or egress except through the exercise of control over the placement and geometrics of connections as necessary for the safety of the travelling public.

In summary, consider the roadway section which was chosen for the reporting of Number of Travel Lanes, A27. If there are no at-grade crossings, then code "1". If at-grade crossings exist but there is an indication that a limiting of access is taking place, then code "2". If no indication of access limiting can be found, then code "3". If a decision cannot be made, code "9".

Variable Name: Trafficway Flow

Format: 1 column - numeric

Beginning
Column 52

Element Values:

- 0 Not physically divided (two way traffic)
- 1 Divided trafficway - median strip without traffic barrier
- 2 Divided trafficway - median strip with traffic barrier
- 3 One way trafficway
- 9 Unknown

Source: Primary source is scene inspection; secondary sources include the police report and driver interviews.

Remarks:

The attribute is determined from the same roadway which was used to determine the Number of Travel Lanes (A27). It is associated with the location of the first harmful event.

The investigator selects the descriptor which identifies the environment at the crash site. (NOTE: If uncertainty exists concerning the location of the first harmful event, refer to point "1" in the accident level versus traffic unit level environmental data discussion following A20, Land Use.)

Code "0" [Not physically divided (two way traffic)] can only be used whenever A28, Median Type, is coded "0" (No median). Remember although gores separate roadways and traffic islands (associated with channels) separate travel lanes neither is involved in the determination of trafficway division (see remarks section for A28, Median Type).

Code "1" (Divided trafficway - median strip without traffic barrier) and "2" (Divided trafficway - median strip with traffic barrier) most likely will be used whenever a trafficway division is reported [i.e., A28, Median Type, equal "1" (Curbed), "2" (Positive barrier), or "3" (Unprotected)]. It is presumed that the traffic travels in but one direction on the roadway associated with the location of the first harmful event. If multiple medians are present, choose the first median encountered laterally to the left (with respect to the normal traffic flow) from the first harmful event. A traffic barrier is any positive barrier (see code "2" for A28, Median Type). If the median has a barrier code "2"; otherwise, code "1" should be used.

ACCIDENT FORM

A31

(2)

Variable Name: Trafficway Flow (cont'd.)

Code "3" (One way trafficway) is used primarily whenever the trafficway is undivided [code "0" (No median) for A28, Median Type] and traffic flows in but one direction (e.g., one-way streets). However, this code can also be used where a median is present so long as all the traffic on the trafficway goes in the same direction. An example occurs where the opposing roadway of the same named trafficway had to be split by such a distance that the right-of-way divides to accommodate other property. If (rare) one of the trafficways is further divided into multiple roadways by a median, then in this instance code "3" (One way trafficway) should be used.

Variable Name: Interchange Geometry

Format: 1 column - numeric

Beginning
Column 53

Element Values:

- 0 No interchange
- 1 Full diamond
- 2 Partial diamond
- 3 Full cloverleaf
- 4 Partial cloverleaf
- 5 Trumpet
- 6 Directional
- 8 Other (specify)
- 9 Unknown

Source: Primary source is the scene inspection; secondary sources include the police report and driver interviews.

Remarks:

An interchange area is the area around a grade separation (ANSI D16.1-1976, section 2.5.14, page 14) which involves at least two trafficways. Included within its boundaries are: (1) all ramps which connect the roadways, and (2) each roadway entering or leaving the interchange to a point 30 meters (100 feet) beyond the gore or curb return at the outermost ramp connection for the roadway. One may find included within an interchange area intersections, driveway accesses, and, of course, roadway sections which are non-junction.

If the location of the first harmful event was not in an interchange area, code "0" (No interchange).

Definitions for codes "1" through "6" were taken from the Transportation and Traffic Engineering Handbook (1976), written by the Institute of Transportation Engineers--pages 645, 646, and 650-655.

A full diamond (code "1") is a four-leg interchange with a single, one-way ramp in each quadrant. All left turns are made directly on the minor highway. Shown below are regular diamond, diamond with "slip" ramps to frontage road, and "split diamond" interchanges.

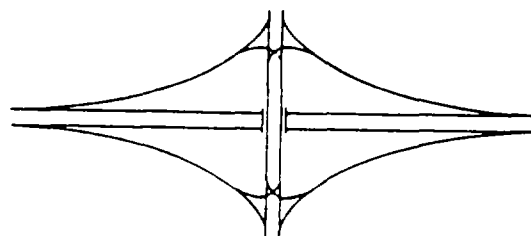

Regular
Diamond
Interchange

Variable Name: Interchange Geometry (cont'd.)

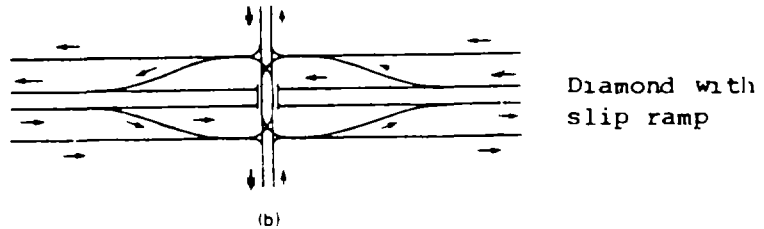

Diamond with slip ramp

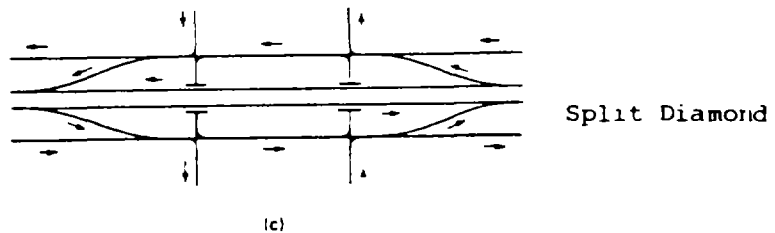

Split Diamond

A partial diamond (code "2") is a four-leg interchange that basically fits the diamond configuration but lacks the existence of a single, one-way ramp in at least one quadrant.

A full cloverleaf (code "3") is a four-leg interchange with ramps for two turning movements in each quadrant, one of which is a loop ramp.

A partial cloverleaf (code "4") is a four-leg interchange that has some loop ramps for left turn maneuvers, but either does not have two ramps per quadrant or one loop ramp per quadrant. Typical cloverleaf patterns are shown below.

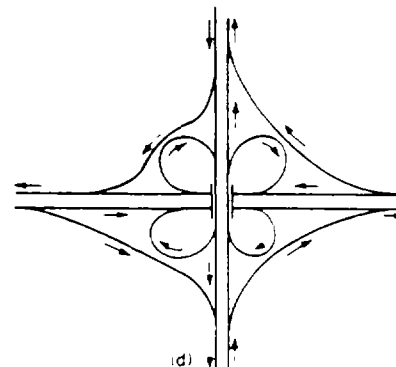
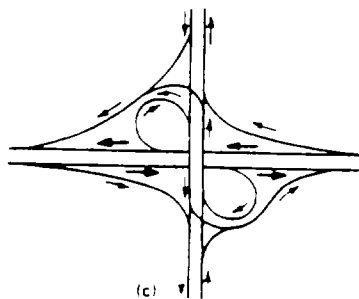
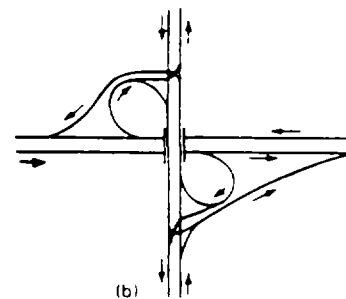
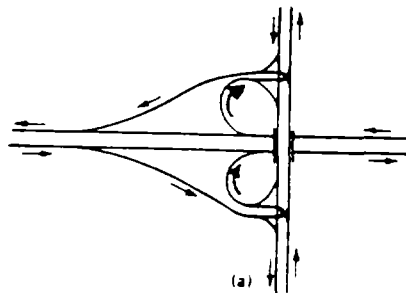

Variable Name: Interchange Geometry (cont'd.)

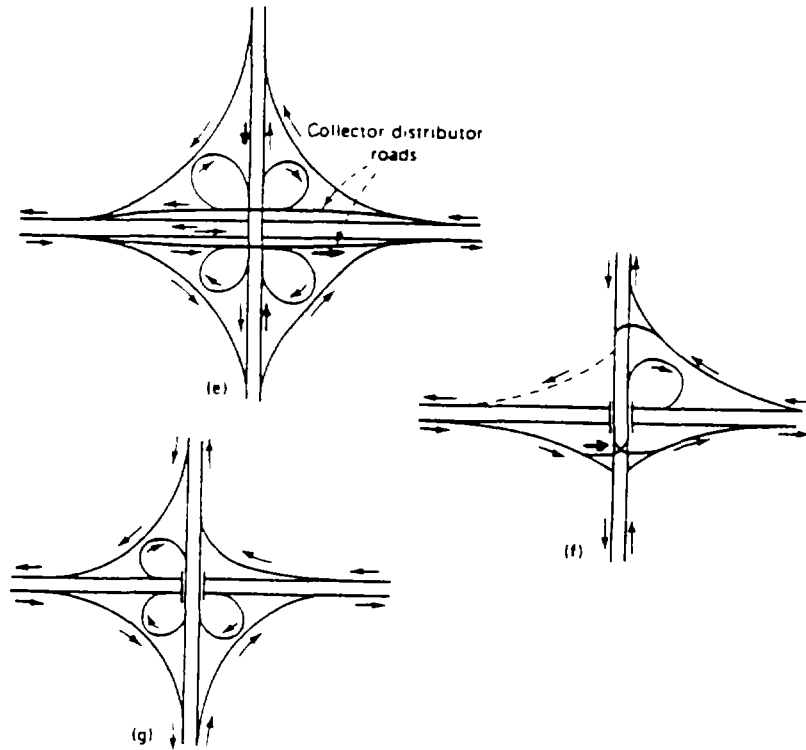

(a), (b), (c), (f), and (g) are examples of partial cloverleaves, while (d) and (e) are full cloverleaves.

A trumpet (code "5") interchange is one with three approach legs. Code "trumpet" even if the interchange is a "Y" or a "T" interchange. Examples of each of these types is shown below.

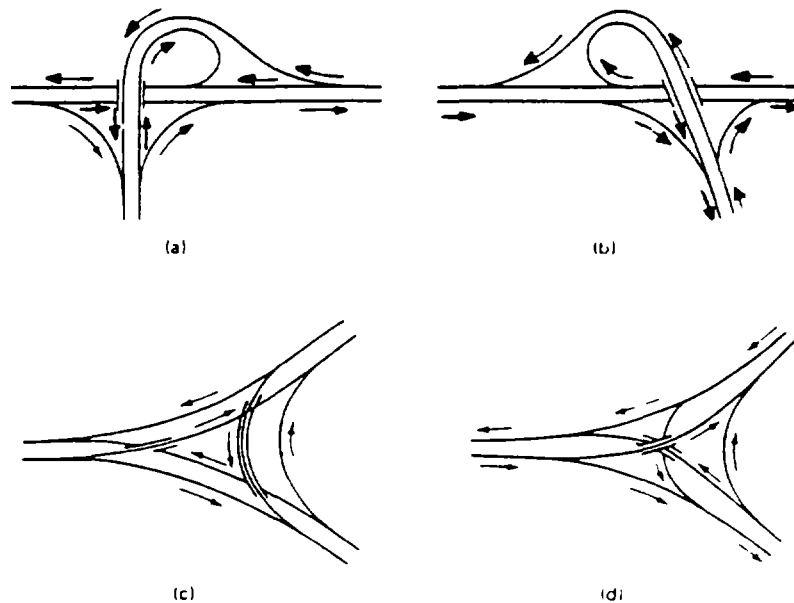

Variable Name: Interchange Geometry (cont'd.)

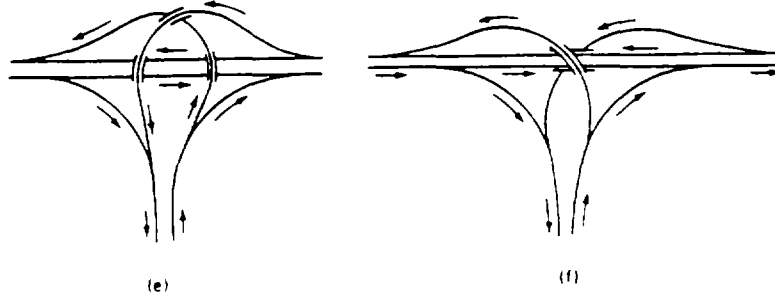

A directional (code "6") interchange is one having more than one highway grade separation with direct or semidirect connections for the major left turning movements. Four of the most common types are shown below. Patterns (a), (b), and (d) show complete directional patterns. Example (c) is a partial directional pattern with three loop ramps.

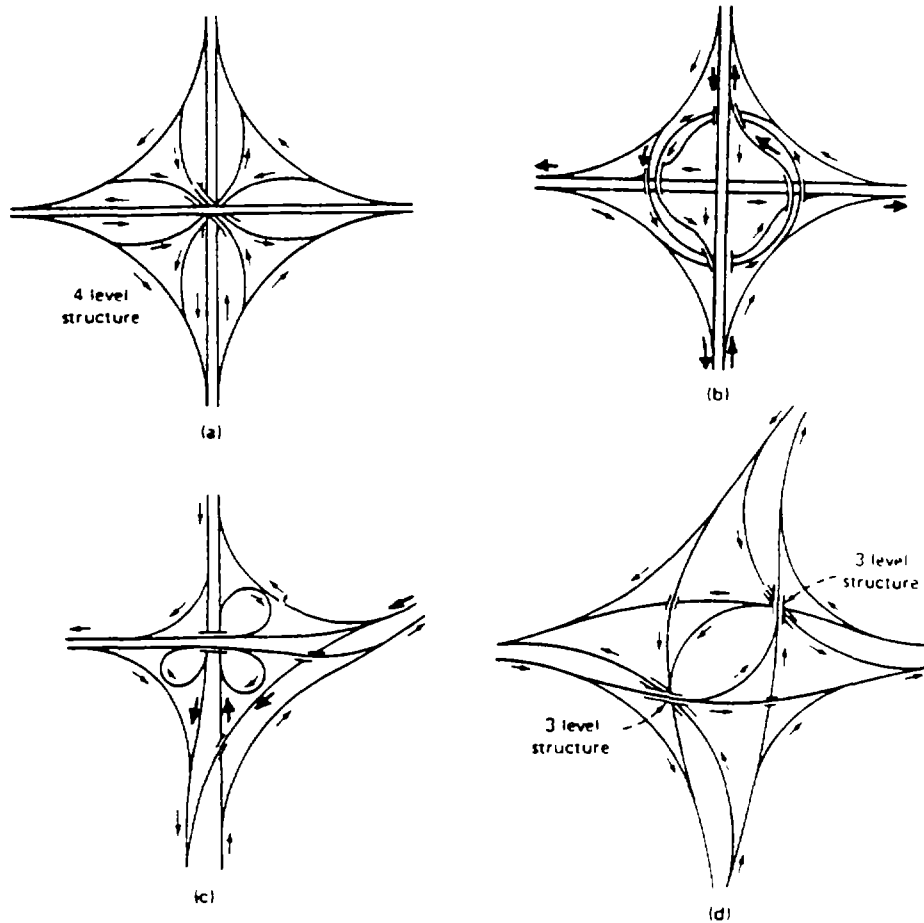

Use other (code "8") for any interchange design that does not fit in codes "1" through "6" above.

Variable Name: Shoulder Presence

Format: 1 column - numeric

Beginning
Column 54

Element Values:

- 0 No shoulder
- 1 One shoulder
- 2 Two shoulders
- 9 Unknown

Source: Primary source is scene inspection; secondary sources include the police report and driver interviews.

Remarks:

The attribute is determined from the same roadway which was used to determine the Number of Travel Lanes (A27). It is associated with the location of the first harmful event.

The investigator selects the descriptor which identifies the environment at the crash site. (NOTE: If uncertainty exists concerning the location of the first harmful event, refer to point "1" in the accident level versus traffic unit level environmental data discussion, following A20, Land Use.)

Consider the same lanes which were used to determine the Number of Travel Lanes (A27), and report the presence of shoulders for those same lanes at, and lateral to, the location of the first harmful event, unless at a junction. In the case of a first harmful event located within a junction, identify the appropriate roadway using the criteria under A27, Number of Travel Lanes, and then select the element value based on the leg of that roadway prior to the junction.

A shoulder is defined as that part of a trafficway (1) contiguous with the roadway for emergency use, (2) for accommodation of stopped road vehicles, and (3) for lateral support of the roadway structure (see ANSI D16.1-1976, section 2.2.18, pages 6-7).

Contiguous surfaces fall into two categories--stabilized and unstabilized. Stabilized means that: (1) the surface was paved with a portland cement concrete or bituminous coarse surface on a granular or improved base, or (2) the earth has been covered with a gravel or other granular material. Unstabilized means that the surface is composed of natural earth, with or without turf.

The accommodation criteria is considered satisfied if a minimum of two (2) feet of area contiguous to the roadway is provided. In other words, the

ACCIDENT FORM

A33
(2)

Variable Name: Shoulder Presence (cont'd.)

entire width of the vehicle under consideration does not have to fit on the contiguous area to qualify the area as a shoulder. If edge lines are present when you measure the lateral distance, measure from the center of the edge line.

In order to provide lateral support to the roadway, the shoulder's surface condition does not have to be stabilized. If the shoulder surface has separated (i.e., eroded away) to expose the base of the roadway, creating an unsafe departure for vehicles, then the lateral support criterion is not met. However, it must be emphasized that the "base" must be exposed. Pavement lips or cracking along the edge of the roadway surface do not by themselves constitute a lacking of lateral support.

The area is a shoulder if it is contiguous to the roadway, provides lateral support to the roadway, and is two feet or greater in width. A raised traffic island at the mouth of a roadway should be considered like a curb and thus not a shoulder. A designated parking lane should not be considered a shoulder for NASS purpose. On the other hand, a painted flush island or a paved median between two edgelines should be considered a shoulder.

On this variable, the investigator reports the number of shoulders present (codes "1" and "2"). Greater detail regarding the type of shoulders present for each involved roadway is reserved for encoding on the Driver Form (see D51, Shoulder Type - Left, and D52, Shoulder Type - Right).

Code "0" (No shoulder) if the roadway is curbed (barrier type curbs) and has no shoulders; code the appropriate response if there are both curbs (mountable) and shoulders (either code "1" or "2").

Code "0" (No shoulder) for any private way (ANSI D16.1-1976, section 2.2.2, page 5) that only becomes a NASS roadway because the accident is coded as driveway, alley access related (code "11") on A24, Relation to Junction [see Remarks page (5)].

Shoulders are still present even if not usable at the time of the accident due to ambient conditions such as plowed snow, parked vehicles, etc.

Pedestrian/bicycle lanes which exist between the roadway and improved shoulder, or outside but contiguous with the improved shoulder should be considered as extra shoulder width (examples 1 and 2 below). Pedestrian/bicycle lanes which exist contiguous with the roadway and bounded on the outside edge (barrier type curb, ditch, etc.) should not be considered a shoulder (example 3).

ACCIDENT FORM

A 33
(3)

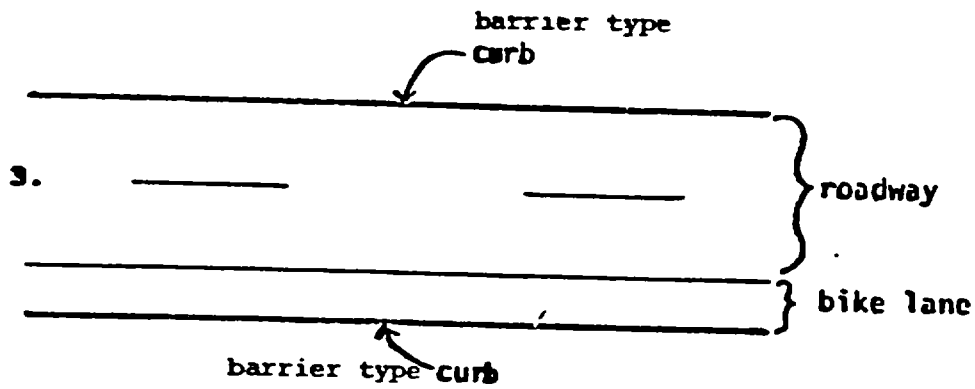
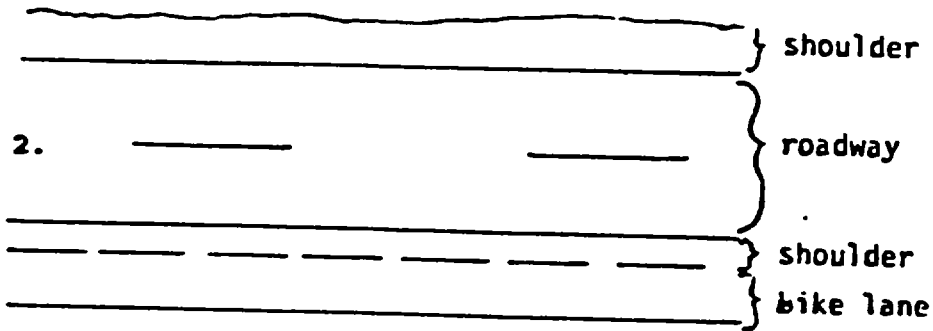
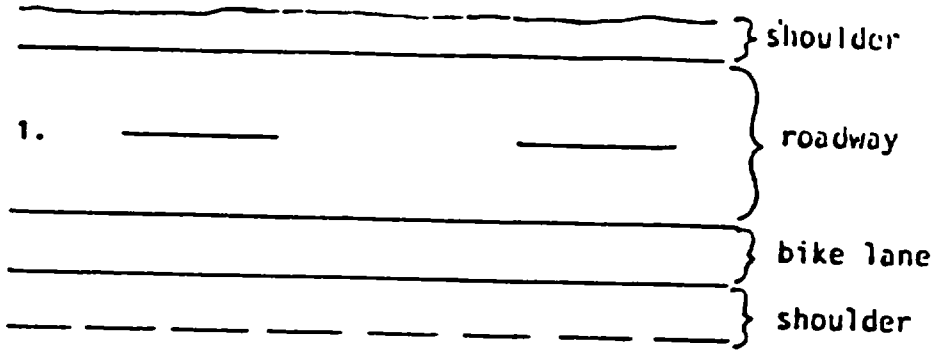

Variable Name: Roadway Alignment

Format: 1 column - numeric

Beginning
Column 55

Element Values:

- 1 Straight
- 2 Curve
- 9 Unknown

Source: Primary source is scene inspection; secondary sources include the police report and driver interviews.

Remarks:

The attribute is determined from the same roadway which was used to determine the Number of Travel Lanes (A27). It is associated with the location of the first harmful event.

The investigator selects the descriptor which identifies the environment at the crash site. (NOTE: If uncertainty exists concerning the location of the first harmful event, refer to point "1" in the accident level versus traffic unit level environmental data discussion, following A20, Land Use.)

Code "1" (Straight) refers to a horizontal surface which is tangent.

Code "2" (Curve) refers to a horizontal surface in transition between two points of tangency as in the following examples:

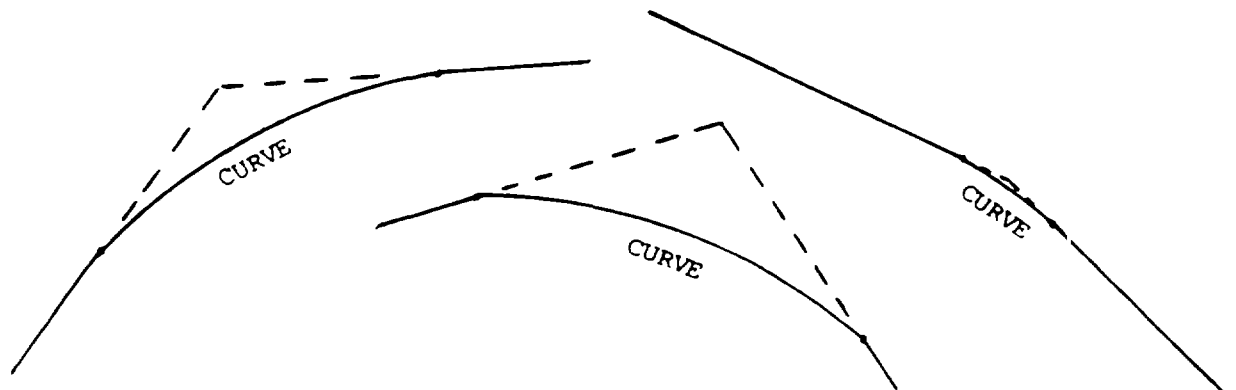

Any perceptually-determined curvature between two tangent sections of a roadway constitutes a curve.

Variable Name: Roadway Profile

Format: 1 column - numeric

Beginning
Column 56

Element Values:

- 1 Level
- 2 Grade (> 2%)
- 3 Hillcrest
- 4 Sag
- 9 Unknown

Slope

Measurement: (Please write the resultant percentage in this space on the driver form.)

(v= _____)/(h= _____)

Source: Primary source is scene inspection; secondary sources include the police report and driver interviews.

Remarks:

The attribute is determined from the same roadway which was used to determine the Number of Travel Lanes (A27). It is associated with the location of the first harmful event.

The investigator selects the descriptor which identifies the environment at the crash site. (NOTE: If uncertainty exists concerning the location of the first harmful event, refer to point "1" in the accident level versus traffic unit level environmental data discussion, following A20, Land Use.)

For all scenes inspected, the slope measurement (associated with the first harmful event), horizontal (level) distance and vertical (perpendicular) distance must be taken and recorded in the spaces provided on the CSS form.

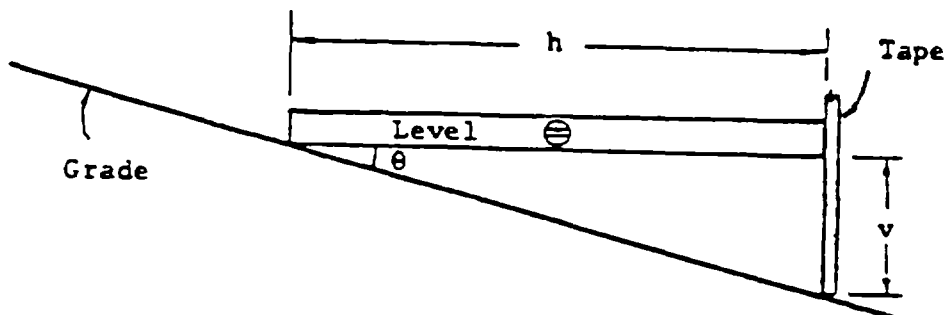

Variable Name: Roadway Profile (cont'd.)

Code "1" (Level) refers to a tangent surface whose gradient is $< 2\%$.

Code "2" [Grade ($\geq 2\%$)] refers to a tangent surface whose gradient is $\geq 2\%$.

Code "3" (Hillcrest) refers to a surface in vertical transition between two points of tangency as in the following examples:

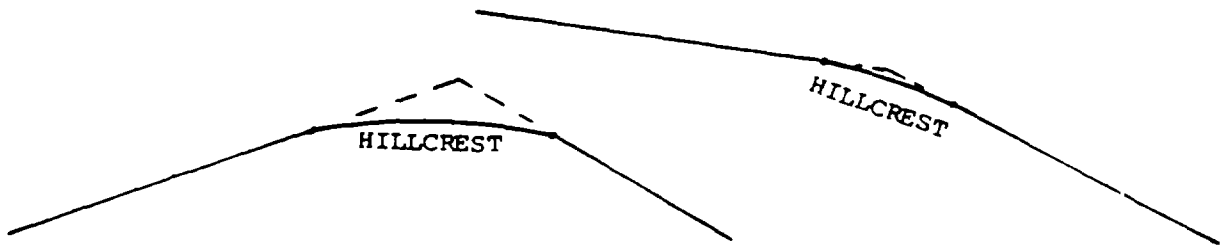

Code "4" (Sag) refers to a surface in vertical transition between two points of tangency as in the following examples:

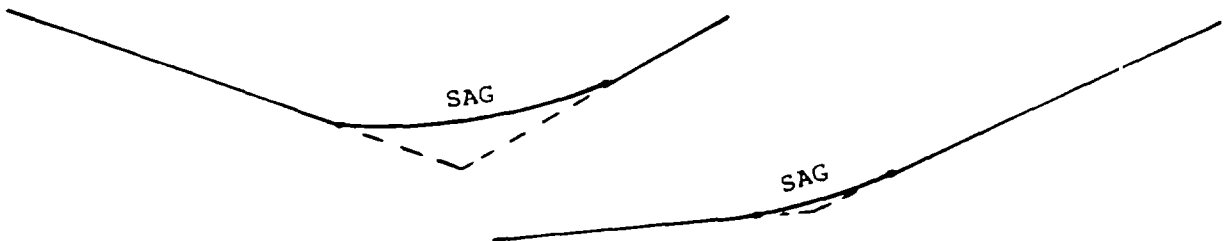

Variable Name: Roadway Surface Type

Format: 1 column - numeric

Beginning
Column 57

Element Values:

- 1 Concrete
- 2 Bituminous [asphalt]
- 3 Brick or block
- 4 Sand, gravel or stone
- 5 Dirt
- 8 Other (specify)
- 9 Unknown

Source: Primary source is scene inspection. secondary sources include the police report and driver interviews.

Remarks:

The attribute is determined from the same roadway which was used to determine the Number of Travel Lanes (A27). It is associated with the location of the first harmful event.

The investigator selects the descriptor which identifies the environment at the crash site. (NOTE: If uncertainty exists concerning the location of the first harmful event, refer to point "1" in the accident level v rsus traffic unit level environmental data discussion, following A20, Land Use.)

If the lateral cross section contains lanes of more than one surface type, code the surface type of the lane just beneath the location of the first harmful event. However, if the location is in a junction and the surface type in the junction differs longitudinally from the surface type in the mouth, code the surface type at the mouth.

Variable Name: Roadway Surface Condition

Format: 1 column - numeric

Beginning
Column 58

Element Values:

- 1 Dry
- 2 Wet
- 3 Snow or slush
- 4 Ice
- 5 Sand, dirt or oil
- 8 Other (specify)
- 9 Unknown

Source: Primary sources are the police report and the driver interview; a secondary source is the scene inspection.

Remarks:

The element value selected is based on the location of the first harmful event. In determining the surface condition, the investigator should use police reports, interviews and observation of the site; do not report the conditions which are observed several days following the accident unless they are felt to be the same as those at the time of the accident.

Consider the same lanes which were used to determine the Number of Travel Lanes (A27) and report the surface condition for those same lanes.

It is possible for different surface conditions to exist when multiple roadways are involved. Furthermore, different surface conditions may exist on the same roadway (e.g., intermittent wet and dry sections on the same roadway). The investigator should consider, but not necessarily be restricted by, the information on the police report for making this assessment. Driver Forms should also be consulted, particularly the one whose vehicle was on the above travel lanes which correspond to the first harmful event. Although it may be difficult to ascertain the surface condition for a particular section, the investigator should attempt to select the value which is most representative of the surface condition for those lanes.

If sand, dirt or oil (code "5") occurs in combination with moisture (codes "2", "3", or "4"), code the moisture condition. Code "5" only if the road was otherwise dry.

Asphalt will "bleed". If, in the opinion of the investigator, the bleeding was such as to constitute a road surface detriment, then code "8" (Other). On the other hand, bleeding which is intermittent and insignificant, in terms of area, should be coded as "1" (Dry). If moisture occurs with the bleeding, code "2" (Wet) should be used.

Variable Name: Traffic Control Device

Format: 2 columns - numeric

Beginning
Column 59

Element Values:

00 No controls

Not at railroad grade crossing

01 Traffic control signal (on colors) without pedestrian signal

02 Traffic control signal (on colors) with pedestrian signal

03 Traffic control signal (on colors) not known whether or not pedestrian signal

04 Flashing traffic control signal

05 Flashing beacon

06 Flashing highway traffic signal, type unknown or other than traffic control or beacon

07 Lane use control signal

08 Other highway traffic signal

09 Unknown highway traffic signal

Regulatory signs

20 Stop sign

21 Yield sign

28 Other regulatory sign

29 Unknown type regulatory sign

School zone signs

30 School speed limit sign

31 School advance or crossing sign

38 Other school related sign

39 Unknown type school zone sign

Warning signs

40 Warning sign

Miscellaneous controls

50 Officer, crossing guard, flagman, etc.

63 Wigwags

64 Bells

68 Other train activated device

69 Active device, type unknown

Passive devices

70 Crossbucks

71 Stop sign

72 Other railroad crossing sign

73 Special warning device - watchman, flagged by crew

78 Other passive device

79 Passive device, type unknown

Miscellaneous controls

80 Grade crossing controlled, type unknown

Whether or not at railroad grade crossing

98 Other

99 Unknown

ACCIDENT FORM

A38
(2)

Variable Name: Traffic Control Device (cont'd.)

Source: Primary source is scene inspection; secondary sources include the police report and driver interviews.

Remarks:

The attribute is determined from the same roadway which was used to determine the Number of Travel Lanes (A27). It is associated with the location of the first harmful event.

The investigator selects the descriptor which identifies the environment at the crash site. (NOTE: If uncertainty exists concerning the location of the first harmful event, refer to point "1" in the accident level versus traffic unit level environmental data discussion, following A20, Land Use.)

This variable measures controls which regulate vehicular traffic. Excluded are any controls which solely regulate pedestrians (e.g., Walk/Wait signals).

According to ANSI D6.1-1978, section 2A-7, pages 2A-3,4 (Manual on Uniform Traffic Control Devices), signs are classified functionally as follows: Regulator signs give notice of traffic laws or regulations. Warning signs call attention to conditions on, or adjacent to, a highway or street that are potentially hazardous to traffic operations; and Guide signs show route designations, destinations, directions, distances, services, points of interest, and other geographical, recreational, or cultural information.

According to ANSI D6.1-1978, section 2A-10, pages 2A-4,5 signs come in standard shapes. The octagon shall be reserved exclusively for the STOP sign. The equilateral triangle, with one point downward, shall be reserved exclusively for the YIELD sign. The round shape shall be used for the advance warning of a railroad crossing and for the civil defense evacuation route marker. The pennant shape, an isosceles triangle, with its longest axis horizontal, shall be used to warn of no passing zones. The diamond shape shall be used only to warn of existing or possible hazards either on the roadway or adjacent hereto. The [vertical] rectangle, ordinarily with the longer dimension vertical, shall be used for regulatory signs, with the exception of STOP signs and YIELD signs. The [horizontal] rectangle, ordinarily with the longer dimension horizontal, shall be used for guide signs, with the exception of certain route markers and recreational area guide signs. The pentaqon, point up, shall be used for School Advance and School Crossing signs. Other shapes are reserved for special purposes. for example, the shield or other characteristic design for route markers and cross-buck for railroad crossings.

Variable Name: Traffic Control Device (cont'd.)

According to ANSI D6.1-1978, Section 2A-11, page 2A-5, signs can be distinguished by their color. The following general rules apply. Red is used as a background color on prohibitory type regulatory signs (e.g., STOP, DO NOT ENTER, WRONG WAY). It is also used as the circular outline and diagonal bar prohibitory symbol. Black may be used as a background (e.g., ONE WAY): it is used as a message on white, yellow and orange signs. White is used as the background for route markers, guide signs, and regulatory signs (except STOP). It is used as the legend on brown, green, blue, black, and red signs. Orange is used only as a background color for construction and maintenance signs. Yellow is used as a background color for warning signs and for school signs. Brown, green, and blue are used as a background color for guide signs.

Pavement markings do not constitute traffic control devices under the present definition.

Guide signs do not constitute traffic controls.

The investigator should consider the intent of this question. If at the time of the accident there was no intent to control (regulate or warn) vehicle traffic, then code "00" (No controls) otherwise, code the appropriate value. Statutory controls (e.g., state law requires that when two drivers meet at an uncontrolled intersection, the one on the right has the right-of-way) should be coded as "00" (No controls).

Focus on the road segment at the location of the first harmful event and select the traffic control device(s) which is (are) most related to the accident. If multiple devices are related, select the device of highest (lowest numerically) priority.

For example, if the intersection is channelized and controlled differently on the channel than on the through lanes (e.g., signal and yield sign), report the traffic controls depending on whether the roadway (A27, Number of Travel Lanes) was chosen based on its through lanes or its channelized lanes.

The codes are prioritized in decreasing numerical value (i.e., "01" takes precedence over "02," "02" over "03", etc.—see exception associated with code "50"). Codes are grouped generally into those not at a railroad crossing ("01" through "50") and those at a railroad grade crossing ("60" through "80"). This means that highway traffic signals take precedence over regulatory signs, school zone signs, and warning signs. Regulatory signs take precedence over school and warning signs. School signs take precedence over warning signs. Likewise, active (railroad crossing) devices take precedence

Variable Name: Traffic Control Device (cont'd.)

over passive devices. If a school guard, police officer, or other officially-designated person controls both pedestrian and vehicular traffic, code "50" (Officer, crossing guard, flagman, etc.) should be used. Any officially-designated person (code "50") takes precedence over values "00" through "40".

Codes "60" through "80" should only be used when the first harmful event occurs in the junction of a roadway and a railroad bed [i.e., A24, Relation to Junction, equals "12" (Railroad grade crossing)]. If A24 equals "12", "50" should be used when the location of the first harmful event occurs anywhere else (i.e., A24 equals "01" through "11" or "13").

Codes "01", "02", or "03" [Traffic control signal (on colors ...)] is used for any signal which processes through the green, amber, and red cycles. The source of actuation is of no concern. If the amber phase is missing, an on-colors control device should still be coded.

If the signal has green, amber, and red cycle capability but is being used to flash amber/red only, then code "04" (Flashing traffic control signal) is used.

Code "05" (Flashing beacon) is used for any device capable of only flashing amber/red signals.

Code "07" (Lane use control signal) includes turn arrows and controls which govern the direction of traffic flow in the lane (i.e., traffic flows differently depending on time of day).

Code "28" (Other regulatory sign) includes speed limit signs, movement signs (e.g., NO TURN, LEFT TURN ONLY, DO NOT PASS, PASS WITH CARE, KEEP RIGHT, DO NOT ENTER, WRONG WAY, ONE WAY), parking signs (e.g., NO PARKING, EMERGENCY PARKING ONLY), pedestrian signs (e.g., NO HITCH HIKING, NO PEDESTRIANS), and other miscellaneous signs (e.g., STOP HERE ON RED, NO TURN ON RED, ROAD CLOSED TO THRU TRAFFIC, WEIGHT LIMIT ..., TRUCK ROUTE)--see ANSI D6.1-1978, sections 2B-10 through 2B-44, pages 2B-6 through 2B-36.

Codes "30" through "39" (School zone signs) should only be used if the first harmful event occurred during the time the sign was in effect. If the sign was in effect, it does not matter whether or not children were present. (NOTE: Time should be ascertained not only with respect to hour of day, but day of week and the effect of holidays, vacations, etc., as well. Each team should report the particulars regarding their state or local ordinances to their Zone Center.) See ANSI D6.1-1978, sections 7B-9 through 7B-13, pages 7B-2 through 7B-6, for examples of school zone signs.

Variable Name: Traffic Control Device (cont'd.)

Code "40" (Warning signs) is used for any black on yellow diamond shaped sign. Some black on yellow horizontal rectangular or vertical rectangular (speed advisory) signs are also included. See ANSI D6.1-1978, section 2C-1 through 2C-41, pages 2C-1 through 2C-22 for examples of signs.

Code "60" (Gates) is used if the railroad crossing is guarded by a combination of gates, flashing lights, and bells. See ANSI D6.1-1978, section 8C-2 through 8C-4, pages 8C-1 through 8C-5, for examples of flashing lights with and without gates.

Code "70" (Crossbucks) is coded if no train activated devices are present and a large "X", with the words RAILROAD CROSSING spelled out on the "X", is present--see ANSI D6.1-1978, section 8B-2, pages 8B-1 and 8B-2.

Code "72" (Other railroad crossing signs) includes the railroad advance warning sign (circle with black "X" on yellow background)--see ANSI D6.1-1978, section 8B-3, page 8B-3.

Code "98" (Other) includes a school bus with flashers activated where vehicles are required to stop.

A traffic control that has been deactivated (e.g., traffic signal that emits no signals) during certain times of the day and was deactivated at the time of the accident should be coded "00" (No controls). A traffic control that has just been installed and not yet activated should also be coded "00". However, a traffic control that is out (e.g., due to a power failure) and was related should be coded, unless a temporary control (e.g., stop sign ("20"), police officer ("50"), etc.) has been inserted, in which case the temporary control should be coded.

Variable Name: Traffic Control Device Functioning

Format: 1 column - numeric

Beginning
Column 61

Element values:

- 0 No traffic control
- 1 Traffic control not functioning
- 2 Traffic control functioning - functioning improperly
- 3 Traffic control functioning properly
- 9 Unknown

Source: Sources are scene inspection, police report, and driver interviews.

Remarks:

Code "0" (No traffic control) must only be used when A38, Traffic Control Device is coded "00" (No controls).

Codes "1" (Traffic control not functioning), "2" (Traffic control functioning - functioning improperly), and "3" (Traffic control functioning properly) are used with respect to the traffic control device cited in A38, Traffic Control Device. Code "3" if the device reported was okay; code "1" if the device did not function at all (e.g., signal out). Code "2" is used when the device had some function but the function was improper or inadequate (e.g., signal works by cycles are short, long, or irregular; sign is covered by vegetation reducing line-of-sight). When this code ("2") is used PHOTOGRAPHS are to be taken of the traffic control device. It is a judgment as to whether function was merely improper versus nonexistent. Your decision will be judged on its reasonableness; annotate where necessary.

Code "9" (Unknown) is only used when A38, Traffic Control Device, is coded "99" (Unknown).

ACCIDENT FORM

A40

Variable Name: Accident Occurrence on School Zone

Format: 1 column - numeric

Beginning
Column 62

Element values:

0 No
1 Yes
9 Unknown

Source: Primary source is scene inspection; secondary sources include the police report and driver interviews.

Remarks:

The attribute is determined from the same roadway which was used to determine the Number of Travel Lanes (A27). It is associated with the location of the first harmful event.

The investigator selects the descriptor which identifies the environment at the crash site. (NOTE: If uncertainty exists concerning the location of the first harmful event, refer to point "1" in the accident level versus traffic unit level environmental data discussion, following A20, Land Use.)

Code "1" (Yes) should only be used if a sign or road marking was present and the accident occurred during the time the sign or marking was in effect (i.e., this applies to the applicable time periods before, during, and following school sessions).

Variable Name: Speed Limit

Format: 2 columns - numeric

Beginning
Column 63

Element values:

Level 2 Range: 15 through 55

Code actual posted or statutory speed limit in m.p.h.

00 No statutory limit

99 Unknown

Source: Primary sources are the scene inspection or statutory law. Do not use the police report for selecting this variable's value.

Remarks:

The attribute is determined from the same roadway which was used to determine the Number of Travel Lanes (A27). It is associated with the location of the first harmful event.

The investigator selects the descriptor which identifies the environment at the crash site. (NOTE: If uncertainty exists concerning the location of the first harmful event, refer to point "1" in the accident level versus traffic unit level environmental data discussion, following A20, Land Use.)

Disregard advisory or other speed signs which do not indicate the legal speed limit. Furthermore, do not confuse advisory signs on entrance/exit ramps or near intersections with the actual legal maximum speed limit.

If no speed limit sign is posed within a "reasonable" distance from the location of the first harmful event along the approach leg of the vehicle for which A27 (Number of Travel Lanes) was selected, the investigator should reference state statutes to obtain the applicable statutory maximum for the scene (local or state).

If a state has a statute that uniformly reduces the maximum allowable speed within or near a construction zone, then code the indicated reduced limit.

Code "00" (No statutory limit) should be used on roadways which are neither posted nor which have a statutory limit (e.g., parking lot roadways or entrance/exits, service station entrance/exits, or driveways, etc.).

If the first harmful event involves vehicles which have different applicable speed limits (e.g., automobile 55, truck 45) record the higher of the applicable limits.

Variable Name: Restriction of Roadway at Scene

Format: 1 column - numeric

Beginning
Column 65

Element values:

- 0 No restrictions
- 1 Narrow bridge (as defined)
- 2 Previous accident on roadway
- 3 Maintenance, repair or construction activity on roadway
- 4 Roadway immersion (e.g., standing water)
- 8 Other roadway restriction (specify)
- 9 Unknown

Source: Primary source is scene inspection; secondary sources include the police report and driver interviews.

Remarks:

The element value selected is not restricted to the location of the first harmful event. The intent of this variable is to identify pre-crash conditions which abnormally reduce the width of the travel lanes available to any driver in the accident from the width ordinarily expected.

Element values "1" through "4", and "8" may be coded if the investigator feels any of them are in some way related to the accident as determined from the police report, driver interviews, witnesses, or scene investigation. The investigator should proceed through the list in numerically descending order and code the first element felt to have existed. For example, if both "1" (Narrow bridge) and "2" (Previous accident on roadway) existed, code "1". The second or higher numbered element will be accounted for on the next variable (A43, Additional Restriction of Roadway at Scene).

Code "1" (Narrow bridge) refers to a bridge which satisfies any part of the criteria as follows:

- (1) has only one lane which is 18 feet or less in width,
- (2) has two lanes which, together, are 24 feet or less in width, or
- (3) the total approach width, as measured from the outside edge of the shoulders, is greater than the total bridge width, as measured from curb-to-curb or parapet-to-parapet.

Code "3" (Maintenance, repair or construction activity on roadway) includes those segments of a divided trafficway where the traffic in one direction is

ACCIDENT FORM

A42
(2)

Variable Name: Restriction of Roadway at Scene (cont'd.)

diverted onto the roadway of the opposing direction due to maintenance, repair, or construction activity that has temporarily closed one of the roadways. The segment begins where the roadway associated with the first harmful event is first narrowed due to physical barriers and ends when the same roadway resumes normal travel conditions.

Code "4" (Roadway immersion) refers to standing or flowing water which reduces the ordinary width of the travel lanes; it is not necessary for the complete width of the lanes to be immersed.

Code "8" (Other roadway restriction) refers to other restrictions such as fallen rocks, objects, cargo, mud slides, deep snow, waiting taxi, police or repair vehicles stopped in travel lanes, vehicles parked in roadway, etc. Make note of the other restriction in the available space. It excludes vehicles in the routine process of pulling into or out of parking lanes which very temporarily narrow or restrict the roadway.

These variables (A42 and A43) are oriented toward permanent or transitorily-fixed objects: therefore, they exclude temporary restrictions to specific sections of the road (e.g., extra-wide load pulled by tractor in motion). Should the above mentioned vehicle be stopped on the roadway, it would then be considered a restriction of the right-of-way.

Variable Name: Additional Restriction of Roadway at Scene

Format: 1 column - numeric

Beginning
Column 66

Element values:

- 0 No additional restrictions
- 2 Previous accident on roadway
- 3 Maintenance, repair or construction activity on roadway
- 4 Roadway immersion (e.g., standing water)
- 5 More than two restrictions
- 8 Other roadway restriction (specify)
- 9 Unknown

Source: Primary source is scene inspection; secondary sources include the police report and driver interviews.

Remarks:

If only one restriction existed, it will have been coded under the variable A42, Restriction of Roadway at Scene; therefore, code "0" for this variable (A43).

If a second, but not a third, restriction of the right-of-way existed, and you were prohibited from coding it on the preceding variable (A42, Restriction of Roadway at Scene), select the proper element value for that restriction to code on this variable.

If more than two restrictions of the right-of-way existed, code "5". The initial restriction will have been coded under variable A42 (Restriction of Roadway at Scene), while the remaining one will be coded as "5" for this variable (A43).

If A42, Restriction of Roadway at Scene, is unknown ("9"), then unknown ("9") should be coded for this variable as well. However, if it is known that only one restriction of the roadway existed but that the nature of the restriction is unknown, then unknown ("9") should be coded for A42, Restriction of Roadway at Scene, and no additional restrictions ("0") coded for this variable.

Variable Name: SS6 - Emergency Medical Service

Format: 1 column - numeric

Beginning
Column 67

Element values:

- 0 No
- 1 Yes
- 8 Not in effect

Source: Special study procedures.

Remarks:

Code "1" (Yes) means there is one or more emergency medical service special study forms associated with this accident.

Code "0" (No) means there are no emergency medical service special study forms associated with this accident.

Code "8" (Not in effect) means that this special study was not active at the time this accident was sampled, or not applicable for a particular PSU.

ACCIDENT FORM

A45

Variable Name: SS7 - Pole

Format: 1 column - numeric

Beginning
Column 68

Element values:

- 0 No
- 1 Yes
- 8 Not in effect

Source: Special study procedures.

Remarks:

Code "1" (Yes) means there is one or more pole special study forms associated with this accident.

Code "0" (No) means there are no pole special study forms associated with this accident.

Code "8" (Not in effect) means that this special study was not active at the time this accident was sampled, or not applicable for a particular PSU.

Variable Name: SS8 - Longitudinal Barrier

Format: 1 column - numeric

Beginning
Column 69

Element values:

0 No
1 Yes
8 Not in effect

Source: Special study procedures.

Remarks:

Code "1" (Yes) means there is one or more longitudinal barrier special study forms associated with this accident.

Code "0" (No) means there are no longitudinal barrier special study forms associated with this accident.

Code "8" (Not in effect) means that this special study was not active at the time this accident was sampled, or not applicable for a particular PSU.

Variable Name: SS9 - Crash Cushion

Format: 1 column - numeric

Beginning
Column 70

Element values:

0 No
1 Yes
8 Not in effect

Source: Special study procedures.

Remarks:

Code "1" (Yes) means there is one or more crash cushion special study forms associated with this accident.

Code "0" (No) means there are no crash cushion special study forms associated with this accident.

Code "8" (Not in effect) means that this special study was not active at the time this accident was sampled, or not applicable for a particular PSU.

Variable Name: SS10 - Pedestrian Typing

Format: 1 column - numeric

Beginning
Column 71

Element values:

- 0 No
- 1 Yes
- 8 Not in effect

Source: Special study procedures.

Remarks:

Code "1" (Yes) means there is one or more pedestrian typing special study forms associated with this accident.

Code "0" (No) means there are no pedestrian typing special study forms associated with this accident.

Code "8" (Not in effect) means that this special study was not active at the time this accident was sampled, or not applicable for a particular PSU.

ACCIDENT FORM

A49

Variable Name: SS11 - Honda Civic

Format: 1 column - numeric

Beginning
Column 72

Element values:

0 No
1 Yes
8 Not in effect

Source: Special study procedures.

Remarks:

Code "1" (Yes) means that all four acceptability requirements for the Honda Civic special study have been satisfied.

Code "0" (No) means that this special study was not applicable, or acceptability requirements were not met.

Code "8" (Not in effect) means that this special study was not active at the time this accident was sampled, or not applicable for a particular PSU.

Variable Name: SS12

Format: 1 column - numeric

Beginning
Column 73

Element values:

0 No
1 Yes
8 Not in effect

Source: Special study procedures.

Remarks:

Code "1" (Yes) means that this special study was applicable.

Code "0" (No) means that this special study was not applicable.

Code "8" (Not in effect) means that this special study was not active at the time this accident was sampled, or not applicable for a particular PSU.

Variable Name: SS13

Format: 1 column - numeric

Beginning
Column 74

Element values:

0 No
1 Yes
8 Not in effect

Source: Special study procedures.

Remarks:

Code "1" (Yes) means that this special study was applicable.

Code "0" (No) means that this special study was not applicable.

Code "8" (Not in effect) means that this special study was not active at the time this accident was sampled, or not applicable for a particular PSU.

Variable Name: SS14

Format: 1 column - numeric

Beginning
Column 75

Element values:

0 No
1 Yes
8 Not in effect

Source: Special study procedures.

Remarks:

Code "1" (Yes) means that this special study was applicable.

Code "0" (No) means that this special study was not applicable.

Code "8" (Not in effect) means that this special study was not active at the time this accident was sampled, or not applicable for a particular PSU.

Variable Name: SS15

Format: 1 column - numeric

Beginning
Column 76

Element values:

- 0 No
- 1 Yes
- 8 Not in effect

Source: Special study procedures.

Remarks:

Code "1" (Yes) means that this special study was applicable.

Code "0" (No) means that this special study was not applicable.

Code "8" (Not in effect) means that this special study was not active at the time this accident was sampled, or not applicable for a particular PSU.

PEDESTRIAN AND NONMOTORIST

**NATIONAL ACCIDENT SAMPLING SYSTEM
CONTINUOUS SAMPLING SUBSYSTEM**

<table style="width:100%; border-collapse: collapse;"> <tr> <td style="width:70%;">1 Primary Sampling Unit Number</td> <td style="width:30%; text-align: center;">1 2</td> </tr> <tr> <td>2 Case Number - Stratification</td> <td style="text-align: center;">3 4 5 6</td> </tr> <tr> <td>3 Record Number</td> <td style="text-align: center;">2 7</td> </tr> <tr> <td>4 Transaction Code</td> <td style="text-align: center;">8</td> </tr> <tr> <td>5 Version Number</td> <td style="text-align: center;">7 9</td> </tr> <tr> <td>6 Investigator ID Number</td> <td style="text-align: center;">10</td> </tr> </table>	1 Primary Sampling Unit Number	1 2	2 Case Number - Stratification	3 4 5 6	3 Record Number	2 7	4 Transaction Code	8	5 Version Number	7 9	6 Investigator ID Number	10	<table style="width:100%; border-collapse: collapse;"> <tr> <th colspan="2" style="text-align: center; border-bottom: 1px solid black;">PEDESTRIAN OR NONMOTORIST INTERVIEW</th> </tr> <tr> <td style="width:70%;">9 Pedestrian or Nonmotorist's Age</td> <td style="width:30%;"></td> </tr> <tr> <td>_____ year(s) - Code actual age at time of accident</td> <td></td> </tr> <tr> <td>___(00) Less than one year old</td> <td></td> </tr> <tr> <td>___(97) 97 years and older</td> <td></td> </tr> <tr> <td>___(99) Unknown</td> <td style="text-align: center;">14 15</td> </tr> <tr> <td>10 Pedestrian or Nonmotorist's Sex</td> <td></td> </tr> <tr> <td>___(1) Male</td> <td></td> </tr> <tr> <td>___(2) Female</td> <td></td> </tr> <tr> <td>___(9) Unknown</td> <td style="text-align: center;">16</td> </tr> <tr> <td>11 Pedestrian or Nonmotorist's Height</td> <td></td> </tr> <tr> <td>_____ inches - Code actual reported height to the nearest inch</td> <td></td> </tr> <tr> <td>___(99) Unknown</td> <td style="text-align: center;">17 18</td> </tr> <tr> <td>12 Pedestrian or Nonmotorist's Weight</td> <td></td> </tr> <tr> <td>_____ pounds - Code actual reported weight to the nearest pound.</td> <td></td> </tr> <tr> <td>___(999) Unknown</td> <td style="text-align: center;">19 20 21</td> </tr> <tr> <td>13 Months Cycling Experience</td> <td></td> </tr> <tr> <td>_____ months - Code actual months of previous cycling experience up to 60.</td> <td></td> </tr> <tr> <td colspan="2"><i>(NOTE 44 days or less equals 1 month; a month and a half equals 2 months.)</i></td> </tr> <tr> <td>___(00) Non-cyclist</td> <td></td> </tr> <tr> <td>___(61) Greater than 60 months (5 years)</td> <td></td> </tr> <tr> <td>___(99) Unknown</td> <td style="text-align: center;">22 23</td> </tr> </table>	PEDESTRIAN OR NONMOTORIST INTERVIEW		9 Pedestrian or Nonmotorist's Age		_____ year(s) - Code actual age at time of accident		___(00) Less than one year old		___(97) 97 years and older		___(99) Unknown	14 15	10 Pedestrian or Nonmotorist's Sex		___(1) Male		___(2) Female		___(9) Unknown	16	11 Pedestrian or Nonmotorist's Height		_____ inches - Code actual reported height to the nearest inch		___(99) Unknown	17 18	12 Pedestrian or Nonmotorist's Weight		_____ pounds - Code actual reported weight to the nearest pound.		___(999) Unknown	19 20 21	13 Months Cycling Experience		_____ months - Code actual months of previous cycling experience up to 60.		<i>(NOTE 44 days or less equals 1 month; a month and a half equals 2 months.)</i>		___(00) Non-cyclist		___(61) Greater than 60 months (5 years)		___(99) Unknown	22 23
1 Primary Sampling Unit Number	1 2																																																								
2 Case Number - Stratification	3 4 5 6																																																								
3 Record Number	2 7																																																								
4 Transaction Code	8																																																								
5 Version Number	7 9																																																								
6 Investigator ID Number	10																																																								
PEDESTRIAN OR NONMOTORIST INTERVIEW																																																									
9 Pedestrian or Nonmotorist's Age																																																									
_____ year(s) - Code actual age at time of accident																																																									
___(00) Less than one year old																																																									
___(97) 97 years and older																																																									
___(99) Unknown	14 15																																																								
10 Pedestrian or Nonmotorist's Sex																																																									
___(1) Male																																																									
___(2) Female																																																									
___(9) Unknown	16																																																								
11 Pedestrian or Nonmotorist's Height																																																									
_____ inches - Code actual reported height to the nearest inch																																																									
___(99) Unknown	17 18																																																								
12 Pedestrian or Nonmotorist's Weight																																																									
_____ pounds - Code actual reported weight to the nearest pound.																																																									
___(999) Unknown	19 20 21																																																								
13 Months Cycling Experience																																																									
_____ months - Code actual months of previous cycling experience up to 60.																																																									
<i>(NOTE 44 days or less equals 1 month; a month and a half equals 2 months.)</i>																																																									
___(00) Non-cyclist																																																									
___(61) Greater than 60 months (5 years)																																																									
___(99) Unknown	22 23																																																								
IDENTIFICATION																																																									
<table style="width:100%; border-collapse: collapse;"> <tr> <td style="width:70%;">7 Pedestrian or Nonmotorist's Number</td> <td style="width:30%; text-align: center;">11 12</td> </tr> <tr> <td>8 Pedestrian or Nonmotorist's Type</td> <td></td> </tr> <tr> <td>___(1) Pedestrian</td> <td></td> </tr> <tr> <td>___(2) Bicyclist</td> <td></td> </tr> <tr> <td>___(3) Other cyclist</td> <td></td> </tr> <tr> <td>_____</td> <td></td> </tr> <tr> <td>___(4) Occupant of an animal related nonmotor vehicle transport device</td> <td></td> </tr> <tr> <td>___(5) Occupant of vehicle not in transport</td> <td></td> </tr> <tr> <td>___(8) Other nonmotorist</td> <td></td> </tr> <tr> <td>_____</td> <td></td> </tr> <tr> <td>_____</td> <td></td> </tr> <tr> <td>___(9) Unknown</td> <td style="text-align: center;">13</td> </tr> </table>	7 Pedestrian or Nonmotorist's Number	11 12	8 Pedestrian or Nonmotorist's Type		___(1) Pedestrian		___(2) Bicyclist		___(3) Other cyclist		_____		___(4) Occupant of an animal related nonmotor vehicle transport device		___(5) Occupant of vehicle not in transport		___(8) Other nonmotorist		_____		_____		___(9) Unknown	13																																	
7 Pedestrian or Nonmotorist's Number	11 12																																																								
8 Pedestrian or Nonmotorist's Type																																																									
___(1) Pedestrian																																																									
___(2) Bicyclist																																																									
___(3) Other cyclist																																																									

___(4) Occupant of an animal related nonmotor vehicle transport device																																																									
___(5) Occupant of vehicle not in transport																																																									
___(8) Other nonmotorist																																																									

___(9) Unknown	13																																																								
ACCIDENT DESCRIPTION INSTRUCTIONS	GENERAL DESCRIPTION OF ACCIDENT SEQUENCE																																																								
<p>Do not interrupt person during general description (narrative), unless he/she requests your assistance. Attempt to summarize the narrative while minimizing any disruptions of the person's internal logic. Specific questions may be asked later. Write these questions down in the space below or on the other side of the page, prior to the interview.</p> <p>SPECIFIC QUESTION _____</p> <p>_____</p> <p>_____</p> <p>_____</p> <p>_____</p>	<p><i>(This represents a synopsis of an uninterrupted narrative by the pedestrian or nonmotorist.)</i></p> <p>_____</p> <p>_____</p> <p>_____</p> <p>_____</p> <p>_____</p> <p>_____</p> <p>_____</p> <p>_____</p> <p>_____</p>																																																								

Delete After Case Review

ACCIDENT DIAGRAM

Draw a rough sketch of the accident sequence as described by the pedestrian or nonmotorist. Note impact and final rest positions carefully. If possible, relate these to some identifiable object in the area, and record vehicle and pedestrian or nonmotorist headings relative to an object, as well.

Indicate North

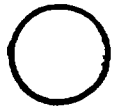

14. Pedestrian or Nonmotorist's Location

- ___ (01) Intersection related - in crosswalk
- ___ (02) Intersection related - on roadway, not in crosswalk
- ___ (03) Intersection related - on roadway, crosswalk not available
- ___ (04) Intersection related - on roadway, crosswalk availability unknown
- ___ (05) Intersection related - not on roadway
- ___ (09) Intersection related - unknown
- ___ (10) Nonintersection - in crosswalk
- ___ (11) Nonintersection - on roadway, not in crosswalk
- ___ (12) Nonintersection - on roadway, crosswalk not available
- ___ (13) Nonintersection - on roadway, crosswalk availability unknown
- ___ (14) Nonintersection - in parking lane
- ___ (15) Nonintersection - on road shoulder
- ___ (16) Nonintersection - bike path
- ___ (17) Nonintersection - outside trafficway
- ___ (18) Nonintersection - other, not on roadway _____
- ___ (19) Nonintersection - unknown
- ___ (99) Unknown

24 25

15 19 Blank (These variables are left blank so that numbering consistency can be maintained with compatible variables on the Occupant Data form.)

20. Treatment - Mortality

<u>Inter- viewee</u>	<u>Official Sources</u>
___ (1) Fatal	_____
___ (2) Fatal - ruled disease	_____
Nonfatal	
___ (3) Hospitalization	_____
___ (4) Transported and released	_____
___ (5) Treatment - other	_____

___ (6) No treatment	_____
___ (9) Unknown	_____

26

21. Hospital Stay

___ (00) Not hospitalized	
___ day(s) (code the number of days (up through 60) that the pedestrian or nonmotorist stayed in hospital)	_____
___ (61) 61 days or more	_____
___ (99) Unknown	_____

27 28

22. Working Days Lost

___ (00) No working days lost	
___ day(s) (code the number of days (up through 60) that the pedestrian or nonmotorist lost from work due to the accident)	_____
___ (61) 61 days or more	_____
___ (62) Fatally injured	_____
___ (99) Unknown	_____

29 30

INJURY DATA FROM INTERVIEWEE

Indicate the *Nature, Location, and injury Source* of all injuries

Soft Tissue Injuries

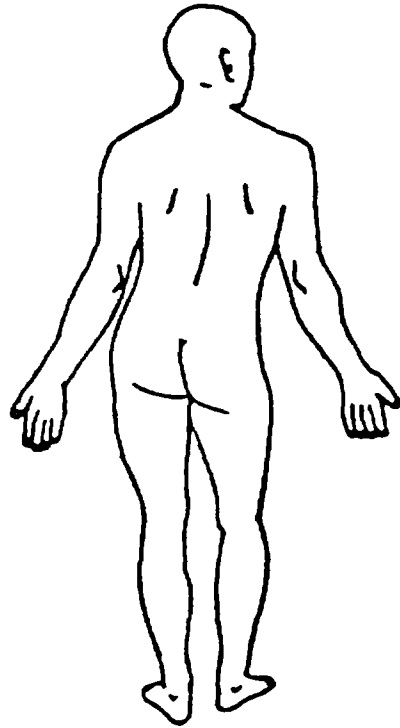
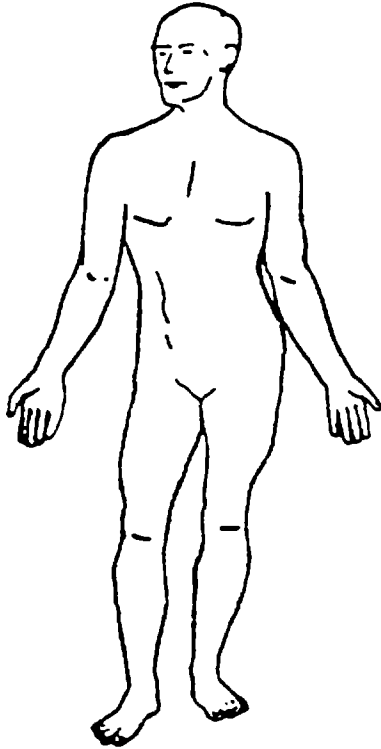

Skeletal Injuries

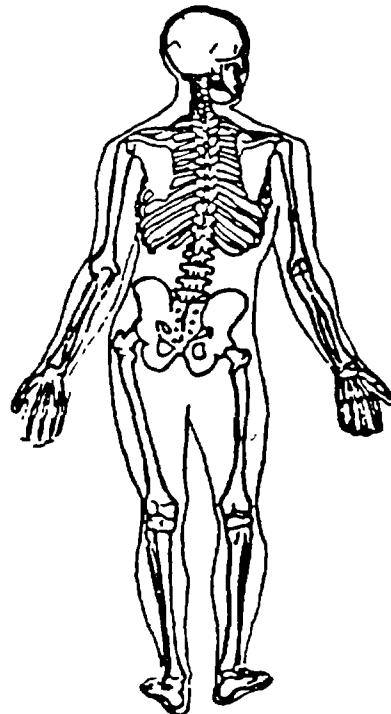
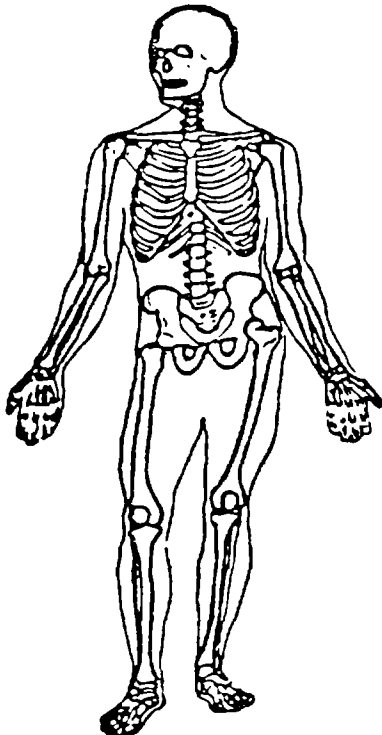

23 - 26 Blank (These variables are left blank so that numbering consistency can be maintained with compatible variables on the Occupant Data form.)

27. Relation of Interviewee to Pedestrian or Nonmotorist

- (0) No interview
- (1) Same person
- (2) Other accident involved person

Uninvolved Person

- (3) Relative or friend
- (4) Other uninvolved person

Combination of Persons

- (5) One of which was accident involved
- (6) None of which were accident involved
- (9) Unknown

31

THIS COMPLETES THE INTERVIEW

COMMENTS

OFFICIAL INJURY DATA

1. Location and Location of All Injuries

Soft Tissue Injuries

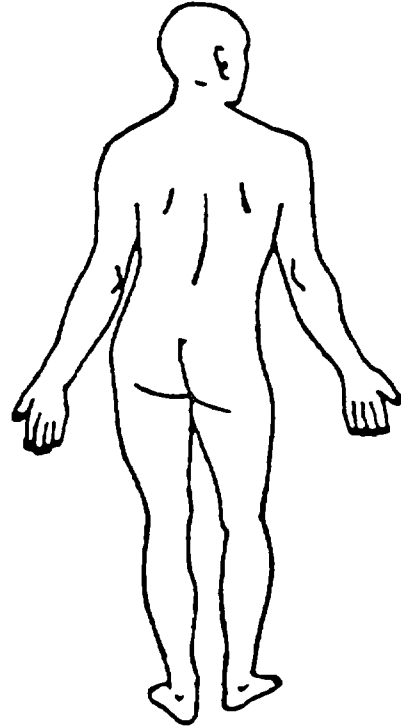
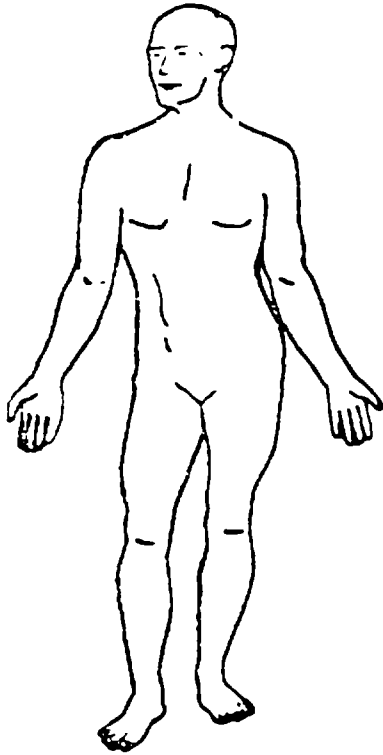

Skeletal Injuries

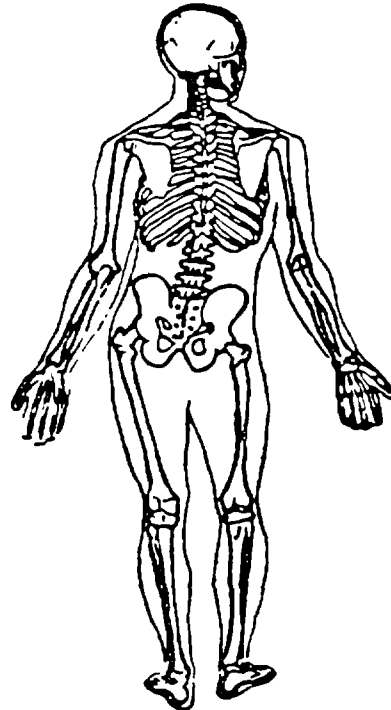
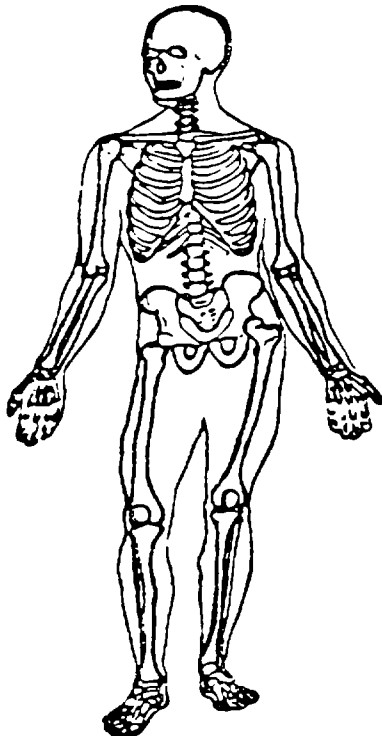

Write additional medical record injury information on reverse of this page.

OCCUPANT INJURY CLASSIFICATION (FOR PEDESTRIAN AND NONMOTORIST)

Injuries which are reported from both *unofficial* and *official* sources. The information from official sources takes precedence over similar information reported by any other source. In other words, do not list the same injury twice; supercede the interview data with official data in the case of similar injuries. List all injuries by official medical sources first. Police reported injuries may be used, but only when no other source of injury information is available.

Were more than ten (10) injuries sustained? _____ Unknown, _____ No, _____ Yes - If more than ten dissimilar injuries were identified during the interview, from collection of official data, and from other unofficial sources (excluding police), list those from the official records first, exhausting the source of data before listing those from the interviewee or other sources.

#	I.S.S. Body Region	O.I.C. Body Region	Aspect	Lesion	System/ Organ	A.I.S. Severity	Injury Source	Source of Data
1	—	—	—	—	—	—	—	—
2	—	—	—	—	—	—	—	—
3	—	—	—	—	—	—	—	—
4	—	—	—	—	—	—	—	—
5	—	—	—	—	—	—	—	—
6	—	—	—	—	—	—	—	—
7	—	—	—	—	—	—	—	—
8	—	—	—	—	—	—	—	—
9	—	—	—	—	—	—	—	—
10	—	—	—	—	—	—	—	—

- Source of Data**
- Official*
- (01) Autopsy records with or without hospital/medical records
 - (02) Hospital medical records other than emergency room (e.g., discharge summary)
 - (03) Emergency room records only (including associated x-rays or other lab reports)
 - (04) Private physician, walk-in or emergency clinic
- Unofficial*
- (05) Lay coroner report
 - (06) E.M.S. personnel
 - (07) Interviewee
 - (08) Other source
-
- (09) Police
 - (99) Unknown if injured
 - (00) Not injured

I.S.S. Body Region

- (1) Head or neck
- (2) Face
- (3) Chest
- (4) Abdominal or pelvic contents
- (5) Extremities or pelvic girdle
- (6) General (*external*)
- (0) Not injured
- (9) Unknown

O.I.C. Body Region

- (M) Abdomen
- (O) Ankle-foot
- (A) Arm (upper)
- (B) Back - thoracolumbar spine
- (C) Chest
- (E) Elbow
- (F) Face
- (R) Forearm
- (H) Head - skull
- (I) Injured, unknown region
- (K) Knee
- (L) Leg (lower)
- (Y) Lower limb(s) (whole or unknown part)
- (N) Neck - cervical spine
- (P) Pelvic - hip
- (S) Shoulder
- (T) Thigh
- (X) Upper limb(s) (whole or unknown part)
- (Q) Whole body
- (W) Wrist - hand
- (0) Not injured
- (9) Unknown if injured

Aspect of Injury

- (A) Anterior - front
- (C) Central
- (I) Inferior - lower
- (U) Injured, unknown aspect
- (L) Left
- (P) Posterior - back
- (R) Right
- (S) Superior - upper
- (W) Whole region
- (0) Not injured
- (9) Unknown if injured

Lesion

- (A) Abrasion
- (M) Amputation
- (V) Avulsion
- (B) Burn
- (K) Concussion
- (C) Contusion
- (N) Crush
- (G) Detachment, separation
- (D) Dislocation
- (F) Fracture
- (Z) Fracture and dislocation
- (U) Injured unknown lesion
- (L) Laceration
- (O) Other
- (P) Perforation, puncture
- (R) Rupture
- (S) Sprain
- (T) Strain
- (Γ) Total severance, transection
- (0) Not injured
- (9) Unknown if injured

System/Organ

- (W) All systems in region
- (A) Arteries - veins
- (B) Brain
- (D) Digestive
- (E) Ears
- (O) Eye
- (H) Heart
- (U) Injured, unknown system
- (I) Integumentary
- (J) Joints
- (K) Kidneys
- (L) Liver
- (M) Muscles
- (N) Nervous system
- (P) Pulmonary - lungs
- (R) Respiratory
- (S) Skeletal
- (C) Spinal cord
- (Q) Spleen
- (T) Thyroid, other endocrine gland
- (G) Urogenital
- (V) Vertebrae
- (0) Not injured
- (9) Unknown if injured

Abbreviated Injury Scale

- (1) Minor injury
- (2) Moderate injury
- (3) Severe injury
- (4) Serious injury
- (5) Critical injury
- (6) Maximum (*unireparable*)
- (7) Injured, unknown severity
- (0) Not injured
- (9) Unknown if injured

Product in Section

Injury Source	ROOF	EXTERIOR of STRIKING MOTOR VEHICLE
(00) No injury	(31) Front header	(71) Front bumper
FRONT	(32) Rear header	(72) Hood edge
(01) Windshield	(33) Roof side rails	(73) Other front of vehicle
(02) Mirror	(34) Roof or convertible top	(74) Hood
(03) Steering assembly, including transmission selector lever when column mounted	FLOOR	(75) Hood ornament
(04) Add-on equipment (e.g., CB, tape deck, air conditioner)	(41) Floor	(76) Windshield, roof rail, A-pillar
(05) Instrument panel and below, excluding foot controls and parking brake	(42) Floor or console mounted transmission lever, including console	(77) Side surface
(06) Sunvisor	(43) Parking brake handle	(78) Side mirrors
(09) Other front object	(44) Foot controls including parking brake	(79) Other side protrusions
SIDE	REAR	(80) Rear surface
(11) Side interior surface, excluding hardware or armrests	(45) Backlight (rear window)	(81) Undercarriage
(12) Side hardware or armrests	(46) Backlight storage rack, door, etc	(82) Tires and wheels
(13) A pillar	(49) Other rear objects	(83) Other exterior of striking motor vehicle
(14) B pillar	EXTERIOR of NONMOTORIST'S VEHICLE	(84) Unknown exterior of striking motor vehicle
(15) Other pillar	(51) Hood	OTHER VEHICLE or OBJECT in the ENVIRONMENT
(16) Window glass or frame	(52) Outside hardware (e.g., outside mirror, antenna)	(86) Ground
(19) Other side object	(53) Other exterior surface or tires	(87) Other vehicle or object
INTERIOR	(59) Unknown exterior objects	(89) Unknown vehicle or object
(21) Seat, back support	CYCLE	NONCONTACT INJURY
(22) Belt restraint system	(61) thru (69) Do Not Use.	(90) Noncontact injury source (impact force)
(23) Head restraint		(97) Injured, unknown source
(24) Air cushion		(99) Unknown if injured
(25) Other occupants		
(26) Interior loose objects		
(29) Other interior object		

(These code numbers are left blank so that numbering consistency can be maintained with compatible variables on the Occupant Data form.)

OCCUPANT INJURY CLASSIFICATION (FOR PEDESTRIAN AND NONMOTORIST)

If there are six or less injuries listed in the O.I.C. reduction section, code all of the injuries ordered by Source of Data (1st-autopsy, 2nd-hospital/medical, 3rd-emergency room, 4th-private physician, or 5th-unofficial sources) and by A.I.S. severity within source.

If there are more than six injuries order the injuries by source and by A.I.S. severity within source. Code this ordering, injury by injury. If a group of ordered injuries has the same source, the same A.I.S., and the group includes at least the sixth and seventh injuries in the ordering, then a choice must be made as to which injury or injuries to code.

Choose the injury or injuries that will enable the maximum number of different I.S.S. body regions to be represented in the coded data. If no new I.S.S. body region can be added, then simply code in accordance with the original ordering.

If the pedestrian or nonmotorist has less than six injuries, then the number of rows required to be completed is equal to the number of injuries plus one (e.g., no injuries requires one row, i.e., columns 32 to 40). In the additional row "no injury" will be coded for all variables including A.I.S. severity.

If you cannot increase the number of different ISS body regions or if you can choose between two or more injuries of the same source and AIS severity any of which would constitute an additional ISS region, then choose the injury that has a known injury source.

Update Candidate Yes No

1ST	ISS Body Region	O.I.C. Body Region	28.	29.	Aspect	30.	Lesion	31.	System/Organ	32.	A.I.S. Severity	33.	Injury Source	34.	Source of Data	Update Candidate			
																37	38	39	40
2ND	---	35.	41	36.	42	37.	43	38.	44	39.	45	40.	46	47	41.	48	49		
3RD	---	42.	50	43.	51	44.	52	45.	53	46.	54	47.	55	56	48.	57	58		
4TH	---	49.	59	50	60	51.	61	52.	62	53.	63	54.	64	65	55.	66	67		
5TH	---	56.	68	57.	69	58.	70	59.	71	60.	72	61.	73	74	62.	75	76		
6TH	---	63	77	64	78	65	79	66.	80	67	81	68.	82	83	69.	84	85		

Coding Section

COMPLETED BY TEAM

INTERVIEW CONTACT RECORD

<u>Contact Sequence</u>	<u>Month</u>	<u>Day</u>	<u>Year</u>	<u>Time of Contact</u>	<u>Contacting Investigator</u>	<u>Manner</u>	<u>Result</u>
	9.		10.		11.	12.	13.
1st	---	---	8	---	---	---	---
	14.		15.		16.	17.	18.
2nd	---	---	8	---	---	---	---
	19.		20.		21.	22.	23.
3rd	---	---	8	---	---	---	---
	24.		25.		26.	26.	28.
4th	---	---	3	---	---	---	---
	29.		30.		31.	32.	33.
5th	---	---	8	---	---	---	---
	34.		35.		36.	37.	38.
6th	---	---	8	---	---	---	---
	39.		40.		41.	42.	43.
7th	---	---	8	---	---	---	---
	44.		45.		46.	47.	48.
8th	---	---	8	---	---	---	---

LOG RESPONSES

Manner

- (1) Telephone
 - (2) Personal visit to home, work, etc.
 - (3) Letter (*questionnaire*)
 - (4) Other (*specify*)
-

Result of Last Contact Attempt

- (01) Unable to contact or locate
 - (02) Hit and run
 - (03) Fatal-surrogate not available
 - (04) In intensive care-surrogate not available
 - (05) Out of State resident
 - (06) Refused interview for other than on advice of attorney or insurance company (*specify*)
-

- (07) Insurance company refusal
 - (08) Attorney refusal or litigation
 - (09) Other (*specify*)
-

- (10) No return of letter questionnaire
 - (11) Return of letter questionnaire (completed)
 - (12) Partial or complete interview
-

Result of Contact Attempt Other than Last Contact Attempt

- (13) No answer (to phone call, no one home, etc.)
 - (14) Other person at home, work, etc.—Interviewee to contact investigator
 - (15) Other person at home, work, etc.—Investigator to repeat call, visit, leave questionnaire, or try elsewhere
 - (16) Must obtain permission of attorney or insurance company.
 - (17) Attorney or insurance company provided permission.
 - (18) Other (*specify*)
-

If any of the coded injury Sources have "other" codes, i.e., 09, 15, 19, 29, 49, 53, 69, 73, 79, 83 or 87; describe the injury source below in the space provided. Clearly indicate each description by numerical value.

POLICE REPORT

70. Injury Severity (Police Rating)

- ___ (0) No injury (O)
- ___ (1) Possible injury (C)
- ___ (2) Nonincapacitating injury (B)
- ___ (3) Incapacitating injury (A)
- ___ (4) Killed (K)
- ___ (5) Injury, severity unknown
- ___ (6) Died prior to accident
- ___ (9) Unknown 86

71. Traffic Violation Charged Against This Pedestrian or Nonmotorist

- ___ (0) No
- ___ (1) Yes (specify) _____
- ___ (9) Unknown 87

72. Police Reported Alcohol Presence

- ___ (0) No (alcohol not present)
- ___ (1) Yes (alcohol present)
- ___ (8) Not reported
- ___ (9) Unknown 88

POLICE, HOSPITAL/MEDICAL, OR OTHER OFFICIAL

73. Alcohol Test Result

- _____ Actual value (decimal implied before first digit) (0.xx)
- ___ (95) Test refused
- ___ (96) None given
- ___ (97) AC test performed, results unknown
- ___ (99) Unknown 89 90

74. Time of Death

- ___ (00) Not fatal
- _____ Code number of hours from time of accident to time of death up through 24 hours. If time of death is greater than 24 hours, code number of days. (Note 1 day = 31, 2 days = 32, n days = 30+n up through 30 days = 60)
- ___ (96) Fatal-ruled disease 91 92
- ___ (99) Unknown

75. 76. 77. Other Pedestrian/Nonmotorist Related Factors

- ___ (00) No other pedestrian/nonmotorist related factors
- Physical/Mental Condition**
- ___ (01) Non-physical (i.e., mental or emotional factor)
- Physical Impairments**
- ___ (02) Blind
- ___ (03) Restricted sight
- ___ (04) Walking cane/crutches required
- ___ (05) Deaf
- ___ (06) Restricted to wheelchair
- ___ (07) Paraplegic
- ___ (08) Previous injury
- ___ (09) Other physical impairments _____
- Drug Impairments**
- ___ (10) Drugs-medication (prescription, over-the-counter)
- ___ (11) Other drugs (excludes alcohol, includes uncontrolled substances): _____
- Operator Related Factors**
- Pedalcyclist Related (Includes Animal Related)**
- ___ (20) Inattention
- ___ (21) Interference with operator by other passenger
- ___ (22) Operator inexperience
- ___ (23) Unfamiliar with roadway
- ___ (24) Overloading or improper loading of vehicles with passengers or cargo
- ___ (25) Operating vehicle in erratic, reckless, careless or negligent manner
- ___ (26) Improper or erratic lane changing
- ___ (27) Failure to keep in proper lane or running off roadway
- ___ (28) Making improper entry to or exit from trafficway
- ___ (29) Failure to yield right-of-way
- ___ (30) Failure to obey traffic signs, traffic control devices or traffic officers, failure to observe Safety Zones
- ___ (31) Failure to signal intentions
- ___ (32) Giving wrong signal
- ___ (33) Making right turn from left lane, making left turn from right lane
- ___ (34) Making other improper turn
- ___ (35) Driving wrong way on one-way roadway
- ___ (36) Driving on wrong side of roadway
- ___ (37) Failure to have lights on when required
- Pedestrian Related (Includes Other Nonmotorist)**
- ___ (38) Not seen by driver
- ___ (39) Darting or running into roadway
- ___ (40) Improper crossing of roadway or intersection
- ___ (41) Walking with or against traffic, playing, working, sitting, lying, standing, etc. in roadway
- ___ (42) Holding onto vehicle
- ___ (98) Other _____ (75) 93 94
- ___ (99) Unknown (76) 95 96
- (77) 97 98

COMPLETED BY TEAM	
1. Primary Sampling Unit Number	1 2
2. Case Number - Stratification	3 4 5 6
3. Record Number	7 2
4. Transaction Code	8
5. Version Number	7 9
6. Investigator I.D. Number	10

PEDESTRIAN OR NONMOTORIST INTERVIEW	
7. Pedestrian or Nonmotorist's Number	11 12
8. Manner of Last Contact Attempt	
(1) Telephone	
(2) Personal visit to home, work, etc.	
(3) Letter (questionnaire)	
(4) Other (specify) _____	13
9. Result of Last Contact Attempt	
(01) Unable to contact or locate	
(02) Hit and run	
(03) Fatal-surrogate not available	
(04) In intensive care-surrogate not available	
(05) Out of State resident	
(06) Refused interview for other than on advice of attorney or insurance company (specify) _____	
(07) Insurance company refusal	
(08) Attorney refusal or litigation	
(09) Other (specify) _____	
(10) No return of letter questionnaire	
(11) Return of letter questionnaire (completed)	
(12) Partial or complete interview	14 15
10. Date Interview Completed	16 17 18 19 20 21 8
11. Completing Person	22
12. Source of Interview Data	
(1) No data obtained	
(2) Same person	
(3) Other accident involved person	
(4) Relative or friend	
(5) Eyewitness	
(6) Combination of 3, 4 or 5	
(7) Other (specify) _____	23

13. Reasons Medical Data Not Obtainable	
(00) Not medically treated	
(01) Record obtained	
(02) No record of treatment at medical facility	
(03) Medical release required-not obtained	
(04) Nonaccident related injury	
(05) Noncooperative hospital	
(06) Hospital out of study area	
(07) Private physician would not release information	
(08) To be updated	
(09) Record not received before file closed	
(10) Unknown if medically treated	24 25

COMPLETED BY ZONE CENTER	
14. Date Medical Record Update Received	26 27 28 29 30 31 8
15. Reviewed By	32 33
16. Interviewee Injury Documentation	
(1) Complete-Injury descriptions are annotated in sufficient detail to enable independent OIC/AIS coding. The protocol for completing the injury diagram has been used and a contact mechanism or "unknown" is indicated.	
(2) Partial-All coded injuries are described in adequate detail, however, additional annotation helpful for independent OIC/AIS coding. Contact mechanism omitted for some injuries.	
(3) Incomplete-Generally inadequate description of injuries or the coded injury does not correspond to the annotated injury.	
(4) NA-No interviewee reported injuries.	34
17. Official Injury Documentation	
(1) Complete-All injuries reported in the medical data are annotated with sufficient detail to enable an independent OIC/AIS coding. The protocol for completing the injury diagram has been used.	
(2) Partial-All coded injuries are described in adequate detail, however, additional annotation helpful for independent OIC/AIS coding. Some minor injuries described in the medical data may be omitted.	
(3) Incomplete-Generally inadequate or erroneous descriptions of injuries and/or omitted major injuries described in the medical data.	
(4) NA-No official medical data	35



PEDESTRIAN AND NONMOTORIST FORM UPDATE RECORD

This section must be completed prior to initial case submission

1 Primary Sampling Unit Number	1	2
2 Case Number-Stratification	3	4 5 6
3 Record Number	7	8
4 Transaction Code	9	10
5 Version Number	11	12
6 Investigator I.D. Number		
7 Pedestrian or Nonmotorist's Number		

PEDESTRIAN or NONMOTORIST'S NAME _____

Address _____ Age _____

(Delete before submission)

10 Sex _____

DATA ON INITIAL SUBMISSION

A08. Final Stratification _____

20. Treatment-Mortality _____

21. Hospital Stay _____

22. Working Days Lost _____

74. Time of Death _____

ENTER RESPONSE FOR EACH VARIABLE WHERE DATA ON INITIAL SUBMISSION WAS UNKNOWN OR IS FELT TO BE IN ERROR, GIVEN RECEIPT OF OFFICIAL MEDICAL RECORD(S)

A08. Final Stratification	17
9 Pedestrian or Nonmotorist's Age	14 15
10 Pedestrian or Nonmotorist's Sex	16
20 Treatment-Mortality	26
21. Hospital Stay	27 28
22. Working Days Lost	29 30

COMPLETE PRIOR TO INITIAL CASE SUBMISSION

INJURY DATA CODED ON INITIAL SUBMISSION

28 ___ 29. ___ 30 ___ 31. ___ 32. ___ 33. ___ 34 ___

35. ___ 36. ___ 37. ___ 38. ___ 39. ___ 40. ___ 41. ___

42 ___ 43 ___ 44 ___ 45. ___ 46 ___ 47. ___ 48. ___

49. ___ 50. ___ 51. ___ 52. ___ 53. ___ 54 ___ 55. ___

56. ___ 57 ___ 58. ___ 59. ___ 60. ___ 61. ___ 62. ___

63. ___ 64. ___ 65. ___ 66 ___ 67. ___ 68. ___ 69. ___

UPDATED INJURY DATA BASED ON SUBSEQUENTLY ACQUIRED OFFICIAL MEDICAL DATA
[or reason data not obtained (see response for log variable 13) ___]

1st	28	32	29.	33	30	34	31	35	32.	36	33.	37	38	34.	39	40
2nd	35.	41	36.	42	37.	43	38	44	39.	45	40.	46	47	41.	48	49
3rd	42	50	43.	51	44.	52	45.	53	46.	54	47.	55	56	48	57	58
4th	49	59	50.	60	51.	61	52	62	53.	63	54.	64	65	55.	66	67
5th	56.	68	57.	69	58.	70	59	71	60.	72	61.	73	74	62	75	76
6th	63.	77	64.	78	65.	79	66.	80	67.	81	68.	82	83	69.	84	85
73. Alcohol Test Results	89	90	74 Time of Death	91	92											

INDICATE THE NATURE AND LOCATION OF ALL INJURIES FROM THE OFFICIAL MEDICAL REPORT(S) ON THE REVERSE SIDE AND ATTACH THE REPORT(S) TO THIS UPDATE

OFFICIAL INJURY DATA

Indicate the *Nature* and *Location* of All injuries.

Soft Tissue Injuries

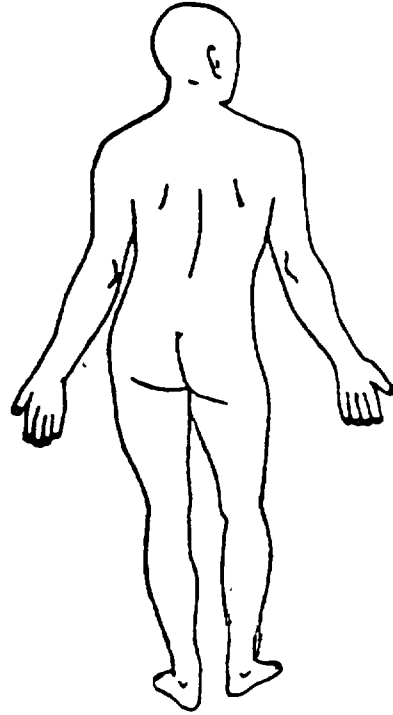
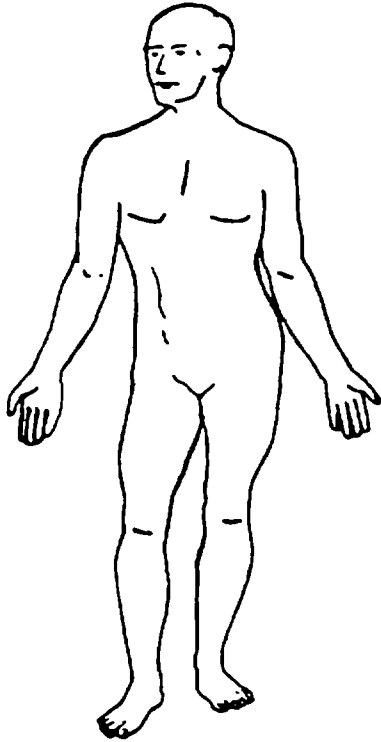

Skeletal Injuries

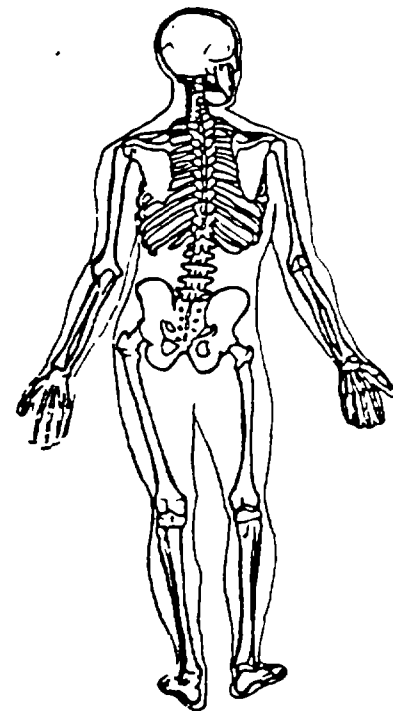
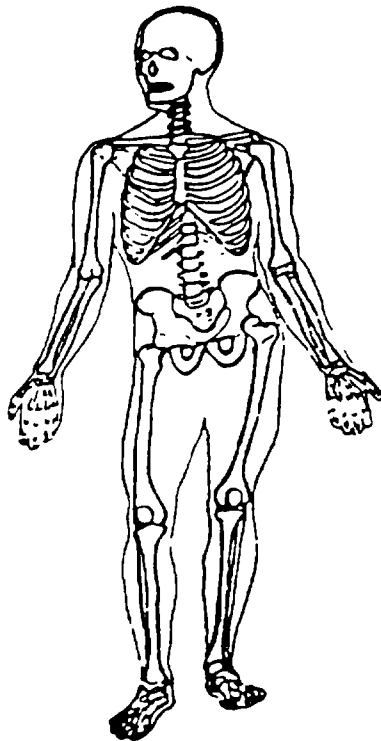

PEDESTRIAN & NONMOTORIST FORM

P06

Variable Name: Investigator I.D. Number

Format: 1 column - numeric

Beginning
Column 10

Element Values:

Level 1 Range: 0 through 9

Source: Zone center.

Remarks:

The person who was primarily responsible for the completion of this Pedestrian and Nonmotorist Form shall enter his/her unique number.

Each investigator's unique number is assigned by the PSU's Zone Center.

This variable is a mandatory variable and cannot be changed.

Variable Name: Pedestrian or Nonmotorist's Number

Format: 2 columns - numeric

Beginning
Column 11

Element Values:

Level 1 Range: 01 through 25

Source: Investigator assigned.

Remarks:

Numbers assigned to pedestrians or nonmotorists must be consecutive starting with "01"; no numbers may be skipped. Where two or more pedestrians or nonmotorists can be associated with a vehicle [motor or other (see ANSI D16.1-1976, section 2.2.8, page 5)], pedalcycle, or nonmotorist conveyance (any human-powered device designed for transporting people), assign their numbers in sequence.

The driver (person with steering control) of a pedalcycle is assigned the lowest number sequentially of any of the pedalcyclists specific to that unit (e.g., a pedalcycle for two). The pedalcyclist in front has steering control and therefore is the driver with Pedestrian or Nonmotorist's Number (P07) "01"; the other pedalcyclist in the rear is the passenger with Pedestrian or Nonmotorist's Number (P07) "02".

Numbers assigned to nonmotorists in motor vehicles not in transport are assigned sequentially left to right and front to back beginning in the enclosed area. Assign numbers last to those persons in or on unenclosed areas.

This variable is a mandatory variable and cannot be changed.

Variable Name: Pedestrian or Nonmotorist's Type

Format: 1 column - numeric

Beginning
Column 13

Element Values:

- 1 Pedestrian
- 2 Bicyclist
- 3 Other cyclist (specify)
- 4 Occupant of an animal related nonmotor vehicle transport device
- 5 Occupant of vehicle not in transport
- 8 Other nonmotorist (specify)
- 9 Unknown

Source: Investigator determined--inputs include the vehicle inspection, interviewee, and the police report.

Remarks:

A Pedestrian ("1") is defined as any person who is on a trafficway or on a sidewalk or path contiguous with a trafficway, and who is not in or on a nonmotorist conveyance. This includes persons who are in contact with the ground, roadway, etc., but who are holding onto a vehicle.

A nonmotorist conveyance is defined as any human-powered device by which a nonmotorist may move, or by which a pedestrian or nonmotorist may move another nonmotorist, other than by pedaling. A nonmotorist conveyance includes the following: baby carriage, coaster wagon, ice skates, roller skates, push cart, scooter, skate board, skis, sled, wheel chair, rickshaw, etc. This includes those persons in a nonmotorist conveyance who hold onto a motor vehicle in motion. Excluded are pedalcyclists.

Bicyclist ("2") refers to only those pedalcyclists who were either a driver or passenger on a bicycle. This includes those bicyclists who hold onto a motor vehicle in motion.

Code "3" (Other cyclist) refers to all other pedalcyclists. This includes those pedalcyclists who hold onto a motor vehicle in motion.

Code "4" (Occupant of an animal related nonmotor vehicle transport device) means that the nonmotorist was either riding on an animal or in an animal-powered conveyance.

Code "5" (Occupant of vehicle not in transport) represents those persons in or on a motor vehicle which is not in transport when struck.

PEDESTRIAN & NONMOTORIST FORM

P08

(2)

Variable Name: Pedestrian or Nonmotorist's Type (cont.)

Other nonmotorist ("8") includes any other person not included under the above definitions of a pedestrian, bicyclist, other cyclist, occupant of an animal related nonmotor vehicle transport device, or occupant of a motor vehicle not in transport. Annotate in the space provided a description of the nonmotorist type.

PEDESTRIAN & NONMOTORIST FORM

P09

Variable Name: Pedestrian or Nonmotorist's Age

Format: 2 columns - numeric

Beginning
Column 14

Element Values:

Level 1 Range: 00 through 97, 99
00 Less than one year old
97 97 years and older
99 Unknown

Source: Primary source is interviewee; secondary sources include police report and official records (e.g., medical, license).

Remarks:

Age is recorded at time of accident with respect to the pedestrian's or nonmotorist's last birthday.

PEDESTRIAN & NONMOTORIST FORM

P10

Variable Name: Pedestrian or Nonmotorist's Sex

Format: 1 column - numeric

Beginning
Column 16

Element Values:

- 1 Male
- 2 Female
- 9 Unknown

Source: Primary source is interviewee; secondary sources include police report and official records (e.g., medical).

Remarks:

Self-explanatory.

Variable Name: Pedestrian or Nonmotorist's Height

Format: 2 columns - numeric

Beginning
Column 17

Element Values:

Level 2 Range: 12 through 85 inches
99 Unknown

Source: Investigator determined--inputs include interviewee or official records (e.g., medical).

Remarks:

Code actual height to the nearest inch.

The PAR may be used as a source if it contains this data, but it is superceded if other data exists.

PEDESTRIAN & NONMOTORIST FORM

P12

Variable Name: Pedestrian or Nonmotorist's Weight

Format: 3 columns - numeric

Beginning
Column 19

Element Values:

Level 2 Range: 005 through 300 Pounds
999 Unknown

Source: Investigator determined--inputs include interviewee or official records (e.g., medical).

Remarks:

Code actual weight to the nearest pound.

The PAR may be used as a source if it contains this data, but it is superceded if other data exists.

Variable Name: Months Cycling Experience

Format: 2 columns - numeric

Beginning
Column 22

Element Values:

Level 1 Range: 00-61, 99

Code actual months of previous cycling experience up to 60

00 Noncyclist

61 Greater than 60 months (5 years)

99 Unknown

Source: Interviewee.

Remarks:

Code to the nearest month all current and/or previous months of cycling experience for the type of pedalcycle the nonmotorist operator was riding (e.g., bicycle, unicycle, etc.). Included are operators of children's tri-cycles.

Noncyclist ("00") is coded for all pedestrians, occupants of an animal related nonmotor vehicle transport device, occupants of vehicles not in transport, other nonmotorists, and passengers, if present, on a pedalcycle.

Note that 44 days or less equals one month: a month and a half equals two months.

PEDESTRIAN & NONMOTORIST FORM

Sub/P13 (1)

Form Pages 1 & 2

PEDESTRIAN/NONMOTORIST' DESCRIPTION OF ACCIDENT SEQUENCE

The interviewee should be allowed to give his/her complete narrative description of the accident sequence, without interruption. A synopsis of this uninterrupted description should be entered into the appropriate space on page 1. If additional space is required, use the back of page 1.

Specific questions should be entered in the space on page 1 or if additional space is needed on the back of page 1 usually prior to the time the interview is conducted. These questions should be asked after the interviewee has given his/her complete narrative. In some cases the interviewee will answer the specific questions during his/her narrative description of the accident.

Specific questions do not include those required, during the interview, to clarify statements made by the interviewee. If an interviewee makes a statement during the interview which is not clear as to its meaning, the interviewee should be queried for a more definitive answer to allow proper coding of the data.

ACCIDENT DIAGRAM

The accident diagram (page 2) should be completed as described by the interviewee. Investigator input (as far as accident dynamics are concerned) should not be used in completing the diagram. It should be drawn as described by the interviewee and the erroneous areas noted. Impact and final rest positions as well as vehicle and pedestrian/nonmotorist orientations should be documented in relation to an identifiable object/point in the environment. Pre-crash, crash, and post-crash headings of the involved vehicles and pedestrian/nonmotorist (when applicable) should also be documented relative to an environmental feature (i.e., road edge) and Magnetic North. Any related factors in the accident (e.g., parked/stopped vehicles) should also be properly placed in the diagram. These data may be needed for the final reconstruction of the accident.

Variable Name: Pedestrian or Nonmotorist's Location

Format: 2 columns - numeric

Beginning
Column 24

Element Values:

- 01 Intersection related - in crosswalk
- 02 Intersection related - on roadway, not in crosswalk
- 03 Intersection related - on roadway, crosswalk not available
- 04 Intersection related - on roadway, crosswalk availability unknown
- 05 Intersection related - not on roadway
- 09 Intersection related - unknown
- 10 Nonintersection - in crosswalk
- 11 Nonintersection - on roadway, not in crosswalk
- 12 Nonintersection - on roadway, crosswalk not available
- 13 Nonintersection - on roadway, crosswalk availability unknown
- 14 Nonintersection - in parking lane
- 15 Nonintersection - on road shoulder
- 16 Nonintersection - bike path
- 17 Nonintersection - outside trafficway
- 18 Nonintersection - other, not on roadway (specify: _____)
- 19 Nonintersection - unknown
- 99 Unknown

Source: Investigator determined--inputs include scene inspection, interviewee, and police reports.

Remarks:

Select the value which best represents the location of the pedestrian or nonmotorist at the time of impact.

To code "intersection related" ("01" through "05", and "09") the pedestrian or nonmotorist must have been struck in the area formed by the junction of two or more trafficways. If the pedestrian was struck in the intersection (of the roadways), or in the crosswalks, sidewalks, or islands within the junction of the trafficways, use these codes.

A crosswalk is defined as a marked area (generally delineated by solid white lines) used by pedestrians when crossing a roadway. The crossing area must be marked (delineated) to be classified as a crosswalk for the purpose of this variable.

The remaining codes ("10" through "19") are applicable to accidents occurring in a nonintersection area, (i.e., not within the junction of two or more trafficways).

PEDESTRIAN & NONMOTORIST FORM

P14

(2)

Variable Name: Pedestrian or Nonmotorist's Location (cont'd.)

Nonmotorists who are occupants of a motor vehicle not in transport are coded with respect to the location of the vehicle.

Code "16" (Nonintersection - bike path) refers to any officially designated path or lane (on or off the road but not within the junction of two or more trafficways) on which pedalcyclists have preference. This includes those lanes which are bimodal if the accident occurs when they convert from motor vehicle to pedalcycle (e.g., weekends). For the purpose of this variable, all bike paths, if marked, are considered off roadway.

Code "18" (Nonintersection - other, not on roadway) should be used whenever the pedestrian or nonmotorist is struck on the "roadside," (i.e., within the trafficway but not on the "road" and not within the junction of two or more trafficways).

Variable Name: Pedestrian or Nonmotorist's Location (cont'd.)

The following coding decision tree should be used to facilitate the proper coding of this variable. Items not previously defined in this manual follow the diagram.

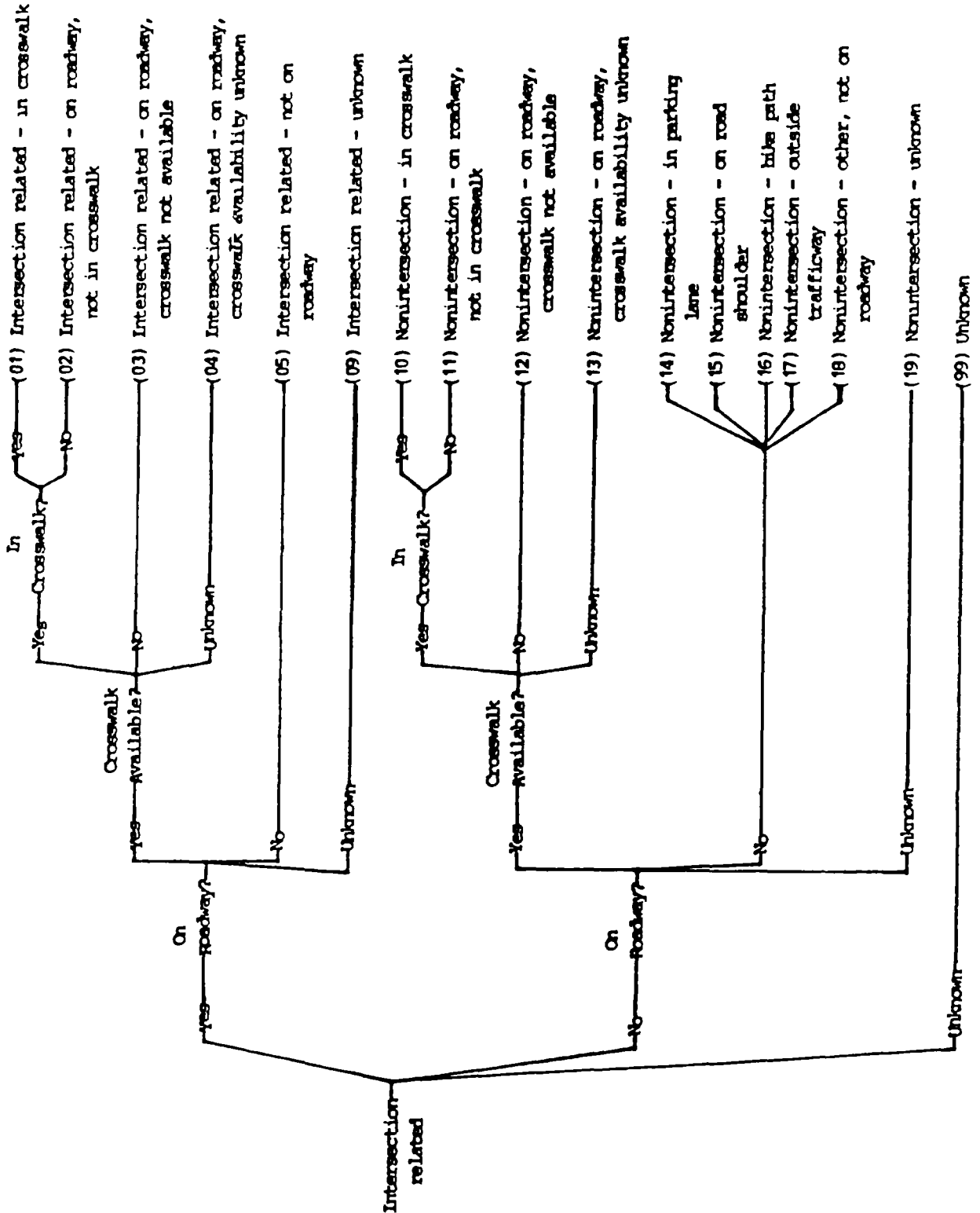

PEDESTRIAN & NONMOTORIST' FORM

P15 - P19

These variables are left blank so that numbering consistency can be maintained with compatible variables on the Occupant Data Form.

Variable Name: Treatment - Mortality

Format: 1 column - numeric

Beginning
Column 26

Element Values:

- 1 Fatal
- 2 Fatal - ruled disease
Nonfatal
- 3 Hospitalization
- 4 Transported and released
- 5 Treatment - other (specify)
- 6 No treatment
- 9 Unknown

Source: Investigator determined--inputs include interviewee, police report, and medical records.

Remarks:

Official sources (if they exist) take precedence over interview data.

Code "1" (Fatal) when death occurs within 30 days of accident. Death must have occurred as a consequence of injuries sustained in the traffic accident.

Code "2" (Fatal - ruled disease) is used in two situations. The first is when the effects of a disease can be deemed as a cause of the accident. Cause means that the on-set of the disease occurred prior to the first harmful event. When determining the time of on-set (relative to the first harmful event), the investigator can use any information source available. The investigator makes his/her determination after weighing all the evidence. (NOTE: The use of all available information sources is restricted to the determination of when the on-set occurred.) Additionally, code "2" (Fatal - ruled disease) is used when a medical examiner (or other official vested by the state to verify the cause of death) or an official medical report verifies that the death resulted from either (1) a diseased condition, or (2) not from accident related injuries.

Code "3" (Hospitalization) when hospitalization occurs as a result of injury (need not be taken directly to a hospital). See Hospital Stay (P21) for hospitalization criteria. Also, use this code if a person is treated and released then subsequently hospitalized as a result of injuries sustained in the accident.

Code "4" (Transported and released) when the person went directly from the accident scene to a treatment facility (hospital, clinic, doctor's office,

Variable Name: Treatment - Mortality (cont'd.)

etc.), and the person is examined for injuries at the facility. The person need not have been injured. The means of transportation is not a consideration.

Code "5" (Treatment - other) includes doctor treatment, treatment at scene, first aid) self-treatment, hospital (if other than directly from scene but treated and released), etc.

Code "6" (No treatment) includes persons transported to a hospital but who refuse treatment. As long as there was transportation directly from the scene, a refusal of treatment will not, on its own, affect the Final Stratification (A08) of the case.

If a person survives the injuries and receives treatment at a hospital, but is not admitted for hospitalization, that person's treatment is to be coded as either "4" or "5", depending upon whether the person went directly or indirectly to the hospital. It does not matter if the person is treated for one hour or twelve, only that the person is released following treatment. Nor does it matter if the treatment begins prior to midnight and spans into the following day.

Variable Name: Hospital Stay

Format: 2 columns - numeric

Beginning
Column 27

Element Values:

Level 1 Range: 00-61, 99
00 Not hospitalized
Code number of days hospitalized up to 60
61 61 days or more
99 Unknown

Source: Investigator determined--inputs include interviewee and medical reports.

Remarks:

Official sources (if they exist) take precedence over interview data.

Code "00" (Not hospitalized) if not injured or injured but not admitted.

Code "00" (Not hospitalized) if fatal at scene, pronounced dead on arrival, or survival does not extend beyond the emergency room.

The basis for the number of days coded is an overnight criterion. Every time a person remains past midnight subsequent to admission, it is one day. The only exception is when a person dies on the same day as the admission.

In the event that the person survives the emergency room but dies subsequent to admission, then code at least "01", even if the person expires the same day as admitted.

If a person is admitted, lives four days in the hospital, then expires, code "04".

Variable Name: Working Days Lost

Format: 2 columns - numeric

Beginning
Column 29

Element Values:

Level 1 Range: 00-62, 99

00 No working days lost

Code number of days for which work was lost up through 60

61 61 days or more

62 Fatally injured

99 Unknown

Source: Primary source is the interviewee; a secondary source is the person's employer.

Remarks:

Report the actual number of "work" days lost due to the accident by an employed person or a full-time college student. Children, adolescents, retirees, or unemployed persons are not included.

Employed is defined to mean that the person was scheduled to work at least four hours on each of the days lost. Each such day is counted as a full day so long as the person was scheduled to work at least four hours on the day lost. Do not accumulate the hours and convert to equivalent full-time days; however, indicate on the form if the person works less than full-time but greater than four hours per day by annotating "part-time" or "PT".

If during the interview a reasonable projection of future days lost can be made, then add those days to those already known to have been lost. If a reasonable projection cannot be made, then code "99" (Unknown).

The days lost need not be due to injury.

Days lost include Saturdays, Sundays, afternoon and evening shifts if so scheduled. Do not count double shifts or days at time and one-half pay, etc., as more than one day.

If a person is not employed, not a full-time college student, or works less than four hours per day, then code "00" (No working days lost). This code includes all persons (except fatals) who do not qualify to lose working days.

PEDESTRIAN & NONMOTORIST FORM

P22
(2)

Variable Name: Working Days Lost (cont'd.)

If a person is fatal - ruled disease, fatal at scene, pronounced dead on arrival, or survival does not extend beyond the emergency room then code "62" (Fatally injured) is used.

If a person expires within thirty days following the accident, code "62" regardless of whether or not the person missed any working days.

If the reported work days lost includes a fraction, round one-half (1/2) day or greater up to a whole day. Less than one-half day should be excluded (rounded down).

If someone gets fired and loses their job as a result of the accident, count only the work days lost between the accident and the date of termination, inclusive.

Do not include days lost by persons who were not directly involved in the accident but who lost days because of it (e.g., husband was not in accident but stayed home to take care of wife who was injured and required assistance).

If no interview is obtained, there is a rebuttable presumption that persons over 65 or under 17 are not employed full-time; for these persons code "00" (No working days lost) should be used, unless the person is fatally injured [codes "1" (Fatal) or "2" (Fatal - ruled disease) for P20, Treatment - Mortality].

Injury Data From Interviewee

This page is separated into four body diagrams: front and back soft tissue injuries and front and back skeletal injuries. These diagrams allow the documentation of all injuries sustained by a pedestrian or nonmotorist in the accident, as stated by the interviewee.

The nature, location, and injury source should be documented as follows:

- Nature - As stated by the interviewee document the lesion sustained (e.g., laceration, fracture, concussion, etc.) and its extent (e.g., size, severity, depth, etc.). The terms used by the interviewee may not necessarily coincide with the terms found in the OIC, but the injury should be documented as stated by the interviewee for ease of completion of this form during the interview. Length of unconsciousness, or state of consciousness on first observation by a medical specialist, and whether unconsciousness was a result of a head contact, should be noted.
- Location - The location of the injury, as stated by the interviewee, should be documented in two ways:
- By arrows, shading, bracketing (for large areas) on the body diagram; or
 - By written description (e.g., left lower arm, right third rib, etc.). The written description may be abbreviated to aid in completion of the page during the interview. Refer to the Injury Coding Manual for standard abbreviations and symbols.
- Source - The interviewee should be queried as to the source of the injury. This information gained from the interviewee may aid in the final coding of injury source in variables P33, P40, P47, P54, P61 and P68 and in the vehicle inspection (if not done previous to interview), and accident reconstruction. The injury source should be written immediately below the nature and written location of the injury and delineated by a horizontal line. If the interviewee does not know the source of the injury, unknown should be documented on the form.

PEDESTRIAN & NONMOTORIST FORM

P23 - P26

These variables are left blank so that numbering consistency can be maintained with compatible variables on the Occupant Data Form.

Variable Name: Relation of Interviewee to Pedestrian or Nonmotorist

Format: 1 column - numeric

Beginning
Column 31

Element Values:

- 0 No interview
- 1 Same person
- 2 Other accident involved person (specify)
Uninvolved Person
- 3 Relative or friend
- 4 Other uninvolved person (specify)
Combination of Persons
- 5 One of which was accident involved
- 6 None of which were accident involved
- 9 Unknown

Source: Element chosen

Remarks:

There is a presumption that the interviewee(s), other than the pedestrian or nonmotorist under consideration (i.e., surrogate codes "2"- "6"), will have sufficient familiarity with the pedestrian or nonmotorist to answer most questions relative to this person's demographic characteristics, treatment-mortality, hospitalization, working days lost, and extent of injuries. Conversely, individuals whose association with this person is limited to and a result of the accident, are presumed to have an insufficient basis for answering the preceding questions.

PEDESTRIAN & NONMOTORIST FORM

Sub/P27
(1)
Form Page 5

Official Injury Data
Specific Medical Record Data Used in Coding OIC/AIS

The official injury data page contains the four body diagrams previously seen on page 3 (Injury Data from Interviewee). The same guidelines should be used to document the nature and the locations of all injuries, but medical records will be used as the only source of information. At times, the medical records will also aid in the determination of source of injuries (e.g., glass in wound) and should be documented on this page as stated in the description of source of injury for page 3.

On the official injury data page the injuries should be clearly and precisely located on the diagrams and the medical record classification of the injury and its extent should be completely annotated. All data used to code the OIC/AIS of injuries [e.g., size of lacerations, level of consciousness on first observation by a medical authority, length of unconsciousness, loss of consciousness, size of hematoma or hemothroax (in cc of blood), etc.], should be written with the diagram or, if the description is too long, written on the additional medical record data used in coding OIC/AIS (reverse of page 5).

NASS Injury Coding Conventions

1. If an AIS is determined to be one of two consecutive numbers, but a clear indication cannot be made after reviewing all the information provided, assign the lower AIS.,
Uncertainty Rule #1—code lower
2. When there is uncertainty about the location of minor multiple abrasions, contusions and lacerations to the body surface, they should be aggregated, regardless of their location(s), and the code OW__-1 should be used.
Uncertainty Rule #2—whole body
3. If the medical or interview information indicates a contused knee, elbow, wrist, ankle, etc., and does not specifically state whether the contusion is to the bone or joint, code the injury as integumentary, __CI-1. If the contusion is known to be to the bone, use __CS-; if to the joint, use __CJ-. Example: contused knee, K.CI-1.
Uncertainty Rule #3—most superficial system if unknown system/organ
4. Cervical spine strain may, in some cases, still be referred to as "whiplash". "Whiplash" is not a medical term and is not used in AIS-80. If an injury is described as "whiplash", it should be coded as cervical spine acute strain, no fracture or dislocation, NPIM-1.
"Whiplash" NPIM-1
5. All internal structures of the mouth, with the exception of the teeth, are coded as part of the digestive system (D). Teeth are coded as skeletal (S).
Mouth - teeth = D
6. Body region code 0 (whole body) should be used only if 50% or more of the whole body surface (0) is affected. An exception is made for burns affecting more than one body region (see below). Aspect code W (whole region) is used only if 50% or more of the body region is affected.
50% rule
7. If a lesion involves more than one aspect of a body region:
 - a. Try to determine if one of the aspects is predominant. If so, code that aspect.
 - b. If not, use the aspect code W (whole).Aspect Whole (W) Code
8. Burn injuries should be coded using the following guidelines:
Burn injuries and the rule of nines
 - a. If only one body region is burned, use that body region code (e.g., ARBI-1, burned right upper arm 1°).
 - b. If more than one body region is burned, but a single injury code will adequately describe the regions affected, use the single injury code (e.g., XRBI-2, burned right whole arm 2°).
 - c. If more than one body region is burned and one injury code cannot be used to specify the body regions involved, the injury is coded OWBI-_. This will be the most likely case in coding burns.
 - d. The Rule of Nines is used in the AIS severity level for (a), (b), and (c) above. See the Rule of Nines diagram.

9. The following definitions have been used traditionally to differentiate "sprain" and "strain" injuries:

Strain versus
sprain

sprain - a joint injury which causes pain and disability depending on the degree of injury to ligaments and muscle tendons near the joint.

strain - an injury to a muscle or musculotendinous unit that results from overstretching and may be associated with a sprain or fracture.

In common medical practice, however, physicians often do not adhere strictly to these definitions, and may use the terms interchangeably. AIS-80 distinguishes sprains from strains. Care should be exercised in selection of the proper code, use __ SJ for sprains and __ TM-1 for strains.

Neck injuries may sometimes be described as "strains" and sometimes as "sprains". For NASS purposes, neck injuries should be coded as "strains" (see above definitions).

No sprains to neck

10. Integumentary lesions to the forehead are coded "face superior", or FS __ - __ in the NASS Injury Coding Manual. Fractures to the frontal bone are coded Head Anterior (HAFS-__).

Coding the fore-
head

11. Coding of substantiated anatomic lesions to the brain:

Anatomic Brain
Lesions

- a. If there are no substantiated anatomic lesions to the brain, the OIC and AIS will be coded as they appear in the Non-Anatomic Injuries section (see HEAD, Part C, Non-Anatomic Injuries).
- b. If only one substantiated anatomic lesion to the brain and the length of unconsciousness are known, the OIC will consist of the four letters describing the injury as it is specified in the "Anatomic Injuries" section (see HEAD, Part B, Anatomic Injuries). The AIS assigned will be determined by comparing: (1) the AIS which accompanies the specified injury in the "Anatomic Injuries" section, with (2) the AIS of the comparable injury in the "Non-Anatomic Injuries" section. The higher of the two AIS scores will be the one coded.
- c. If there are two or more substantiated anatomic lesions to the brain, the OIC and the AIS will be coded as they appear in the "Anatomic Injuries" section.

12. "Friction Burns" are to be coded as abrasions. The same criteria for assigning AIS applies (see definitions of abrasion - major and superficial, in the Glossary). If there is information as to the degree (e.g., 1°, 2° or 3°) code: AIS = 1 for 1°, 2° or unspecified, AIS = 2 for 3°.

Friction Burns

13. When an injury is described as a " type of laceration" (e.g., avulsion tpe laceration, flap laceration) use the "L" (laceration) lesion code. For all ambiguous situation use "laceration" over puncture, perforation, or avulsion.

Laceration Type
Injuries

14. A single compression fracture of the spine involving > 1 vertebra and overlapping adjacent regions of the spine is to be coded as one injury (i.e., one line of code). Choose the more superior of the two regions for the aspect code. Compression Fractures
15. For axilla (armpit) injuries code the Body Region for whatever can be determined to be nearest; A (arm), C (chest) or if in between S (shoulder). If unknown or unspecified use A (arm). Axilla Injuries
16. When "closed head injury," "head trauma," or other ambiguous phrase is the only information available, code HUUU-7. Closed Head Injury
17. The AIS codes individual injuries only. Injuries to body parts which are present on both sides of the body (bilateral) are coded as two separate injuries. It should be remembered that within the OIC "Aspect" measures the location of the injury being reported. Therefore, bilateral is not used to code the occurrence of hemo- or pneumothorax (results) present bilaterally. Instead, an upgraded AIS will account for the presence of bilateral results. Bilateral Limited
18. The distinction in coding individual skull fractures versus subsuming them under the crush classification lies in the displacement of brain tissue. If it can be determined that brain matter is forcibly extracted or moved from the cranium in conjunction with extensive fracturing, then the term "crushed skull" is applicable. Lack of specificity regarding the displacement of brain tissue tells the coder not to use the crush code and to code the fracturing as individual injuries. An HUUU-7 may be added if brain injuries are present but not specifically described. Crushed Skull
19. In the absence of other medical information, code broken neck as cervical spine, fracture, unspecified (NPFS-2), if all neck injuries are believed to be AIS 2 or 3. Otherwise code NPFS-7 (e.g., fatal with only listed injury being broken neck). Broken Neck

NASS Injury Coding Procedures

1. The first four rules below are given in the NASS field forms on how to select injuries for coding and are included here for the convenience of the coder.
 - a. If there are six or less injuries listed in the O.I.C. reduction section, code all of the injuries ordered by Source of Data (1st—autopsy, 2nd—hospital/medical, 3rd—emergency room, 4th—private physician, or 5th—unofficial sources) and by AIS severity within source. Order by source
 - b. If there are more than six injuries, order the injuries by source and by AIS severity within source. Code this ordering, injury-by-injury. If a group of ordered injuries has the same source, the same AIS, and the group includes at least the sixth and seventh injuries in the ordering, then a choice must be made as to which injury or injuries to code. Then by severity within source
 - c. Choose the injury or injuries that will enable the maximum number of different ISS body regions to be represented in the coded data. If no new ISS body region can be added, then simply code in accordance with the rule concerning known injury sources below. Maximize ISS within that source
 - d. If you cannot increase the number of different ISS body regions or if you can choose between two or more injuries of the same source and AIS severity any of which constitute the 3rd ISS region, then choose the injury that has a known injury source. Maximize by contact points
 - e. If the occupant has less than six injuries, then the number of rows required to be completed is equal to the number of injuries plus one (e.g., no injuries requires one row). In the additional row "not injured" will be coded for all variables including AIS severity. If < 6 rows, close out next row with zeros
2. An AIS-6 should be used only for injuries specifically coded AIS-6 in the Abbreviated Injury Scale and not because the victim died. Watch your "6"s
3. Try to associate contact points with individual injuries. List individual injured areas (i.e., body regions) if possible, instead of lumping them together into a code of X, Y, or O. For instance, if there are lacerations to both thigh and shin, code both TLLI-1 and LLLI-1 instead of YLLI-1. Individualize injuries
4. The coder should take care not to code the same injury twice simply because information concerning it is available from two different sources. For example, if the interview is used in gathering data, only the injuries not already coded based upon medical records should be coded. Don't double count
5. Pain, asphyxia, and hemorrhage represent results of injuries and are not injuries, per se; therefore, they are not coded. The AIS-80 revision is designed to code the injury itself (e.g., MIUW-3, retroperitoneum injury involving hemorrhage). Pain, asphyxia and hemorrhage not valid
6. In NASS, "not injured" is defined as AIS=0. Code "0" for all OIC variables, including AIS severity, for cases in which there are no injuries, or as the last injury listing for occupants sustaining less than six injuries. Closeout or no injury = 0

7. Definitions and procedures for the NASS for coding Injury Source for direct, induced, and noncontact injuries are:

Injury Sources

direct injury - an injury to a particular body region caused by the traumatic contact of that body region with a vehicle component or other object. The vehicle component or other object is coded as the injury source for that injury.

indirect or induced injury - an injury to a particular body region caused by a blow or a traumatic contact in some other body region (e.g., knee/acetabulum). The injury source for an induced injury would be the vehicle component contacted by the other body region (i.e., the occupant contact that initiates the injury mechanism).

Injury source is, therefore, defined as the vehicle component or object that initiated the injury mechanism (induced injury) or directly caused the injury (direct injury).

The noncontact injury source code ("90") is to be used only for the following specific types of injuries:

Non-contact Injury Sources

- (1) twisting or stretching of muscles in the arm, leg, back, etc. with no associated contact identifiable (most often these injuries will be minor muscle strain injuries);
- (2) head or neck injuries in which the torso is supported (e.g., by seat back or belt) and head or neck experiences traumatic forces due to inertial motion;
- (3) burns and flying glass injuries.

The following examples should be helpful in illustrating the above definitions.

Injury	Injury Mechanism Determined from Crash Evidence	Injury Source
Example 1		
Neck dislocation NPDV-3	a. head strikes windshield	a. (01) windshield
	b. forehead hits roof or convertible top	b. (34) roof or convertible top
	c. head strikes steering assembly	c. (03) steering assembly
	d. back hits seatback, no head restraint, head rolls back over seat	d. (90) noncontact injury source
	e. neck forced into lateral flexion by impact forces	e. (90) noncontact injury source
	f. torso restrained by belt, head and neck inertia causes neck injury	f. (90) noncontact injury source
	g. back hits seat back, head hits head restraint, neck is injured	g. (23) head restraint

Injury	Injury Mechanism Determined from Crash Evidence	Injury Source
Example 2		
Hip Dislocation P.DJ-3	Knee strikes dash, forces transmitted along femur forcing femoral head out of the acetabulum	(05) instrument panel
Example 3		
Shoulder elbow- wrist fracture/ dislocation .ZJ-2	Occupant braced hands on instrument panel, transmitting forces to wrist, elbow, and shoulder	(05) instrument panel
Example 4		
Acute lumbar strain BTM-1	Jackknife over seat belt, rotated about seat belt stretches back muscles	(22) belt restraint
Example 5		
Muscle strain in arms, back, chest, neck	Strain of muscles from twisting due to impact forces	(90) noncontact injury source

8. When no other injury information is available, data from the PAR is to be coded. If specific injuries are detailed, code accordingly. If only a PAR injury severity rating is assigned, code: "injured, severity unknown". This implies the existence of an unspecified injury of unknown severity. Do not code: "unknown if injured". This denotes lack of knowledge concerning the existence of injury, which is contrary to information documented in the PAR. Consider the five example situations below and code according to the instructions given, for example, in variable O28 et al. (1st O.I.C. - Body Region).

- a. No interview; no medical; PAR injury severity rating: "K", "A", "B", or "C"; code: "injured, severity unknown"—9UUU79709.
- b. No interview; no medical; PAR injury severity rating: "U"; code: "unknown if injured"—9999999999.
- d. No interview; no medical; PAR injury severity rating: "C", in addition "laceration to forehead" is reported; code: 6FSLI1 __ 09.
- e. No interview; no medical; no PAR mention of injury; hit & run vehicle/driver reported; code: "unknown if injured"—9999999999.

Coding PAR injury data

9. If the PAR is "blank" where the injury severity is assessed and the person was at the scene during the police investigation, code no injury. However, if the person was not present during the police inspection, code unknown if injured.

Presumption of "no injury" or "unknown if injured" from PAR

10. NASS does not code possible injuries, but injuries whose existence is considered to be probable are coded. If the words "possible" or "probable" are used, code accordingly (i.e., code the probable injuries only). If it is difficult to determine if an injury is probable or possible (i.e., use of other indistinct language such as "suspected," "appears" to be," etc), judge whether "possible" or "probably" based on the specific situation.

Only "Probable"
Injuries

PEDESTRIAN & NONMOTORIST FORM

P28
P35
P42
P49
P56
P63

Variable Name: 1st O.I.C. - Body Region
2nd O.I.C. - Body Region
3rd O.I.C. - Body Region
4th O.I.C. - Body Region
5th O.I.C. - Body Region
6th O.I.C. - Body Region

Format: 1 column - alphanumeric

Beginning
Column 32
41
50
59
68
77

Element Values:

M Abdomen	L Lea (lower)
Q Ankle - foot	Y Lower limb(s) (whole or unknown part)
A Arm (upper)	N Neck - cervical spine
B Back - thoracolumbar spine	P Pelvic - hip
C Chest	S Shoulder
E Elbow	T Thigh
F Face	X Upper limb(s) (whole or unknown part)
R Forearm	O Whole body
H Head - skull	W Wrist - hand
U Injured, unknown region	Ø Not injured
K Knee	9 Unknown if injured

Source: Variables P34, P41, P48, P55, P62, and P69 respectively.

Remarks:

The NASS Injury Coding Manual 1983 contains a listing of most injuries. Use the manual to code, for each injury, both its O.I.C. and I.S.S. body region and record them on the form. Ordering instructions are on page 7 of the Pedestrian & Nonmotorist Form.

PEDESTRIAN & NONMOTORIST FORM

F28
F35
F42
F49
F56
F63
(2)

Variable Name: 1st O.I.C. - Body Region (cont'd.)
2nd O.I.C. - Body Region (cont'd.)
3rd O.I.C. - Body Region (cont'd.)
4th O.I.C. - Body Region (cont'd.)
5th O.I.C. - Body Region (cont'd.)
6th O.I.C. - Body Region (cont'd.)

For coding the following situations, the correct procedure is:

	R	A	L	S	A	I	S	S	O	
	E	S	E	Y	.	N	O	O	F	
	G	P	S	S	I	J	U	U	D	
	I	E	I	T	.	U	R	R	A	
	O	C	O	E	S	R	C	C	T	
	N	T	N	M	.	Y	E	E	A	
Not injured:	0	0	0	0	0	0	0	0	0	
	32	33	34	35	36	37	38	39	40	
Injured, severity unknown:	U	U	U	U	7	9	7	0 or 9	1,2,3,4,5,6,7,8 or 9	
	32	33	34	35	36	37	38	39	40	
	0	0	0	0	0	0	0	0	0	
	41	42	43	44	45	46	47	48	49	
Unknown if injured:	9	9	9	9	9	9	9	9	9	
	32	33	34	35	36	37	38	39	40	
	0	0	0	0	0	0	0	0	0	
	41	42	43	44	45	46	47	48	49	

Note: Be sure to complete one additional row with zeros ("0") when the person is injured but has less than six injuries. This is true even when the person is injured but the severity is unknown, or if it is unknown whether or not the person is injured. Refer to the last O.I.C. note on page 7 of the Pedestrian and Nonmotorist Form.

When the person has several injuries from the same Source of Data, one of which is "injured, severity unknown," code this injury last.

OCCUPANT FORM

033
040
047
054
061
068
(3)

Variable Name: 1st O.I.C. - Injury Source (cont'd.)
2nd O.I.C. - Injury Source (cont'd.)
3rd O.I.C. - Injury Source (cont'd.)
4th O.I.C. - Injury Source (cont'd.)
5th O.I.C. - Injury Source (cont'd.)
6th O.I.C. - Injury Source (cont'd.)

75 Hood ornament
76 Windshield, roof rail, A-pillar
77 Side surface
78 Side mirrors
*79 Other side protrusions
80 Rear surface
81 Undercarriage
82 Tires and wheels
*83 Other exterior of striking motor vehicle
84 Unknown exterior of striking motor vehicle

Other Vehicle or Object in the Environment

86 Ground
*87 Other vehicle or object
89 Unknown vehicle or object

Noncontact Injury

90 Noncontact injury source (e.g., impact force, heat or flame from fire, battery acid, etc.)
97 Injured, unknown source
99 Unknown if injured

Source: Investigator determined--inputs include vehicle inspection and interviewee.

Remarks:

Interior flying glass refers to the person being struck by glass which has already fractured and is airborne. This is coded as "90" (Noncontact injury source). This does not refer to a person causing glass to shatter upon impacting it.

Investigator should record only those contact mechanisms which can be documented by some physical evidence (e.g., scuffs, hair, smudges, dents,

PEDESTRIAN & NONMOTORIST FORM

P30
P37
P44
P51
P58
P65

Variable Name: 1st O.I.C. - Lesion
2nd O.I.C. - Lesion
3rd O.I.C. - Lesion
4th O.I.C. - Lesion
5th O.I.C. - Lesion
6th O.I.C. - Lesion

Format: 1 column - alphanumeric

Beginning
Column 34
43
52
51
70
79

Element Values:

A Abrasion	U Injured, unknown lesion
M Amputation	L Laceration
V Avulsion	O Other
B Burn	P Perforation, puncture
K Concussion	R Rupture
C Contusion	S Sprain
N Crush	T Strain
G Detachment, separation	E Total severance, transection
D Dislocation	Ø Not injured
F Fracture	9 Unknown if injured
Z Fracture and dislocation	

Source: Variables P34, P41, P48, P55, P62, and P69 respectively.

Remarks:

The NASS Injury Coding Manual 1983 contains a listing of most injuries. Use the manual to code, for each injury, its lesion and record it on the form.

PEDESTRIAN & NONMOTORIST FORM

P31
P38
P45
P52
P59
P66

Variable Name: 1st O.I.C. - System/Organ
2nd O.I.C. - System/Organ
3rd O.I.C. - System/Organ
4th O.I.C. - System/Organ
5th O.I.C. - System/Organ
6th O.I.C. - System/Organ

Format: 1 column - alphanumeric

Beginning
Column 35
44
53
62
71
80

Element Values:

W All systems in region	M Muscles
A Arteries - veins	N Nervous system
B Brain	P Pulmonary - lungs
D Digestive	R Respiratory
E Ears	S Skeletal
O Eye	C Spinal cord
H Heart	Q Spleen
U Injured, unknown system	T Thyroid, other endocrine gland
I Intequimentary	G Urogenital
J Joints	V Vertebrae
K Kidneys	Ø Not injured
L Liver	9 Unknown if injured

Source: Variables P34, P41, P48, P55, P62, and P69 respectively.

Remarks:

The NASS Injury Coding Manual 1983 contains a listing of most injuries. Use the manual to code, for each injury, its system/organ and record it on the form.

PEDESTRIAN & NONMOTORIST FORM

P32
P39
P46
P53
P60
P67

Variable Name: 1st O.I.C. - Abbreviated Injury Scale
2nd O.I.C. - Abbreviated Injury Scale
3rd O.I.C. - Abbreviated Injury Scale
4th O.I.C. - Abbreviated Injury Scale
5th O.I.C. - Abbreviated Injury Scale
6th O.I.C. - Abbreviated Injury Scale

Format: 1 column - alphanumeric

Beginning
Column 36
45
54
63
72
81

Element Values:

- 0 Not injured
- 1 Minor injury
- 2 Moderate injury
- 3 Severe injury
- 4 Serious injury
- 5 Critical injury
- 6 Maximum (untreatable)
- 7 Injured, unknown severity
- 9 Unknown if injured

Source: Variables P34, P41, P48, P55, P62, and P69 respectively.

Remarks:

The NASS Injury Coding Manual 1983 contains a listing of most injuries. Use the manual to code, for each injury, its A.I.S. value and record it on the form.

PEDESTRIAN & NONMOTORIST FORM

P33
P40
P47
P54
P61
P68

Variable Name: 1st O.I.C. - Injury Source
2nd O.I.C. - Injury Source
3rd O.I.C. - Injury Source
4th O.I.C. - Injury Source
5th O.I.C. - Injury Source
6th O.I.C. - Injury Source

Format: 2 columns- numeric

Beginning
Column 37
46
55
64
73
82

Element Values:

- 00 Not injured
- Front
- 01 Windshield
- 02 Mirror
- 03 Steering assembly, including transmission selector lever when column mounted
- 04 Add-on equipment (e.g., CB, tape deck, air conditioner)
- 05 Instrument panel and below, excluding foot controls and parking brake
- 06 Sunvisor
- *09 Other front object
- Side
- 11 Side interior surface, excluding hardware or armrests
- 12 Side hardware or armrests
- 13 A pillar
- 14 B pillar
- 15 Other pillar
- 16 Window glass or frame
- *19 Other side object
- Interior
- 21 Seat, back support
- 22 Belt restraint system
- 23 Head restraint
- 24 Air cushion
- 25 Other occupants
- 26 Interior loose objects
- *29 Other interior objects

PEDESTRIAN & NONMOTORIST FORM

P33
P40
P47
P54
P61
P68
(2)

Variable Name: 1st O.I.C. - Injury Source (cont'd.)
2nd O.I.C. - Injury Source (cont'd.)
3rd O.I.C. - Injury Source (cont'd.)
4th O.I.C. - Injury Source (cont'd.)
5th O.I.C. - Injury Source (cont'd.)
6th O.I.C. - Injury Source (cont'd.)

Roof

31 Front header
32 Rear header
33 Roof side rails
34 Roof or convertible top

Floor

41 Floor
42 Floor or console mounted transmission lever, including console
43 Parking brake handle
44 Foot controls including parking brake

Rear

45 Backlight (rear window)
46 Backlight storage rack, door, etc.
*49 Other rear objects

Exterior of Nonmotorist's Vehicle

51 Hood
52 Outside hardware (e.g., outside mirror, antenna)
*53 Other exterior surface or tires
59 Unknown exterior objects

Cycle

(61) thru (69) Do Not Use

These Code Numbers are left blank so numbering consistency can be maintained with compatible variables on the Occupant Data Form.)

Exterior of Striking Motor Vehicle

71 Front bumper
72 Hood edge
*73 Other front of vehicle
74 Hood
75 Hood ornament
76 Windshield, roof rail, A-pillar
77 Side surface

PEDESTRIAN & NONMOTORIST FORM

P33
P40
P47
P54
P61
P68
(3)

Variable Name: 1st O.I.C. - Injury Source (cont'd.)
2nd O.I.C. - Injury Source (cont'd.)
3rd O.I.C. - Injury Source (cont'd.)
4th O.I.C. - Injury Source (cont'd.)
5th O.I.C. - Injury Source (cont'd.)
6th O.I.C. - Injury Source (cont'd.)

78 Side mirrors
*79 Other side protrusions
80 Rear surface
81 Undercarriage
82 Tires and wheels
*83 Other exterior of striking motor vehicle
84 Unknown exterior of striking motor vehicle

Other Vehicle or Object in the Environment

86 Ground
*87 Other vehicle or object
89 Unknown vehicle or object

Noncontact Injury

90 Noncontact injury source (e.g., impact force, heat or flame from fire, battery acid, etc.)

97 Injured, unknown source
99 Unknown if injured

Source: Investigator determined--inputs include vehicle inspection and interviewee.

Remarks:

Interior flying glass refers to the person being struck by glass which has already fractured and is airborne. This is coded as "90" (Noncontact injury source). This does not refer to a person causing glass to shatter upon impacting it.

Investigator should record only those contact mechanisms which can be documented by some physical evidence (e.g., scuffs, hair, smudges, dents, cracks, etc.). Use page 3 of the Pedestrian and Nonmotorist Form to record the injury source evidence. For those nonmotorists who are occupants of a motor vehicle not in transport (P08, Pedestrian or Nonmotorist's Type, equal to "5"), attach page 7 of a Vehicle Form to the Pedestrian and Nonmotorist Form and document any potential contact points.

PEDESTRIAN & NONMOTORIST FORM

P33
P40
P47
P54
P61
P68
(4)

Variable Name: 1st O.I.C. - Injury Source (cont'd.)
2nd O.I.C. - Injury Source (cont'd.)
3rd O.I.C. - Injury Source (cont'd.)
4th O.I.C. - Injury Source (cont'd.)
5th O.I.C. - Injury Source (cont'd.)
6th O.I.C. - Injury Source (cont'd.)

The element values encoded can be based on physical evidence, occupant kinematics, and interviewee information. Although physical evidence is preferred, it does not have to be present to support a contact mechanism.

If a parked (not in transport) vehicle is impacted by an occupant of a vehicle in transport, use the "87" (other vehicle or object) code.

NOTE: Whenever an "other" code (i.e., "09", "15", "19", "29", "49", "53", "73", "79", "83", or "87") is coded as injury source, clearly identify, in the space provided at the top of page 8 of the form, each description by value and injury number.

PEDESTRIAN & NONMOTOPIST FORM

P34
P41
P48
P55
P62
P69

Variable Name: 1st O.I.C. - Source of Data
2nd O.I.C. - Source of Data
3rd O.I.C. - Source of Data
4th O.I.C. - Source of Data
5th O.I.C. - Source of Data
6th O.I.C. - Source of Data

Format: 2 columns - numeric

Beginning
Column 39
48
57
66
75
84

Element Values:

Official	Unofficial
01 Autopsy records with or without hospital/medical records	05 Lay coroner report
02 Hospital/medical records other than emergency room (e.g., discharge summary)	06 E.M.S. personnel
03 Emergency room records only (including associated x-rays or other lab reports)	07 Interviewee
04 Private physician, or walk-in emergency clinic	08 Other source (specify)
	09 Police
	99 Unknown if injured
	00 Not injured

Source: Element chosen

Remarks:

Code "01" (Autopsy records with or without hospital/medical records) excludes records from lay, nonmedical personnel; they must be the result of an autopsy by a physician or other similarly qualified life scientist. A non-invasive external examination by a physician, though, should be coded either "02" (Hospital medical records other than emergency room) or "04" (Private physician) since it is generally a superficial listing of external injuries and possible internal injuries; therefore, injuries from this source should not be grouped with those from a thorough autopsy report.

Code "02" [Hospital/medical records other than emergency room (e.g., discharge summary)] is used whenever the injury is listed on the official post-emergency room records of a hospital or medical facility. If the injury was also listed on a facility's associated emergency room records, then the "02" code takes precedence. If the injury is also contained in an autopsy re-

PEDESTRIAN & NONMOTORIST FORM

P34
P41
P48
P55
P62
P69
(2)

Variable Name: 1st O.I.C. - Source of Data (cont'd.)
2nd O.I.C. - Source of Data (cont'd.)
3rd O.I.C. - Source of Data (cont'd.)
4th O.I.C. - Source of Data (cont'd.)
5th O.I.C. - Source of Data (cont'd.)
6th O.I.C. - Source of Data (cont'd.)

cord--where the autopsy was performed by a physician or similarly qualified life scientist--then, code "01" (Autopsy records with or without hospital/medical records) takes precedence. However, this code includes non-invasive (external) examinations conducted by a physician or medical examiner on a deceased victim and documented as a hospital record.

Code "03" [Emergency room records only (including associated x-rays or other lab reports)] is used when the injury only appears on a facility's emergency room record or on records that were completed in support of the person's examination in an emergency room. For example, an x-ray report that was completed because the emergency room physician requested it as a part of his/her examination would be included under this code. This code should not be used if the injury is subsequently listed on a post-emergency room record or in a medical autopsy.

If both types of records (emergency room and post-emergency room) refer to the same injury, code "02" [Hospital/medical records other than emergency room (e.g., discharge summary)] is used as the code even if the detail provided on the emergency room records exceeds the detail provided on the post-emergency room records.

Code "04" (Private physician, walk-in or emergency clinic) refers to any physician (in private practice) who saw the injured person and who has records of that treatment (i.e., other than hospital or autopsy records). Also included in this code are non-invasive (external) examinations conducted by a private physician or similarly qualified life scientist on a deceased victim and documented as other than a hospital record (e.g., coroner's report).

In summary, examinations of deceased persons are distinguished first by qualifications of examiner [official (codes "01", "02", and "04") versus unofficial (code "05")], second by the type of examination [autopsy (code "01") versus non-invasive (codes "02" or "04)], and third by type of examination record [hospital (code "02") versus other than hospital (code "04")].

PEDFSTRIAN & NONMOTORIST FORM

P34
P41
P48
P55
P62
P69
(3)

Variable Name: 1st O.I.C. - Source of Data (cont'd.)
2nd O.I.C. - Source of Data (cont'd.)
3rd O.I.C. - Source of Data (cont'd.)
4th O.I.C. - Source of Data (cont'd.)
5th O.I.C. - Source of Data (cont'd.)
6th O.I.C. - Source of Data (cont'd.)

Code "05" (Lay coroner report) is used if the injury data is contained in a report where a non-invasive examination of the deceased was performed by a non-physician, or lay coroner.

Code "06" (E.M.S. personnel) refers to a person certified by the state as trained in emergency medical service techniques. Code "06" should not be used for ambulance attendants, police, or other personnel not trained in E.M.S. techniques.

Code "07" (Interviewee) refers to the person who was interviewed to get the information on this form (not necessarily the person described on this form). The interviewee is defined in variable P27.

Code "08" (Other) is used when data are obtained from an unofficial source different from those explicitly listed above (e.g., chiropractors).

Code "09" (Police) can be used, but only when no other source of injury information is available. See last sentence of first paragraph on page 6, Pedestrian and Nonmotorist Form.

Code "00" (Not injured) is to be used when no injury was reported. In other words, this variable reports only the source of the injury information.

Variable Name: Injury Severity (Police Rating)

Format: 1 column - numeric

Beginning
Column 86

Element Values:

- 0 No injury (O)
- 1 Possible injury (C)
- 2 Nonincapacitating injury (B)
- 3 Incapacitating injury (A)
- 4 Killed (K)
- 5 Injury, severity unknown
- 6 Died prior to accident
- 9 Unknown

Source: Police report.

Remarks:

Code the police reported injury severity for this pedestrian or nonmotorist. It is possible that the police could have updated the PAR between the time it was stratified (A02, Case Number--Stratification) and when it was picked up. For example, a person might have been listed originally with incapacitating injuries ("3"). Later the person dies ("4"), and the PAR is changed accordingly. Therefore, use the latest information on the PAR at the time it was obtained from the police agency.

If the police report contains a detailed description of the injuries but does not translate the injuries into the KABCO codes, use the police method for doing so. For example, injuries which are considered to be of an incapacitating nature are classified as "A" (code "3"), nonincapacitating-evident injuries are "B" (code "2"), and possible injuries are "C" (code "1"). Property damage only is classified as "O" (code "0").

Code "5" (Injury, severity unknown) if the police report indicates a "U" or in any other way communicates the idea that the person was injured but their severity is unknown.

Code "6" (Died prior to accident) should only be coded if the police explicitly so indicate.

As a general rule, if the PAR is "blank" where the injury severity is accessed and the person was at the scene during the police investigation, code "0" (No injury). If the PAR is "blank" and the person was not present during the police investigation, code "9" (Unknown).

PEDESTRIAN & NONMOTORIST FORM

P70
(2)

Variable Name: Injury Severity (Police Rating) (cont'd.)

Not all states use the KARCOU scheme. Listed below, by state, are alternative schemes; a mapping to the NASS scheme is provided.

State	PAR Code/Definition	NASS Scheme/Code
Alabama	K = Killed	K - 4
	A = Visible or carried from scene	A - 3
	B = Bruise/abrasion/swelling	B - 2
	C = No visibility - has pain/faint	C - 1
	Blank = No documentation of driver or occupant injury	Blank - 0
	= No set unknown code	- 9
Arizona	1 = No injury	O - 0
	2 = Possible injury	C - 1
	3 = Nonincapacitating injury	B - 2
	4 = Incapacitating injury	A - 3
	5 = Fatal	K - 4
	6 = Unknown	U - 5
California	1 = Fatal	K - 4
	2 = Severe wound/distorted member	A - 3
	3 = Other visible injury	B - 2
	4 = Complaint of pain	C - 1
	blank = Occupant present	O - 0
	blank = Occupant not present	- 9
Colorado*	5 = Fatal	K - 4
	4 = Evident - incapacitating	A - 3
	3 = Evident - nonincapacitating	B - 2
	2 = Possible injury	C - 1
	1 = No injury	O - 0
<p>*There is a box at the top of the PAR indicating number of persons injured. If this box is marked 0 and the injury code is left "blank", assume "No injury". If the box is marked 1 (or more) pertaining to the vehicle occupants in question and the injury code is "blank", assume "Injured, severity unknown". If "blanks" are present in both the persons injured box and the injury code box, assume "Unknown".</p>		
Florida	1 = No injury	O - 0
	2 = Fatal "in 90 days" injury	K - 4
	3 = Incapacitating injury	A - 3
	4 = Nonincapacitating injury	B - 2
	5 = Possible injury	C - 1
	6 = Non-traffic fatality	K - 4
	= No set unknown code	- 9

PEDestRIAN & NONMOTORIST FORM

P70
(3)

Variable Name: Injury Severity (Police Rating) (cont'd.)

State	PAR Code/Definition			NASS Scheme/Code	
Indiana	Nature of Most Severe Injury	Location of Most Severe Injury	Victim's Injury Status		
	1-11 Any Entry	1-12 Any Entry	6 Dead	K - 4	
	1-11 Any Entry	1-12 Any Entry	2 Semiconscious 3 Incoherent 4 Unconscious	A - 3	
	1 Severed 2 Internal 4 Severe Burn 7 Severe Bleed (Arterial) Fracture/dislocation	1-12 Any Entry	1 Conscious 5 Shock 7 Refused Med	A - 3	
	3 Minor Burn 6 Minor Bleed 10 Complaint of Pain 11 None Visible	3 Eye	1 Conscious 5 Shock 7 Refused Med	A - 3	
	3 Minor Burn 6 Minor Bleed	1-2, 4-12 (Any EXCEPT Eye)	1 Conscious 5 Shock 7 Refused Med	B - 2	
	5 Abrasion 9 Contusion/Bruise	1-12 Any Entry	1 Conscious 5 Shock 7 Refused Med	B - 2	
	10 Complaint of Pain 11 None Visible	1-2, 4-12 (Any EXCEPT Eye)	1 Conscious 5 Shock 7 Refused Med	C - 1	
	11 None Visible	Blank or Slashed	1 Conscious	O - 0	
	Blank or Slashed	Blank or Slashed	Blank or Slashed	O - 0	
	Unknown	Unknown	Unknown	U - 9	
	Iowa	1 = Fatal			K - 4
		2 = Major (incapacitating)			A - 3
		3 = Minor (bruises and abrasions)			B - 2
		4 = Possible (complaint of pain)			C - 1
Ø = Unknown			U - 9		
Blank = No documentation of driver or occupants on back of PAR			O - 0		
Louisiana	1 = Fatal			K - 4	
	2 = Severe			A - 3	
	3 = Noticeable			B - 2	
	4 = Complaint of pain or momentary unconsciousness			C - 1	
	5 = None			O = 0	

PEDESTRIAN & NONMOTORIST FORM

P70
(4)

Variable Name: Injury Severity (Police Rating) (cont'd.)

State	PAR Code/Definition	NASS Scheme/Code
Maryland	5 = Fatal	K - 4
	4 = Incapacitating	A - 3
	3 = Nonincapacitating	B - 2
	2 = Possible injury	C - 1
	1 = No injury/Damage only	O = 0
	Blank = No documentation of driver or occupants on front of PAR	
Massachusetts	K = Killed	K - 4
	A = Visible signs of injury, as bleeding wound or distorted member; or had to be carried from scene	A - 3
	B = Other visible injury, as bruises, abrasions, swelling, limping, etc.	B - 2
	C = No visible injury but complaint of pain or momentary unconsciousness	C - 1
	Blank = No documentation of driver or occupants on front of PAR	O - 0
	= No set unknown code	- 9
Missouri	A = Fatal	K - 4
	B = Disabling	A - 3
	C = Evident (Not Disabling)	B - 2
	D = Probable - Not Apparent	C - 1
	E = None Apparent	O - 0
	F = Unknown	U - 9
Nebraska	4 = Fatal	K - 4
	3 = Incapacitating injury	A - 3
	2 = Nonincapacitating injury	B - 2
	1 = Possible injury	C - 1
	0 = No injury	O - 0
	Blank = Occupant present	O - 0
Blank = Occupant not present	- 9	

Variable Name: Injury Severity (Police Rating) (cont'd.)

State	PAR Code/Definition			NASS Scheme/Code
New Jersey	Location of Injury	Type of Injury	Victim's Condition	
	Any entry	Any entry	Killed	K - 4
	Any entry	Any entry	Incapacitated	A - 3
	Any entry	amputation, concussion, internal, fracture/dislocation	Moderate injury Complaint of pain	A - 3
	Eye	burn, bleeding, complaint of pain	Moderate injury Complaint of pain	A - 3
	Any entry	bleeding, contusion, bruise, abrasion	Moderate injury	B - 2
	Any entry (except eye)	complaint of pain	Complaint of pain	C - 1
	-	-	-	O - 0
	U	U	U	- 9
	New York	Location of Injury	Type of Complaint	Victim's Status
Any entry		Any entry	Apparent death	K - 4
Any entry		Any entry	Unconscious, Semi-conscious, Incoherent	A - 3
Any entry		amputation, concussion, internal, severe bleeding, severe burn, moderate burn, fracture - dislocation	Shock, Normal	A - 3
Eye		minor bleeding, minor burn, complaint of pain	Shock, Normal	A - 3
All but eye		minor bleeding, minor burn	Shock, Normal	B - 2
Any entry		contusions-bruise, abrasion	Shock, Normal	B - 2
All but eye		complaint of pain	Shock, Normal	C - 1
-		-	-	O - 0
X		X	X	- 9

PEDESTRIAN & NONMOTORIST FORM

P70
(6)

Variable Name: Injury Severity (Police Rating) (cont'd.)

State	PAR Code/Definition	NASS Scheme/Code
Pennsylvania	0 = No injury	O - 0
	1 = Death	K - 4
	2 = Major injury	A - 3
	3 = Moderate injury	B - 2
	4 = Minor injury [and] Type of Apparent Injury	
	- amputation	
	- bleeding	
	- broken bone(s)	B - 2
	- burns	
	- concussion	
- abrasions/bruises		
- other		
4 = Minor injury [and] Type of Apparent Injury		
- shock	C - 1	
- dizziness		
- complaint of pain		
Rhode Island	1 = Fatal injury at scene	K - 4
	2 = Visible signs of injury - bleeding or broken bones	A - 3
	3 = Other visible injury - bruises or abrasions	B - 2
	4 = No visible injury, but complaints of pain	C - 1
	Blank = No injury	O - Ø
South Dakota	Ø = No injury	O - Ø
	1 = Fatal	K - 4
	2 = Incapacitating injury	A - 3
	3 = Nonincapacitating injury	B - 2
	4 = Possible injury	C - 1
Tennessee	4 = Dead at time of report	K - 4
	3 = Bleeding wound, distorted member	A - 3
	2 = Bruises, abrasions, swelling, limping, etc.	B - 2
	1 = Complaint of pain, no visible injury	C - 1
	Blank = No documentation of driver or occupants on front of PAR or on supplement	O - 0

PEDESTRIAN & NONMOTORIST FORM

P70

(7)

Variable Name: Injury Severity (Police Rating) (cont'd.)

<u>State</u>	<u>PAR Code/Definition</u>	<u>NASS Scheme/Code</u>
Washington	1 = No injury	O - 0
	2 = Dead at scene	K - 4
	3 = Dead on arrival	K - 4
	4 = Died in hospital	K - 4
	5 = Disabling injury	A - 3
	6 = Nondisabling injury	R - 2
	7 = Possible injury	C - 1
	Blank = Unknown	- 9

PEDESTRIAN & NONMOTORIST FORM

P71

Variable Name: Traffic Violation Charged Against This Pedestrian or
Nonmotorist

Format: 1 column - numeric

Beginning
Column 87

Element Values:

- 0 No
- 1 Yes (specify)
- 9 Unknown

Source: Police report

Remarks:

If the police charged this pedestrian or nonmotorist with any violation,
then code yes ("1"). Specify the violation in the space provided, if known.

Variable Name: Police Reported Alcohol Presence

Format: 1 column - numeric

Beginning
Column 88

Element Values:

- 0 No (alcohol not present)
- 1 Yes (alcohol present)
- 8 Not reported
- 9 Unknown

Source: Police report.

Remarks:

Find the location on the police report that indicates the investigating officer's assessment with respect to whether or not alcohol was present in this pedestrian or nonmotorist in this accident. If the police report explicitly states or implies that alcohol was present or used by this pedestrian or nonmotorist prior to the accident, then code "1" [Yes (alcohol present)]. If there is no specific variable alcohol presence, see if it is addressed in the narrative description of the accident.

The phrase "present in this pedestrian or nonmotorist" means that this pedestrian or nonmotorist had consumed an alcoholic beverage. Presence is not an indication that alcohol was in any way a cause of the accident, even though it may have been. Finding opened or unopened alcoholic beverage with this pedestrian or nonmotorist does not by itself constitute presence.

In summary, if the police indicate alcohol presence in the pedestrian or nonmotorist via a specific data element on the police report form and/or if the police charges the pedestrian or nonmotorist with walking while intoxicated (WWI) or public intoxication, etc., and/or if the police mention in the narrative section of the report that the pedestrian or nonmotorist had been drinking (or alcohol was present or involved) and/or the police report has a positive BAC test result (BAC > .00), then code "1" [Yes (alcohol present)].

Code "0" [No (alcohol not present)] if the investigating officer's assessment (as reported on the police report) is that no alcohol was present in this pedestrian or nonmotorist. If there is a specific location on the police report for assessment of alcohol presence but the investigating officer fails to make either a positive or negative assessment of alcohol presence, then code "8" (Not reported).

If the PAR has a block which is labeled "Alcohol/Drugs", then use any other information on the PAR to determine what was present, alcohol or some other type of drug. If no other information is available, then code "9" (Unknown) should be used.

PEDESTRIAN & NONMOTORIST FORM

P72

(2)

Variable Name: Police Reported Alcohol Presence (cont'd.)

Code "9" (Unknown) if the alcohol presence is unknown. In general police reports have blocks to check either positive or negative alcohol presence, hence one of the codes "0", "1", or "8" is the appropriate response. But if a police report has provision for the investigating officer to respond "unknown alcohol presence," then code "9" (Unknown).

Variable Name: Alcohol Test Result

Format: 2 columns - numeric

Beginning
Column 89

Element Values:

Level 2 Range: 00 through 25

Code actual reported number representing fraction of alcohol present
(decimal implied before first digit 0.xx)

95 Test refused

96 None given

97 AC test performed, results unknown

99 Unknown

Source: Police report, medical reports, or other official sources.

Remarks:

A blood alcohol concentration (BAC) test could be a blood, breath, or urine test. No psychomotor (police observation of driver actions) test results are to be coded here. These preliminary tests include instrumented field screening tests which indicate the presence of alcohol but not necessarily the particular content level. These devices are designed to segregate candidates for further testing from those persons where the suspected presence of alcohol is either nonexistent or too low for additional tests.

Code "95" (Test refused) when the person refuses to voluntarily take a BAC test and no subsequent test is given. If the person refuses, but a test is performed, code the reported BAC or "97" (AC test performed, results unknown).

Code "96" (None given) includes those instances when an instrumented field screening test was given and it determined that no BAC test was required.

If an instrumented field screening test was given and it determined that a BAC test was required, code either the reported BAC from the subsequent test or "97" (AC test performed, results unknown) if the precise level was not obtained.

If the results are not available at the time the NASS case is initially submitted, code "97" (AC test performed, results unknown) circle the variable number, and update this variable when the results are obtained.

If the BAC was given on the police report or subsequently added after the case was initiated, code the reported value. If the BAC was obtained from a medical report or any other official record, code the reported value. In essence, if any BAC is obtained, code the reported value.

Variable Name: Time of Death

Format: 2 columns - numeric

Beginning
Column 91

Element Values:

Level 1 Range: 00 through 24, 31 through 60, 96, 99
00 Not fatal
96 Fatal - ruled disease
99 Unknown

Source: Police report, hospital/medical records, autopsy report, or other official records for actual time of death for fatally injured pedestrians or nonmotorists.

Remarks:

Code "00" should identify (from any source) all pedestrians or nonmotorists who are not fatally injured (i.e., death does not occur, or does not occur within thirty days of the accident).

All pedestrians or nonmotorists who die within thirty days of the accident should have their time-of-death recorded unless their death meets the criteria of the Fatal - ruled disease code "96."

Code "96" (Fatal - ruled disease) is used in two situations. The first is when the effects of a disease can be deemed as a cause of the accident. Cause means that the on-set of the disease occurred prior to the first harmful event. When determining the time of on-set (relative to the first harmful event), the investigator can use any information source available. The investigator makes his/her determination after weighing all the evidence. (NOTE: The use of all available information sources is restricted to the determination of when the on-set occurred.) Additionally, code "96" (Fatal - ruled disease) is used when a medical examiner (or other official vested by the state to verify the cause of death) or an official medical report verifies that the death resulted from either (1) a diseased condition, or (2) not from accident related injuries.

Code "01" should identify pedestrians or nonmotorists who die within (less than) one and a half hours of the time of the accident.

Variable Name: Time of Death (con't)

Codes "02" through "24" should identify pedestrians or nonmotorists who die in the period of time between one and a half hours from the time of the accident to twenty-four hours after the accident. The variable should be coded to the nearest hour except for code "24" which is used only for the period between twenty-three and a half hours after the accident and twenty-four hours after the accident.

Codes "31" through "60" should identify pedestrians or nonmotorists who die in the period of time between greater than twenty-four hours after the accident (24 hours and one minute is coded as "31" while 24 hours is coded as "24") and thirty days after the accident. (NOTE: One day = "31", two days "32", ..., twenty-nine days = "59", and thirty days = "60".) The number of days should be rounded off to the nearest whole day except for code "60" which is used for the period between twenty-nine days and twelve hours and thirty days after the accident.

The exact time period which applies to each code is shown in the table below.

Variable Name: Time of Death (cont'd.)

Code	Time period in hours
01	0 - < 1 1/2
02	1 1/2 - < 2 1/2
03	2 1/2 - < 3 1/2
04	3 1/2 - < 4 1/2
05	4 1/2 - < 5 1/2
06	5 1/2 - < 6 1/2
07	6 1/2 - < 7 1/2
08	7 1/2 - < 8 1/2
09	8 1/2 - < 9 1/2
10	9 1/2 - < 10 1/2
11	10 1/2 - < 11 1/2
12	11 1/2 - < 12 1/2
13	12 1/2 - < 13 1/2
14	13 1/2 - < 14 1/2
15	14 1/2 - < 15 1/2
16	15 1/2 - < 16 1/2
17	16 1/2 - < 17 1/2
18	17 1/2 - < 18 1/2
19	18 1/2 - < 19 1/2
20	19 1/2 - < 20 1/2
21	20 1/2 - < 21 1/2
22	21 1/2 - < 22 1/2
23	22 1/2 - < 23 1/2
24	23 1/2 - 24

Code	Time period in days
31	> 1 - < 1 1/2
32	1 1/2 - < 2 1/2
33	2 1/2 - < 3 1/2
34	3 1/2 - < 4 1/2
35	4 1/2 - < 5 1/2
36	5 1/2 - < 6 1/2
37	6 1/2 - < 7 1/2
38	7 1/2 - < 8 1/2
39	8 1/2 - < 9 1/2
40	9 1/2 - < 10 1/2
41	10 1/2 - < 11 1/2
42	11 1/2 - < 12 1/2
43	12 1/2 - < 13 1/2
44	13 1/2 - < 14 1/2
45	14 1/2 - < 15 1/2
46	15 1/2 - < 16 1/2
47	16 1/2 - < 17 1/2
48	17 1/2 - < 18 1/2
49	18 1/2 - < 19 1/2
50	19 1/2 - < 20 1/2
51	20 1/2 - < 21 1/2
52	21 1/2 - < 22 1/2
53	22 1/2 - < 23 1/2
54	23 1/2 - < 24 1/2
55	24 1/2 - < 25 1/2
56	25 1/2 - < 26 1/2
57	26 1/2 - < 27 1/2
58	27 1/2 - < 28 1/2
59	28 1/2 - < 29 1/2
60	29 1/2 - 30

PEDESTRIAN & NONMOTORIST FORM

P'5
P'6
P'7

Variable Name: 1st - Other Pedestrian/Nonmotorist Related Factors
2nd - Other Pedestrian/Nonmotorist Related Factors
3rd - Other Pedestrian/Nonmotorist Related Factors

Format: 2 columns - numeric

Beginning
Column 93
95
97

Element Values:

00 No other pedestrian/nonmotorist related factors

Physical/Mental Condition

01 Non-physical (i.e., mental or emotional factor)

Physical Impairments

- 02 Blind
- 03 Restricted sight
- 04 Walking cane/crutches required
- 05 Deaf
- 06 Restricted to wheelchair
- 07 Paraplegic
- 08 Previous injury
- 09 Other physical impairments (specify)

Drug Impairments

- 10 Drugs-medication (prescription, over-the-counter)
- 11 Other drugs (excludes alcohol, includes uncontrolled substances)[specify]

Operator Related Factors

Pedalcyclist Related (Includes Animal Related)

- 20 Inattention
- 21 Interference with operator by other passenger
- 22 Operator inexperience
- 23 Unfamiliar with roadway
- 24 Overloading or improper loading of vehicles with passengers or cargo
- 25 Operating vehicle in erratic, reckless, careless or negligent manner
- 26 Improper or erratic lane changing
- 27 Failure to keep in proper lane or running off roadway
- 28 Making improper entry to or exit from trafficway
- 29 Failure to yield right-of-way
- 30 Failure to obey traffic signs, traffic control devices or traffic officers, failure to observe Safety Zones

PEDESTRIAN & NONMOTORIST FORM

P75
P76
P77
(2)

Variable Name: 1st - Other Pedestrian/Nonmotorist Related Factors (cont'd.)
2nd - Other Pedestrian/Nonmotorist Related Factors (cont'd.)
3rd - Other Pedestrian/Nonmotorist Related Factors (cont'd.)

- 31 Failure to signal intentions
- 32 Giving wrong signal
- 33 Making right turn from left lane, making left turn from right lane
- 34 Making other improper turn
- 35 Driving wrong way on one-way roadway
- 36 Driving on wrong side of roadway
- 37 Failure to have lights on when required

Pedestrian Related (Includes Other Nonmotorist)

- 38 Not seen by driver
- 39 Darting or running into roadway
- 40 Improper crossing of roadway or intersection
- 41 Walking with or against traffic, playing, working, sitting, lying, standing, etc., in roadway
- 42 Holding onto vehicle

- 98 Other (specify)
- 99 Unknown

Source: Police report, hospital/medical report, or other official records.

Remarks:

The purpose of these variables is to provide guidance to safety research on the involvement of these factors in accidents. Causal determinations must necessarily be based on more detailed investigations and other data, such as exposure data.

Related Factors are circumstances that may have contributed to the cause of an accident. For our purposes, regarding pedestrian/nonmotorist related factors, only those factors indicated by the investigating police officer on the PAR or identified in other official reports are to be considered for coding. These factors can appear anywhere on the report--in the narrative section, in the space for violations, in the column titled "Contributing Factors" or "Driver/Operator Action", etc.

As described in the coding attributes, pedestrian/nonmotorist related factors are divided into two groups: (1) Physical/Mental Conditions (codes "01"-"11"), and (2) Operator Related Factors (codes "20"-"42"). Physical/Mental Conditions can be police report indications and/or information taken from other official records (e.g., hospital/medical, autopsy reports, driver records, etc.). Operator Related Factors are restricted to police report

PEDESTRIAN & NONMOTORIST FORM

P'15
P'16
P'17
(3)

Variable Name: 1st - Other Pedestrian/Nonmotorist Related Factors (cont'd.)
2nd - Other Pedestrian/Nonmotorist Related Factors (cont'd.)
3rd - Other Pedestrian/Nonmotorist Related Factors (cont'd.)

indications only. Indications taken from the PAR are coded whether or not the PAR's contributing factor is accurate.

Only the pedestrian/nonmotorist related factors that apply to that particular pedestrian/nonmotorist should be coded. If only one factor applies, the code for it should be entered in the slots for the first variable. The following variables should be coded "00" (No other pedestrian/nonmotorist related factors), signifying no subsequent related factors. If two or three factors apply, code accordingly in ascending numerical order. If more than three codes apply, choose the three that seem the most significant. If no other pedestrian/nonmotorist related factors apply, code "00" (No other pedestrian/nonmotorist related factors) for all three variables.

Code "00" (No other pedestrian/nonmotorist related factors) is used if the investigating officer did not indicate any related factors for the pedestrian/nonmotorist in the accident and if related factors are not identified from other official sources.

Code "01" [Non-physical (i.e., mental or emotional factor)] includes anger, depression, excitement, illness, disease, blackout, etc. It also includes inattention for pedestrians.

Codes "02" through "11" (Physical and Drug Impairment) apply to impairments that are indicated on the PAR or specified in other official records.

Code "04" (Walking cane/crutches required) also includes ambulatory "walkers".

If both "06" (Restricted to wheelchair) and "07" (Paraplegic) apply, code "07". Reserve "06" for those persons who are restricted to a wheelchair, but are not paraplegic.

Codes "20" through "37" are Operator Related Factors and apply only to pedalcyclists and operators of nonmotorist conveyances (including animal related).

Code "21" (Interference with operator by other person) is to be used whenever the operator of a pedalcycle or nonmotorist conveyance (included animal related) is distracted or restricted by an occupant of that pedalcycle or conveyance.

PEDESTRIAN & NONMOTORIST FORM

P75
P76
P77
(4)

Variable Name: 1st - Pedestrian/Nonmotorist Related Factors (cont'd.)
2nd - Pedestrian/Nonmotorist Related Factors (cont'd.)
3rd - Pedestrian/Nonmotorist Related Factors (cont'd.)

Code "33" (Making right turn from left lane, making left turn from right lane) refers to any turn made from the wrong lane. It includes turning into a driveway, turning at an intersection, etc.

Code "34" (Making other improper turn) includes all of the turns that do not apply above (e.g., U-turns, turning at an intersection when it is not allowed, turning into the wrong lane, etc.).

Code "37" (Failure to have lights on when required) includes operating the pedalcycle or conveyance without the proper light equipment (e.g., headlights, taillights, etc.).

Codes "38" through "42" are primarily Pedestrian Related Factors, but also apply to Other Nonmotorists.

Code "38" (Not seen by driver) means "not visible" (i.e., having some quality that renders the pedestrian imperceptible to the driver). This can refer to pedestrians who wear dark clothing at night, very small children, etc.

Code "39" (Darting or running into roadway) includes pedestrians running to cross the roadway, to retrieve a ball, etc.

Code "40" (Improper crossing of roadway or intersection) can be coded together with "39" if the pedestrian is both running and crossing the roadway improperly.

Code "42" (Holding onto vehicle) includes interfering with operator while attached to the vehicle as a pedestrian, or nonmotorist associated with a nonmotorist conveyance.

Code "98" [Other (specify)] does not include alcohol presence or involvement.

Code "99" (Unknown) in all three spaces only when the PAR specifically states "unknown contributing factors".



1 Primary Sampling Unit Number	1	2
2 Case Number - Stratification	3	4 5 6
3 Record Number	3	7
4 Transaction Code	8	
5 Version Number	7	9
6 Investigator I.D. Number	10	

IDENTIFICATION

7 Vehicle Number	11	12
8 Number of Occupant Forms Submitted		
Code only the number of occupants in this vehicle for which an OCCUPANT FORM was submitted.		
(97) 97 or more	13	14
9 Vehicle Role		
(0) Noncollision		
(1) Striking unit		
(2) Struck unit		
(3) Both striking and struck		
(9) Unknown		15
10. Manner of Leaving Scene (Determined by Investigator)		
(1) Driven		
(2) Towed - due to vehicle damage		
(3) Towed - not due to vehicle damage		
(4) Abandoned		
(9) Unknown		16

EXTERIOR ITEMS

11. Vehicle Model Year		
Code the last two digits of the model year.		
(99) Unknown	17	18
12. Vehicle Make		
Applicable codes are found in your NASS Data Collection, Coding and Editing Manual.		
(99) Unknown	19	20
13 Vehicle Model		
Applicable codes are found in your NASS Data Collection, Coding and Editing Manual.		
(00) Unknown		
(69) Unknown (motorcycle)		
(79) Unknown (light truck)		
(89) Unknown (truck)		
(99) Unknown (automobile)	21	22

14. Body Type

Automobiles

(01) Convertible (excludes sun-roof, t-bar)

(02) 2-door sedan, hardtop, coupe

(03) 3-door/2-door hatchback

(04) 4-door sedan, hardtop

(05) 5-door/4-door hatchback

(06) Station wagon (excluding van and truck based)

(08) Other automobile type

(09) Unknown automobile type

Automobile Derivatives and Short Utility Vehicles

(10) Auto based pickup (includes El Camino, Caballero, Ranchero, Brat)

(11) Auto based panel (cargo station wagon, includes auto based ambulance/hearse)

(12) Short utility - not truck based (includes Jeep CJ-5, Jeep CJ-7, Renegade, Landrover, Pre-78 Bronco, Landcruiser, Thing)

(13) Large limousine - more than four side doors or stretched chassis

Motorcycles

(20) Motorcycle

(21) Mopeds (motorized bicycles)

(28) Other motorcycle (mmbikes, motorscooters):

(29) Unknown motorcycle type

Bus (excludes van based)

(30) School bus (designed to carry students, not cross country or transit)

(31) Cross country/intercity (designed for long distance)

(32) Transit bus (includes short ride city bus and medium range suburban bus)

(38) Other bus (e.g., bus based motorhome):

(39) Unknown bus type

Van Based Light Truck (< 10,000 lbs GVWR)

(40) Van (includes VW bus, Vanagon, Kombi, Beauville, Chateau, Club Wagon, Sportsman; excludes moving van)

(41) Van-commercial cutaway (includes box van, multi-stop, parcel, van pickups)

(42) Van based motorhome

(48) Other van type

(49) Unknown van type

Light Conventional Truck (Pickup style cab, < 10,000 lbs GVWR)

(50) Pickup (includes open box and caps)

(51) Pickup with slide-in camper

(52) Pickup based motorhome (chassis mounted)

(53) Cab chassis based (includes rescue vehicles, light stake, dump, and tow trucks)

(54) Truck based panel

(55) Truck based station wagon (4-door; includes Suburban, Travelall, Wagoneer)

(56) Truck based utility (2-door; includes Blazer, Bronco - 78 on, Jimmy, Ramcharger, Cherokee, Trailduster, Scout)

(58) Other light conventional truck (e.g., stretched Suburban limousine)

(59) Unknown light conventional truck

(69) Unknown light truck (van or pickup)

Medium/Heavy Truck (> 10,000 lbs GVWR)

(70) Step vans

(71) Single unit straight truck (10,000 lbs < GVWR < 26,000 lbs.)

(72) Single unit straight truck (> 26,000 lbs. GVWR)

(73) Medium/heavy truck based motorhome

(74) Truck-tractor with no cargo trailer

(75) Truck-tractor pulling one or more trailers

(77) Truck-tractor (unknown if pulling trailer)

(78) Unknown medium/heavy truck type

(79) Unknown truck type (light/medium/heavy)

Other Vehicles

(80) Snowmobile

(81) Farm equipment other than trucks

(82) ATV, all terrain vehicle (e.g., dune/swamp buggy)

(83) Construction equipment other than trucks (e.g., grader, off road)

(88) Other (e.g., go cart, fork lift, city street sweeper)

(89) Unknown other vehicle:

(99) Unknown body type

National Accident Sampling System – Continuous Sampling Subsystem: Vehicle Data

15. Towed Trailing Unit (V14# 75,77)
 ___ (0) No towed unit (or V14=75,77)
 Yes,
 towed trailing unit hitch type
 ___ (1) Clamp on (temporary)
 ___ (2) Bumper hitch (bolted)
 ___ (3) I frame
 ___ (4) Fifth wheel
 ___ (5) Other _____
 ___ (6) Unknown hitch type

25

16 Cab Configuration
 ___ (0) Not a truck (e.g., automobile, motorcycle)
 Cab Over Engine (COE)
 ___ (1) COL, high entry
 ___ (2) COL, low entry
 ___ (3) COL, unknown entry
 Conventional (CBF Cab Behind Engine)
 ___ (4) 2-door (standard)
 ___ (5) 2-door extended cab/4-door crew cab
 ___ (6) Unknown number of doors
 ___ (7) Cab alongside engine (CAE)
 ___ (8) Other _____
 ___ (9) Unknown

26

17. Seating Capacity/Truck Vocation
Passenger Vehicles by Designated Seating Capacity
 Motorcycle/Automobile/Van/Bus (exclude pickups)
 ___ (01) One seat position
 ___ (02) Two seat positions
 ___ (03) Three seat positions
 ___ (04) Four seat positions
 ___ (05) Five seat positions
 ___ (06) Six seat positions
 ___ (07) Seven seat positions
 ___ (08) Eight seat positions
 ___ (09) Nine seat positions
 ___ (10) 10 to 19 seat positions
 ___ (11) 20 to 49 seat positions
 ___ (12) 50 or more seat positions
 ___ (13) Motorhome (any light or medium truck based)
 ___ (14) Ambulance/LMS (any auto or truck based)
 ___ (19) Unknown passenger vehicle seating capacity

Cargo Vehicle by Vocation (Cargo Configuration)
 Platform
 ___ (20) Platform, flat bed
 ___ (21) Platform with device (e.g., self-loader, spreader)
 ___ (22) Stake
 ___ (23) Drop frame, low bed, lowboy
 ___ (24) Livestock Carrier
 ___ (28) Other platform _____

Open
 ___ (30) Pickup box (non-dump, includes open box and caps)
 ___ (31) Pickup with slide-in camper
 ___ (32) Dump (any light, medium, or heavy truck based)
 ___ (33) Dump with blade (front or undercarriage)
 ___ (34) Hopper (grain)
 ___ (35) Auto carrier/transport (includes boat)
 ___ (36) Van-open top
 ___ (38) Other open _____

Closed
 ___ (40) Van-closed top (any light, medium or heavy truck based, e.g., multi-stop)
 ___ (41) Low bed van (e.g., moving van)
 ___ (42) Refrigerated or insulated
 ___ (43) Mobile home
 ___ (44) Beverage, bottler
 ___ (45) Container (e.g., piggy back)
 ___ (46) Tank-liquid and gaseous
 ___ (47) Tank-dry bulk
 ___ (48) Other closed _____

Service/Utility
 ___ (50) Garbage, refuse (including dumpster)
 ___ (51) Fire apparatus
 ___ (52) Concrete mixer
 ___ (53) Wrecker, tow
 ___ (54) Crane, aerial basket
 ___ (55) Service, mobile repair (e.g., phone line truck)
 ___ (56) Pole (e.g., pipe or log)
 ___ (57) Armored truck
 ___ (58) Other service/utility: _____
 ___ (71) Truck-tractor – no trailer
 ___ (72) Chassis, incomplete vehicle
 ___ (88) Other cargo vehicle _____
 ___ (97) Other nontruck (e.g., construction paver, farm tractor)
 ___ (98) Unknown cargo configuration
 ___ (99) Unknown if passenger or cargo vehicle

27 28

HEAVY TRUCK DATA (TRUCKS OVER 10,000 LBS GVWR – V14=70–78)

18. Tractor with Dromedary
 ___ (0) Not truck over 10,000 lbs GVWR (V14 ≠ 70–78)
 ___ (1) No
 ___ (2) Yes
 ___ (9) Unknown

29

19. 20. 21. 22. Number of Axles

Power Unit	Trailer 1st	Trailer 2nd	Trailer 3rd	
___	___	___	___	(0) Not truck over 10,000 lbs. GVWR (V14≠ 70–78)
___	___	___	___	(1) One
___	___	___	___	(2) Two
___	___	___	___	(3) Three
___	___	___	___	(4) Four
___	___	___	___	(5) Five
___	___	___	___	(6) Six
___	___	___	___	(7) Seven or more
___	___	___	___	(8) No trailer
___	___	___	___	(9) Unknown

P 1 2 3
 30 31 32 33

23. Type of Brakes
 ___ (0) Not truck over 10,000 lbs GVWR (V14≠ 70–78)
 ___ (1) Air
 ___ (2) Hydraulic
 ___ (3) Electric
 ___ (4) Other: _____
 ___ (5) Unknown

34

24. Gross Vehicle Weight Rating (GVWR)
 ___ (0) Not truck over 10,000 lbs. GVWR (V14≠70–78)
 ___ (1) 10,001-14,000 lbs.
 ___ (2) 14,001-16,000 lbs.
 ___ (3) 16,001-19,500 lbs.
 ___ (4) 19,501-26,000 lbs.
 ___ (5) 26,001-33,000 lbs.
 ___ (6) 33,001 lbs. and above
 ___ (9) Unknown

35

National Accident Sampling System – Continuous Sampling Subsystem: Vehicle Data

FIELD MEASUREMENTS

Complete When Applicable	
End Damage	Side Damage
Undeformed end width _____ Corner shift: A1 _____ A2 _____ End shift at frame (CDC) (check one) < 4 inches _____ ≥ 4 inches _____	Bowing: B1 _____ X1 _____ B2 _____ X2 _____ Bowing constant $\frac{X1 + X2}{2} = \underline{\hspace{2cm}}$

Note Measure C1 to C6 from Driver to Passenger side in Front or Rear impacts--
Rear to Front in Side impacts.

Specific Impact Number	Plane* of C-Measurements	Direct Damage		Field L**	C ₁	C ₂	C ₃	C ₄	C ₅	C ₆	±D
		Width** (CDC)	Max*** Crush								

*Identify the plane at which the C-measurements are taken (e.g., at bumper, above bumper, at sill, above sill, at beltline, etc.) or label adjustments (e.g., free space).

Free space value is defined as the distance between the baseline and the original body contour taken at the individual C locations. This may include the following: bumper lead, bumper taper, side protrusion, side taper, etc. Record the value for each C-measurement and maximum crush.

**Measure and document on the vehicle diagram the beginning or end of the direct damage width and field L (e.g., side damage with respect to undamaged axle).

***Measure and document on the vehicle diagram the location of the maximum crush.

Note Use as many lines/columns as necessary to describe each damage profile.



DAMAGE DESCRIPTION Tire—Wheel Damage a. Rotation physically restricted RF _____ LF _____ RR _____ LR _____ b. Tire deflated RF _____ LF _____ RR _____ LR _____ (1) Yes, (2) No, (8) NA, (9) Unk.	TYPE OF TRANSMISSION _____Manual _____Automatic Average Track: _____ Maximum Width: _____ Curb Weight: _____ Overall Length: _____ Wheel Base: _____ Engine Size: cyl. _____	WHEEL STEER ANGLES (For locked front wheels or displaced rear axles only) RF ± _____° LF ± _____° RR ± _____° LR ± _____° Within ± 5 degrees
--	--	---

Vehicle No.: _____

displ. _____

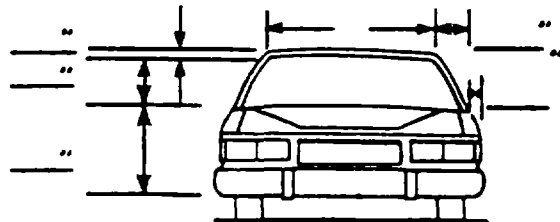
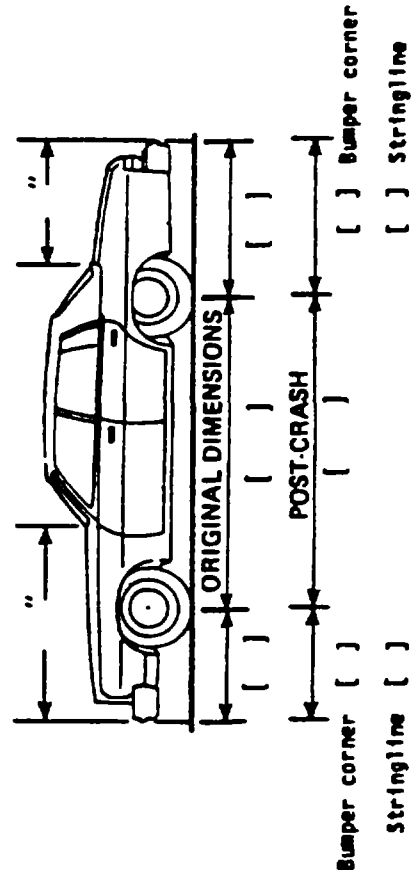
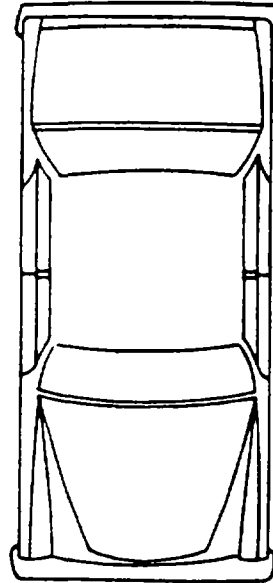
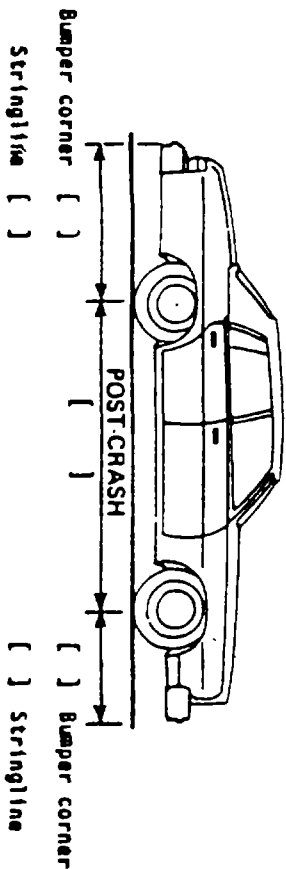
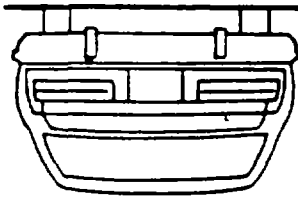

Note: Sketch new perimeter and cross hatch, direct damage and single hatch induced damage on all views. Annotate observations which might be useful in reconstructing the accident (e.g., grass in the hood, direction of striations, scuff on sidewall, etc.)

If pulling trailer sketch type of trailer and damage received on the back of page 3.

Annotate any damage caused by extrication such as component removal by torching, prying or hydraulic shears.

If the vehicle contacted a pedestrian, complete the back of this page.

Pedestrian Impacts Only

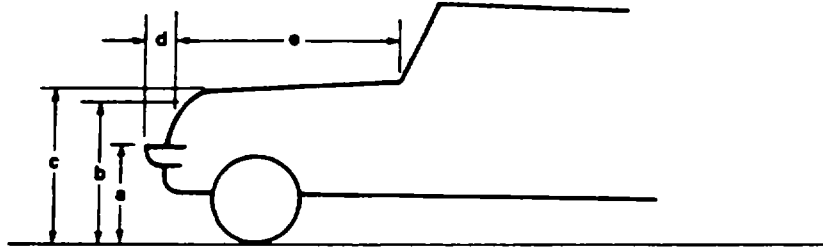

- _____ a. Bumper Height
- _____ b. Contact Height - to end of Vertical
- _____ c. Hood Height - to Horizontal
- _____ d. Bumper Lead
- _____ e. Hood Length
- _____ f. Wrap Distance(s)
- _____
- _____

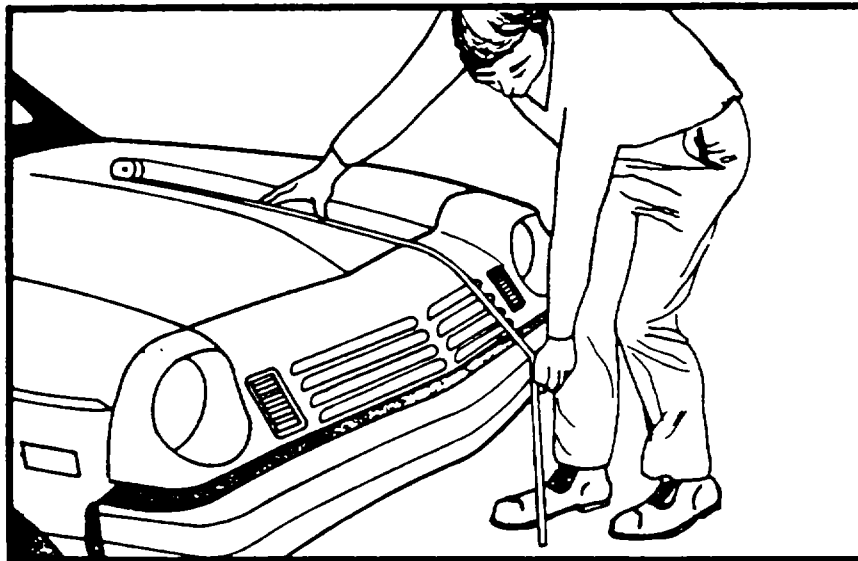

WRAP DISTANCE MEASUREMENT

DEFORMATION CLASSIFICATION by IMPACT NUMBER

Event Number (this vehicle)	Object Contacted	Direction of Force (degrees)	Incremental Value of Shift	(3) Deformation Location	(4) Specific Longitudinal or Lateral Location	(5) Specific Vertical or Lateral Location	(6) Type of Damage Distribution	(7) Deformation Extent Guide	Event Number (in accident)
1	---	---	---	---	---	---	---	---	---
2	---	---	---	---	---	---	---	---	---
3	---	---	---	---	---	---	---	---	---
4	---	---	---	---	---	---	---	---	---

OBJECT CONTACTED

(00) Noncollision
(01) through (30)

If the object contacted by the vehicle under consideration was a motor vehicle in transport, code the Vehicle Number assigned to that vehicle.

Collision with Stationary Object

(31) Motor vehicle not in transport*

(32) Tree (< 6 inches in diameter)

(33) Tree (> 6 inches in diameter)

Highway/Traffic Supports

(34) Luminaire-breakaway

(35) Luminaire-nonbreakaway

(36) Large sign-breakaway

(37) Large sign-nonbreakaway

(38) Small sign-breakaway

(39) Small sign-nonbreakaway

(40) Utility pole

(41) Other post, pole, or support

(42) Traffic signal pole

(43) Fence

(44) Mail box
(45) Delineator
(46) Other movable object:

(47) Culvert
(48) Railroad tracks
(49) Curb
(50) Abutment
(51) Wall (stone, rock, metal, etc.)

(52) Embankment-earth
(53) Embankment-rock, stone or concrete

(54) Building, rigid
(55) Building, nonrigid
(56) Bridge pier or abutment
(57) Bridge rail
(58) Bridge parapet end
(59) Guardrail - bridge rail transition
(60) Guardrail end (non-median)
(61) Guardrail end (median)

(62) Guardrail (non-median)
(63) Guardrail (median)
(64) Concrete barrier (non-median)
(65) Concrete barrier (median)
(66) Other median barrier

(67) Other longitudinal barrier (non-median)

(68) Impact attenuator/Crash cushion
(69) Ground
(70) Train
(71) Ditch
(72) Other stationary/fixd object

Collision with Nonstationary Objects

(73) Animal

(74) Trailer, disconnected in transport

(75) Train

(76) Other nonstationary objects

(81) through (95)

If the object contacted by the vehicle under consideration was pedestrian or nonmotorist, add eighty (80) to the assigned Pedestrian & Nonmotorist Number, and code the resultant sum.

(96) Vehicle occupant

(97) Other object

(99) Unknown

NOTE. For coding of CDC or TDC investigators must refer to appropriate reference documents for accurate coding.

*If this vehicle impacted a vehicle not in transport, fill in the information for that vehicle at the end of the CRASH Program Summary

DEFORMATION CLASSIFICATION

HIGHEST DELTA "V"

Event Number (this vehicle)	Object Contacted	(1) (2) Direction of Force	(3) Deformation Location	(4) Specific Longitudinal or Lateral Location	(5) Specific Vertical or Lateral Location	(6) Type of Damage Distribution	(7) Deformation Extent Guide	Event Number (in accident)
25.	26.	27.	28.	29.	30.	31.	32.	33.
36	37 38	39 40	41	42	43	44	45 46	47
Second								
34.	35.	36.	37.	38.	39.	40.	41.	42.
48	49 50	51 52	53	54	55	56	57 58	59
Third								
43.	44.	45.	46.	47.	48.	49.	50.	51.
60	61 62	63 64	65	66	67	68	69 70	71
Fourth								
52.	53.	54.	55.	56.	57.	58.	59.	60.
72	73 74	75 76	77	78	79	80	81 82	83

Reduction Section

Coding Section

INTERIOR ITEMS

61. Vehicle Identification Number

- No VIN-Code all zeros
- Unknown Code all numbers
- Left justify
- Slash zeros: 0

84 85 86 87 88 89 90 91 92 93 94 95 96 97 98 99 100

62. Registration of Vehicle

- (0) Not registered
- (1) In-state (at least)
- (2) Out-of-state (only)
- (8) Other registration (e.g., federal, foreign, military)
- (9) Unknown

101

63. Vehicle Special Use (this trip)

- (0) No special use
- (1) Taxi
- (2) Vehicle used as school bus
- (3) Vehicle used as other bus
- (4) Military
- (5) Police
- (6) Ambulance
- (7) Fire
- (9) Unknown

102

64. Odometer Reading

- _____ miles. Code mileage to the nearest 1,000 miles
- (000) No odometer
- (001) Less than 1,500 miles
- (997) 996,500 miles or more
- (999) Unknown

103 104 105

65. Passenger Compartment Integrity

- (0) No passenger compartment
- (1) No integrity loss
- Yes, integrity was lost through
- (2) Windshield
- (3) Door (side)
- (4) Door (rear)
- (5) Roof
- (6) Windshield and door (side)
- (7) Other combination of above
- _____
- (9) Unknown

106

66. Passenger Compartment Intrusion (NOTE: Code the area in terms of the most severe intrusion.)

- (0) No passenger compartment
- (1) No intrusion
- (2) Front (i.e., steering column, dash)
- (3) Right side (i.e., door[s] with or without sill override)
- (4) Left side (i.e., door[s] with or without sill override)
- (5) Rear (i.e., trunk, rear seat intruded upon)
- (6) Bottom (i.e., floor)
- (7) Top (i.e., windshield, "A", "B", "C", or "D" pillar[s], roof)
- (8) Two or more areas
- (9) Unknown

107

67. Magnitude of Intrusion

- (0) No intrusion
- (1) Less than five centimeters
- (2) Between five and fifteen centimeters
- (3) Greater than fifteen centimeters
- (9) Unknown

108

68. Fire Occurrence

- (0) No fire
- Yes, fire occurred
- (1) Started in vehicle, minor
- (2) Started in vehicle, major
- (3) Started external to vehicle, minor
- (4) Started external to vehicle, major
- (5) Origin unknown
- (9) Unknown

109

RESTRAINT SYSTEM		Front Seat: Left	Front Seat: Middle	Front Seat: Right	Second Seat: Left	Second Seat: Middle	Second Seat: Right	Third Seat: Left	Third Seat: Middle	Third Seat: Right	Other Position r Unit*
MANUAL	Availability	_____	_____	_____	_____	_____	_____	_____	_____	_____	_____
	Indication of Usage	_____	_____	_____	_____	_____	_____	_____	_____	_____	_____
AUTO-MATIC	Availability	_____	_____	_____	_____	_____	_____	_____	_____	_____	_____
	Function	_____	_____	_____	_____	_____	_____	_____	_____	_____	_____

<p>Manual Restraint System – Availability –</p> <p>___ (0) None available</p> <p>___ (1) Shoulder belt</p> <p>___ (2) Lap belt</p> <p>___ (3) Lap and shoulder belt</p> <p>___ (4) Motorcycle helmet</p> <p>___ (5) Child safety seat (designed without tether or unknown design)</p> <p>___ (6) Child safety seat (designed with tether – properly installed)</p> <p>___ (7) Child safety seat (designed with tether – improperly installed)</p> <p>___ (8) Restraint available type unknown or other.</p> <p>___ (9) Unknown</p> <p>*Specify the Other Position or Unit referenced _____</p>	<p>Manual Restraint System – Indication of Usage</p> <p>___ (0) None used</p> <p>___ (1) Shoulder belt</p> <p>___ (2) Lap belt</p> <p>___ (3) Lap and shoulder belt</p> <p>___ (4) Motorcycle helmet</p> <p>___ (5) Child safety seat – used properly</p> <p>___ (6) Child safety seat – used improperly</p> <p>___ (7) Child safety seat unknown if used properly</p> <p>___ (8) Restraint used-type unknown or other</p> <p>___ (9) Unknown</p>	<p>Automatic (Passive) Restraint System – Availability –</p> <p>___ (0) Not equipped</p> <p>___ (1) Airbag</p> <p>___ (2) Airbag disconnected</p> <p>___ (3) Airbag not reinstalled</p> <p>___ (4) Two point automatic belts</p> <p>___ (5) Three point automatic belts</p> <p>___ (6) Automatic belts destroyed</p> <p>___ (9) Unknown</p>	<p>Automatic (Passive) Restraint System – Function –</p> <p>___ (0) Not equipped</p> <p>___ (1) Automatic belt in use</p> <p>___ (2) Automatic belt not in use</p> <p>___ (3) Deployed airbag</p> <p>___ (4) Non-deployed airbag</p> <p>___ (9) Unknown</p>
---	--	--	--

<p>INDICATIONS of EJECTION</p> <p>___ No ejection</p> <p>Ejection Area</p> <p>___ Windshield</p> <p>___ Left front</p> <p>___ Right front</p> <p>___ Left rear</p> <p>___ Right rear</p> <p>___ Rear</p>	<p><i>If ejection is suspected or reported, indicate the avenue; for multiple avenues number them and utilize the same numbers consistently throughout.</i></p> <p>___ Roof</p> <p>___ Other area (e.g., sidecar, back of pickup, etc.)</p> <p>___ Unknown</p>	<p>Ejection Medium</p> <p>___ Door (side)</p> <p>___ Door (rear)</p> <p>___ Open roof structure</p> <p>___ Fixed windows</p> <p>___ Other medium type</p> <p>___ Unknown</p>	<p>Medium Status</p> <p>___ Open</p> <p>___ Separation</p> <p>___ Closed, closed when damaged</p> <p>___ Integral structure ripped opened</p> <p>___ Status unknown</p> <p>Operable windows</p> <p>___ Roll down type</p> <p>___ Hinged typed</p> <p>___ Sliding type</p> <p>___ Other type window</p>
---	--	---	--

CHECK ALL AREAS of SUSPECTED OCCUPANT CONTACT

<p>FRONT</p> <p>___ Windshield</p> <p>___ Mirror</p> <p>___ Steering assembly, including transmission selector level when column mounted</p> <p>___ Add-on equipment (e.g., CB, tape deck, air conditioner)</p> <p>___ Instrument panel and below, excluding foot controls and parking brake</p> <p>___ Sunvisor</p> <p>___ Other front object</p> <p>SIDE</p> <p>___ Side interior surface, excluding hardware or armrests</p> <p>___ Side hardware or armrests</p> <p>___ A pillar</p> <p>___ B pillar</p> <p>___ Other pillar</p> <p>___ Window glass or frame</p> <p>___ Other side object</p>	<p>INTERIOR</p> <p>___ Seat, back support</p> <p>___ Belt restraint system</p> <p>___ Head restraint</p> <p>___ Air cushion</p> <p>___ Other occupants</p> <p>___ Interior loose objects</p> <p>___ Other interior object</p> <p>ROOF</p> <p>___ Front header</p> <p>___ Rear header</p> <p>___ Roof side rails</p> <p>___ Roof or convertible top</p> <p>FLOOR</p> <p>___ Floor</p> <p>___ Floor or console mounted transmission lever, including console</p> <p>___ Parking brake handle</p> <p>___ Foot controls including parking brake</p>	<p>REAR</p> <p>___ Backlight (rear window)</p> <p>___ Backlight storage rack, door, etc.</p> <p>___ Other rear objects</p> <p>EXTERIOR of OCCUPANT'S VEHICLE</p> <p>___ Hood</p> <p>___ Outside hardware (e.g., outside mirror, antenna)</p> <p>___ Other exterior surface or tires</p> <p>___ Unknown exterior objects</p>
--	--	---

VEHICLE INTERIOR
POINTS OF OCCUPANT CONTACT

CONTACT	INTERIOR PART CONTACTED	SUPPORTIVE PHYSICAL EVIDENCE	Confidence Level of Contact Point
A			1 2
B			1 2
C			1 2
D			1 2
E			1 2
F			1 2
G			1 2
H			1 2

If Additional Contact Points, Continue on Reverse Side

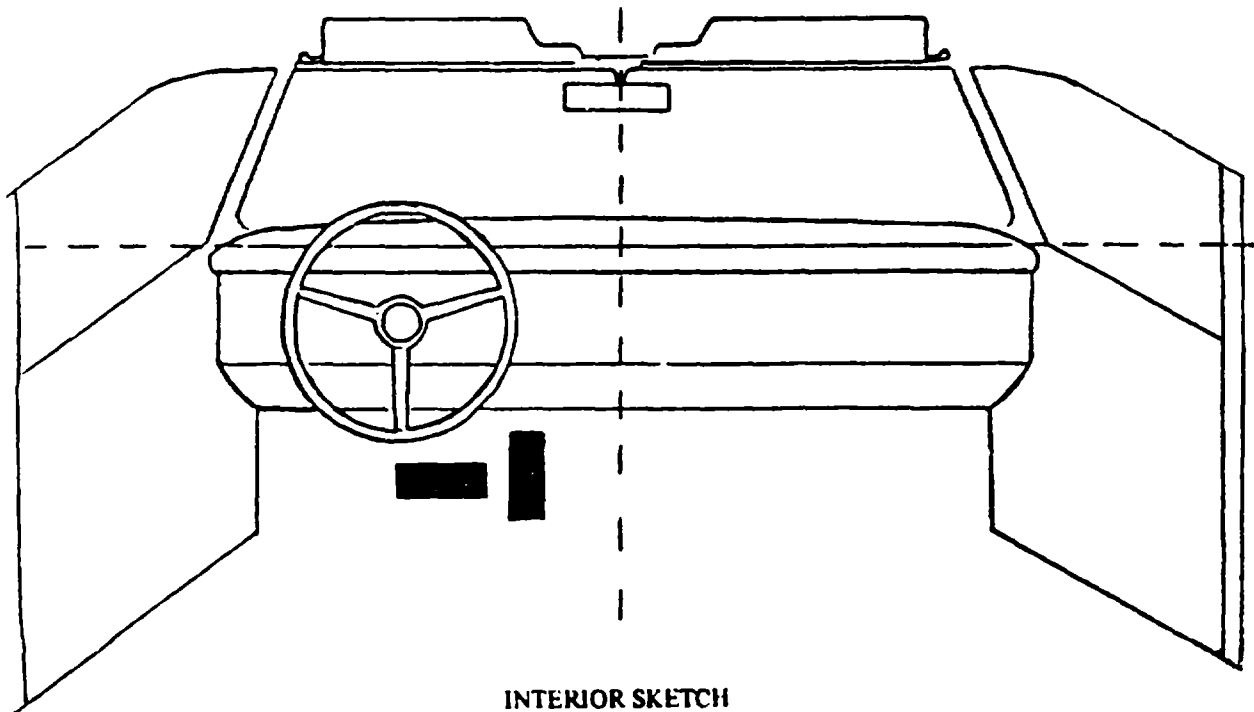
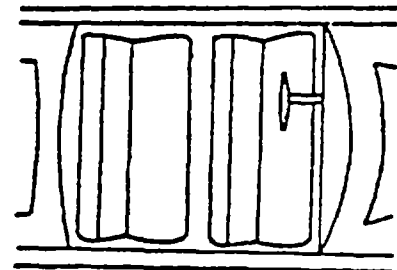
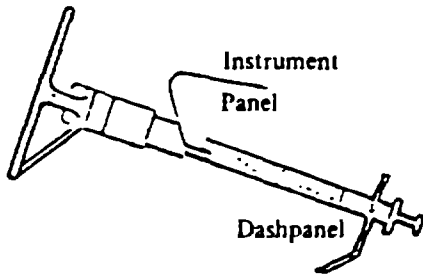

INTERIOR SKETCH

Sketch controls in appropriate positions, if contacted. Sketch and describe all occupant contact points (i.e., dents, skin transfer, etc.) and code on preceding page. Dash lines indicate center of instrument panel-windshield area and top of panel for reference purposes.

Codes for Confidence Level of Contact Point are: Certain - 1; and possible - 2.

SUPPLEMENTAL ITEMS

69. Most Severe Impact This Vehicle
This Vehicle Role

- (0) Nonimpact
- (1) Front of this vehicle
- (2) Left side of this vehicle
- (3) Right side of this vehicle
- (4) Rear of this vehicle
- (5) Other impact location
- (9) Unknown impact type

110

70. Role of Other Contacted Vehicle, Object or Person (for same impact as above)

- (0) Nonimpact
- (1) Front of other vehicle
- (2) Side of other vehicle
- (3) Rear of other vehicle
- (4) Intraunit damage
- (5) Other location on other vehicle
- (6) Object (stationary and non stationary)
- (7) Pedestrian or nonmotorist
- (8) Motorcycle or moped
- (9) Unknown impact type

111

71. Rollover

- (0) No rollover
- (1) Rollover, less than 4 quarter turns
- (2) Rollover, 4 or more quarter turns
- (3) Rollover, details unknown

112

72. Jackknife

- (0) Not an articulated vehicle
- (1) No
- (2) Yes

113

73. Submission of Potential Safety Problem Bulletin

- (0) No
- (1) Yes

114

74. Hazardous Cargo

- (0) No hazardous cargo
- (1) Load of hazardous materials only
- (2) Load of hazardous and nonhazardous materials
- (9) Unknown

115

NOTE: (See coding manual for definition and examples of hazardous materials)

VEHICLE WEIGHT ITEMS

75. Vehicle Curb Weight

- _____ pounds - Code weight to nearest 100 pounds.
- (001) Less than 150 pounds.
- (997) 99,650 lbs or more
- (999) Unknown

116 117 118

Source: _____

76. Vehicle Cargo Weight

- _____ pounds - Code weight to nearest 100 pounds.
- (000) Less than 50 pounds
- (997) 99,650 lbs or more
- (999) Unknown

119 120 121

77. Investigator Reported Source of Cargo Weight

- (0) No cargo
- (1) Measured
- (2) Estimated
- (3) Rated capacity
- (9) Unknown: source or weight

122

COMMENTS

LOG RESPONSES

Key to Vehicle Documentation

17. Damage Measurements

- (1) Complete – All applicable field measurements (post-crash measurements, direct and induced damage, C-measurements, maximum crush, shifting, bowing, intrusion damage description, wheel steer angles, etc.) are documented using standard investigative techniques.
- (2) Partial – Only relevant field measurements are documented; measurements are incomplete or incorrect.
- (3) Incomplete – Vehicle documentation is poor. Field measurements are obviously incorrect and/or incomplete.
- (4) Vehicle not inspected or catastrophic conditions.
- (5) Not required

18. Original Dimensions

- (1) Complete – All original dimensions (overall length, maximum width, wheelbase measurements, front and rear overhangs, undeformed end width, etc.) are documented
- (2) Partial – Only relevant dimensions are documented; measurements are incomplete or incorrect.
- (3) Incomplete – The majority of relevant dimensions are excluded.
- (4) Vehicle not inspected
- (5) Not available/unable to obtain.

19. Areas of Contact

- (1) Complete – All damaged areas are documented and annotated (i.e., all impact-related damage, previous damage, damage from towtruck, Jaws of Life, etc.
- (2) Partial – Only relevant impact areas are documented. Previous or unexplained damage not annotated
- (3) Incomplete – Obvious impact-related damage overlooked or incomplete documentation of damage.
- (4) Vehicle not inspected or catastrophic conditions.

20. Occupant Contacts

- (0) No evidence of occupant contact.
- (1) Complete – All occupant contacts and/or suspected contact points are sketched and described.
- (2) Partial – Only obvious contact points are documented; suspected contact points are not noted.
- (3) Incomplete – Obvious occupant contact points are not documented.
- (4) Vehicle not inspected.
- (5) Vehicle interior not inspected.

NOTE. Access to vehicle interior should be taken into consideration.

COMPLETED BY TEAM

1. Primary Sampling Unit Number	1	2
2. Case Number - Stratification	3	4 5 6
3. Record Number	7	
4. Transaction Code	8	
5. Version Number	9	
6. Investigator I.D. Number	10	

VEHICLE INSPECTION

7. Vehicle Number	11	12
8. Reason Vehicle Registration Records are not obtainable		
(0) Not required-vehicle inspected		
(1) Records obtained		
(2) Hit & Run vehicle-no information		
(3) Records not found		
(4) Vehicle not registered		
(5) Registration number incorrect		
(6) No information on vehicle		
(7) Out of state or foreign registration		
(8) To be updated		
(9) Record not received before file closed		13
9. Date vehicle inspected and field data elements obtained	14	15 16 17 18 19
10. Completing Person		20
11. Reason Vehicle Inspection Not Completed		
(00) Not required		
(01) Inspection completed		
(02) Vehicle can not be located		
(03) Vehicle repaired or destroyed		
(04) Vehicle outside of study area		
(05) Vehicle impounded		
(06) Vehicle sold		
(07) Hit and run vehicle		
(08) Owner could not be located		
(09) Owner refusal		
(10) Insurance company refusal		
(11) Attorney refusal or litigation		
(12) Repair or tow facility refusal		
(13) Stolen		
(14) Wrong name and address on PAR		
(15) Interstate truck		
(16) Commercial vehicle unavailable		
(17) Other _____		21 22
12. Reason Highest Total Delta V Unknown		
(1) Highest total delta V known-based on damage data only		
(2) Highest total delta V known-based on damage and trajectory data		
(3) Rollover		
(4) Other nonhorizontal force (e.g., vaulting)		
(5) Sideswipe type damage/severe overrides		
(6) Vehicle out of scope/pedestrian		
(7) Yielding object		
(8) Other (e.g., animal) _____		
(9) Insufficient data		23
13. Confidence in CRASH Results (for Highest Delta V)		
(0) No CRASH		
(1) Collision fits model-results appear reasonable		
(2) Collision fits model-results appear high		
(3) Collision fits model-results appear low		
(4) Bcdeline reconstruction-results appear reasonable		24

14. CRASH Output on Other than Highest Delta V		
___ (0) No-CRASH output for highest delta V or no CRASH run		
___ (1) Yes-CRASH run on a secondary CDC		25
15. DATA OBTAINED FOR THIS VEHICLE'S MOST SEVERE IMPACT: REGARDLESS OF USAGE		
(00) No data obtained		
(01) CDC only		
(02) TDC only		
(03) Crush profile* only (outside scope of CDC/TDC)		
(04) Trajectory data only		
(05) CDC and crush profile only		
(06) TDC and crush profile only		
(07) CDC and trajectory		
(08) TDC and trajectory		
(09) Crush profile* (outside scope of CDC/TDC) and trajectory		
(10) CDC, crush profile and trajectory		
(11) TDC, crush profile and trajectory		26 27

*For vehicles outside the scope of CDC/TDC, crush profile means damage sketch and applicable measurements.

COMPLETED BY ZONE CENTER

(See back of page 8 for responses to questions 17-20)

16. Were Measuring Stands Used		
___ (1) No-stands omitted or incorrectly placed		
___ (2) Yes-stands correctly used		
___ (3) Vehicle not inspected or catastrophic conditions		
___ (4) Stands not required		28
17. Damage Measurements		
___ (1) Complete		
___ (2) Partial		
___ (3) Incomplete		
___ (4) Vehicle not inspected or catastrophic conditions		
___ (5) Not required		29
18. Original Dimensions		
___ (1) Complete		
___ (2) Partial		
___ (3) Incomplete		
___ (4) Vehicle not inspected		
___ (5) Not available/unable to obtain		30
19. Areas of Contact		
___ (1) Complete		
___ (2) Partial		
___ (3) Incomplete		
___ (4) Vehicle not inspected or catastrophic conditions		31
20. Occupants Contacts		
___ (0) No evidence of occupant contact		
___ (1) Complete		
___ (2) Partial		
___ (3) Incomplete		
___ (4) Vehicle not inspected		
___ (5) Vehicle interior not inspected		32
21. Date Official Record Update Received	33	34 35 36 37 38
22. Reviewed By		39 40



VEHICLE FOR NON-TOWAWAY ACCIDENT

1. Primary Sampling Unit Number	1	2
2. Case Number - Stratification	3	4 5 6
3. Record Number	3	7
4. Transaction Code	8	
5. Version Number	7	9
6. Investigator I.D. Number	10	

IDENTIFICATION

7. Vehicle Number	11	12
8. Number of Occupant Forms Submitted		
Code only the number of occupants in this vehicle for which an OCCUPANT FORM was submitted.		
(97) 97 or more	13	14
9. Vehicle Role		
(0) Noncollision		
(1) Striking unit		
(2) Struck unit		
(3) Both striking and struck		
(9) Unknown		15
10. Manner of Leaving Scene (Determined by Investigator)		
(1) Driven		
(2) Towed - due to vehicle damage		
(3) Towed - not due to vehicle damage		
(4) Abandoned		
(9) Unknown		16

EXTERIOR ITEMS

11. Vehicle Model Year		
Code the last two digits of the model year.		
(99) Unknown	17	18
12. Vehicle Make		
Applicable codes are found in your NASS Data Collection, Coding and Editing Manual.		
(99) Unknown	19	20
13. Vehicle Model		
Applicable codes are found in your NASS Data Collection, Coding and Editing Manual.		
(00) Unknown		
(69) Unknown (motorcycle)	21	22
(79) Unknown (light truck)		
(89) Unknown (truck)		
(99) Unknown (automobile)		

14. Body Type

Automobiles

- (01) Convertible (excludes sun-roof, t-bar)
- (02) 2-door sedan, hardtop, coupe
- (03) 3-door/2-door hatchback
- (04) 4-door sedan, hardtop
- (05) 5-door/4-door hatchback
- (06) Station wagon (excluding van and truck based)
- (08) Other automobile type
- (09) Unknown automobile type

Automobile Derivatives and Short Utility Vehicles

- (10) Auto based pickup (includes El Camino, Caballero, Ranchero, Brat)
- (11) Auto based panel (cargo station wagon, includes auto based ambulance/hearse)
- (12) Short utility - not truck based (includes Jeep CJ-5, Jeep CJ-7, Renegade, Landrover, Pre-78 Bronco, Landcruiser, Thing)
- (13) Large limousine - more than four side doors or stretched chassis

Motorcycles

- (20) Motorcycle
- (21) Mopeds (motorized bicycles)
- (28) Other motorcycle (minibikes, motorscooters)
- (29) Unknown motorcycle type

Bus (excludes van based)

- (30) School bus (designed to carry students, not cross country or transit)
- (31) Cross country/intercity (designed for long distance)
- (32) Transit bus (includes short ride city bus and medium range suburban bus)
- (38) Other bus (e.g., bus based motorhome)
- (39) Unknown bus type

Van Based Light Truck (< 10,000 lbs GVWR)

- (40) Van (includes VW bus, Vanagon, Kombi, Beauville, Chateau, Club Wagon, Sportman; excludes moving van)
- (41) Van-commercial cutaway (includes box van, multi-stop, parcel, van pickups)
- (42) Van based motorhome
- (48) Other van type
- (49) Unknown van type

Light Conventional Truck (Pickup style cab, < 10,000 lbs. GVWR)

- (50) Pickup (includes open box and caps)
- (51) Pickup with slide-in camper
- (52) Pickup based motorhome (chassis mounted)
- (53) Cab chassis based (includes rescue vehicles, light stake, dump, and tow trucks)
- (54) Truck based panel
- (55) Truck based station wagon (4-door; includes Suburban, Travellall, Wagoneer)
- (56) Truck based utility (2-door; includes Blazer, Bronco - 78 on, Jimmy, Ramcharger, Cherokee, Trailduster, Scout)
- (58) Other light conventional truck (e.g., stretched Suburban limousine)
- (59) Unknown light conventional truck
- (69) Unknown light truck (van or pickup)

Medium/Heavy Truck (> 10,000 lbs GVWR)

- (70) Step vans
- (71) Single unit straight truck (10,000 lbs < GVWR < 26,000 lbs.)
- (72) Single unit straight truck (> 26,000 lbs. GVWR)
- (73) Medium/heavy truck based motorhome
- (74) Truck-tractor with no cargo trailer
- (75) Truck-tractor pulling one or more trailers
- (77) Truck-tractor (unknown if pulling trailer)
- (78) Unknown medium/heavy truck type
- (79) Unknown truck type (light/medium/heavy)

Other Vehicles

- (80) Snowmobile
- (81) Farm equipment other than trucks
- (82) ATV, all terrain vehicle (e.g., dune/swamp buggy)
- (83) Construction equipment other than trucks (e.g., grader, off road)
- (88) Other (e.g., go cart, fork lift, city street sweeper)
- (89) Unknown other vehicle:
- (99) Unknown body type

NON-TOWAWAY VEHICLE LOG

COMPLETED BY TEAM

<p>1. Primary Sampling Unit Number 1 2</p> <p>2. Case Number -- Stratification 3 4 5 6</p> <p>3. Record Number 3</p> <p>4. Transaction Code 8</p> <p>5. Version Number 7</p> <p>6. Investigator I.D. Number 10</p>	<p>9. Date vehicle inspected and field data elements obtained 0 0 0 0 8 14 15 16 17 18 19</p> <p>10. Completing Person 0 20</p> <p>11. Reason Vehicle Inspection Not Completed</p> <ul style="list-style-type: none"> (00) Not required (01) Inspection completed (02) Vehicle can not be located (03) Vehicle repaired or destroyed (04) Vehicle outside of study area (05) Vehicle impounded (06) Vehicle sold (07) Hit and run vehicle (08) Owner could not be located (09) Owner refusal (10) Insurance company refusal (11) Attorney refusal or litigation (12) Repair or tow facility refusal (13) Stolen (14) Wrong name and address on PAR (15) Interstate truck (16) Commercial vehicle unavailable (17) Other: _____ 0 0 21 22
VEHICLE INSPECTION	
<p>7. Vehicle Number 11 12</p> <p>8. Reason Vehicle Registration Records are not obtainable</p> <ul style="list-style-type: none"> (0) Not required--vehicle inspected (1) Records obtained (2) Hit & Run vehicle--no information (3) Records not found (4) Vehicle not registered (5) Registration number incorrect (6) No information on vehicle (7) Out of state or foreign registration (8) To be updated (9) Record not received before file closed 13 	<p style="text-align: center;">COMPLETED BY ZONE CENTER:</p> <p>21. Date Official Record Update Received 8 33 34 35 36 37 38</p> <p>22. Reviewed By 39 40</p>

--STOP FORM COMPLETE--

This vehicle is from an accident sampled in the Nontowaway strata "Y" or "Z".

Neither the inspection nor photographs of this vehicle are required.



CRASH Program Summary

This form presents the CRASH Program summary information for traffic units numbered: **NASS**

	Vehicle No.	Make	Model
First Vehicle	_____	_____	_____
Second Vehicle	_____	_____	_____

Primary Sampling Unit Number _____

Case Number - Stratification _____

Common Impact Number _____

2. VEHICLE SIZE/WEIGHT?

Veh #1	Class	Occupant	Cargo	Curb	Weight:
_____	_____	_____	_____	_____	_____
Veh #2	Class	Occupant	Cargo	Curb	Weight:
_____	_____	_____	_____	_____	_____

3. Veh #1 CDC _____
PDOF _____ ± _____

4. Veh #2 CDC _____
PDOF _____ ± _____

5. VEHICLE STIFFNESS?

Veh #1 _____
Veh #2 _____

6. KNOWLEDGE of REST and IMPACT POSITIONS?

_____ No - skip to 38. - Damage Dimensions
_____ Yes

7. REST Veh #1 X _____
Y _____
↓ _____

Veh #2 X _____
Y _____
↓ _____

8. IMPACT

Veh #1 X _____
Y _____
↓ _____

Veh #2 X _____
Y _____
↓ _____

9. Slide slip angles PRIOR to impact?

_____ No - skip to 11.
_____ Yes

10. Slip angles

Veh #1 _____ ± _____
Veh #2 _____ ± _____

11. SUSTAINED CONTACT?

_____ No
_____ Yes

12. Did Vehicle One SLIDE SIDEWAYS?

_____ No - skip to 15.
_____ Yes:

13. Did rotation cease prior to final rest?

_____ No - skip to 15.
_____ Yes:

14. Location X _____
Y _____
↓ _____

15. Was Vehicle One's PATH CURVED?

_____ No - skip to 17.
_____ Yes:

16. Point on Path X _____
Y _____

17. Did Vehicle One ROTATE?

_____ None - skip to 19.
_____ Clockwise:
_____ Counterclockwise:

18. More than 360 degrees?
_____ No
_____ Yes

19. Did Vehicle Two SLIDE SIDEWAYS?

_____ No - skip to 22.
_____ Yes:

20. Did rotation cease prior to final rest?

_____ No - skip to 22.
_____ Yes:

21. Location X _____
Y _____
↓ _____

22. Was Vehicle Two's PATH CURVED?

_____ No - skip to 24.
_____ Yes:

23. Point on Path X _____
Y _____

24. Did Vehicle Two ROTATE?

_____ None skip to 26.
_____ Clockwise:
_____ Counterclockwise:

25. More than 360 degrees

_____ No
_____ Yes

26. COEFFICIENT of FRICTION? _____

National Accident Sampling System - Continuous Sampling Subsystem: CRASH Program Summary

<p>27. ROLLING RESISTANCE? [Option (1) or (2)]</p> <p>(1) Proportion of Braking Each Wheel</p> <p>28. Veh #1 RF ___ ___ LF ___ ___ RR ___ ___ LR ___ ___</p> <p>29. Veh #2 RF ___ ___ LF ___ ___ RR ___ ___ LR ___ ___</p> <p>OR</p> <p>(2) Longitudinal Deceleration</p> <p>30. Veh #1 ___ . ___ ___</p> <p>31. Veh #2 ___ . ___ ___</p> <p>32. TRAJECTORY SIMULATION?</p> <p>___ No - skip to 38.</p> <p>___ Yes: Steer angles?</p> <p>33. Veh # 1 RF ___ ___ LF ___ ___ RR ___ ___ LR ___ ___</p> <p>34. Veh # 2 RF ___ ___ LF ___ ___ RR ___ ___ LR ___ ___</p> <p>35. TERRAIN BOUNDARY?</p> <p>___ No - skip to 38.</p> <p>___ Yes: Boundary Points?</p> <p>36. XBP1 ___ ___ ___ ___ YBP1 ___ ___ ___ ___ XBP2 ___ ___ ___ ___ YBP2 ___ ___ ___ ___</p> <p>37. SECONDARY FRICTION COEFFICIENT? ___ . ___ ___</p>	<p>38. Are DAMAGE DIMENSIONS Known?</p> <p>___ No - PROGRAM COMPLETED!</p> <p>___ Yes: Dimensions in Inches</p> <p>39. Side damage</p> <p>42. End damage Veh #1 L ___ ___ ___</p> <p>40. Side damage</p> <p>43. End damage C₁ ___ ___ ___ C₂ ___ ___ ___ C₃ ___ ___ ___ C₄ ___ ___ ___ C₅ ___ ___ ___ C₆ ___ ___ ___</p> <p>41. Side damage</p> <p>44. End damage D± ___ ___ ___</p> <p>45. Side damage</p> <p>48. End damage Veh # 2 L ___ ___ ___</p> <p>46. Side damage</p> <p>49. End damage C₁ ___ ___ ___ C₂ ___ ___ ___ C₃ ___ ___ ___ C₄ ___ ___ ___ C₅ ___ ___ ___ C₆ ___ ___ ___</p> <p>47. Side damage</p> <p>50. End damage D± ___ ___ ___</p>
--	---

If this Common Impact was with a Motor Vehicle *Not In Transport*, fill in the information below.

Model Year: _____	Make: _____	The CDC, crush profile (C ₁ through C ₆), and trajectory measurements for this vehicle should be recorded above.
Curb Weight: _____ lbs	Model: _____	
Cargo Weight: _____ lbs		
Total Occupant Weight: _____ lbs	VIN: _____	

Complete and ATTACH the appropriate schematic and damage dimensions (Vehicle Form - page 3 and 3A-3P) to this Form.

Delete Identifier After Case Review



OLDMISS Program Summary

1. TITLE Primary Sampling Unit Number _____
 Case Number - Stratification _____
 Common Impact Number _____

	Year	Make	Model	NASS Veh #
OLDMISS Veh. # 1	_____	_____	_____	_____
OLDMISS Veh. # 2	_____	_____	_____	_____

2. Size Category?
 Vehicle # 1 _____
 Vehicle # 2 _____

7. For Which Vehicle Is The Damage Known? _____
 8. Damage Width For Known Vehicle? (Inches)
 L _____

3. Stiffness Category?
 Vehicle # 1 _____
 Vehicle # 2 _____

9. Number Of Crush Measurements For Known Vehicle?
 (2, 4 or 6) _____

4. Vehicle Weights? (Lbs.)

	Curb	Occupant(s)	Cargo	
Veh. # 1	_____ +	_____ +	_____ =	_____*
Veh. # 2	_____ +	_____ +	_____ =	_____*

*(Ø = Unknown)

10. Crush Measurements For Known Vehicle? (Inches)
 C₁ _____
 C₂ _____
 C₃ _____
 C₄ _____
 C₅ _____
 C₆ _____

5. Vehicle Heading Angles At Impact?
 ψ Vehicle # 1 ± _____°
 ψ Vehicle # 2 ± _____°

11. Damage Midpoint Offset For Known Vehicle? (Inches)
 D± _____

6. Damaged Area Of Each Vehicle?
 Vehicle # 1 _____
 Vehicle # 2 _____
 (F = Front, B = Back, L = Left, R = Right)

12. PDOF In Degrees For Known Vehicle? (-360 to 360°)
 ± _____

13. Estimated Damage Midpoint Offset For Unknown Vehicle? (Inches)
 D± _____

13. Estimated Damage Midpoint Offset For Unknown Vehicle? (Inches)
 D± _____

VEHICLE FORM

V06

Variable Name: Investigator I.D. Number

Format: 1 column - numeric

Beginning
Column 10

Element Values:

Level 1 Range: 1 through 9

Source: Zone center.

Remarks:

The person who was primarily responsible for the completion of the Vehicle Form shall enter his/her unique number.

Each investigator's unique number is assigned by the PSU's Zone Center.

This variable is a mandatory variable and cannot be changed.

Variable Name: Vehicle Number

Format: 2 columns - numeric

Beginning
Column 11

Element Values:

Level 1 Range: 01 through 30

Source: Investigator determined.

Remarks:

This variable is a mandatory variable and cannot be changed.

Numbers assigned to vehicles must be consecutive starting with 01 with no missing numbers. Each motor vehicle in transport must be assigned a unique number.

Vehicles shall be numbered according to their entry into the impact sequence. If there is only one vehicle in the accident, the vehicle has to be coded as vehicle number one. (NOTE: However, if there is only one vehicle and that vehicle was struck by a pedestrian, then vehicle number one can be a struck vehicle.)

In multiple vehicle collisions, in which one (moving) vehicle strikes another with its front, that vehicle shall be given the lower number in the sequence. However, in a head-on collision, the vehicle on the wrong side of the road shall be given the lower number in the sequence.

For impacts in which no (moving) vehicle has frontal damage, the vehicle that has encroached upon the other shall be given the lower number in the sequence (e.g., vehicle one backs into the front of stopped vehicle two, and classical sideswipes where A10, Manner of Collision, equals "5" (Sideswipe, same direction) or "6" (Sideswipe, opposite direction)).

A vehicle that sets an object in motion which strikes or is struck by another motor vehicle, prior to stabilization of the object, shall be given the lower number in the sequence (even if it sustains no damage or its occupants are not injured).

In the instance where one motor vehicle is towing another, the vehicle number or numbers assigned depends on the accident circumstances and the type of linkage between the vehicles. If the linkage between the vehicles is fixed (e.g., tow bar, cradle, etc.), then the combination is one vehicle.

VEHICLE FORM

V07
(2)

Variable Name: Vehicle Number (cont'd.)

If either component is involved in the accident, the power unit component is assigned a vehicle number. If the linkage is nonfixed (e.g., rope, chain, etc.), then assign a vehicle number to each component involved in the accident. If the linkage is nonfixed, then each vehicle is considered to be in transport. A fixed linkage is defined as one which has the property of keeping the towed unit separated from the power unit by a distance which is essentially constant. Included within this definition are cradle linkages where the towed unit has two or more wheels off the ground.

Do not assign a number to any struck motor vehicle not in transport (e.g., a vehicle parked out of the roadway). A Vehicle Form is not to be completed for these vehicles; nor is a Driver Form to be completed. Any occupants they contain, including a person who was intent on driving the vehicle, are to be handled using the Pedestrian & Nonmotorist Form. However, the vehicle should be shown on the accident diagram and referred to as P-1, etc. Also, data which may be required to exercise the CRASH program is to be collected. The necessary data questions are located at the bottom of the second page of the CRASH Program Summary.

Variable Name: Number of Occupant Forms Submitted

Format: 2 columns - numeric

Beginning
Column 13

Element Values:

Level 1 Range: 00 through 97
97 97 or more

Source: Investigator determined--inputs include police report, vehicle inspection, driver interviews, and other interviewees.

Remarks:

Code only the number of occupants in this vehicle for which an Occupant Form was submitted.

The value coded here should agree with the value coded on variable D08, Number of Occupants This Motor Vehicle, unless: (1) the actual number of occupants in this vehicle is unknown (D08 equal "99"), or (2) this vehicle qualifies under the "special bus rule" cited in section 4.2, page 53.

Code "01" (one occupant) is used in the case of a hit-and-run vehicle, where it is assumed that only one occupant/driver was present. Additional Occupant Forms (and thus the number coded here) can be submitted if reliable evidence exists that additional occupants were present.

This variable is a mandatory variable and cannot be changed.

Variable Name: Vehicle Role

Format: 1 column - numeric

Beginning
Column 15

Element Values:

- 0 Noncollision
- 1 Striking unit
- 2 Struck unit
- 3 Both striking and struck
- 9 Unknown

Source: Investigator determined from all available information.

R marks:

Code "0" (Noncollision) only when the noncollision occurred first, even if subsequent impacts occurred. Noncollision includes overturned (which includes overturning motorcycles), fire/explosion, jackknifed, or immersion. A vehicle that sets an object (e.g., cargo, spewed gravel, etc.) in motion which strikes or is struck by another motor vehicle prior to stabilization of the object is coded as "0". The other motor vehicle (if in transport) is either a striking unit ("1") or a struck unit ("2") depending on whether or not the unit is in motion or stationary.

A vehicle must be in motion to be a striking vehicle. If the vehicle was not in motion, then it was struck. If a vehicle in motion contacts an object with its leading end and/or side (including an object that was set in motion by another motor vehicle), then the vehicle is striking.

If a vehicle in motion contacts another vehicle, pedestrian, or nonmotorist with its front, then the vehicle is striking. For example, in a head-on collision both vehicles are striking. If a vehicle is moving forward and is not in rotation and contacts another vehicle, pedestrian, or nonmotorist with other than its front (with one exception), then the vehicle is struck. The exception is for sideswiping vehicles. Both sideswiping vehicles are striking. Sideswiping includes front or rear endswipes.

For a vehicle to be both striking and struck it must sustain two impacts such that they did not occur with the same vehicle (e.g., side-slap), object, pedestrian, or nonmotorist. If the impacts occurred at the same location on this vehicle, they must have occurred at different points in time in the accident sequence. The classical example of a vehicle which is both striking and struck is the chain reaction rear-end where the vehicle which is striking and struck is located within the chain.

A vehicle that impacts an object and sends that object into another vehicle, or another vehicle's path, is coded as "1", striking unit.

VEHICLE ROLE (V09)

MOTOR VEHICLE UNDER CONSIDERATION (BEING INSPECTED)		NOT TRACKING	
TRACKING (Includes Controlled Turn)		(Significant yaw and/or Rotation)	
OTHER VEHICLE/OBJECT/ Pedestrian or Nonmotorist	STATIONARY	CONTACTS ITS LEADING END (Back or Front)	CONTACTS ITS LEADING END AND/OR SIDE ² IS CONTACTED
VEHICLE IN MOTION	STRIKING	STRIKING	STRIKING
OBJECT IN MOTION	STRIKING	STRIKING	STRIKING
STATIONARY VEHICLE OR OBJECT	SHOULD NOT OCCUR	STRIKING	SHOULD NOT OCCUR
PEDESTRIAN OR NON-MOTORIST	STRIKING	STRIKING	STRIKING

1. Leading End (Tracking): That end (Back or Front) of the vehicle under consideration which passes over a section of terrain before its opposite end.

2. Leading End and/or Side (Not Tracking): That end and/or side (Back, Front, Left or Right) of the vehicle under consideration which passes over a section of terrain before its opposite end and/or side.

3. Exception: Code "Striking" in those cases where the vehicle under consideration overtakes or undercuts the other vehicle/object/pedestrian or nonmotorist.

a. Overtaking: The vehicle under consideration is passing the other vehicle/object/pedestrian or nonmotorist and contacts the other vehicle/object/pedestrian or nonmotorist with its side.

b. Undercutting: The vehicle under consideration "cuts a corner" or turns in such a manner as to contact with its side the other vehicle/object/pedestrian or nonmotorist which is stationary or moving in the same general direction.

EG:

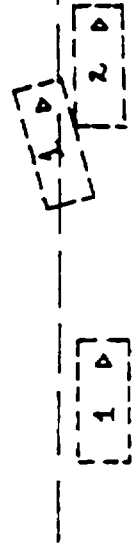

EG:

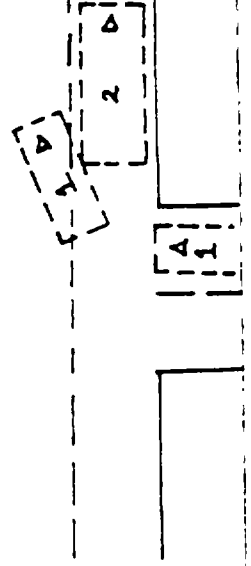

Variable Name: Manner of Leaving Scene (Determined by Investigator)

Format: 1 column - numeric

Beginning
Column 16

Element Values:

- 1 Driven
- 2 Towed - due to vehicle damage
- 3 Towed - not due to vehicle damage
- 4 Abandoned
- 9 Unknown

Source: Investigator determined--inputs include vehicle inspection, interviews, wrecker operators, police report.

Remarks:

This variable measures the disposition of the vehicle or power unit of an articulated combination at the accident scene.

The source of information for selecting an element value is the investigator, based on his/her final information which may be different from the police report. The investigator is reminded to determine if any difference here from the police report will affect the Final Stratification (A08). Strata O, R, V, W, Y and Z are possibly affected as shown in the examples as follows:

- o Accident is stratified as "Z" in the Case Number-Stratification (A02) and subsequent investigation revealed that a vehicle was in fact towed; therefore, Final Stratification (A08) is coded as "W" or "V" depending on whether occupant was transported to hospital or not.
- o Accident is stratified as "R" in the Case Number-Stratification (A02) and subsequent investigation revealed that a vehicle was in fact not towed; therefore, Final Stratification (A08) is coded as "Y".

In terms of its effect on Final Stratification (A08), it makes no difference why the vehicle was towed (i.e., codes "2" or "3" below).

Code "2" (Towed - due to vehicle damage) refers to any towing which is due to disabling damage caused by this accident which prohibits vehicle movement under its own power.

Code "3" (Towed - not due to vehicle damage) refers to those cases where the

Variable Name: Manner of Leaving Scene (Determined by Investigator)
[cont'd.]

towing results from other than damage (e.g., mired vehicles, driver arrested, etc.).

For Y and Z cases, vehicles which are discovered later to have been towed but which are not so reported on the police report, are to be coded either "2" (Towed - due to vehicle damage) or "3" (Towed - not due to vehicle damage).

Code 4 (Abandoned) should only be used when all the information available to the investigator, at the time of case submission, indicates that the vehicle still remained at the scene.

Remember, if a case was originally stratified under Case Number--Stratification (A02) as either "Y" or "Z", then the form entitled "Vehicle Form For Non-Towaway Accident", is required for all vehicles in the case. This form requires no inspection and must be used even if it is subsequently learned that one of the involved vehicles was towed. Conversely, cases originally stratified as other than "Y" or "Z" require that all vehicles be inspected using the Vehicle Form. This is true even if it is subsequently learned that none of the involved vehicles were towed.

Consider the following examples.

If a vehicle is involved in a previous accident (stabilization had occurred) and is then involved in another accident (in transport because on roadway) and finally is towed from the scene but not because of the damage sustained in the second impact, then code "3" (Towed - not due to vehicle damage) is used.

If a motorcycle is walked home [or a car pushed (by hand or by another car)] after the accident, then consider the motorcycle towed. If it was walked home because it was not driveable, then code "2" (Towed - due to vehicle damage).

A vehicle is driven from a scene and subsequently breaks down. It is towed from that location. The towing may have been a result of the damage sustained in the accident. Even if the subsequent towing was due to damage, code "1" (Driven) for this vehicle.

VEHICLE FORM

V11

Variable Name: Vehicle Model Year

Format: 2 columns - numeric

Beginning
Column 17

Element Values:

Level 2 Range: 60 through 85

Code the last two digits of the model year for which the vehicle was
manufactured.

99 Unknown

Source: Primary source is the VIN during vehicle inspection; secondary
sources include registration, police report, and interviewees.

Remarks:

A vehicle manufactured as a 1985 model is to be coded as "85".

Variable Name: Vehicle Make

Format: 2 columns - numeric

Beginning
Column 19

Element Values:

Automobile

01 American Motors	39 Jaquar
02 Jeep (includes AMC-Jeep, Kaiser)	40 Lancia
03 AM General	41 Mazda
	42 Mercedes Benz
	43 MG
06 Chrysler	[18] Opel
07 Dodge	44 Peugeot
08 Imperial	45 Porsche
09 Plymouth	46 Renault
	47 Saab
12 Ford	48 Subaru
13 Lincoln	49 Toyota
14 Mercury	50 Triumph
	51 Volvo
18 Buick (includes Opel)	52 Mitsubishi
19 Cadillac	
20 Chevrolet	59 Other foreign
21 Oldsmobile	<u>V13</u>
22 Pontiac	31 Aston Martin
23 GMC	32 Bricklin
	33 Citroen
29 Other domestic	34 Delorean
<u>V13</u>	35 Ferrari
01 Studebaker/Avanti	36 Hillman
02 Checker	37 Jensen
28 Other domestic (e.g., Desoto)	38 Lamborghini
	39 Lotus
30 Volkswagen (domestic and foreign)	40 Maserati
31 Alfa Romeo	41 Morris
32 Audi	42 Rolls Royce/Bentley
33 Austin/Austin Healey	43 Rover
34 BMW	44 Simca
35 Datsun	45 Sunbeam
36 Fiat	46 TVR
37 Honda	58 Other foreign (e.g., Morgan,
38 Isuzu	Singer)

Variable Name: Vehicle Make (cont'd.)

Motored Cycles

- | | |
|---|---|
| [34] BMW | [48] Subaru |
| 60 BSA | [49] Toyota |
| 61 Ducati | [30] Volkswagen |
| 62 Harley-Davidson | [51] Volvo |
| [37] Honda | 88 White |
| 63 Kawasaki | |
| 64 Moto-Guzzi | 95 Other |
| 65 Norton | <u>V13</u> |
| 66 Suzuki | 01 Autocar |
| [50] Triumph | 02 Auto-Union-DKW |
| 67 Yamaha | 03 Divco |
| 69 Other | 04 Western Star |
| | 88 Other truck or bus (e.g.,
Oshkosh, IVECO) |
| 70 Mo-ped (all mo-peds whose
manufacturer is not specifically
listed above) | |

Other make

- 98 Other make (use codes 29, 59, 69,
70, or 95 if applicable)

Trucks and Busses

- [03] AM General
80 Brockway
[20] Chevrolet
81 Diamond Reo or Reo
[35] Datsun
[07] Dodge
[12] Ford
82 Freightliner or White Freightliner
83 FWD
[23] GMC
84 International Harvester
[38] Isuzu
[02] Jeep
85 Kenworth
86 Mack
[41] Mazda
[42] Mercedes Benz
[52] Mitsubishi
87 Peterbilt
[09] Plymouth

Unknown make

- 99 Unknown make

[] The brackets mean that the make's
number has been previously listed.

Variable Name: Vehicle Make (cont'd.)

Alphabetical Listing of Makes

31	Alfa Romeo	83	FWD	65	Norton
03	AM General	23	GMC	21	Oldsmobile
01	American Motors	62	Harley-Davidson	18	Opel
5931	Aston Martin	5936	Hillman	87	Peterbilt
32	Audi	37	Honda	44	Peugeot
33	Austin	84	International	09	Plymouth
34	BMW		Harvester	22	Pontiac
5932	Bricklin	38	Isuzu	45	Porsche
80	Brockway	39	Jaquar	46	Renault
60	BSA	02	Jeep	5942	Rolls Royce/Bentley
18	Buick	5937	Jensen	5943	Rover
19	Cadillac	63	Kawasaki	47	Saab
2902	Checker	85	Kenworth	5944	Simca
20	Chevrolet	5938	Lamborghini	2901	Studebaker/Avanti
06	Chrysler	40	Lancia	48	Subaru
5933	Citroen	13	Lincoln	5945	Sunbeam
35	Datsun	5939	Lotus	66	Suzuki
5934	Delorean	86	Mack	50	Triumph
81	Diamond Reo or Reo	5940	Maserati	49	Toyota
07	Dodge	41	Mazda	5946	TVR
61	Ducati	42	Mercedes-Benz	30	Volkswagen
5935	Ferrari	14	Mercury	51	Volvo
36	Fiat	43	MG	88	White
12	Ford	52	Mitsubishi	67	Yamaha
82	Freightliner or White Freightliner	5941	Morris		
		64	Moto-Guzzi		

Source: Primary source is the VIN during vehicle inspection; secondary sources include the police report, interviewees, and vehicle registration files.

Remarks:

Please write the Vehicle Make of the vehicle in the available space for ready visual reference, even though the information is incorporated in the Make code.

Variable Name: Vehicle Make (cont'd.)

The Make codes are organized into general groups. These groups are:

01-29 - Domestic automobiles
 30-59 - Foreign automobiles
 60-70 (34, 37, 50) - Motored cycles
 80-88 (02, 03, 07, 09, 12, 20, 23, 30, 35, 38, 41, 42, 48, 49, 51) -
 Trucks and Buses
 29, 59, 69, 70, 95, 98 - Other
 99 - Unknown

If the make of the vehicle is known and is not listed as one of the specific attributes, select an "other" code based upon the vehicle's body type (V14). Reference table below:

<u>V12 Vehicle Make</u>	<u>V13 Vehicle Model</u>	<u>V14 Body Type</u>
29 Other domestic automobile	01, 02, 28	01-13
59 Other foreign automobile	31-46, 58	01-13
69 Other motored cycle (except Moped)	61-69	20, 28, 29
70 Other Moped	61, 62, 69	21
95 Other Truck/Bus	01-04, 78, 88	30-79
98 Other	97, 00	80-89, 99

If the make of the vehicles is known (i.e., codes "01"- "03", "06"- "09", "12"- "14", "18"- "23", "29"- "52", "59"- "67", "69"- "70", "80"- "88", or "95" or "98") but it is unknown whether or not the vehicle was a passenger car, a truck, or motorcycle, then code Vehicle Model (V13) as "00" (Unknown).

If the make of the vehicle is not known (e.g., hit-and-run vehicle), then code "99" (Unknown make), and code Vehicle Model (V13) as "00" (Unknown). However, if the make of the vehicle is not known but it is known to be an automobile (V14, Body Type, equals "01"- "09"), then code Vehicle Model (V13) as "99" [Unknown (automobile)].

V12, Vehicle Make, and V13, Vehicle Model, have to be used in conjunction; therefore, refer to remarks for V13.

Variable Name: Vehicle Model

Format: 2 columns - numeric

Beginning
Column 21

Element Values:

Model Code	Vehicle Line	Includes	Model Years
<u>American Motors (01)</u>			
01	Rambler/American	Rogue, 220, 440, Scrambler	
02	Rebel/Matador	550,770,660, Classic, Brougham, Barcelona, X, Marlin	
03	Ambassador	880, 990, SST, DPL, Brougham	
04	Pacer	DL, Limited	
05	AMX	(2-Seater)	68-70
06	Javelin	SST, AMX (1971-1974)	
07	Hornet/Concord	SST, Sportabout, AMX (1975-1978), Limited, DL, SC 360	
08	Spirit/Gremlin	Limited, DL, Custom, AMX (1979 on), GT(1983 on)	
09	Eagle	DL, Limited	80 on
10	SX4/Kamback	DL, Limited	81 on
*	Alliance/Encore		
28	Other (domestic automobile)		
99	Unknown (automobile)		

Jeep (02)

01	CJ-2/CJ-3/CJ-4	Military	
02	CJ-5/CJ-6/CJ-7/CJ-8	Scrambler, Golden Eagle, Renegade, Laredo	
71	Cherokee	Wide Track Chief, Commando, Jeepster	
73	Pick-up	J-10, J-20, Roncho	
76	Wagoneer	Custom, Brougham Limited	
78	Other (light truck)		
79	Unknown (light truck)		
28	Other (domestic automobile)		
99	Unknown (automobile)		
00	Unknown [Jeep]		

* See Renault

VEHICLE FORM

V13
(2)

Variable Name: Vehicle Model (cont'd.)

Model Code	Vehicle Line	Includes	Model Years
<u>AM General (03)</u>			
01	Dispatcher	Post Office (Jeep)	
75	Dispatcher	DJ-Series, Post Office Delivery (Van)	
87	Bus (rear engine)	Transit	
88	Other (truck)	Military off-road	
89	Unknown (truck)		
28	Other (domestic automobile)		
99	Unknown (automobile)		
00	Unknown [AM General]		
<u>Chrysler (06)</u>			
07	LeBaron	S, Medallion, Salon	77 on
09	Cordoba	Crown, 300, LS	
10	Newport/New Yorker	Town and Country, Brougham, Custom, Royal, 300 (through 1971)	thru 82
14	E-Class	New Yorker, Fifth Ave.	83 on
15	Laser	Turbo	84 on
28	Other (domestic automobile)		
99	Unknown (automobile)		
<u>Dodge (07)</u>			
01	Dart	170, 270, Custom, GT, Swinger, Sport, Demon, 340, 360, Special, Special Edition	
02	Coronet/Charqer/Magnum	Brougham, Custom, Super Bee, Crestwood, Deluxe, XE, R/T, 440, 500	
03	Polara/Monaco	Custom, Special, Police, Taxi, Crestwood, Brougham	
04	Royal Monaco		
05	Challenger	R/T, T/A, Rallye	70-74
06	Aspen	Custom, Special Edition, Police	
07	Diplomat	Medallion, "S", Salon	
08	Omni	024, De Tomaso, Miser, Charqer 2.2, Custom, Shelby	
09	Mirada		
10	St. Regis		
11	Aries(K)	Custom, SE	
12	400	LS	
13	Rampage (car based pick-up)	2.2	

VEHICLE FORM

V13
(3)

Variable Name: Vehicle Model (cont'd.)

Model Code	Vehicle Line	Includes	Model Years
------------	--------------	----------	-------------

Dodge (07) (cont'd.)

14	600	ES	83 on
15	Daytona	Turbo	84 on
33	Challenger-foreign		78 on
34	Colt	GT, Custom, Carousel, RS	
70	Caravan	T-Van	84 on
71	Ramcharger	Ram	
72	D50/Colt Pickup (foreign), Vista Van	Power Ram, Ram 50	
73	B, W-Series Pickup	Ram, Custom, Royal, Miser	
74	Van	Sportsman Van, Royal, Maxiwagon, Ram	
75	Van Derivative	Karivan	
81	Medium/Heavy: CRE		
82	Medium/Heavy: COE, low entry		
83	Medium/Heavy: COE, high entry		
84	Medium/Heavy: unk. engine location		
85	Medium: Bus (not van based)		
88	Other (truck)		
89	Unknown (truck)		
28	Other (domestic automobile)		
90	Medium/Heavy: COE, unk. entry position		
99	Unknown (automobile)		
00	Unknown [Dodge]		

Imperial (08)

10	Imperial	Imperial LeBaron	thru 75
28	Other (domestic automobile)		
99	Unknown (automobile)		

Plymouth (09)

01	Valiant/Duster/Scamp	100, 200, Taxi, Brougham, Signet, Custom, Special 340, Special 360, 340, 360	thru 76
----	----------------------	---	---------

VEHICLE FORM

V13
(4)

Variable Name: Vehicle Model (cont'd.)

Model Code	Vehicle Line	Includes	Model Years
<u>Plymouth (09) (cont'd.)</u>			
02	Satellite/Belvedere	Belvedere I, II, GTX, Road Runner (through 1974), Brougham, Sebring, Sebring Plus, Superbird	
03	Fury	I, II, III, Road Runner (1975), Suburban, Salon, VIP, Sport	
04	Gran Fury	Sedan, Brougham, Custom, Sport, Suburban	
05	Barracuda	Formula "S", 340, Gran Coupe, AAR Cuda	
06	Volare	Custom, Premier, Road Runner (1976 on), Police	
07	Caravelle		
08	Horizon	TC-3, Turismo, Miser, Turismo 2.2, Custom	
11	Reliant(K)	Custom, SE	
13	Scamp (car based pick-up)	GT	82 on
31	Cricket		
32	Arrow	GS, GT, Fire Arrow	
33	Sapporo		
34	Champ/Colt	Custom	
70	Voyager	T-Van	84 on
71	Trailduster		
72	Arrow pickup (foreign)		
74	Van (Voyager)	Sport, Premier	
78	Other (light truck)		
79	Unknown (light truck)		
28	Other (domestic automobile)		
99	Unknown (automobile)		
00	Unknown [Plymouth]		
<u>Ford (12)</u>			
01	Falcon	Falcon-Futura (through 1969)	thru 70
02	Fairlane	500, 500 XL, Fairlane-Torino (1968-1970)	thru 70
03	Mustang/Mustang II	Mach I, Boss, Grande, Cobra, Cobra II, Ghia, SVO, GT	
04	Thunderbird	All sizes, Town Landau, Heritage	
05	LTD II	Squire, Brougham	77-79
06	LTD/Galaxy/Custom	XL, Landau, Ranch Wagon, Country Squire, S, 500, 500 XL, Brougham, Crown Victoria(81 & 82)	
07	Ranchero (car based pick-up)	500, GT, Squire, Custom	

VEHICLE FORM

V13
(5)

Variable Name: Vehicle Model (cont'd.)

Model Code	Vehicle Line	Includes	Model Years
<u>Ford (12) (cont'd.)</u>			
08	Maverick	Grabber	70-77
09	Pinto	MPG, Pony, ESS	71-80
10	Torino/Gran Torino	Elite, GT, Cobra, Sport, Squire, Brougham	71-76
11	Granada	Ghia, L, GL, GLX	75 on
12	Fairmont	Fairmont-Futura (1978-1981)	78 on
13	Escort	L, GL, GLX, SS	81 on
14	EXP	Turbo	82 on
15	Tempo	L, GL, GLX	83 on
16	Crown Victoria		83 on
31	English Ford	(e.g. Cortina)	
32	Fiesta		78-80
33	Laser	GL Ghia, GL Sport	83 on
70	Bronco II	Ranger based	83 on
71	Bronco	Full size truck based	
72	Courier Pickup (foreign)		
73	F-Series Pickup	F-100 to F-350	
74	Van	E-Series, Econoline, Club Wagon, Chateau, Cutaway based (e.g., box van, van bus/RV),	
75	Van derivative	Parcel	
77	Ranger		82 on
78	Other (light truck)		
79	Unknown (light truck)		
81	Medium/Heavy: CBE	F-500 through F-800, L/LN/LNT/LT/LS/LTS-series FT8000, FT800D, FT800	
82	Medium/Heavy: COE, low entry	C/CT-series	
83	Medium/Heavy: COE, high entry	CL/CLT-series	
84	Medium/Heavy: unk. engine location		
85	Medium Bus	B-series (not van based)	
88	Other (truck)		
89	Unknown (truck)		
90	Medium/Heavy: COE, unk. entry position		
28	Other (domestic automobile)		
99	Unknown (automobile)		
00	Unknown [Ford]		

VEHICLE FORM

V13
(6)

Variable Name: Vehicle Model (cont'd.)

Model Code	Vehicle Line	Includes	Model Years
<u>Lincoln (13)</u>			
01	Lincoln	Lincoln Continental (thru 81), Town Car (82 on)	
02	Mark	I, II, III, IV, V, VI, VII	
05	Continental		82 on
11	Versailles		77-80
28	Other (domestic automobile)		
99	Unknown (automobile)		
<u>Mercury (14)</u>			
02	Cyclone	GT, CJ, Spoiler	thru 71
03	Capri-Domestic		79 on
04	Cougar	Villaquer, Brougham, XR7 (thru 80)	67 on
05	Cougar XR7		81 on
06	Marquis/Monterey	Marauder, X-100, Parklane, Colony Park, S-55, Custom, Brougham, Grand (thru 82)	67 on
08	Comet	Caliente, Capri (1966-1967), GT, Voyager, 202	
09	Bobcat		75-80
10	Montego	GT, MX, Villaquer, Brougham	67-76
11	Monarch	Ghia	75-81
12	Zephyr	Z7, GS	78 on
13	Lynx	L, LS, GS, RS	81 on
14	LN7		82-83
15	Topaz	L, LS, GS	83 on
16	Grand Marquis		83 on
31	Capri-foreign	Capri (1970-1978), Capri II	70-78
33	Pantera		
28	Other (domestic automobile)		
99	Unknown (automobile)		
<u>Buick (18)</u>			
01	Regal/Century/ Special	GS, GS350, GS400, GS455, Luxus, Skylark (thru 1972), Sportswagon, Waqon, Custom, Special, Sport Coupe, Limited	thru 81
02	LeSabre/Wildcat/ Centurion	Estate waqon, Custom, Luxus, Sport Coupe, Waqon, Limited, Invicta	

VEHICLE FORM

V13
(7)

Variable Name: Vehicle Model (cont'd.)

Model Code	Vehicle Line	Includes	Model Years
<u>Buick (18) (cont'd.)</u>			
03	Electra/Electra 225	Custom, Limited, Park Avenue, Wagon	
05	Riviera	"S" Type, "T" Type	
08	Apollo	S/R, Skylark (1975)	73-75
10	Regal	G-car, "T" Type	82 on
12	Skyhawk	"S" Type, Road Hawk	75-81
15	Skylark	Limited, Sport, S/R, "S", Custom (see code 01), "T" Type, "T" Type Custom	76 on
16	Skyhawk	J-car, "T" Type	82 on
17	Century	A-car, "T" Type	82 on
31	Opel Kadett		thru 75
32	Opel Manta/1900	Luxus, Rallye, Sports Coupe	thru 75
33	Opel GT		thru 75
34	Opel Isuzu	Deluxe, Sport	76-79
28	Other (domestic automobile)		
99	Unknown (automobile)		
<u>Cadillac (19)</u>			
03	DeVille/Brougham	Calais, 60-Special, Coupe, Sedan, Fleetwood	
04	Limousine	Fleetwood 75, Formal	
05	Eldorado	Touring Coupe, Biarritz	
06	Commercial Series	(e.g., ambulance/hearse)	thru 81
14	Seville	Elegante	76 on
16	Cimarron	J-car	82 on
28	Other (domestic automobile)		
99	Unknown (automobile)		
<u>Chevrolet (20)</u>			
01	Malibu/Chevelle	Classic, Concours, Laguna, S-3, Nomad, Greenbriar, Estate, 300, SS-396/454, Deluxe	64 on
02	Caprice/Impala	Classic, Kingswood, Townsman, Estate, Brookwood, Super Sport, Bel Air, Biscayne	
04	Corvette	Stingray	53 on
06	Corvair	Corvair Monza, 500, Corvair Spyder, Corsa	thru 69
07	El Camino	Royal Knight	59 on

VEHICLE FORM

V13
(8)

Variable Name: Vehicle Model (cont'd.)

Model Code	Vehicle Line	Includes	Model Years
<u>Chevrolet (20) (cont'd.)</u>			
08	Nova	Chevy II, Chevy Nova, LN, Concours	thru 79
09	Camaro	SS, LT, Z-28, Berlinetta	67 on
10	Monte Carlo	G-car	70 on
11	Vega	GT, Cosworth, Kammback	71-77
12	Monza	2 + 2, Spyder, Sport, Towne Coupe	75-80
13	Chevette	Scoutler	76 on
15	Citation	X-car, X-11	80 on
16	Cavalier	J-car	82 on
17	Celebrity	A-car	82 on
70	Blazer	S-10 based	83 on
71	Blazer	Full size truck based	
72	LUV pickup (foreign)		
73	C, K-Series Pickup		
74	G-Series Van	Beauville, Chevy Van, Sport Van	
75	Van Derivatives	P-Series, Parcel Van	
76	Suburban		
77	S-10		82 on
78	Other (light truck)		
79	Unknown (light truck)		
81	Medium/Heavy: CRE	C50, C60 and C65 series, M60 and M65 series, H70, H80 and H90 series, J70, J80 and J90 series, Rison 90	
82	Medium/Heavy: COF, low entry	T60 and T65 series	
83	Medium/Heavy: COF, high entry	Titan 90	
84	Medium/Heavy: unk. engine location	PS6500, P6T042	
85	Bus	S60 series	
88	Other (truck)		
89	Unknown (truck)		
90	Medium/Heavy: COE, unk. entry position		
28	Other (domestic automobile)		
99	Unknown (automobile)		
00	Unknown [Chevrolet]		

VEHICLE FORM

V13
(9)

Variable Name: Vehicle Model (cont'd.)

Model Code	Vehicle Line	Includes	Model Years
<u>Oldsmobile (21)</u>			
01	Cutlass	Supreme, Calais, Cruiser, "S", "LS", Salon, Brougham, Vista Cruiser, 442, F-85 (thru 1972), Rallye 350, Hurst Olds	
02	Delta 88	Royale, Custom, Custom Cruiser, Jetstar 88, Delmont 88, Delta, Starfire (thru 1966)	
03	Ninety-Eight	Regency, Luxury	
05	Toronado	Brougham, XSR, Custom	
06	Commercial Series	Chassis Cowl, CKD Chassis	
12	Starfire	"SX"	75-80
15	Omega	Brougham, Salon, F-87, F-85 (1975 on), X-car (1980 on)	73 on
16	Firenza	J-car	82 on
17	Ciera	A-car, Cutlass Ciera, ES, Brougham	82 on
28	Other (domestic automobile)		
99	Unknown (automobile)		
<u>Pontiac (22)</u>			
01	LeMans/Tempest	Grand Am, Safari, T-37, Grand Sport, Luxury, Custom, GTO (thru 1973), Judge, GT-37, Sprint	
02	Bonneville/Catalina	Brougham, Grand Safari, Safari, GrandVille, Executive, 2 + 2, Starchief	
05	Fiero	P-Car, 2M4	84 on
08	Ventura	SJ, Custom, II, Sprint, GTO (1974 on)	71-77
09	Firebird/Trans Am	Esprit, Formula, Skybird, Redbird, Yellowbird, Spring	68 on
10	Grand Prix	LJ, SJ, Brougham, G-car	
11	Astre	Safari, Wagon, SJ, Custom	75-77
12	Sunbird	Sport, Safari, Wagon	76 on
13	T-1000/1000		81 on
15	Phoenix	LJ, SJ, X-car, (1980 on)	78 on
16	J-2000/2000	J-car, Sunbird Convertible, LE, SE	82 on
17	6000	A-car, STE	82 on
28	Other (domestic automobile)		
99	Unknown (automobile)		
<u>GMC (23)</u>			
07	Caballero/Sprint		
70	Jimmy	S-15 based	83 on

VEHICLE FORM

V13
(10)

Variable Name: Vehicle Model (cont'd.)

<u>Model Code</u>	<u>Vehicle Line</u>	<u>Includes</u>	<u>Model Years</u>
<u>GMC (23) (cont'd.)</u>			
71	Jimmy	Full sized truck based	
73	C, K-Series Pickup		
74	G Van/Vandura, Rally Van		
75	Van Derivatives	P-Series, Value Van, Magnavan	
76	Suburban		
77	S-15		82 on
78	Other (light truck)		
79	Unknown (light truck)		
81	Medium/Heavy: CRE	C-5000, C-6000, and C-7000 series, Briqadier 8000, Briqadier 9500, General 9500	
82	Medium/Heavy: COE, low entry	W-6000, W-7000	
83	Medium/Heavy: COE, high entry	Astro 95	
84	Medium/Heavy: unk. engine location	P5G500, P68042	
85	Bus	B-6000	
88	Other (truck)		
89	Unknown (truck)		
90	Medium/Heavy: COE, unk. entry position		
28	Other (domestic automobile)		
99	Unknown (automobile)		
00	Unknown [GMC]		

Other domestic (29)

01	Studebaker/Avanti		
02	Checker		
28	Other (domestic automobile) [e.g., Desoto]		

Volkswagen (30)

31	Karmann Ghia		
32	Beetle		
33	Super Beetle		
34	411/412	Squareback, Fastback	

VEHICLE FORM

713
(11).

Variable Name: Vehicle Model (cont'd.)

Model Code	Vehicle Line	Includes	Model Years
------------	--------------	----------	-------------

Volkswagen (30) cont'd.)

35	Squareback/Fastback	Type 3, 1600	
36	Rabbit	L, GTI Sport, LS Custom, GL Deluxe	
37	Dasher		
38	Scirocco		
39	The Thing		
40	Jetta		
41	Quantum		
43	Rabbit Pickup		
74	Van/Vanagon/Camper		
78	Other (light truck)		
79	Unknown (light truck)		
58	Other (foreign automobile)		
99	Unknown (automobile)		
00	Unknown [Volkswagen]		

Alfa Romeo (31)

31	Spider	Veloce, 2000/1750, all roadsters	
32	Sports Sedan	Alfetta, Berlina, 2000/1750, Giulia Super, 4 door sedans	
33	Sprint Veloce	Alfetta GT 2000 GTV, 1750 GTV, Giulia Sprint GT, all 2 door coupes	
34	GTV-6		
58	Other (foreign automobile)		
99	Unknown (automobile)		

Audi (32)

31	Super 90		
32	100	LS, GL	
33	Fox		
34	4000		
35	5000	Coupe	
36	Quattro		82 on
58	Other (foreign automobile)		
99	Unknown (automobile)		

Austin/Austin Healey (33)

31	Marina	GT	
32	America		

VEHICLE FORM

V13
(20)

Variable Name: Vehicle Model (cont'd.)

Model Code	Vehicle Line	Mod 1 Years
---------------	-----------------	----------------

Other import (59) (cont'd.)

40	Maserati	
41	Morris	
42	Rolls Royce/Bentley	
43	Rover	
44	Simca	7
45	Sunbeam	
46	TVR	
58	Other (foreign automobile) [e.g., Morgan, Singer]	

MOTORED CYCLE (60-69)

V12

BSA (60)
Ducati (61)
Harley-Davidson (62)
Kawasaki (63)
Moto-Guzzi (64)
Norton (65)
Suzuki (66)
Yamaha (67)
Other Motored Cycle (69)

V13

61	0- 50 cc
62	51-124 cc
63	125-349 cc
64	350-449 cc
65	450-749 cc
66	750 cc or over
69	Unknown (cc)

V12Mo-ped (70)V13

61	0- 50 cc
62	51-124 cc
69	Unknown (cc)

VEHICLE FORM

V13
(3)

Variable Name: Vehicle Model (cont'd.)

Model Code	Vehicle Line	Includes	Model Years
------------	--------------	----------	-------------

Datsun/Nissan (35) (cont'd.)

41	PL 411/RL 411		
42	Stanza	XE	82 on
43	Sentra		83 on
44	Pulsar	NX	83 on
72	Pickup		
78	Other (light truck)		
79	Unknown (light truck)		
58	Other (foreign automobile)		
99	Unknown (automobile)		
00	Unknown [Datsun]		

Fiat (36)

31	124 (Coupe/Sedan)	Sport	
32	124 (Spider)	Spider 2000	
33	Brava/131		
34	850 (Coupe & Spyder)		
35	128		
36	X-1/9		
37	Strada		
58	Other (foreign automobile)		
99	Unknown (automobile)		

Honda (37)

31	Civic	1300, 1500, CVCC	
32	Accord	LX, CVCC	
33	Prelude		
34	600	Coupe, Sedan	
61	0- 50 cc		
62	51-124 cc		
63	125-349 cc		
64	350-449 cc		
65	450-749 cc		
66	750 cc or over		
69	Unknown (cc)		
58	Other (foreign automobile)		
99	Unknown (automobile)		
00	Unknown [Honda]		

VEHICLE FORM

V13
(14)

Variable Name: Vehicle Model (cont'd.)

<u>Model Code</u>	<u>Vehicle Line</u>	<u>Includes</u>	<u>Model Years</u>
<u>Isuzu (38)</u>			
31	I Mark	Gemini	
32	Impulse		
72	P'up (Pick-up)	Rodeo	
78	Other (light truck)		
79	Unknown (light truck)		
58	Other (foreign automobile)		
99	Unknown (automobile)		
00	Unknown [Isuzu]		
<u>Jaquar (39)</u>			
31	XJ-S Coupe		
32	XJ6/XJ12 Sedan/Coupe L, XJ, C, 420/340 Sedans		
33	XK-E	2 + 2, V-12 roadster, 120	
58	Other (foreign automobile)		
99	Unknown (automobile)		
<u>Lancia (40)</u>			
31	Beta Sedan/HPE		
32	Beta Coupe/Zagato		
33	Scorpion		
58	Other (foreign automobile)		
99	Unknown (automobile)		
<u>Mazda (41)</u>			
31	RX2		
32	RX3		
33	RX4		
34	RX7		
35	GLC		
36	Cosmo		
37	626		
38	808		
39	Mizer		thru 76
40	R-100		thru 72
41	618/616		
42	1800		
72	Pick-up	B-2200	

VEHICLE FORM

V13
(15)

Variable Name: Vehicle Model (cont'd.)

Model Code	Vehicle Line	Includes	Model Years
<u>Mazda (41) (cont'd.)</u>			
78	Other (light truck)		
79	Unknown (light truck)		
58	Other (foreign automobile)		
99	Unknown (automobile)		
00	Unknown [Mazda]		
<u>Mercedes-Benz (42)</u>			
31	200/220/230/240/250/ 280/300 (Sedan and 5 passenger Coupe "C" only)	SE, CD, D, SD, TD, CE, E [excludes 280 S, 280 SE (1975 on), 300 SD Sedan (see Code 37)]	
32	230 SL/280 SL (2 passenger)		
33	350 SL/450 SL/380 SL		
34	350 SLC/450 SLC/380 SLC		
35	300 SEL/280 SEL	TD-T, TD, CDT	
36	450 SEL/380 SEL/ 500 SEL	SL, SLC, SEC	
37	450 SE/380 SE	280 S, 280 SE (1975 on), 300 SD Sedan	
38	600/6.9 Sedan	Pullman	
39	190		
75	Van Derivative	Kurbstar	32 on
81	Medium/Heavy: CBE		
82	Medium/Heavy: COE, low entry		
83	Medium/Heavy: COE, high entry		
84	Medium/Heavy: unk. engine location		
85	Medium: Bus		
88	Other (truck)		
89	Unknown (truck)		
90	Medium/Heavy: COE, unk. entry position		
58	Other (foreign automobile)		
99	Unknown (automobile)		
00	Unknown [Mercedes-Benz]		

VEHICLE FORM

V13
(16)

Variable Name: Vehicle Model (cont'd.)

Model Code	Vehicle Line	Includes	Model Years
------------	--------------	----------	-------------

MG (43)

31	MG Midget		
32	MGB		
33	MGB GT		
34	MGA		
35	TA/TC/TD/TF		
36	MGC	MGC/GT	
58	Other (foreign automobile)		
99	Unknown (automobile)		

Mitsubishi See V12 Code (52) listed after Volvo

Opel See Buick--(18)

Peugeot (44)

31	304		
32	403		
33	404		
34	505/504	STI	
35	604	SL, D	
58	Other (foreign automobile)		
99	Unknown (automobile)		

Porsche (45)

31	911	S, E, T, SC, Carrera	
32	912/912E		
33	914	914/6	
34	924	Turbo	
35	928	S	
36	930/Turbo		
37	944		
58	Other (foreign automobile)		
99	Unknown (automobile)		

82 on

Renault (46)

31	LeCar	5	
32	10/Dauphine/ Caravelle/R-8		

VEHICLE FORM

V13
(17)

Variable Name: Vehicle Model (cont'd.)

Model Code	Vehicle Line	Includes	Model Years
------------	--------------	----------	-------------

Renault (46) (cont'd.)

33	12	R12	
34	15	R15TL	
35	16		
36	17	R17, Gordini Coupe	
37	R18i		
38	Fuego	TL, TS, GTL, GTS	
39	Alliance	L, DL, Limited	83 on
40	Encore		
58	Other (foreign automobile)		
99	Unknown (automobile)		

Saab (47)

31	99/99E/900	Turbo	
32	Sonnet	Sonnet III, Sonnet 97	
33	95/96/97		
58	Other (foreign automobile)		
99	Unknown (automobile)		

Subaru (48)

31	FE/GF/DL/STD/GL/G/	4 wheel drive	
	GLF		
32	Star		
33	360		
43	Brat	DL, GL	
78	Other (light truck)		
79	Unknown (light truck)		
58	Other (foreign automobile)		
99	Unknown (automobile)		
00	Unknown [Subaru]		

Toyota (49)

31	Corona	Custom, Deluxe, Mark II, 1900, 2000	
32	Corolla	1100, 1200, 1600, Deluxe, Custom, SR 5	
33	Celica	1900, 2000, GTS	
34	Celica Supra	Soarer	
35	Cressida		
36	Crown	2300, 2600	

VEHICLE FORM

V13
(18)

Variable Name: Vehicle Model (cont'd.)

Model Code	Vehicle Line	Includes	Model Years
------------	--------------	----------	-------------

Toyota (49) (cont'd.)

37	Carina	2000	
38	Tercel	4WD Wagon	
39	Starlet		
71	Landcruiser		
72	Pick-up, Mini-Van	Chinooks, LN44	
78	Other (light truck)		
79	Unknown (light truck)		
58	Other (foreign automobile)		
99	Unknown (automobile)		
00	Unknown [Toyota]		

Triumph (50)

31	Spitfire	I, II, III, IV, 1500	
32	GT6		
33	TR4	TR3, TR2, TR4A	
34	TR6	TR 250	
35	TR7/TR8		
36	Herald	Vitesse	
37	Stag		
61	0- 50 cc		
62	51-124 cc		
63	125-349 cc		
64	350-449 cc		
65	450-749 cc		
66	750 cc or more		
69	Unknown (cc)		
58	Other (foreign automobile)		
99	Unknown (automobile)		
00	Unknown [Triumph]		

Volvo (51)

31	122	S	
32	142/144/145	S, Deluxe, GL, GLS, E	
33	164	S, E	
34	242/244/245	Deluxe, DL, GLE, GLT, GL	
35	262/264/265	GL	
36	1800	E, S, ES	
37	P-544		

VEHICLE FORM

V 3
(19)

Variable Name: Vehicle Model (cont'd.)

Model Code	Vehicle Line	Includes	Model Years
------------	--------------	----------	-------------

Volvo (51) (cont'd.)

38	760	GLE	
81	Medium/Heavy:	CBE	
82	Medium/Heavy:	COF, low entry	
83	Medium/Heavy:	COE, high entry	
84	Medium/Heavy:	unk. engine location	
85	Medium:	Bus	
88	Other (truck)		
89	Unknown (truck)		
90	Medium/Heavy:	COE, unk. entry position	
58	Other (foreign automobile)		
99	Unknown (automobile)		
00	Unknown [Volvo]		

Mitsubishi (52)

31	Starion	2 + 2	83 on
32	Tredia		83 on
33	Cordia		83 on
70	Montero		
72	Pickup, Mini-Van		83 on
58	Other (foreign automobile)		
99	Unknown (automobile)		
00	Unknown [Mitsubishi]		

Other import (59)

31	Aston Martin		
32	Bricklin		
33	Citroen		
34	Delorean		
35	Ferrari		
36	Hillman		
37	Jensen		
38	Lamborghini		
39	Lotus		

VEHICLE FORM

V13
(20)

Variable Name: Vehicle Model (cont'd.)

Model Code	Vehicle Line	Mod 1 Years
---------------	-----------------	----------------

Other import (59) (cont'd.)

40	Maserati	
41	Morris	
42	Rolls Royce/Bentley	
43	Rover	
44	Simca	7
45	Sunbeam	
46	TVR	
58	Other (foreign automobile) [e.g., Morgan, Singer]	

MOTORED CYCLE (60-69)

V12

BSA (60)
Ducati (61)
Harley-Davidson (62)
Kawasaki (63)
Moto-Guzzi (64)
Norton (65)
Suzuki (66)
Yamaha (67)
Other Motored Cycle (69)

V13

61	0- 50 cc
62	51-124 cc
63	125-349 cc
64	350-449 cc
65	450-749 cc
66	750 cc or over
69	Unknown (cc)

V12Mo-ped (70)V13

61	0- 50 cc
62	51-124 cc
69	Unknown (cc)

VEHICLE FORM

V13
(21)

Variable Name: Vehicle Model (cont'd.)

Model Code	Vehicle Line	Includes	Model Years
------------	--------------	----------	-------------

TRUCKS AND BUSES (80-83, 85-88)

V12

- Brockway (80)
- Diamond Reo or Reo (81)
- Freightliner or White Freightliner (82)
- FWD (83)
- Kenworth (85)
- Mack (86)
- Peterbilt (87)
- White (88)

V13

- 80 Motor Home
- 81 Medium/Heavy: CBE
- 82 Medium/Heavy: COE, low entry
- 83 Medium/Heavy: COE, high entry
- 84 Medium/Heavy: unknown engine location
- +85 Bus: conventional (engine out front)
- 86 Bus: flat front, front engine
- 87 Bus: flat front, rear engine
- 88 Other (truck)
- 89 Unknown (truck)
- 90 Medium/Heavy: COE, unk. entry position

+Use code "85" (Bus) if the frontal plane or the engine location is unknown.

International Harvester (84)

- | | | |
|----|-------------------------------|--|
| 71 | Scout | Scout II, Utility Pickup, SS-2, Roadstar, Terra Traveltop, 800 Series, Traveler |
| 73 | Pickup/Panel | R100, 900A-1500C, 1000D-1500D, 1010-1510, 100-500 |
| 75 | Multistop | Metro RM 120-160, MS1210, MS1510 |
| 76 | Travellall | 1010-1210, 100-200 |
| 78 | Other (light truck) | |
| 79 | Unknown (light truck) | |
| 80 | Motor Home | 1310 MHC, 1500 MHC |
| 81 | Medium/Heavy: CBE | Loadstar/Fleetstar, Paystar, CBE Transtar (4200), S-Series, Mixer |
| 82 | Medium/Heavy: COE, low entry | CO, VCO, DCO (190-1950), Cargostar, LFM 5370 (Garbage) |
| 83 | Medium/Heavy: COE, high entry | DCO, DCOT, UCO, VCOT, (405 Series), COE Transtar, Unistar, Conco 707B, 9600 Series |

VEHICLE FORM

V13
(22)

Variable Name: Vehicle Model (cont'd.)

Model Code	Vehicle Line	Includes	Model Years
------------	--------------	----------	-------------

International Harvester (84) (cont'd.)

84	Medium/Heavy: unk. engine location		
85	Bus: Conventional	R153-1853, Loadstar	1603-1853
86	Bus: flat front, front engine	173 FC, 183 FC	
87	Bus: flat front, rear engine	183RE, 193RE, (transit)	
88	Other (truck)	Fire Truck - R140-R306, CO	8190
89	Unknown (truck)		
90	Medium/Heavy: COE, unk. entry position		
00	Unknown [International Harvester]		

Other (Truck or Bus) (95)

01	Autocar		
02	Auto-Union-DKW		
03	Divco		
04	Western Star		
78	Other (light truck)*		
88	Other (truck†)	[e.g., Oshkosh, IVECO, Gramman]	

Other make (98)

00	Unknown		
97	Other (e.g., snowmobile, go-cart)		
99	Unknown (automobile)**		

*Use code "88" [Other (truck)] if the vehicle's GVWR is unknown.

**Occurs when make is not explicitly listed and it is unknown whether make is domestic or import.

†Truck as used here includes (1) any truck of unknown GVWR, (2) medium or heavy trucks, and (3) buses.

Variable Name: Vehicle Model (cont'd.)

Unknown make (99)

00 Unknown (as to automobile, motored cycle, light truck, or truck)
69 Unknown (motored cycle)*
79 Unknown (light truck)*
89 Unknown (truck†)*
98 Other automobile (unknown if domestic or foreign)*
99 Unknown (automobile)*

*Use these codes even if you know more detail about the model than these codes indicate (e.g., unknown pickup truck, unknown CBE tractor semi-trailer, unknown bus, or unknown car pickup body). V14, Body Type, is available to code the additional information.

†Truck as used here includes (1) any truck of unknown GVWR, (2) medium or heavy trucks, and (3) buses.

Source: Primary source is the VIN during vehicle inspection; secondary sources include police report, interviewees, and vehicle registration.

Remarks:

The model codes are organized into general groups. These groups are:

01-28, 99 - domestic passenger car (automobile)
31-58, 99 - foreign passenger car (automobile)
60-69 - motored cycles (including motorcycles, mini-bikes, motor scooters, dirt bikes, and mo-peds)
70-79 - light trucks (including truck based utility vehicles, light duty pickup trucks, standard pickup trucks, vans, van based station wagons, van based buses, van derivatives, and truck based station wagons)
80-90 - trucks and buses [includes all trucks over 10,000 lbs. GVWR except those pickup type trucks mentioned under Body Type (V14) code "50" (Pickup), and all buses except those that are van based]

Within these groups, the model codes for automobiles and light trucks generally are not ordered to give any indication of vehicle size or type. However, the model codes for motored cycles, trucks/buses, other and unknown have specific definition. These definitions are:

Variable Name: Vehicle Model (cont'd.)

Motored Cycle

61 0-50cc
 62 51-124cc
 63 125-349cc
 64 350-449cc
 65 450-749cc
 66 750cc or over
 69 Unknown cc

These codes should be used to indicate the manufacturer's model size, rather than the actual piston displacement. For example, a 1980 Honda CB 750 has an original piston displacement of 749cc. This would be coded as "66" (750 or over).

Trucks/Buses

80 Motor Home
 81 Medium/Heavy: CBE
 82 Medium/Heavy: COE, low entry
 83 Medium/Heavy: COE, high entry
 84 Medium/Heavy: unknown engine location
 †85 Bus: conventional (engine out front)
 86 Bus: flat front, front engine
 87 Bus: flat front, rear engine
 88 Other (truck)
 89 Unknown (truck)
 90 Medium/Heavy: COE, unk. entry position

†Use code "85" (Bus) if the frontal plane or the engine location is unknown.

Other make (98)

28 Other domestic automobile
 58 Other foreign automobile
 78 Other light truck
 88 Other truck**
 97 Other (e.g., snowmobile, go-cart)

Unknown make (99)

00 Unknown (as to automobile, motored cycle, light truck, or truck)
 69 Unknown (motored cycle)*
 79 Unknown (light truck)*
 89 Unknown (truck**)*

VEHICLE FORM

V13
(25)

Variable Name: Vehicle Model (cont'd.)

Unknown make (99) (cont'd.)

- 98 Other automobile (unknown if domestic or foreign)*
- 99 Unknown (automobile)*

*Use these codes even if you know more detail about the model than these codes indicate (e.g., unknown pickup truck, unknown CBE tractor semi-trailer, unknown bus, or unknown car pickup body). V14, Body Type, is available to code the additional information.

**Truck as used here includes (1) any truck of unknown GVWR, (2) medium or heavy trucks, and (3) buses.

V12, Vehicle Make, and V13, Vehicle Model, have to be used in conjunction; therefore, refer to remarks for V12.

Variable Name: Body Type

Format: 2 columns - numeric

Beginning
Column 23

Element Values:

Automobiles

- 01 Convertible (excludes sun-roof, t-bar)
- 02 2-door sedan, hardtop, coupe
- 03 3-door/2-door hatchback
- 04 4-door sedan, hartop
- 05 5-door/4-door hatchback coupe
- 06 Station wagon (excluding van and truck based)
- 08 Other automobile type
- 09 Unknown automobile type

Automobile Derivatives and Short Utility Vehicles

- 10 Auto based pickup (includes El Camino, Caballero, Ranchero, Brat)
- 11 Auto based panel (cargo station wagon, includes auto based ambulance/hearse)
- 12 Short utility - not truck based (includes Jeep CJ-5, Jeep CJ-7, Renegade, Landrover, Pre-78 Bronco, Landcruiser, Thing)
- 13 Large limousine - more than four side doors or stretched chassis

Motorcycles

- 20 Motorcycle
- 21 Mopeds (motorized bicycles)
- 28 Other motorcycle (minibikes, motorscooters)
- 29 Unknown motorcycle type

Bus (excludes van based)

- 30 School bus (designed to carry students, not cross country or transit)
- 31 Cross country;/intercity (designed for long distance)
- 32 Transit bus (includes short ride city bus and medium range suburban bus)
- 38 Other bus (e.g., bus based motor home)
- 39 Unknown bus type

Van Based Light Truck (\leq 10,000 lbs. GVWR)

- 40 Van (includes VW bus, Vanagon, Kombi, Beauville, Chateau, Club Wagon, Sportman; excludes moving van)

Variable Name: Body Type (cont'd.)

Van Based Light Truck (\leq 10,000 lbs. GVWR) (cont'd.)

- 41 Van-commercial cutaway (includes box van, multi-stop, parcel, van pickups)
- 42 Van based motor home
- 48 Other van type
- 49 Unknown van type

Light Conventional Truck (Pickup style cab, \leq 10,000 lbs. GVWR)

- 50 Pickup (includes open box and caps)
- 51 Pickup with slide-in camper
- 52 Pickup based motorhome (chassis mounted)
- 53 Cab chassis based (includes rescue vehicles, light stake, dump, and tow trucks)
- 54 Truck based panel
- 55 Truck based station wagon (4-door; includes Suburban, Travelall, Wagoneer)
- 56 Truck based utility (2-door; includes Blazer, Bronco - 78 on, Jimmy)
- 58 Other light conventional truck (e.g., stretched Suburban limousine)
- 59 Unknown light conventional truck
- 69 Unknown light truck (van or pickup)

Medium/Heavy Truck ($>$ 10,000 lbs. GVWP)

- 70 Step vans
- 71 Single unit straight truck (10,000 lbs. $<$ GVWR \leq 26,000 lbs.)
- 72 Single unit straight truck ($>$ 26,000 lbs. GVWR)
- 73 Medium/heavy truck based motor home
- 74 Truck-tractor with no cargo trailer
- 75 Truck-tractor pulling one or more trailers
- 77 Truck-tractor (unknown if pulling trailer)
- 78 Unknown medium/heavy truck type
- 79 Unknown truck type (light/medium/heavy)

Other Vehicles

- 80 Snowmobile
- 81 Farm equipment other than trucks
- 82 ATV, all terrain vehicle (e.g., dune/swamp buggy)
- 83 Construction equipment other than trucks (e.g., grader, off road)
- 88 Other (e.g., go cart, fork lift, city street sweeper)
- 89 Unknown other vehicle
- 99 Unknown body type

VEHICLE FORM

V14
(3)

Variable Name: Body Type (cont'd.)

Source: Primary source is vehicle inspection; secondary sources include police report, interviewees, and vehicle registration.

Remarks:

Note the selection of any code is based solely on its body type rather than usage or ownership (i.e., code the vehicle as it was originally manufactured).

Code "01" (Convertible) refers to automobiles with soft or removable hard shells which are considered to be "convertibles". A removable hardtop is one that can be removed without tools, such as older Corvettes or XKE's. This would also include "tarqa" tops. Removable solid roof sections that were bolted on at the factory are considered standard roofs. Cars with sun roofs or "T" tops should be considered as having a standard roof. The position of the top at the time of the collision is not considered when coding the Body Type.

Codes "03", "05" (3 or 5-door hatchback coupe) includes those automobiles with hinged rear "doors" which include large glass cargo portals as found on fastbacks or hatchbacks. Station wagons with hinged doors which open vertically are excluded from this category since they are coded "06" (Station wagon excluding van-based or truck-based station wagon).

Code "08" (Other automobile) refers to other automobiles such as the one-door Isetta, street rods without doors, etc.

Code "11" (Ambulance, hearse type only) refers to hearse body vehicles which may be used for ambulance, funeral, or other purposes (including private usage). Note that only ambulances with a hearse body style are coded here. Ambulances other than hearse types are coded according to their particular body type. These vehicles will subsequently be identified as ambulances under V63, Vehicle Special Use.

A motorcycle (motored cycle) is defined as any motor vehicle having a seat or saddle for the use of the rider and designed to travel on not more than 3 wheels in contact with the ground, but excluding a tractor (Source: Uniform Vehicle Code and Model Traffic Ordinance - revised 1968, section 1-135).

Code "20" (Motorcycle) is restricted to "standard" motorcycles [i.e., it excludes minibikes, motorscooters, or any motorcycles with sidecars attached--these are coded under "28" (Other motorcycle)].

Variable Name: Body Type (cont'd.)

Code "21" [Moped (motorized bicycle)] refers to a motor-driven cycle whose speed attainable in 1 mile is 30 mph or less, which is equipped with a motor that produces 2-horsepower or less. If an internal combustion engine is used, the piston displacement shall not exceed 50 cc and the power drive system shall not require the operator to shift gears.

Codes "30" through "39" refer to vehicles (excluding vans, truck-based station wagons, etc.) which are designed to transport more than ten persons.

Code "30" (School bus) refers to vehicles which are specifically designed for usage by a school corporation for the purpose of transporting children independent of usage and ownership at the time of the accident. Body type alone, independent of color (e.g., yellow), is the determining criterion.

Code "31" (Cross country) refers to busses having adjustable seat backs and only one normal entry-exit door. This bus is of the type most commonly used for commercial cross country service; however, recall that body type alone (independent of usage and ownership) is sufficient by itself to use this code.

Code "32" (Transit bus) refers to busses having fixed seatbacks and two normal entry-exit door systems. This bus is of the type most commonly used for intra-city commuter service; however, recall that body type alone (independent of usage and ownership) is sufficient by itself to use this code.

Code "38" (Other bus) is used for busses which are exclusive of the above bus codes or in cases where the investigator has identified and photographed the vehicle but is uncertain as to which of the above bus codes is to be used.

Code "39" (Unknown type bus) is used when the investigator has no information which would allow more specific classification in one of the bus codes.

Code "40" (Van) includes VW bus, Econoline, Chevy Van, Dodge Tradesman, and station wagons based on these models.

Codes "40" and "55" (Van; truck-based station wagon) are to be used in instances where these trucks are used as busses, although not specifically designed for that purpose. It is permissible to consider these trucks as other motor vehicles while stratifying due to limited information on the police report, yet code them under trucks on this variable.

VEHICLE FORM

V14
(5)

Variable Name: Body Type (cont'd.)

Code "41" (Van-commercial cutaway) includes all derivatives other than motor homes that are based on a van chassis, even if greater than 10,000 lbs. GVWR (e.g., Chevrolet Hi Cube Van, Dodge Kary Van, Ford Econoline Parcel Delivery Van).

Code "48" (Other van type) would be used for light duty vans that would not qualify for a more specific code. Possible inclusions for this could be some special use mail vans, milk trucks or light duty step vans. Note that step vans over 10,000 lbs. GVWR would be coded "70".

Code "50" (Pickup) includes all trucks based on a pickup chassis, even if greater than 10,000 lbs. GVWR (e.g., Chevrolet C30, Ford F350, Dodge D300, etc.).

Code "77" (Unknown if pulling trailer) can be used when you know that a truck tractor was involved, but it is unknown if a trailer was attached.

Code "82" (Dune buggy, swamp buggy, etc.) also can be used if an amphibious vehicle is encountered.

Code "83" excludes passenger vehicles which are owned/leased and operated by construction related firms. These should be assigned codes "01" through "06" unless the vehicle has been modified, in which case, it should be coded "08". Construction related includes state or municipally owned road cleaning equipment, or utility related equipment where the model is essentially a special vehicle ("83"). However, some of these vehicles are single unit trucks modified with the cleaning or repair equipment attached front or rear. In the latter case, code straight truck over 10,000 lbs. GVWR ("71" or "72").

Code "88" (Other) is used for special vehicles which are exclusive of the above special vehicle codes (e.g., go-cart).

Fire trucks will be coded based on GVWR and Body Type, and identified under V17, Seating Capacity/Truck Vocation, code "51" (Fire apparatus) and V63, Vehicle Special Use, code "7" (Fire).

Variable Name: Towed Trailing Unit (V14 ≠ 75, 77)

Format: 1 column - numeric

Beginning
Column 25

Element Values:

- 0 No towed unit (or V14 = 75, 77)
Yes, towed trailing unit hitch type
1 Clamp on (temporary)
2 Bumper hitch (bolted)
3 Frame
4 Fifth wheel
5 Other
6 Unknown hitch type

Source: Primary source is vehicle inspection; secondary sources include driver interview, photographs, and police report.

Remarks:

A towed trailing unit includes horse trailers, fifth wheel trailers, travel trailers, camper trailers, boat trailers, truck trailers or any other trailer (except as excluded above).

Code "0" (No towed unit) is used when it is unknown whether or not a trailer was being towed, or when no wheeled unit was being towed by the vehicle, or when V14 (Body Type) is coded "75" (Truck tractor pulling one or more trailers).

Code "1" (Clamp on) is used to describe a trailer hitch that is mounted by bands or clamps that are tightened around the bumper face (no holes are drilled in the bumper for mounting purposes).

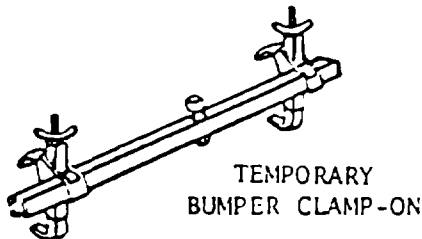

Variable Name: Towed Trailing Unit (V14 ≠ 75, 77) [cont'd.]

Code "2" (Bumper hitch) is used to describe a trailer hitch that is permanently mounted by drilling holes and bolting the hitch to the bumper. Also included would be a trailer ball mounted on a step bumper.

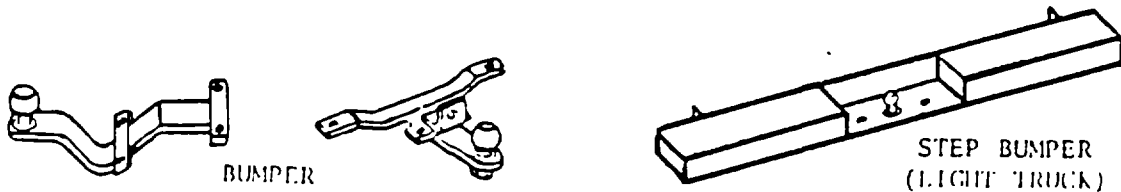

Code "3" (Frame) is used to describe a trailer hitch that is permanently mounted by drilling holes and bolting (or welding) the hitch to the frame rails. In most cases, this type of hitch is also attached to the bumper.

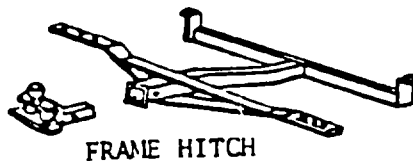

Code "4" (Fifth wheel) is used to describe a trailer hitch that is a permanently mounted rounded plate upon which the trailer rests and is coupled to the towing unit.

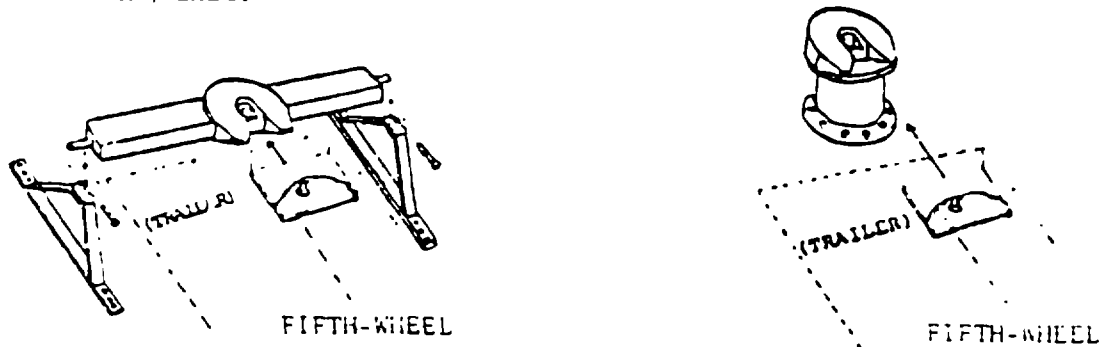

Code "5" (Other) is used to code a trailer hitch that cannot be described by using one of the more specific codes 1 through 4. Also included would be nonfixed linkage (i.e., rope, cable, chain), even if the nonfixed linkage is attached to a specific hitch type.



Code "6" (Unknown hitch type) is used when it is known that a trailer was being towed (V14 ≠ 75, 77) but the specific hitch type is unknown.

Variable Name: Cab Configuration

Format: 1 column - numeric

Beginning
Column 26

Element Values:

0 Not a truck (e.g., automobile, motorcycle)

Cab Over Engine (COE)

1 COE, high entry

2 COE, low entry

3 COE, unknown entry

Conventional (CBE - Cab Behind Engine)

4 2-door (standard)

5 2-door extended cab/4-door crew cab

6 Unknown number of doors

7 Cab alongside engine (CAE)

8 Other

9 Unknown

Source: Primary source is vehicle inspection; secondary sources include driver interview, photographs, and police report.

Remarks:

<u>Code</u>	<u>Description</u>
1	COE, high entry

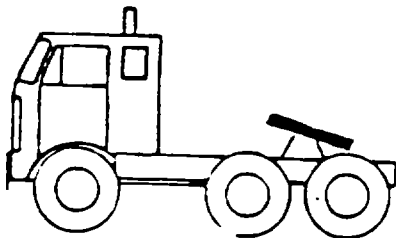

2	COE, low entry
---	----------------

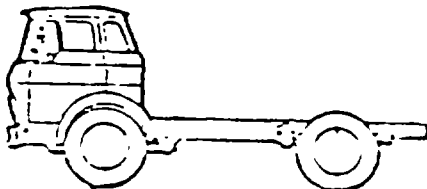

Variable Name: Cab Configuration (cont'd.)

<u>Code</u>	<u>Description</u>
8	Code "8" (Other) is used when the truck cab configuration cannot be classified using one of the above codes. This code is also used for vans (V14 = 40-49) and busses (V14 = 30-39).
9	Code "9" (Unknown) is used when the cab configuration cannot be determined (e.g., no vehicle inspection). Code "9" is also used when it cannot be determined if the vehicle is a truck or another motor vehicle.

The relationship between this variable and V14, Body Type, is shown in the table below.

If V14 Equals	Then V16 Equals
01-29	0
30-49	8
50-79,99	1-9
80-89	0

Variable Name: Seating Capacity/Truck Vocation

Format: 2 columns - numeric

Beginning
Column 27

Element Values:

Passenger Vehicles by Designated Seating Capacity

Motorcycle/Automobile/Van/Bus (exclude pickups)

- 01 One seat position
- 02 Two seat positions
- 03 Three seat positions
- 04 Four seat positions
- 05 Five seat positions
- 06 Six seat positions
- 07 Seven seat positions
- 08 Eight seat positions
- 09 Nine seat positions
- 10 10 to 19 seat positions
- 11 20 to 49 seat positions
- 12 50 or more seat positions
- 13 Motorhome (any light or medium truck based)
- 14 Ambulance/EMS (any auto or truck based)
- 19 Unknown passenger vehicle seating capacity

Cargo Vehicles by Vocation (Cargo Configuration)

Platform

- 20 Platform, flat bed
- 21 Platform with device (e.g., self-loader, spreader)
- 22 Stake
- 23 Drop frame, low bed, lowboy
- 24 Livestock carrier
- 28 Other platform (specify)

Open

- 30 Pickup box (non-dump, includes open box and caps)
- 31 Pickup with slide-in camper
- 32 Dump (any light, medium, or heavy truck based)
- 33 Dump with blade (front with under carriage)
- 34 Hopper (grain)
- 35 Auto carrier/transport (includes boat)
- 36 Van-open top
- 38 Other open (specify)

Closed

- 40 Van-closed top (any light, medium or heavy truck based, e.g., multi-stop)
- 41 Low bed van (e.g., moving van)
- 42 Refrigerated or insulated

Variable Name: Seating Capacity/Truck Vocation (cont'd.)

Cargo Vehicles by Vocation (Cargo Configuration)

Closed (cont'd.)

- 43 Mobile home
- 44 Beverage, bottler
- 45 Container (e.g., piggy back)
- 46 Tank-liquid and gaseous
- 47 Tank-dry bulk
- 48 Other closed (specify)

Service/Utility

- 50 Garbage, refuse (including dumpster)
- 51 Fire apparatus
- 52 Concrete mixer
- 53 Wrecker, tow
- 54 Crane, aerial basket
- 55 Service, mobile repair (e.g., phone line truck)
- 56 Pole (e.g., pipe or log)
- 57 Armored truck
- 58 Other service/utility (specify)
- 71 Truck-tractor - no trailer
- 72 Chassis, incomplete vehicle
- 88 Other cargo vehicle (specify)
- 97 Other nontruck (e.g., construction paver, farm tractor)
- 98 Unknown cargo configuration
- 99 Unknown if passenger or cargo vehicle

Source: Primary source is vehicle inspection; secondary sources include driver interview, photographs, and police report.

Remarks:

Any motor vehicle designed primarily to transport people should be encoded using elements 01-19 to indicate "designed" seating capacity. For those vehicles manufactured with restraints at each "designed" seat (approximately 1968 and newer) which have not been altered (removed restraints or seat types exchanged) the "designed" seating capacity can generally be determined by the number of restraints installed in the vehicle. For altered vehicles, vans with add-on (rigidly attached) seats, or most vehicles manufactured prior to 1968 the seating capacity can be determined from the seat width. Seats that are not rigidly attached to the vehicle are not considered as part of the seating capacity.

Variable Name: Cab Configuration (cont'd.)

<u>Code</u>	<u>Description</u>
3	Code "3" is used when it can be determined that the truck has a COE configuration, however, it is unknown whether it has a high or low entry.

4	CBE - 2-door (standard)
---	-------------------------

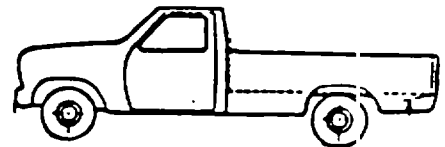
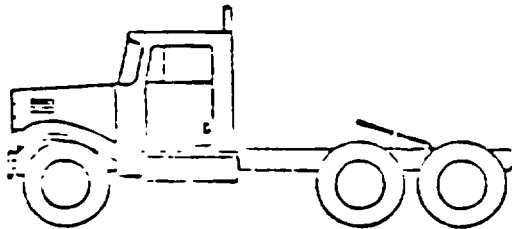

5	CRE - 2-door extended cab/4-door crew cab
---	---

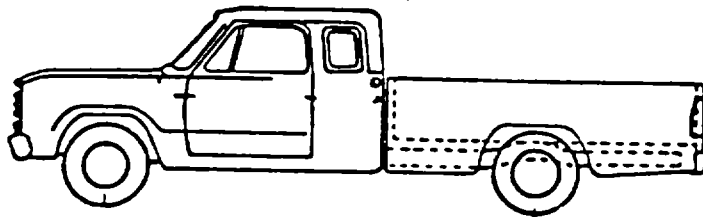

Extended Cab

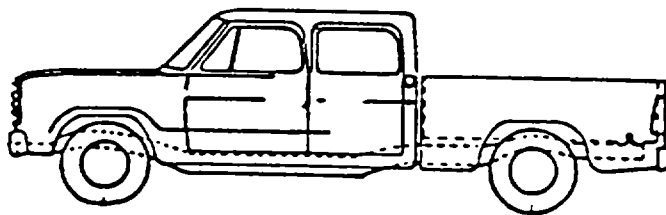

Crew Cab

6	Code "6" is used when it can be determined that the truck has a CBF (Conventional) configuration, however, the number of doors is unknown.
---	--

7	Cab alongside engine (CAE)
---	----------------------------

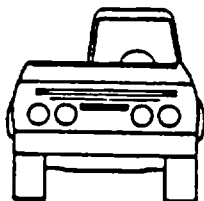

Variable Name: Seating Capacity/Truck Vocation (cont'd.)

Code Description

20 Platform, flatbed - A body having a floor without sides or roof.

Example:

V14 = 53, 71 or 72
V15 = 0
V17 = 20

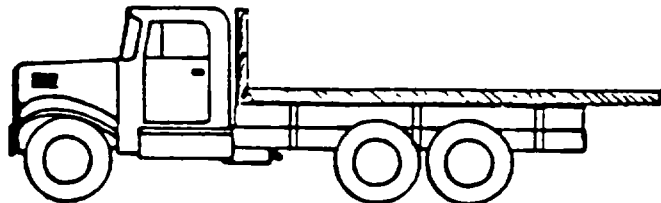
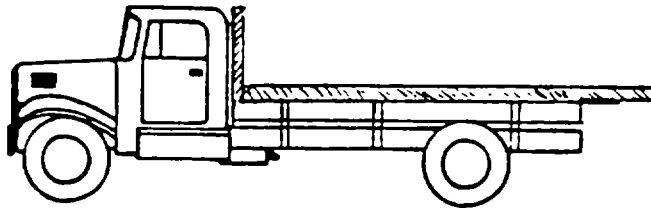

V14 = 75
V15 = 0
V17 = 20

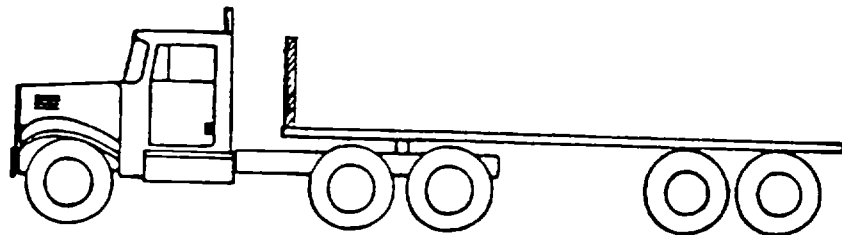

21 Platform with device (example: crane or "cherry picker") - A body having a floor without sides or roof on which additional machinery is securely mounted for work or other purposes.

Example:

V14 = 53, 71 or 72
V15 = 0
V17 = 21

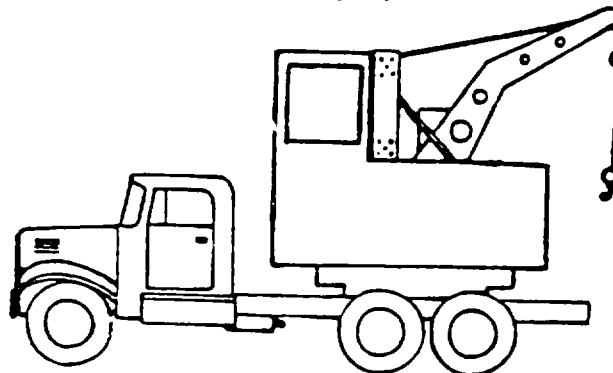

Variable Name: Seating Capacity/Truck Vocation (cont'd.)

Code Description

22 Stake - A body having a floor without sides or roof with stakes mounted around the perimeter to confine the commodity to the cargo area.

Example:

V14 = 53, 71 or 72
V15 = 0
V17 = 22

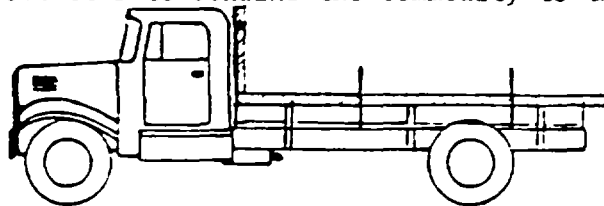

V14 = 75
V15 = 0
V17 = 22

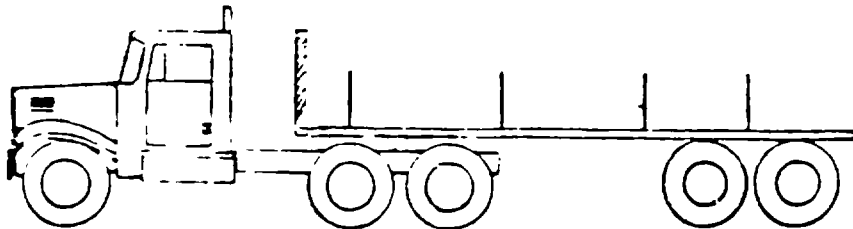

23 Drop frame, low bed, lowboy - A trailer with a platform body constructed to provide a low loading height and designed for the transportation of extremely heavy or bulky property.

Example:

V14 = 75
V15 = 0
V17 = 23

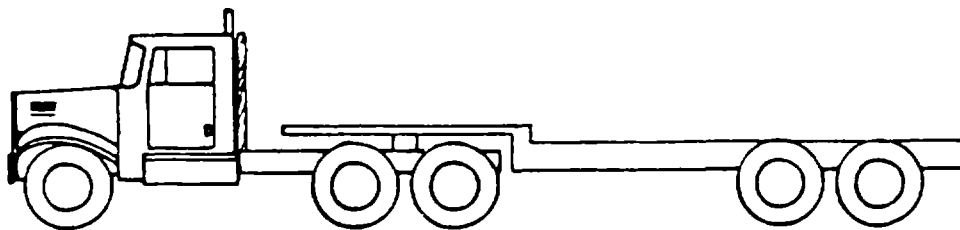

24 Livestock carrier - A rack body with or without roof designed primarily for transportation of livestock.

Example:

V14 = 75
V15 = 0
V17 = 24

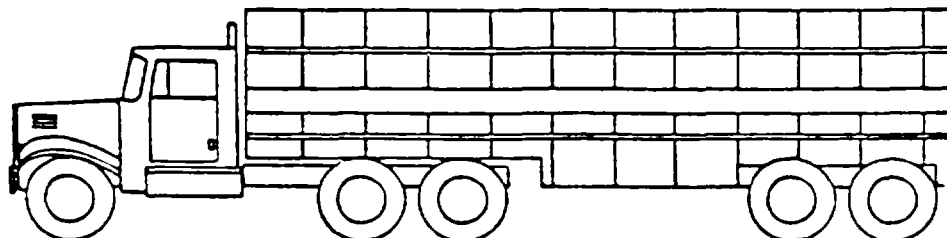

Variable Name: Seating Capacity/Truck Vocation (cont'd).

Code Description

- 30 Pickup box (non-dump, includes open box and caps) - A cap is attached to top of the pickup bed and is not enclosed when standing by itself.
- 31 Pickup with slide-in camper - A slide-in camper is an enclosed (self-contained) unit that slides into the bed of the pickup.
- 32 Dump - A low side open box body, designed primarily to transport dry fluid commodities in bulk, which can be tilted or otherwise manipulated to discharge its load by gravity.

Example:

V14 = 53, 71 or 72
V15 = 0
V17 = 32

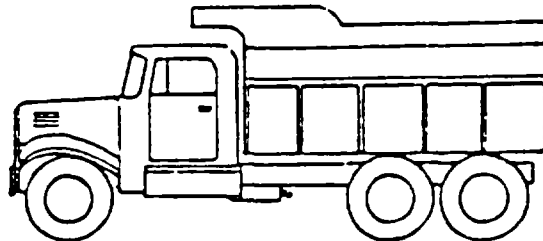

V14 = 75
V15 = 0
V17 = 32
V19 = 06

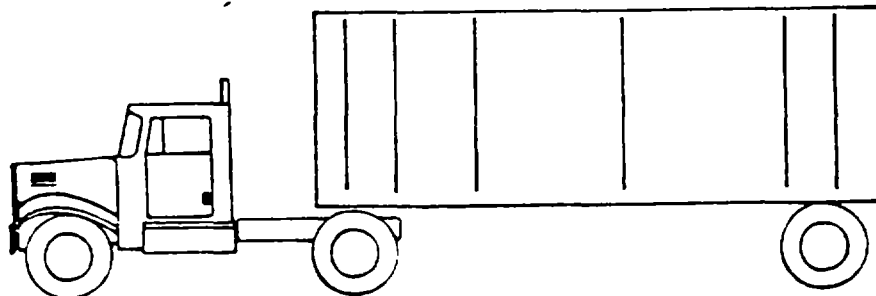

- 35 Auto carrier/boat carrier - A body designed primarily for the transportation of other transport vehicles.

Example:

V14 = 75
V15 = 0
V17 = 35

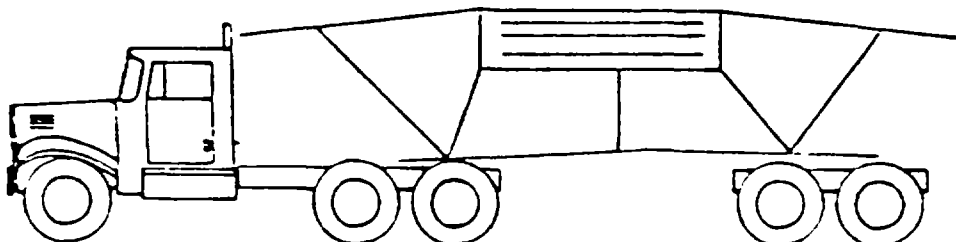

Variable Name: Seating Capacity/Truck Vocation (cont'd.)

Code Description

V14 = 75
V15 = 0
V17 = 35

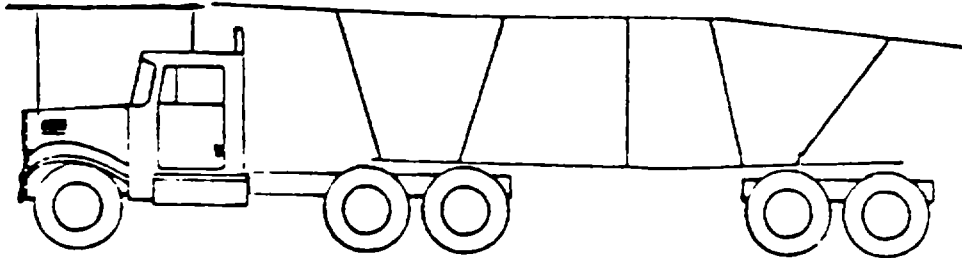

36 Van-open top - A body with high closed sides and ends, and a removable top, which usually is a tarpaulin cover.

Example:

V14 = 53, 71 or 72
V15 = 0
V17 = 36

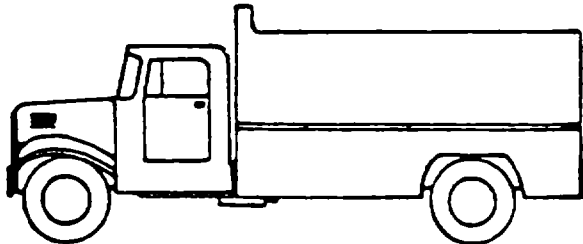

V14 = 75
V15 = 0
V17 = 36

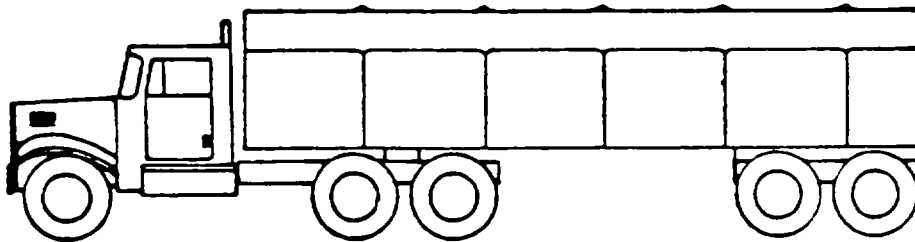

40 Van-closed top - A fully enclosed body designed primarily for the transportation of package commodities.

Example:

V14 = 41, 53, 70, 71 or 72
V15 = 0
V17 = 40

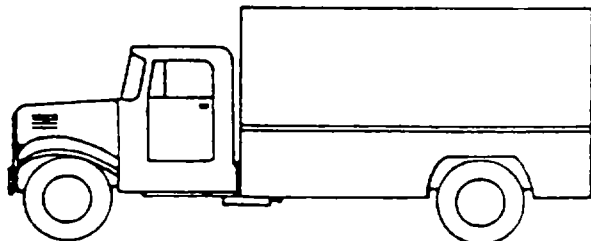

Variable Name: Seating Capacity/Truck Vocation (cont'd.)

Code Description

V14 = 75
V15 = 0
V17 = 40

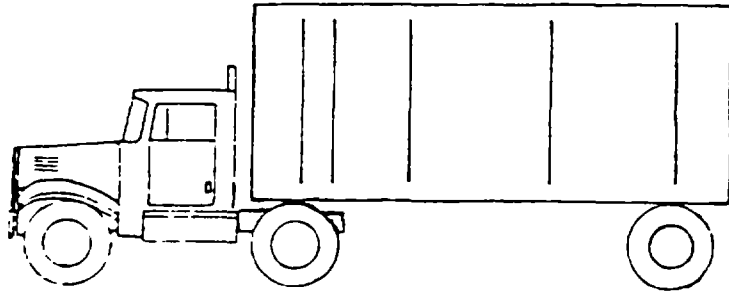

40 Van-closed top (e.g., multi-stop or walk-in) - A fully enclosed body with driver's compartment integral and designed for easy access.

Example:

V14 = 70
V15 = 0
V17 = 40

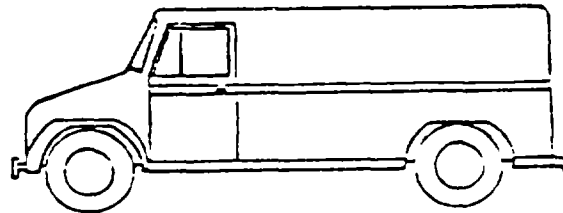

V14 = 70
V15 = 0
V17 = 40

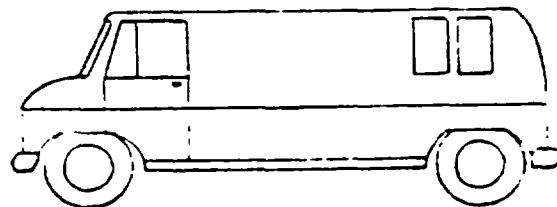

41 Low bed van (e.g., moving van) - A van body designed primarily for transportation of furniture or household goods. Customarily, when truck-mounted, it includes an integral driver's compartment.

Example:

V14 = 41, 53, 71 or 72
V15 = 0
V17 = 41

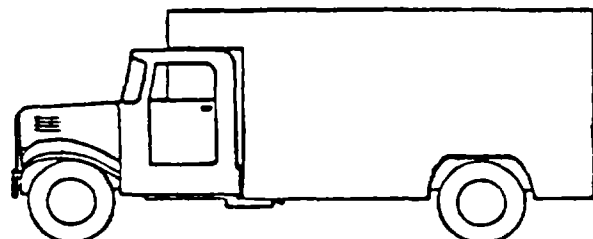

Variable Name: Seating Capacity/Truck Vocation (cont'd.)

Code Description

V14 = 75
V15 = 1
V17 = 41

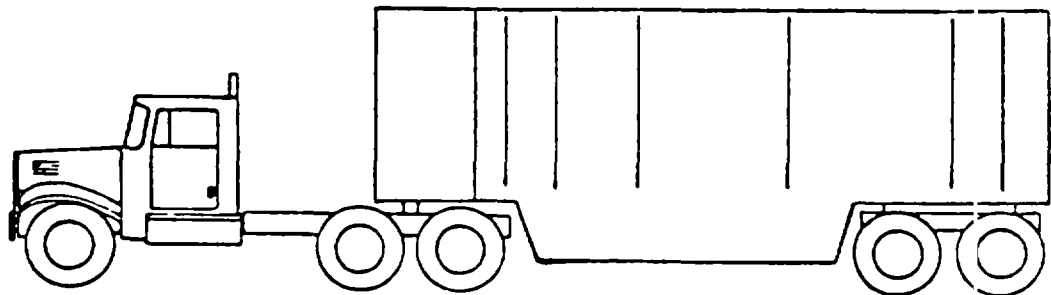

42 Refrigerated or insulated - A van body designed primarily for the transportation of commodities or the vending of food, beverage, or confections at controlled temperatures. It may be provided with equipment for refrigeration or heating.

Example:

V14 = 41, 48, 53, 70, 71 or 72
V15 = 0
V17 = 42

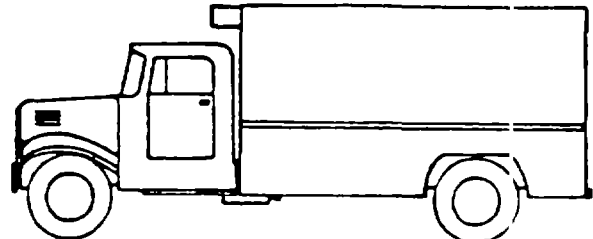

V14 = 75
V15 = 0
V17 = 42

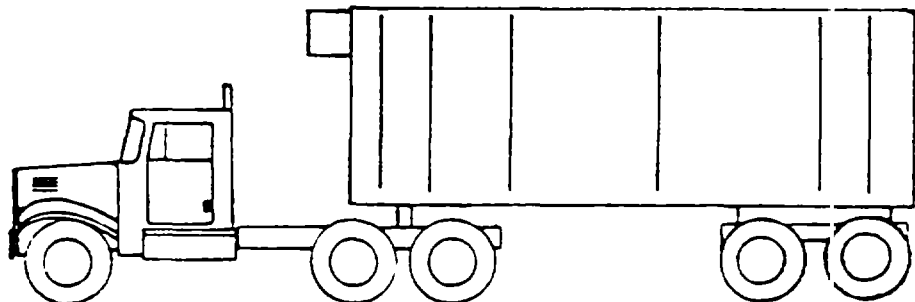

43 Mobile home - A body designed for use as an abode with bunk(s), including house body and camper body.

Example:

V14 = 75
V15 = 0
V17 = 43

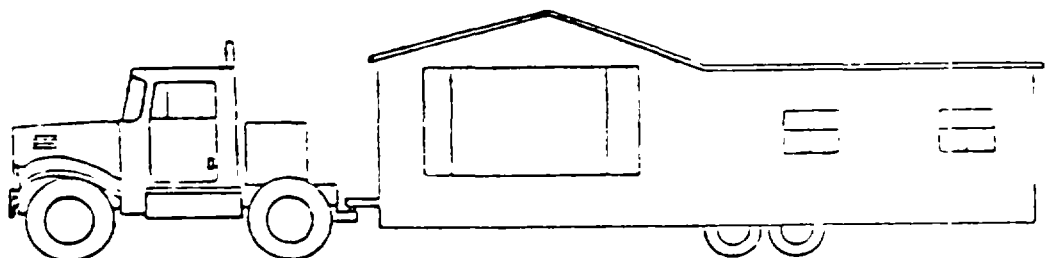

Variable Name: Seating Capacity/Truck Vocation (cont'd).

Code Description

44 Beverage, bottler - A body designed primarily for the transportation of cased, bottled beverages on opened or closed shelves, A-frame or pallets.

Example:

V14 = 71 or 72
V15 = 0
V17 = 44

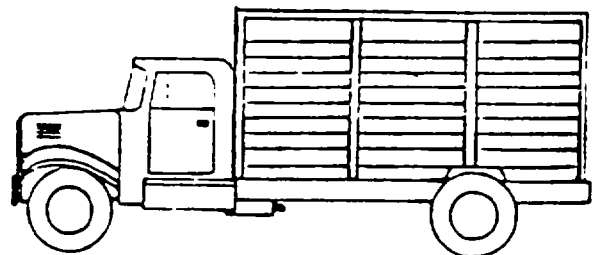

46 Tank-liquid and gaseous - A body designed for the transport of bulk liquid commodities (i.e., petroleum, oil, water, etc.).

Example:

V14 = 53, 71 or 72
V15 = 0
V17 = 46

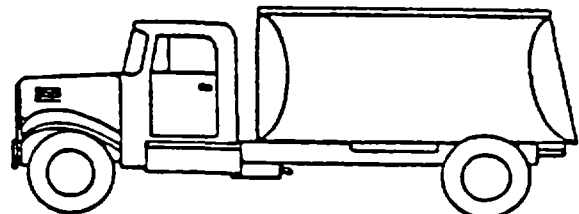

V14 = 75
V15 = 0
V17 = 46

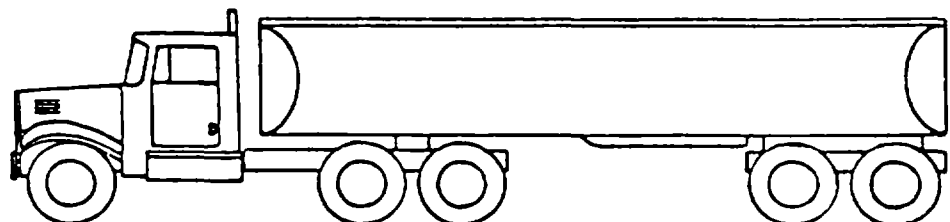

47 Tank-dry bulk - A body designed for the transport of bulk dry commodities (i.e., grain or dry chemicals).

Example:

V14 = 75
V15 = 0
V17 = 47

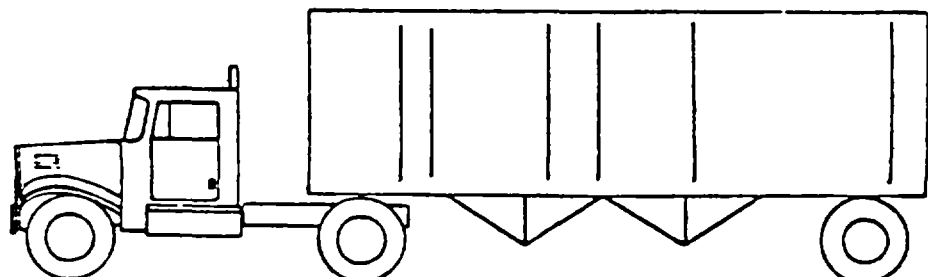

Variable Name: Seating Capacity/Truck Vocation (cont'd.)

Code Description

- 50 Garbage, refuse - A body designed primarily for the collection of garbage and refuse. It is frequently equipped within the body.

Example:

V14 = 71 or 72
V15 = 0
V17 = 50

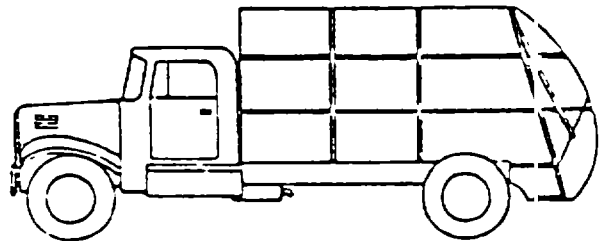

- 52 Cement mixer - A body designed and equipped to mix or agitate concrete.

Example:

V14 = 71 or 72
V15 = 0
V17 = 52

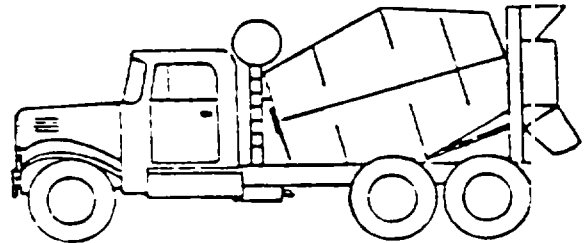

- 53 Wrecker, tow - A body designed primarily for the transportation of equipment for salvaging disabled vehicles and equipped with means for hoisting and towing such vehicles.

Example:

V14 = 54, 71 or 72
V15 = 0
V17 = 53

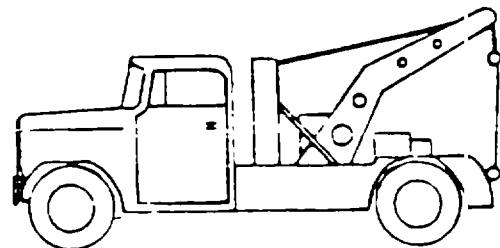

- 55 Service, mobile repair (example: electrical utility repair vehicle) - A body designed primarily for the transportation of tools, equipment, and supplies for construction, maintenance, and repair purposes.

Example:

V14 = 53, 71 or 72
V15 = 0
V17 = 55

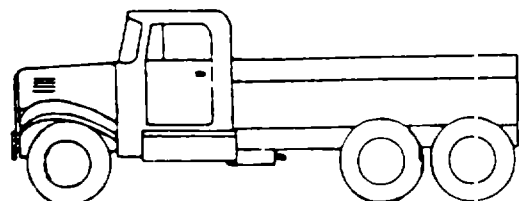

Variable Name: Seating Capacity/Truck Vocation (cont'd.)

Code Description

56 Pole - A body comprised of sill, bolsters, with or without headboard, with provision for uprights, and designed primarily for the transportation of logs, poles, pipes or other loads which may be boomed.

Example:

V14 = 75
V15 = 0
V17 = 56

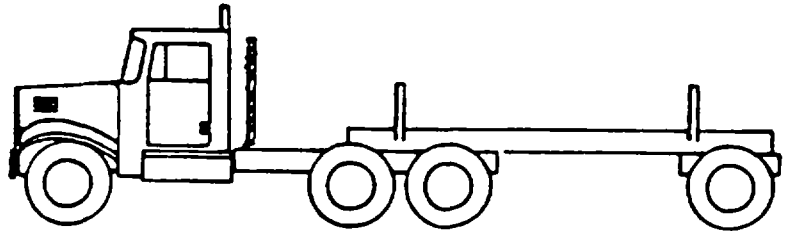

57 Armored truck - An enclosed cargo body with integral driver's compartment so constructed as to protect cargo and crew from overt attack.

Example:

V14 = 41, 53, 70, 71 or 72
V15 = 0
V17 = 57

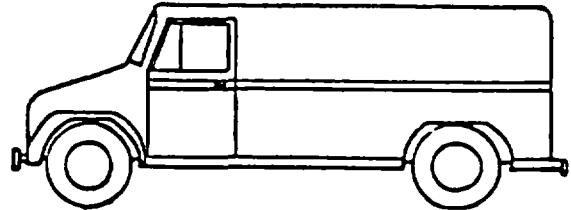

71 Truck-tractor - no trailer - Any vehicle constructed primarily to pull a semi-trailer, full trailer, pole trailer, house trailer or equipment.

Example:

V14 = 74
V15 = 0
V17 = 71

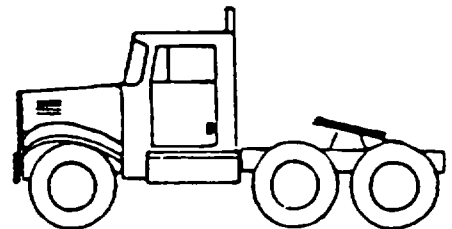
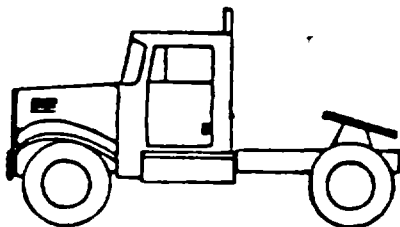

VEHICLE FORM

V17
(12)

Variable Name: Seating Capacity/Truck Vocation (cont'd.)

Code Description

Cab over engine (COE) configuration

V14 = 74
V15 = 0
V17 = 71

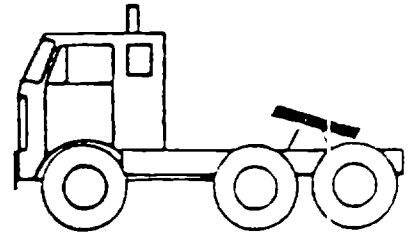
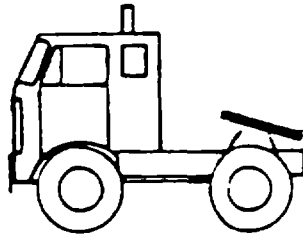

Cab behind engine (CRE) configuration

V14 = 74
V15 = 0
V17 = 71

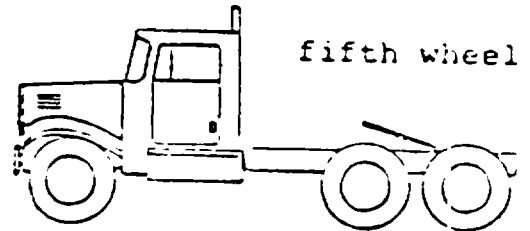

Cab alongside engine (CAE) configuration

V14 = 74
V15 = 0
V17 = 71

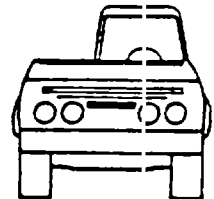

V14 = 74
V15 = 1
V17 = 71

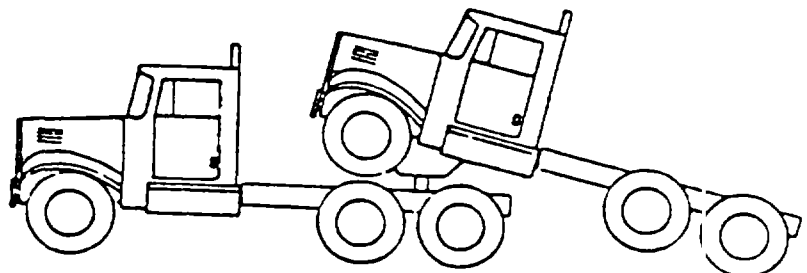

Variable Name: Seating Capacity/Truck Vocation (cont'd.)

Code Description

V14 = 74
V15 = 1
V17 = 71

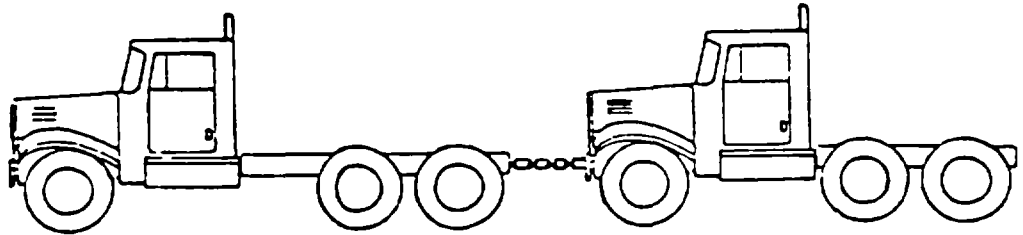

Other (Codes "28", "38", "48", "58", and "97") - Includes any body style that is known and can be typed, yet cannot be coded in one of the specific attributes.

Unknown (Codes 19 and 98) - Includes body types that can be identified as either passenger or cargo vehicles but the seating capacity/cargo configuration is unknown.

Unknown (Code 99) - Includes hit and run vehicles which are not identifiable by body type in the police accident report. This also includes any other vehicle which is not inspected and the information on the PAR is not sufficient to identify the body type as being passenger or cargo.

Variable Name: Tractor With Dromedary

Format: 1 column - numeric

Beginning
Column 29

Element Values:

- 0 Not truck over 10,000 lbs. GVWR (V14 ≠ 70 - 78)
- 1 No
- 2 Yes
- 9 Unknown

Source: Primary source is vehicle inspection; secondary sources include driver interview, photographs, and police report.

Remarks:

A dromedary, for NASS purposes, is a tractor that has a separate cargo carrying area on its own frame. If the tractor fits this definition, then use code "2" (Yes). If the tractor does not have a separate cargo carrying area on its own frame, then code "1" (No). Use "9" (Unknown) if it cannot be determined.

If the final stratification (AØ8) for the case is A - H, and V14 = 79 (Unknown truck type [light/medium/heavy]):

- a. Assume that the vehicle is a light truck.
- b. Variables V18-V24 should be coded "0" (Not truck over (10,000 lbs. GVWR [V14 = 70-78])).

If the final stratification (AØ8) is J - M and V14 = 79 (Unknown truck type [light/medium/heavy]):

- a. Assume that the vehicle is a medium/heavy truck.
- b. Variables V18-V24 should be appropriately coded one of valid codes 1-9.

VEHICLE FORM

V19
V20
V21
V22

Variable Name: Number of Axles - Power Unit (Trucks Over 10,000 lbs. GVWR - V14 = 70-78)
 Number of Axles - 1st Trailer (Trucks Over 10,000 lbs. GVWR - V14 = 70-78)
 Number of Axles - 2nd Trailer (Trucks Over 10,000 lbs. GVWR - V14 = 70-78)
 Number of Axles - 3rd Trailer (Trucks Over 10,000 lbs. GVWR - V14 = 70-78)

Format: 1 column - numeric

Beginning
Column 30
31
32
33

Element Values:

0 Not truck over 10,000 lbs. GVWR (V14 ≠ 70-78)	5 Five
1 One	6 Six
2 Two	7 Seven or more
3 Three	8 No trailer
4 Four	9 Unknown

Source: Primary source is vehicle inspection; secondary sources include driver interview, photographs (newspaper, police, etc.), and police report.

Remarks:

Axles are coded for the unit to which they are primarily attached. Axles on a converter dolly are coded for the unit under which they exist.

Liftable axles (axles which are intermittently load bearing) are coded independent of their position at the time of the accident; it doesn't matter if they were up or down.

If the final stratification (A08) for the case is A - H, and V14 = 79 (Unknown truck type [light/medium/heavy]):

- a. Assume that the vehicle is a light truck.
- b. Variables V18-24 should be coded "0" (Not truck over 10,000 lbs. GVWR [V14 = 70-78]).

VEHICLE FORM

V19
 V20
 V21
 V22
 (2)

Variable Name: Number of Axles - Power Unit (Trucks Over 10,000 lbs. GVW - V14 = 70-78)
 Number of Axles - 1st Trailer (Trucks Over 10,000 lbs. GVW - V14 = 70-78)
 Number of Axles - 2nd Trailer (Trucks Over 10,000 lbs. GVW - V14 = 70-78)
 Number of Axles - 3rd Trailer (Trucks Over 10,000 lbs. GVW - V14 = 70-78) (cont'd.)

If the final stratification (A08) is J - M and V14 = 79 (Unknown truck type [light/medium/heavy]):

- a. Assume that the vehicle is a medium/heavy truck.
- b. Variables V18-V24 should be appropriately coded one of valid codes 1-9.

"DOLLY LEGS", which are used to hold up the front of a semi-trailer when not attached to a tractor, should not be counted as an axle for Variables 20-22.

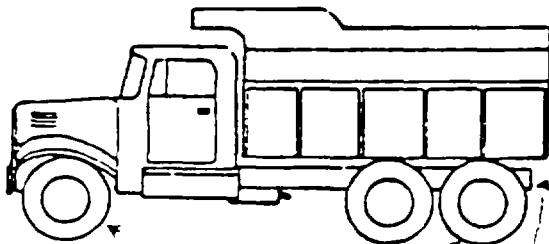

Codes: 19 = 1 + 1+1 = 3
 20 = 8
 21 = 8
 22 = 8

EXAMPLES:

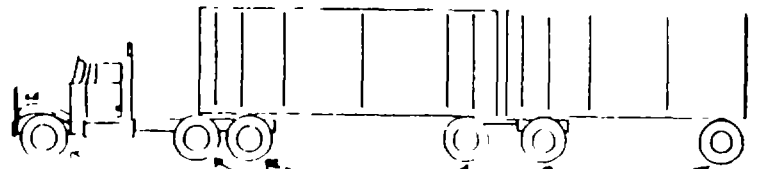

Codes: 19 = 1 + 1+1 = 3
 20 = = 1
 21 = +1 = 2
 22 = = 8

VEHICLE FORM

V19
 V20
 V21
 V22
 (3)

Variable Name: Number of Axles - Power Unit (Trucks Over 10,000 lbs. GVWR - V14 = 70-78) [cont'd.]
 Number of Axles - 1st Trailer (Trucks Over 10,000 lbs. GVWR - V14 = 70-78) [cont'd.]
 Number of Axles - 2nd Trailer (Trucks Over 10,000 lbs. GVWR - V14 = 70-78) [cont'd.]
 Number of Axles - 3rd Trailer (Trucks Over 10,000 lbs. GVWR - V14 = 70-78) [cont'd.]

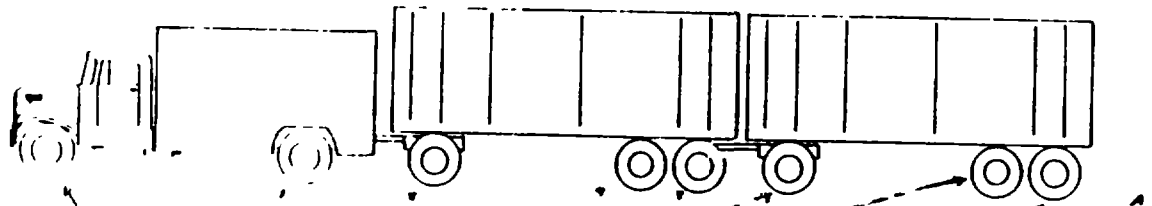

Codes: 19 = 1 + 1 = 2
 20 = 1+1+1 = 3
 21 = 1+1+1 = 3
 22 = = 8

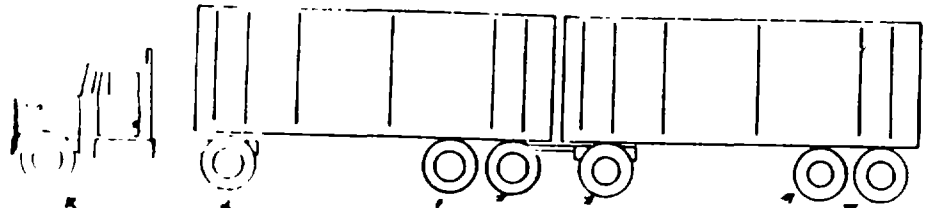

Codes: 19 = 1 + 1 = 2
 20 = 1+1 = 2
 21 = 1+1+1 = 3
 22 = = 8

VEHICLE FORM

V23

Variable Name: Type of Brakes (Trucks Over 10,000 lbs. GVWR - V14 = 70-78)

Format: 1 column - numeric

Beginning
Column 34

Element Values:

- 0 Not truck over 10,000 lbs. GVWR (V14 ≠ 70-78)
- 1 Air
- 2 Hydraulic
- 3 Electric [should not occur]
- 4 Other (specify)
- 9 Unknown

Source: Primary sources are the vehicle inspection and the driver interview.

Remarks:

If the vehicle qualifies as a medium or heavy truck, then the investigator should be sure to write on page 2 of the Driver Form (in the Specific Question block) a question to ask the driver concerning the type of brakes used by the power unit.

If the final stratification (AØ8) for the case is A - H, and V14 = 79 (Unknown truck type [light/medium/heavy]):

- a. Assume that the vehicle is a light truck.
- b. Variables V18-V24 should be coded "0" (Not truck over 10,000 lbs. GVWR [V14 = 70-78]).

If the final stratification (AØ8) is J - M and V14 = 79 (Unknown truck type [light/medium/heavy]):

- a. Assume that the vehicle is a medium/heavy truck.
- b. Variables V18-V24 should be appropriately coded one of valid codes 1-9.

For tractor/trailer units, code the brake system of the tractor and annotate the trailer brake system on the vehicle sketch (pages 3H-3K).

Air (code "1") brakes are normally recognized by a cylinder chamber that is attached to the brake drum.

VEHICLE FORM

V23

(2)

Variable Name: Type of Brakes (Trucks Over 10,000 lbs. GVWR - V14 = 70-78)
[cont'd.]

Hydraulic (code "2") brakes are normally recognized by a fluid line that leads directly into the brake drum.

Electric (code "3") brakes are normally found on trailers only (i.e., RV trailers, some derivative of RV trailers, and medium to light duty utility trailers). They are normally recognized by electrical wiring that leads directly to the brake drum.

Variable Name: Type of Brakes (Trucks Over 10,000 lbs. GVWR - V14 = 70-78)
[cont'd.]

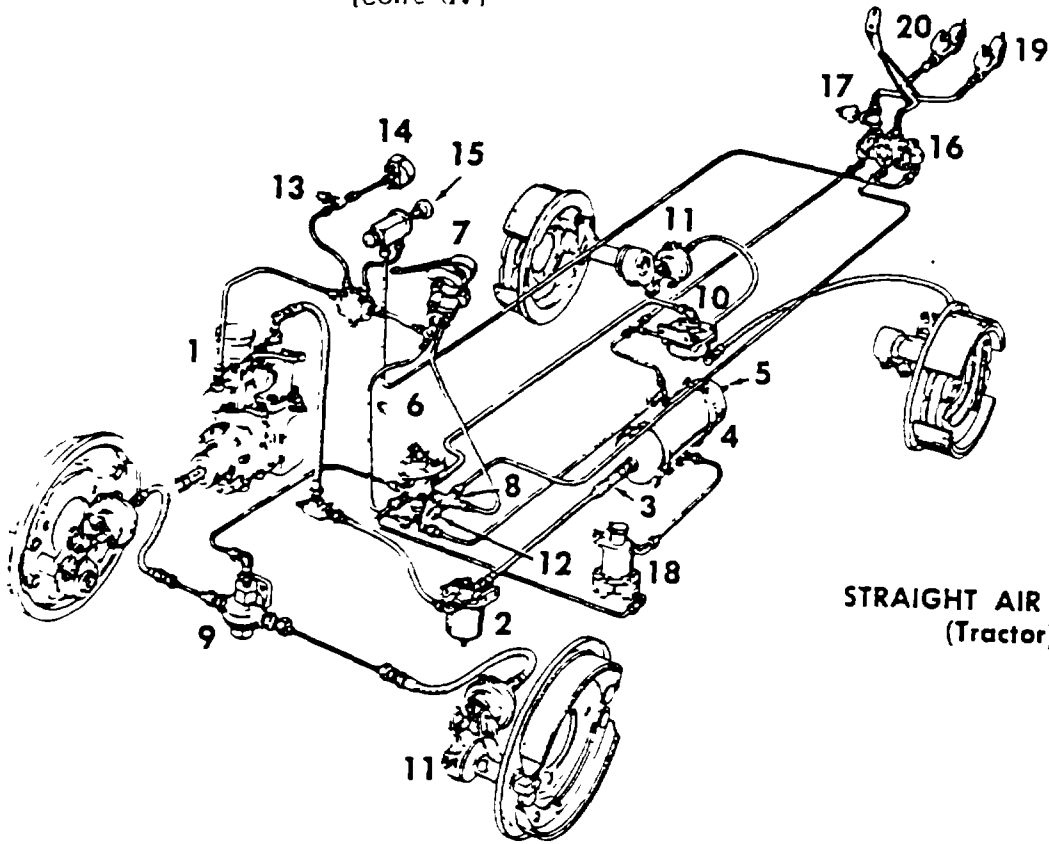

STRAIGHT AIR SYSTEM
(Tractor)

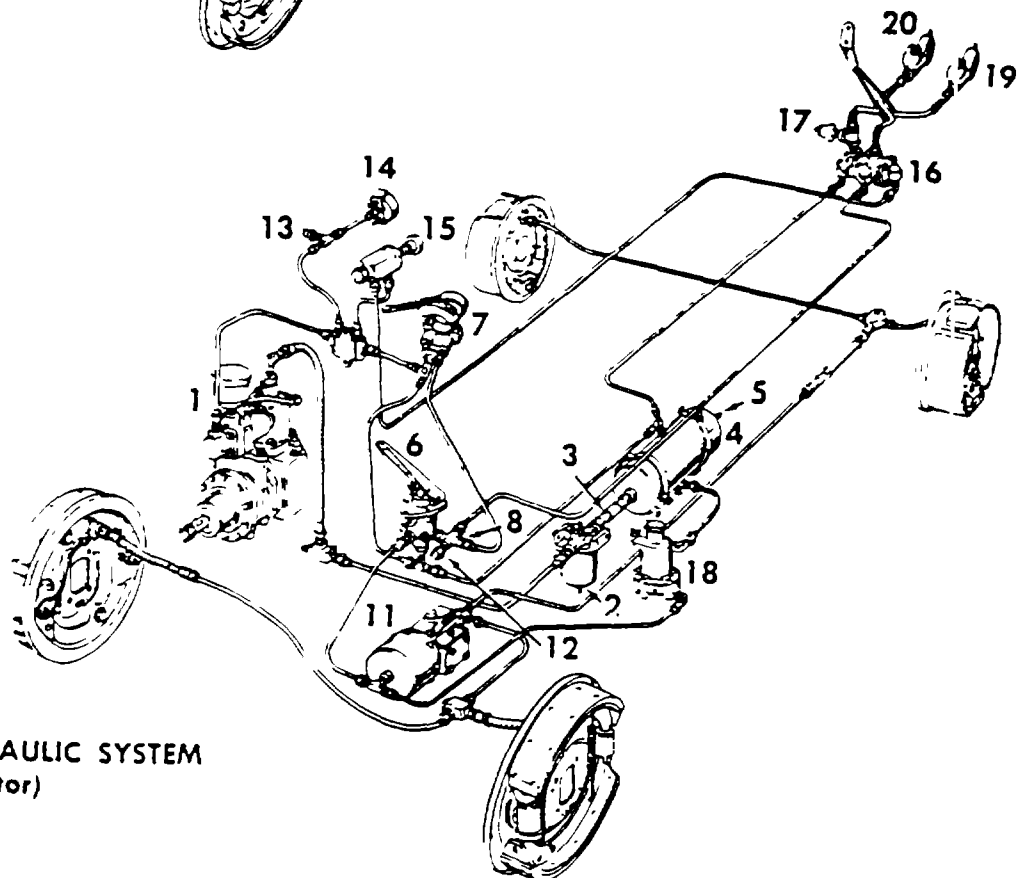

AIR-OVER-HYDRAULIC SYSTEM
(Tractor)

Variable Name: Type of Brakes (Trucks Over 10,000 lbs. GVWR - V14 = 70-78)
[cont'd.]

PROTECTED TRACTOR

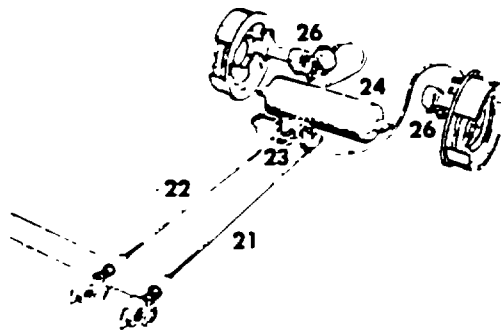

STRAIGHT AIR SYSTEM (Semi-Trailer)

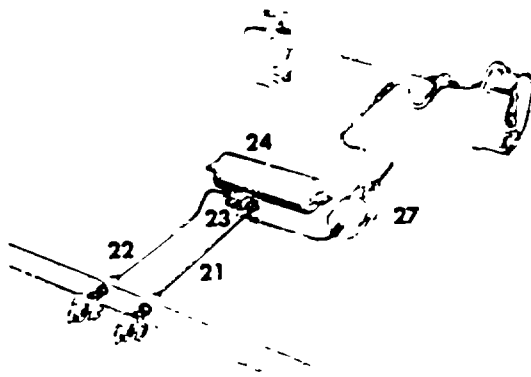

AIR-OVER-HYDRAULIC SYSTEM (Semi-Trailer)

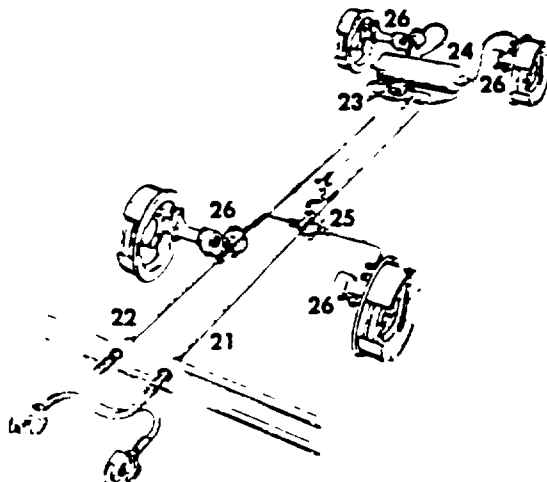

STRAIGHT AIR SYSTEM (Full Trailer)

1. Compressor (includes control value)
2. Alcohol injector--accessory
3. Single check valve
4. Air tank
5. Reservoir safety value
6. Foot application value
7. Hand application value
8. Two-way check value
9. Quick-release value
10. Relay quick-release value,
or
Quick-release value
11. Straight Air:
Brake chamber or Power cylinder
Air-Over-Hydraulic:
Power cluster
12. Switch, normal stop light circuit
13. Switch, low pressure indicator circuit
14. Air gauge
15. Emergency brake value
16. Tractor air line protection value
17. Switch, emergency stop light circuit
18. Moisture ejection value--accessory
19. Emergency air line and hose coupler
20. Service air line and hose coupler

PROTECTED TRAILER

21. Emergency air line
22. Service air line
23. Relay quick-release emergency (breakaway) valve
24. Close-coupled trailer tank
25. Quick-release value
26. Brake chamber and slack adjuster
27. Power cluster

VEHICLE FORM

V24

Variable Name: Gross Vehicle Weight Rating (GVWR) (V14 = 70-78)

Format: 1 column - numeric

Beginning
Column 35

Element Values:

- 0 Not truck over 10,000 lbs. GVWR (V14 ≠ 70-78)
- 1 10,001-14,000 lbs.
- 2 14,001-16,000 lbs.
- 3 16,001-19,500 lbs.
- 4 19,501-26,000 lbs.
- 5 26,001-33,000 lbs.
- 6 33,001 lbs. and above
- 9 Unknown

Source: Primary source is the vehicle inspection; secondary sources include interviewees, reference books, police report, and vehicle registration files.

Remarks:

Gross vehicle weight rating (GVWR) is the value specified by the manufacturer as the acceptable loaded weight of a single vehicle or power unit. This would include all equipment, fuel, body, cargo, driver, etc.

Some information regarding GVWR is contained in the VIN. Proper deciphering of the VIN, using the National Automobile Theft Bureau (NATR) motor vehicle identification manual, may provide the GVWR of the vehicle. In addition, automobile reference books like: Branham Automobile Reference Book, Gasoline Truck Index, Diesel Truck Index, etc., contain GVWR information. Based on vehicle make, model, and year, proper rating can usually be ascertained from these reference books. (NOTE: This variable only applies to the power unit and is a weight rating, not an actual vehicle weight.)

Code "0" is used for any motor vehicle not classified as a truck with a GVWR greater than 10,000 lbs.

Codes "1" through "6" are used to identify the manufacturer's GVWR (10,000 - infinity) for vehicles classified as trucks (V14 - 70-78).

Code "9" is used when a truck could be over 10,000 lbs. GVWR, however, the specific GVWR is unknown. If the specific GVWR is unknown, yet it is known to be under 10,000 lbs. GVWR, code "0" would apply. Code "9" is also used when the vehicle body type cannot be determined (e.g., hit and run vehicle).

VEHICLE FORM

V24
(2)

Variable Name: Gross Vehicle Weight Rating (GVWR) (V14 = 70-78) [cont'd.]

If the final stratification (A08) for the case is A - H, and V14 = 79 (Unknown truck type [light/medium/heavy]):

- a. Assume that the vehicle is a light truck.
- b. Variables V18-V24 should be coded "0" (Not truck over 10,000 lbs. GVWR [V14 = 70-78]).

If the final stratification (A08) is J - M, and V14 = 79 (Unknown truck type [light/medium/heavy]):

- a. Assume that the vehicle is a medium/heavy truck.
- b. Variables V18-V24 should be appropriately coded one of valid codes 1-9.

VEHICLE FORM

Sub/V24

(1)

Form Page 3

INSTRUCTIONS FOR COMPLETION OF FIELD MEASUREMENTS PAGE

Document all the necessary field measurements on this page following the Crush Measurement Techniques protocol as specified in the Vehicle Inspection section of the NASS Accident Investigation Procedures Manual. Complete the top portion (measurements related to shift and bowing) when applicable. The first line would be used for base line measurements. The second line would be used for free space adjustments, and the third line would be used for recording the crush resultant. Use as many lines as necessary when applying averaging techniques. For example, on a side impact with sill override, the crush measurements taken along the plane of maximum crush are averaged with the measurements taken at the sill level. Thus, seven lines will be necessary to describe the damage profile and all seven lines will have the same impact number but different L, C, and D measurements. Note that the measurements on the seventh line are average measurements and, thus, should be annotated average under Column 2 (Plane of C-measurements).

For fiberglass bodied vehicles (e.g., Corvettes), "C" measurements should be taken where the depths of penetration or crush can be determined. This usually occurs where structural supporting members for the fiberglass panels have been deformed. For the cases where the fiberglass panels are cracked and resume their original shape or where sections are completely broken away, "C" measurements are not applicable.

INSTRUCTIONS FOR COMPLETION OF VEHICLE SKETCH

The investigator must keep in mind that all relevant data is not clearly recognized and encoded when the vehicle is inspected. Some information, of no apparent value at the time of the inspection, may be of great value in explaining vehicle or occupant phenomena in the subsequent reconstruction. For this reason, all scrapes, scratches, transfers, buckling and indications of engagement or relative motion must be annotated on this form. If there is insufficient room for this purpose, use a numerical coding scheme in which the numerals on the form (page 3A through 3P) are keyed to the investigator's descriptive statements on the back of the page.

All the observed damage is sketched on page 3A (or 3B through 3P) of the Vehicle Form. Any damage known to be pre-crash is so specified. In sketching the damage, boundaries of the damaged area are marked by solid lines, with damage highlighted by crosshatching (XXXXXXXXXX) to indicate direct damage and single hatching (/////////) to indicate induced damage.

The original and post-crash wheelbase, front and rear overhangs, as well as the dimensions required to determine extent-zone (column 7 of CDC/TDC) are measured and documented on page 3A (or 3B through 3P). Also, the vehicle number, the damage to the tires, wheel steer angles, type of transmission, average track (front track for tractors and straight trucks), maximum width (cab width for tractors and straight trucks), curb weight, overall length, wheel base, engine size (number of cylinders and displacement) of the vehicle, and the location of maximum crush are measured and documented on the page.

For Pedestrian accidents involving the front of the vehicle the back of the page must also be completed with the following measurements. The measurements should be adjusted to reflect the at-impact condition of the vehicle (i.e. adjust for post-crash tire deflation or body damage) and should be taken at or near the area of pedestrian contact.

- a) Bumper Height: is measured vertically from the ground to the top of the bumper.
- b) Contact Height-to End of Vertical: is measured vertically from the ground to the end (transition point between the front vertical plane and the hood horizontal plane) of the vertical plane (e.g. for the pictured Vega the end of the vertical plane is at the top of the louvers in the grille). Where the end of the vertical plane is not easily discernable use the 45 degree midpoint between the vertical and horizontal planes. An example of an unusual vehicle would be the V.W. Beetle where the end of the vertical plane occurs at the top of the bumper.

VEHICLE FORM

Sub/'724
'3)

- c) Hood Height-to Horizontal: is measured vertically from the ground to the front edge of the hood (e.g. for the pictured Vega the hood height would be measured from the ground to the height of the hood at the seam between the hood and the grille).
- d) Bumper Lead: is the protrusion of the bumper from the grille measured horizontally.
- e) Hood Length: is measured horizontally from the end of the vertical plane (as defined in Contact Height) to the base of the windshield (e.g. for the pictured Vega the hood length would be measured from the top of the louvers in the grille to the base of the windshield).
- f) Wrap Distance(s): is measured (continuously along the vehicle profile) from the ground to each distinguishable pedestrian contact point (e.g. dents) on the grille, hood and windshield and each point measured should be identified (e.g. top of grille/hip; middle of hood/shoulder; windshield/head).

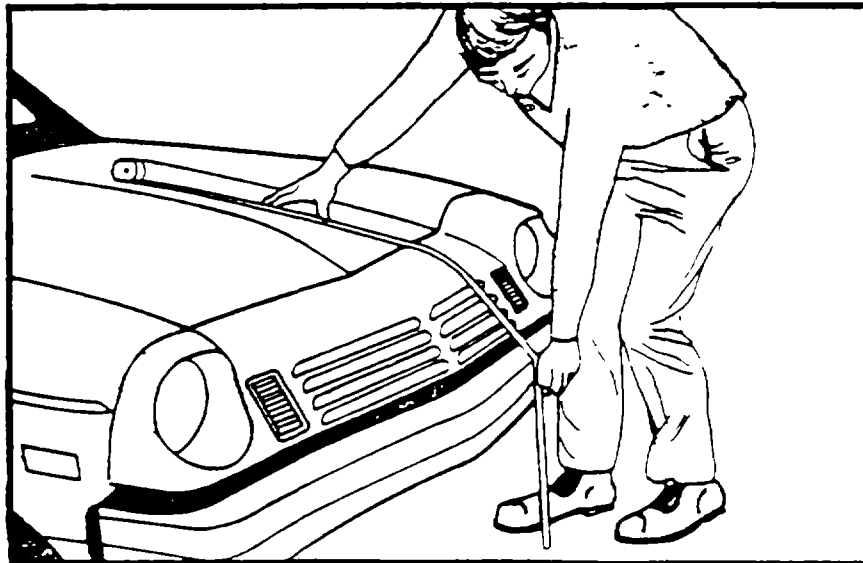
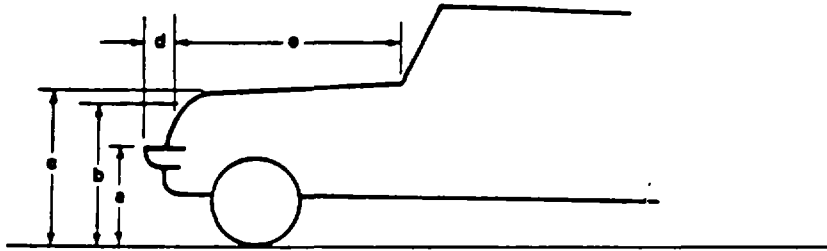

WRAP DISTANCE MEASUREMENT

CDC/TDC RELATED REMARKS

An estimated CDC/TDC should be indicated for each impact (top of page 4). In this estimate write the direction of principal force in increments of ten degrees rather than in clock positions. Thus, if the direction appeared to be approximately ten degrees to the right of straight-ahead, indicate "010". If the direction of force appeared to be ten degrees left of straight-ahead, indicate "-010" ("350"). The final coding of the CDC/TDC at the bottom of page 4 reflects the direction of force in clock positions. So in the example where the principal direction of force (PDOF) is closest to ten degrees to the right of straight-ahead "010" ["-005" ("355") to "025"] then the estimate is coded according to the clock direction--either 12 or 01 as determined by examining all available inputs to ensure accuracy for force assignments. If upon examining all the available inputs the investigator feels the PDOF is more likely to be within +015 to +025 and classifies the clock direction as "01", the top of page 4 should still reflect the original value "010".

When occasional differences which seem to be inconsistent (e.g., PDOF = 010° and clock position = 01) are encountered on page 4, they actually reflect the investigative method; therefore, they can be reconciled by reviewing the entire case and any CRASH output to determine if the difference is reasonable. This procedure allows the reviewer to appreciate what the investigator thought the PDOF (top of page 4) was, to the closest 10 degrees, based upon examination of that vehicle alone, while the clock position representing the force at the bottom of page 4 reflects the final determination after examining all sources (vehicles, objects contacted, scene evidence, CRASH program, etc.). In other words, it is not necessary for the force directions at the top and bottom of page 4 to be compatible; however, any force directions on the final CRASH output must be compatible with the force direction at the bottom of page 4.

VEHICLE FORM

Sub/V24
(5)

Form Page 4

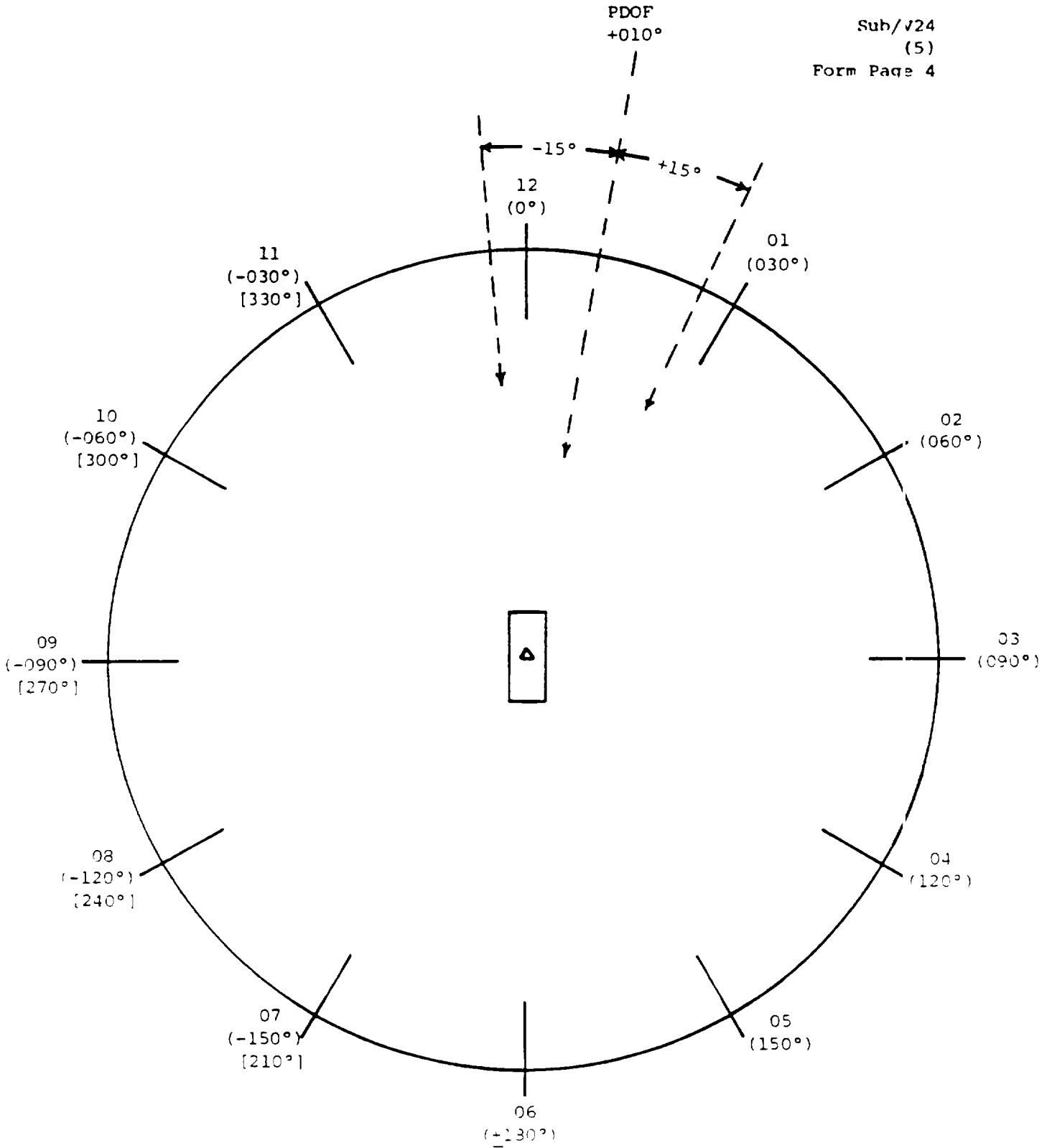

VEHICLE FORM

V25
V34
V43
V52

Variable Name: 1st C.D.C./T.D.C. - Event Number (this vehicle)
2nd C.D.C./T.D.C. - Event Number (this vehicle)
3rd C.D.C./T.D.C. - Event Number (this vehicle)
4th C.D.C./T.D.C. - Event Number (this vehicle)

Format: 1 column - numeric

Beginning
Column 36
48
60
72

Element Values:

Blank - no event
1-7 - First through seventh
8 - Eighth or additional
9 - Unknown

Source: Primary sources are the scene and vehicle inspections; secondary sources include the police report and interviewees.

Remarks:

"Event Number (this vehicle)" is the chronological sequence of impacts to a specific vehicle. In V25, V34, V43, and V52, these events are arranged in order of descending severity. Severity level should be based on CRASH output when available; otherwise, it must be based on damage severity.

CDC/TDCs are listed at the top of page 4 of the Vehicle Form in the order of their occurrence and are linked with an event number specific to this vehicle. In other words, the first line contains the CDC/TDC representing the damage caused by the first event to this vehicle. The second line contains the CDC representing the damage caused by the second event to this vehicle, etc. If more than four events occurred to this vehicle, list the additional CDC-related information on the back of page 4. When the CDC/TDCs are ranked at the bottom of page 4 (Vehicle Form) in the descending order of delta "V" severity, its corresponding event number (this vehicle) is also coded. For example, a vehicle is struck in the rear, loses control and sideswipes a parked car, then continues on finally striking a large tree. The front to rear end collision would be event number one, the sideswipe event number two and the tree event number three. By means of the CRASH program and inspection, the event severities are ranked tree, rear ending, and sideswipe. Therefore, V25 would be coded 3, V34 would be coded 1, and V43 would be coded 2. V52 would be left blank since there was no fourth event.

VEHICLE FORM

V26
V35
V44
V53

Variable Name: 1st C.D.C./T.D.C. - Object Contacted
2nd C.D.C./T.D.C. - Object Contacted
3rd C.D.C./T.D.C. - Object Contacted
4th C.D.C./T.D.C. - Object Contacted

Format: 2 columns - numeric

Beginning
Column 37
49
61
73

Element Values:

00 Noncollision
01 through 30 - If the object contacted by the vehicle under consideration was a motor vehicle in transport, code the Vehicle Number assigned to that vehicle.

Collision with Stationary Object

31 Motor vehicle not in transport	53 Embankment--rock, stone or concrete
32 Tree (< 6 inches in diameter)	54 Building, rigid
33 Tree (> 6 inches in diameter)	55 Building, nonrigid
Highway/Traffic Supports	56 Bridge pier or abutment
34 Luminaire--breakaway	57 Bridge rail
35 Luminaire--nonbreakaway	58 Bridge parapet end
36 Large sign--breakaway	59 Guardrail bridge transition
37 Large sign--nonbreakaway	60 Guardrail end (non-median)
38 Small sign--breakaway	61 Guardrail end (median)
39 Small sign--nonbreakaway	62 Guardrail (non-median)
40 Utility pole	63 Guardrail (median)
41 Other post, pole or support	64 Concrete barrier (non-median)
42 Traffic signal pole	65 Concrete barrier (median)
43 Fence	66 Other median barrier
44 Mail box	67 Other longitudinal barrier (non-median)
45 Delineator	68 Impact attenuator/crash cushion
46 Other movable object (specify)	69 Ground
47 Culvert	70 Train
48 Railroad tracks	71 Ditch
49 Curb	72 Other stationary/fixed object (specify)
50 Abutment	
51 Wall (stone, rock, metal, etc.)	
52 Embankment--earth	

VEHICLE FORM

V26
 V35
 V44
 V53
 (2)

Variable Name: 1st C.D.C./T.D.C. - Object Contacted (cont'd.)
 2nd C.D.C./T.D.C. - Object Contacted (cont'd.)
 3rd C.D.C./T.D.C. - Object Contacted (cont'd.)
 4th C.D.C./T.D.C. - Object Contacted (cont'd.)

Collision with Nonstationary Object

73 Animal
 74 Trailer, disconnected in
 transport
 75 Train
 76 Other nonstationary objects
 (specify)
 81 through 95
 If the object contacted by
 the vehicle under consider-
 ation was a pedestrian or
 nonmotorist, add eighty
 (80) to the Pedestrian or
 Nonmotorist number, and code
 the resultant sum (e.g.,
 5 + 80 = 85)
 96 Vehicle occupant
 97 Other object (specify)
 99 Unknown

Source: Primary sources are the scene and vehicle inspections; secondary sources include the police report and interviewees.

Remarks:

Code the appropriate object contacted for each event even if there is no C.D.C./T.D.C.

This section is not to be completed until after the CRASH program is exercised except for those cases where: (1) the CRASH program is inapplicable, (2) the vehicle has sustained but one impact and there is insufficient data for a trajectory reconstruction to aid in the determination of force directions, or (3) the vehicle is outside the scope of CDC-SAE, J224 MAR80.

Code "00" (Noncollision) refers to those situations where this vehicle's harmful event (see ANSI D16.1-1976, section 2.3.3, page 8) did not in any sequence result from an impact. Examples of such situations are covered under codes "02" through "07" of A10, First Harmful Event. However, it must be kept in mind that even if a vehicle's first harmful event did not involve an impact, the vehicle may subsequently have impacted a vehicle, object, pedestrian, or nonmotorist. Just because A10 (First Harmful Event) equals

VEHICLE FORM

V26

V35

V44

V53

(3)

Variable Name: 1st C.D.C./T.D.C. - Object Contacted (cont'd.)
 2nd C.D.C./T.D.C. - Object Contacted (cont'd.)
 3rd C.D.C./T.D.C. - Object Contacted (cont'd.)
 4th C.D.C./T.D.C. - Object Contacted (cont'd.)

"02" through "07" does not mean that the vehicle involved was not subsequently involved in an impact for which the object contacted is coded here. For example, when A10 = 05 (Fell from vehicle), there is a good chance, particularly if the person was the driver, that the vehicle was subsequently involved in an impact. Further, in some instances of A10 = 07 [Other non-collision (e.g., jackknife)] code "00" (Noncollision) ought not be used. In the jackknife situation, this occurs when the power unit of the articulated vehicle impacts the trailer unit in which case you should code the vehicle's own number.

Code "00" (Noncollision) may also be used for a vehicle which sets an object in motion that strikes or is struck by a vehicle. Examples include dislodged cargo, spewed gravel, etc. It may also be used in other situations subject to consultation with the Zone Centers.

Code "31" (Motor vehicle not in transport) refers to a motor vehicle which is not on the roadway and not in motion (e.g., vehicle located in parking lane).

For codes "32" and "33" (Tree), measure the diameter of the tree on the horizontal plane at the point of impact.

For pole (codes "34" through "42") the word "pole" used in a general sense, includes all types of supports for utility lines, light standards, traffic control signals, and signs. A pole may be made of wood, metal, or concrete and may have various cross-sectional shapes and dimensions. The pole must be nontemporary (i.e., have a permanent base). The pole must be at least five feet in height with the minimum cross-sectional dimension greater than two inches. U-shaped () support (other than C-Channels) or supports are not poles.

Codes "34" and "35" (Luminaire) refer to a pole whose primary purpose is to support one or more light standards. A secondary purpose may be to support a traffic signal or sign. Private luminaires are not eligible.

Codes "36" through "39" (Sign pole) refer to a pole whose sole purpose is to support one or more highway traffic sign(s) that provides warning, guidance, or regulatory information. Private signs are not eligible.

VEHICLE FORM

V26
V35
V44
V53
(4)

Variable Name: 1st C.D.C./T.D.C. - Object Contacted (cont'd.)
2nd C.D.C./T.D.C. - Object Contacted (cont'd.)
3rd C.D.C./T.D.C. - Object Contacted (cont'd.)
4th C.D.C./T.D.C. - Object Contacted (cont'd.)

Codes "34", "36", and "38" (... breakaway) refer to a breakaway device that is designed to readily disengage, fracture, or bend away from an impacting vehicle above a predetermined force level. A pole fitted with such a breakaway device is a breakaway pole; otherwise, it is a nonbreakaway pole. Common types include: slip base (steel); fragile base (cast aluminum); and progressive shear (galvanized steel or stainless steel).

Codes "35", "37", and "39" (... nonbreakaway) refer to supports which are not designed to "break away" and reduce the deceleration force experienced by the vehicle.

For codes "36" and "37" (Large sign) the support pole's largest cross-sectional dimension is greater than or equal to 4 inches.

For codes "38" and "39" (Small sign) the support pole's largest cross-sectional dimension must be greater than or equal to 2 inches and less than 4 inches.

Code "40" (Utility pole) refers to a pole whose primary purpose is to support utility lines. A secondary purpose may be to support a light standard, traffic signal, or sign.

Code "41" (Other post, pole, or support) includes U-shaped () supports (e.g., STOP or YIELD signs), other small poles that are less than 2 inches in cross-sectional dimension, all private (nonhighway, nontraffic) signs and supports, and any other post, pole, or support not coded in codes "34" through "40" and "42" through "45". [NOTE: This code does not relate directly with A10, First Harmful Event, equaling "31" (Other post, pole, or support) since STOP or YIELD signs would be coded "27" (Highway/Traffic sign post) for A10.]

Code "42" (Traffic signal pole) refers to a pole whose primary purpose is to support a traffic signal. A secondary purpose may be to support a sign.

If you are unable to identify the type of pole (or barrier, although the barrier types are not detailed here) impacted, help is available from the following contacts listed in the table below. Contact with these individuals should be infrequent and should only be made when the team is unable to make a determination.

VEHICLE FORM

'726
'735
'744
'753
(5)

Variable Name: 1st C.D.C./T.D.C. - Object Contacted (cont'd.)
 2nd C.D.C./T.D.C. - Object Contacted (cont'd.)
 3rd C.D.C./T.D.C. - Object Contacted (cont'd.)
 4th C.D.C./T.D.C. - Object Contacted (cont'd.)

----PHWA----				
PSU	Region	Site	Contact Name	Phone
01	5	2	No contact	
02	5	10	Robert Doqyns	(616) 788-2381
03	7	11	(Team leader has own contacts)	
04	5	16	Jim Lindemuth or Dan Vanltine	(517) 754-7443
05	5	20	Wayne Smith	(616) 849-2811
06	5	23	Dan Shamo	(219) 362-6125
07	5	27	No contact	
08	5		Major Anthony Yucevicius	(312) 865-4770
09	5		John Kinville/Don Polaski	(313) 224-7626
10	5		Maynard Stoehr	(608) 266-0421
11	5		F. W. DesAutels	(313) 761-1500
12	5		Maynard Stoehr	(608) 266-0421
13	5		Steve Hardesty	(317) 362-9484
14	7		Maurice F. Burr	(515) 472-4171
26	1	5	James Pierson	(914) 331-5533
27	3	1	Bob Johnson	(814) 437-5711, Ext. 374
28	3	4	John Laughher	(215) 687-1600, Ext. 369
29	1	14	No contact	
30	3	17	Angelo Boezi	(717) 962-4062
31	3	21	John Laughher	(215) 687-1600, Ext. 369
32	3	22	Andy Rost	(412) 565-2555
33	1	24	Ed Dannehy	(518) 393-0863
34	1		Ray Carter	(212) 938-3380
35	1		John Gallagher	(617) 727-4710
36	1		Norman Winkler (North)	(716) 683-3476
			George Tolsma (South)	(716) 649-2349
37	3		John Laughner	(215) 687-1600
38	3		Ed Meehan/Dave Curtin	(301) 345-7100
39	1		Thomas Jackvony	(401) 277-2378

VEHICLE FORM

V26
V35
V44
V53
(6)

Variable Name: 1st C.D.C./T.D.C. - Object Contacted (cont'd.)
 2nd C.D.C./T.D.C. - Object Contacted (cont'd.)
 3rd C.D.C./T.D.C. - Object Contacted (cont'd.)
 4th C.D.C./T.D.C. - Object Contacted (cont'd.)

----FHWA----				
PSU	Region	Site	Contact Name	Phone
51	4	6	Ron Register	(305) 776-4300
52	4	7	James Braden - Shelby County	() 668-0173
			Billy Franklin - St. Clair Cty.	() 274-2112
53	6	9	Jim Allbritton	(501) 534-1612
54	4	19	Gene Ednonds	(704) 258-6178
55	4	26	Carl Guin	() 759-4281
56	4		Frank Deluca	(305) 377-5290
57	4		Terry Grubb	(615) 546-3660
58	4		M.C. (Bob) Adams	(919) 733-2330
59	4		A.S. (Bud) Smith	(601) 683-3341
60	6		Corporal Russel Roque	(318) 352-8101
61	6	3	Bob Lay	(512) 465-6366
62	6	29	Bob Lay	(512) 465-6366
63	6		Milton Watkins, Jr.	(214) 321-6421
76	10	8	No contact	
78	7	12		
79	9	13	Jim Collins	(415) 557-0154
80	8	15	Bill Tucker	(303) 757-9271
81	9	18	John Churchman	(602) 782-1646
82	6	25	Parker Bell	(505) 983-0630
83	8	30	Clint Gregory	(605) 773-3462
85	10	28	No contact	
87	9		Don Cornelison	(602) 261-7386

Code "43" (Fence) includes both the fence material and the support posts.

Code "44" (Mail box) includes mail box and any supporting posts associated with it.

Code "46" (Other movable objects) includes other stationary objects that are readily movable--compare with code "69" (other stationary/fixed object). Examples include trash cans, grocery carts, unoccupied pedalcycles, small boulders, etc.

VEHICLE FORM

V26
V35
V44
V53
(7)

Variable Name: 1st C.D.C./T.D.C. - Object Contacted (cont'd.)
2nd C.D.C./T.D.C. - Object Contacted (cont'd.)
3rd C.D.C./T.D.C. - Object Contacted (cont'd.)
4th C.D.C./T.D.C. - Object Contacted (cont'd.)

Code "47" (Culvert) is a man-made structure that allows passage over a drainage area and is that part of the structure which is intended to channel flow through the structure and maintain the stability/integrity of the road bed. If the structure has a portion above the road surface which is of sufficient height to engage above the wheels of an errant passenger vehicle and redirect it, that part of the structure is considered a bridge rail code "57". A ditch code "71" ends where a culvert begins and resumes on the opposite side of the culvert.

Code "50" (Abutment), is a structural member that supports an overhead structure that is used for other than vehicular or pedestrian traffic (e.g., support for a tunnel, overhead pipeline, etc.). Abutments related to bridges should be coded "56" (Bridge pier or abutment).

Code "56" (Bridge pier or abutment) is a structural member of a bridge that supports an overpass structure used for vehicular or pedestrian traffic. This code is directly related to A10, First Harmful Event, code "21" (Bridge pier or abutment). See A10, Code "21" figure 8 for descriptive drawing.

Code "57" (Bridge rail) is a longitudinal barrier located on a bridge and is used when the contact was with any portion of the rail except for the parapet end. This code is directly related to A10, First Harmful Event code "23" (Bridge rail).

Code "58" (Bridge parapet end) is the end structure of a bridge rail (including concrete supports for the bridge rail ends). This code is directly related to A10, First Harmful Event, code "22" (Bridge parapet end).

Code "59" (Guardrail - bridge rail transition) is used when any contact was made with a guardrail within 25 feet from the leading end (upstream end) of the bridge rail or parapet wall. The upstream end should be for the vehicle's direction of travel, not necessarily the normal traffic flow. This transition guardrail may be located on the roadside, in a gore or median. This code takes precedence over codes 62 and 63 below. See example 1.

VEHICLE FORM

V26
V35
V44
V53
(8)

Variable Name: 1st C.D.C./T.D.C. - Object Contacted (cont'd.)
2nd C.D.C./T.D.C. - Object Contacted (cont'd.)
3rd C.D.C./T.D.C. - Object Contacted (cont'd.)
4th C.D.C./T.D.C. - Object Contacted (cont'd.)

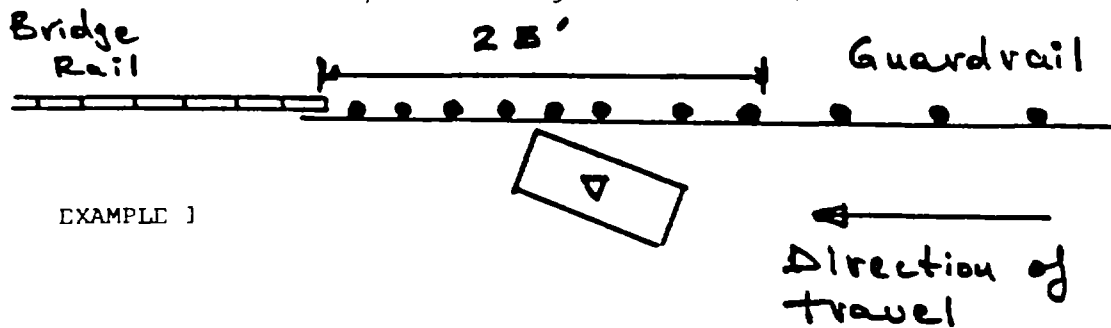

EXAMPLE 1

Code "60" [Guardrail end (non-median)] is used when any vehicle contact is made with a guardrail within 25 feet of its leading end (upstream end). The upstream end should be considered for the direction of vehicle travel, not necessarily the normal traffic flow. The guardrail end may be located on the roadside or in a gore. The flare length is not a consideration for coding this variable. The guardrail must meet the definition of code "62" below. This code takes precedence over code "62" below. See example 3.

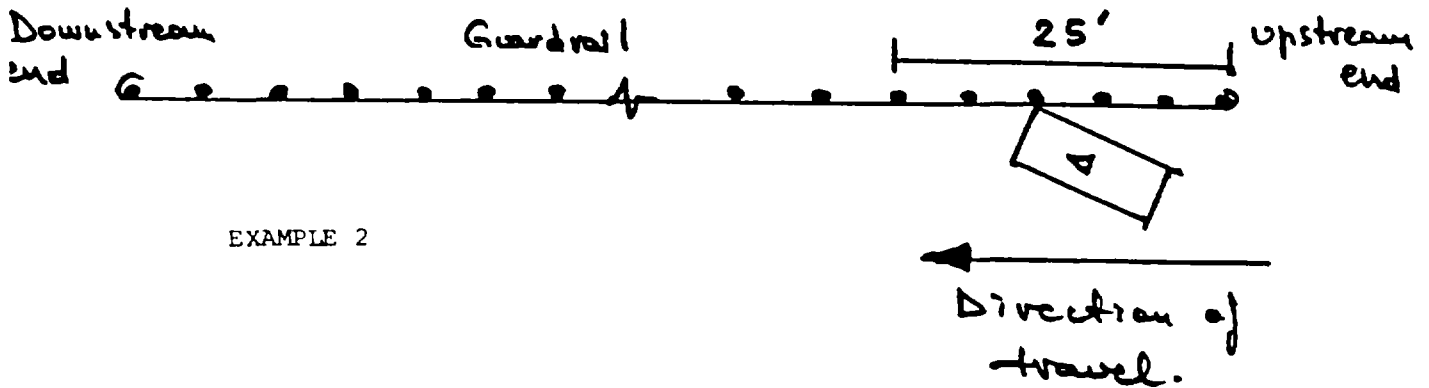

EXAMPLE 2

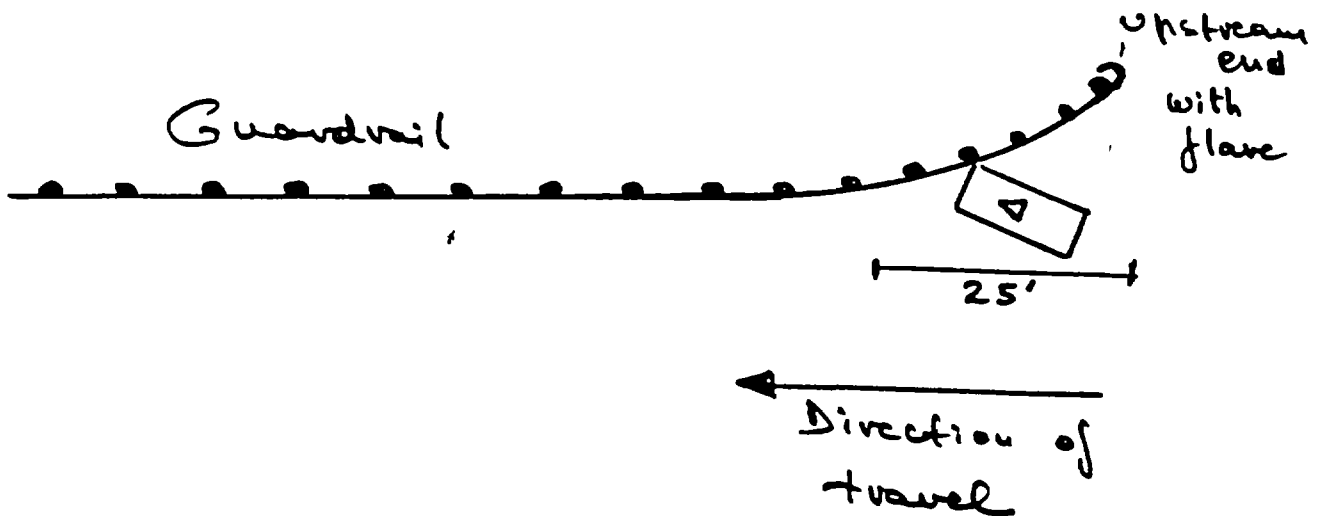

VEHICLE FORM

V:6
V:15
V:44
V:53
(9)

Variable Name: 1st C.D.C./T.D.C. - Object Contacted (cont'd.)
2nd C.D.C./T.D.C. - Object Contacted (cont'd.)
3rd C.D.C./T.D.C. - Object Contacted (cont'd.)
4th C.D.C./T.D.C. - Object Contacted (cont'd.)

Code "61" [Guardrail end (median)] is used when any vehicle contact is made with a median barrier within 25 feet from its leading end (upstream end). The upstream end should be considered the direction of vehicle travel not necessarily the normal traffic flow. The guardrail must meet the definition of code "63" below. This code takes precedence over code "63" below. See example 3.

EXAMPLE 3

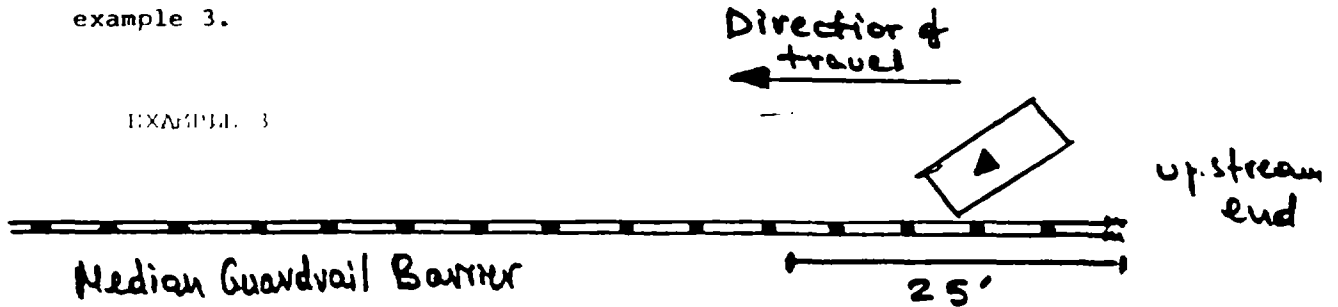

Code "62" [Guardrail (non-median)] is a longitudinal barrier, designed as a guardrail, located on the outside of the road surface. Guardrails which are located in gore areas (ANSI D16.1-1976, section 2.5.20, page 15) are considered guardrails (non-median) (code "62"), although they are used to redirect traffic at ramp areas. If the trafficway is undivided, it makes no difference on which side of the road the struck guardrail was located. See page V26 et al. (10), types 01-09, for examples of guardrails.

Code "63" [Guardrail (median)] is a longitudinal barrier, designed as a guardrail [e.g., types 01-09 on V26 et al. (10)] located in a median.

Code "64" [Concrete barrier (non-median)] is a concrete safety shape barrier [e.g., types 10 or 17 on V26 et al. (10 or 11)] located on the outside of the road surface. Concrete barriers located in gore areas are considered concrete barriers (non-median) (code "64"), although they are used to redirect traffic at ramp areas. If the trafficway is undivided, it makes no difference on which side of the road the struck barrier was located.

Code "65" [Concrete barrier (median)] is a concrete safety shape barrier [e.g., types 10 and 17 on V26 et al. (10 and 11)] located in a median.

Code "66" (Other median barrier) is a barrier designed as a median barrier [e.g., types 12-16, 18-21 on V26 et al (11)] located in the median.

VEHICLE FORM

V26
V35
V44
V53
(10)

	<p>TYPE 01</p>	<p>TYPE 01</p>	<p>TYPE 02</p>	<p>TYPE 03</p>
SYSTEM	G1 Cable Support	G2 6" x 8" Head Post, Cable Support (Head Post)	G2 6" Beam (Steel Head Post)	G3 6" Beam
MAINT. DESCRIPTION POST SPACING POST TYPE BEAM TYPE CABLE BRACKETS CABLE BEARS POST HEADS	12' 0" E261 7 steel Three 3/4" diameter steel cables ----- 5/16" diameter steel head bolts 1/4" x 2 1/2" steel plate welded to post	12' 0" 3/4" dia. of' galvanized steel posts Three 3/4" diameter steel cables, steel head bolts, steel 5/16" diameter steel bolts, steel 1/4" x 2 1/2" precast concrete bearing block	12' 0" nominal E261 7 steel Steel "C" section, 12 GA ----- 5/16" diameter steel bolts 1/4" x 2 1/2" steel plate welded to post	6' 0" E261 7 steel 6" x 6" x 10' steel tube 15" x 2 1/2" x 1/4" steel angle 6' long ----- 3/8" dia. steel bolts/bars to top of 1/4" x 2 1/2" steel plate welded to post
	<p>TYPE 04</p>	<p>TYPE 05</p>	<p>TYPE 06</p>	<p>TYPE 07</p>
	G4 6" Beam (Steel Head Post)	G4 6" Beam (Steel Head Post)	G4 6" Beam (Steel Head Post)	G4 6" Beam (Steel Head Post)
	12' 0" E261 7 steel Three 3/4" diameter steel cables ----- 5/16" diameter steel head bolts 1/4" x 2 1/2" steel plate welded to post	12' 0" E261 7 steel Three 3/4" diameter steel cables ----- 5/16" diameter steel head bolts 1/4" x 2 1/2" steel plate welded to post	12' 0" E261 7 steel Three 3/4" diameter steel cables ----- 5/16" diameter steel head bolts 1/4" x 2 1/2" steel plate welded to post	12' 0" E261 7 steel Three 3/4" diameter steel cables ----- 5/16" diameter steel head bolts 1/4" x 2 1/2" steel plate welded to post
	<p>TYPE 08</p>	<p>TYPE 09</p>	<p>TYPE 10</p>	
	G5 6" Beam (Steel Head Post)	G5 6" Beam (Steel Head Post)	G5 6" Beam (Steel Head Post)	
	12' 0" E261 7 steel Three 3/4" diameter steel cables ----- 5/16" diameter steel head bolts 1/4" x 2 1/2" steel plate welded to post	12' 0" E261 7 steel Three 3/4" diameter steel cables ----- 5/16" diameter steel head bolts 1/4" x 2 1/2" steel plate welded to post	12' 0" E261 7 steel Three 3/4" diameter steel cables ----- 5/16" diameter steel head bolts 1/4" x 2 1/2" steel plate welded to post	

VEHICLE FORM

1726
1735
1744
1753
(11)

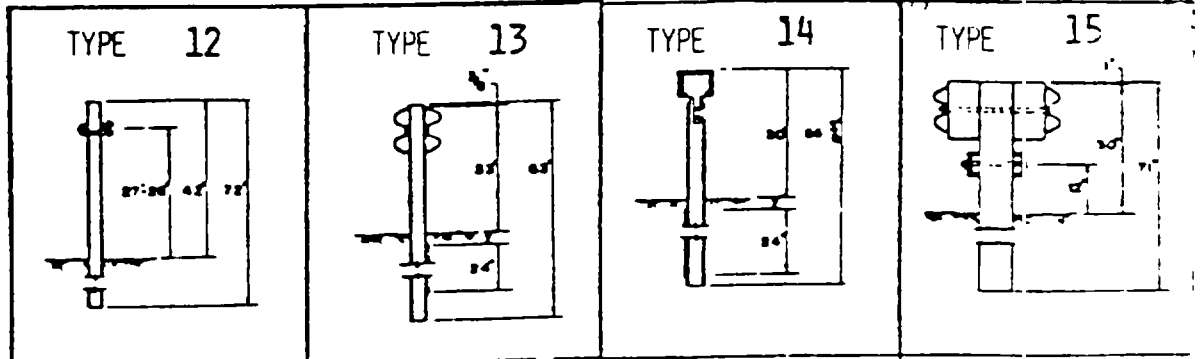

SYSTEM	#81 Cable	#82 1/2" Section (Steel Seat Post)	#83 Seat Tube	#84 Electric-Start 1/2" Seat Tube Post
MARKING DESCRIPTION POST BRACING POST TYPE BEAM TYPE OFFSET BRACKETS MOUNTING POST #82	8" 0" 12-1/2" 1" Two 3/4" diameter steel cables 1" diameter steel 1/2" bolt None	17" 8" 33x5 7" Two steel 1/2" sections None 5/16" bolts 8"x4"x1/4" steel plate welded to post	6" 0" 33x5 7" 8" od 1/2" steel tube None Steel padding 8"x4"x1/4" steel plate welded to post	6" 0" 17" 8" 1/2" Douglas Fir 1/2" 1/2" section - two 1/2" 1/2" 1/2" 1/2" 1/2" 1/2" Douglas fir slats 1/2" diameter bolts None

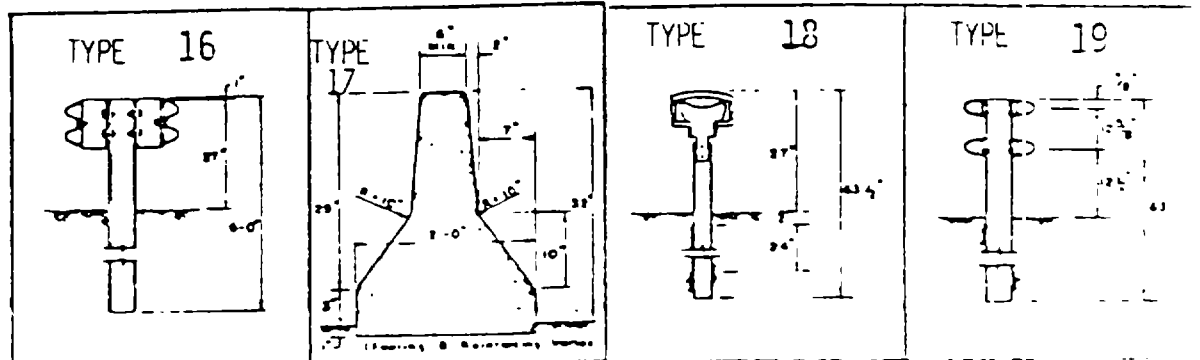

SYSTEM	#85 Electric-Start 1/2" Seat Tube Post	#86 Cable & Spring Barrier	#87 Seat Tube	#88 Seat Tube
MARKING DESCRIPTION POST BRACING POST TYPE BEAM TYPE OFFSET BRACKETS MOUNTING POST #82	17" 8" 33x5 7" 1/2" Douglas Fir 1/2" 1/2" section - two 1/2" 1/2" 1/2" 1/2" 1/2" 1/2" Douglas fir slats 1/2" diameter bolts None	17" 8" 33x5 7" 1/2" Douglas Fir 1/2" 1/2" section - two 1/2" 1/2" 1/2" 1/2" 1/2" 1/2" Douglas fir slats 1/2" diameter bolts None	6" 0" 33x5 7" 8" od 1/2" steel tube None Steel padding 8"x4"x1/4" steel plate welded to post	6" 0" 33x5 7" 8" od 1/2" steel tube None Steel padding 8"x4"x1/4" steel plate welded to post

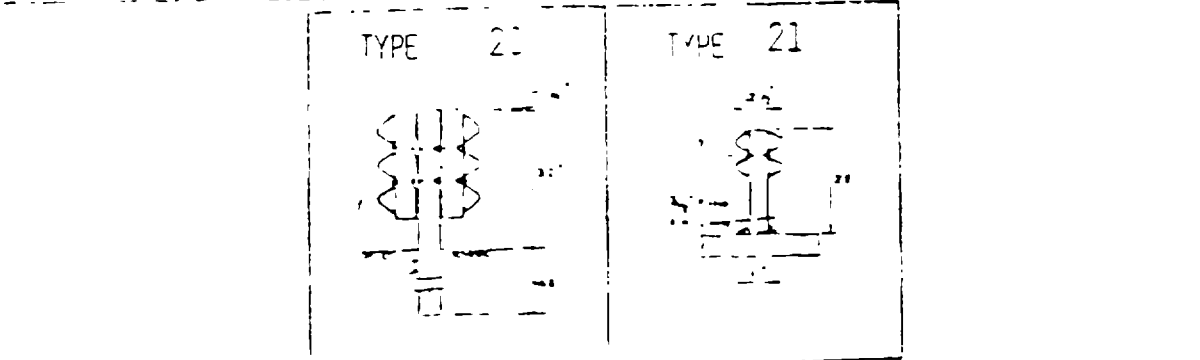

SYSTEM	#89 Electric-Start 1/2" Seat Tube Post	#90 Cable & Spring Barrier	#91 Seat Tube	#92 Seat Tube
MARKING DESCRIPTION POST BRACING POST TYPE BEAM TYPE OFFSET BRACKETS MOUNTING POST #82	17" 8" 33x5 7" 1/2" Douglas Fir 1/2" 1/2" section - two 1/2" 1/2" 1/2" 1/2" 1/2" 1/2" Douglas fir slats 1/2" diameter bolts None	17" 8" 33x5 7" 1/2" Douglas Fir 1/2" 1/2" section - two 1/2" 1/2" 1/2" 1/2" 1/2" 1/2" Douglas fir slats 1/2" diameter bolts None	6" 0" 33x5 7" 8" od 1/2" steel tube None Steel padding 8"x4"x1/4" steel plate welded to post	6" 0" 33x5 7" 8" od 1/2" steel tube None Steel padding 8"x4"x1/4" steel plate welded to post

VEHICLE FORM

V26
V35
V44
V53
(12)

Variable Name: 1st C.D.C./T.D.C. - Object Contacted (cont'd.)
2nd C.D.C./T.D.C. - Object Contacted (cont'd.)
3rd C.D.C./T.D.C. - Object Contacted (cont'd.)
4th C.D.C./T.D.C. - Object Contacted (cont'd.)

Code "67" [Other longitudinal barrier (non-median)] is any barrier that does not meet the requirements for codes "62" or "64" and is located on the outside of the road surface or in a gore area.

Code "68" (Impact Attenuator/Crash Cushion) refers to crash cushions which are barriers placed in front of fixed objects on the highway to absorb energy, and to thus mitigate the injury effects of collisions at such sites. A number of the common devices are described and illustrated following A10 (First Harmful Event) in this manual. Other impact attenuating devices may be encountered; therefore, the investigator should be sure to photograph them for verification when uncertain.

Code "69" (Ground) refers to an impact with the ground. Collisions which may be classified using this code include (but are not limited to) vehicles which overturn/rollover as well as those which sustain undercarriage damage by (1) straddling the pavement and shoulder and impacting a prominent pavement lip, or (2) free falls or vaults from the road surface to the ground. This includes uncontrolled motorcycles which contact the ground first. For motorcycle impacts, ground will be coded as an impact unless evidence indicates that the motorcycle did not strike the ground.

Code "71" (Ditch) is a man made structure for drainage purposes. When the sides of the ditch are approximately of equal height it makes no difference which side of the ditch was struck; however, if the struck side is substantially higher than the other side, code the impact with the struck side as an embankment (codes "52" and "53"). Substantial means that an embankment existed had the ditch not been present.

Code "72" (Other stationary/fixed object) is any other object of sufficient mass, or anchored, such that it is not readily movable--compare with code "46" (other movable objects). Examples include large boulders, large logs (fallen trees), etc.

Code "73" (Animal) should be coded if the object contacted was an animal (stationary or nonstationary). Where a nonmotorist was associated with the animal [i.e., on the animal, or on or in an animal powered nonmotor vehicle transport device (see P08, Pedestrian and Nonmotorist Type, code "4")] use the following scheme. If the contact is to (1) the animal, the animal and the person, the animal and the conveyance, or the animal, conveyance, and

VEHICLE FORM

V26
V35
V44
V53
(13)

Variable Name: 1st C.D.C./T.D.C. - Object Contacted (cont'd.)
2nd C.D.C./T.D.C. - Object Contacted (cont'd.)
3rd C.D.C./T.D.C. - Object Contacted (cont'd.)
4th C.D.C./T.D.C. - Object Contacted (cont'd.)

the person, code "73" (Animal); (2) the conveyance or to both the conveyance and the person, code "76" (Other nonstationary objects); or (3) to the person, code the person's Pedestrian or Nonmotorist's Number plus 80 (codes "81" through "95").

Code "76" (Other nonstationary objects) refers to any other object that is moving (exceptions include a stationary pedalcycle associated with a pedalcyclist or a stationary nonmotorist conveyance associated with a nonmotorist).

A nonmotorist conveyance is defined as any human-powered device by which a nonmotorist may move, or by which a pedestrian or nonmotorist may move another nonmotorist, other than by pedaling. A nonmotorist conveyance includes the following: baby carriage, coaster wagon, ice skates, roller skates, push cart, scooter, skate board, skis, sled, wheel chair, rickshaw, etc. Excluded are pedalcyclists. Pedalcyclist refers to any occupant of a pedalcycle (see D16.1-1976, section 2.2.16, page 6). For a pedalcyclist or nonmotorist associated with a nonmotorist conveyance, code "76" (Other nonstationary objects) if the impact was with the pedalcycle, the conveyance, the pedalcycle and pedalcyclist, or the conveyance and nonmotorist associated with the conveyance; code "81" through "95" if the impact was with the person(s).

Codes "81" through "95" are used to identify contacted pedestrian or nonmotorists where the code is derived by adding eighty (80) to that person's unique number and coding the resultant sum (e.g., 5 + 80 = 85). Pedestrian refers to any person who is on a trafficway or on a sidewalk or path contiguous with a trafficway, and who is not in or on a nonmotorist conveyance.

Code "96" (Vehicle occupant) is used when the object contacted was any person who was an occupant of a motor vehicle. Two examples of this code are as follows. Code "96" (Vehicle occupant) for any occupant who falls from a vehicle (A10, First Harmful Event, equal 05) and is subsequently run over before stabilization occurred. In addition, use this code for any motorcyclist who separates from his/her motorcycle during impact and subsequently impacts a motor vehicle before stabilization occurred.

VEHICLE FORM

V27
V36
V45
V54

Variable Name: 1st C.D.C./T.D.C. - Direction of Force
2nd C.D.C./T.D.C. - Direction of Force
3rd C.D.C./T.D.C. - Direction of Force
4th C.D.C./T.D.C. - Direction of Force

Format: 2 columns - numeric

Beginning
Column 39
51
63
75

Element Values:

Range: Blank, 00-13, 20-32, 40-52, 60-72, 80-92, 99

C.D.C. or T.D.C.

Blank - No C.D.C./T.D.C.

00 Non-horizontal force	08 8 o'clock
01 1 o'clock	09 9 o'clock
02 2 o'clock	10 10 o'clock
03 3 o'clock	11 11 o'clock
04 4 o'clock	12 12 o'clock
05 5 o'clock	13 Intra-unit force (T.D.C. only)
06 6 o'clock	99 Unknown
07 7 o'clock	

Incremental Values for Above Force Directions (C.D.C. only)

00 No shift
20 End shift vertical--up; top shift forward
40 End shift vertical--down; top shift rearward
60 End or top shift lateral--right
80 End or top shift lateral--left.

Source: Restricted to vehicle inspection or photographs.

Remarks:

Code the principal direction of force incremented to indicate vertical or lateral shifting of vehicle basic end structures which occur during horizontal force application or longitudinal or lateral shifting to the top

VEHICLE FORM

V27
 V36
 V45
 V54
 (2)

Variable Name: 1st C.D.C./T.D.C. - Direction of Force (cont'd.)
 2nd C.D.C./T.D.C. - Direction of Force (cont'd.)
 3rd C.D.C./T.D.C. - Direction of Force (cont'd.)
 4th C.D.C./T.D.C. - Direction of Force (cont'd.)

structure as a result of non-horizontal force application to the top. In other words, the combined value (Direction of Force + Incremental Value for CDC only) is coded under this variable.

Code variables 26, 35, 44 and 53 (1st, 2nd, 3rd, and 4th C.D.C./T.D.C. - Object Contacted) with the appropriate code(s) when the object contacted is known regardless of how the C.D.C./T.D.C.s, variables 27-32, 36-41, 45-50, and 54-59 are coded.

The CDC/TDC generated for a particular impact is based upon damage which is the result of direct impact only; it does not include induced damage. All CDC/TDCs are based entirely upon the procedures in SAE J224 MAR80, or SAE J1301.

Any time a vehicle becomes inverted and impacts any object or vehicle while inverted, the clock direction is coded as "00" (plus any incremental value for a top structure impact). Also use "00" (Non-horizontal force) with any other circumstance which is consistent with the directions contained in SAE, J224 MAR80, or SAE J1301.

If there is only one CDC, it should be entered in variables 27-32, whether or not CRASH was exercised. Variables 34-42 should then be left "Blank".

If it is unknown whether the vehicle sustained a second impact, code variables 34-42 unknown ("99" or "9").

$\frac{9}{48}$ $\frac{9}{49}$ $\frac{9}{50}$ $\frac{9}{51}$ $\frac{9}{52}$ $\frac{9}{53}$ $\frac{9}{54}$ $\frac{9}{55}$ $\frac{9}{56}$ $\frac{9}{57}$ $\frac{9}{58}$ $\frac{9}{59}$

Rank order any CDCs on the basis of the CRASH program results, if used.

If there are two or more CDCs, and if CRASH is exercised on none or on a portion of the CDCs, subjectively order the most severe impacts (in terms of assumed change in velocity, delta "V").

If CRASH can be exercised on only one CDC, where two or more exist, the CDC used in CRASH should be coded in variables 27-32 if it is felt to represent the highest change in velocity (delta "V"); it should be coded in variables

VEHICLE FORM

V27
V36
V45
V54
(3)

Variable Name: 1st C.D.C./T.D.C. - Direction of Force (cont'd.)
2nd C.D.C./T.D.C. - Direction of Force (cont'd.)
3rd C.D.C./T.D.C. - Direction of Force (cont'd.)
4th C.D.C./T.D.C. - Direction of Force (cont'd.)

36-41 if it is felt to represent the second highest delta "v", etc. It should not be coded if it is felt to represent the fifth highest or lesser delta "v".

If no CDC/TDC has been recorded for a vehicle which has sustained but one impact, row variables 27-32 are coded as unknown ("99" or "9") and the remaining rows are left "Blank". If no CDC/TDCs are recorded for a vehicle which has sustained more than one impact, fill in the required number of CDC/TDC rows to cover each impact with unknowns ("99" or "9") and leave the remaining ones blank. If an unknown number of impacts occurred, fill in the entire block of CDC/TDC rows with the appropriate CDC/TDCs (or unknowns, if applicable). If a vehicle has sustained multiple impacts and, for example, the only CDC/TDC which can be generated (due to contamination from repair process which was underway at time of inspection, etc.) is for the second most severe impact, row variables 27-32 are coded as unknown ("99" or "9") and the generated CDC/TDC is coded in row variables 36-41.

No CDC/TDCs may be entered in the row variables unless those CDC/TDCs are known in their entirety [i.e., do not use "9" (Unknown) for any missing character when that character is unknown]. Conversely, any time a "9" is coded in any column for the CDC/TDC row variables, all other CDC/TDC columns in that row must be coded "9" (Unknown); however, variables 32, 41, 50 and 59 may be coded "09".

Verbal Descriptions by drivers, occupants, or owners may not form the basis for a CDC/TDC except in pedestrian accidents or very minor accidents (no residual damage) where the vehicle has been inspected. In cases involving no residual damage and where the vehicle is involved with another vehicle or object, that other vehicle or object should be inspected.

In some instances where the vehicle is undergoing repair (parts removed) or has been repaired (parts available) a CDC/TDC may be determined from those parts and a description of the damage from testimony of a repairman judged to be reliable. (NOTE: Do not formulate "C" measurements for these vehicles unless there is only minor alteration which does not detract from the investigator's confidence in those measurements.)

VEHICLE FORM

V27
V36
V45
V54
(4)

Variable Name: 1st C.D.C./T.D.C. - Direction of Force (cont'd.)
2nd C.D.C./T.D.C. - Direction of Force (cont'd.)
3rd C.D.C./T.D.C. - Direction of Force (cont'd.)
4th C.D.C./T.D.C. - Direction of Force (cont'd.)

Leave the CDC/TDC row variables "Blank" for vehicles which are beyond the scope of the CDC/TDC protocols (e.g., motorcycles, busses, snowmobiles, farm equipment other than trucks, dune buggies, construction equipment other than trucks, etc.). Reference should be made to the damage classification protocols to determine if any vehicle not mentioned above is within the scope of those protocols. Recall that the object any of these vehicles contact is still coded in either V26, V35, V44 and V53 [1st (2nd) (3rd) (4th) C.D.C./T.D.C. - Object Contacted] even though the CDC/TDC row variables are left "Blank" because they are not in scope for classification.

For Intraunit force type damages (i.e., Jackknife), where multiple CDC/TDCs may be coded, if a vehicle inspection is not obtained, multiple CDC/TDCs (1**99999999 1) need to be coded.

** Code actual object contacted if known (i.e., in a jackknife the objects contacted would be that vehicle's number).

VEHICLE FORM

V28
V37
V46
V55

Variable Name: 1st C.D.C./T.D.C. - Deformation Location
2nd C.D.C./T.D.C. - Deformation Location
3rd C.D.C./T.D.C. - Deformation Location
4th C.D.C./T.D.C. - Deformation Location

Format: 1 column - alphanumeric

Beginning
Column 41
53
65
77

Element Value:

C.D.C.

Blank - no C.D.C./T.D.C.
F Front
R Right side
L Left side
B Back (rear)
T Top
U Undercarriage
9 Unknown

T.D.C.

Blank - no C.D.C./T.D.C.
F Front
R Right side
L Left side
B Back of unit with cargo area
rear of trailer or straight
truck)
D Back (rear of tractor)
C Rear of cab
V Front of cargo area
T Top
U Undercarriage
9 Unknown

Source: Restricted to vehicle inspection or photographs.

Remarks:

See remarks section for variables V27 and V36, etc.

VEHICLE FORM

V29
V38
V47
V56

Variable Name: 1st C.D.C./T.D.C. - Specific Longitudinal or Lateral Location
 2nd C.D.C./T.D.C. - Specific Longitudinal or Lateral Location
 3rd C.D.C./T.D.C. - Specific Longitudinal or Lateral Location
 4th C.D.C./T.D.C. - Specific Longitudinal or Lateral Location

Format: 1 column - alphanumeric

Beginning
 Column 42
 54
 66
 78

Element Value:

<u>C.D.C.</u>	<u>T.D.C.</u>
Blank - no C.D.C./T.D.C.	Blank - no C.D.C./T.D.C.
D Distributed--side or end	D Distributed--side or end
L Left--front or rear	L Left--front or rear
C Center--front or rear	C Center--front or rear
R Right--front or rear	P Right--front or rear
F Side front--left or right	F Side front (forward of windshield)
P Side center section--L or R	P Side cab
B Side rear--left or right	W Side rear of cab to rear of tractor
Y Side (F + P) or end (L + C)	K Side (P + W)
Z Side (P + B) or end (C + R)	S Side (F + P + W)
9 Unknown	B Side rear of cab to rear of trailer or cargo area
	T Side trailer (rear of tractor to rear of trailer)
	Y Side (F + P) or end (L + C)
	Z Side (B + P) or end R + C)
	9 Unknown

Source: Restricted to vehicle inspection or photographs.

Remarks:

See remarks section for variables V27 and V36, etc.

VEHICLE FORM

V30
V39
V48
V57

Variable Name: 1st C.D.C./T.D.C. - Specific Vertical or Lateral Location
2nd C.D.C./T.D.C. - Specific Vertical or Lateral Location
3rd C.D.C./T.D.C. - Specific Vertical or Lateral Location
4th C.D.C./T.D.C. - Specific Vertical or Lateral Location

Format: 1 column - alphanumeric

Beginning
Column 43
55
67
79

Element Value:

C.D.C. (Vertical - Front, Rear, or Side Impacts)

Blank - no C.D.C./T.D.C.
A All
H Top of frame to top
E Everything below belt line
G Belt line and above
M Middle--top of frame to belt line or hood
L Frame--top of frame, frame, bottom of frame (including undercarriage)
W Below undercarriage level (wheels and tires only)
9 Unknown

T.D.C. (Vertical - Front, Rear, or Side Impacts)

Blank - no C.D.C./T.D.C.
A Top of vehicle to bottom of vehicle exclusive of wheels
H Top of frame to top of vehicle
T Everything above cab
G Belt line and above
E Belt line and below
M Middle--top of frame to belt line or hood
L Low--top of frame, frame, and bottom of frame (including undercarriage)
W Below undercarriage level (wheel and tires only)
9 Unknown

Variable Name: Vehicle Number

Format: 2 columns - numeric

Beginning
Column 11

Element Values:

Level 1 Range: 01 through 30

Source: Investigator determined--inputs include police report and driver interview.

Remarks:

For each and every Vehicle Form, there must be an accompanying Driver Form.

The value coded here must be the same as that coded for the vehicle in which this driver is associated.

This variable is a mandatory variable and cannot be changed.

VEHICLE FORM

V31
V40
V49
V58

Variable Name: 1st C.D.C./T.D.C. - Type of Damage Distribution
2nd C.D.C./T.D.C. - Type of Damage Distribution
3rd C.D.C./T.D.C. - Type of Damage Distribution
4th C.D.C./T.D.C. - Type of Damage Distribution

Format: 1 column - alphanumeric

Beginning
Column 44
56
68
80

Element Values:

C.D.C. or T.D.C.

Blank - no C.D.C./T.D.C.
W Wide impact area
N Narrow impact area
S Sideswipe
O Rollover (includes side)
A Overhanging structure
E Corner
K Conversion in impact type (C.D.C. only)
U No residual deformation
R Override (T.D.C. only)
9 Unknown

Source: Restricted to vehicle inspection or photographs.

Remarks:

See remarks section for variables V27 and V36, etc.

VEHICLE FORM

V32
V41
V50
V59

Variable Name: 1st C.D.C./T.D.C. - Deformation Extent Guide
2nd C.D.C./T.D.C. - Deformation Extent Guide
3rd C.D.C./T.D.C. - Deformation Extent Guide
4th C.D.C./T.D.C. - Deformation Extent Guide

Format: 2 columns - alphanumeric

Beginning
Column 45
57
69
81

Element Values:

C.D.C. or T.D.C.

Blank - no C.D.C./T.D.C.	07	Seven
01 One	08	Eight
02 Two	09	Nine
03 Three	0A	(T.D.C. only)
04 Four	0B	(T.D.C. only)
05 Five	0C	(T.D.C. only)
06 Six	0D	(T.D.C. only)
	0X	(T.D.C. only)
	99	Unknown

Source: Restricted to vehicle inspection or photographs.

Remarks:

See remarks section for variables V27 and V36, etc.

When a body panel is torn loose from the vehicle frame due to impact, the extent zone should be coded from direct damage only; consider body panels torn loose from the frame as not representative of residual crush.

VEHICLE FORM

V33
V42
V51
V60

Variable Name: 1st C.D.C./T.D.C. - Event Number (in accident)
2nd C.D.C./T.D.C. - Event Number (in accident)
3rd C.D.C./T.D.C. - Event Number (in accident)
4th C.D.C./T.D.C. - Event Number (in accident)

Format: 2 columns - alphanumeric

Beginning
Column 47
59
71
83

Element Values:

Blank - no event
1-7 - First through seventh
8 - Eighth or additional
9 - Unknown

Remarks:

In accidents involving multiple vehicles and multiple events, the events are numbered in sequence by chronology in reference to the entire accident. This total accident sequence number is coded adjacent (V33, V42, V51 or V60) to the CDC/TDC that was produced during this event. For example, three cars are waiting at a red light. A pickup truck rear ends the third car in line and pushes it into the second car which in turn is pushed into the first car. The sequential event numbers in this accident would be as follows:

Number 1 - pickup vs. 3rd car
Number 2 - 3rd car vs. 2nd car
Number 3 - 2nd car vs. 1st car

Do not forget that the numbers are actually encoded in accordance with CDC/TDC prioritization.

Variable Name: Vehicle Identification Number

Format: 17 columns - alphanumeric

Beginning
Column 84

Element Values:

Code the entire VIN, left justify

00000000000000000000 No VIN

99999999999999999999 Unknown

Source: Primary source is vehicle inspection; secondary sources are the police report and the vehicle registration files.

Remarks:

Leave "Blank" any column which does not have a VIN character.

If part of the VIN is missing or not decipherable, leave the column any such character would ordinarily occupy "Blank".

If the entire VIN is unknown or missing, enter "9"s in the entire field.

If the vehicle is a type which has no VIN (e.g., go-cart), enter "0"s in the entire field.

If the vehicle is a motor home or school bus, the vehicle chassis VIN should be coded and the secondary manufacturer's number should be annotated.

Code the entire VIN as found during inspection of the vehicle and left justify, as shown in the following example:

VIN: A3A197H118815 _____

CODE: A3A197H118815 _____

Code the police reported VIN, if available (and indicate police). Do so only when the vehicle is not inspected, and the police reported characters are consistent with reference materials (e.g., NATB) with respect to alphanumeric characters.

If the vehicle is manufactured by the Ford Motor Company and begins with a script "F", the "F" should not be coded. Proceed to the next character as in the example:

VIN: 3U62S100932 _____

CODE: 3U62S100932 _____

NOTE: For this variable only, slash zeros "0" so that they are not confused with the alphabet character "O", as in DOT.

VEHICLE FORM

V61
(2)

Variable Name: Vehicle Identification Number (cont'd.)

In addition, if any hyphens or periods are contained in the string of alpha-numeric characters, then they should be ignored as in the example below.

VIN: SM-E 3076421
CODE: SME3076421 _____

If the state will not allow transmittal of the complete VIN, code all characters except the sequential production numbers. Code zeros ("0") in place of the sequential numbers.

The location of the VIN will vary among, and within, vehicles. Reference sources which may prove helpful in locating the VIN include, but are not limited to:

- (1) Motor Vehicle Identification Manual
National Automobile Theft Bureau
Palmer Publications Company
Downers Grove, Illinois 60515
- (2) Passenger Car and Truck-Accident
Investigators Manual
MVMA of the U.S., Inc.
300 New Center Building
Detroit, Michigan 48202
- (3) Lee S. Cole
Davis Publishing Co.
Post Office Box 841
Santa Cruz, California 95060

(Vehicle Identification 1938-1868
Vehicle Identification 1968-1981)

Variable Name: Registration of Vehicle

Format: 1 column - numeric

Beginning
Column 10'

Element Values:

- 0 Not registered
- 1 In-state (at least)
- 2 Out-of-state (only)
- 8 Other registration (e.g., federal, foreign, military)
- 9 Unknown

Source: Primary sources are the vehicle inspection, police report, and vehicle registration files.

Remarks:

Registration means that the vehicle was registered to drive on a street/highway. Some states require a registration for off-road use. A vehicle registered only for off-road use that was involved in an accident associated with a NASS roadway, is not considered registered--code "0" (Not registered).

Vehicles displaying a valid temporary registration certificate are to be considered registered. Expired registrations are not valid and are to be ignored when selecting the proper attribute. Vehicles displaying dealer's tags are not registered (code "0"). The assumption is that the association between the tag and the vehicle is short-lived.

Code "0" means that the vehicle has no currently valid registration. This would include expired registrations and exempt vehicles.

Code "1" (In-state) means that the vehicle was registered in the state in which the accident occurred. The vehicle may or may not have also been registered in other states. The vehicle, in the instance of tractor-trailer or multi-unit trucks, includes the registration found for both the tractor and its trailer(s).

Code "2" (Out-of-state) means that the vehicle was registered, but not in the state in which the accident occurred. State-owned vehicles are coded "1" if the accident occurred in the same state in which the vehicle is registered.

Variable Name: Vehicle Special Use (this trip)

Format: 1 column - numeric

Beginning
Column 102

Element Values:

- 0 No special use
- 1 Taxi
- 2 Vehicle used as school bus
- 3 Vehicle used as other bus
- 4 Military
- 5 Police
- 6 Ambulance
- 7 Fire
- 9 Unknown

Source: Investigator determined--inputs include vehicle inspection, driver interviews, police report, and other interviewees.

Remarks:

Code "0" (No Special Use).

Code "1" (Taxi) refers to vehicles used during this trip (at the time of the accident) on a "fee-for-hire" basis to transport persons. Most of these vehicles will be marked and formally registered as taxis; however, vehicles which are used as taxis, even though they are not registered (e.g., "Gypsy Cabs"), are included here. Taxis and drivers which are off-duty at the time of the accident are not included. The investigator should ask taxi drivers a special question on the Driver Form to determine if he/she was on duty at the time of the accident.

Code "2" (Vehicle used as school bus) refers to a motor vehicle (V14, Body Type, need not equal 30) which satisfies the following criteria:

- externally identifiable to other traffic units as a school/pupil transport vehicle. The vehicle may be equipped with flashing lights, may have a sway stop arm and traffic may be required to stop for the vehicle when occupants enter or exit.
- operated, leased or owned by a public or private school-type institution;

VEHICLE FORM

V63
(2)

Variable Name: Vehicle Special Use (this trip) [cont'd.]

- where the institution's students may range from pre-school through high school;
- whose occupants, if any, are associated with the institution; and,
- the vehicle is in operation at the time of the accident to and from the school or on a school-sponsored activity or trip.

Code "3" (Vehicle used as other bus) refers to a motor vehicle which is designed for transporting more than ten persons and does not satisfy the above criteria of a school bus.

For codes "4" (Military), "5" (Police), "6" (Ambulance), and "7" (Fire), special use means "in use" and not necessarily emergency use. External identification to the normal driving public is the criterion.

Code "4" (Military) refers to a vehicle which is owned by any of the Armed Forces. These vehicles are presumed to be in special military use at all times.

Code "5" (Police) refers to a readily identifiable (lights or markings) vehicle which is owned by any local, county, state or federal police agency. The vehicles are presumed to be in special police use at all times. Personal vehicles (not owned by the agency) which are used by officers or agents (e.g., undercover) are excluded.

Military police vehicles are coded "4" (Military).

Code "6" (Ambulance) refers to those readily identifiable (lights or markings) vehicles: (1) whose sole purpose is to provide ambulance service and which is always presumed to be in special ambulance use at all times, or (2) vehicles serving dual purposes such as a hearse used for both funeral and emergency purposes, which is only coded, when used for the latter purpose.

Military ambulances are coded "4" (Military).

Code "7" (Fire) refers to a readily identifiable (lights or markings) vehicle which is owned by any government (typically local) or cooperative agency. This vehicle is presumed to be in special use at all times. For volunteer fire companies, firefighting apparatus and other vehicles owned by the company or government qualify for code "7". Privately owned vehicles, even if equipped with lights, do not qualify.

Military fire vehicles are coded "4" (Military).

Variable Name: Odometer Reading

Format: 3 columns - numeric

Beginning
Column 103

Element Values:

Level 2 Range: 001 through 500

Code mileage to the nearest 1,000 miles

000 No odometer

001 Less than 1,500 miles

997 Greater than or equal to 996,500 miles

999 Unknown

Source: Primary source is the vehicle inspection; however, it may be supplemented with information from the police report and/or driver interview.

Remarks:

Code to the nearest 1,000 miles as in the examples:

Mileage: 7,498

Code: 007

Mileage: 7,502

Code: 008

Mileage: 18,342

Code: 018

Mileage: 147,687

Code: 148

Code "001" if the mileage is less than 1,500.

Code "999" (Unknown) if the odometer was disconnected or broken before the collision, or if the mileage is unknown.

This variable measures the mileage on the vehicle's odometer; however, in cases where it is suspected that the odometer is working but has turned over (i.e., recycled) the coded value represents the total mileage on the vehicle rather than the reading on the odometer.

Variable Name: Passenger Compartment Integrity

Format: 1 column - numeric

Beginning
Column 106

Element Values:

- 0 No passenger compartment
- 1 No integrity loss
- Yes, integrity was lost through:
- 2 Windshield
- 3 Door (side)
- 4 Door (rear)
- 5 Roof
- 6 Windshield & door (side)
- 7 Other combination of above
- 9 Unknown

Source: Restricted to vehicle inspection or photographs.

Remarks:

Consider the passenger compartment as a "package" which is designed to contain the occupant. If an opening occurs of sufficient magnitude through which an occupant could have been ejected totally or partially (although it is not necessary for an occupant to have been so ejected), the integrity of the compartment should be considered to have been lost. While it is difficult to define the magnitude of the opening in a universal manner, the minimum size of the opening would be equivalent to the head of most adults. Components which may lose their integrity are restricted to the windshield, door or roof (individually or in combination).

The question of integrity loss is assessed with respect to impact-related damage. The damage can be either direct or induced. Damage which is not impact-related (e.g., fire) is not considered.

Code "0" (No passenger compartment) if the vehicle has no passenger compartment (e.g., motorcycle).

Doors which open prior to an impact do not constitute loss of integrity, but those which open upon impact or from occupant or cargo loading due to the impact constitute loss of integrity.

Code "3" [Door (side)] refers to any door (including cargo doors) along the left or right side of a vehicle that is not separated from the passenger compartment by a full partition.

Variable Name: Passenger Compartment Integrity (cont'd.)

Code "4" [Door (rear)] refers to a door at the back of a vehicle (not a rear side door). For this door to qualify, there can be no full partition between this rear door and the passenger compartment. For example, rear doors or hatchbacks and stationwagons would qualify; a trunk lid would not.

Code "5" (Roof) includes convertibles, "T-tops", targa tops and removable tops that are up or in place. These tops should not be coded as having lost integrity if they are removed or in the down position prior to impact. Sun/Moon roofs are also excluded, even if shattered.

NOTE: Side or rear windows, whether fixed or movable, are excluded, even if shattered.

Variable Name: Passenger Compartment Intrusion

Format: 1 column - numeric

Beginning
Column 107

Element Values:

- 0 No passenger compartment
- 1 No intrusion
- 2 Front (i.e., steering column, dash)
- 3 Right side [i.e., door(s) with or without sill override]
- 4 Left side [i.e., door(s) with or without sill override]
- 5 Rear (i.e., trunk, rear seat intruded upon)
- 6 Bottom (i.e., floor)
- 7 Top [i.e., windshield, "A", "B", "C", or "D" pillar(s), roof]
- 8 Two or more areas
- 9 Unknown

Source: Restricted to vehicle inspection or photographs.

Remarks:

Intrusion occurs only when components within the passenger compartment are physically changed as a result of the impact such that they assume a position more within the compartment. For example, a door which buckles outward does not necessarily constitute intrusion. Intrusion cannot occur from damage which is not impact-related (e.g., fire). The damage which caused the intrusion can be either direct or induced.

Since intrusion is restricted only to interior components or surfaces, it excludes cases where the external sheet metal is indented but the interior door panel is not changed.

Code "0" (No passenger compartment) if the vehicle has no passenger compartment (e.g., motorcycles).

Code "6" (Bottom) includes toe pan.

Code "7" (Top) refers to the upper pillars (A, B, C, or D) being intruded upon, or those segments of the pillars above a horizontal plane through the bottom of the windshield.

NOTE: Code the area in terms of the most severe intrusion. Therefore, to have two or more areas (Code "8"), they must have the same amount of intrusion.

Variable Name: Magnitude of Intrusion

Format: 1 column - numeric

Beginning
Column 108

Element Values:

- 0 No intrusion
- 1 Less than five centimeters
- 2 Between five and fifteen centimeters
- 3 Greater than fifteen centimeters
- 9 Unknown

Source: Restricted to vehicle inspection or photographs.

Remarks:

Code "0" (No intrusion) if the vehicle has no passenger compartment (e.g., motorcycles), or if there is no intrusion.

Code "1" (Less than five centimeters) if less than 5 cm (2 in.).

Code "2" (Between five and fifteen centimeters) if between 5 and 15 cm (2-6 in.).

Code "3" (Greater than fifteen centimeters) if greater than 15 cm (6 in.).

Variable Name: Fire Occurrence

Format: 1 column - numeric

Beginning
Column 109

Element Values:

- 0 No fire
- Yes, fire occurred
- 1 Started in vehicle, minor
- 2 Started in vehicle, major
- 3 Started external to vehicle, minor
- 4 Started external to vehicle, major
- 5 Origin unknown
- 9 Unknown

Source: Primary source is the vehicle inspection; a secondary source is the police report and scene inspection.

Remarks:

Code "0" (No fire) includes those vehicles which are not inspected but for which it is reasonable to presume any fire to those vehicles would have been mentioned, if it occurred, on the police report. It also includes vehicles with smoke damage only, but which sustained no fire.

To code fire occurrence (codes "1" through "5"), the fire must reach the "vehicle" as defined by the variable Body Type (V14).

Code "1" (Started in vehicle, minor) refers to a fire which starts anywhere in the vehicle but consumes less than 50% of the passenger compartment.

Code "2" (Started in vehicle, major) refers to a fire which starts anywhere in the vehicle and consumes 50% or more of the passenger compartment.

Code "3" (Started external to vehicle, minor) refers to a fire which starts external to the vehicle but consumes less than 50% of the passenger compartment.

Code "4" (Started external to vehicle, major) refers to a fire which starts external to the vehicle but consumes 50% or more of the passenger compartment.

Code "5" (Origin unknown) if the origin of the fire is unknown, regardless of the extent of the fire. Scene inspection should serve as a secondary source for determining fire occurrence. Where the PAR does not address fire

Variable Name: Fire Occurrence (cont'd.)

and no vehicle inspection or interviews are obtained, burned debris and a charred surface are good indicators of fire occurrence providing for the investigator to code "5", origin unknown.

Code "9" (Unknown) if there is no vehicle inspection and no interviews of occupants, witnesses or other persons involved in the accident, including the investigating officer, and one cannot reasonably presume the occurrence of any fire would have been reported on the police report.

The occupant area of a motorcycle is equivalent to the passenger compartment of another vehicle.

Instructions for Completion of Restraint System Usage

Restraint usage recorded on page 6 of the Vehicle Form is based only on inspection of the vehicle; in other words, it is the recording of the evidence concerning restraint usage provided only by vehicle inspection.

An indication of restraint usage must be determined for every seating position in the vehicle, regardless of the number of occupants in the vehicle. This "indication of usage" should represent "recent usage" rather than "usage ever" if at all possible. Look for such things as:

- Belt/fittings damaged by occupant loading: deformed anchorages, stretched webbing, latch metal peening (loading impression on metal);
- Placement of belts: on, behind, or under seatbacks or benches; and,
- Condition of belts: dirty, dust covered, mechanically unusable, knotted, size adjustment on fixed length belts, cut for convenience or comfort (out of the way, near housings), or cut for occupant extraction by emergency personnel (usually at an easily accessible position).

Restraint "usage in this accident" is not determined on the Vehicle Form. Vehicle evidence, along with police report information, interviews, relationship of contact points to seat position given the PDOF applied to the vehicle, presence of belt-caused injuries, presence or absence of ejection, etc., are used for the final determination of restraint usage recorded on the Occupant Form.

Where recent usage is indicated, code the type of restraint. Where belts have been used but it cannot be determined whether or not the restraint was used recently (e.g., well worn belts and latches), code the type of restraint and annotate the reason for the code. If usage is not indicated, code none ("0").

When a child safety seat exists in other than a normal seating position, such as the floor behind the back seat, use the last column (Other position or unit) to code the presence and any indication of usage for that seat. If the child safety seat is in a normal position, make a diagonal line through each appropriate box and code data for the child safety seat in one half and the normal seat position in the other half. Due to the transient nature of these seats, one should key questions regarding its presence and usage at the time of the accident in the interview before making the final assessments on the Occupant Form.

Indications of Ejection

If acquired information indicated that an occupant of a vehicle has been ejected but the vehicle cannot be inspected, do not complete the section entitled "Indication of Ejection". The information on this page can only be obtained through a visual inspection of the vehicle.

INSTRUCTIONS FOR COMPLETION OF VEHICLE INTERIOR PAGE

Sketch and label (A,B,C,...etc.) all occupant contact points or evidence of contact (i.e., dents, skin transfer, etc.) on the appropriate diagram, identifying the occupant number (or seat location) and possible body part contacting at each point on the diagram. Using the table, document the "Interior Part Contacted" (i.e., dash, radio knob, AC duct, etc.), the "Supportive Physical Evidence" (i.e., dent, skin or cloth transfer, hair, scuff, etc.), and the "Confidence Level of Contact Point" (your confidence that the point is indeed an occupant contact from this accident). If you are reasonably certain that the area was contacted during this accident circle the 1; if you think it is only a possible contact, then circle the 2.

The diagram of the steering column should be used to show steering wheel deformation and contacts to the column.

The overhead view of the interior (center right part of page) should be used to indicate areas of intrusion, deformation of seat backs, rear seat area occupant contacts, in some cases the direction of occupant travel from seat position to contacted areas, and in some cases areas where the vehicle interior has bulged outward.

Variable Name: Type of Most Severe Impact This Vehicle, This Vehicle's Role

Format: 1 column - numeric

Beginning
Column 110

Element Values:

- 0 Nonimpact
- 1 Front of this vehicle
- 2 Left side of this vehicle
- 3 Right side of this vehicle
- 4 Rear of this vehicle
- 5 Other impact location
- 9 Unknown impact type

Source: Primary source is vehicle inspection; secondary sources include photographs, police report, and driver interviews.

Remarks:

This variable measures the general area of deformation of this vehicle's most severe impact; consequently, the value coded represents the same plane of the vehicle that was coded for V28, 1st C.D.C./T.D.C. - Deformation Location, where V28 is other than "9" or "Blank". This association and unknown as well as out of scope damage classifications for V28 are illustrated in the table below, recognizing that the table is interpretable in only one direction. In other words, it may only be used by beginning the logic with a value for V28, 1st C.D.C./T.D.C. - Deformation Location, to determine the value or range of values for V69, Type of Most Severe Impact This Vehicle, This Vehicle's Role.

IF		THEN
V28 equals:		V69 equals:
C.D.C.	T.D.C.	
F	F,V	1
L	L	2
P	P	3
B	R,C,D	4
T,U	T,U	5
9	9	0, 1-5, or 9
Blank	Blank	0, 1-5, or 9

It should be recognized from the above table that vehicles which are beyond the scope of the C.D.C./T.D.C. are coded under this variable as "0" (Nonimpact), "1"- "5" (i.e., one of the various impact aspects) or "9" (Unknown impact type).

VEHICLE FORM

V69

(2)

Variable Name: Type of Most Severe Impact This Vehicle, This Vehicle's Role
(cont'd.)

Code "0" (Nonimpact) is used when the vehicle sustains no impact but is part of the case due to: fire or explosion, immersion, gas inhalation, an occupant's fall from the vehicle, an injured occupant without an external impact, or other nonimpacts except most jackknife situations.

If the impact occurred at a corner, follow the corner protocol spelled out in SAE J224 MAR80 and SAE J1301 for selection of the proper plane.

"Vehicle" as used in this variable is the same as V14, Body Type, plus any trailers connected by means of a fixed linkage at the time of impact. The four planes (front, right, left, rear) are measured with respect to the entire vehicle (capsule). In contrast, any trailer disconnected prior to impact is treated as an object.

Variable Name: Role of Other Contacted Vehicle, Object, or Person (for same impact as above)

Format: 1 column - numeric

Beginning
Column 111

Element Values:

- 0 Nonimpact
- 1 Front of other vehicle
- 2 Side of other vehicle
- 3 Rear of other vehicle
- 4 Intraunit damage
- 5 Other location on other vehicle
- 6 Object (stationary and non-stationary)
- 7 Pedestrian or nonmotorist
- 8 Motorcycle or moped
- 9 Unknown impact type

Source: Primary source is the inspection of the other vehicle; secondary sources include the inspection of this vehicle, photographs, police report, and driver interviews.

Remarks:

Code "0" (Nonimpact) should be used only when V69, Type of Most Severe Impact This Vehicle, This Vehicle's Role, equals "0" (Nonimpact).

Codes "1" (Front of other vehicle), "2" (Side of other vehicle), "3" (Rear of other vehicle), and "5" (Other location on other vehicle) report the geographical location on the other vehicle for the common impact that produced the most severe impact on the vehicle under consideration. Row variables V27 through V32 may or may not be of help in this matter, since the most severe impact for this vehicle may not have produced the most severe impact for the other vehicle.

If a C.D.C./T.D.C. for the other vehicle is coded on its Vehicle Form (i.e., V27-V32, V36-V41, V45-V50 or V54-V59) which corresponds with this vehicle's most severe impact (this is true even if no C.D.C./T.D.C. for this vehicle was coded--variables V27-V32), then use the table below to select the appropriate value. Remember, this table, as its predecessor (V69), is only interpretable in one direction.

Variable Name: Role of Other Contacted Vehicle, Object, or Person (for same impact as above) [cont'd.]

IF		THEN
V28, V37, V46 or V55 equals		V70
C.D.C.	T.D.C.	equals
F	F, V	1
L, R	L, R	2
B	B, C, D	3
T, U	T, U	5
9	9	0-9
Blank	Blank	0-9

If no C.D.C./T.D.C. on the other vehicle maps to this vehicle's most severe impact (for whatever reason), then code the most appropriate response.

Code "4" (Intraunit damage) is used whenever the most severe impact for the vehicle under consideration was produced by (1) its trailer and/or towed trailing unit for TDC applicable vehicles or (2) its towed trailing unit and/or cargo for CDC applicable vehicles.

Code "6" [Object (stationary and nonstationary)] whenever the most severe impact for the vehicle under consideration was produced by an object. Object includes motor vehicles not in transport, which do not contain any nonmotorists, and trailers which disconnect.

Code "7" (Pedestrian or nonmotorist) whenever the most severe impact for the vehicle under consideration occurred with a pedestrian, pedalcyclist, occupant of an animal related nonmotor vehicle transport device, nonmotorist inside a motor vehicle not in transport, or another nonmotorist. This code is used even if the nonmotorist inside the motor vehicle not in transport was not injured.

Code "8" (Motorcycle or moped) whenever the most severe impact for the vehicle under consideration was produced by a motorcycle or moped.

Code "9" (Unknown impact type) whenever the most severe impact for the vehicle under consideration resulted from an impact [nonimpacts are coded "0" (Nonimpacts)] of unknown origin.

VEHICLE FORM

V'1

Variable Name: Rollover (Excludes Motorcycle)

Format: 1 column - numeric

Beginning
Column 1-2

Element Values:

- 0 No rollover
- 1 Rollover, less than 4 quarter turns
- 2 Rollover, 4 or more quarter turns
- 3 Rollover, details unknown

Source: Primary source is the vehicle inspection; secondary sources include photographs, police report, driver interviews, and other interviewees.

Remarks:

Rollover is defined as any vehicle rotation of 90 degrees or more, about any true longitudinal or lateral axis. Rollover can occur at any time during the collision and is coded independently of other configuration questions. If a trailer, attached to the case vehicle, rolled over but the vehicle itself did not, the variable should be coded "0" (No rollover).

If First Harmful Event (A10) equals "01" (Overturn) and it was based on this vehicle, then Rollover must not equal "0" for this vehicle, unless Body Type (V14) equals "20"- "29" (Motorcycles) for this vehicle.

It should be known whether or not this vehicle rolled over. If uncertainty exists, code "0" (No rollover).

Variable Name: Jackknife

Format: 1 column - numeric

Beginning
Column 113

Element Values:

- 0 Not an articulated vehicle
- 1 No
- 2 Yes

Source: Primary source is the vehicle inspection; secondary sources include photographs, police report, driver interviews, and other interviewees.

Remarks:

Jackknife can occur at any time during the collision. The phenomenon called "jackknife" is not restricted to truck-tractor vehicles; it may occur with any passenger vehicle, van, motorcycle, etc., which is pulling a trailing unit, and the trailing unit and the pulling vehicle are capable of rotating (articulating) with respect to each other.

Vehicles coded in variable V15 (Towed Trailing Unit) as "0" (No) are to be coded "0" (Not an articulated vehicle) here, unless they were previously coded as "75" (Truck tractor pulling one or more trailers), on variable V14 (Body Type). Code "75" (for variable V14, Body Type) as well as any vehicle for which variable V15, Towed Trailing Unit, equals "1" (Yes), must be coded, on this variable, either "1" (No) or "2" (Yes).

Code "2" (Yes) whenever there is sufficient rotation (articulation) between the trailing unit (which includes another vehicle) and the pulling vehicle to come in contact with each other and leave any visible damage (irrespective) of the magnitude of the damage), or the rotation was ninety (90) degrees or more.

Code "2" (Yes) excludes articulation under controlled situations (e.g., backing, parking, etc.).

Variable Name: Submission of Potential Safety Problem Bulletin

Format: 1 column - numeric

Beginning
Column 114

Element Values:

0 No
1 Yes

Source: Investigator determined--inputs include vehicle inspection, scene inspection, police report, driver interviews, and other interviewees.

Remarks:

Code "0" (No) when the Body Type (V14) is known and no potential safety problem bulletin was submitted. Use code "0" (No) whenever the Body Type (V14) is unknown ("99").

All teams will be provided with bulletins (forms) to report any potential vehicle safety problems which they encounter. Code "1" (Yes) if a bulletin is submitted.

Submit these bulletins to Mr. Vernon Roberts at NHTSA. It has been requested that each team be placed on the mailing list for reports of active defect investigations. Teams should become familiar with current investigations and be on the lookout for accidents which are relevant to these investigations; although, other defects or vehicle problems encountered are also of interest and should be reported.

Attach a copy of the bulletin submitted to NHTSA to the Vehicle Form before submitting the case to your Zone Center.

A list of potential safety problems of current interest to NHTSA follows.

This list is provided for guidance and is not intended to be inclusive.

Variable Name: Submission of Potential Safety Problem Bulletin (cont'd.)

SPECIFIC AREAS OF INTEREST TO NHTSA RULEMAKING

CRASH AVOIDANCE

1. Accident involving vehicles driven by handicapped drivers.
2. Accident involving vehicles equipped with adaptive aids.
3. Accidents in which failure of a multipiece rim (not a tire failure) caused or contributed to the severity of the accident.
4. Accidents involving malfunction of a speed governor or speed control unit.
5. Accidents where the driver reported confusion about the location of display or control elements of the vehicle.
6. Accidents where underinflation of tires caused or contributed to the severity of the accident.
7. Accidents involving pedestrian and/or cyclist injured by impact with outside mirrors.
8. Accidents involving injury to motorcycle drivers due to impact with the motorcycle mirrors.
9. Accidents where driver reported that distortion of image in convex mirror confused him (especially late model GM cars).
10. Accidents where commercial vehicle drivers reported that they could not see car, pedestrian, or cycle in a specific blind spot (such as in the right front area of large truck-tractors).
11. Accidents where driver of a passenger car or light truck reported that they could not see because of an obstruction of view by some part of the vehicle (such as inside mirror or roof support pillar).
12. Accidents where the vehicle's defrost/defog system or wiper system could not provide an adequate view of the traffic scene through the windshield.
13. Accidents where drivers reported they didn't see a heavy duty commercial vehicle before striking the rear or side of that vehicle (i.e., truck conspicuity problems).

Variable Name: Submission of Potential Safety Problem Bulletin (cont'd.)

14. Accidents involving heavy duty vehicles where a malfunctioning antilock system is alleged to have caused or contributed to the severity of the accident.
15. Accidents involving heavy duty vehicles where brakes out of adjustment caused or contributed to the severity of the accident.
16. Accidents involving heavy duty vehicle hot brake fade (i.e., runaways).
17. Accidents involving pickup trucks pulling fifth-wheel type trailers.
18. Accidents involving heavy duty air braked vehicles in which the vehicle's being stalled in traffic due to emergency brake application (loss of air pressure) caused an accident.
19. Accidents involving braking, jackknifing, or loss of control of trailers equipped with electric brakes or no brakes.

CRASHWORTHINESS

1. Seat and/or seat back failures in crashes and their contribution to occupant injury.
2. Identify external vehicle components (i.e., hood, grill, windshield wiper, etc.) that penetrate the windshield and the degree of such penetration in crashes involving vans and light trucks.
3. Ejections through the hatchback or station wagon rear doors in rear impacts. Identify whether ejection was through window opening or through door or hatchback opening because of latch failure.
4. Cars involving child restraints that break or involve injury. Identify the restraint by make and model, how and which position used.

CORROSION

1. Structural rust of uni-body undercarriage, vehicle chassis frames, floor boards in areas of seat belt attachment points or seat or seat track anchorages.
2. Rust which develops in areas where the owner can observe the rust and therefore be forewarned, but which might have safety implications such as cowl area and wipers, around windshield or backlite.

VEHICLE FORM

V73

(4)

Variable Name: Submission of Potential Safety Problem Bulletin (cont'd.)

3. Rust on weight bearing or vehicle guidance components, the failure of which could affect vehicle safety and do not normally wear out in service, such as tie rods, control arms, strut rods.
4. Rust of areas where the owners report exhaust intrusion such as wheel wells, wagon tire wells and rear floor pans.

POTENTIAL SAFETY PROBLEM BULLETIN

Reporting Date: _____

SEND TO: Vernon Roberts, NRD-32
National Highway Traffic Safety Administration
Nassif Building, Room 6213
400 Seventh Street, S.W.
Washington, D.C. 20590

SUBJECT: _____

IDENTIFICATION:

TEAM _____ CASE NO. _____ ACCIDENT DATE: _____

ACCIDENT LOCATION _____

INVESTIGATING POLICE AGENCY _____

VEHICLE MODEL YEAR _____ MAKE/MODEL _____

VIN _____ ODOMETER READING _____

ACCIDENT DESCRIPTION (include sanitized police report)

(continue on back)

ITEM DESCRIPTION (include hardware and photographs if possible)

Variable Name: Hazardous Carqo

Format: 1 column - numeric

Beginning
Column 115

Element Values:

- 0 No hazardous carqo
- 1 Load of hazardous materials only
- 2 Load of hazardous and nonhazardous materials
- 9 Unknown

Source: Primary source is vehicle inspection; secondary sources include driver interview, photographs, and police report.

Remarks:

The following definitions have been abstracted from the Code of Federal Regulations, Title 49-Transportation, Parts 100 to 177. Refer to the referenced sections for complete details. NOTE: Rulemaking proposals are outstanding or are contemplated concerning some of these definitions.

HAZARDOUS MATERIAL - Means a substance or material which has been determined by the Secretary of Transportation to be capable of posing an unreasonable risk to health, safety, and property when transported in commerce, and which has been so designated. (Sec. 171.8)

HAZARD CLASS	UN No	DEFINITIONS
		<u>An Explosive</u> - Any chemical compound, mixture, or device, the primary or common purpose of which is to function by explosion, i.e., with substantially instantaneous release of gas and heat, unless such compound, mixture, or device is otherwise specifically classified in Parts 171-179. (Sec. 173.50)
CLASS A EXPLOSIVE	1	Detonating or otherwise of maximum hazard. The nine types of Class A explosives are defined in Sec. 173.53.
CLASS B EXPLOSIVE	1	In general, function by rapid combustion rather than detonation and include some explosive devices such as special fireworks, flash powders, etc. (Sec. 173.88)
CLASS C EXPLOSIVE	1	Certain types of manufactured articles containing Class A or Class B explosives, or both, as components but in restricted quantities, and certain types of fireworks. (Sec. 173.100)
BLASTING NT	1	A material designed for blasting which has been tested in accordance with Sec. 173.114a(b) and found to be so insensitive that there is very little probability of accidental initiation to explosion or of transition from deflagration to detonation. [Sec. 173.114a(b)]

VEHICLE FORM

V74

(2)

HAZARD CLASS	UN No	DEFINITIONS
		<p><u>Compressed Gas</u> - Any material or mixture having in the container a pressure EXCEEDING 40 psia at 70°F., or a pressure exceeding 104 psia at 130°F.; or any liquid flammable material having a vapor pressure exceeding 40 psia at 100°F. [Sec. 173.300(a)]</p> <p><u>Non-liquefied compressed gas</u> is a gas, other than gas in solution, which under the charged pressure is entirely gaseous at a temperature of 70°F.</p> <p><u>Liquefied compressed gas</u> is a gas which, under the charged pressure, is partially liquid at a temperature of 70°F.</p> <p><u>Compressed gas in solution</u> is a nonliquefied compressed gas which is dissolved in a solvent.</p>
FLAMMABLE GAS	2	Any compressed gas meeting the requirements for lower flammability limit, flammability limit range, flame projection, or flame propagation criteria as specified in Sec. 173.300(b).
NONFLAMMABLE GAS	2	Any compressed gas other than a flammable compressed gas.
COMBUSTIBLE LIQUID	3	Any liquid having a flash point at or above 100°F. and below 200°F. as determined by tests listed in Sec. 173.115(d). Exceptions are found in Sec. 173.115(b).
FLAMMABLE LIQUID	3	<p>Any liquid having a flash point below 100°F. as determined by tests listed in Sec. 173.115(d). For exceptions, see Sec. 173.115(a).</p> <p><u>Pyroforic Liquid</u> - Any liquid that ignites spontaneously in dry or moist air at or below 130°F. [Sec. 173.115(c)]</p>
FLAMMABLE SOLID	4	<p>Any solid material, other than an explosive, which is liable to cause fires through friction, retained heat from manufacturing or processing, or which can be ignited readily and when ignited, burns so vigorously and persistently as to create a serious transportation hazard. Included in this class are spontaneously combustible and water-reactive materials. (Sec. 173.150)</p> <p><u>Spontaneously Combustible Material (Solid)</u> - A solid substance (including sludges and pastes) which may undergo spontaneous heating or self-ignition under conditions normally incident to transportation or which may, upon contact with the atmosphere, undergo an increase in temperature and ignite. (Sec. 171.8)</p> <p><u>Water Reactive Material (Solid)</u> - Any solid substance (including sludges and pastes) which, by interaction with water, is likely to become spontaneously flammable or to give off flammable or toxic gases in dangerous quantities. (Sec. 171.8)</p>

HAZARD CLASS	UN No.	DEFINITIONS
ORGANIC PEROXIDE	5	An organic compound containing the bivalent -O-O structure and which may be considered a derivative of hydrogen peroxide where one or more of the hydrogen atoms have been replaced by organic radicals must be classed as an organic peroxide unless... [See Sec. 173.151(a) for details].
OXIDIZER	5	A substance such as chlorate, permanganate, inorganic peroxide, or a nitrate, that yields oxygen readily to stimulate the combustion of organic matter. (See Sec. 173.151)
POISON A	2	<u>Extremely Dangerous Poisons</u> - Poisonous gases or liquids of such nature that a very small amount of the gas, or vapor of the liquid, mixed with air is <u>dangerous to life</u> . (Sec. 173.326)
POISON B	6	<u>Less Dangerous Poisons</u> - Substances, liquids or solids (including pastes and semi-solids), other than Class A or Irritating materials, which are known to be so toxic to man as to afford a hazard to health during transportation; or which, in the absence of adequate data on human toxicity, are presumed to be toxic to man. (Sec. 173.343)
IRRITATING MATERIAL	6	A liquid or solid substance which, upon contact with fire or when exposed to air, gives off dangerous or intensely irritating fumes, but <u>not including any poisonous material, Class A</u> . (Sec. 173.381)
ETIOLOGIC AGENT	6	An "etiologic agent" means a viable micro-organism, or its toxin, which causes, or may cause, human disease. (Sec. 173.386)
RADIOACTIVE MATERIAL	7	Any material, or combination of materials, that spontaneously emits ionizing radiation, and having a specific activity greater than 0.002 microcuries per gram. (Sec. 173.389) [See Sec. 173.389(a) through (1) for details]
CORROSIVE MATERIAL	8	Any liquid or solid that causes visible destruction or irreversible alterations in human skin tissue or a liquid that has a severe corrosion rate on steel. [See Sec. 173.240(a) and (b) for details]
ORM - OTHER REGULATED MATERIALS		(1) Any material that may pose an unreasonable risk to health and safety or property when transported in commerce; and (2) Does not meet any of the definitions of the other hazard classes specified in this subpart; or (3) Has been reclassified an ORM (specifically or permissively) according to this subchapter. [Sec. 173.500(a)] NOTE: A material with a flashpoint of 100°F. to 200°F. must be classed as a combustible rather than as an ORM if it is a hazardous waste or is offered in a packaging having a rated capacity of more than 110 gallons.
ORM-A	9	A material which has an anesthetic, irritating, noxious, toxic, or other similar property and which can cause extreme annoyance or discomfort to passengers and crew in the event of leakage during transportation. [Sec. 173.500(b)(1)]

HAZARD CLASS	UN No	DEFINITIONS
ORM-B	9	A material (including a solid when wet with water) capable of causing significant damage to a transport vehicle from leakage during transportation. Materials meeting one or both of the following criteria are ORM-B materials: (1) A liquid substance that has a corrosion rate exceeding 0.250 inch per year (IPY) on aluminum (nonclad 7075-T6) at a test temperature of 130°F. An acceptable test is described in NACE Standard TM-01-69; and/or (2) Specifically designated by name in Sec. 172.101. [Sec. 173.500(b)(2)]
ORM-C	9	A material which has other inherent characteristics not described as an ORM-A or ORM-B but which makes it unsuitable for shipment, unless properly identified and prepared for transportation. Each ORM-C material is specifically named in Sec. 172.101. [Sec.173.500(b)(3)]
ORM-D	9	A material such as a consumer commodity which, though otherwise subject to the regulations of this subchapter, presents a limited hazard during transportation due to its form, quantity and packaging. They must be materials for which <u>exceptions</u> are provided in Sec. 172.101. A shipping description applicable to each ORM-D material or category of ORM-D materials is found in Sec. 172.101. [Sec. 173.500(b)(4)]
ORM-E	9	A material that is not included in any other hazard class, but is subject to the requirements of this subchapter. Materials in this class include (1) hazardous waste and (2) hazardous substance, as defined in Sec. 171.8. [Sec. 173.500(b)(5)]

THE FOLLOWING ARE OFFERED TO EXPLAIN SOME OF THE ADDITIONAL TERMS USED IN PREPARATION OF HAZARDOUS MATERIALS FOR SHIPMENT. (Sec. 171.8)

CONSUMER COMMODITY (See ORM-D above)		A material that is packaged or distributed in a form intended and suitable for sale through retail sales agencies or instrumentalities for consumption by individuals for purposes of personal care of household use. This term also includes drugs and medicines. (Sec. 171.8)
FLASH POINT		The minimum temperature at which a substance gives off flammable vapors which, in contact with a spark or flame, will ignite. For liquids, see Sec. 173.115; for solids, see Sec. 173.150.

TERM	DEFINITION
FORBIDDEN	Material is prohibited from being offered or accepted for transportation. This prohibition <u>does not</u> apply if these materials are diluted, stabilized, or incorporated in devices and they are classed in accordance with the definitions of hazardous materials. [Sec. 172.101(d)(1)]
HAZARDOUS SUBSTANCE	For transportation purposes, a material and its mixtures or solutions, that is identified by the letter "E" in Column (1) of the Hazardous Materials Table, Sec. 172.101, when offered for transportation in one package, or in one transport vehicle if not packaged, and when the quantity of the material therein equals or exceeds the reportable quantity (RQ). For details, refer to Sec. 171.8 and Sec. 172.101 (Hazardous Materials Table).
HAZARDOUS WASTE	Any material that is subject to the hazardous waste manifest requirements of the Environmental Protection Agency specified in the CFR, Title 40, Part 262 or would be subject to these requirements in the absence of an interim authorization to a State under Title 40, CFR, Part 123, Subpart F. (Sec. 171.8). Questions regarding EPA hazardous waste regulations, call Toll Free: (800) 424-9065 or in Washington: 554-1404.
LIMITED QUANTITY	The maximum amount of a hazardous material as specified in those sections applicable to the particular hazard class for which there is a specific labeling and packaging exception from the requirements. See Sec. 173.118, 173.118(a), 173.153, 173.244, 173.306, 173.345, 173.364 and 173.391.
REPORTABLE QUANTITY	The quantity of hazardous substance specified in the Hazardous Materials Table (Sec. 172.101) and identified by the letter "E" in Column (1). (Sec. 171.8)

VEHICLE FORM

V74
(6)

Variable Name: Hazardous Cargo (cont'd.)

This variable measures the association between the vehicle under consideration and the presence of hazardous cargo. It does not measure the type of hazardous cargo.

Code "0" (No hazardous cargo) if the vehicle was not transporting any cargo which is defined as hazardous above. Use this code if (1) neither a truck (light, medium, or heavy) nor a van (i.e., V14 = 40-79) was involved and (2) the police report does not state whether the vehicle was carrying hazardous cargo and (3) no additional information is available (i.e., no vehicle inspection and no interview).

Code "1" (Load of hazardous materials only) or "2" (Load of hazardous and nonhazardous materials) if the vehicle was transporting any cargo defined above as hazardous. The existence of a DOT Hazardous Materials Warning Placard or Label is a good indicator of the presence of a hazardous material. However, caution should be exercised to be sure that the vehicle was transporting the hazardous cargo at the time of the accident. Also, be sure to write down on page 2 of the Driver Form (Specific Question block) a note to ask the driver if the cargo was only hazardous material or a mixture.

Code "1" (Load of hazardous materials only) should be used if all of the cargo transported was hazardous. It does not matter whether or not all of the cargo was composed of the same type of hazardous material.

Code "2" (Load of hazardous and nonhazardous materials) is used if any part (but not all) of the cargo transported was nonhazardous.

Transported means that the cargo was moved by the vehicle (V14, Body Type) or any trailing units associated with the vehicle.

Code "9" (Unknown) should be used when no information is available on hazardous cargo. For example, a transient truck is involved in an accident with minor damage; the police report does not address hazardous cargo, and an interview is not available. This circumstance should be coded "9". For unknown hazardous cargo in passenger cars, motorcycles, buses, and other vehicles (i.e., V14 = 01-39, 80-89), use code "0" (No hazardous cargo).

DOT Hazardous Materials Warning Labels

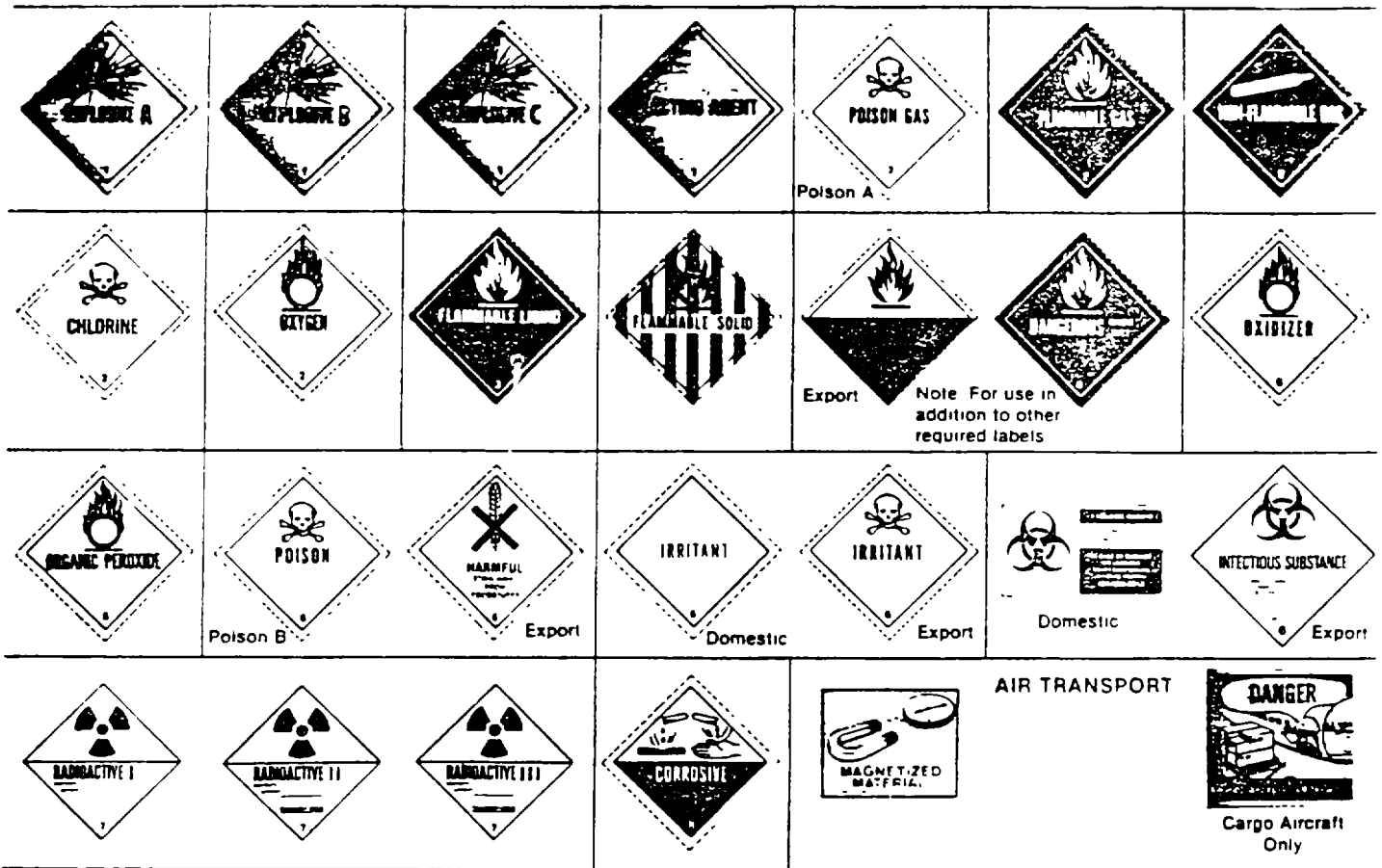

General Guidelines on Use of Labels

1. The Hazardous Materials Tables, Sec 172.101 and 172.102, identify the proper label(s) for the hazardous materials listed
2. Any person who offers a hazardous material for shipment *must* label the package, if required [Sec 172.400(a)]
3. Labels may be affixed to packages (even though not required by the regulations) provided each label represents a hazard of the material in the package [Sec 172.401]
4. Label(s), when required, *must* be printed on or affixed to the surface of the package near the proper shipping name [Sec 172.406(a)]
5. When two or more different labels are required display them next to each other [Sec 172.406(c)]
6. When two or more packages containing compatible hazardous materials are packaged within the same overpack the outside container *must* be labeled as required for each class of material contained therein [Sec 172.404(b)]
7. Material classified as an Explosive A, Poison A or Radioactive Material also meeting the definition of another hazard class *must* be labeled for each class [Sec 172.402(a)]

8. Material classed as an Oxidizer, Corrosive, Flammable Solid, or Flammable Liquid that also meets the definition of a Poison B *must* be labeled POISON, in addition to the hazard class label. [Sec. 172.402(a)(3) and (5)]
9. Material classed as a Flammable Solid that also meets the definition of a water-reactive material *must* be labeled with FLAMMABLE SOLID and DANGEROUS WHEN WET labels. [Sec. 172.402(a)(4)]
10. Material classed as a Poison B, Flammable Liquid, Flammable Solid, or Oxidizer that also meets the definition of a Corrosive material *must* be labeled CORROSIVE in addition to the class label. [Sec 172.402(a)(6) through (9)]

Hazardous Materials Class Numbers

Hazardous materials class numbers associated with the hazard classes

- Class 1- Explosives
- Class 2- Gases (Compressed, liquefied or dissolved under pressure)
- Class 3- Flammable liquids
- Class 4- Flammable solids or Substances
- Class 5- Oxidizing Substances
- Class 6- Poisonous and Infectious Substances
- Class 7- Radioactive Substances
- Class 8- Corrosives
- Class 9- Miscellaneous dangerous Substances

NOTE For requirements, see Sec 172.102(h), 172.332(c)(3) and 172.407(g)

This chart is designed as a reference. For more complete details, refer to the Code of Federal Regulations, Title 49, Parts 100-177



US Department of Transportation
Research and Special Programs
Administration

Materials Transportation Bureau
Washington, D.C. 20590

DOT Hazardous Materials Warning Placards

V74
(8)

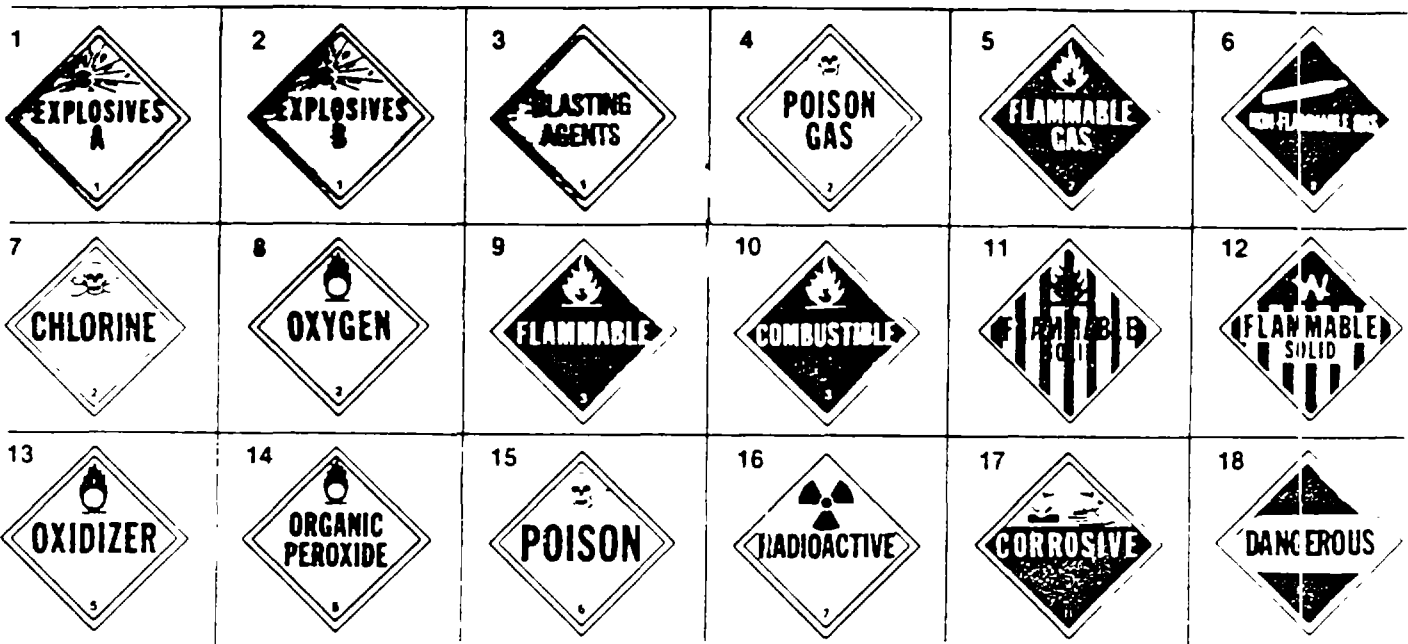

Numbers in each square (illustration numbers) refer to TABLES 1 and 2



Use a square background on large quantity shipments requiring special routing

May be substituted for Flammable and/or Combustible placard See Sec 172.542 and 172.544

Use a square background for the above placards

TABLE 1	Guidelines	TABLE 2																																																		
<table border="0"> <tr> <td>Hazard Classes</td> <td>★ No</td> </tr> <tr> <td>Class A explosives</td> <td>1</td> </tr> <tr> <td>Class B explosives</td> <td>2</td> </tr> <tr> <td>Poison A</td> <td>4</td> </tr> <tr> <td>Flammable solid (DANGEROUS WHEN WET label only)</td> <td>12</td> </tr> <tr> <td>Radioactive material (YELLOW III label)</td> <td>16</td> </tr> <tr> <td>Radioactive material</td> <td></td> </tr> <tr> <td> Uranium hexafluoride fissile (containing more than 0.7% U235)</td> <td>16 & 17</td> </tr> <tr> <td> Uranium hexafluoride low-specific activity (containing 0.7% or less U235)</td> <td>16 & 17</td> </tr> </table>	Hazard Classes	★ No	Class A explosives	1	Class B explosives	2	Poison A	4	Flammable solid (DANGEROUS WHEN WET label only)	12	Radioactive material (YELLOW III label)	16	Radioactive material		Uranium hexafluoride fissile (containing more than 0.7% U235)	16 & 17	Uranium hexafluoride low-specific activity (containing 0.7% or less U235)	16 & 17	<ul style="list-style-type: none"> Placard motor vehicles, freight containers and rail cars containing any quantity of hazardous materials listed in TABLE 1 Placard motor vehicles and freight containers containing 1,000 pounds or more gross weight of hazardous materials classes listed in TABLE 2 Placard freight containers 640 cubic feet or more containing any quantity of hazardous materials classes listed in TABLES 1 and/or 2 when offered for transportation by air or water. Under 640 cubic feet, see Sec 172.512(b) Placard rail cars containing any quantity of hazardous materials classes listed in TABLE 2 except when less than 1,000 pounds gross weight of hazardous materials are transported in TOFC (Trailer on Flat Car) or COFC (Container on Flat Car) service 	<table border="0"> <tr> <td>Hazard Classes</td> <td>★ No</td> </tr> <tr> <td>Class C explosives</td> <td>18</td> </tr> <tr> <td>Blasting agent</td> <td>3</td> </tr> <tr> <td>Nonflammable gas</td> <td>6</td> </tr> <tr> <td>Nonflammable gas (Chlorine)</td> <td>7</td> </tr> <tr> <td>Nonflammable gas (Fluorine)</td> <td>15</td> </tr> <tr> <td>Nonflammable gas (Oxygen, pressurized liquid)</td> <td>8</td> </tr> <tr> <td>Flammable gas</td> <td>5</td> </tr> <tr> <td>Combustible liquid</td> <td>10</td> </tr> <tr> <td>Flammable liquid</td> <td>9</td> </tr> <tr> <td>Flammable solid</td> <td>11</td> </tr> <tr> <td>Oxidizer</td> <td>13</td> </tr> <tr> <td>Organic peroxide</td> <td>14</td> </tr> <tr> <td>Poison B</td> <td>15</td> </tr> <tr> <td>Corrosive material</td> <td>17</td> </tr> <tr> <td>Irritating material</td> <td>18</td> </tr> </table>	Hazard Classes	★ No	Class C explosives	18	Blasting agent	3	Nonflammable gas	6	Nonflammable gas (Chlorine)	7	Nonflammable gas (Fluorine)	15	Nonflammable gas (Oxygen, pressurized liquid)	8	Flammable gas	5	Combustible liquid	10	Flammable liquid	9	Flammable solid	11	Oxidizer	13	Organic peroxide	14	Poison B	15	Corrosive material	17	Irritating material	18
Hazard Classes	★ No																																																			
Class A explosives	1																																																			
Class B explosives	2																																																			
Poison A	4																																																			
Flammable solid (DANGEROUS WHEN WET label only)	12																																																			
Radioactive material (YELLOW III label)	16																																																			
Radioactive material																																																				
Uranium hexafluoride fissile (containing more than 0.7% U235)	16 & 17																																																			
Uranium hexafluoride low-specific activity (containing 0.7% or less U235)	16 & 17																																																			
Hazard Classes	★ No																																																			
Class C explosives	18																																																			
Blasting agent	3																																																			
Nonflammable gas	6																																																			
Nonflammable gas (Chlorine)	7																																																			
Nonflammable gas (Fluorine)	15																																																			
Nonflammable gas (Oxygen, pressurized liquid)	8																																																			
Flammable gas	5																																																			
Combustible liquid	10																																																			
Flammable liquid	9																																																			
Flammable solid	11																																																			
Oxidizer	13																																																			
Organic peroxide	14																																																			
Poison B	15																																																			
Corrosive material	17																																																			
Irritating material	18																																																			

UN and NA Identification Numbers

- UN (United Nations) or NA (North American) numbers are found in Sec 172.101, 172.102 and the Emergency Response Guidebook
- The four-digit UN or NA numbers are used to identify the hazardous materials involved
- NA numbers are used only in the USA and Canada
- UN or NA numbers must be displayed on Tank Cars, Cargo Tanks and Portable Tanks

- When ID numbers are displayed on placards ORANGE PANELS are not required
- When ID numbers are displayed on ORANGE PANELS, appropriate placards are also required



1541

- EUROPEAN NUMBERING SYSTEM
Top numbers represent the Hazard Index. The bottom numbers are the required UN identification numbers



For more complete details on Identification Numbers see Sec 172.300 through 172.338

Variable Name: Vehicle Curb Weight

Format: 3 columns - numeric

Beginning
Column 116

Element Values:

Level 2 Range: 001 through 500

Code recorded weight to the nearest 100 pounds.

001 Less than 150 Pounds
997 99,650 Pounds or More
999 Unknown

Source: Primary and secondary sources are listed below; occasional tertiary sources [for heavy trucks only (i.e., over 10,000 lbs. GVWR)] are the vehicle inspection and driver interview.

Remarks:

"Vehicle" is defined on this variable to mean one and the same as that which is coded on V14, Body Type.

Code to nearest 100 pounds as in the examples:

Weight: 180 lbs.	Weight: 3,230 lbs.	Weight: 16,500 lbs.
Code: 002	Code: 032	Code: 165

Code "001" if the weight is less than 150 lbs.

Do not confuse the rated Gross Vehicle Weight Rating (GVWR) with the curb weight since it is likely to be significantly greater than the curb weight.

For heavy trucks an inspection is only a source where some document (e.g., bill of lading) is found which reveals the weight. Further, the interview is only a source where the driver knew the weight because of having had the vehicle weighed.

The weight of the trailer (exclusive of cargo) is counted with the vehicle curb weight if variable V14 (Body Type) is coded as "75" (Truck tractor pulling one or more trailers). The weight of the cargo contained within or on the trailer(s) as well as in the tractor is coded under variable V76 (Vehicle Cargo Weight).

If variable V15 (Towed Trailing Unit) is coded "1" (Yes) and variable V14 (Body Type) is not coded as "75" (Truck tractor pulling one or more trailers), the weight of the trailer and its cargo is not coded here. Instead,

VEHICLE FORM

V75

(2)

Variable Name: Vehicle Curb Weight (cont'd.)

it is coded under variable V76 (Vehicle Cargo Weight). For example, the weight of a boat trailer and its cargo are coded as Vehicle Cargo Weight (V76), distinct from the weight of the vehicle.

When coding a pickup (V14, Body Type, equal 50 or 51) or car [e.g., El Camino (V14 = 10)] with an add-on type camper (i.e., shell or self-contained), do not consider the add-on type camper as part of the curb weight. Add-on type campers should be coded under Variable V76, Vehicle Cargo Weight. However, chassis-mounted campers are to be included in this variable.

If the vehicle model (V13) is known, but the engine size is unknown (e.g., 6 or 8 cylinders), code the average between the high and low curb weights for the model and annotate that the "average" was reported.

When the vehicle specifications do not report the vehicle weight with the proper engine size then adjustments must be made. First, try to determine the weight differences from the vehicle specifications. If the weight difference cannot be determined from the specifications then adjust as follows: 8 cyl. to 6 cyl. - subtract 100 lbs.; 6 cyl. to 4 cyl. - subtract 75 lbs.

Add 100 lbs. to the shipping weight to obtain a curb weight on all light duty vehicles (except motored cycles, snowmobiles, and other unusual vehicle types).

The primary source is the first source of reference material listed below; the next three sources are secondary.

Passenger Vehicle Specifications
Motor Vehicle Manufacturers Association
of the U.S., Inc.
300 New Center Building
Detroit, Michigan 48202

Automotive News
Crain Automotive Group, Inc.
965 East Jefferson Avenue
Detroit, Michigan 48207

Branham Automobile Reference Book
Branham Publishing Company
Post Office Box 1948
Santa Monica, California 90406

VEHICLE FORM

V75
(3)

Variable Name: Vehicle Curb Weight (cont'd.)

Gasoline Truck Index and
Diesel Truck Index
Truck Index, Inc.
Post Office Box 4221
Anaheim, California 92803

Annotate the source used in the space provided on the Vehicle Form under this variable.

Variable Name: Vehicle Cargo Weight

Format: 3 columns - numeric

Beginning
Column 119

Element Values:

Level 2 Range: 000 through 500

Code recorded weight to the nearest 100 pounds.

000 Less than 050 pounds
997 99,650 pounds or more
999 Unknown

Source: Investigator determined--inputs include vehicle inspection (e.g., GVW, shipping invoice, bill of lading), driver interview, and other interviews.

Remarks:

Code to the nearest 100 pounds as in the examples:

Weight: 180 lbs.
Code: 002

Weight: 3,230 lbs.
Code: 032

Weight: 16,500 lbs. ,
Code: 165

Code "000" if the weight is less than 050 lbs.

Do not include the weight of the occupants in the cargo weight. The weight represented by the occupants will be included as a component (along with cargo and vehicle curb weight) of the single value which represents the vehicles combined weight on the CRASH Program Summary Form, if used.

The weight of the cargo (including animals) contained within or on the trailer(s) as well as in the tractor for vehicles coded "75" (Truck tractor pulling one or more trailers) on variable V14 (Body Type) is coded here. This is exclusive of the weight of the trailer(s) by themselves.

If variable V15 (Towed Trailing Unit) is coded "1" (Yes) and variable V14 (Body Type) is not coded as "75" (Truck tractor pulling one or more trailers) [prohibited combination--see Remarks section for V15, Towed Trailing Unit], the weight of the trailer and its cargo (if known) is coded here.

VEHICLE FORM

V76

(2)

Variable Name: Vehicle Cargo Weight (cont'd.)

The weight of add-on type campers (i.e., shell or self-contained) should be coded here. See Remarks section for V75, Vehicle Curb Weight.

Code "997" (99,650 pounds or more) if the cargo weight is 99,650 lbs. or more.

Code "999" (Unknown) if cargo weight is unknown.

VEHICLE FORM

V77

Variable Name: Investigator Reported Source of Cargo Weight

Format: 1 column - numeric

Beginning
Column 122

Element Values:

- 0 No cargo
- 1 Measured
- 2 Estimated
- 3 Rated capacity
- 9 Unknown: Source or weight

Source: Investigator determined--inputs include vehicle inspection, driver interview, and other interviewees.

Remarks:

Code "0" (No cargo) only if there was no cargo. If cargo is present and the total cargo weight of V76 (Vehicle Cargo Weight) is less than 50 pounds (i.e., if V76 equals "000"), then V77 can equal "1" (Measured) or "2" (Estimated).

If the cargo weight (V76) is coded greater than or equal to 50 pounds, then code this variable as "1" (Measured), "2" (Estimated), or "3" (Rated capacity) respectively.

Annotate the source used in the space provided on the Vehicle Form under this variable.

RECONSTRUCTION PROGRAM

Four options or methods for calculating the Delta V are available in the reconstruction program. Delta V is a vector quantity giving the difference in velocity over the collision or crushing phase of an impact. The direction is the same as that of the principal direction of force. $V = V_{\text{separation}} - V_{\text{impact}}$.

DAMAGE ALGORITHM (CRASH 3)

In this method the damage profile and direction of principal force for each vehicle are used to estimate the Delta V. In the absence of an exact profile the CDC itself will be utilized by the program. When the vehicles have been inspected it is important to utilize the "nearest 10-degree" estimate of force direction rather than only relying on the o'clock sector definition for CDC.

TRAJECTORY ALGORITHM (CRASH 3)

In this method the evidence from the scene as well as vehicle damage data is utilized to estimate Delta V. The scene evidence of trajectory will, allow prediction of impact speed as well as Delta V. The scene data may be uncertain in many cases. For example, the friction coefficient on a wet road may be uncertain. The precise location of final rest and impact positions may be uncertain. The path between impact and final rest may be uncertain. The uncertainty associated with such evidence grows as the time between the accident and the time of scene inspection increases. The investigator should not be dismayed for even a live scene contains ambiguities concerning impact position and trajectory. Even the final rest position may be confused by action of the police in moving the vehicles to clear traffic congestion. Your best efforts as a trained, experienced investigator are required to obtain reliable evidence in these challenging situations.

RECONCILIATION OF DIFFERENT RESULTS BETWEEN DAMAGE AND TRAJECTORY (CRASH 3)

When evidence from the scene and the vehicle are present, the execution of the reconstruction program will produce two independent estimates of Delta V. The two results will seldom be precisely equal. What is a significant difference, and what action should the investigator take in the face of a significant difference?

Experience indicates that satisfactory agreement exists between the two estimates when the directions of Delta V are colinear and their total Delta V component magnitude differs by no more than 4 kph or 10 percent, whichever is greater. When the agreement is not satisfactory, the data associated with each option should be reviewed for accuracy.

Possible sources of error include:

Vehicle damage: Review the crush measurements and ensure they are consistent with the damage photos. Review the wheel and tire conditions to ensure they reflect the best estimates of their contribution to steering and drag.

Scene evidence: Review the impact and rest positions and the trajectory path. Review the surface coefficient of friction. Make sure directions of rotation, points on the paths, and end-of-rotation points are specified correctly.

After reviewing these sources, subsequent runs should be made if adjustments to the input are rational. ADJUSTMENTS SHOULD NOT BE MADE WITHOUT BASIS FOR UNCERTAINTY IN THE ADJUSTED VARIABLES. If agreement cannot be reached between the two methods, the case should be flagged for special review by the Zone Center, who will then complete variables V78 through V82.

Investigators will find it convenient when uncertainty exists in some variables such as friction coefficient and other scene evidence, to identify the range of rational error that may exist before initiating a reconstruction run.

If agreement does not occur, the RERUN execution on the reconstruction program can then be initiated at a considerable savings in time devoted to changing the input variables.

In any case, when both options--DAMAGE and TRAJECTORY--have been executed and agreement has been obtained, the two results for Delta V should be averaged after making the force direction collinear and this averaged value entered in V79 through V82.

For known occupants with unknown weights, use the occupant's age or age group in the table below to determine the appropriate weight to add.*

Age	0	1	2	3	4	5	6	7	8	9	10	11	12	13
Male	17	25	30	35	39	43	48	53	59	66	73	83	93	105
Female	16	24	29	33	37	41	45	51	59	67	77	86	97	106
Age	14	15	16	17	18-24	25-34	35-44	45-54	55-64	65-97				
Male	119	131	142	149	161	172	176	175	170	163				
Female	115	121	124	125	128	132	139	145	144	142				

Age Group	Child (0-12)	Adolescent (13-17)	Adult (18-97)
Male	50**	130***	170
Female		120***	137

*Sources of Information:

- Weight and Heights of Adults 18-74 Years of Age: United States, 1971-1974. Vital and Health Statistics: Series 11, Data from the National Health Survey; Number 211. DHEW publication (PHS) 79-1659. Table 4, page 17; data based on 50th percentile.

- NCHS Growth Curves for Children Birth-18 Years: United States. Vital and Health Statistics: Series 11, Data from the National Health Survey; Number 165. DHEW publication (PHS) 79-1650. Tables 10, page 34, and 14, page 38; data based on 50th percentile at half year age to the nearest pound.

**Based on 6 and 7 year olds rounded to the nearest 5 pounds.

***Based on 15 year olds rounded to the nearest 5 pounds.

MISSING VEHICLE ALGORITHM

The data for the Missing Vehicle Algorithm is entered in the same manner as the data is entered for CRASH 3 "Damage Only" Algorithm.

The minimum information required on the missing, or not inspected vehicle, is:

- Vehicle make/model/year or size category
(Table 8-1 in CPASH 3 Manual)
- Mass [curb weight + occupant(s) weight + cargo weight], if available.
- Area of damage (at least third character of CDC - "Area of deformation").

The information required on the inspected vehicle is the same as that information needed to run CRASH 3.

YIELDING OBJECT ALGORITHM

The data for the Yielding Object Algorithm is entered in the same manner as the data is entered for CRASH 3 "Damage Only" Algorithm.

Certain characteristics of the struck object are required data in order to reconstruct a Delta V. These characteristics depend on the type or category of the object that is struck. Record the following data for each category of object listed below:

1. Wood Utility Pole
 - a. pole diameter.
 - b. degree of fracture: partial, complete shear, undamaged.
 - c. degree of shift in ground: inches, degrees.
2. Non-movable (fixed) deformable objects.
 - a. type of structure and material.
 - b. size of structure (barrier post size).
 - c. degree of damage to structure (Rough crush profile or max crush).
3. Movable objects (e.g., mailbox, fence post, objects not rigidly attached to ground).
 - a. description of object.
 - b. approximate mass/weight of the object.
 - c. distance object was thrown from POI to FRP.

Variable Name: Basis for Total Delta V (highest)

Format: 1 column - numeric

Beginning
Column 123

Element Values:

Delta V calculated

- 1 CRASH program damage-only routine
- 2 CRASH program damaged and trajectory routine
- 3 Missing vehicle algorithm
- 4 Yielding object algorithm
- 5 Other technique used

Delta V not calculated

- 6 At least one vehicle (which may include this vehicle) is beyond the scope of an acceptable reconstruction program: regardless of collision conditions.
- 7 All vehicles within scope (CDC applicable) of CRASH program but one of the collision conditions is beyond the scope of the CRASH program or other acceptable reconstruction technique: regardless of the adequacy of damage data.
- 8 All vehicles and collision conditions are within scope of one of the acceptable reconstruction programs, but there is insufficient data available.

Source: Investigator determined--inputs include CRASH output (if applicable), vehicle inspection, scene inspection, police report, and photographs.

Remarks:

This variable is used to indicate what reconstruction algorithm or technique was used to compute this vehicle's highest Delta V (results coded in variables V79-V82), or the reason a reconstruction program was not applied to the most severe impact.

Code "1" (CRASH program damage-only routine) means that the CRASH3 output (coded in variables V79-V82) is based upon vehicle damage only.

Code "2" (CRASH program damage and trajectory routine) means that the CRASH3 output (coded in variables V79-V82) is based on trajectory evidence documented at the scene, in addition to vehicle damage.

Code "3" (Missing vehicle algorithm) means that in a two vehicle impact that one vehicle is inspected (damage measurements and CDC are obtained) but for the other vehicle the damage measurements (including CDC) are missing but enough data is available to use the missing vehicle algorithm.

Variable Name: Basis for Total Delta V (highest) [cont'd.]

Code "4" (Yielding object algorithm) means that in a vehicle/object impact that the object yielded but adequate data is available to use the yielding object algorithm.

Code "5" (Other technique used) means that a technique other than CRASH, missing vehicle algorithm, and yielding object algorithm was used to determine delta V. Identify the technique in the space provided.

Code "6" (At least one vehicle) means that one of the vehicles (including this vehicle) involved in this vehicle's most severe collision cannot be adequately represented by the parameters in an acceptable reconstruction size/stiffness categories (e.g., large truck, motorcycle, bus, etc.). As a general rule in NASS, any vehicle that is not applicable for CDC is not applicable for an acceptable reconstruction program.

Code "7" (All vehicles within scope) means that the involved vehicles fit the vehicle parameters for an acceptable reconstruction program; however, the collision type is beyond the scope of the program (e.g., rollover, sideswipe, etc.).

Code "8" (All vehicles and collision) means that the involved vehicles and the collision type are applicable for an acceptable reconstruction program (1 through 5 above), but due to insufficient data on one (or both) of the vehicles (or object), an acceptable reconstruction program (1 through 5 above) cannot be used.

V78	V79	V80-V81	V82
1, 5	00 - 97	-97 - +97	0000 - 9997
6, 7, or 8	_99	_99	9999

The character "_" means leave the first space "blank".

Variable Name: Total Delta V

Format: 2 columns - numeric

Beginning
Column 124

Element Values:

Level 1 Range: 00 through 97, 99

Nearest k.p.h.

00 Less than 0.5 k.p.h.

97 97 k.p.h and above

99 Unknown

Source: Reconstruction program.

Remarks:

Complete an acceptable reconstruction program (where applicable) for all impacts in the accident. The results may then be used to classify the corresponding CDCs by severity, for variables V25-V60 of the Vehicle Form. If a CDC is entered in row variables V27-V32 and it was used in exercising the reconstruction program, code the Total Delta V as shown in the results.

Code this variable as "99" (Unknown), if results for the most severe impact are unobtainable. If the CDC associated with the reconstruction program was only entered in row variables V35-V41 (secondary), enter the Total Delta V as shown in the results on the space available in the secondary (noncoded) column of this variable.

To convert miles to kilometers, multiply miles times 1.61. For example, 18 m.p.h. x 1.61 = 29.0 k.p.h.

Variable Name: Longitudinal Component of Delta V

Format: 3 columns - numeric

Beginning
Column 126

Element Values:

Level 1 Range: -97 k.p.h. through +97 k.p.h., _99

Nearest k.p.h.

±00 Greater than -0.5 and less than 0.5 k.p.h.

±97 97 k.p.h. and above

_99 Unknown

Source: Reconstruction program.

Remarks:

Complete an acceptable reconstruction program (where applicable) for all impacts in the accident. The results may then be used to classify the corresponding CDCs by severity for variables V25-V60 of the Vehicle Form. If a CDC is entered in row variables V27-V32 (highest) and it was used in exercising the reconstruction program, code the Longitudinal Component of Delta V as shown in the results.

Code this variable as "99" (Unknown), if the results for the most severe impact are unobtainable. If the CDC associated with reconstruction program was only entered in row variables V35-V41 (secondary), enter the Longitudinal Component of Delta V as shown in the results on the space available in the secondary (noncoded) column of this variable.

The character "_" means leave the first space "blank".

Variable Name: Lateral Component of Delta V

Format: 3 columns - numeric

Beginning
Column 129

Element Values:

Level 1 Range: -97 k.p.h. through +97 k.p.h., _99

Nearest k.p.h.

±00 Greater than -0.5 and less than 0.5 k.p.h.

±97 97 k.p.h. and above

_99 Unknown

Source: Reconstruction program.

Remarks:

Complete an acceptable reconstruction program (where applicable) for all impacts in the accident. The results may then be used to classify the corresponding CDCs by severity for row variables V25-V60 of the Vehicle Form. If a CDC is entered in row variables V27-V32 (highest) and it was used in exercising the reconstruction program, code the Lateral Component of Delta V as shown in the results.

Code this variable as "99" (Unknown), if the results for the most severe impact are unobtainable. If the CDC associated with the reconstruction program was only entered in row variables V35-V41 (secondary), enter the Lateral Component of Delta V as shown in the results on the space available in the secondary (noncoded) column of this variable.

The character "_" means leave the first space "blank".

Variable Name: Energy Absorption

Format: 4 columns - numeric

Beginning
Column 132

Element Values:

Level 1 Range: 0000 through 9997, 9999 newton.meters

Nearest 100 newton.meters (joules)

0000 Less than 50 newton.meters

9997 999,650 newton.meters or more

9999 Unknown

Source: Reconstruction program.

Remarks:

Complete an acceptable reconstruction program (where applicable) for all impacts in the accident. The results may then be used to classify the corresponding CDCs by severity for variables V25-V60 of the Vehicle Form. If a CDC is entered in row variables V26-V33 (highest) and it was used in exercising the reconstruction program, code the Energy Absorbed as shown in the results.

Code this variable as "9999" (Unknown) if the result for the most severe impact are unobtainable. If the CDC associated with the reconstruction program was only entered in row variables V35-V41 (secondary), enter the Energy Absorbed as shown in the results on the space available in the secondary (noncoded) column of this variable.

To convert foot-pounds to newton.meters, multiply by 1.356. For example, 14631.3 ft-lbs. x 1.356 = 19840 nt.m.

The value is then reported to the nearest 100 newton.meters. In the above example it would be "0198".

If the reconstruction program is exercised in the english version and the amount of energy absorbed exceeds 737,462 ft-lbs., code "9997".

If the reconstruction program is exercised in the metric version and the amount of energy absorbed exceeds 999,999 nt.m, the output will appear as "*****", code "9997". In this case, rerun the program using the english version to get the actual amount of energy absorbed since ft-lbs. are 1/1.356 times as great as equivalent nt.m. The english version should indicate that the amount of energy absorbed is greater than 737,462 ft-lbs.

VEHICLE FORM

V81

Variable Name: Reconstruction Damage Data for Highest Delta V - L

Format: 4 columns - numeric

Beginning
Column 135

Element Values: (metric values)

Level 2 Range: 0005 through 0600 centimeters

Nearest centimeter

Blank - No reconstruction output for most severe impact

9999 Unknown

Source: Reconstruction program.

Remarks:

The output of the reconstruction program contains a "Summary of the Damage Data". The value of "L" coded must be the same as the "L" value given in this reconstruction program output's Summary. This is the value of L that is used in the reconstruction program, and it should not be confused with the "Field L" measurement. Of course, it is possible that in some cases the value of "Field L" is the same as the value of the "reconstruction program L". (NOTE: The "L" measurement used in the reconstruction program considers both direct and induced damage.)

If there is no reconstruction attempt on the most severe impact, leave this variable "blank".

If there is a reconstruction attempt on the most severe impact, but this variable is unknown, code "9999" (Unknown).

When no value is entered into the reconstruction program (e.g., CDC only run), code "9999" (Unknown).

Variable Name: Reconstruction Program Damage Data for Highest Delta V - C1
Reconstruction Program Damage Data for Highest Delta V - C2
Reconstruction Program Damage Data for Highest Delta V - C3
Reconstruction Program Damage Data for Highest Delta V - C4
Reconstruction Program Damage Data for Highest Delta V - C5
Reconstruction Program Damage Data for Highest Delta V - C6

Format: 3 columns - numeric

Beginning
Column 140

Element Values: (metric values)

Level 2 Range: 000 through 150 centimeters

Nearest centimeter

Blank - No reconstruction output for most severe impact

999 Unknown

Source: Reconstruction Program.

Remarks:

The values of "C" (i.e., C1, C2, C3, C4, C5, and C6) coded must be the same as the "C" values given in the reconstruction output Summary. These are the C-values used in the reconstruction program, and they may differ from C-measurements made in the field. For example, in a side impact with sill override, the C-measurements are taken along the plane that represents maximum crush and at the sill level. These C-measurements are averaged for the reconstruction purposes. In this example, the C-values coded (V84) are averaged C-measurements. [NOTE: If only 4 C-measurements are taken (i.e., $L \leq 16$ "), then leave C5 and C6 "Blank".]

If there is no reconstruction attempt run on the most severe impact, leave these variables "blank".

If there is a reconstruction attempt on the most severe impact, but these variables are unknown, code "999" (Unknown).

When no value is entered into the reconstruction program (e.g., CDC only run), code "999" (Unknown).

VEHICLE FORM

V85

Variable Name: Reconstruction Program Damage Data for Highest Delta V ± D

Format: 4 columns - numeric

Beginning
Column 158

Element Values:

Level 2 Range: -300 centimeters through +300 centimeters

Nearest centimeter

Blank - No reconstruction output for most severe impact

±000 Greater than -0.5 and less than +0.5 centimeters

_999 Unknown

Source: CRASH Program Summary Form (input data).

Remarks:

This is the measured value of "D" entered in the reconstruction program, and remember that it is the induced plus direct "D" that is used in the reconstruction program. If input was in inches, be sure to convert the value to centimeters (i.e., 1 inch = 2.54 centimeters) before recording it here.

If there is no reconstruction attempt run on the most severe impact, leave this variable "blank".

If there is a reconstruction attempt run on the most severe impact, but this variable is unknown, code "_999" (Unknown).

When no value is entered into the reconstruction program (e.g., CDC only run), code "_999" (Unknown).

The character "_" means leave the first space "blank".

Variable Name: Travel Speed

Format: 2 columns - numeric

Beginning
Column 162

Element Values:

Level 1 Range: 00 through 97, 99
Nearest m.p.h.
00 Stopped or less than 0.5 m.p.h.
97 97 m.p.h. or higher
99 Unknown

Source: Police report only.

Remarks:

Code the travel speed for this vehicle if indicated on the police report by the investigating officer. Do not use estimates by drivers or witnesses.

Code to the nearest m.p.h. as in the examples:

Reported Speed: 40 m.p.h.
Code: 40

Reported Speed: 40.2 m.p.h.
Code: 40

Reported Speed: 40.5 m.p.h.
Code: 41

Code "00" if stopped or less than 0.5 m.p.h.

Code "97" if 97 m.p.h. or greater.

Code "99" if the estimated travel speed is unknown.

If the travel speed is reported as a range, code the average. For example, if reported as 55-60 m.p.h., code "58".

VEHICLE FORM

V87

V83

V89

Variable Name: 1st - Other Vehicle Related Factors
2nd - Other Vehicle Related Factors
3rd - Other Vehicle Related Factors

Format: 2 columns - numeric

Beginning

Column 164

166

168

Element Values:

00 No other vehicle related factors

Defective

01 Tires

02 Wheels

03 Brake system

04 Steering system

05 Suspension

06 Power train

07 Exhaust system

08 Headlights

09 Signal lights

10 Other lights (specify)

11 Horn

12 Mirrors

13 Wipers

14 Body, doors

15 Driver seating and control

16 Trailer hitch

98 Other (specify)

99 Unknown

Source: Police report.

Remarks:

The purpose of these variables is to provide guidance to safety research on the involvement of these factors in accidents. Causal determinations must necessarily be based on more detailed investigations and other data, such as exposure data.

VEHICLE FORM

V87
V88
V89
(2)

Variable Name: 1st - Other Vehicle Related Factors (cont'd.)
2nd - Other Vehicle Related Factors (cont'd.)
3rd - Other Vehicle Related Factors (cont'd.)

Related Factors are circumstances that may have contributed to the cause of an accident. For our purposes, regarding vehicle related factors, only those factors indicated by the investigating police officer on the PAR are to be considered for coding. These factors can appear anywhere on the report--in the narrative section, in the space for violations, in the column titled "Contributing Factors" or "Vehicle Defects", etc.

As described in the coding attributes, vehicle related factors are police accident report (PAR) indications of defects. The vehicle related factors are taken directly from the PAR whether or not the PAR's contributing factor is accurate.

Only the vehicle related factors that apply to that particular vehicle should be coded. If only one factor applies, the code for it should be entered in the slots for the first variable. The following variables should be coded "00" (No other vehicle related factors), signifying no subsequent related factors. If two or three factors apply, code accordingly in ascending numerical order. If more than three codes apply, choose the three that seem the most significant. If no other vehicle related factors apply, code "00" (No other vehicle related factors) for all three variables.

Code "00" (No other vehicle related factors) if a vehicle defect was not indicated by the investigating officer as a related factor in the accident.

Codes "01" through "16" are to be applied when the specific vehicle component is indicated as defective on the PAR. It is not necessary that the PAR indicate this as a cause of the accident.

Code "03" (Brake system) includes parking brake.

Code "06" (Power train) includes engine, transmission, drive shaft, differential, etc.

Code "07" (Exhaust system) includes exhaust manifolds, headers, muffler, tailpipe, etc.

Code "14" (Body, doors) includes trunk, hood, tailgate, rear doors of cargo vans, etc.

VEHICLE FORM

V87
V88
V89
(3)

Variable Name: 1st - Other Vehicle Related Factors (cont'd.)
2nd - Other Vehicle Related Factors (cont'd.)
3rd - Other Vehicle Related Factors (cont'd.)

Code "16" (Trailer hitch) is to be applied to a defective trailer hitch only. An improper trailer hitch qualifies as a driver-related factor [code "37" (Operating without required equipment) in the Driver Related Factors section.

Code "99" (Unknown) in all three spaces only when the PAR specifically states "unknown contributing factors".

Components may be defective through inadequate design, through improper maintenance or absence of maintenance. For NASS purposes, it would require additional sources of data to ascertain this information; thus, it is not a matter to be considered in coding these variables. If it appears on the FAR or in the opinion of the investigator based on his observations of the accident data in the PAR and all other available sources to be related to inadequate design, then a Potential Safety Problem Bulletin should also be filed.

For hit and run vehicles, code "00" (No other vehicle related factors) for all three variables unless the PAR indicates the presence of a factor.



Driver Data

1. Primary Sampling Unit Number	1	2
2. Case Number - Stratification	3	4 5 6
3. Record Number	4	7
4. Transaction Code	8	
5. Version Number	7	9
6. Investigator I.D. Number	10	

IDENTIFICATION

7. Vehicle Number	11	12
8. Number of Occupants This Motor Vehicle		
<p>_____ occupant(s) - Code the actual number of persons (including the driver if present) that were occupants of this vehicle. The number of OCCUPANT FORMS does not have to equal this value</p> <p>- (97) 97 or more</p> <p>- (99) Unknown</p>		
9. Driver Presence In Vehicle	13	14
<p>- (1) Driver Present</p> <p>- (2) Driver Not Present</p>		
<p>(NOTE: If no driver was present in this vehicle, indicate and subsequently leave blank the remaining non-environmental questions on this form. Do code the environmental elements. No OCCUPANT FORM for the driver is required. Remember, if the person who had been driving this motor vehicle prior to the accident was injured outside of this vehicle, that person is handled on the PEDESTRIAN & NONMOTORIST FORM.)</p>		

DRIVER INTERVIEW

10. Months Driving Experience This Class of Vehicle (e.g., passenger car, light truck, motorcycle, etc.)	16	17
<p>_____ months - Code actual months of previous driving experience up to 60.</p> <p>(NOTE: 44 days or less equals 1 month; a month and a half equals 2 months.)</p> <p>- (61) Greater than five years</p> <p>- (99) Unknown</p>		

11. Estimated Mileage This Vehicle
(Estimated total mileage that driver has driven in this specific accident involved vehicle.)

- _____ miles to the nearest 100
- (001) Less than 150 miles
- (997) 99,650 miles or more
- (999) Unknown

18 19 20

12. Total Mileage All Vehicles
(Past Twelve Months)

- _____ miles to the nearest 100
- (001) Less than 150 miles
- (997) 99,650 miles or more
- (999) Unknown

21 22 23

13. Type of Operation or Carrier
(vehicle over 10,000 lbs GVWR)

- (0) Noncommercial or not vehicle over 10,000 lbs. GVWR
- (1) For hire / common carrier
- (2) For hire / contract carrier
- (3) Private carrier of property or passengers
- (4) Carrier of ICC exempt commodities
- (5) Foreign carrier
- (6) Carrier of migrant workers
- (7) U.S. mail carrier
- (8) Other: _____
- (9) Unknown

24

14. Federal Safety Regulated

- (0) Noncommercial or not vehicle over 10,000 lbs. GVWR
- (1) Motor carrier not subject to U.S. DOT (BMCS) regulations
- Motor carrier subject to U.S. DOT (BMCS) regulations
- (2) Intercity operations
- (3) Local pickup or delivery
- (9) Unknown

25

15. Driver's Classification

- (0) Noncommercial or not vehicle over 10,000 lbs. GVWR
- (1) Full time employee
- (2) Part Time employee
- (3) Owner operator
- (4) Leased (from labor contractor)
- (8) Other: _____
- (9) Unknown

26

ACCIDENT DESCRIPTION INSTRUCTIONS

Do not interrupt person during general description (narrative), unless he/she requests your assistance. Attempt to summarize the narrative while minimizing any disruptions of the person's internal logic. Specific questions may be asked later. Write these questions down in the space below or on the other side of the paper, prior to the interview.

SPECIFIC QUESTION. _____

GENERAL DESCRIPTION OF ACCIDENT SEQUENCE

(This represents a synopsis of an uninterrupted narrative by the driver.)

Estimated Travel Speed

(NOTE: Record as obtained from interviewee in increments of 5 m.p.h.; note information source e.g., speedometer, estimate, etc.)

- Stopped Less than 5 m.p.h.
- Actual speed (in increments)
- Not applicable Unknown

Estimated Impact Speed

(NOTE: Record as obtained from interviewee in increments of 5 m.p.h.; note information source e.g., speedometer, estimate, etc.)

- Stopped Less than 5 m.p.h.
- Actual speed (in increments)
- Not applicable Unknown

INFORMATION SOURCE:

Delete After Case Review

PRE-CRASH	Travel Lane (NOTE: Lane one is the curb or shoulder lane; lane two is the next lane, etc. to the median or centerline. Opposing lanes are numbered similarly and distinguished by direction of travel.)
Direction of Travel <input type="checkbox"/> North <input type="checkbox"/> Southeast <input type="checkbox"/> East <input type="checkbox"/> Northwest <input type="checkbox"/> South <input type="checkbox"/> Southwest <input type="checkbox"/> West <input type="checkbox"/> Not applicable <input type="checkbox"/> Northeast <input type="checkbox"/> Unknown	<input type="checkbox"/> 1st lane <input type="checkbox"/> On shoulder <input type="checkbox"/> 2nd lane <input type="checkbox"/> On trafficway <input type="checkbox"/> 3rd lane <input type="checkbox"/> Off road <input type="checkbox"/> 4th lane <input type="checkbox"/> Outside trafficway <input type="checkbox"/> 5th or additional lane <input type="checkbox"/> Not applicable <input type="checkbox"/> Unknown

¹ Object Contacted <input checked="" type="checkbox"/> Motor vehicle <input type="checkbox"/> Guardrail <input type="checkbox"/> Ditch <input type="checkbox"/> Ground <input type="checkbox"/> Tree <input type="checkbox"/> Pole <input type="checkbox"/> Sign <input type="checkbox"/> Pedacyclist <input type="checkbox"/> Pedestrian <input type="checkbox"/> Other: _____ <input type="checkbox"/> Unknown	² Vehicle Impact Location <input type="checkbox"/> (1) Front <input type="checkbox"/> (2) Right side <input type="checkbox"/> (3) Rear <input type="checkbox"/> (4) Left side <input type="checkbox"/> (5) Top <input type="checkbox"/> (6) Undercarriage <input type="checkbox"/> (7) Other: _____ <input type="checkbox"/> (8) Not applicable <input type="checkbox"/> (9) Unknown	³ Vehicle Orientation <input type="checkbox"/> (1) Tracking, no skidding (includes controlled turn) <input type="checkbox"/> (2) Tracking, skidding <input type="checkbox"/> (3) Rotated clockwise to path of travel <input type="checkbox"/> (4) Rotated counterclockwise to path of travel <input type="checkbox"/> (5) Rolling over <input type="checkbox"/> (6) Jackknifed <input type="checkbox"/> (7) Other: _____ <input type="checkbox"/> (8) Not applicable <input type="checkbox"/> (9) Unknown
--	--	---

DRIVER VIEW of TOTAL ACCIDENT CONTACT SEQUENCE

Did More Than Six Events Occur? Unknown, No, Yes: code the six severest impacts.

Event Number (Driver)	Final Event Number (Investigator)	Object Contacted ¹	One Vehicle			Other Vehicle—if applicable		
			Vehicle Number	Event Location ²	Vehicle Orientation ³	Vehicle Number	Event Location ²	Vehicle Orientation ³
1	—	—	—	—	—	—	—	—
2	—	—	—	—	—	—	—	—
3	—	—	—	—	—	—	—	—
4	—	—	—	—	—	—	—	—
5	—	—	—	—	—	—	—	—
6	—	—	—	—	—	—	—	—

POST-CRASH Final Rest Position <input type="checkbox"/> On roadway <input type="checkbox"/> On shoulder <input type="checkbox"/> In parking lane <input type="checkbox"/> In median <input type="checkbox"/> Off road (beyond shoulder area) <input type="checkbox"/> Other: _____ <input type="checkbox"/> Not applicable <input type="checkbox"/> Unknown	Driver Inputs Between Last Point-of-Impact and Final Rest Position <input type="checkbox"/> None <input type="checkbox"/> Braking <input type="checkbox"/> Steering left <input type="checkbox"/> Steering right <input type="checkbox"/> Braking and steering left <input type="checkbox"/> Braking and steering right <input type="checkbox"/> Acceleration followed by braking <input type="checkbox"/> Acceleration followed by braking and steering <input type="checkbox"/> Releasing brake <input type="checkbox"/> Other: _____ <input type="checkbox"/> Not applicable <input type="checkbox"/> Unknown
---	---

multiple impacts occurred, describe driver inputs between initial and last point-of-impact.

ACCIDENT DIAGRAM

Draw a rough sketch of the accident sequence as described by the driver. Note impact and final rest positions carefully. If possible, relate these to some identifiable object in the area, and record vehicle and pedestrian or nonmotorist headings relative to an object, as well

Indicate North

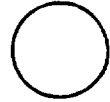

Any luggage or other cargo in vehicle when accident occurred? Estimated Weight: _____ lbs.

Describe: _____

Hazardous cargo in vehicle? No Yes If yes, specify: _____

Present location of vehicle (if not yet inspected)? _____

Did any of the Following Restrictions of the Road Exist Prior to the Accident

- None
- Narrow bridge (as defined)
- Previous accident
- Maintenance, repair, or construction activity on roadway
- Roadway immersion (standing water)
- Unknown

Road Surface Condition

- Dry
- Snow or slush
- Wet
- Ice
- Sand, dirt or oil
- Unknown

16. Driver Education

Automobile or Light Truck Driver Training

- (0) No formal driver training
- (1) In training at time of accident
- (2) High school driver training
- (3) Commercial driver training
- (8) Other formal driver training (e.g., college, military, etc.)
- (9) Unknown

Motorcycle Driver Training

- (0) No formal driver training
- (1) In training at time of accident
- (6) Motorcycle driver training
- (9) Unknown

Heavy Vehicle Driver Training (>10,000 lbs. GVWR)

- (0) No formal driver training
- (1) In training at time of accident
- (4) Truck driver training school
- (5) Motor carrier program – On-the-Job-Training
- (7) Vocational training (CETA, Job Corp, other government sponsored training, etc.)
- (8) Other formal driver training (e.g., college, military, etc.)
- (9) Unknown

17. Frequency Driving Road

- (1) Daily
- (2) Weekly
- (3) Monthly
- (4) Less than once a month
- (5) First time on road
- (9) Unknown

18. 19. 20. Actions Prior to Avoidance Maneuvers

(Code what the vehicle was doing prior to accident.)

- ___ Blank - Driver not present (D09)
- Movements essentially straight ahead
- ___ (00) No actions
- ___ (01) Moving straight, details unknown or no maneuvers
- ___ (02) Straight ahead in proper direction, including curves in roadway
- ___ (03) Overtaking other vehicle on left, left of center line
- ___ (04) Overtaking other vehicle on left, right of center line (includes one-way roadways without center lines)
- ___ (05) Overtaking another vehicle on right
- ___ (06) Straight ahead in left turn lane
- ___ (07) Straight ahead in right turn lane
- ___ (08) Changing lanes to left
- ___ (09) Changing lanes to right
- ___ (10) Merging from left (roadway narrows on left)
- ___ (11) Merging from right (roadway narrows on right)
- ___ (12) On wrong side of roadway
- ___ (13) In wrong direction on one-way roadway
- ___ (14) Swerving to left
- ___ (15) Swerving to right
- ___ (16) Slowing or stopping
- ___ (17) Skidding longitudinally
- ___ (18) Skidding laterally
- ___ (19) Spinning or yawing
- ___ (20) Jackknifing
- ___ (21) Stopped in traffic
- ___ (22) Starting from stop
- ___ (23) Increasing speed

Turning Movements

- ___ (30) Turning, details unknown
- ___ (31) Left from left turn bay or special lane
- ___ (32) Left from left (proper) lane
- ___ (33) Left from other lane, legal
- ___ (34) Left from other lane, illegal
- ___ (35) Left from unknown lane
- ___ (36) U-turn
- ___ (37) Right from special lane
- ___ (38) Right from right (proper) lane
- ___ (39) Right from other lane, legal
- ___ (40) Right from other lane, illegal
- ___ (41) Right from unknown lane

Entering Traffic Lane

- ___ (50) Entering traffic lane, details unknown
- ___ (51) From entrance ramp on left
- ___ (52) From entrance ramp on right
- ___ (53) From shoulder on left
- ___ (54) From shoulder on right
- ___ (55) From parking space at left curb
- ___ (56) From parking space at right curb
- ___ (57) From driveway on left
- ___ (58) From driveway on right

Leaving Traffic Lane

- ___ (60) Leaving traffic lane, details unknown
- ___ (61) To exit ramp on left
- ___ (62) To exit ramp on right
- ___ (63) To shoulder on left
- ___ (64) To shoulder on right
- ___ (65) To parking space at left curb
- ___ (66) To parking space at right curb
- ___ (67) To driveway on left
- ___ (68) To driveway on right

Parking On Or Adjacent To Traffic Lane

- ___ (70) Parking, details unknown
- ___ (71) On left shoulder
- ___ (72) On right shoulder
- ___ (73) At left curb
- ___ (74) At right curb
- ___ (75) In traffic lane (on roadway) on left
- ___ (76) In traffic lane (on roadway) on right
- ___ (77) Double parking on left
- ___ (78) Double parking on right

Miscellaneous Movements

- ___ (81) Backing in roadway
- ___ (82) Backing from parking on left
- ___ (83) Backing from parking on right
- ___ (84) Backing across traffic
- ___ (85) Backing on shoulder
- ___ (86) Vehicle pushed by other vehicle
- ___ (87) Vehicle pushed by pedestrian
- ___ (88) Not in motion (parked or standing—driver in vehicle)
- ___ (89) Loss of air pressure in tire (blowout or other)
- ___ (98) Other _____
- ___ (99) Unknown

	Inter- viewee	Inves- tigator		
(18)	___	___	29	30
(19)	___	___	31	32
(20)	___	___	33	34

Inter- viewee	Investi- gator
21. Attempted Avoidance Maneuver (Pre-Crash)	
<input type="checkbox"/> (00) No avoidance actions	<input type="checkbox"/>
<input type="checkbox"/> (01) Braking (no lockup)	<input type="checkbox"/>
<input type="checkbox"/> (02) Braking (lockup)	<input type="checkbox"/>
<input type="checkbox"/> (03) Pumping brakes (modulation)	<input type="checkbox"/>
<input type="checkbox"/> (04) Releasing brakes	<input type="checkbox"/>
<input type="checkbox"/> (05) Steering left	<input type="checkbox"/>
<input type="checkbox"/> (06) Steering right	<input type="checkbox"/>
<input type="checkbox"/> (07) Braking and steering left	<input type="checkbox"/>
<input type="checkbox"/> (08) Braking and steering right	<input type="checkbox"/>
<input type="checkbox"/> (09) Accelerating	<input type="checkbox"/>
<input type="checkbox"/> (10) Accelerating and steering left	<input type="checkbox"/>
<input type="checkbox"/> (11) Accelerating and steering right	<input type="checkbox"/>
<input type="checkbox"/> (98) Other action:	<input type="checkbox"/>
<input type="checkbox"/> (99) Unknown	<input type="checkbox"/>
	35 35
22. How Many Accidents Within Past Twelve Months (as Driver)	
Code actual value up through 7	
<input type="checkbox"/> (8) 8 or more	
<input type="checkbox"/> (9) Unknown	
	37

POLICE REPORT

Traffic Violation Charged Against This Driver

NO – Code 0 for each of questions 23 through 31.

If YES – Check (✓) each of the violations below that were indicated; code 1 for the checked violations and 0 for the violations not checked.

Unknown – Code 9 for each of questions 23 through 31

23. <input type="checkbox"/> Speeding	38
24. <input type="checkbox"/> Driving While Intoxicated (or DUI)	39
25. <input type="checkbox"/> Reckless Driving	40
26. <input type="checkbox"/> Driving With Suspended or Revoked License	41
27. <input type="checkbox"/> Failure to Yield Right-of-Way	42
28. <input type="checkbox"/> Following too Closely	43
29. <input type="checkbox"/> Running a Traffic Signal or Stop Sign	44
30. <input type="checkbox"/> Other Violation Charged	45
31. <input type="checkbox"/> Unknown Violation Charged	46
32. <input type="checkbox"/> Police Reported Alcohol Presence	
<input type="checkbox"/> (0) No (alcohol not present)	
<input type="checkbox"/> (1) Yes (alcohol present)	
<input type="checkbox"/> (8) Not reported	
<input type="checkbox"/> (9) Unknown	
	47

POLICE, HOSPITAL/MEDICAL, OR OTHER OFFICIAL	
33. Alcohol Test Results	
<input type="checkbox"/> Actual value (decimal implied before first digit) (0.xx)	
<input type="checkbox"/> (95) Test refused	
<input type="checkbox"/> (96) None given	
<input type="checkbox"/> (97) AC test performed, results unknown	
<input type="checkbox"/> (99) Unknown	48 49
34. License Source	
<input type="checkbox"/> (0) No license	
<input type="checkbox"/> (1) Domestic	
<input type="checkbox"/> (2) Foreign	
<input type="checkbox"/> (9) Unknown	
	50
35. Compliance With License Restrictions	
<input type="checkbox"/> (0) No restrictions	
<input type="checkbox"/> (1) Restrictions complied with	
<input type="checkbox"/> (2) Restrictions not complied with	
<input type="checkbox"/> (3) Restrictions, compliance unknown	
<input type="checkbox"/> (9) Unknown	
	51
36. Driver License Status (For This Vehicle)	
<input type="checkbox"/> (0) No license required	
<input type="checkbox"/> (1) Not licensed	
<input type="checkbox"/> (2) Valid	
<input type="checkbox"/> (3) Suspended	
<input type="checkbox"/> (4) Revoked	
<input type="checkbox"/> (5) Expired	
<input type="checkbox"/> (6) Canceled or denied	
<input type="checkbox"/> (7) Learner's permit	
<input type="checkbox"/> (8) Temporary	
<input type="checkbox"/> (9) Unknown	
	52
37. Driver License Type Compliance	
<input type="checkbox"/> (0) No license required	
<input type="checkbox"/> (1) No license, license required	
<input type="checkbox"/> (2) Valid license (for this class vehicle only)	
<input type="checkbox"/> (3) One (single class) valid license (but not for this class vehicle)	
<input type="checkbox"/> (4) Multiple class license – valid license for this class vehicle	
<input type="checkbox"/> (5) Multiple class license – no valid license for this class vehicle	
<input type="checkbox"/> (9) Unknown	
	53

38. Driver License Restrictions

- ___ (0) No restrictions
- ___ (1) Corrective or contact lenses
- ___ (2) Mechanical aid
- ___ (3) Limited to daylight only
- ___ (4) Automatic transmission
- ___ (5) Outside mirror
- ___ (6) Prosthetic aid
- ___ (7) Limited to employment
- ___ (8) Other restrictions _____
- ___ (9) Unknown

64

39. Additional Driver License Restrictions

- ___ (0) No additional restriction
- ___ (2) Mechanical aid
- ___ (3) Limited to daylight only
- ___ (4) Automatic transmission
- ___ (5) Outside mirror
- ___ (6) Prosthetic aid
- ___ (7) Limited to employment
- ___ (8) Other restrictions _____
- ___ (9) Unknown

66

Code in the space provided the actual number of recorded convictions/suspensions/accidents that occurred within the last three (3) years (as measured from the date of the accident.) If 8 or more convictions/suspensions or accidents, then code 8. If unknown, code 9.

(NOTE: The coded value: 8, indicates that the actual recorded value was eight or more; be sure that the actual value is recorded in the space provided near the question number.)

___ Unknown—Code 9 for each of questions 40 through 44.

- 40. ___ Previous Speeding Convictions 65
- 41. ___ Previous Other Harmful Moving Violation Convictions 67
- 42. ___ Previous Driving While Intoxicated Convictions (or DUIL) 68
- 43. ___ Previous Recorded Suspensions and Revocations 69
- 44. ___ Previous Recorded Accidents 70

WAS THE DRIVER'S VEHICLE IN A SCHOOL ZONE?
(FOR USE IN CODING A40)

Yes _____
No _____

ENVIRONMENTAL DATA

45. Number of Travel Lanes

- ___ (1) One
- ___ (2) Two
- ___ (3) Three
- ___ (4) Four
- ___ (5) Five
- ___ (6) Six
- ___ (7) Seven or more
- ___ (9) Unknown

61

46. Median Type

- ___ (0) No Median
- ___ (1) Curbed
- ___ (2) Positive Barrier
- ___ (3) Unprotected
- ___ (9) Unknown

62

47. Median Width

- ___ (00) No median
Code actual measured value up to 96 feet.
- ___ (97) 97 feet and above
- ___ (99) Unknown

63

64

48. Access Control

- ___ (1) Full
- ___ (2) Partial
- ___ (3) Uncontrolled
- ___ (9) Unknown

65

49. Trafficway Flow

- ___ (0) Not physically divided (two way traffic)
- ___ (1) Divided trafficway – median strip without traffic barrier
- ___ (2) Divided trafficway – median strip with traffic barrier
- ___ (3) One way trafficway
- ___ (9) Unknown

66

50. Highway Performance Monitoring System (HPMS) Sample Number

Code actual alphanumeric values. The first column identifies the county within the PSU. See coding manual for designated codes.

- ___ (000000000000) Not in HPMS sample
- ___ (999999999999) Unknown

67 68 69 70 71 72 73 74 75 76 77 78 79

(If the HPMS data is not available, leave blank)

51. 52. Shoulder Type

Left	Right		
—	—	(0) No shoulder	
—	—	(1) Surfaced 2-6 ft.	
—	—	(2) Surfaced > 6 ft.	
—	—	(3) Gravel or other granular material 2-6 ft.	
—	—	(4) Gravel or other granular material > 6 ft.	
—	—	(5) Natural earth, with or without turf 2-6 ft.	
—	—	(6) Natural earth, with or without turf > 6 ft.	L R
—	—	(9) Unknown	80 81

53. Roadway Alignment

—	(1) Straight	
—	(2) Curve right	
—	(3) Curve left	
—	(9) Unknown	82
Length of Chord = _____ ft.		
Middle Ordinate = _____ in.		

54. Roadway Profile

—	(1) Level (< 2% grade)	slope measurement:
—	(2) Positive grade	
—	(3) Negative grade	
—	(4) Hillcrest	(v = _____)/(h = _____)
—	(5) Sag	
—	(9) Unknown	83

55. Roadway Surface Type

—	(1) Concrete	
—	(2) Bituminous	
—	(3) Brick or block	
—	(4) Slag, gravel or stone	
—	(5) Dirt	
—	(8) Other _____	
—	(9) Unknown	84

56. Roadway Surface Condition

—	(1) Dry	
—	(2) Wet	
—	(3) Snow or slush	
—	(4) Ice	
—	(5) Sand, dirt or oil	
—	(8) Other _____	
—	(9) Unknown	85

57. Speed Limit

—	(00) No statutory limit	
—	m.p.h. – Code actual posted or statutory speed limit	
—	(99) Unknown	86 87

58. Traffic Control Device Functioning

—	(0) No traffic control	
—	(1) Traffic control not functioning	
—	(2) Traffic control functioning – functioning improperly	
—	(3) Traffic control functioning properly	
—	(9) Unknown	88

59. Traffic Control Device

—	(00) No controls
<u>Not at railroad grade crossing</u>	
Highway traffic signals	
—	(01) Traffic control signal (on colors) without pedestrian signal
—	(02) Traffic control signal (on colors) with pedestrian signal
—	(03) Traffic control signal (on colors) not known whether or not pedestrian signal
—	(04) Flashing traffic control signal
—	(05) Flashing beacon
—	(06) Flashing highway traffic signal, type unknown or other than traffic control or beacon
—	(07) Lane use control signal
—	(08) Other highway traffic signal
—	(09) Unknown highway traffic signal
Regulatory signs	
—	(20) Stop sign
—	(21) Yield sign
—	(28) Other regulatory sign
—	(29) Unknown type regulatory sign
School Zone Signs	
—	(30) School speed limit sign
—	(31) School advance or crossing sign
—	(38) Other school related sign
—	(39) Unknown type school zone sign
Warning Signs	
—	(40) Warning sign
Miscellaneous Controls	
—	(50) Officer, crossing guard, flagman, etc.
<u>At railroad grade crossing</u>	
Active Devices	
—	(60) Gates
—	(61) Flashing lights
—	(62) Traffic control signal
—	(63) Wigwags
—	(64) Bells
—	(68) Other train activated device
—	(69) Active device, type unknown
Passive Devices	
—	(70) Crossbucks
—	(71) Stop sign
—	(72) Other railroad crossing sign
—	(73) Special warning device – watchman, flagged by crew.
—	(78) Other passive device
—	(79) Passive device, type unknown
Miscellaneous Controls	
—	(80) Grade crossing controlled type unknown
<u>Whether or not at railroad grade crossing</u>	
—	(98) Other
—	(99) Unknown

POLICE, HOSPITAL/MEDICAL, OR OTHER OFFICIAL

60. 61. 62. Other Driver Related Factors

- ___ (00) No other driver related factors
- Physical/Mental Condition:
- ___ (01) Nonphysical (i.e., mental or emotional factor)
- ___ (02) Drowsy, sleepy, asleep, fatigued
- ___ (03) Depression
- ___ (04) Illness, disease, blackout

Physical Impairments

- ___ (05) Deaf
- ___ (06) Restricted to wheelchair
- ___ (07) Paraplegic
- ___ (08) Previous injury
- ___ (09) Other physical impairments: _____

Drug Impairments

- ___ (10) Drugs-medication (prescription, over-the-counter)
- ___ (11) Other drugs (excludes alcohol, includes illegal substances): _____

Operator Related Factors:

- ___ (20) Inattention
- ___ (21) Interference with driver by other passenger
- ___ (22) Operator inexperience
- ___ (23) Unfamiliar with roadway
- ___ (24) Overloading or improper loading of vehicles with passengers or cargo
- ___ (25) Operating vehicle in erratic, reckless, careless or negligent manner
- ___ (26) Improper or erratic lane changing
- ___ (27) Failure to keep in proper lane or running off roadway
- ___ (28) Making improper entry to or exit from trafficway
- ___ (29) Failure to obey traffic signs, traffic control devices or traffic officers, failure to observe Safety Zones
- ___ (30) Failure to signal intentions
- ___ (31) Giving wrong signal
- ___ (32) Making right turn from left lane, making left turn from right lane
- ___ (33) Making other improper turn
- ___ (34) Driving wrong way on one-way roadway
- ___ (35) Driving on wrong side of roadway
- ___ (36) Failure to dim lights or to have lights on when required
- ___ (37) Operating without required equipment
- ___ (38) Creating unlawful noise or using equipment prohibited by law
- ___ (39) Passing where prohibited by posted signs, pavement markings, hill, curve or school bus displaying warning not to pass
- ___ (40) Passing on wrong side
- ___ (41) Passing with insufficient distance or inadequate visibility or failing to yield to overtaking vehicle
- ___ (42) Passing through or around barrier positioned to prohibit or channel traffic
- ___ (43) Failure to observe warnings or instructions on vehicles displaying them
- ___ (44) Driving less than posted minimum
- ___ (45) Operating at erratic or suddenly changing speeds

- ___ (46) High speed chase with police in pursuit
- ___ (47) Illegal driving on road shoulder, in ditch, on roadside, or on sidewalk or path
- ___ (48) Starting or backing improperly
- ___ (49) Stopping in roadway (vehicle not abandoned)
- ___ (50) Opening vehicle door into moving traffic or while vehicle is in motion
- ___ (51) Towing or pushing vehicle improperly
- ___ (98) Other: _____
- ___ (99) Unknown

(60) 91 92
 (61) 93 94
 (62) 95 96

63. 64. 65. Other Environmental Related Factors

- ___ (00) No other environmental related factors

Vision Obscured By:

- ___ (01) Rain, snow, fog, smoke, sand, dust
- ___ (02) Reflected glare, bright sunlight, headlights
- ___ (03) Curve, hill or other design features (including traffic signs, embankment)
- ___ (04) Building, billboard, etc.
- ___ (05) Trees, crops, vegetation
- ___ (06) Moving vehicle (including load)
- ___ (07) Splash or spray of passing vehicle
- ___ (08) Parked vehicle
- ___ (09) Other object not classifiable above:

Swerving or Loss of Control Due to:

- ___ (20) Severe crosswind
- ___ (21) Wind from passing truck
- ___ (22) Slippery surface
- ___ (23) Avoiding debris or objects in roadway
- ___ (24) Ruts, holes, bumps in roadway
- ___ (25) Avoiding animals in roadway
- ___ (26) Avoiding vehicle in roadway
- ___ (27) Avoiding pedestrian, pedalcyclist, other nonmotorist in roadway
- ___ (28) Avoiding standing water, snow, oil/slick or ice patch on roadway

Roadway Features:

- ___ (30) Inadequate warning of exits, lanes narrowing, traffic controls, etc.
- ___ (31) Pavement marking obscured or absent
- ___ (32) Surface washed out (caved in, road slippage)
- ___ (33) Shoulder too low or high
- ___ (34) Inadequate construction or poor design of roadway, bridge, etc.
- ___ (35) Vehicle unattended in roadway
- ___ (98) Other: _____
- ___ (99) Unknown

(63) 97 98
 (64) 99 100
 (65) 101 102

COMPLETED BY TEAM

- 1. Primary Sampling Unit Number 1 2
- 2. Case Number - Stratification 3 4 5 6
- 3. Record Number 7
- 4. Transaction Code 8
- 5. Version Number 9
- 6. Investigator I.D. Number 10

DRIVER INTERVIEW

- 7. Vehicle Number 11 12
- 8. Driver's Occupant Number 13 14
(NOTE. If no driver was present code "00")
- 9. Type of Driver Interview Data Obtained
 - (0) Driver not present
 - (1) No data obtained
 - (2) Driver history only
 - (3) Accident circumstances only
 - (4) Driver history and accident circumstances 15
- 10. Source of Driver Data
 - (0) Driver not present
 - (1) No data obtained
 - (2) Driver
 - (3) Other occupant
 - (4) Relative or friend
 - (5) Eyewitness
 - (6) Combination of 3, 4 or 5
 - (7) Other (specify) _____ 16

- 11. Result
 - (00) Driver not present
 - (01) Unable to contact or locate
 - (02) Hit and run
 - (03) Fatal-surrogate not available
 - (04) In intensive care-surrogate not available
 - (05) Out of State resident
 - (06) Refused interview for other than on advice of attorney or insurance company (specify) _____
 - (07) Insurance company refusal
 - (08) Attorney refusal or litigation
 - (09) Other (specify) _____
 - (10) No return of letter questionnaire
 - (11) Return of letter questionnaire (completed)
 - (12) Partial or complete interview 17 18
- 12. Date Driver Interview Completed 19 20 21 22 23 24
- 13. Completing Person 25
- 14. Reason Official Driver Records are not Obtainable
 - (0) Driver not present
 - (1) Records obtained
 - (2) Hit and run driver
 - (3) Records not found
 - (4) Driver not licensed
 - (5) License number incorrect
 - (6) No information on driver
 - (7) Out of state and foreign drivers
 - (8) To be updated
 - (9) Record not received before file closed 26

COMPLETED BY ZONE CENTER

- 15. Date Official Driver Record Update Received 27 28 29 30 31 32
- 16. Reviewed By 33 34



DRIVER UPDATE RECORD

This section must be completed prior to initial case submission

<p>1. Primary Sampling Unit Number 1 2</p> <p>2. Case Number—Stratification 3 4 5 6</p> <p>3. Record Number 4 7</p> <p>4. Transaction Code 2 8</p> <p>5. Version Number 7 9</p> <p>6. Investigator I.D. Number 10</p> <p>7. Vehicle Number 11 12</p>	<p>DRIVER'S NAME: _____</p> <p>ADDRESS: _____</p> <p>State Driver License No.: _____</p> <p>Date of Birth: ____/____/____</p> <p style="text-align: center;">(Delete before submission)</p>
---	---

Circle the number of each variable to be updated and complete upon receipt of this data
[or reason data not obtained (see response for log variable 14) ____]

33. Alcohol Test Results	48 49
34. License Source	50
35. Compliance With License Restrictions	51
36. Driver License Status (For this vehicle)	52
37. Driver License Type Compliance	53
38. Driver License Restriction	54
39. Additional Driver License Restriction	55
40. Previous Speeding Convictions	56
41. Previous Other Harmful Moving Violations Convictions	57
42. Previous Driving While Intoxicated Convictions	58
43. Previous Recorded Suspensions and Revocations	59
44. Previous Recorded Accidents	60

SOURCE OF DATA ON WHICH UPDATE IS BASED

ATTACH TO THIS FORM ANY SUPPORTING OFFICIAL RECORDS FOR THIS DRIVER

Variable Name: Investigator I.D. Number

Format: 1 column - numeric

Beginning
Column 10

Element Values:

Level 1 Range: 1 through 9

Source: Zone center.

Remarks:

The person who was primarily responsible for the completion of the Driver Form shall enter his/her unique number.

Each investigator's unique number is assigned by the PSU's Zone Center.

This variable is a mandatory variable and cannot be changed.

Variable Name: Vehicle Number

Format: 2 columns - numeric

Beginning
Column 11

Element Values:

Level 1 Range: 01 through 30

Source: Investigator determined--inputs include police report and driver interview.

Remarks:

For each and every Vehicle Form, there must be an accompanying Driver Form.

The value coded here must be the same as that coded for the vehicle in which this driver is associated.

This variable is a mandatory variable and cannot be changed.

Variable Name: Number of Occupants This Motor Vehicle

Format: 2 columns - numeric

Beginning
Column 13

Element Values:

Level 2 Range: 00 through 10

99 Unknown

97 97 or more

Source: Primary source is driver interview, secondary sources include the police report and an occupant interviewee, witnesses other than any occupant interviewee.

Remarks:

This variable tells the system how many occupants (including the driver) were present in this driver's vehicle. If the actual number present is unknown, then "99" (Unknown) should be coded.

Code "99" (Unknown) is used in the case of a hit-and-run vehicle--unless reliable evidence clearly establishes the number of occupants present.

Variable Name: Driver Presence in Vehicle

Format: 1 column - numeric

Beginning
Column 15

Element Values:

- 1 Driver present
- 2 Driver not present

Source: Investigator determined--inputs include the police report and any driver interviews or person interviews.

Remarks:

This variable serves as a flag to identify driverless motor vehicles in transport. If no driver was physically in the vehicle at the time it was struck, then code "2" (Driver not present) should be coded. In addition, variables D10 through D44 and D60 through D65 should be left "blank". If no driver was present, then no Occupant Form for this driver is required. On the other hand, a code of "1" implies that an Occupant Form will be present for this driver.

If this motor vehicle was a "hit-and-run" vehicle, as defined on the Accident Form (A16), then the driver was present ("1").

This variable is a mandatory variable and cannot be changed.

Variable Name: Months Driving Experience This Class of Vehicle

Format: 2 columns - numeric

Beginning
Column 16

Element Values:

Level 1 Range: 01 through 61, 99
Code actual months of previous driving experience up to 60.
Blank - Driver not present (D09)
61 Greater than five years
99 Unknown

Source: Driver interview.

Remarks:

"Blank" indicates that no driver was present.

This variable is used to report the driver's previous driving experience in the class of vehicle the driver was operating at the time of the accident. Class of vehicle refers to general vehicle types (i.e., passenger car, light truck, straight truck, truck-tractor, bus, motorcycle, or special vehicle). These categorizations are not necessarily mutually exclusive. For example, a driver employed to operate a large limousine (special vehicle: V14 = 13, Body Type) is involved in an accident. This driver normally operates a standard size passenger car. In this instance, the investigator must not consider the special vehicle as a class differing from the driver's other driving experience. A professional truck driver, on the other hand, involved in an accident while operating the family's personal passenger car would certainly require the investigator to separate this driver's professional and personal driving experience.

The class "passenger car" includes vehicles ranging from mini-cars through full-size luxury cars.

The class of the vehicle is the sole criterion for this variable; attached trailers, additional cargo, etc., have no affect in the assessment.

The driver driving experience reported is "on-road" driving experience. For example, the driver has 5 years of off-road motorcycle riding experience, but has only been operating an on-road motorcycle for one month. One month (code "01") should be reported. Similarly, the driver has driven a tractor on the farm for 4 years; however, only in the last six months has he/she been allowed to drive on the highway. Code "06" should be used.

Variable Name: Estimated Mileage This Vehicle

Format: 3 columns - numeric

Beginning
Column 18

Element Values:

Level 1 Range: 001 through 997, 999
Miles to the nearest 100
Blank - Driver not present (D09)
001 Less than 150 miles
997 99,650 miles or more
999 Unknown

Source: Driver interview.

Remarks:

"Blank" indicates that no driver was present.

"This vehicle" refers to the vehicle in the accident. The intent is to measure the driver's cumulative driving experience for the specific vehicle being driven at the time of the accident. For example, if a person drove various standard passenger vehicles over a period of five years so as to accumulate approximately 60,000 total miles, but was involved in an accident while driving another standard passenger vehicle for the first time, the total estimated mileage this vehicle would equal only that mileage accumulated during the trip in which the accident occurred. Specifically excluded is any subsequent mileage accumulated in "this vehicle" post-accident.

Variable Name: Total Mileage All Vehicles (Past Twelve Months)

Format: 3 columns - numeric

Beginning
Column 21

Element Values:

Level 1 Range: 001 through 997, 999
Miles to the nearest 100
Blank - Driver not present (D09)
001 Less than 150 miles
997 99,650 miles or more
999 Unknown

Source: Driver interview.

Remarks:

"Blank" indicates that no driver was present.

The mileage recorded should include the cumulative mileage driven, during the twelve months prior to the accident date, of all motor vehicles driven by this driver.

For new drivers who have not driven for twelve months, determine their miles per month average and multiply by twelve.

Variable Name: Type of Operation or Carrier
(Vehicle Over 10,000 lbs. GVWR)

Format: 1 column - numeric

Beginning
Column 24

Element Values:

- Blank - Driver not present (D09)
- 0 Noncommercial or not vehicle over 10,000 lbs. GVWR
[or an operator not meeting one of the following descriptions]
 - 1 For hire/common carrier
 - 2 For hire/contract carrier
 - 3 Private carrier of property or passengers
 - 4 Carrier of ICC exempt commodities
 - 5 Foreign carrier
 - 6 Carrier of migrant workers
 - 7 U.S. mail carrier
 - 8 Other (specify)
 - 9 Unknown

Source: Primary source is driver interview; secondary sources include the police report or an employer [Reference: Public Law 95-473, October 17, 1978].

Remarks:

"Blank" indicates that no driver was present.

The type of carrier for which a driver drives inferentially indicates the degree of preemployment screening and training he is likely to have undergone--hence the interest in this question. This is especially true of carriers subject to BMCS regulations.

Code "0" (Noncommercial. . .) for any operation being conducted for private nonbusiness purposes; that is, the driver and vehicle under consideration were not being operated for hire or in furtherance of a business enterprise.

Code "1" (For hire/common carrier) is a carrier presenting himself/herself to the general public as a provider of motor vehicle transportation for compensation over regular or irregular routes, or both.

Code "2" (For hire/contract carrier) is the same as a common carrier except that the carrier provides motor vehicle transportation for compensation under continuing agreements with a person or a limited number of persons. These definitions apply to carriers of property and carriers of passengers.

Variable Name: Type of Operation or Carrier (cont'd.)

Code "3" (Private carrier of property or passengers) means a person other than a common or contract carrier that is transporting property by motor vehicle and:

- (1) the person is the owner, lessee, or bailee of the property being transported; and,
- (2) the property is being transported for sale, lease, rent, or bailment, or to further a commercial enterprise.

Code "4" (Carrier of ICC exempt commodities) is used when the carrier would ordinarily be considered a common or contract carrier if it were not for the commodities being hauled. These commodities are exempted from ICC (Interstate Commerce Commission) economic regulation, hence the term exempt hauler. The list of commodities is exhaustive and is not printed here. They tend to fit into one of the following categories:

- (1) ordinary livestock
- (2) agricultural or horticultural commodities
- (3) cooked or uncooked fish, fresh or frozen (unprocessed) shellfish, and other unprocessed food products
- (4) newspapers

Code "5" (Foreign carrier) is used for any common or contract carrier owned by or registered as a foreign carrier (e.g., Canada, Mexico, etc.) which operates in the United States.

Code "6" (Carrier of migrant workers) is used for any carrier who is transporting migrant workers.

Code "7" (U.S. mail carrier) is used for any contract carriers who work for the United States Postal Service.

Code "8" (Other) includes any other type of operation not included in one of the definitions above.

The following definitions are provided to assist your understanding.

agricultural: pertaining to the production of crops, livestock, or poultry.
bailee: the person to whom a bailment is made.

bailment: a delivery of personal property by one person to another in trust for a specific purpose, with a contract, expressed or implied, that the trust shall be faithfully executed and the property returned or duly

DRIVER FORM

D13

(3)

Variable Name: Type of Operation or Carrier (cont'd.)

accounted for when the special purpose is accomplished, or kept until the bailer reclaims it.

bailor: the maker of a bailment; one who delivers personal property to another to be held in bailment.

horticultural: pertaining to the cultivation of flowers, fruits, vegetables or ornamental plants in relation to a garden, orchard, or nursery.

Variable Name: Federal Safety Regulated

Format: 1 column - numeric

Beginning
Column 25

Element Values:

Blank - Driver not present (D09)

0 Noncommercial or not vehicle over 10,000 lbs. GVWR

1 Motor carrier not subject to U.S. DOT (BMCS) regulations
Motor carrier subject to U.S. DOT (BMCS) regulations

2 Intercity operation

3 Local pickup or delivery

9 Unknown

Source: Primary source is driver interview; secondary sources include the police report or an employer.

Remarks:

"Blank" indicates that no driver was present.

The term "federal safety" refers to any agency of the federal government that issues regulations which promote traffic safety. The primary agency of concern, at this time, is the Bureau of Motor Carrier Safety (BMCS). In general, BMCS regulates the operation of carriers who are engaged in interstate or foreign commerce. It should be emphasized that this variable measures whether or not the carrier is regulated, rather than the driver; although, the driver is the primary source of information regarding the carrier.

Interstate commerce is the movement of goods from one state to another. In general, this means that a shipment of goods originates in one state and terminates in another. Any movement of those goods that is a part of a principal shipment is interstate commerce and subject to BMCS regulation. The carrier involved in the accident you are investigating, need not have crossed a state line so long as the carrier is a component part of the principal movement of the goods. For example, if a carrier hauls goods from a railroad facility to a trucking facility, from which they are subsequently shipped, then this carrier is involved in interstate commerce even if the carrier never leaves the city limits. This carrier's trip was a part of a principal movement of goods from one state to another. On the other hand, a carrier who picks up goods from a facility which was the destination for the principal trip of those goods, and delivers them for use or sale is not involved in interstate commerce. Rather, this carrier is involved in local pickup and delivery.

Variable Name: Federal Safety Regulated (cont'd.)

In summary, if a carrier is transporting goods as a part of a continuous move from one state to another, then the carrier is engaged in interstate commerce. Carriers who operate solely within the commercial zone of a municipality or large city (generally pickup and delivery drivers) are exempt from BMCS regulations.

The investigator should first determine if the driver's vehicle was over 10,000 lbs. GVWR. Second, determine if the driver was engaged in a commercial enterprise (D13, Type of Operation or Carrier, equals "1" through "8"). If the answer to either of these questions is "no", then code "0" (Noncommercial or not vehicle over 10,000 lbs. GVWR).

If the answer to both preceding questions is "yes", next determine if the motor carrier is DOT (BMCS) regulated. Investigators should ask the driver if he/she is DOT (BMCS) regulated. If the driver indicates that he/she knows the answer, then proceed accordingly. If the driver is unsure, ask the driver these questions.

- (1) Do you have to have a DOT (ICC) physical?
- (2) Do you have a DOT card?
- (3) Do you keep driver logs?
- (4) Do you have a bill of lading?

If the answer is "yes" to any of these questions, presume that the carrier is DOT (BMCS) regulated. In addition to the driver, the vehicle may give you some clues. If during your inspection you see the following: ICC #...# or MC #...#, then you have evidence that the carrier is DOT (BMCS) regulated.

If you determine that the carrier is not DOT (BMCS) regulated, code "1" [Motor carrier not subject to U.S. DOT (BMCS) regulations]. If you determine the carrier is regulated, next inquire as to whether this particular trip was part of an intercity operation. That is, ask the driver if he/she was moving goods from city-to-city, or making a local pickup or delivery. Apply the principals given above, and make the best fit. If the goods are being transported between cities or towns, code "2" (Intercity operation). If making local pickups or deliveries best describes this driver's trip, code "3" (Local pickup or delivery).

Use code "9" (Unknown) if: (1) the GVWR of the vehicle is unknown, (2) it is unknown whether or not this driver/vehicle was engaged in a commercial enterprise, or (3) you cannot determine if the carrier is DOT (BMCS) regulated. If you determine the carrier was regulated, make every attempt to choose from codes "2" (Intercity operation) and "3" (Local pickup or delivery).

The flowchart which follows depicts this questioning process.

Variable Name: Driver's Classification
[Vehicle Over 10,000 lbs. GVWR]

Format: 1 column - numeric

Beginning
Column 26

Element Values:

Blank - Driver not present (D09)
0 Noncommercial or not vehicle over 10,000 lbs. GVWR

[Commercial]

1 Full time employee
2 Part time employee
3 Owner operator
4 Leased (from labor contractor)
8 Other (specify)
9 Unknown

Source: Primary source is driver interview; secondary sources include the police report or an employer.

Remarks:

"Blank" indicates that no driver was present.

Code "0" (Noncommercial or not in vehicle 10,000 lbs. GVW or greater) if the driver is in a motor vehicle not being operated on this trip for hire or in furtherance of a commercial enterprise, or if the vehicle is not equal to or greater than 10,000 lbs. GVWR.

The key distinction between commercial and noncommercial is whether the vehicle (or its most immediate operator) is being operated for gain. Therefore, a county truck would not be commercial, but a telephone company truck would be; or a school bus operated by the public school system would not be commercial, but a bus operated by a contractor to the school system while supplying the same service would be. Also, busses operated by private schools would be considered commercial because the service is included in the educational contract (for gain).

Code "1" (Full time employee) if the driver in any period of seven (7) consecutive days is employed or used as a driver solely by a single employer. If a person works less than a full work week but has no other job and does not work for another employer, the driver is considered full-time. Excluded, however, are seasonal employees.

Variable Name: Driver's Classification (cont'd.)

Code "2" (Part time employee) if the driver drives for a motor carrier on a temporary (short term) or seasonal basis; works for a multiple number of carriers, but is not an employee of a labor contractor (typically this might include drivers working out of a union hiring hall or drivers "off the street"), or if the driver works part of a work week for the carrier but also has another job with another employer.

Code "3" (Owner operator) if the driver owns the truck and/or trailer that was involved and either is acting as an independent motor carrier himself/herself or has leased himself/herself and the vehicle to a motor carrier.

Code "4" [Leased (from labor contractor)] if the driver is the employee of a labor contractor, who in turn, leases the services of the driver to a motor carrier. Under these arrangements, the carrier usually exercises dispatch control over the driver, but the driver's pay, vacation, sick leave and other fringe benefits are the responsibility of the labor contractor that employs him.

Code "8" (Other) includes any other category of commercial driver not covered above.

DRIVER VIEW OF TOTAL ACCIDENT CONTACT SEQUENCE

Record all impacts in the sequence that they occurred. For each impact, record: [a] its number, [b] the object contacted (from above codes), [c] the number of the impacting vehicle, [d] the location of the impact on that vehicle (from above codes), and [e] the vehicle's orientation (from above codes). If the impact involved another vehicle, list [f] its number, [g] location of the impact on the vehicle and [h] the vehicle's orientation. List up to six impacts. Place a check mark in the box for "object contacted" for that impact to indicate it was with another motor vehicle. If a vehicle is stopped at impact, use code 7 for Vehicle Orientation and write in "stopped", "parked", etc.

Have the driver sketch the accident sequence. For telephone interviews the investigator must sketch the accident sequence as described by the driver. It is not necessary that all the drivers involved in a multicar/multi-impact accident know the actual sequence of impacts. It is important to get each driver to describe how the accident occurred; each driver could provide a new insight into the dynamics of the collision. Hence, the sketch drawn in each Driver Form should reflect the perceptions of that particular driver, and not the investigator's overall determination, of the actual accident configuration.

Very few accidents will involve more than six impacts, but for those that do, the investigator must select the six most severe impacts from the total number of impacts and then list them in sequence. (Example: If there are a total of nine (9) impacts out of which the 3rd, 6th, and 7th impacts are minor compared to the rest, the investigator would list impacts 1, 2, 4, 5, 8, and 9 as per the driver's narration of sequence.) In these cases it is recommended that the investigator record the additional impacts on the reverse side of page 3 of the Driver Form and annotate as to his/her basis for selecting the six (6) most severe impacts. Although in the above example there will be nine (9) common impacts, each involved driver may not have knowledge of all nine (9) separate and distinct impacts.

Also, it should always be kept in mind that the common impact number is unique to an accident and not to a driver/vehicle.

Example: An accident involving four vehicles

Sketches and information of the accident sequence as recorded from each driver interview are shown in the next six pages. These sketches and impacts are recorded based on information given by each driver. A final accident sequence diagram is shown in Exhibit 2, based on scene inspection, vehicle inspections, and driver interviews. Using this information the investigator determines the sequence of impacts (impact numbers) and records the

DRIVER FORM

Sub/D15

(2)

Form Pages 3 & 4

Assume you got the following information from each driver's interview.

Driver #1: The driver tells you that he hit two trees before his vehicle was hit by another vehicle (vehicle #2) which made him spin around into the path of vehicle #3 and was hit in the left side by vehicle #3. The other vehicle (vehicle #2) then hit vehicle #4 head-on.

Driver #2: This driver tells you that vehicle #1 skidded into his path and caused his vehicle to hit vehicle #1 in the right side. Then his vehicle (#2) skidded into impact with vehicle #4 head-on. He then tells you that he heard vehicle #1 impacting vehicle #3.

Driver #3: This driver gives you a similar type of description as driver #2 except she feels that vehicle #1 hit her vehicle before vehicle #2 impacted vehicle #4.

Driver #4: This driver tells you that all he knows about the accident is that vehicle #2 hit his vehicle head-on.

DRIVER FORM

Sub/D15

(7)

Form Pages 3 & 4

FINAL DIAGRAM BASED ON ALL INTERVIEWS, POLICE
AND SCENE INSPECTION

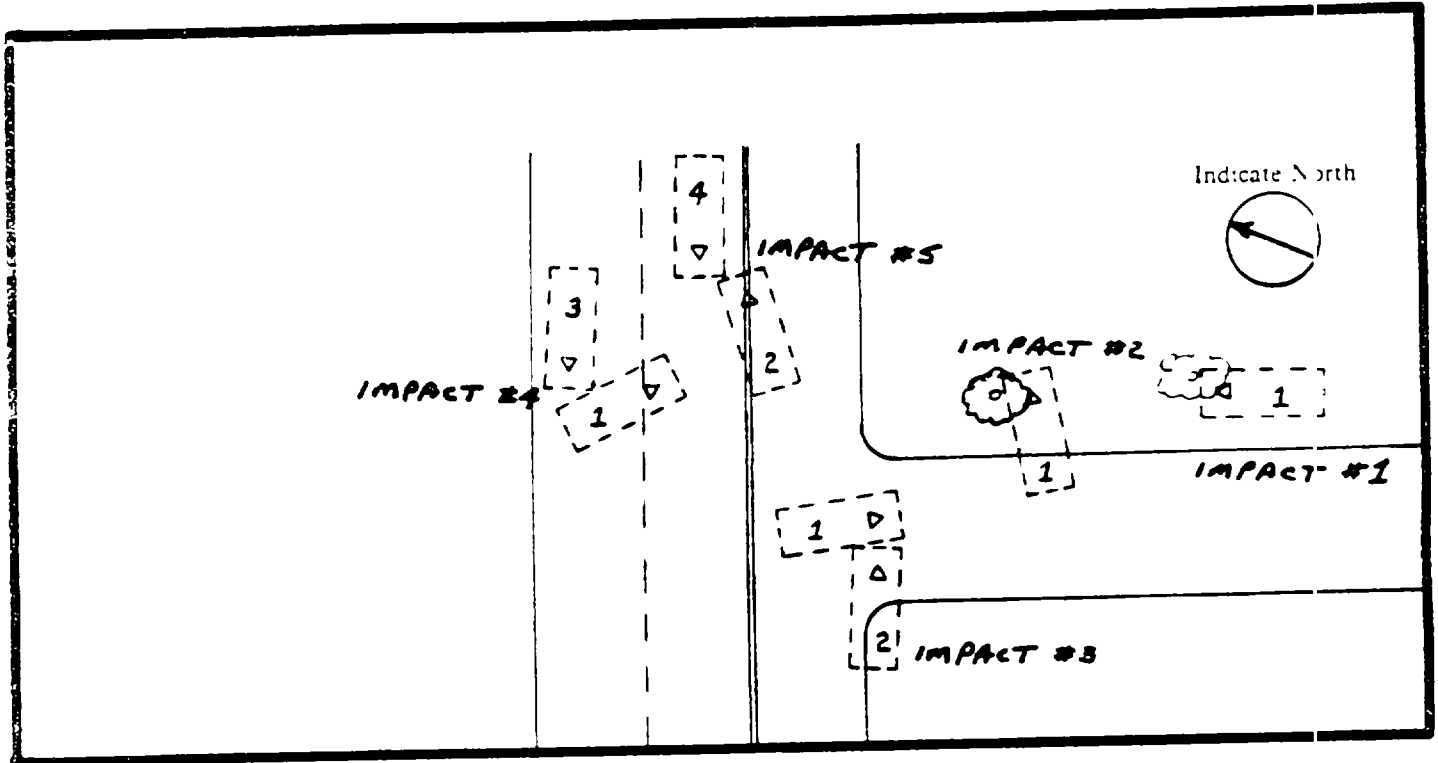

Based on final accident dynamics as determined by the investigator drawing on his/her knowledge of scene inspection, vehicle inspection, police report and interviews, the actual impact sequence [Final Impact Sequence (Final Impact Sequence (Investigator))] is determined as shown above and entered in corresponding Driver Forms. (See next page.)

Variable Name: Driver Education

Format: 1 column - numeric

Beginning
Column 27

Element Values:

Blank - Driver not present (D09)

0 No formal driver training

1 In training at time of accident

2 High school driver training

3 Commercial driver training

8 Other formal driver training (e.g., college, military, etc.)

9 Unknown

Motorcycle Driver Training

0 No formal driver training

1 In training at time of accident

6 Motorcycle driver training

9 Unknown

Heavy [and Medium] Vehicle Driver Training (> 10,000 lbs. GVWR)

0 No formal driver training

1 In training at time of accident

4 Truck driver training school

5 Motor carrier program - On-the-Job-Training

7 Vocational training (CETA, Job Corp, other government sponsored training, etc.)

8 Other formal driver training (e.g., college, military, etc.)

9 Unknown

Source: Driver interview.

Remarks:

"Blank" indicates that no driver was present.

Only basic driver training is considered for this variable--refresher courses (i.e., basic skills) are included. Specifically excluded from consideration are special or advanced training type courses (e.g., special training for elderly, accident avoidance type training (including traffic schools), or any other advanced type of training). Advanced means that the training was beyond the basic training provided for the class of driver under consideration.

What type of vehicle the driver was operating in this accident determines his/her Driver Education (D16) is coded.

Variable Name: Driver Education (cont'd.)

There are three specific classes of drivers considered. These are: passenger vehicle drivers (including light trucks and vans), motorcycle drivers, and heavy truck drivers (GVWR over 10,000 lbs.).

The table below shows which attributes of this variable apply to the different driver classes.

Type	V14	D09	D16
Driver Not Present	Any	2	Blank
Automobile or Light Truck Driver Training	01-13,40-42,48-56,58,59,69,80-82,88	1	0-3,8,9
Motorcycle Driver Training	20,21,28,29	1	0,1,6,9
Heavy (and Medium) Vehicle Driver Training	30-32,38,39,70-75,77-79,81,83	1	0,1,4,5,7-9
Unknown	89,99	1	9

The type of driver training that heavy vehicle and motorcycle drivers receive is of particular interest. If the driver is driving a heavy vehicle then this variable measures the type of training the driver has received in vehicles over 10,000 lbs. GVWR. Since codes "4" (Truck driver training school), "5" (Motor carrier program - On-the-Job-Training), and "7" [Vocational training (CETA, Job Corp, other government sponsored training, etc.)] are assumed to use heavy vehicles, these codes are not applicable for motorcycle drivers or automobile or light truck drivers. Similarly codes "2" (High school driver training) and "3" (Commercial driver training) apply only to automobile or light truck drivers, and code "6" (Motorcycle driver training) applies only to motorcycle drivers. Code "8" (Other formal driver training (e.g., college, military, etc.) applies only to automobile or light truck drivers and heavy vehicle drivers. Codes "0" (No formal driver training) and "1" (In training at time of accident) must be applied within the context of the driver's status.

Code "0" (No formal driver training) should be used if a driver received no driver training for the class vehicle he/she was driving at the time of the accident.

Code "1" (In training at time of accident) means that the driver must have been enrolled in a formal driver training class when the accident occurred.

Code "3" (Commercial driver training) refers to organizations that provide passenger type vehicle driver training for a profit. It excludes nonprofit organizations, employee training programs, and rehabilitative programs which use passenger type vehicles. These should be coded as "8" (Other formal driver training).

DRIVER FORM

D16

(3)

Variable Name: Driver Education (cont'd.)

Code "4" (Truck driver training school) is used if the heavy [and medium] vehicle driver received training at a "school" (e.g., American Truck Driving School) established for the purpose of training drivers in the use of vehicles over 10,000 lbs. GVWR. The drivers in this school must not all work for the same employer.

Code "5" (Motor carrier program--On-the-Job-Training) is used when the heavy [and medium] vehicle driver is provided with on-the-job type training [whether formal (e.g., classroom) or informal] by the motor carrier that employs him/her.

If a heavy [and medium] vehicle driver attended a driver training school and received on-the-job-training from his/her employer, then code the type of training that occurred most recently. Similar coding would take place for an automobile driver who took both high school and college driver training courses.

Code "6" (Motorcycle driver training) refers to any formal training for driving a motorcycle.

Variable Name: Frequency Driving Road

Format: 1 column - numeric

Beginning
Column 28

Element Values:

- Blank - Driver not present (D09)
- 1 Daily
- 2 Weekly
- 3 Monthly
- 4 Less than once a month
- 5 First time on road
- 9 Unknown

Source: Driver interview.

Remarks:

"Blank" indicates that no driver was present.

The following decision rules apply if the driver's response is given in units different than those listed.

Daily = \geq 3 times a week

Weekly = $<$ 3 times a week but \geq 3 times a month

Monthly = 1 or 2 times a month

Less than once a month = less than once a month

First time on road = first time on road

DRIVER FORM

D18
D19
D20

Variable Name: D18 - Last Action Prior to Avoidance Maneuvers
D19 - Second to Last Action Prior to Avoidance Maneuvers
D20 - Third to Last Action Prior to Avoidance Maneuvers

Format: 2 columns - numeric

Beginning
Column 29
31
33

Element Values:

- Blank - Driver not present (D09)
- Movements essentially straight ahead
- 00 No actions
- 01 Moving straight, details unknown, or no maneuvers
- 02 Straight ahead in proper direction, including curves in roadway
- 03 Overtaking other vehicle on left, left of center line
- 04 Overtaking other vehicle on left, right of center line (includes one-way roadways without center lines)
- 05 Overtaking another vehicle on right
- 06 Straight ahead in left turn lane
- 07 Straight ahead in right turn lane
- 08 Changing lanes to left
- 09 Changing lanes to right
- 10 Merging from left (roadway narrows on left)
- 11 Merging from right (roadway narrows on right)
- 12 On wrong side of roadway
- 13 In wrong direction on one-way roadway
- 14 Swerving to left
- 15 Swerving to right
- 16 Slowing or stopping
- 17 Skidding longitudinally
- 18 Skidding laterally
- 19 Spinning or yawing
- 20 Jackknifing
- 21 Stopped in traffic
- 22 Starting from stop
- 23 Increasing speed
- Turning movements
- 30 Turning, details unknown
- 31 Left from left turn bay or special lane
- 32 Left from left (proper) lane
- 33 Left from other lane, legal
- 34 Left from other lane, illegal
- 35 Left from unknown lane
- 36 U-turn

DRIVER FORM

D18
D19
D20
(2)

Variable Name: D18 - Last Action Prior to Avoidance Maneuvers (cont'd.)
D19 - Second to Last Action Prior to Avoidance Maneuvers (cont'd.)
D20 - Third to Last Action Prior to Avoidance Maneuvers (cont'd.)

- 37 Right from special lane
- 38 Right from right (proper) lane
- 39 Right from other lane, legal
- 40 Right from other lane, illegal
- 41 Right from unknown lane
- Entering traffic lane
- 50 Entering traffic lane, details unknown
- 51 From entrance ramp on left
- 52 From entrance ramp on right
- 53 From shoulder on left
- 54 From shoulder on right
- 55 From parking space at left curb
- 56 From parking space at right curb
- 57 From driveway on left
- 58 From driveway on right
- Leaving traffic lane
- 60 Leaving traffic lane, details unknown
- 61 To exit ramp on left
- 62 To exit ramp on right
- 63 To shoulder on left
- 64 To shoulder on right
- 65 To parking space at left curb
- 66 To parking space at right curb
- 67 To driveway on left
- 68 To driveway on right
- Parking on or adjacent to traffic lane
- 70 Parking, details unknown
- 71 On left shoulder
- 72 On right shoulder
- 73 At left curb
- 74 At right curb
- 75 In traffic lane (on roadway) on left
- 76 In traffic lane (on roadway) on right
- 77 Double parking on left
- 78 Double parking on right
- Miscellaneous movements
- 81 Backing in roadway
- 82 Backing from parking on left
- 83 Backing from parking on right
- 84 Backing across traffic
- 85 Backing on shoulder
- 86 Vehicle pushed by other vehicle

DRIVER FORM

D18

D19

D20

(3)

Variable Name: D18 - Last Action Prior to Avoidance Maneuvers (cont'd.)
D19 - Second to Last Action Prior to Avoidance Maneuvers
(cont'd.)
D20 - Third to Last Action Prior to Avoidance Maneuvers
(cont'd.)

- 87 Vehicle pushed by pedestrian
- 88 Not in motion (parked or standing - driver in vehicle)
- 89 Loss of air pressure in tire (blowout or other)

- 98 Other (Specify)
- 99 Unknown

Source: Investigator determined--inputs include the driver interview, police report, and the scene inspection.

Remarks:

"Blank" indicates that no driver was present.

Action prior to avoidance maneuver means the driver's movement of the vehicle either (1) just prior to his/her realization of an impending danger, or (2) just prior to impact if the driver either (a) took no action or (b) had no time to attempt any evasive maneuvers.

Code the driver's actions (up to three) in reverse chronological order starting with (D18) his realization of an impending danger and working backwards in time. (Note that D18 happens after D19, and D19 happens after D20.)

In an attempt to clarify the terms "impending danger" and "just prior to impact," an understanding of the intent for this variable must be considered. Analysts are attempting to identify the actions executed by a driver prior to the recognition of an imminent impact. In other words, they are concerned with the time frame which immediately precedes the Impact/Avoidance Maneuver sequence.

As an example: a driver traveling along a highway suddenly realizes the traffic in front of him has come to a stop. The driver applies the brake and attempts to steer right, but impacts the stopped vehicle. For the purposes of this variable, the driver's action prior to realization of the impending impact should be coded. In this case, D18 should be coded "02" (Straight ahead in proper direction), D19 and D20 should be coded "00" (No actions).

To illustrate the changeable nature of this variable, the above example has been changed slightly. The driver of the subject vehicle avoids the rear end collision by departing the right side of the roadway. However, the

DRIVER FORM

D18
D19
D20
(4)

Variable Name: D18 - Last Action Prior to Avoidance Maneuvers (cont'd.)
D19 - Second to Last Action Prior to Avoidance Maneuvers (cont'd.)
D20 - Third to Last Action Prior to Avoidance Maneuvers (cont'd.)

Vehicle impacts a utility pole. The driver was not aware that a pole impact would occur and subsequently did not attempt any evasive maneuvers prior to the pole contact. In this situation, the last three actions taken by the driver before the collision with the pole should be coded. The recommended coding for this example is: D18=64 (to shoulder on right), D19=15 (swerving to right), and D20=16 (slowing or stopping).

A relationship exists between these variables and D21, Attempted Avoidance Maneuver (Pre-Crash).

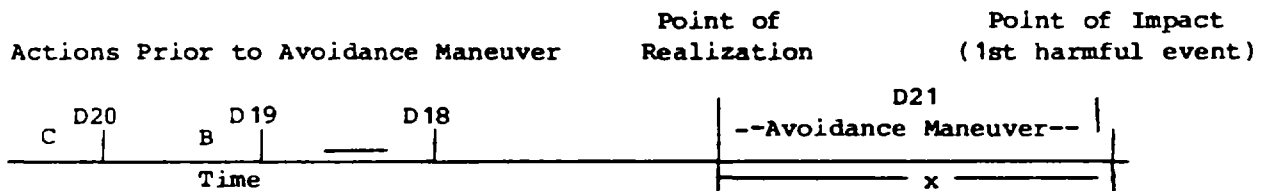

Drivers' statements about what occurred just prior to impact can roughly be grouped into three categories. First, there are drivers who say that "I never saw him/her; I didn't know I was going to be in an accident until I was hit." For these drivers "x" equals zero. No realization occurred. Second, some drivers say that they saw the impending impact coming but state that "I didn't have time to do anything." For these drivers "x" is greater than zero but still very small. However, realization occurred, but D21 for this category as well as the preceding one is coded "00" (No avoidance actions). In the third category are those drivers who realized the impending impact and had sufficient time to do something (independently of whether or not they did)--"x" is sufficiently large.

What drivers do after realization is coded on D21, Attempted Avoidance Maneuver (Pre-Crash); what this driver was doing up to the point of realization is coded on these variables. The points "A", "B", and "C" indicate the reverse chronological order of prior actions. In almost all cases D18, Last Action Prior to Avoidance Maneuvers, should be coded with some action [i.e., not "00" (No actions)] even if the action was no more complicated than traveling straight ahead ("02"). Further, if there are less than three actions prior to avoidance maneuvers, close out these variables with zeros. For example, if the investigator determines the driver was just driving down the road and was struck, the correct coding would be: D18=02, D19=00 and D20=00.

DRIVER FORM

D18
D19
D20
(5)

Variable Name: D18 - Last Action Prior to Avoidance Maneuvers (cont'd.)
D19 - Second to Last Action Prior to Avoidance Maneuvers (cont'd.)
D20 - Third to Last Action Prior to Avoidance Maneuvers (cont'd.)

If very little is known concerning the driver's actions prior to the accident which requires the use of the element "...details unknown" then D19 and D20 should be coded "99" (unknown).

Do not code "definitely known maneuvers" after the use of the element "...details unknown." However, a "...details unknown" element can be used following a definitely known element, but two (2) "...details unknown" should not be used. Do not code "...details unknown" from a category which has already been coded with a "definitely known" element (i.e., "01" should not be used if "02" was previously selected).

The "unknown" (99) element will always follow the use of a "...details unknown" element. The only exception would be if "...details unknown" was coded for D20.

DRIVER FORM

D18
D19
D20
(6)

Variable Name: D18 - Last Action Prior to Avoidance Maneuvers (cont'd.)
D19 - Second to Last Action Prior to Avoidance maneuvers (cont'd.)
D20 - Third to Last Action Prior to Avoidance Maneuvers (cont'd.)

The following table is provided as a guide to the proper coding conventions.

	D18	D18	D18	D18
D18	D≠00	D≠00	P	U
D19	D	P	U	U
D20	D, P, or U	U	U	U

Categories:

D = Definitely known action
P = Partially known action
U = Unknown action

D = Codes 00, 02 through 23, 31 through 41, 51 through 58, 61 through 68, 71 through 78, and 81 through 89, and 98.
P = Codes 01, 30, 50, 60, and 70.
U = Code 99.

Use of the word "driveway" in codes "57", "58", "67", or "68" means a driveway that otherwise would not be a NASS roadway--see Remarks section for A24, Relation to Junction page (5), paragraphs 5 and 6. If the driveway would be considered a NASS roadway then treat entrances or exits as "turning movements" (codes "30"- "41").

Variable Name: Attempted Avoidance Maneuver (Pre-Crash)

Format: 2 columns - numeric

Beginning
Column 35

Element Values:

Blank - Driver not present (D09)
00 No avoidance actions
01 Braking (no lockup)
02 Braking (lockup)
03 Pumping brakes (modulation)
04 Releasing brakes
05 Steering left
06 Steering right
07 Braking and steering left
08 Braking and steering right
09 Accelerating
10 Accelerating and steering left
11 Accelerating and steering right
98 Other action (specify)
99 Unknown

Source: Investigator determined--inputs include the driver interview, police report, and the scene inspection.

Remarks:

"Blank" indicates that no driver was present.

Attempted avoidance maneuvers (pre-crash) are movements/actions taken by the driver to avoid the impending crash after realization of an impending danger but before actual crash (impact). See discussion on preceding page.

Code the attribute which best describes the actions taken by the driver.

Code "00" (No avoidance actions) is used whenever the driver did not have time to attempt any evasive (pre-crash) maneuvers.

Variable Name: How Many Accidents Within Past Twelve Months (as Driver)

Format: 1 column - numeric

Beginning
Column 37

Element Values:

Blank - Driver not present (D09)
Code actual value up through 7
8 8 or more
9 Unknown

Source: Driver interview.

Remarks:

"Blank" indicates that no driver was present.

Record the number of accidents the driver was involved in as a driver within the past twelve (12) months inclusive from the date of the accident as reported by the driver.

Code "0" (0 accidents) if the driver was not involved as a driver in any accident within the past twelve months inclusive from the date of accident. Remember that it is not necessary for the driver to be licensed to be involved in an accident as a driver.

Code "9" (Unknown) means that the interviewee did not know (e.g., surrogate interviewee) or the interviewee refused to answer this question.

Variable Name: Traffic Violation Charged--Speeding

Format: 1 column - numeric

Beginning
Column 38

Element Values:

Blank - Driver not present (D09)
0 No
1 Yes
9 Unknown

Source: Police report.

Remarks:

"Blank" indicates that no driver was present.

If the driver was charged in this accident for speeding, code "1" (Yes). Code this violation independent of variable D36, Driver License Status [e.g., under age driver--D36 = 1 (Not licensed)].

Code "0" (No) if the police report indicates that charges are "pending" or the arrest/summons is blank or crossed out. For example, the police report has "pending" as the only response in the arrest section; the investigator should code "0" (No) for variables D23 through D31. However, if the driver is charged with speeding but additional charges are "pending", the investigator should code D23 as "1" (Yes) and D24 through D31 as "0" (No).

Variable Name: Traffic Violation Charged--Driving While Intoxicated (or DUIL)

Format: 1 column - numeric

Beginning
Column 39

Element Values:

Blank - Driver not present (D09)
0 No
1 Yes
9 Unknown

Source: Police report.

Remarks:

"Blank" indicates that no driver was present.

If this driver was charged in this accident for driving under the influence, or for driving while intoxicated, then code "1" (Yes). The nature (either of the influencing agent which includes nonalcoholic drugs or the level of its presence) of the influence or intoxication may vary within jurisdictions. This variable records only that the offense was cited. Code this violation independent of variable D36, Driver License Status [e.g., under age driver--D36 = 1 (Not licensed)].

Code "0" (No) if the police report indicates that charges are "pending" or the arrest/summons section is blank or crossed out. For example, the police report has "pending" as the only response in the arrest section; the investigator should code "0" (No) for variables D23 through D31. However, if the driver is charged with DWI or DUIL (driving under the influence of liquor) but additional charges are "pending", the investigator should code D24 as "1" (Yes) and D23 and D25-D31 as "0" (No).

Variable Name: Traffic Violation Charged--Reckless Driving

Format: 1 column - numeric

Beginning
Column 40

Element Values:

Blank - Driver not present (D09)
0 No
1 Yes
9 Unknown

Source: Police report.

Remarks:

"Blank" indicates that no driver was present.

If this driver was charged in this accident for reckless driving or for driving to endanger, then code "1" (Yes). Code this violation independent of variable D36, Driver License Status [e.g., under age driver--D36 = 1 (Not licensed)].

Code "0" (No) if the police report indicates that charges are "pending" or the arrest/summons section is blank or crossed out. For example, the police report has "pending" as the only response in the arrest section; the investigator should code "0" (No) for variables D23 through D31. However, if the driver is charged with reckless driving but additional charges are "pending", the investigator should code D25 as "1" (Yes) and D23, D24, and D26-D31 as "0" (No).

Caution must be exercised when coding "careless driving". Careless driving may or may not be the same as "reckless driving". Be sure to check with your State license agency regarding their similarity.

Variable Name: Traffic Violation Charged--Driving with Suspended or Revoked License

Format: 1 column - numeric

Beginning
Column 41

Element Values:

Blank - Driver not present (D09)
0 No
1 Yes
9 Unknown

Source: Police report.

Remarks:

"Blank" indicates that no driver was present.

If this driver was charged in this accident for driving with either a suspended or a revoked driver's license, then code "1" (Yes). Code this violation independent of variable D36, Driver License Status [e.g., under age driver--D36 = 1 (Not licensed)].

Code "0" (No) if the police report indicates that charges are "pending" or the arrest/summons section is blank or crossed out. For example, the police report has "pending" as the only response in the arrest section; the investigator should code "0" (No) for variables D23 through D31. However, if the driver is charged with driving while suspended or revoked but additional charges are "pending", the investigator should code D26 as "1" (Yes) and D23-D25 and D27-D31 as "0" (No).

Variable Name: Traffic Violation Charged--Failure to Yield Right-of-Way

Format: 1 column - numeric

Beginning
Column 42

Element Values:

Blank - Driver not present (D09)

0 No

1 Yes

9 Unknown

Source: Police report.

Remarks:

"Blank" indicates that no driver was present.

If this driver was charged in this accident for failing to yield the right-of-way, then code "1" (Yes). Code this violation independent of variable D36, Driver License Status [e.g., under age driver--D36 = 1 (Not licensed)].

Code "0" (No) if the police report indicates that charges are "pending" or the arrest/summons section is blank or crossed out. For example, the police report has "pending" as the only response in the arrest section; the investigator should code "0" (No) for variables D23 through D31. However, if the driver is charged with failure to yield right-of-way but additional charges are "pending", the investigator should code D27 as "1" (Yes) and D23-D26 and D28-D31 as "0" (No).

Variable Name: Traffic Violation Charged--Following Too Closely

Format: 1 column - numeric

Beginning
Column 43

Element Values:

Blank - Driver not present (D09)
0 No
1 Yes
9 Unknown

Source: Police report.

Remarks:

"Blank" indicates that no driver was present.

If this driver was charged in this accident for following too closely or for failure to keep proper distance, then code "1" (Yes). Code this violation independent of variable D36, Driver License Status [e.g., under age driver-D36 = 1 (Not licensed)].

Code "0" (No) if the police report indicates that charges are "pending" or the arrest/summons section is blank or crossed out. For example, the police report has "pending" as the only response in the arrest section; the investigator should code "0" (No) for variables D23 through D31. However, if the driver is charged with following too closely but additional charges are "pending", the investigator should code D28 as "1" (Yes) and D23-D27 and D29-D31 as "0" (No).

Variable Name: Traffic Violation Charged--Running a Traffic Signal or Stop Sign

Format: 1 column - numeric

Beginning
Column 44

Element Values:

Blank - Driver not present (D09)
0 No
1 Yes
9 Unknown

Source: Police report.

Remarks:

"Blank" indicates that no driver was present.

If this driver was charged in this accident for running a traffic signal or stop sign, then code "1" (Yes). Code this violation independent of variable D36, Driver License Status [e.g., under age driver--D36 = 1 (Not licensed)].

Code "0" (No) if the police report indicates that charges are "pending" or the arrest/summons section is blank or crossed out. For example, the police report has "pending" as the only response in the arrest section; the investigator should code "0" (No) for variables D23 through D31. However, if the driver is charged with running a traffic signal or stop sign but additional charges are "pending", the investigator should code D29 as "1" (Yes) and D23-D28, D30 and D31 as "0" (No).

Variable Name: Traffic Violation Charged--Other Violation Charged

Format: 1 column - numeric

Beginning
Column 45

Element Values:

Blank - Driver not present (D09)

0 No

1 Yes

9 Unknown

Source: Police report.

Remarks:

"Blank" indicates that no driver was present.

If this driver was charged in this accident with a violation other than speeding, driving under the influence, driving while intoxicated, reckless driving (driving to endanger), driving with either a suspended or revoked license, failure to yield right-of-way, following too closely (failure to keep proper distance), or running a traffic signal or stop sign, then code "1" (Yes). Code this violation independent of variable D36, Driver License Status [e.g., under age driver--D36 = 1 (Not licensed)].

Code "0" (No) if the police report indicates that charges are "pending" or the arrest/summons section is blank or crossed out. For example, the police report has "pending" as the only response in the arrest section; the investigator should code "0" (No) for variables D23 through D31. However, if the driver is charged with an "other" violation (e.g., improper center lane usage) but additional charges are "pending", the investigator should code D30 as "1" (Yes) and D23-D29 and D31 as "0" (No).

Variable Name: Traffic Violation Charged--Unknown Violation Charged

Format: 1 column - numeric

Beginning
Column 46

Element Values:

Blank - Driver not present (D09)
0 No
1 Yes
9 Unknown

Source: Police report.

Remarks:

"Blank" indicates that no driver was present.

If this driver was charged in this accident with a violation but no violation was specified, then code "1" (Yes). A code of yes for this variable may imply that the preceding eight variables (D23 through D30) should be coded no ("0"). Code this violation independent of variable D36, Driver License Status [e.g., under age driver--D36 = 1 (Not licensed)].

Code "0" (No) if the police report indicates that charges are "pending" or the arrest/summons section is blank or crossed out. For example, the police report has "pending" as the only response in the arrest section; the investigator should code "0" (No) for variables D23 through D31. However, if the driver is charged with an unspecified violation but additional charges are "pending", the investigator should code D31 as "1" (Yes) and D23-D30 as "0" (No).

Variable Name: Police Reported Alcohol Presence

Format: 1 column - numeric

Beginning
Column 47

Element Values:

Blank - Driver not present (D09)
0 No (alcohol not present)
1 Yes (alcohol present)
8 Not reported
9 Unknown

Source: Police report.

Remarks:

"Blank" indicates that no driver was present.

Find the location on the police report that indicates the investigating officer's assessment with respect to whether or not alcohol was present in the driver in this accident. If the police report explicitly states or implies that alcohol was present or used by the driver prior to the accident, then code "1" [Yes (alcohol present)]. If there is no specific variable concerning alcohol presence, see if it is addressed in the narrative description of the accident.

The phrase "present in the driver" means that the driver had consumed an alcoholic beverage. Presence is not an indication that alcohol was in any way a cause of the accident, even though it may have been. Finding opened or unopened alcoholic beverages in the vehicle does not by itself constitute presence.

In summary, if the police indicate alcohol presence in the driver via a specific data element on the police report form and/or if the police charges the driver with DWI or DUIL and/or if the police mention in the narrative section of the report that the driver had been drinking (or alcohol was present or involved) and/or the police report has a positive BAC test result (BAC > .00), then code "1" [Yes (alcohol present)].

Code "0" [No (alcohol not present)] if the investigating officer's assessment (as reported on the police report) is that no alcohol was present in the driver. If there is a specific location on the police report for assessment of alcohol presence but the investigating officer fails to make either a positive or negative assessment of alcohol presence, then code "8" (Not reported).

Variable Name: Police Reported Alcohol Presence (cont'd.)

If the PAR has a block which is labeled "Alcohol/Drugs", then use any other information on the PAR to determine what was present, alcohol or some other type of drug. If no other information is available, then code "9" (Unknown) should be used.

Code "9" (Unknown) if the alcohol presence is unknown. In general police reports have blocks to check either positive or negative alcohol presence, hence one of the codes "0", "1", or "8" is the appropriate response. But if a police report has provision for the investigating officer to respond "unknown alcohol presence", then code "9" (Unknown).

Hit-and-run drivers should be coded "9" (Unknown) for this variable unless clear evidence to the contrary exists.

Variable Name: Alcohol Test Results

Format: 2 columns - numeric

Beginning
Column 48

Element Values:

Level 2 Range: 00 through 25
Code actual reported number representing fraction of alcohol present
(decimal implied before first digit 0.xx).
Blank - Driver not present (D09)
95 Test refused
96 None given
97 AC test performed, results unknown
99 Unknown

Source: Police report, medical reports, or other official sources.

Remarks:

"Blank" indicates that no driver was present.

A blood alcohol concentration (BAC) test could be a blood, breath, or urine test. No psychomotor (police observation of driver actions) test results are to be coded here. These preliminary tests include instrumented field screening tests which indicate the presence of alcohol, but not necessarily the particular content level. These devices are designed to segregate candidates for further testing from those persons where the suspected presence of alcohol is either nonexistent or too low for additional tests.

Code "95" (Test refused) when the person refuses to voluntarily take a BAC test and no subsequent test is given. If the person refuses, but a test is performed, code the reported BAC or "97" (AC test performed, results unknown).

Code "96" (None given) includes those instances when an instrumented field screening test was given and it determined that no BAC test was required.

If an instrumented field screening test was given and it determined that a BAC test was required, code either the reported BAC from the subsequent test or "97" (AC test performed, results unknown) if the precise level was not obtained. Investigators should obtain BAC test results whenever possible. Code "97" should be used only after all available sources have been exhausted. Verbal BACs obtained from official sources are acceptable if written approval (or approval via the message system) has been obtained from the Zone Center.

DRIVER FORM

D33

(2)

Variable Name: Alcohol Test Results

If the results are not available at the time the NASS case is initially submitted, code "97" (AC test performed results unknown), circle the variable number, and update this variable when the results are obtained.

If the BAC was given on the police report or subsequently added after the case was initiated, code the reported value. If the BAC was obtained from a medical report or any other official record, code the reported value. In essence, if any BAC is obtained, code the reported value.

Variable Name: License Source

Format: 1 column - numeric

Beginning
Column 50

Element Values:

Blank - Driver not present (D09)
0 No license
1 Domestic
2 Foreign
9 Unknown

Source: Official driver record and police report. Official driver records take precedence over police reported information.

Remarks:

This variable describes the origin of the license the driver possesses, regardless of whether the license is valid for the type of vehicle being driven at the time of the accident, or is suspended, revoked or expired.

"Blank" indicates that no driver was present.

Code "0" (No license) means that it is known that this driver is not a registered motor vehicle operator.

Code "1" (Domestic) means that this driver is registered in at least one of the fifty (50) states or by the military. If a driver's license is suspended or revoked but was originally registered in the U.S. or by the military, then code "1" (Domestic) should be used.

Code "2" (Foreign) means that this driver is not registered in one of the fifty (50) states or by the military and is registered in a foreign country (e.g., Canada, Mexico, etc.), in a U.S. possession or territory (e.g., Puerto Rico, Guam, etc.), or has an international license.

Unknown ("9") is used if the investigator is uncertain as to whether or not the person possesses a license.

See reference table for coding variables D34, D36, and D37 following the remarks section of variable D37 (Driver License Type Compliance).

Acquiring Driver Records for NASS Through the FARS Analyst

The following procedure to acquire driver and vehicle records for the National Accident Sampling System (NASS) is in effect.

The system differs for each of the two following situations: the first involves the NASS PSU team leader, and the second involves the team leader and the FARS Analyst. The two situations are:

- (a) Driver records for drivers who reside within an operating NASS PSU State. (Attached is a list of NASS PSU States.)
- (b) Driver records of drivers who reside in a Non-NASS State. Attached is a list of NHTSA FARS CTMs.

Please note that this procedure does not address drivers who reside in another country.

DRIVER RECORD ACQUISITION SYSTEM

A. Driver Records for Drivers Who Reside within the NASS PSU State

In your own State, follow your established procedures. In another NASS PSU State, contact a NASS team in the State and have them obtain the driver records for you. Be sure to provide all of the information the team tells you is necessary to obtain the record. Informatics can be used to identify the driver record needed.

B. Driver Records for Drivers Who Reside in a Non-NASS State

The NASS PSU Team Leader will complete the enclosed information request and send it to the appropriate NHTSA FARS Regional CTM (list of names and addresses enclosed). The NHTSA FARS Regional CTM will forward the request directly to the State FARS Analyst. The State Analyst will return the completed form directly to the PSU Team Leader with a copy to the FARS Regional CTM.

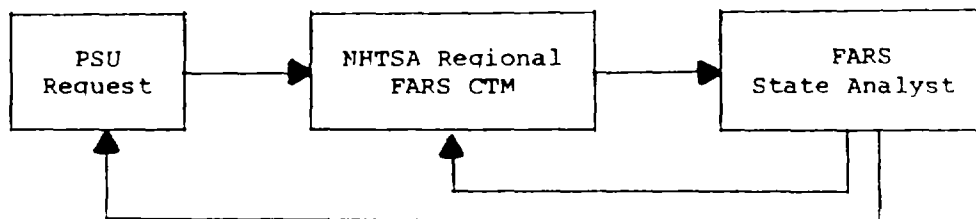

LIST OF NASS PSU STATES

The following States contain at least one operating NASS PSU:

<u>STATE</u>	<u>PSU(s)</u>	<u>STATE</u>	<u>PSU(s)</u>
Alabama	P52,P55	Missouri	P03
Arizona	P81,P87	Nebraska	P78
Arkansas	P53	New Jersey	P29
California	P79	New Mexico	P82
Colorado	P80	New York	P26,P33,P34,P36
Florida	P51,P56	North Carolina	P54,P58
Illinois	P01,P07,P08	Pennsylvania	P27,P28,P30,P31,P32,P37
Indiana	P06,P13	Rhode Island	P39
Iowa	P14	South Dakota	P83
Louisiana	P60	Tennessee	P57
Maryland	P38	Texas	P61,P62,P63
Massachusetts	P35	Washington	P76,P85
Michigan	P02,P04,P05,P09,P11	Wisconsin	P10,P12
Mississippi	P59		

Driver records from states identified above are to be requested through the appropriate NASS PSU(s) of that state.

LIST OF NHTSA FARS REGIONS

<u>REGION 1</u>	<u>REGION 2</u>	<u>REGION 3</u>
*Connecticut	New Jersey	*Delaware
*Maine	New York	Maryland
Massachusetts	*Puerto Rico	Pennsylvania
*New Hampshire		*Virginia
Rhode Island		*Washington, D.C.
*Vermont		*West Virginia
<u>REGION 4</u>	<u>REGION 5</u>	<u>REGION 6</u>
Alabama	Illinois	Arkansas
Florida	Indiana	Louisiana
*Georgia	Michigan	New Mexico
*Kentucky	*Minnesota	*Oklahoma
Mississippi	*Ohio	Texas
North Carolina	Wisconsin	
*South Carolina		
Tennessee		

* Driver records are to be requested through the NHTSA FARS Regional CTMs only for those states identified with an asterisk (*).

<u>REGION 7</u>			<u>REGION 8</u>			<u>REGION 9</u>			<u>Region 10</u>		
Iowa			Colorado			Arizona			*Alaska		
*Kansas			*Montana			California			*Idaho		
Missouri			*North Dakota			*Hawaii			*Oregon		
Nebraska			South Dakota			*Nevada			Washington		
			*Utah								
			*Wyoming								
<u>State</u>	<u>NASS PSU Number</u>	<u>NHTSA FARS Region</u>	<u>State</u>	<u>NASS PSU Number</u>	<u>NHTSA FARS Region</u>						
Alabama	P52, P55	4	Nebraska	P78	7						
*Alaska		10	*Nevada		9						
Arizona	P81, P87	9	*New Hampshire		1						
Arkansas	P53	6	New Jersey	P29	2						
California	P79	9	New Mexico	P82	6						
Colorado	P80	8	New York	P26, P33, P34, P36	2						
*Connecticut		1	North Carolina	P54, P58	4						
*Delaware		3	*North Dakota		8						
Florida	P51, P56	4	*Ohio		5						
*Georgia		4	*Oklahoma		6						
*Hawaii		9	*Oregon		10						
*Idaho		10	Pennsylvania	P27, P28, P30, P31, P32, P37	3						
Illinois	P01, P07, P08	5	*Puerto Rico		2						
Indiana	P06, P13	5	Rhode Island	P39	1						
Iowa	P14	7	*South Carolina		4						
*Kansas		7	South Dakota	P83	8						
*Kentucky		4	Tennessee	P57	4						
Louisiana	P60	6	Texas	P61, P62, P63	6						
*Maine		1	*Utah		8						
Maryland	P38	3	*Vermont		1						
Massachusetts	P35	1	*Virginia		3						
Michigan	P02, P04, P05, P09, P11	5	Washington	P76, P85	10						
*Minnesota		5	*Washington, D.C.		3						
Mississippi	P59	4	*West Virginia		3						
Missouri	P03	7	Wisconsin	P10, P12,	5						
*Montana		8	*Wyoming		8						

* Driver records are to be requested through the NHTSA FARS Regional CTMs only for those states identified with an asterisk (*).

NHTSA FARS Regional CTMs

REGION 01

Winsor Coleman
NHTSA Region 1
Transportation Systems Center
55 Broadway
Kendall Square
Cambridge, Massachusetts 02142

REGION 03

Charles Alwine
NHTSA Region 3
Airport Plaza Building
793 Elkridge Landing Road
Linthicum, Maryland 21090

REGION 05

Sami Richie
NHTSA Region 5
Executive Plaza, Suite 214
1010 Dixie Highway
Chicago Heights, Illinois 60411

REGION 07

William Reitingner
NHTSA Region 7
P.O. Box 19515
Kansas City, Missouri 64141

REGION 09

John R. Nelson
NHTSA Region 9
Two Embarcadero Center
Suite 610
San Francisco, California 94111

REGION 02

Thomas Louizou
NHTSA Region 2
222 Mamaroneck Avenue
Suite 204
White Plains, New York 10605

REGION 04

Joseph Jeffrey
NHTSA Region 4
1720 Peachtree Road, N.W.
Suite 501
Atlanta, Georgia 30309

REGION 06

Pat Sutherland
NHTSA Region 6
819 Taylor Street
Fort Worth, Texas 76102

REGION 08

Harold Jones
NHTSA Region 8
555 Zang Street
Denver, Colorado 80228

REGION 10

Howard Eddy
NHTSA Region 10
Federal Building, Room 3140
915 Second Avenue
Seattle, Washington 98147

NOTE: The NHTSA FARS Regional CTMs should be contacted only when driver records are being requested from a non-NASS state -- states without a NASS PSU.

Acquiring Canadian Driver Records for NASS

Cooperative arrangements between NHTSA and Transport Canada for obtaining driver/vehicle information concerning Canadians involved in motor vehicle accidents occurring within the U.S. have been finalized.

In the event that a Canadian driver or vehicle is involved in a NASS accident, please call the appropriate individual (based on Canadian province) for the required information (see attachment).

Also, please realize that this is a cooperative arrangement and that it is possible that these individuals may contact you for similar information on U.S. drivers involved in accidents which occurred in Canada. Should you receive such a request, please obtain and send them the necessary information.

CONTACTS FOR INFORMATION ON ACCIDENT-INVOLVED MOTOR VEHICLE DRIVERS AND VEHICLES

PROVINCE	AGENCY	CONTACT	AREA CODE	TELEPHONE NUMBERS
Nova Scotia	Technical University of Nova Scotia	Dr. Charles Miller Dr. Robert Baird Vince Dolron Carol Price	902	423-1526 (ext. 224) 429-8300 (ext. 161)
New Brunswick	HALIFAX, Nova Scotia University of New Brunswick	Prof. J. D. Innes Gary Smith Gordon Tuft	506	454-9099
Quebec	FREDERICTON, N.B. MCGILL University	Prof. A. Thompson Mrs. D. Steiner Jonathan Shanks	514	392-4200 392-4796 392-4673
	MONTREAL, Quebec Ecole Polytechnique	Prof. Michael Gou Alexandre Cazin Francois Morin Jocelyne Chretien	514	344-4669 344-4769 344-4721 344-4720
Ontario	MONTREAL, Quebec University of Toronto	Prof. M. Davis Mr. L. Black D. Kean	416	978-5054
	TORONTO, Ontario University of Western Ontario	Prof. E. Nowak Alan German Zygmund Gorski	416	679-3323 679-6565 679-6565
Manitoba	LONDON, Ontario University of Manitoba	Dr. G. W. Mulligan Carol Soble Peter Male	204	786-3528
Saskatchewan	WINNIPEG, Manitoba University of Saskatchewan	Miss Pat Hamilton	306	343-3171 343-3795
Alberta	SASKATOON, Saskatchewan University of Calgary	Dr. John Read Irene Wingate Peter Marsh	403	284-6005 284-5041 284-5042
British Columbia	CALGARY, Alberta University of British Columbia	Dr. Dave Erickson Shirley McGuire	604	228-4753 or 228-6851
Prince Edward Island Newfoundland Yukon	VANCOUVER, British Columbia Transport Canada	Brian Hendrick T d Richards Mike Bertrand	603	993-9851
Northwest Territories	OTTAWA, Ontario			

NATIONAL ACCIDENT SAMPLING SYSTEM DATA

REQUEST FROM THE FATAL ACCIDENT REPORTING SYSTEM ANALYST

TO: _____
Appropriate FARS Regional CTM

NASS ACCIDENT CASE NO: _____

FROM: _____
PSU Team Leader

REQUEST DATE: _____

_____ Address

_____ City State Zip

This is a request for data for a vehicle and/or driver involved in an accident in the State of _____. Below and on the back of this form are some descriptive data for the vehicle and/or driver. Please obtain the required data (covering the three year period prior to the date of the accident: _____ 197__ to _____ 198__) from the State vehicle and/or driver files and complete the appropriate items. If information is not available, please check the box below. Thank you.

SORRY, NO VEHICLE/DRIVER RECORD IN THIS STATE. (Circle Vehicle, Driver, or both.)

VEHICLE DESCRIPTION

OWNER'S NAME:

BODY TYPE:

OWNER'S ADDRESS:

YEAR:

REGISTERED IN STATE OF:

LICENSE NO.:

MAKE:

PLATE YEAR:

MODEL:

VIN:

VEHICLE MAKE	14	15	VEHICLE MODEL	16	17	BODY TYPE	18	19	MODEL YEAR	20	21									
(See Instruction Manual)			(See Instruction Manual)			(See Instruction Manual)			Actual Value except 99 - Unknown											
VEHICLE IDENTIFICATION NUMBER				22	23	24	25	26	27	28	29	30	31	32	33	34	35	36	37	38
Actual Value Except																				
Zero Fill if no VIN																				
Nine Fill if Unknown																				
REGISTRATION STATE										39	40									
GSA Codes Except																				
00 - Not Applicable					95 - U.S. Government Tags															
92 - No Registration					96 - Military Vehicle															
93 - Multiple State Reg. in State					97 - Foreign Countries															
94 - Multiple State Reg. Out-of-State					99 - Unknown															

DRIVER INFORMATION

Driver's Name:

Driver's License No.:

Driver's Address:

D37

LICENSE/CLASS VEHICLE COMPLIANCE

- 0 - No License Required
- 1 - No License, License Required
- 2 - Valid License for This Class Vehicle Only
- 3 - One Valid License, but Not for This Class Vehicle
- 4 - Multiple Class Licenses, Valid License for This Class Vehicle
- 5 - Multiple Class Licenses, No Valid License for This Class Vehicle
- 9 - Unknown

17

D36

LICENSE STATUS

- 0 - None Required
- 1 - None
- 2 - Valid
- 3 - Suspended
- 4 - Revoked
- 5 - Expired
- 6 - Cancelled or Denied
- 7 - Learner's Permit
- 8 - Temporary
- 9 - Unknown

18

D35
COMPLIANCE WITH
LICENSE RESTRICTIONS

- 0 - No Restrictions
- 1 - Restrictions Complied With
- 2 - Restrictions Not Complied With
- 3 - Restrictions, Compliance Unknown
- 9 - Unknown

19

D16
DRIVER TRAINING

- 0 - None
- 1 - High School
- 2 - Commercial
- 3 - School Bus
- 4 - Traffic School
- 5 - Two or more Types
- 6 - Training, Type Unknown
- 9 - Unknown

20

Not Applicable

21

D44
PREVIOUS RECORDED
ACCIDENTS

- Actual Value Except:
- 00 - None
- 99 - Unknown

22	23
----	----

D43
PREVIOUS RECORDED SUSPENSIONS
AND REVOCATIONS

- Actual Value Except:
- 00 - None
- 99 - Unknown

99 - Unknown

24	25
----	----

D42

PREVIOUS DWI CONVICTIONS

- Actual Value Except:
- 00 - None
- 99 - Unknown

99 - Unknown

26	27
----	----

D40

PREVIOUS SPEEDING CONVICTIONS

- Actual Value Except:
- 00 - None
- 99 - Unknown

99 - Unknown

28	29
----	----

D41
PREVIOUS
OTHER
HARMFUL MV
CONVICTIONS

- Actual Value Except:
- 00 - None
- 99 - Unknown

30	31
----	----

38. Driver License Restrictions*

- (0) No restrictions
- (1) Corrective or contact lenses
- (2) Mechanical aid
- (3) Limited to daylight only
- (4) Automatic transmission
- (5) Outside mirror
- (6) Prosthetic aid
- (7) Limited to employment
- (8) Other restrictions:
- (9) Unknown

39. Additional Driver License
Restrictions*

- (0) No additional restriction
- (2) Mechanical aid
- (3) Limited to daylight only
- (4) Automatic transmission
- (5) Outside mirror
- (6) Prosthetic aid
- (7) Limited to employment
- (8) Other restrictions:
- (9) Unknown

*If there are restrictions from driver records that cannot be matched with codes "1" through "7", write these restrictions in the space provided for code "8" (Other restrictions).

Variable Name: Compliance With License Restrictions

Format: 1 column - numeric

Beginning
Column 51

Element Values:

Blank - Driver not present (D09)
0 No restrictions
1 Restrictions complied with
2 Restrictions not complied with
3 Restrictions, compliance unknown
9 Unknown

Source: Police report, other official records, or vehicle inspection when a vehicle related restriction applies.

Remarks:

"Blank" indicates that no driver was present.

The vehicle inspection can be used to determine compliance with a restriction that is related to vehicle structure (e.g., outside mirrors, automatic transmission, mechanical aids, etc.).

Code "0" (No restrictions) must be coded if D36, Driver License Status, equals "0" (No license required) or "1" (Not licensed). In distinguishing license requirements from restrictions focus upon whether or not all drivers possessing the type of license are mandated to obey the requirement. If they are, then the requirement is not a restriction, but rather part of a definition of the license. Restrictions, on the other hand, are requirements specific to individual drivers.

If a driver has more than one license restriction, compliance with restrictions should be coded as follows: If it is known that the driver complied with all license restrictions, use code "1" (restrictions complied with). If it is known that the driver did not comply with at least one restriction, use code "2" (restrictions not complied with). If the compliance of at least one restriction is unknown, then code "3" (restrictions, compliance unknown) should be used.

If a driver had a "learner's permit" (D36, Driver License Status, equal "7") and was caught driving unaccompanied by a person who holds a valid driver's license for the vehicle type being operated, then do not consider this "failure to be accompanied" as a "restriction not complied with" since it is not a restriction (i.e., it is implied in the definition of a learner's permit). This also applies to any other requirements which are associated

DRIVER FORM

D35

(2)

Variable Name: Compliance With License Restrictions

with a learner's permit in a particular state (e.g., driving limited to certain time periods).

On the other hand, if a driver with a valid driver's license for the vehicle type being operated, but restricted to driving during certain periods only, is caught driving outside the specified time periods, then code "2" (Restrictions not complied with).

Variable Name: Driver License Status (for this vehicle)

Format: 1 column - numeric

Beginning
Column 52

Element Values:

- Blank - Driver not present (D09)
- 0 No license required
- 1 Not licensed
- 2 Valid
- 3 Suspended
- 4 Revoked
- 5 Expired
- 6 Canceled or denied
- 7 Learner's permit
- 8 Temporary
- 9 Unknown

Source: Official driver record and police report. Official driver records take precedence over police reported information.

Remarks:

If variable D34 (license source) is coded "9" (unknown), then variable D36 must be coded "9" (unknown).

"Blank" indicates that no driver was present.

Code "0" (No license required) means that a license was not required for the vehicle being driven (e.g., mopeds in some states).

Code "1" (Not licensed) should be used only when it has been reasonably established that the driver is not registered (anywhere) or that the driver's license held is not valid for the type of vehicle being driven during this accident. Drivers who have a license but fail to have their license with them at the time of the accident should be coded according to the type (class) of license they possess and the validity of the license. If the police report indicates that the driver has "no license", the investigator should first determine whether this means that the person was not in possession of his/her license at the time of the accident, or that the driver is not a registered motor vehicle operator. A review of the violations cited section of the police report may yield some clues in this matter. If the person is cited for not possessing his/her license or for not having one, then code this information in variable D30, Traffic Violation Charged--Other Violation Charged. If the investigator is uncertain as to whether or not the person possesses a license, then code "9" (Unknown) should be used.

Variable Name: Driver License Status (cont'd.)

Code "2" (Valid) refers to a valid license held by the driver that is valid for the class of vehicle being driven. As an example, a common situation occurs when a separate license is required for a motorcycle. If the driver possesses a valid license for a passenger car but not for the motorcycle, then code "1" should be used. However, if the driver possesses the required motorcycle license, code "2" (valid) would be used.

Code "2" (Valid) includes those with restrictions (e.g., restricted to certain hours). If the driver is in violation of some aspect of his/h r license (e.g., one of the restrictions) do not consider the license as being not valid. Record the restriction on variable D38 (Driver License Restriction) or D39 (Additional Driver License Restriction) if applicable. If the police cite the driver for the violation, then the information would be recorded under variable D30 (Traffic Violation Charged--Other Violation Charged).

Codes "3" (Suspended), "4" (Revoked), or "5" (Expired) are only used when a driver has a license for the class of vehicle being driven and they take precedence over codes "2", "7", or "8". If the driver has a license that is suspended, revoked, or expired but would not be applicable for this type of vehicle, then code "1" no license.

Code "6" (Cancelled or denied) is used whenever the driver's official driver record indicates that the driver's license for the class of vehicle driven in this accident (1) was cancelled or (2) the driver's request for a license, or an extension of one, was denied. If the driver has a license that is cancelled or denied, but would not be applicable for this type of vehicle, then code "1" no license.

Code "7" (Learner's permit) includes any type of preliminary license the driver obtained. It is defined as the state-sanctioned authority to operate a motor vehicle for a specified period with the requirement that the operator be accompanied by a person who holds a valid driver's license for the vehicle type being operated. There may be additional requirements (e.g., driving limited to certain time periods) which are also considered within the definition of a learner's permit. If the learner's permit is valid for the type of vehicle being driven in this accident use code "7"; if not, use code "1".

Code "8" (Temporary) includes any type of nonpermanent license issued for a period of time less than that for a permanent license (e.g., temporary license to drive within a resort area; temporary license issued to foreign nationals). Short term permanent licenses are not temporary (e.g., license issued to elderly drivers requiring frequent retesting). In order to use this code, the temporary license must be valid for the type of vehicle being

DRIVER FORM

D36
(3)

Variable Name: Driver License Status (cont'd.)

driven during the accident; if not, use code "1". Interim licenses held by new drivers awaiting a permanent driver license identification from the state are not temporary.

Code "9" (Unknown) should be used when the driver has a license but the validity for this type of vehicle is uncertain or if it is unknown whether the driver had a license or not (e.g., hit-and-run). Code "9" must be used when variable D34 (license source) is coded "9" (unknown).

See reference table for coding variables D34, D36, and D37 following the remarks section of variable D37 (Driver License Type Compliance).

In distinguishing license requirements from restrictions focus upon whether or not all drivers possessing the type of license are mandated to obey the requirement. If they are, then the requirement is not a restriction, but rather part of the definition of the license. Restrictions, on the other hand, are requirements specific to individual drivers.

Variable Name: Driver License Type Compliance

Format: 1 column - numeric

Beginning
Column 53

Element Values:

- Blank - Driver not present (D09)
- 0 No license required
- 1 No license, license required
- 2 Valid license (for this class vehicle only)
- 3 One (single class) valid license (but not for this class vehicle)
- 4 Multiple class license - valid license for this class vehicle
- 5 Multiple class license - no valid license for this class vehicle
- 9 Unknown

Source: Official driver record and police report. Official driver records take precedence over police reported information.

Remarks:

"Blank" indicates that no driver was present.

Code "0" (No license required) means that a license was not required for the vehicle being driven (e.g., mopeds in some states). If D36, Driver License Status, is coded "0" (No license required), then it must also be coded here.

Code "1" (No license, license required) should be used only when it has been reasonably established that the driver is not registered (anywhere), and where D36 equals 1 or 3-6. Drivers who have a license but fail to have their license with them at the time of the accident should be coded according to the type of license they possess and the class of vehicle they were driving. Code "1" should not be used in this instance. If the police report indicates that the driver has "no license", the investigator should first determine whether this means that the person was not in possession of his/her license at the time of the accident, or that the driver is not a registered motor vehicle operator. A review of the violations cited section of the police report may yield some clues in this matter. If the person is cited for not possessing his/her license or for not having one, then code this information in variable D30, Traffic Violation Charged--Other Violation Charged. If the investigator is uncertain as to whether or not the person possesses a license, then code "9" (Unknown) should be used.

Code "2" [Valid license (for this class vehicle only)] refers to the class of vehicle being driven. Class here is similar to the notion of class D10, Months Driving Experienc This Class of Vehicle, except for light trucks and

Variable Name: Driver License Type Compliance (cont'd.)

passenger cars which are considered distinct classes in D10, but are considered in the same class of this variable (i.e., a standard operators license is for a single class of vehicle). As an example, the driver has a "motorcycle" driver's license only and was driving a motorcycle at the time of the accident; code "2" should be used.

Code "3" (One (single class) valid license (but not for this class vehicle)) refers to drivers with a valid license but not for the class of vehicle driven at the time of the accident. As an example, the driver has an "operator's license" when a "public passenger" type license is required. For this driver, "3" should be coded. Another common situation occurs when a separate license is required for a motorcycle. If the driver possesses a valid license for a passenger car but not for the motorcycle, then code "3" should be used if the driver was involved in this accident while driving a motorcycle.

Code "4" (Multiple class license - valid license for this class vehicle) refers to drivers with a multiple class license who were driving a class of vehicle specified in the multiple class license. As an example, the driver has an "operator's license" for any motor vehicle through 8,000 lbs. gross weight and for any motor-driven cycles; if the driver was involved in this accident while driving a motorcycle, then code "4".

Code "5" (Multiple class license - no valid license for this class vehicle) refers to drivers with a multiple class license who were driving a class of vehicle not covered by this multiple class license. As an example, the driver has a multiple class license for any motor-driven cycles and any motor vehicle except truck-tractor semitrailer combinations; if the driver was involved in this accident while driving a tractor-semitrailer combination, then code "5".

The phrase "multiple class license" means that the State which issued the driver's license (the one reported on the PAR) indicates that the driver is qualified to operate more than one class of vehicle. Having licenses from more than one state, territory, etc., does not constitute a multiple class license. In fact, the license reported to the police is the one reported about on this and the preceding variable (D36, Driver License Status).

Code "9" (Unknown) should be used when the driver has a license but the type or validity are uncertain or if it is unknown whether the driver had a license or not (e.g., hit-and-run). Also, code "9" is used when the vehicle type is known to be a vehicle which does not require a driver to be licensed (e.g., Mopeds or Farm Tractors in some states) and variables D34 and D36 are coded "9".

A cross reference table for coding variables D34, D36 and D37 follows:

Cross Reference Tables For D34, D36, D37

D37
(3)

D34	D36	0	1	2	3	4	5	6	7	8	9
0		Y	Y	N	N	N	N	N	N	N	N
1		Y	Y	Y	Y	Y	Y	Y	Y	Y	Y
2		Y	Y	Y	Y	Y	Y	Y	Y	Y	Y
3		N	N	N	N	N	N	N	N	N	Y

D34	D37	0	1	2	3	4	5	9
0		Y	Y	N	N	N	N	N
1		Y	Y	Y	Y	Y	Y	Y
2		Y	Y	Y	Y	Y	Y	Y
9		N	N	N	N	N	N	Y

D36	D37	0	1	2	3	4	5	9
0		Y	N	N	N	N	N	N
1		N	Y	N	Y	N	Y	Y
2		N	N	Y	N	Y	N	Y
3		N	Y	N	N	N	Y	Y
4		N	Y	N	N	N	Y	Y
5		N	Y	N	N	N	Y	Y
6		N	Y	N	N	N	Y	Y
7		N	N	Y	N	Y	N	Y
8		N	N	Y	N	Y	N	Y
9		N	N	N	N	N	N	Y

Y = Valid Combination
N = Invalid Combination

REMINDER: D34 = Applies to any license entry in the driver's record
 D36 = Applies to this vehicle only.
 D37 = Applies according to the code meaning (generally this vehicle).

Variable Name: Driver License Restrictions

Format: 1 column - numeric

Beginning
Column 54

Element Values:

- Blank - Driver not present (D09)
- 0 No restrictions
- 1 Corrective or contact lenses
- 2 Mechanical aid
- 3 Limited to daylight only
- 4 Automatic transmission
- 5 Outside mirror
- 6 Prosthetic aid
- 7 Limited to employment
- 8 Other restrictions (specify)
- 9 Unknown

Source: Official driver record and police report (if applicable). Official driver records take precedence over police reported information.

Remarks:

"Blank" indicates that no driver was present.

These restrictions are ascendingly ordered if more than one element is applicable. Code the lowest numerically-valued restriction on this variable.

Code "0" (No restrictions) must be coded if D36, Driver License Status, equals "0" (No license required) or "1" (Not licensed).

Code "2" (Mechanical aid) refers to a special mechanical device attached to the vehicle (e.g., hand controlled brakes).

Code "6" (Prosthetic aid) refers to a device attached to the driver (e.g., artificial limb).

If a driver had a "learner's permit" (variable D36 = 7, Driver License Status) and was caught driving unaccompanied by a person who holds a valid driver's license for the vehicle type being operated, then do not consider this "failure to be accompanied" as a restriction since it is implied in the definition of a learner's permit. This also applies to any other requirements which are associated with a learner's permit in a particular state (e.g., driving limited to certain time periods).

DRIVER FORM

D38

(2)

Variable Name: Driver License Restrictions

In distinguishing license requirements from restrictions focus upon whether or not all drivers possessing the type of license are mandated to obey the requirement. If they are, then the requirement is not a restriction, but rather a part of the definition of the license. Restrictions, on the other hand, are requirements specific to individual drivers.

Variable Name: Additional Driver License Restrictions

Format: 1 column - numeric

Beginning
Column 55

Element Values:

- Blank - Driver not present (D09)
- 0 No additional restriction
- 2 Mechanical aid
- 3 Limited to daylight only
- 4 Automatic transmission
- 5 Outside mirror
- 6 Prosthetic aid
- 7 Limited to employment
- 8 Other restrictions (specify)
- 9 Unknown

Source: Official driver record and police report (if applicable). Official driver records take precedence over police reported information.

Remarks:

"Blank" indicates that no driver was present.

Code "0" (No additional restriction) if no restrictions were reported (D38, Driver License Restriction, equals code "0"), or only one restriction was reported. The restriction reported on the preceding variable (D38) must have been of a lower numerical value than the restriction reported here with the exception of the other restriction ("8") code. In this instance "8" (Other restriction) should be coded for this variable.

In addition, code "0" (No additional restriction) must be coded if D36, Driver License Status, equals "0" (No license required) or "1" (Not licensed).

If a driver had a "learner's permit" (variable D36 = 7, Driver License Status) and was caught driving unaccompanied by a person who holds a valid driver's license for the vehicle type being operated, then do not consider this "failure to be accompanied" as a restriction since it is implied in the definition of a learner's permit. This also applies to any other requirements which are associated with a learner's permit in a particular state (e.g., driving limited to certain time periods).

DRIVER FORM

D39

(2)

Variable Name: Additional Driver License Restrictions

In distinguishing license requirements from restrictions focus upon whether or not all drivers possessing the type of license are mandated to obey the requirement. If they are, then the requirement is not a restriction, but rather part of the definition of the license. Restrictions, on the other hand, are requirements specific to individual drivers.

Variable Name: Previous Speeding Convictions

Format: 1 column - numeric

Beginning
Column 56

Element Values:

Level 1 Range: 0 through 9

Blank - Driver not present (D09)

8 Eight or more

9 Unknown

Source: Official driver record.

Remarks:

"Blank" indicates that no driver was present.

Code "9" (Unknown) means that no official records were obtainable, independent of the reason for the record being unobtainable (i.e., record never existed, person never licensed, record not found, or record denied by cognizant state agency).

If the state record does not include the number of previous speeding convictions, then this variable should be coded as "9" (Unknown).

Record the number of speeding convictions (points assessed, license suspensions, etc.) listed on the driver's record for the "previous three years" inclusive from the date of the accident.

Variable Name: Previous Other Harmful Moving Violation Convictions

Format: 1 column - numeric

Beginning
Column 57

Element Values:

Level 1 Range: 0 through 9

Blank - Driver not present (D09)

8 Eight or more

9 Unknown

Source: Official driver record.

Remarks:

"Blank" indicates that no driver was present.

Code "9" (Unknown) means that no official records were obtainable, independent of the reason for the record being unobtainable (i.e., record never existed, person never licensed, record not found, or record denied by cognizant state agency).

If the state record does not include the number of previous moving violation convictions, then this variable should be coded as "9" (Unknown).

Record the number of moving violation convictions (points assessed, license suspensions, etc.) listed on the driver's record for the "previous three years" inclusive from the date of the accident.

Each team should consult with their state driver records personnel so as to distinguish other moving violations from nonmoving violations (e.g., driving without a license).

All moving violations cited are assumed to be harmful. In other words, disregard the term "harmful".

OFFICIAL INJURY DATA

Indicate the *Nature* and *Location* of All injuries

Soft Tissue Injuries

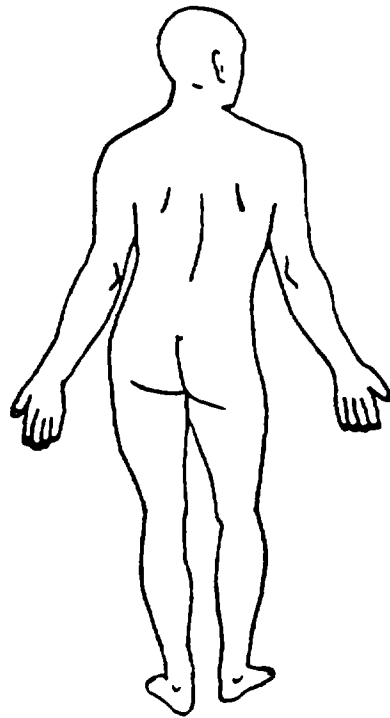
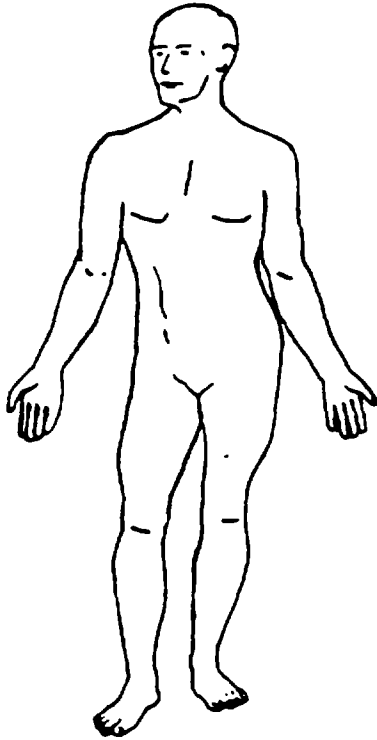

Skeletal Injuries

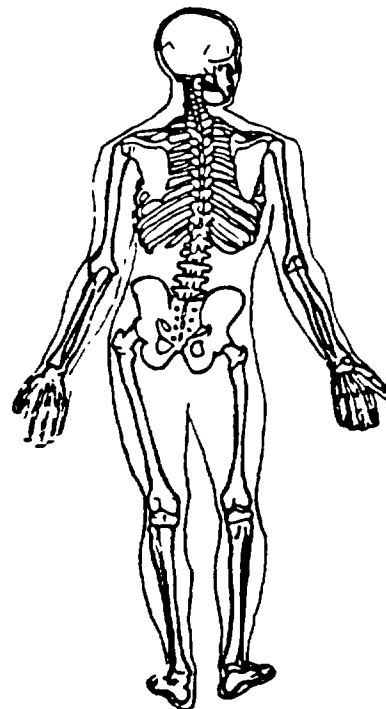
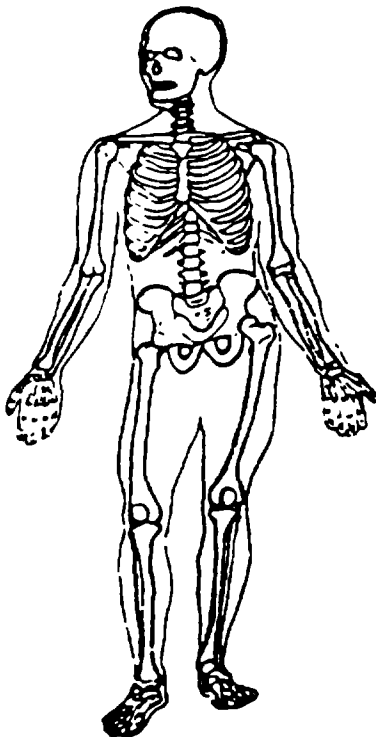

Write additional medical record injury information on reverse of this page.

Variable Name: Previous Recorded Suspensions and Revocations

Format: 1 column - numeric

Beginning
Column 59

Element Values:

Level 1 Range: 0 through 9

Blank - Driver not present (D09)

8 Fight or more

9 Unknown

Source: Official driver record.

Remarks:

"Blank" indicates that no driver was present.

Code "9" (Unknown) means that no official records were obtainable, independent of the reason for the record being unobtainable (i.e., record never existed, person never licensed, record not found, or record denied by cognizant state agency).

If the state record does not include the number of previous recorded suspensions and revocations, then this variable should be coded as "9" (Unknown).

Record the number of previous suspensions or revocations of the driver's license the state has listed on the record. The suspension or revocation need not be for a traffic violation (e.g., failure to appear at an accident hearing or failure to provide proof of financial responsibility could be grounds for suspension). Record the number listed for the "previous three years" inclusive from the date of the accident.

Previous is to be distinguished from current suspensions and revocations by the fact that for each previous suspension or revocation the driver's license must have been reinstated. Code each listing of suspension or revocation as a unique occurrence unless evidence to the contrary is clearly indicated. If the state record does not date reinstatements, it should provide an indication of current status. If the current status is "suspended" or "revoked" (or words to that effect) then do not include the last listed suspension or revocation unless it is clearly apparent that the current status is a consequence of the accident and was changed following it.

DRIVER FORM

1143

(2)

Variable Name: Previous Recorded Suspensions and Revocations

If the state record lists a suspension or revocation which, at the time of the accident, is considered to have been in effect (because evidence to the contrary is not present), and the police report lists the license as suspended or revoked, and the current status is listed as "clear" (or words to that effect), then assume the suspension or revocation was current at the time of the accident and do not count it.

Variable Name: Previous Recorded Accidents

Format: 1 column - numeric

Beginning
Column 60

Element Values:

Level 1 Range: 0 through 9

Blank - Driver not present (D09)

8 Eight or more

9 Unknown

Source: Official driver record.

Remarks:

"Blank" indicates that no driver was present.

Code "9" (Unknown) means that no official records were obtainable, independent of the reason for the record being unobtainable (i.e., record never existed, person never licensed, record not found, or record denied by cognizant state agency).

If the state record does not include the number of previous recorded accidents, then this variable should be coded as "9" (Unknown).

Record the number of previous accidents listed on the driver's record for the "previous three years" inclusive from the date of the accident.

If the state's driver records does not list previous accidents, then code "9" (Unknown).

Accident Level Versus Traffic Unit Level Environmental Data

There is a conceptual difference between the accident level and the traffic unit level environmental data. The accident level data are intended to represent the environment at the crash scene. In this sense, one can say that the accident level environmental variables represent at-crash data. On the other hand, the traffic unit level environmental variables are intended to provide the most representative description of the roadway environment that the driver (vehicle) had to cross just prior to the first harmful event. In this sense, one can say that the traffic unit level environmental variables represent the environment just prior to crash.

When determining either the accident or traffic unit level environmental data, the point of focus is at the location of the first harmful event. There are two mutually exclusive sets of locations in which the first harmful event can occur. They are: (1) in a junction (within the prolongation of the lines which form the boundary of the intersecting roadways) and (2) not in a junction. Recall that a junction is merely the area formed by the intersection of two roadways. Further, the roadways can be either a highway, road, or street, or one or both of the roadways can be an alley or driveway. In the latter case, there is a special rule for determining the accident level environment in a junction [see 2(a)(3) below]. Alleys and driveways can (in the vast majority of instances) be distinguished from highways, roads, and streets by the fact that the former are not named. Any exceptions to this "named rule" for distinguishing streets or roads from alleys or driveways should be handled on a case-by-case basis.

To determine the environmental variables, the investigator must begin by determining the location of the first harmful event. In the investigator's judgment, based upon review of the police report, scene inspection, participant interviews and, in some instances, vehicle inspection, the location of the first harmful event is either known or it is obscure. Let us deal with the latter situation first.

1. The location of the first harmful event is obscure. The investigator begins with the police report and adjusts the location determination based upon scene data, interviews, etc. However, if these additional sources fail to clarify the location, then the preponderance of the evidence from the police report must be relied upon. The two situations are as follows:

- (a) The police report depicts the accident as occurring in a junction. Upon review of the actual scene you are unsure as to whether or not the first harmful event actually did or did not occur within the prolongation of the lines forming the boundaries of the intersecting roadways; therefore, assume it did occur in a junction and proceed as if it did (i.e., follow the "in-a-junction" rules); or
- (b) The police report depicts the accident as occurring other than in a junction. Upon review of the actual scene you are unsure as to where the first harmful event actually occurred. Follow the "not-in-a-junction"

rules. However, if you do determine from the scene and other evidence that the location of the first harmful event was in a junction, then follow the "in-a-junction" rules.

2. The location of the first harmful event is known. The investigator either follows the rules pertaining to: (a) in-a-junction, or (b) not-in-a-junction to determine the roadway segment or segments for which the environmental variables are reported.

(a) In-a-junction. First, determine the traffic unit level environmental variables for each in transport vehicle. Go independently to the mouth of the roadway that brought each vehicle into the junction. In the case of a vehicle abandoned in a junction, go to the mouth of the roadway that most likely brought the vehicle into the junction. Verify the identity of each involved roadway. The identity is needed so that each roadway's federal aid and functional classification can be subsequently determined from a map in-office. Collection of each roadway's classification is required so that the accident level comparison (below) can be accomplished. Next, follow the guidelines presented for variable D45 (Number of Travel Lanes) and determine the total number of lanes for each vehicle's roadway (at the mouth). Finally, determine for each of the remaining variables (D46-D49, D51-D59) the values for each vehicle that are most representative of the driver's (vehicle's) environment back along the vehicle's (driver's) path just prior to its involvement in the collision. The phrase "just prior" is purposely left vague since the decision rests with the investigator. However, the distance should only go so far as is needed to include those points of transition which are most representative of the environment. Your judgment will be evaluated on the basis of the reasonableness of your selections.

After completing the traffic unit level environmental variables for each roadway involved, proceed to the accident level environmental variables. Where multiple roadways were involved in the accident's first harmful event, select, according to the following rules, one of the roadways on which a vehicle involved in the first harmful event was travelling just prior to its entrance into the junction:

- (1) Choose the roadway with the higher (lower numerically) Federal Aid System (A21) classification. If the values are the same, then proceed to rule (2). In either case, record the value in variable A21, Federal Aid System.
- (2) Choose the roadway with the greater number of lanes (variable D45). If the number of lanes are the same, then proceed to rule (3).
- (3) Choose the roadway on which the most at-fault driver was travelling, except for alleys and driveways where the street used by the other vehicle is always chosen. (NOTE: This exception applies only to

in-a-junction accidents. If the first harmful event occurred outside the junction and on the driveway or alley, then the not-in-a-junction rules are followed and the driveway or alley is selected at the accident level.)

If all of the in transport vehicles involved in the accident's first harmful event came from the same roadway, then select that roadway. Once you have chosen the roadway, complete the accident level environmental variables (A27-A31, A33-A41) based on the values recorded for that roadway's traffic unit level environmental variables (D45-D49, D51-D59). The values will be nearly identical.

- (b) Not-in-a-junction. [NOTE: An accident whose Relation to Junction (A24) was listed as "intersection related" (code "06") is an example of an accident not in a junction.] Determine the traffic unit level environmental variables for each in transport vehicle before attempting to determine the accident level environmental variables. Since the location of the first harmful event is not in a junction, the investigator must proceed, in accordance with the guidance which follows, to determine both the traffic unit and accident level environmental variables.

If the first harmful event did not occur in a junction, then there are two mutually exclusive locations in which it did occur. These are: (1) off the roadway, or (2) on the roadway.

- (1) Off roadway: For each in transport vehicle involved in the first harmful event, return to the location where the vehicle was last on a roadway. For this determination, "on roadway" means that any part of the vehicle was in contact with the roadway. However, if a vehicle leaves one roadway and enters another roadway other than in the manner that the second roadway was designed to be travelled, ignore the second roadway and return to the location at which the first roadway was last departed. For example: (Situation A) Vehicle leaves roadway X, crosses a field and enters roadway Y. Vehicle crosses roadway Y laterally until it impacts (a) an object (e.g., median barrier), (b) another motor vehicle, or (c) an object on the other side of the roadway. In any of these cases, return to roadway X to record the vehicle's traffic unit level environmental variables. (Situation B) Vehicle leaves roadway X to short-cut traffic ahead. Vehicle, while attempting to merge longitudinally on roadway Y, impacts (a) an object--on or off the roadway, but on the trafficway, or (b) another motor vehicle. In either of these cases, consider the vehicle to be associated with roadway Y.

If a vehicle is in transport on a trafficway but not on a roadway (e.g., motorcyclist riding along on the shoulders or roadside), assign the vehicle to the roadway which best fits the vehicle's direction of travel. Use the point on the chosen roadway nearest the first harmful event.

Once you have determined the location where the vehicle last left the roadway (or each vehicle in the case of an accident involving multiple vehicles which leave their roadway prior to their involvement in the accident), the selection process for the proper values for the traffic unit level environmental variables is the same as for vehicles whose first harmful event was on the roadway. See (2) below for remaining instructions.

If a vehicle departed the roadway from a junction prior to the first harmful event, go to the mouth of the roadway that brought the vehicle into the junction to determine the traffic unit level environmental variables.

- (2) On roadway: Go to the location of the first harmful event [location where the vehicle last left the roadway if it occurred "off roadway" in (1) above]. Determine the number of lanes (D45) for each involved vehicle by selecting the value which provides the most representative description of the driver's roadway leading to this location. Make this determination, and all subsequent traffic unit level environmental determinations (D46-D49, D51-D59), by looking back along the vehicle's path just prior to the impact. The phrase "just prior" is purposely left vague since the decision rests with the investigator. However, the distance should only go so far as is needed to include those points of transition which are most representative of the environment. Your judgment will be evaluated on the basis of the reasonableness of your selections.

For the accident level environmental variables, use a generalized cross-section of the roadway at the location of the first harmful event or the location where the vehicle last left the roadway if it occurred "off roadway". Record Federal Aid System (A21) for the roadway at this location. In addition, determine the appropriate values for each of the remaining accident level environmental variables (A27-A31, A33-A41).

One special rule needs to be considered for the accident level determination. If the location of the first harmful event is one and the same as an area of transition (of any kind: straight-curve, level-grade, wet-dry, concrete-bituminous, etc.) record the transition according to the following rules:

- (01) Choose undivided over divided;
- (02) Choose other divisions over barrier division;
- (03) Choose partial control over partial access controls;
- (04) Choose no control over partial access controls;
- (05) Choose shoulders over no shoulders;
- (06) Choose two shoulders over one;
- (07) Choose curve over straight;
- (08) Choose grade over level;

- (09) Choose hillcrest or sag over grade;
- (10) Choose other surface types over concrete;
- (11) Choose gravel, dirt, brick or block over bituminous;
- (12) Choose gravel or dirt over brick or block;
- (13) Choose dirt over gravel;
- (14) Choose nondry surface conditions over dry;
- (15) Choose snow or slush over other nondry conditions;
- (16) Choose ice over wet or other conditions; and,
- (17) Choose wet over other conditions.

The location of the first harmful event and the subsequent selection of the accident level environmental variables can occur from a roadway that differs from any roadway on which an in transport vehicle was travelling. In this case the accident and driver level environmental variables may be different. This is true primarily in single vehicle collisions. An example of this occurs when a vehicle is attempting to negotiate a junction, and it impacts an object outside of the junction but on another roadway (different street or different leg of the same street but which has different attributes than the other leg). Further, in the opinion of the investigator, the former roadway is the one most representative of the vehicle's (driver's) environment just prior to the collision. (See next page for examples.) However, there is an exception to this general rule. This exception occurs when the other roadway would not qualify as a NASS roadway if it were not for the "throat" rule (see Variable A24, Relation to Junction, fifth page, paragraphs 5 and 6). In these instances, the accident level environmental variables should be the same as the traffic unit level environmental variables for the involved in transport vehicle.

The accident and traffic unit level variables may also differ where a vehicle was not attempting to negotiate a junction. Recall on sub-page (3) Situation A where a vehicle departed roadway X, prior to its junction with roadway Y, but enters roadway Y laterally before a harmful event occurs. If the vehicle impacts an object or a pedestrian or nonmotorist (see P08, Pedestrian or Nonmotorist's Type) on the road, then use roadway Y for the accident level and roadway X for the traffic unit level. However, if the object or pedestrian or nonmotorist was not impacted until after the vehicle crossed the road for roadway Y, then roadway X would be used at both the accident and traffic unit levels.

For those in transport vehicles not involved in the accident's first harmful event (but involved in the accident), determine the traffic unit level environmental variables for that vehicle from the area preceding the location where that vehicle sustained its initial damage or its occupants were initially injured.

EXAMPLE:

Sub/D44
(6)

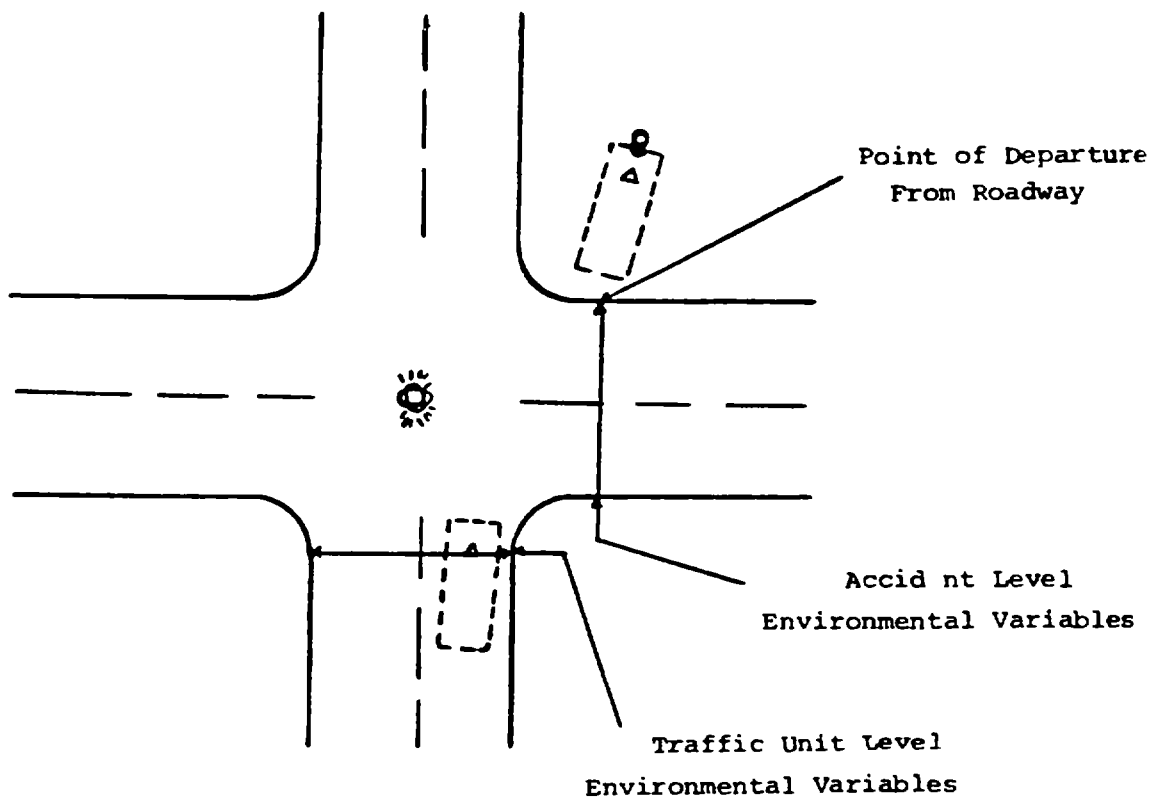
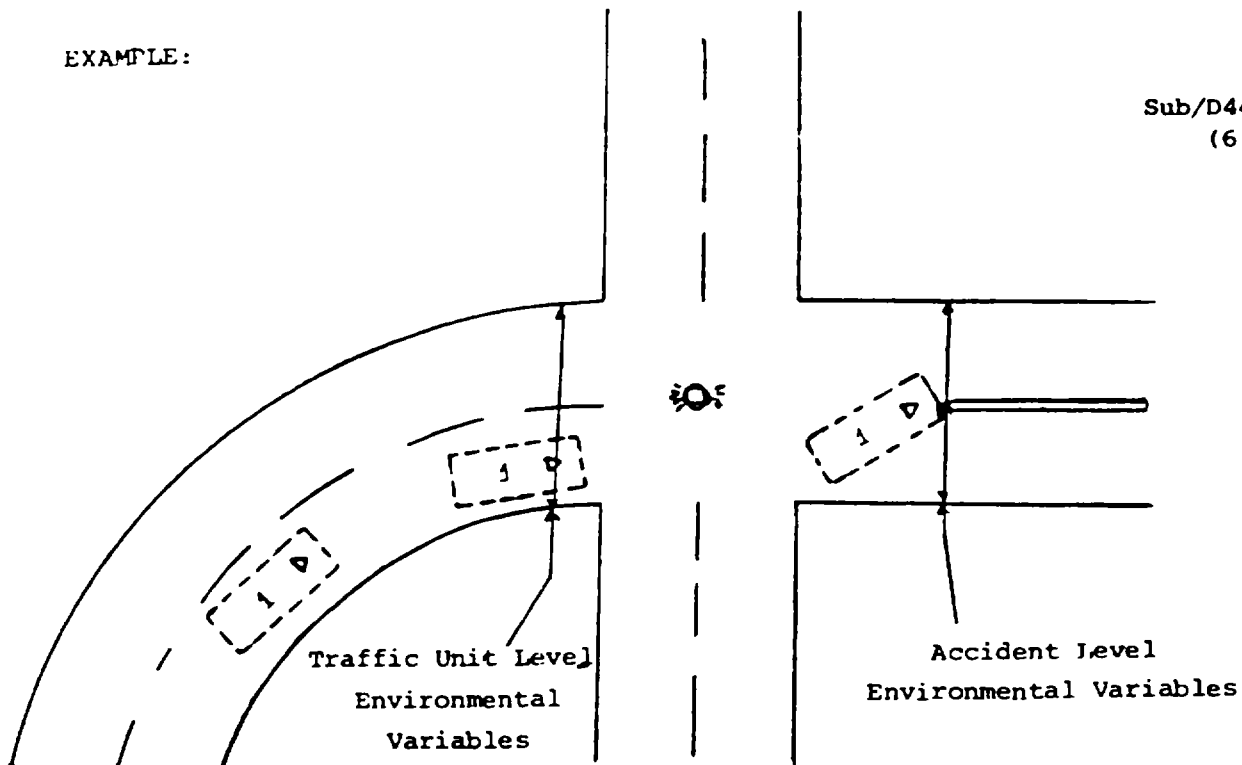

DRIVER FORM

Sub/D44
(7)

Variable Name: Was the Driver's Vehicle in a School Zone (for use in coding A40)

Format: None

Beginning Not
Column Applicable

Element Values:

Yes
No

Source: Primary source is scene inspection; secondary sources include the police report and the driver interview.

Remarks:

The attribute is determined from the same roadway which was used to determine the Number of Travel Lanes (D45). It is associated with the location of this vehicle's first harmful event.

The investigator selects the descriptor that best represents the vehicle's environment just prior to the impact. (NOTE: If uncertainty exists concerning the location of the first harmful event, refer to point "1" in the accident level versus traffic unit level environmental data discussion, following D44, Previous Recorded Accidents.)

Yes should only be used if a sign or road marking was present and the accident occurred during the time the sign or marking was in effect (i.e., this applies to the applicable time periods before, during, and following school sessions).

Variable Name: Number of Travel Lanes

Format: 1 column - numeric

Beginning
Column 61

Element Values:

- 1 One
- 2 Two
- 3 Three
- 4 Four
- 5 Five
- 6 Six
- 7 Seven or more
- 9 Unknown

Source: Primary source is scene inspection; secondary sources include the police report and the driver interview.

Remarks:

If the collision occurred other than in a junction, code the value on the basis of the most representative description of this driver's roadway leading to the location of this vehicle's first harmful event.

If the first harmful event occurs off the roadway, code the value on the basis of the most representative description of the roadway leading to the point of departure.

If the first harmful event is located in the junction of two or more roadways, code the number of lanes on the basis of the most representative description of the approach leg to the junction for this vehicle.

A roadway is that part of a trafficway where vehicles travel. A divided trafficway is composed of two or more roadways.

If traffic flows in both directions and is undivided, code the number of lanes in both directions. If the trafficway is divided into two or more roadways, code only the number of lanes for the roadway on which the vehicle under consideration was travelling.

If turn bays, acceleration, deceleration, or two-way left turn lanes exist and are physically located within the cross section of the roadway where the first harmful event occurred, and these lanes are the most representative of the driver's environment just prior to the impact, then they are to be included in the number of lanes. Channelized lanes, by their definition (see ANSI D16.1-1976, section 2.5.13), are separated from other through or turn

Variable Name: Number of Travel Lanes (cont'd.)

related lanes. (NOTE: The separation normally will not involve a physical barrier.) Because a channelized lane is separated, it should not be included unless it is preceded by a turn bay or turn lane and this bay or lane is felt to be most representative of the driver's environment just prior to impact.

The number of lanes counted includes any of which are narrowed or rendered unusable by restriction of the right-of-way cited in variables A42 (Restriction of Roadway at Scene) or A43 (Additional Restriction of Roadway at Scene).

Only those lanes ordinarily used for motor vehicle travel should be considered when coding this variable (i.e., pedestrian/bicycle lanes are excluded).

In a number of instances, there will be uncertainty as to the number of lanes due to: (1) nonstandard roadway widths; (2) variability of width in the same roadway due to disrepair and other reasons; or (3) absence of lane, center, and edge lines, etc. The number coded in these cases should represent the number of operational lanes based on customary or observed usage.

On a road that has legal parking such that the legal parking area ends short of the junction of the roadway with another roadway or drive, and the space left between the end of the legal parking area and the beginning of the junction can be utilized for turning by a vehicle on the roadway, do not consider this additional area as another travel lane (regardless of customary or observed usage in this instance). This area should be construed as additional width to the existing travel lane(s). The only time that another lane will be counted at a junction is when that space is expressly designated for turning [e.g., by lane (line or turn arrow) marking, signs, or signals].

The number of lanes for driveways, widemouth parking lots, etc. should be coded as follows: If it is possible to determine the number of lanes through either lane markings or observed or customary use, code the actual number of lanes present. If the number of lanes cannot be accurately established, use code "9" (unknown).

If the vehicle was on a channel or an entrance or exit ramp (A24, Relation to Junction, codes "07" and "09" respectively), code the number of lanes for that roadway section (also see D46, Median Type, remarks).

If the vehicle was in a crossover or on a driveway (see A24, Relation to Junction, definitions for codes "11" and "13") which is in essence a private way (ANSI D16.1-1976, section 2.2.2, page 5), code the number of lanes for that vehicle.

Variable Name: Median Type

Format: 1 column - numeric

Beginning
Column 62

Element Values:

- 0 No median
- 1 Curbed
- 2 Positive barrier
- 3 Unprotected
- 9 Unknown

Source: Primary source is scene inspection; secondary sources include the police report and the driver interview.

Remarks:

The attribute is determined from the same roadway which was used to determine the Number of Travel Lanes (D45). It is associated with the location of this vehicle's first harmful event.

The investigator selects the descriptor that best represents the vehicle's environment just prior to the impact. (NOTE: If uncertainty exists concerning the location of the first harmful event, refer to point "1" in the accident level versus traffic unit level environmental data discussion, following D44, Previous Recorded Accidents.)

Two-way left turn lanes do not divide a trafficway.

Physical division of roadways (e.g., concrete traffic barrier) overrides simple lateral division (e.g., grass median); therefore, code "2" (Positive barrier) takes precedence over codes "1" (Curbed) and "3" (Unprotected).

In order to code this variable the investigator must first determine if the trafficway was divided at the point of assessment. A trafficway may be divided into two or more roadways. Any intentional separation (see exception below) of travel lanes, either opposing or lanes in the same direction, constitutes a division of a trafficway. Separations can be composed of physical barriers in addition to lateral distance. Further definitions help to describe medians:

Variable Name: Median Type (cont'd.)

1. Medians provide an insulating area between streams of moving traffic.
2. Medians provide protection and control of cross and turning traffic.
3. Medians provide a refuge for pedestrians.

Medians and gores (see Remarks section for A12, Relation to Roadway, for definitions) separate roadways. A traffic island (associated with a channel) separates travel lanes but does not constitute a division of a trafficway because the associated channelized lane(s) is (are) not considered to be a separate roadway.

Entrance and exit ramps (see remarks section for A24, Relation to Junction, code "09" for definition) are considered separate (unique) roadways. Therefore, even though they are divided from their primary roadway [i.e., the one used for Federal Aid System (A21) classification purposes], their division is assessed independently. Ramps are not considered divided unless two ramps exist adjacent separated by a median (with or without a physical barrier). A ramp can divide into two ramps. A gore separates the ramps. The gore does not constitute a division.

Multiple medians could be present. If they are not, then this variable reports about the median that is present. If more than one is present and the first harmful event occurred in median (code "3" for A12, Relation to Roadway), then this variable reports about the median involved in the first harmful event. If more than one is present and the first harmful event did not occur in a median, then this variable reports about the first median laterally to the left (with respect to normal traffic flow) from the first harmful event.

Code "0" (No median) if no medians are present independent of the presence of a gore or traffic island. Variable D47, Median Width, must equal "00" (No median), and variable D49, Trafficway Flow, must equal either "0" [Not physically divided (two way traffic)] or "3" (One way trafficway).

Code "1" (Positive barrier) refers to all concrete or other types of longitudinal barriers (i.e., all manufactured barriers). Also, bridge or underpass supporting structures and bridge rails take this code.

Code "3" (Unprotected) includes any vegetation, gravel, or paved flush--painted or unpainted--medians.

Vegetation or gravel median includes trees, water, embankments, and ravins that separate a trafficway (i.e., nonmanufactured barrier).

Variable Name: Median Type (cont'd.)

A painted flush median can be described as solid painted lines spaced apart with the intent to divide a trafficway into two or more roadways. The intent to divide means to purposely create a safety zone between streams of traffic.

Division does not occur when double no passing lines are present and separated by no more than the width of a center line--allow a margin of error for poor workmanship. If a distance greater than the width of a painted line (about 4 inches and not attributable to poor workmanship, exists between two painted (should be "solid") center lines, then a separation is considered to have occurred.

Variable Name: Median Width

Format: 2 columns - numeric

Beginning
Column 63

Element Values:

Code actual measured value up to 96 feet

00 No median

97 97 feet and above

99 Unknown

Source: Primary source is scene inspection; secondary sources include the police report and the driver interview.

Remarks:

The attribute is determined from the same roadway which was used to determine the Number of Travel Lanes (D45). It is associated with the location of this vehicle's first harmful event.

The investigator selects the descriptor that best represents the vehicle's environment just prior to the impact. (NOTE: If uncertainty exists concerning the location of the first harmful event, refer to point "1" in the accident level versus traffic unit level environmental data discussion, following D44, Previous Recorded Accidents.)

Code "00" (No median) if no median (code "0") was coded for D46, Median Type.

Medians are measured to the nearest foot from the center of roadway edge line to edge line, where present, or roadway edge (best estimate) to roadway edge, where edge lines are absent. Inside shoulders are thus included since the shoulder (for NASS purposes) may be a variety of surface types and its exact width difficult to determine.

Code "01" (1 foot) includes all distances less than 1.5 feet.

In some instances estimation may be required because of physical difficulties in taking the measurement at the appropriate location. The investigator should always attempt to obtain as good an approximation as possible. In some cases a point nearby can be used; other times the measurement may have to be made at a substantial distance (e.g., location of first harmful event is on a bridge spanning a river).

If the width varies substantially in the area that fits the most representative description, then multiple measurements and averaging are required.

Variable Name: Access Control

Format: 1 column - numeric

Beginning
Column 65

Element Values:

- 1 Full
- 2 Partial
- 3 Uncontrolled
- 9 Unknown

Source: Primary source is scene inspection; secondary sources include the police report and the driver interview

Remarks:

The attribute is determined from the same roadway which was used to determine the Number of Travel Lanes (D45). It is associated with the location of this vehicle's first harmful event. If the roadway is an entrance or exit ramp, ANSI (D16.11976, section 3.7.3.4, pages 26-27) requires that the ramp be coded (full, partial, or uncontrolled) the same as the roadway of the higher (lower) numerically) Federal Aid System classification (A21) which it connects. Determine which of the connected roadways is higher [if they are the same (A21), then choose the one that led to the ramp] and determine the value for this variable at the general area where the ramp connects with the roadway.

The investigator selects the descriptor that best represents the vehicle's environment just prior to the impact. (NOTE: If uncertainty exists concerning the location of the first harmful event, refer to point "1" in the accident level versus traffic unit level environmental data discussion, following D44, Previous Recorded Accidents.)

Code "1" (Full) refers to those situations where the authority to control access is exercised to give preference to through traffic to a degree that, in addition to access connections with selected public roads, there may be some crossings at-grade and some private driveway connections.

Code "2" (Partial) refers to those situations where the authority to control access is exercised to give preference to through traffic to a degree that, in addition to access connections with selected public roads, there may be some crossings at-grade and some private driveway connections.

Code "3" (Uncontrolled) refers to those situations where the authority having jurisdiction over a highway, street, or road, does not limit the

Variable Name: Access Control

number of points of ingress or egress except through the exercise of control over the placement and geometrics of connections as necessary for the safety of the travelling public.

In summary, consider the roadway section which was chosen for the reporting of the Number of Travel Lanes, D45. If there are no at-grade crossings, then code "1". If at-grade crossings exist but there is an indication that a limiting of access is taking place, then code "2". If no indication of access limiting can be found, then code "3". If a decision cannot be made, code "9".

Variable Name: Trafficway Flow

Format: 1 column - numeric

Beginning
Column 66

Element Values:

- 0 Not physically divided (two way traffic)
- 1 Divided trafficway - median strip without traffic barrier
- 2 Divided trafficway - median strip with traffic barrier
- 3 One way trafficway
- 9 Unknown

Source: Primary source is scene inspection; secondary sources include the police report and the driver interview.

Remarks:

The attribute is determined from the same roadway which was used to determine the Number of Travel Lanes (D45). It is associated with the location of this vehicle's first harmful event.

The investigator selects the descriptor that best represents the vehicle's environment just prior to the impact. (NOTE: If uncertainty exists concerning the location of the first harmful event, refer to point "1" in the accident level versus traffic unit level environmental data discussion, following D44, Previous Recorded Accidents.)

Code "0" [Not physically divided (two way traffic)] can only be used whenever D46, Median Type, is coded "0" (No median). Remember although gores separate roadways and traffic islands (associated with channels) separate travel lanes, neither is involved in the determination of trafficway division (see remarks section for D46, Median Type).

Code "1" (Divided trafficway - median strip without traffic barrier) and "2" (Divided trafficway - median strip with traffic barrier) most likely will be used whenever a trafficway division is reported [i.e., D46, Median Type, equal "1" (Curbed), "2" (Positive barrier), or "3" (Unprotected)]. It is presumed that the traffic travels in but one direction on the roadway associated with the location of the first harmful event. If multiple medians are present, choose the first median encountered laterally to the left (with respect to the normal traffic flow) from the first harmful event. A traffic barrier is any positive barrier (see code "2" for D46, Median Type). If the median has a barrier code "2"; otherwise, code "1" should be used.

Code "3" (One way trafficway) is used primarily whenever the trafficway is undivided [code "0" (No median) for D46, Median Type] and traffic flows in

Variable Name: Trafficway Flow

but one direction (e.g., one-way streets). However, this code can also be used where a median is present so long as all the traffic on the trafficway goes in the same direction. An example occurs where the opposing roadway of the same named trafficway had to be split by such a distance that the right-of-way divides to accommodate other property. If (rare) one of the trafficways is further divided into multiple roadways by a median, then in this instance code "3" (One way trafficway) should be used.

Variable Name: Highway Performance Monitoring System
(HPMS) Sample Number

Format: 13 columns - alphanumeric (First column
is numeric and identifies the county with
the PSU.)

Beginning
Column 67

Element Values:

Code value contained on maps supplied by NCSA
00000000000000 Not in HPMS sample
99999999999999 Unknown
----- (Blank) HPMS data not available

County Codes: PSUs that do not have multiple counties should use a county
code of "1".

<u>PSU 12</u>	<u>PSU 38</u>	<u>PSU 59</u>	<u>PSU 82</u>
1 Green	1 Charles	1 Kemper	1 Bernalillo
2 Iowa	2 Prince Georges	2 Lauderdale	2 Sandoval
3 Lafayette		3 Newton	
	<u>PSU 52</u>	<u>PSU 60</u>	<u>PSU 83</u>
<u>PSU 13</u>	1 Shelby	1 Natchitoches	1 Harding
1 Benton	2 St. Clair	2 Winn	2 Lawrence
2 Jasper		3 Jackson	3 Butte
3 Newton	<u>PSU 53</u>	<u>PSU 76</u>	4 Meade
4 White	1 Lincoln	1 Skagit	5 Corson
	2 Desha	2 San Juan	6 Dewey
<u>PSU 14</u>	3 Chicot	3 Island	7 Ziebach
1 Appanoose	4 Ashley		8 Perkins
2 Monroe	5 Drew		
3 Lucas		<u>PSU 80</u>	<u>PSU 84</u>
4 Wayne	<u>PSU 54</u>	1 Gilpin	1 Zapata
5 Decatur	1 Rutherford	2 Jefferson	2 Jim Hogg
6 Clarke	2 Cleveland		3 Starr
			4 Brooks
			5 Kenedy
			6 Willacy

Source: NCSA supplied maps.

Remarks:

Most counties or cities within the PSUs contain highway road segments which are part of FHWA's Highway Performance Monitoring System (HPMS). When the location of the first harmful event occurs in one of these segments, that segment's FHWA assigned code is to be reported on this variable. Since the codes are not county independent, PSUs with multiple counties must specify the county in which the highway segment was located. The first column of

Variable Name: Highway Performance Monitoring System
(HPMS) Sample Number [cont'd.]

this 13 column field is reserved for the county code. Single county and city PSUs use a county of "1" in the first column.

It may or may not be difficult to determine exactly where the HPMS segment begins and/or ends. If the segment begins and/or ends near a junction, be sure to include the junction in the segment so that in-junction first harmful events will be covered. However, remember that a vehicle must be travelling on the roadway which is sampled for the junction accident to be considered associated with the HPMS segment.

If the first harmful event occurred in the segment but the most representative description of the driver's (vehicle's) environment just prior to the collision would not be in the segment, then code "000000000000" (Not in HPMS sample) (e.g., junction accident in which the segment begins on the opposite side of the roadway from the vehicle's direction of travel). If the first harmful event occurs outside the segment but the most representative description of the driver's environment just prior to the collision corresponds with the segment, then encode the segment's code (e.g., the first harmful event occurs just beyond the junction at which the segment ends). If the first harmful event occurs off roadway and the most representative description of the driver's environment just prior to the collision measured from the last point at which the vehicle was on a roadway is in the segment, then encode the segment's code. If it cannot be determined if the driver's environment was in the segment (e.g., because it is unclear where the segment begins or ends), then code "999999999999" (Unknown).

DRIVER FORM

D51
D52

Variable Name: Shoulder Type - Left
Shoulder Type - Right

Format: 1 column - numeric

Beginning
Column 80
81

Element Values:

- 0 No shoulder
- 1 Surfaced 2-6 ft.
- 2 Surfaced > 6 ft.
- 3 Gravel or other granular material 2-6 ft.
- 4 Gravel or other granular material > 6 ft.
- 5 Natural earth, with or without turf 2-6 ft.
- 6 Natural earth, with or without turf > 6 ft.
- 9 Unknown

Source: Primary source is scene inspection; secondary sources include the police report and the driver interview.

Remarks:

The attribute is determined from the same roadway which was used to determine the Number of Travel Lanes (D45). It is associated with the location of this vehicle's first harmful event.

The investigator selects the descriptor that best represents the vehicle's environment just prior to the impact. (NOTE: If uncertainty exists concerning the location of the first harmful event, refer to point "1" in the accident level versus traffic unit level environmental data discussion, following D44, Previous Recorded Accidents.)

Consider the same lanes which were used to determine the Number of Travel Lanes (D45), and report the presence of shoulders for those same lanes at, and lateral to, the location of this vehicle's first harmful event, unless at a junction. In the case of a first harmful event located within a junction, select the element value based on the leg of the roadway that this vehicle was travelling on prior to its entrance into the junction.

A shoulder is defined as that part of a trafficway (1) contiguous with the roadway for emergency use, (2) for accommodation of stopped road vehicles, and (3) for lateral support of the roadway structure (see ANSI D16.1-1976, section 2.2.18, pages 6-7).

D51

D52

(2)

Variable Name: Shoulder Type - Left (cont'd.)
Shoulder Type - Right (cont'd.)

Contiguous surfaces fall into two categories--stabilized and unstabilized. Stabilized means that: (1) the surface was paved with a portland cement concrete or bituminous coarse surface on a granular or improved base, or (2) the earth has been covered with a gravel or other granular material. Unstabilized means that the surface is composed of natural earth, with or without turf.

Accommodation means that at least a minimum of two (2) feet of area contiguous to the roadway is provided. In other words, the entire width of the vehicle under consideration does not have to fit on the contiguous area to qualify the area as a shoulder. If edge lines are present when you measure the lateral distance, measure from the center of the edge line.

In order to provide lateral support to the roadway, the shoulder's surface condition does not have to be stabilized. If the shoulder surface has separated (i.e., eroded away) to expose the base of the roadway, creating an unsafe departure for vehicles, then the lateral support criterion is not met. However, it must be emphasized that the "base" must be exposed. Pavement lips or cracking along the edge of the roadway surface do not by themselves constitute a lacking of lateral support.

The area is a shoulder if it is contiguous to the roadway, provides lateral support to the roadway, and is two feet or greater in width. A raised traffic island at the mouth of a roadway should be considered like a barrier curb on the road edge and thus not a shoulder. A designated parking lane should not be considered a shoulder for NASS purposes. On the other hand, a painted flush island or a paved median between two edgelines should be considered a shoulder. If the traffic island is the most representative description of the driver's environment just prior to impact, then select the appropriate response.

On these variables, the investigator should identify not only the presence (codes "1" through "6") of a shoulder, but also its type. Using the definitions above, code the attribute which best describes the shoulder type. Surfaced stabilized areas (codes "1" and "2") take precedence over gravel or granular stabilized areas (codes "3" and "4") and over unstabilized areas (codes "5" and "6"). For areas of the same type, but different surfaces within that type, add the widths of the surfaces together [e.g., 3 ft. turf and 5 ft. ground equals 8 ft. of "Natural earth, with or without turf" (code "6")]. For example, an area composed of a 3 foot wide gravel stabilized area followed by an additional 5 feet of unstabilized area, would be coded "3" (Gravel or other granular material 2-6 ft.). On the other hand, an area composed of 3 feet of bituminous coarse surface followed by an additional 5 feet of gravel would be coded as "1" (Surfaced 2-6 ft.). Likewise, 3 feet of concrete followed by 2 feet of gravel and 4 feet of grass is coded as "1"

DRIVER FORM

D51
D52
(3)

Variable Name: Shoulder Type - Left (cont'd.)
Shoulder Type - Right (cont'd.)

(Surfaced 2-6 ft.). Further, a 1 foot wide granular area adjacent to 7 feet of grass-covered earth is coded "6" (Natural earth, with or without turf > 6 ft.) since a minimum of two feet of granular area was not present. Finally, 1 and 1/2 feet of concrete between the roadway and a guardrail would be coded as "0" (No shoulder) since the accommodation criterion is not satisfied.

Code "0" (No shoulder) if the roadway is curbed and has no shoulders; code the appropriate response if there are both curbs (mountable) and shoulders (probably either code "1" or "2").

Code "0" (No shoulder) for any private way (ANSI D16.1-1976, section 2.2.2, page 5) that only becomes a NASS roadway because the accident is coded as driveway, alley access related (code "11") on A24, Relation to Junction [see Remarks page (15)].

Shoulders are still present even if not usable at the time of the accident due to ambient conditions such as plowed snow, parked vehicles, etc.

Pedestrian/bicycle lanes which exist between the roadway and improved shoulder, or outside but contiguous with the improved shoulder should be considered as extra shoulder width (examples 1 and 2 below). Pedestrian/bicycle lanes which exist contiguous with the roadway and bounded on the outside edge (i.e., curb, ditch, etc.) should not be considered a shoulder (example 3).

Variable Name: Roadway Alignment

Code "1" (Straight) refers to a horizontal surface which is tangent.

Codes "2" (Curve right) and "3" (Curve left) refer to a horizontal surface in transition between two points of tangency as in the examples below. The vehicle's direction of travel determines whether the curvature is right or left.

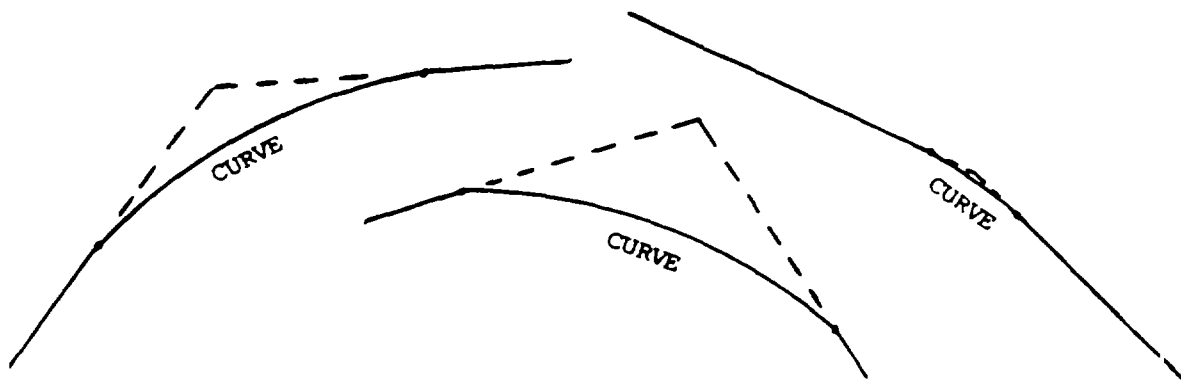

Any perceptually-determined curvature between two tangent sections of a roadway constitutes a curve.

Variable Name: Roadway Profile

Format: 1 column - numeric

Beginning
Column 83

Element Values:

- | | | |
|---|--------------------|--|
| 1 | Level (< 2% grade) | Slope |
| 2 | Positive grade | Measurement: (Please write the resultant |
| 3 | Negative grade | percentage in this space on |
| 4 | Hillcrest | the driver form.) |
| 5 | Sag | (v= _____)/(h= _____) |
| 9 | Unknown | |

Source: Primary source is scene inspection; secondary sources include the police report and the driver interview.

Remarks:

The attribute is determined from the same roadway which was used to determine the Number of Travel Lanes (D45). It is associated with the location of this vehicle's first harmful event.

The investigator selects the descriptor that best represents the vehicle's environment just prior to the impact. (NOTE: If uncertainty exists concerning the location of the first harmful event, refer to point "1" in the accident level versus traffic unit level environmental data discussion, following D44, Previous Recorded Accidents.)

The slope measurement, horizontal (level) distance and vertical (perpendicular) distance must be measured in the area where the traffic unit level variables are taken and recorded in the spaces provided on the CSS forms.

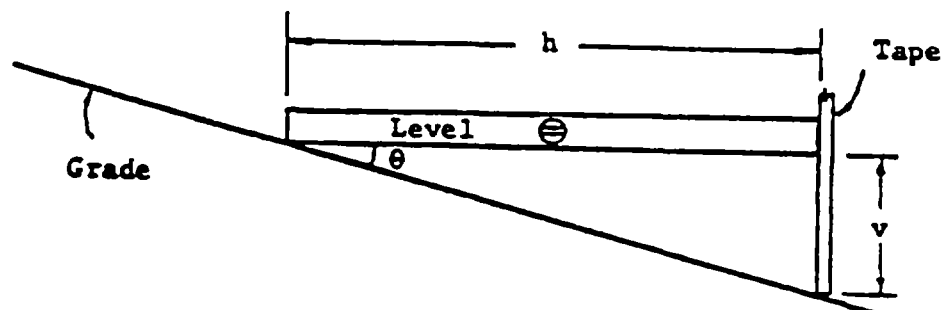

Code "1" [Level (< 2% grade)] refers to a tangent surface whose gradient is <2%.

Variable Name: Roadway Profile

Codes "2" (Positive grade) and "3" (Negative grade) refer to a tangent surface whose gradient is $\geq 2\%$. The vehicle's direction of travel determines whether the grade is positive (uphill) or negative (downhill).

Code "4" (Hillcrest) refers to a surface in vertical transition between two points of tangency as in the following examples:

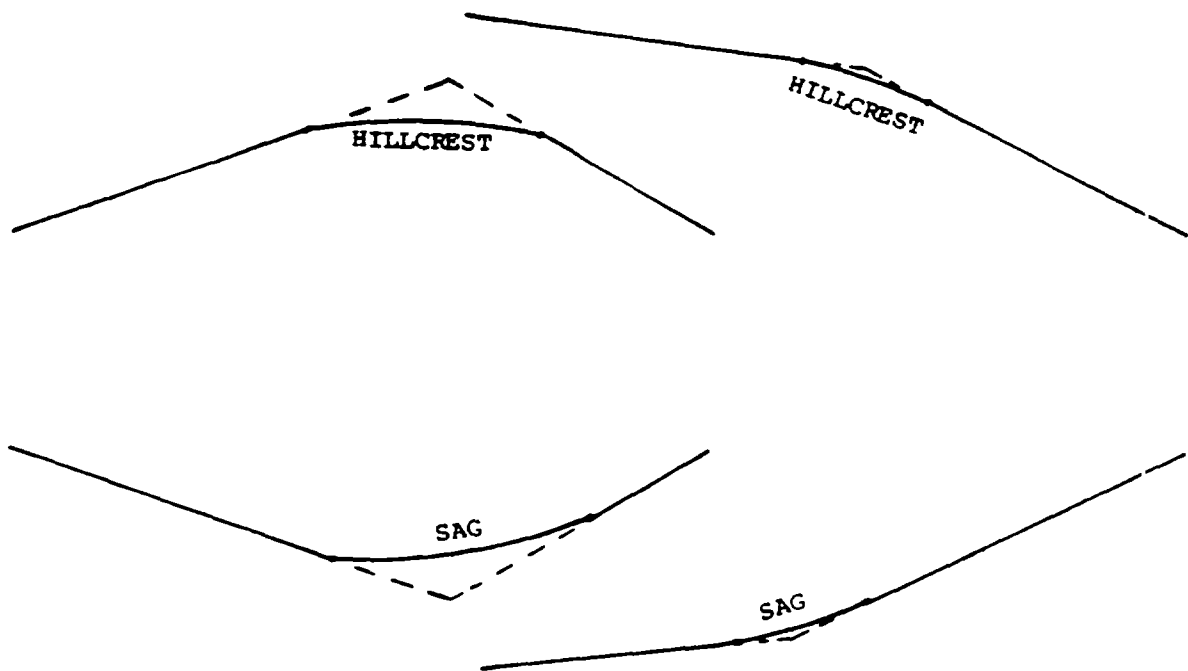

Code "5" (Sag) refers to a surface in vertical transition between two points of tangency as in the above examples:

Variable Name: Roadway Surface Type

Format: 1 column - numeric

Beginning
Column 84

Element Values:

- 1 Concrete
- 2 Bituminous [asphalt]
- 3 Brick or block
- 4 Slag, gravel or stone
- 5 Dirt
- 8 Other (specify)
- 9 Unknown

Source: Primary source is scene inspection; secondary sources include the police report and the driver interview.

Remarks:

The attribute is determined from the same roadway which was used to determine the Number of Travel Lanes (D45). It is associated with the location of this vehicle's first harmful event.

The investigator selects the descriptor that best represents the vehicle's environment just prior to the impact. (NOTE: If uncertainty exists concerning the location of the first harmful event, refer to point "1" in the accident level versus traffic unit level environmental data discussion, following D44, Previous Recorded Accidents.)

If the lateral cross section contains lanes of more than one surface type, code the surface type of the lane the driver's vehicle was travelling on prior to impact.

Variable Name: Roadway Surface Condition

Format: 1 column - numeric

Beginning
Column 85

Element Values:

- 1 Dry
- 2 Wet
- 3 Snow or slush
- 4 Ice
- 5 Sand, dirt or oil
- 8 Other (specify)
- 9 Unknown

Source: Primary sources are the police report and the driver interview; a secondary source is the scene inspection.

Remarks:

The element value selected is based on the location which the investigator determines best represents the driver's pre-crash environment. In determining the surface condition, the investigator should use police reports, interviews and observation of the site; do not report the conditions which are observed several days following the accident unless they are felt to be the same as those at the time of the accident.

Consider the same lanes which were used to determine the Number of Travel Lanes (D45) and report the surface condition for those lanes.

It is possible for different surface conditions to exist on the same roadway (e.g., intermittent wet and dry sections). The investigator should consider, but not necessarily be restricted by, the information on the police report for making this assessment. The Driver Form (for the vehicle which was on the above travel lanes) should also be consulted. Although it may be difficult to ascertain the surface condition for a particular section, the investigator should attempt to obtain a value which is most representative of the condition for those lanes.

If sand, dirt or oil (code "5") occurs in combination with moisture (codes "2", "3", or "4"), code the moisture condition. Code "5" only if the road was otherwise dry.

Asphalt will "bleed". If, in the opinion of the investigator, the bleeding was such as to constitute a road surface detriment, then code "8" (Other). On the other hand, bleeding which is intermittent and insignificant, in terms of area, should be coded as "1" (Dry). If moisture occurs with the bleeding, code "2" (Wet) should be used.

Variable Name: Speed Limit

Format: 2 columns - numeric

Beginning
Column 86

Element Values:

Level 2 Range: 15 through 55
Code actual posted or statutory speed limit in m.p.h.
00 No statutory limit
99 Unknown

Source: Primary sources are scene inspection or statutory law. Do not use the police report for selecting this variable's value.

Remarks:

The attribute is determined from the same roadway which was used to determine the Number of Travel Lanes (D45). It is associated with the location of this vehicle's first harmful event.

The investigator selects the descriptor that best represents the vehicle's environment just prior to the impact. (NOTE: If uncertainty exists concerning the location of the first harmful event, refer to point "1" in the accident level versus traffic unit level environmental data discussion, following D44, Previous Recorded Accidents.)

Disregard advisory or other speed signs which do not indicate the legal speed limit. Furthermore, do not confuse advisory signs on entrance/exit ramps or near intersections with the actual legal maximum speed limit.

If no speed limit sign is posted within a "reasonable" distance from the location of the first harmful event along the approach leg of the vehicle for which D45 (Number of Travel Lanes) was selected, the investigator should reference state statutes to obtain the applicable statutory maximum for the scene (local or state).

If a state has a statute that uniformly reduces the maximum allowable speed within or near a construction zone, then code the indicated reduced limit.

Code "00" (No statutory limit) should be used on roadways which are neither posted nor which have a statutory limit (e.g., parking lot roadways or entrance/exits, service station entrance/exits, or driveways, etc.).

Variable Name: Traffic Control Device Functioning

Format: 1 column - numeric

Beginning
Column 88

Element Values:

- 0 No traffic control
- 1 Traffic control not functioning
- 2 Traffic control functioning - functioning improperly
- 3 Traffic control functioning properly
- 9 Unknown

Source: Sources are scene inspection, police report, and the driver interview.

Remarks:

Code "0" (No traffic control) must only be used when D59, Traffic Control Device, is coded "00" (No controls).

Codes "1" (Traffic control not functioning), "2" (Traffic control functioning - functioning improperly), and "3" (Traffic control functioning properly) are used with respect to the traffic control device cited in D59, Traffic Control Device. Code "3" if the device reported was okay; code "" if the device did not function at all (e.g., signal out). Code "2" is used when the device had some function but the function was improper or inadequate (e.g., signal works but cycles are short, long, or irregular; sign is covered by vegetation reducing line-of-sight). When this code ("2") is used PHOTOGRAPHS are to be taken of the traffic control device. It is a judgment as to whether function was merely improper versus nonexistent. Your decision will be judged on its reasonableness; annotate where necessary.

Code "9" (Unknown) is only used when D59, Traffic Control Device, is coded "99" (Unknown).

Variable Name: Traffic Control Device

Format: 2 columns - numeric

Beginning
Column 89

Element Values:

00 No controls

Not at railroad grade crossing

Highway traffic signals

- 01 Traffic control signal (on colors) without pedestrian signal
- 02 Traffic control signal (on colors) with pedestrian signal
- 03 Traffic control signal (on colors) not known whether or not pedestrian signal
- 04 Flashing traffic control signal
- 05 Flashing beacon
- 06 Flashing highway traffic signal, type unknown or other than traffic control or beacon
- 07 Lane use control signal
- 08 Other highway traffic signal
- 09 Unknown highway traffic signal

Regulatory signs

- 20 Stop sign
- 21 Yield sign
- 28 Other regulatory sign
- 29 Unknown type regulatory sign

School zone signs

- 30 School speed limit sign
- 31 School advance or crossing sign
- 38 Other school related sign
- 39 Unknown type school zone sign

Warning signs

- 40 Warning sign

Miscellaneous controls

- 50 Officer, crossing guard, flagman, etc.

At railroad grade crossing

Active devices

- 60 Gates
- 61 Flashing lights
- 62 Traffic control sign
- 63 Wigwags
- 64 Bells
- 68 Other train activated device
- 69 Active device, type unknown

Passive devices

- 70 Crossbucks
- 71 Stop sign
- 72 Other railroad crossing sign

Variable Name: Traffic Control Device (cont'd.)

73 Special warning device - watchman, flagged by crew

78 Other passive device

79 Passive device, type unknown

Miscellaneous controls

80 Grade crossing controlled, type unknown

Whether or not at railroad grade crossing

98 Other

99 Unknown

Source: Primary source is scene inspection; secondary sources include the police report and driver interviews.

Remarks:

The attribute is determined from the same roadway which was used to determine the Number of Travel Lanes (D45). It is associated with the location of the first harmful event.

The investigator selects the descriptor which identifies the environment at the crash site. (NOTE: If uncertainty exists concerning the location of the first harmful event, refer to point "1" in the accident level versus traffic unit level environmental data discussion, following D44, Lane Use.)

This variable measures controls which regulate vehicular traffic. Excluded are any controls which solely regulate pedestrians (e.g., Walk/Wait signals).

According to ANSI D6.1-1978, section 2A-7, pages 2A-3,4 (Manual on Uniform Traffic Control Devices), signs are classified functionally as follows: Regulator signs give notice of traffic laws or regulations; Warning signs call attention to conditions on, or adjacent to, a highway or street that are potentially hazardous to traffic operations; and Guide signs show route designations, destinations, directions, distances, services, points of interest, and other geographical, recreational, or cultural information.

According to ANSI D6.1-1978, section 2A-10, pages 2A-4,5 signs come in standard shapes. The octagon shall be reserved exclusively for the STOP sign. The equilateral triangle, with one point downward, shall be reserved exclusively for the YIELD sign. The round shape shall be used for the advance warning of a railroad crossing and for the civil defense evacuation route marker. The pennant shape, an isosceles triangle, with its longest axis horizontal, shall be used to warn of no passing zones. The diamond shape shall be used only to warn of existing or possible hazards either on the roadway or adjacent thereto. The [vertical] rectangle, ordinarily with

Variable Name: Traffic Control Device (cont'd.)

the longer dimension vertical, shall be used for regulatory signs, with the exception of STOP signs and YIELD signs. The [horizontal] rectangle, ordinarily with the longer dimension horizontal, shall be used for guide signs, with the exception of certain route markers and recreational area guide signs. The pentagon, point up, shall be used for School Advance and School Crossing signs. Other shapes are reserved for special purposes; for example, the shield or other characteristic design for route markers and crossbuck for railroad crossings.

According to ANSI D6.1-1978, section 2A-11, page 2A-5, signs can be distinguished by their color. The following general rules apply. Red is used as a background color on prohibitory type regulatory signs (e.g., STOP, DO NOT ENTER, WRONG WAY). It is also used as the circular outline and diagonal bar prohibitory symbol. Black may be used as a background (e.g., ONE WAY); it is used as a message on white, yellow and orange signs. White is used as the background for route markers, guide signs, and regulatory signs (except STOP). It is used as the legend on brown, green, blue, black, and red signs. Orange is used only as a background color for construction and maintenance signs. Yellow is used as a background color for warning signs and for school signs. Brown, green, and blue are used as a background color for guide signs.

Pavement markings do not constitute traffic control devices under the present definition.

Guide signs do not constitute traffic controls.

The investigator should consider the intent of this question. If at the time of the accident there was no intent to control (regulate or warn) vehicle traffic, then code "00" (No controls); otherwise, code the appropriate value. Statutory controls (e.g., state law requires that when two drivers met at an uncontrolled intersection, the one on the right has the right-of-way) should be coded as "00" (No controls).

Focus on the road segment just prior to the location of the first harmful event and select the traffic control device(s) which is (are) most related to the accident. If multiple devices are related, select the device of highest (lowest numerically) priority.

For example, if the intersection is channelized and controlled differently on the channel than on the through lanes (e.g., signal and yield sign), report the traffic controls depending on whether the roadway (D45, Number of Travel Lanes) was chosen based on its through lanes or its channelized lanes.

The codes are prioritized in decreasing numerical value (i.e., "01" takes precedence over "02", "02" over "03", etc.--see exception associated with code

Variable Name: Traffic Control Device (cont'd.)

"50"). Codes are grouped generally into those not at a railroad crossing ("01" through "50") and those at a railroad grade crossing ("60" through "80"). This means that highway traffic signals take precedence over regulatory signs, school zone signs, and warning signs. Regulatory signs take precedence over school and warning signs. School signs take precedence over warning signs. Likewise, active (railroad crossing) devices take precedence over passive devices. If a school guard, police officer, or other officially-designated person controls both pedestrian and vehicular traffic, code "50" (Officer, crossing guard, flagman, etc.) should be used. Any officially-designated person (code "50") takes precedence over values "00" through "40".

Codes "60" through "80" should only be used when the first harmful event occurs in the junction of a roadway and a railroad bed [i.e., A24, Relation to Junction, equals "12" (Railroad grade crossing)]. If A24 equals "12", then codes "00" or "60" through "80" should be used. Codes "01" through "50" should be used when the location of the first harmful event occurs anywhere else (i.e., A24 equals "01" through "11" or "13").

Codes "01", "02", or "03" [Traffic control signal (on colors)] is used for any signal which processes through the green, amber, and red cycles. The source of actuation is of no concern. If the amber phase is missing, an on-colors control device should still be coded.

If the signal has green, amber, and red cycle capability but is being used to flash amber/red only, then code "04" (Flashing traffic control signal) is used.

Code "05" (Flashing beacon) is used for any device capable of only flashing amber/red signals.

Code "07" (Lane use control signal) includes turn arrows and controls which govern the direction of traffic flow in the lane (i.e., traffic flows differently depending on time of day).

Code "28" (Other regulatory sign) includes speeds limit signs, movement signs (e.g., NO TURN, LEFT TURN ONLY, DO NOT PASS, PASS WITH CARE, KEEP RIGHT, DO NOT ENTER, WRONG WAY, ONE WAY), parking signs (e.g., NO PARKING, EMERGENCY PARKING ONLY), pedestrian signs (e.g., NO HITCH HIKING, NO PEDESTRIANS), and other miscellaneous signs (e.g., STOP HERE ON RED, NO TURN ON RED, ROAD CLOSED TO THRU TRAFFIC, WEIGHT LIMIT, TRUCK ROUTE)--see ANSI D6.1-1978, sections 2B-10 through 2B-44, pages 2B-6 through 2B-36.

Codes "30" through "39" (School zone signs) should only be used if the first harmful event occurred during the time the sign was in effect. If the sign was in effect, it does not matter whether or not children were present. (NOTE: Time should be ascertained not only with respect to hour of day, but

Variable Name: Traffic Control Device (cont'd.)

day of week and the effect of holidays, vacations, etc., as well. Each team should report the particulars regarding their state or local ordinances to their Zone Center.) See ANSI D6.1-1978, sections 7B-9 through 7B-13, pages 7B-2 through 7B-6, for examples of school zone signs.

Code "40" (Warning signs) is used for any black on yellow diamond shaped sign. Some black on yellow horizontal rectangular or vertical rectangular (speed advisory) signs are also included. See ANSI D6.1-1978, section 2C-1 through 2C-41, pages 2C-1 through 2C-22 for examples of signs.

Code "60" (Gates) is used if the railroad crossing is guarded by a combination of gates, flashing lights, and bells. See ANSI D6.1-1978, section 8C-2 through 8C-4, pages 8C-1 through 8C-5, for examples of flashing lights with and without gates.

Code "70" (Crossbucks) is coded if no train activated devices are present and a large "X", with the words RAILROAD CROSSING spelled out on the "X", is present--see ANSI D6.1-1978, section 8B-2, pages 8B-1 and 8B-2.

Code "72" (Other railroad crossing sign) includes the railroad advance warning sign (circle with black "X" on yellow background)--see ANSI D6.1-1978, section 8B-3, page 8B-3.

Code "98" (Other) includes a school bus with flashers activated where vehicles are required to stop.

A traffic control that has been deactivated (e.g., traffic signal that emits no signals) during certain times of the day and was deactivated at the time of the accident should be coded "00" (No controls). A traffic control that has just been installed and not yet activated should also be coded "00". However, a traffic control that is out (e.g., due to a power failure) and was related should be coded, unless a temporary control [e.g., stop sign ("20"), police officer ("50"), etc.] has been inserted, in which case the temporary control should be coded.

DRIVEFORM

D60
D61
D62

Variable Name: 1st - Other Driver Related Factors
2nd - Other Driver Related Factors
3rd - Other Driver Related Factors

Format: 2 columns - numeric

Beginning
Column 91
93
95

Element Values:

00 No other driver related factors

Physical/Mental Condition

- 01 Non-physical (i.e., mental or emotional factor)
- 02 Drowsy, sleepy, asleep, fatigued
- 03 Depression
- 04 Illness, disease, blackout

Physical Impairments

- 05 Deaf
- 06 Restricted to wheelchair
- 07 Paraplegic
- 08 Previous injury
- 09 Other physical impairments (specify)

Drug Impairments

- 10 Drugs-medication (prescription, over-the-counter)
- 11 Other drugs (excludes alcohol, includes illegal substances)(specify)

Operator Related Factors

- 20 Inattention
- 21 Interference with driver by other passenger
- 22 Operator inexperience
- 23 Unfamiliar with roadway
- 24 Overloading or improper loading of vehicles with passengers or cargo
- 25 Operating vehicle in erratic, reckless, careless or negligent manner
- 26 Improper or erratic lane changing
- 27 Failure to keep in proper lane or running off roadway
- 28 Making improper entry to or exit from trafficway
- 29 Failure to obey traffic signs, traffic control devices or traffic officer, failure to observe Safety Zones
- 30 Failure to signal intentions
- 31 Giving wrong signal
- 32 Making right turn from left lane, making left turn from right lane

DRIVER FORM

D60
D61
D62
(2)

Variable Name: 1st - Other Driver Related Factors (cont'd.)
2nd - Other Driver Related Factors (cont'd.)
3rd - Other Driver Related Factors (cont'd.)

- 33 Making other improper turn
- 34 Driving wrong way on one-way roadway
- 35 Driving on wrong side of roadway
- 36 Failure to dim lights or to have lights on when required
- 37 Operating without required equipment
- 38 Creating unlawful noise or using equipment prohibited by law
- 39 Passing where prohibited by posted signs, pavement markings, hill, curve or school bus displaying warning not to pass
- 40 Passing on wrong side
- 41 Passing with insufficient distance or inadequate visibility or failing to yield to overtaking vehicle
- 42 Passing through or around barrier positioned to prohibit or channel traffic
- 43 Failure to observe warnings or instructions on vehicles displaying them
- 44 Driving less than posted minimum
- 45 Operating at erratic or suddenly changing speeds
- 46 High speed chase with police in pursuit
- 47 Illegal driving on road shoulder, in ditch, on roadside, or on sidewalk or path
- 48 Starting or backing improperly
- 49 Stopping in roadway (vehicle not abandoned)
- 50 Opening vehicle door into moving traffic or while vehicle is in motion
- 51 Towing or pushing vehicle properly

- 98 Other (specify)
- 99 Unknown

Source: Police report, hospital/medical report, or other official records.

Remarks:

The purpose of these variables is to provide guidance to safety research on the involvement of these factors in accidents. Causal determinations must necessarily be based on more detailed investigations and other data, such as exposure data.

Related Factors are circumstances that may have contributed to the cause of an accident. For our purposes, regarding driver related factors, only those circumstances indicated by the investigating police officer on the PAR or identified in other official reports are to be considered for coding. These factors can appear anywhere on the report--in the narrative section, in the

DRIVER FORM

D60
D61
D62
(3)

Variable Name: 1st - Other Driver Related Factors (cont'd.)
2nd - Other Driver Related Factors (cont'd.)
3rd - Other Driver Related Factors (cont'd.)

space for violations, in the column titled "Contributing Factors" or "Driver Action", etc. Do not include driver statements unless verified by the investigating police officer.

As described in the coding attributes, driver related factors are divided into two groups: (1) Physical/Mental Conditions (codes "01"- "11"), and (2) Operator Related Factors (codes "20"- "51"). Physical/Mental Conditions can be police report indications and/or information taken from other official records (e.g., hospital/medical, autopsy reports, driver records, etc.). Operator Related Factors are restricted to police report indications only. Indications taken from the PAR are coded whether or not the PAR's contributing factor is accurate.

Only the driver related factors that apply to that particular driver should be coded. If only one factor applies, the code for it should be entered in the slots for the first variable. The following variables should be coded "00" (No other related factors), signifying no subsequent related factors. If two or three factors apply, code accordingly in ascending numerical order. If more than three codes apply, choose the three that seem the most significant. If no other driver related factors apply, code "00" for all three variables. Do not include any factors already coded as a violation in D23 through D30.

Code "00" (No other driver related factors) is used if the investigating officer did not indicate any related factors for the driver in the accident and if related factors are not identified from other official sources.

Code "01" [Non-physical (i.e., mental or emotional factor)] includes anger, excitement, etc.

Code "04" (Illness, disease, blackout) includes nausea.

Codes "05" through "11" (Physical and Drug Impairments) apply to impairments that are indicated on the PAR or specified in other official records.

If both "06" (Restricted to wheelchair) and "07" (Paraplegic) apply, code "07". Reserve "06" for those persons who are restricted to a wheelchair, but are not paraplegic.

Code "11" (Other drugs) is used for illegal substances (e.g., heroin/morphine, marijuana which are not obtained as a result of a prescription, etc.).

DRIVER FORM

D60

D61

D62

(4)

Variable Name: 1st - Other Driver Related Factors (cont'd.)
2nd - Other Driver Related Factors (cont'd.)
3rd - Other Driver Related Factors (cont'd.)

Codes "20" through "51" are Operator Related Factors and generally refer to specific actions performed by the driver.

Code "21" (Interference with driver by other passenger) refers to situations where the driver is distracted or physically restricted by the passenger. If the driver is simply conversing with the passenger, code "20" (Inattention).

Code "25" (Operating vehicle in erratic, reckless, careless, or negligent manner) does not include erratic lane changing (code "26") or erratic speed changing (code "45").

Codes "26" (Improper or erratic lane changing) and "27" (Failure to keep in proper lane or running off roadway) differ in that the former involves intentionally changing lanes and the latter does not. Code "27" refers to a driver who fails to keep his vehicle in its lane, or unintentionally leaves it (e.g., a drunk who weaves, all or part of the vehicle repeatedly crossing an edge line or a lane marker).

Code "28" (Making improper entry or exit from trafficway) does not include an uncontrolled departure of the roadway. It should also be distinguished from starting or backing improperly (see code "48").

Code "32" (Making right turn from left lane, making left turn from right lane) refers to any turn made from the wrong lane. It includes turning into a driveway, turning at an intersection, etc. Code "33" (Making other improper turn) includes all of the turns that do not apply above, e.g., U-turns, turning at an intersection when it is not allowed, turning into the wrong lane, etc.

Code "37" (Operating without required equipment) can refer to an improper trailer hitch, no snow tires in the winter months of some states, no chains on tires for use on mountain roads, no outside mirror when the driver's license requires one, etc.

Code "38" (Creating unlawful noise or using equipment prohibited by law) includes using legal equipment illegally, e.g., vehicles with low hydraulic or air shock absorbers, etc.

Code "43" (Failure to observe warnings or instructions on vehicles displaying them) includes failure to observe warnings or instructions on snow plows, construction equipment, etc.

DRIVER FORM

D60

D61

D62

(5)

Variable Name: 1st - Other Driver Related Factors (cont'd.)
2nd - Other Driver Related Factors (cont'd.)
3rd - Other Driver Related Factors (cont'd.)

Code "47" (Illegal driving on road shoulder, in ditch, on roadside, or on sidewalk or path) presumes that the driver was in control of his vehicle on the road shoulder, sidewalk, etc., prior to the first harmful event.

Code "48" (Starting or backing improperly) only applies when the driver is parking, leaving a parked position, or other maneuvers that are not traffic control related.

Code "49" [Stopping in roadway (vehicle not abandoned)] does not include stopping for a traffic signal, sign, traffic officer, legal turn, etc.

Code "98" [Other (specify)] does not include alcohol involvement, speeding (in any form), driving while intoxicated (or DUIL), reckless driving with a suspended or revoked license, failure to yield right-of-way, following too closely, running a traffic signal or stop sign, or any other factor for which a citation was issued listed in D30, Other Violation Charged.

Code "99" (Unknown) in all three spaces only when the PAR specifically states "unknown contributing factors".

For hit and run vehicles, code "00" (No other driver related factors) for all three variables unless the PAR indicates the presence of a factor.

DRIVER FORM

D63
D64
D65

Variable Name: 1st - Other Environmental Related Factors
2nd - Other Environmental Related Factors
3rd - Other Environmental Related Factors

Format: 2 columns - numeric

Beginning
Column 97
99
101

Element Values:

00 No other environmental related factors

Vision Obscured By

- 01 Rain, snow, fog, smoke, sand, dust
- 02 Reflected glare, bright sunlight, headlights
- 03 Curve, hill or other design features (including traffic signs, embankment)
- 04 Building, billboard, etc.
- 05 Trees, crops, vegetation
- 06 Moving vehicle (including load)
- 07 Splash or spray of passing vehicle
- 08 Parked vehicle
- 09 Other object not classifiable above

Swerving or Loss of Control Due to

- 20 Severe crosswind
- 21 Wind from passing truck
- 22 Slippery surface
- 23 Avoiding debris or objects in roadway
- 24 Ruts, holes, bumps in roadway
- 25 Avoiding animals in roadway
- 26 Avoiding vehicle in roadway
- 27 Avoiding pedestrian, pedalcyclist, other nonmotorist in roadway
- 28 Avoiding standing water, snow, oilslick or ice patch on roadway

Roadway Features

- 30 Inadequate warning of exits, lanes narrowing, traffic controls, etc.
- 31 Pavement marking obscured or absent
- 32 Surface washed out (caved in, road slippage)
- 33 Shoulder to low or high
- 34 Inadequate construction or poor design of roadway, bridge, etc.
- 35 Vehicle unattended in roadway

- 98 Other (specify)
- 99 Unknown

Source: Police report.

DRIVER FORM

D63
D64
D65
2)

Variable Name: 1st - Other Environmental Related Factors (cont'd.)
2nd - Other Environmental Related Factors (cont'd.)
3rd - Other Environmental Related Factors (cont'd.)

Remarks:

The purpose of these variables is to provide guidance to safety research on the involvement of these factors in accidents. Causal determinations must necessarily be based on more detailed investigations and other data, such as exposure data.

Related Factors are circumstances that may have contributed to the cause of an accident. For our purposes, regarding environmental related factors, only those circumstances indicated by the investigating police officer on the PAR are to be considered for coding. These factors can appear anywhere on the report--in the narrative section, in the space for violations, in the column titled "Contributing Factors" or "Driver Action", etc.

As described in the coding attributes, environmental related factors are police accident report (PAR) indications of factors. The environmental related factors are taken directly from the PAR whether or not the PAR's contributing factor is accurate.

Only the environmental related factors that apply to that particular driver should be coded. If only one factor applies, the code for it should be entered in the slots for the first variable. The following variables should be coded "00" (No other environmental related factors), signifying no subsequent related factors. If two or three factors apply, code accordingly in ascending numerical order. If more than three codes apply, choose the three that seem the most significant. If no other environmental related factors apply, code "00" for all three variables.

Codes "01" through "09" are to be used when the driver's vision is obscured by an element of the environment.

Codes "20" through "28" should be used if the driver swerves or loses control of his vehicle as a result of these environmental factors.

Code "22" (Slippery surface) includes snow, ice, oil, etc.

Code "26" (Avoiding Vehicle in Roadway) includes both attended and unattended vehicles. Only code this for "phantom" vehicles if the investigating police officer specifically indicates it.

Codes "30" through "35" are to be used whenever roadway features are indicated by the investigating officer as related factors in the accident.

DRIVER FORM

D63
D64
D65
(3)

Variable Name: 1st - Other Environmental Related Factors (cont'd.)
2nd - Other Environmental Related Factors (cont'd.)
3rd - Other Environmental Related Factors (cont'd.)

Remarks:

Code "35" (Vehicle unattended in roadway) should be used only when an unattended vehicle in the roadway is struck (as the first harmful event).

Code "99" (Unknown) in all three spaces only when the PAR specifically states "unknown contributing factors."

For hit and run vehicles, code "00" (No other environmental related factors) for all three variables unless the PAR indicates the presence of a factor.



Occupant Data

1. Primary Sampling Unit Number	<u> </u> <u> </u>
2. Case Number-Stratification	<u> </u> <u> </u> <u> </u> <u> </u>
3. Record Number	<u> </u> <u> </u>
4. Transaction Code	<u> </u>
5. Version Number	<u> </u>
6. Investigator I.D. Number	<u> </u>

IDENTIFICATION	
7. Vehicle Number	<u> </u> <u> </u>
8. Occupant Number	<u> </u> <u> </u>

OCCUPANT INTERVIEW	
9. Occupant's Age	<u> </u> <u> </u>
_____ year(s) - Code actual age at time of accident.	
___ (00) Less than one year old	
___ (97) 97 years and older	
___ (99) Unknown	
10. Occupant's Sex	<u> </u>
___ (1) Male	
___ (2) Female	
___ (9) Unknown	
11. Occupant's Height	<u> </u> <u> </u>
_____ inches - Code actual height to the nearest inch.	
___ (99) Unknown	
12. Occupant's Weight	<u> </u> <u> </u> <u> </u>
_____ pounds - Code actual weight to the nearest pound.	
___ (999) Unknown	
13. Occupant's Role	<u> </u> <u> </u> <u> </u>
___ (1) Driver	
___ (2) Passenger	
___ (9) Unknown	

14. Occupant's Seat Position	<u> </u> <u> </u>
___ (01) Front seat-left side	
___ (02) Front seat-middle	
___ (03) Front seat-right side	
___ (04) Second seat-left side	
___ (05) Second seat-middle	
___ (06) Second seat-right side	
___ (07) Third seat-left side	
___ (08) Third seat-middle	
___ (09) Third seat-right side	
___ (10) Front seat-additional passenger	
___ (11) Second seat or beyond-additional passenger	
___ (12) Truck-tractor sleeping section	
___ (13) Other enclosed area:	
___ (14) In or on unenclosed area	
area	
type: _____	
___ (15) In or on trailing unit	
unit	
type: _____	
___ (99) Unknown	<u> </u> <u> </u>

(NOTE: INVESTIGATOR as used below refers to the product of individual observation, police reports, and any other sources used that culminated in the assessment which represents the final opinion of the investigator.)

15. Entrapment	<u> </u> <u> </u>
(NOTE: Entrapped means that part of the occupant was in the vehicle and mechanically restrained; jammed doors and immobilizing injuries by themselves are not sufficient to constitute entrapment.)	

Inter- viewee	Inves- tigator	<u> </u> <u> </u>
___ (0) Not entrapped	___	
___ (1) Entrapped	___	
___ (9) Unknown	___	<u> </u>

16. Ejection	<u> </u> <u> </u>
___ (0) None	
___ (1) Complete ejection	
___ (2) Partial ejection	
___ (3) Ejection, unknown degree	
___ (9) Unknown	<u> </u>

V5
(66
67)

V5
(66
67)

<u>Inter-viewee</u>	<u>Inves-tigator</u>
17. Ejection Area	
___ (0) No ejection	___
___ (1) Windshield	___
___ (2) Left front	___
___ (3) Right front	___
___ (4) Left rear	___
___ (5) Right rear	___
___ (6) Rear	___
___ (7) Roof	___
___ (8) Other area (e.g., sidecar, back of pick-up, etc.) _____	___
___ (9) Unknown	___
	28
18. Ejection Medium	
___ (0) No ejection	___
___ (1) Door	___
___ (2) Open roof structure	___
___ (3) Fixed windows	___
Operable windows	
___ (4) Roll down type	___
___ (5) Hinged type	___
___ (6) Sliding type	___
___ (7) Other type _____	___
___ (8) Other medium: _____	___
___ (9) Unknown	___
	29

<u>Inter-viewee</u>	<u>Inves-tigator</u>
19. Medium Status	
___ (0) No ejection	___
___ (1) Open	___
___ (2) Separation	___
___ (3) Closed, closed when damaged	___
___ (4) Integral structure ripped open	___
___ (9) Unknown	___
	30
20. Treatment – Mortality	
<u>Inter-viewee</u>	<u>Official Sources</u>
___ (1) Fatal	___
___ (2) Fatal – ruled disease	___
Nonfatal	
___ (3) Hospitalization	___
___ (4) Transported and released	___
___ (5) Treatment-other: _____	___
___ (6) No treatment	___
___ (9) Unknown	___
	31

COMMENTS:

v6

v6

v6

Delete Comments After Case Review

INJURY DATA FROM INTERVIEWEE

Indicate the *Nature, Location, and injury Source* of all injuries

Soft Tissue Injuries

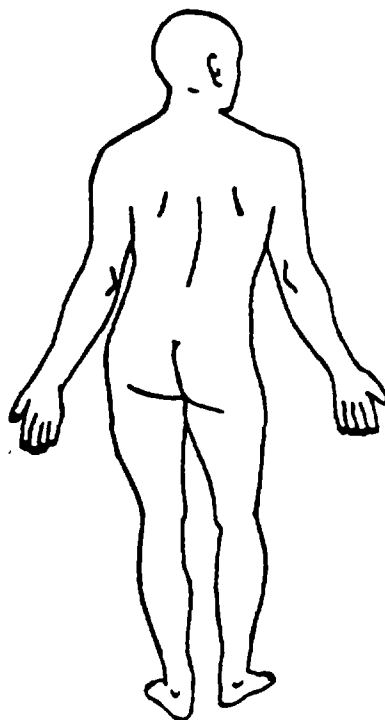
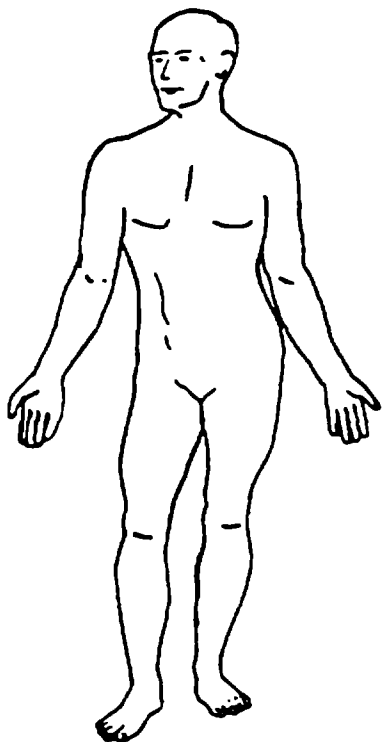

Skeletal Injuries

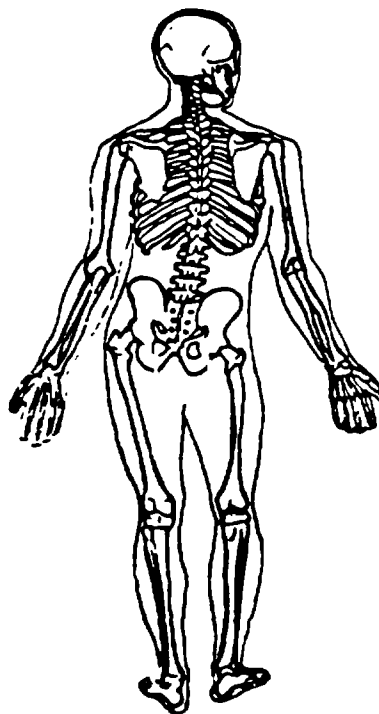
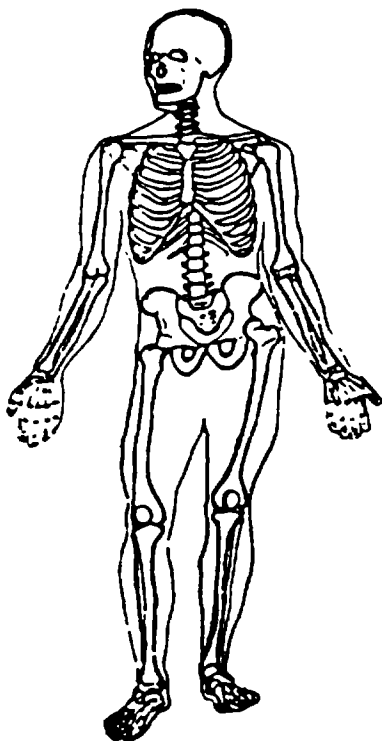

National Accident Sampling System – Continuous Sampling Subsystem: Occupant Data

<u>Inter-viewee</u>	<u>Official Sources</u>
21. Hospital Stay	
___ (00) Not Hospitalized	___
___ day(s) – Code the number of days (up through 60) that the occupant stayed in hospital.	___
___ (61) 61 days or more	___
___ (99) Unknown	___
	32 33
22. Working Days Lost	
___ (00) No working days lost	
___ day(s) – Code the number of days (up through 60) that the occupant lost from work due to the accident	
___ (61) 61 days or more	
___ (62) Fatally Injured	
___ (99) Unknown	
	34 35

<u>Inter-viewee</u>	<u>Investigator</u>
23 Manual (Active) Restraint System Availability	
___ (0) None available	___
___ (1) Shoulder belt	___
___ (2) Lap belt	___
___ (3) Lap and shoulder belt	___
___ (4) Motorcycle helmet	___
___ (5) Child safety seat (designed without tether or unknown design)	___
___ (6) Child safety seat (designed with tether – properly installed)	___
___ (7) Child safety seat (designed with tether – improperly installed)	___
___ (8) Restraint available – type unknown or other: _____	___
___ (9) Unknown	___
	36

<u>Inter-viewee</u>	<u>Police</u>	<u>Investigator</u>
24. Manual (Active) Restraint System Use		
___ (0) None used	___	___
___ (1) Shoulder belt	___	___
___ (2) Lap belt	___	___
___ (3) Lap and shoulder belt	___	___
___ (4) Motorcycle helmet	___	___
___ (5) Child safety seat – used properly	___	___
___ (6) Child safety seat – used improperly	___	___
___ (7) Child safety seat – unknown if used properly	___	___
___ (8) Restraint used – type unknown or other: _____	___	___
___ (9) Unknown	___	___
		37
25. Automatic (Passive) Restraint System Availability		
___ (0) Not equipped		___
___ (1) Airbag		___
___ (2) Airbag disconnected		___
___ (3) Airbag not reinstalled		___
___ (4) 2 point automatic belts		___
___ (5) 3 point automatic belts		___
___ (6) Automatic belts destroyed		___
___ (9) Unknown		___
		38
26. Automatic (Passive) Restraint Function		
___ (0) Not equipped		___
___ (1) Automatic belt in use		___
___ (2) Automatic belt not in use		___
___ (3) Deployed airbag		___
___ (4) Nondeployed airbag		___
___ (9) Unknown		___
		39
27. Relation of Interviewee to Occupant		
___ (0) No interview		
___ (1) Same person		
___ (2) Other accident involved person: _____		
Uninvolved Person		
___ (3) Relative or friend		
___ (4) Other uninvolved person: _____		
Combination of Persons:		
___ (5) One of which was accident involved		
___ (6) None of which were accident involved		
___ (9) Unknown		
		40

THIS COMPLETES THE INTERVIEW

OFFICIAL INJURY DATA

Indicate the *Nature* and *Location* of All injuries

Soft Tissue Injuries

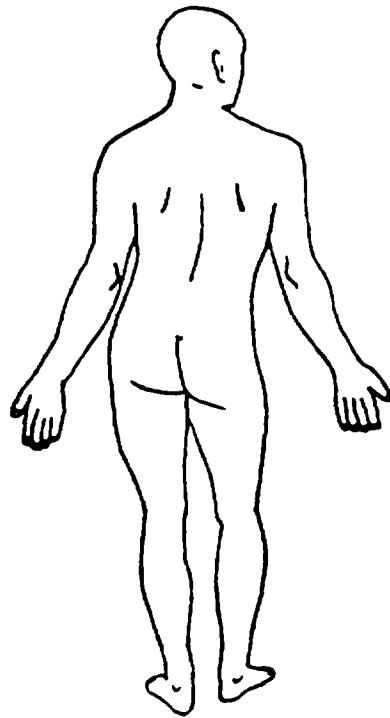
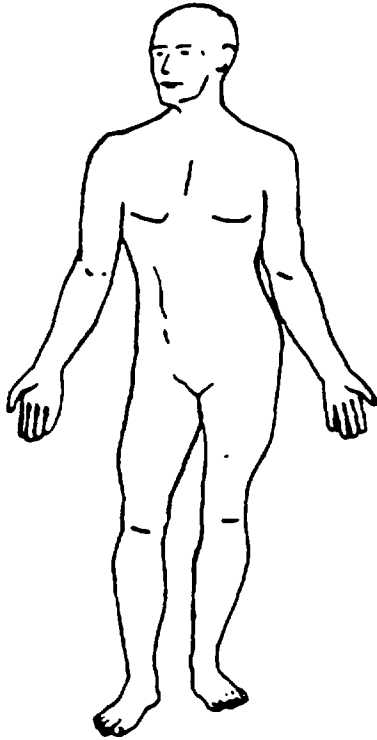

Skeletal Injuries

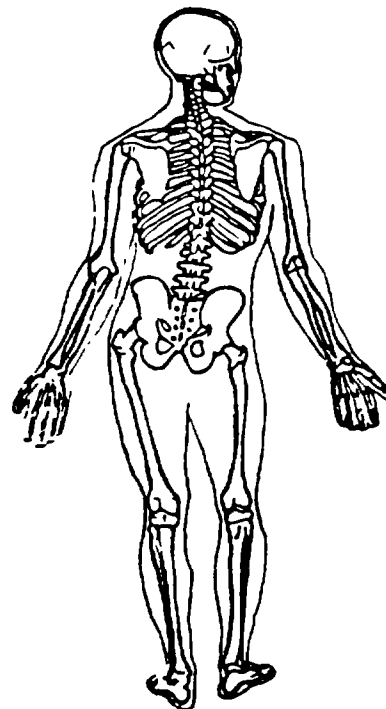
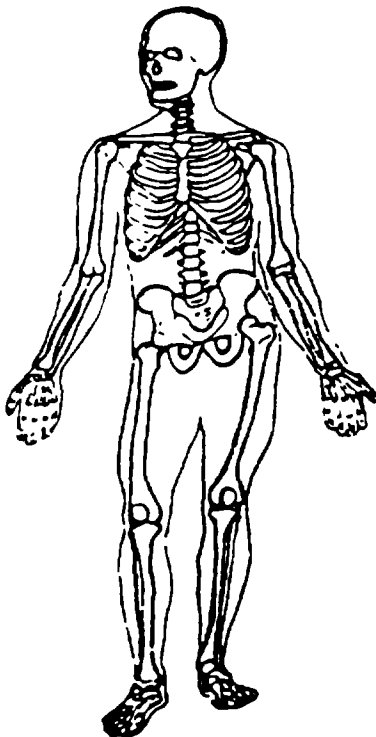

Write additional medical record injury information on reverse of this page.

National Accident Sampling System – Continuous Sampling Subsystem: Occupant Data

OCCUPANT INJURY CLASSIFICATION

Consider all injuries which are reported from both unofficial and official sources. The information from official sources takes precedence over similar injuries reported by any other source. In other words, do not list the same injury twice; supercede the interview data with official data in the case of similar injuries. List all injuries by official medical sources first. Police reported injuries may be used, but only when no other source of injury information is available.

Were more than ten (10) injuries sustained? Unknown, No, Yes – If more than ten dissimilar injuries were identified during the interview, from collection of official data, and from other unofficial sources (excluding police), list those from the official records first, exhausting that level of data before listing those from the interviewee or other sources.

	<u>I.S.S. Body Region</u>	<u>O.I.C. Body Region</u>	<u>Aspect</u>	<u>Lesion</u>	<u>System/ Organ</u>	<u>A.I.S. Severity</u>	<u>Injury Source</u>	<u>Source of Data</u>
1	—	—	—	—	—	—	—	—
2	—	—	—	—	—	—	—	—
3	—	—	—	—	—	—	—	—
4	—	—	—	—	—	—	—	—
5	—	—	—	—	—	—	—	—
6	—	—	—	—	—	—	—	—
7	—	—	—	—	—	—	—	—
8	—	—	—	—	—	—	—	—
9	—	—	—	—	—	—	—	—
10	—	—	—	—	—	—	—	—

Source of Data

Official

(01) Autopsy records with or without hospital/medical records

(02) Hospital medical records other than emergency room (e.g., discharge summary)

(03) Emergency room records only (including associated x-rays or other lab reports)

(04) Private physician, walk-in or emergency clinic

Unofficial

(05) Lay coroner report

(06) E.M.S. personnel

(07) Interviewee

(08) Other source:

(09) Police

(99) Unknown if injured

(00) Not injured

REDUCTION SECTION

I.S.S. Body Region

- (1) Head or neck
- (2) Face
- (3) Chest
- (4) Abdominal or pelvic contents
- (5) Extremities or pelvic girdle
- (6) General (external)
- (0) Not injured
- (9) Unknown

O.I.C. Body Region

- (M) Abdomen
- (Q) Ankle-foot
- (A) Arm (upper)
- (B) Back-thoracolumbar spine
- (C) Chest
- (E) Elbow
- (f) Face
- (R) Forearm
- (H) Head - skull
- (U) Injured, unknown region
- (K) Knee
- (L) Leg (lower)
- (Y) Lower limb(s) (whole or unknown part)
- (N) Neck - cervical spine
- (P) Pelvic - hip
- (S) Shoulder
- (T) Thigh
- (X) Upper limb(s) (whole or unknown part)
- (O) Whole body
- (W) Wrist - hand
- (0) Not injured
- (9) Unknown if injured

Aspect of Injury

- (A) Anterior - front
- (C) Central
- (I) Inferior - lower
- (U) Injured, unknown aspect
- (L) Left
- (P) Posterior - back
- (R) Right
- (S) Superior - upper
- (W) Whole region
- (0) Not injured
- (9) Unknown if injured

Lesion

- (A) Abrasion
- (M) Amputation
- (V) Avulsion
- (B) Burn
- (K) Concussion
- (C) Contusion
- (N) Crush
- (G) Detachment, separation
- (D) Dislocation
- (I) Fracture
- (Z) Fracture and dislocation
- (U) Injured unknown lesion
- (L) Laceration
- (O) Other
- (P) Perforation, puncture
- (K) Rupture
- (S) Sprain
- (T) Strain
- (I) Total severance, transection
- (0) Not injured
- (9) Unknown if injured

System/Organ

- (W) All systems in region
- (A) Arteries - veins
- (B) Brain
- (D) Digestive
- (E) Ears
- (O) Eye
- (H) Heart
- (U) Injured, unknown system
- (I) Integumentary
- (J) Joints
- (K) Kidneys
- (L) Liver
- (M) Muscles
- (N) Nervous system
- (P) Pulmonary - lungs
- (R) Respiratory
- (S) Skeletal
- (C) Spinal cord
- (Q) Spleen
- (T) Thyroid, other endocrine gland
- (G) Urogenital
- (V) Vertebrae
- (0) Not injured
- (9) Unknown if injured

Abbreviated Injury Scale

- (1) Minor injury
- (2) Moderate injury
- (3) Severe injury
- (4) Serious injury
- (5) Critical injury
- (6) Maximum (untreatable)
- (7) Injured, unknown severity
- (0) Not injured
- (9) Unknown if injured

National Accident Sampling System – Continuous Sampling Subsystem: Occupant Data

Injury Source	ROOF	EXTERIOR of STRIKING MOTOR VEHICLE
(00) No injury	(31) Front header	(71) Front Bumper
FRONT	(32) Rear header	(72) Hood edge
(01) Windshield	(33) Roof side rails	(73) Other front of vehicle
(02) Mirror	(34) Roof or convertible top	(74) Hood
(03) Steering assembly, including transmission selector level when column mounted	FLOOR	(75) Hood ornament
(04) Add-on equipment (e.g., CB, tape deck, air conditioner)	(41) Floor	(76) Windshield, roof rail, A-pillar
(05) Instrument panel and below, excluding foot controls and parking brake	(42) Floor or console mounted transmission lever, including console	(77) Side surface
(06) Sunvisor	(43) Parking brake handle	(78) Side mirrors
(09) Other front object	(44) Foot controls including parking brake	(79) Other side protrusions
SIDE	REAR	(80) Rear surface
(11) Side interior surface, excluding hardware or armrests	(45) Backlight (rear window)	(81) Undercarriage
(12) Side hardware or armrests	(46) Backlight storage rack, door, etc	(82) Tires and wheels
(13) A pillar	(49) Other rear objects	(83) Other exterior of striking motor vehicle
(14) B pillar	EXTERIOR of OCCUPANT's VEHICLE	(84) Unknown exterior of striking motor vehicle
(15) Other pillar	(51) Hood	OTHER VEHICLE or OBJECT in the ENVIRONMENT
(16) Window glass or frame	(52) Outside hardware (e.g., outside mirror, antenna)	(86) Ground
(19) Other side object	(53) Other exterior surface or fuses	(87) Other vehicle or object
INTERIOR	(59) Unknown exterior objects	(89) Unknown vehicle or object
(21) Seat, back support	CYCLE	NONCONTACT INJURY
(22) Belt restraint system	(61) Handle bars or attachments	(90) Noncontact injury source (impact force)
(23) Head restraint	(62) Frame or suspension component or fender	(97) Injured, unknown source
(24) Air cushion	(63) Seat	(99) Unknown if injured
(25) Other occupants	(64) Foot pedal, foot rest, foot pegs	
(26) Interior loose objects	(65) Wheel or tire	
(29) Other interior object	(66) Engine or transmission	
	(67) Gas tank, gas tank filling cap or neck	
	(69) Other cycle part	

OCCUPANT INJURY CLASSIFICATION

If there are six or less injuries listed in the O.I.C. reduction section, code all of the injuries ordered by Source of Data (1st-autopsy, 2nd-hospital/medical, 3rd-emergency room, 4th-private physician, or 5th-unofficial sources) and by A.I.S. severity within source.

If there are more than six injuries order the injuries by source and by A.I.S. severity within source. Code this ordering, injury by injury. If a group of ordered injuries has the same source, the same A.I.S., and the group includes at least the sixth and seventh injuries in the ordering, then a choice must be made as to which injury or injuries to code.

Choose the injury or injuries that will enable the maximum number of different I.S.S. body regions to be represented in the coded data. If no new I.S.S. body region can be added, then simply code in accordance with the original ordering.

If the occupant has less than six injuries, then the number of rows required to be completed is equal to the number of injuries plus one (e.g., no injuries requires one row i.e., columns 41 to 49). In the additional row "No injury" will be coded for all variables including A.I.S. severity.

If you cannot increase the number of different ISS body regions or if you can choose between two or more injuries of the same source and AIS severity any of which would constitute an additional ISS region, then choose the injury that has a known injury source

Update Candidate Yes No

	I.S.S. Body Region	O.I.C. Body Region	Aspect	Lesion	System/ Organ	A.I.S. Severity	Injury Source	Source of Data
1st	—	28 41	29 42	30 43	31 44	32 45	33 46 47	34 48 49
2nd	—	35 50	36 51	37 52	38 53	39 54	40 55 56	41 57 58
3rd	—	42 59	43 60	44 61	45 62	46 63	47 64 65	48 66 67
4th	—	49 68	50 69	51 70	52 71	53 72	54 73 74	55 75 76
5th	—	56 77	57 78	58 79	59 80	60 81	61 82 83	62 84 85
6th	—	63 86	64 87	65 88	66 89	67 90	68 91 92	69 93 94

CODING SECTION

COMPLETED BY TEAM

INTERVIEW CONTACT RECORD

Contact Sequence	Month	Day	Year	Time of Contact	Contacting Investigator	Manner	Result
1st	9		8	10.	11.	12.	13.
2nd	14		8	15.	16.	17.	18.
3rd	19		8	20.	21.	22.	23.
4th	24		8	25.	26.	26.	28.
5th	29		8	30.	31.	32.	33.
6th	34		8	35.	36.	37.	38.
7th	39		8	40.	41.	42.	43.
8th	44		8	45.	46.	47.	48.

LOG RESPONSES

Manner

- (1) Telephone
- (2) Personal visit to home, work, etc
- (3) Letter (questionnaire)
- (4) Other (specify)

Result of Last Contact Attempt

- (01) Unable to contact or locate
- (02) Hit and run
- (03) Fatal—surrogate not available
- (04) In intensive care—surrogate not available
- (05) Out of State resident
- (06) Refused interview for other than on advice of attorney or insurance company (specify)

- (07) Insurance company refusal
- (08) Attorney refusal or litigation
- (09) Other (specify)

- (10) No return of letter questionnaire
- (11) Return of letter questionnaire (completed)
- (12) Partial or complete interview

Result of Contact Attempt Other than Last Contact Attempt

- (13) No answer (to phone call, no one home, etc.)
- (14) Other person at home, work, etc –Interviewee to contact investigator
- (15) Other person at home, work, etc –Investigator to repeat call, visit, leave questionnaire, or try elsewhere
- (16) Must obtain permission of attorney or insurance company.
- (17) Attorney or insurance company provided permission
- (18) Other (specify)

National Accident Sampling System – Continuous Sampling Subsystem: Occupant Data

If any of the coded injury Sources have "other" codes, i.e., 09, 15, 19, 29, 49, 53, 69, 73, 79, 83 or 87; describe the injury source below in the space provided. Clearly indicate each description by numerical value.

POLICE, HOSPITAL/MEDICAL, OR OTHER OFFICIAL

71. Time of Death

____ (00) Not fatal
 _____ Code number of hours from time of accident to time of death up through 24 hours. If time of death is greater than 24 hours, code number of days (Note: 1 day = 31, 2 days = 32, n days = 30+n up through 30 days = 60)

____ (96) Fatal—ruled disease

____ (99) Unknown

96 97

POLICE REPORT

70 Injury Severity (Police Rating)

____ (0) No injury (O)

____ (1) Possible injury (C)

____ (2) Nonincapacitating injury (B)

____ (3) Incapacitating injury (A)

____ (4) Killed (K)

____ (5) Injury, severity unknown

____ (6) Died prior to accident

____ (9) Unknown

95

COMMENTS:

Delete Comments After Case Review

COMPLETED BY TEAM	
1. Primary Sampling Unit Number	1 2
2. Case Number—Stratification	3 4 5 6
3. Record Number	5 7
4. Transaction Code	8
5. Version Number	7 9
6. Investigator I.D. Number	10

OCCUPANT INTERVIEW	
7. Vehicle Number	11 12
8. Occupant Number	13 14
9. Is This Occupant a Driver (0) No (1) Yes (9) Unknown	15
10. Manner of Last Contact Attempt (1) Telephone (2) Personal visit to home, work, etc. (3) Letter (questionnaire) (4) Other (specify)	16
11. Result of Last Contact Attempt (01) Unable to contact or locate (02) Hit and run (03) Fatal—surrogate not available (04) In intensive care—surrogate not available (05) Out of State resident (06) Refused interview for other than on advice of attorney or insurance company (specify) (07) Insurance company refusal (08) Attorney refusal or litigation (09) Other (specify) (10) No return of letter questionnaire (11) Return of letter questionnaire (completed) (12) Partial or complete interview	17 18
12. Date Interview Completed	8 19 20 21 22 23 24
13. Completing Person	25

14. Source of Interview Data (1) No data obtained (2) Same person (3) Other occupant (or driver) (4) Relative or friend (5) Eyewitness (6) Combination of 3, 4 or 5 (7) Other (specify)	26
15. Reasons Medical Data Not Obtainable (00) Not medically treated (01) Record obtained (02) No record of treatment at medical facility (03) Medical release required—not obtained (04) Nonaccident related injury (05) Noncooperative hospital (06) Hospital out of study area (07) Private physician would not release information (08) To be updated (09) Record not received before file closed (10) Unknown if medically treated	27 28

COMPLETED BY ZONE CENTER	
16. Date Medical Record Update Received	8 29 30 31 32 33 34
17. Reviewed By	35 36
18. Interviewee Injury Documentation (1) Complete—Injury descriptions are annotated in sufficient detail to enable independent OIC/AIS coding. The protocol for completing the injury diagram has been used and a contact mechanism or “unknown” is indicated. (2) Partial—All coded injuries are described in adequate detail, however, additional annotation helpful for independent OIC/AIS coding. Contact mechanism omitted for some injuries. (3) Incomplete—Generally inadequate description of injuries or the coded injury does not correspond to the annotated injury. (4) NA—No interviewee reported injuries.	37
19. Official Injury Documentation (1) Complete—All injuries reported in the medical data are annotated with sufficient detail to enable an independent OIC/AIS coding. The protocol for completing the injury diagram has been used. (2) Partial—All coded injuries are described in adequate detail, however, additional annotation helpful for independent OIC/AIS coding. Some minor injuries described in the medical data may be omitted (3) Incomplete—Generally inadequate or erroneous descriptions of injuries and/or omitted major injuries described in the medical data. (4) NA—No official medical data.	38



Occupant Update Record

This section must be completed prior to initial case submission

<table style="width:100%; border-collapse: collapse;"> <tr> <td style="width:30%;">1. Primary Sampling Unit Number</td> <td style="width:10%; text-align: center;">1</td> <td style="width:10%; text-align: center;">2</td> <td style="width:10%;"></td> <td style="width:10%;"></td> <td style="width:10%;"></td> <td style="width:10%;"></td> </tr> <tr> <td>2. Case Number - Stratification</td> <td style="text-align: center;">3</td> <td style="text-align: center;">4</td> <td style="text-align: center;">5</td> <td style="text-align: center;">6</td> <td></td> <td></td> </tr> <tr> <td>3. Record Number</td> <td></td> <td></td> <td style="text-align: center;">5</td> <td style="text-align: center;">7</td> <td></td> <td></td> </tr> <tr> <td>4. Transaction Code</td> <td></td> <td></td> <td style="text-align: center;">2</td> <td style="text-align: center;">8</td> <td></td> <td></td> </tr> <tr> <td>5. Version Number</td> <td></td> <td></td> <td style="text-align: center;">7</td> <td style="text-align: center;">9</td> <td></td> <td></td> </tr> <tr> <td>6. Investigator I.D. Number</td> <td></td> <td></td> <td></td> <td style="text-align: center;">10</td> <td></td> <td></td> </tr> <tr> <td>7. Vehicle Number</td> <td></td> <td></td> <td style="text-align: center;">11</td> <td style="text-align: center;">12</td> <td></td> <td></td> </tr> <tr> <td>8. Occupant Number</td> <td></td> <td></td> <td style="text-align: center;">13</td> <td style="text-align: center;">14</td> <td></td> <td></td> </tr> </table>	1. Primary Sampling Unit Number	1	2					2. Case Number - Stratification	3	4	5	6			3. Record Number			5	7			4. Transaction Code			2	8			5. Version Number			7	9			6. Investigator I.D. Number				10			7. Vehicle Number			11	12			8. Occupant Number			13	14			<p>OCCUPANT'S NAME _____</p> <p>Address: _____</p> <p style="text-align: center;">(Delete before submission)</p> <p>DATA ON INITIAL SUBMISSION.</p> <p>A08. Final Stratification _____</p> <p>20. Treatment - Mortality _____</p> <p>21. Hospital Stay _____</p> <p>22. Working Days Lost _____</p> <p>71. Time of Death _____</p>
1. Primary Sampling Unit Number	1	2																																																							
2. Case Number - Stratification	3	4	5	6																																																					
3. Record Number			5	7																																																					
4. Transaction Code			2	8																																																					
5. Version Number			7	9																																																					
6. Investigator I.D. Number				10																																																					
7. Vehicle Number			11	12																																																					
8. Occupant Number			13	14																																																					

ENTER RESPONSE FOR EACH VARIABLE WHERE DATA ON INITIAL SUBMISSION WAS UNKNOWN OR IS FELT TO BE IN ERROR, GIVEN RECEIPT OF OFFICIAL MEDICAL RECORD(S)

A08. Final Stratification	15	16
9. Occupant's Age	15	16
10. Occupant's Sex		17
20. Treatment - Mortality		31
21. Hospital Stay	32	33
22. Working Days Lost	34	35

Complete prior to initial case submission

INJURY DATA CODED ON INITIAL SUBMISSION

28	29	30	31	32	33	34
35	36	37	38	39	40	41
42	43	44	45	46	47	48
49	50	51	52	53	54	55
56	57	58	59	60	61	62
63	64	65	66	67	68	69

UPDATED INJURY DATA BASED ON SUBSEQUENTLY ACQUIRED OFFICIAL MEDICAL DATA
[or reason data not obtained (see response for log variable 15) _____]

1st	28.	41	29.	42	30.	43	31.	44	32.	45	33.	46	47	34.	48	49
2nd	35.	50	36.	51	37.	52	38.	53	39.	54	40.	55	56	41.	57	58
3rd	42.	59	43.	60	44.	61	45.	62	46.	63	47.	64	65	48.	66	67
4th	49.	68	50.	69	51.	70	52.	71	53.	72	54.	73	74	55.	75	76
5th	56.	77	57.	78	58.	79	59.	80	60.	81	61.	82	83	62.	84	85
6th	63.	86	64.	87	65.	88	66.	89	67.	90	68.	91	92	69.	93	94
	71. Time of Death															

OFFICIAL INJURY DATA

Indicate the *Nature* and *Location* of *All* injuries.

Soft Tissue Injuries

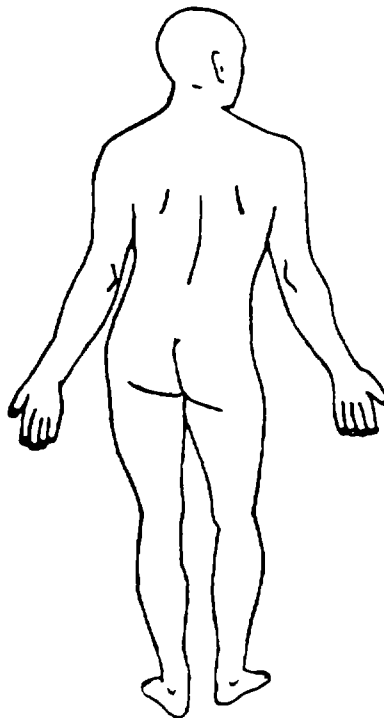
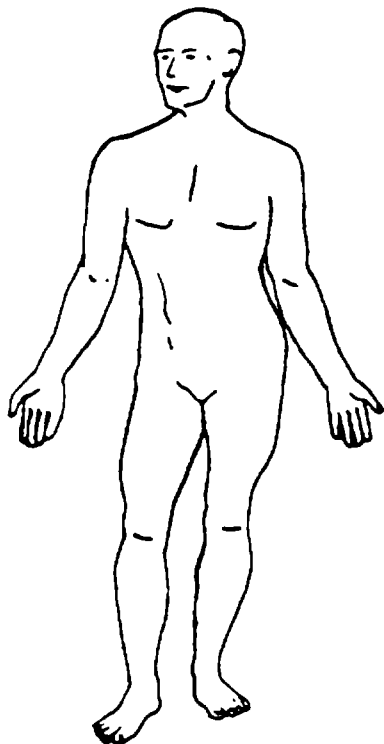

Skeletal Injuries

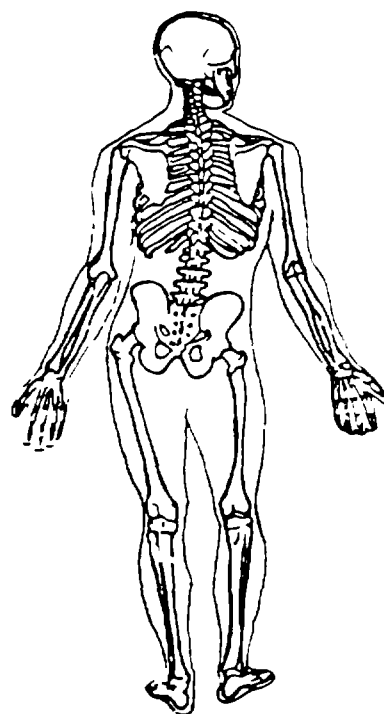
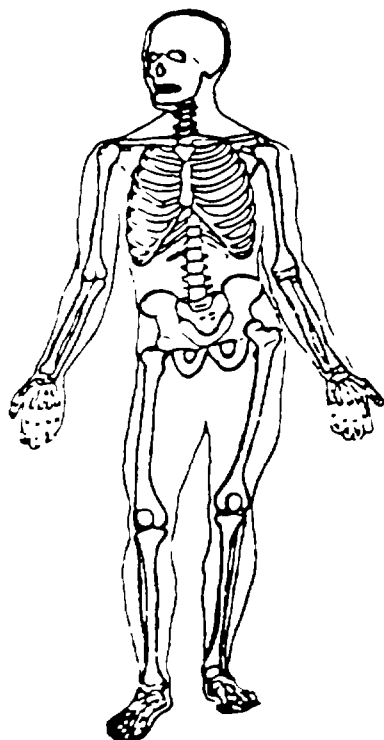

Variable Name: Investigator I.D. Number

Format: 1 column - numeric

Beginning
Column 10

Element Values:

Level 1 Range: 0 through 9

Source: Zone Center.

Remarks:

The person who was primarily responsible for the completion of this Occupant Form shall enter his/her unique number.

Each investigator's unique number is assigned by the PSU's Zone Center.

This variable is a mandatory variable and cannot be changed.

Variable Name: Vehicle Number

Format: 2 columns - numeric

Beginning
Column 11

Element Values:

Level 1 Range: 01 through 30

Source: Investigator assigned.

Remarks:

Code the Vehicle Number for the vehicle in which this occupant was riding (i.e., as a driver or as a passenger--in or on the vehicle).

One and only one occupant is assumed to be in a hit-and-run vehicle (unless reliable evidence to the contrary exists), and that one person is also assumed to be the driver.

This variable is a mandatory variable and cannot be changed.

Variable Name: Occupant Number

Format: 2 columns - numeric

Beginning
Column 13

Element Values:

Level 1 Range: 01 through 50

Source: Investigator assigned.

Remarks:

Occupant numbers must be assigned sequentially, beginning in the enclosed area with "01". No numbers may be skipped. Assign numbers left to right and front to back among occupants.

Assign numbers last to persons on the vehicle or in an unenclosed area. Persons appended to vehicle for motion (e.g., bicyclist holding onto vehicle) are either pedestrians or other nonmotorists.

Persons on a motorcycle are assigned numbers sequentially, starting with "01". Assign numbers from front to back among occupants. If there are occupants in a side car, they are to be coded after the motorcycle occupants by assigning numbers left to right and front to back among the remaining occupants.

Drivers do not have to be coded "01" (e.g., right hand drive vehicles containing left front occupant). However, code the assumed driver of a hit-and-run vehicle as "01".

An occupant on or in the lap of another person should be assigned a number one higher than the person whose lap they were on or in.

Occupants sharing a seating position should be assigned numbers using the guidelines stated in the first paragraph above.

This variable is a mandatory variable and cannot be changed.

Variable Name: Occupant's Age

Format: 2 columns - numeric

Beginning
Column 15

Element Values:

Level 1 Range: 00-97, 99
00 Less than one year old
97 97 years and older
99 Unknown

Source: Primary source is interviewee; secondary sources include police report and official records (e.g., medical, license).

Remarks:

Age is recorded at time of accident with respect to the occupant's last birthday.

For drivers, verify age with data on licensing file. Licensing file data takes precedence over police or interview data.

OCCUPANT FORM

O10

Variable Name: Occupant's Sex

Format: 1 column - numeric

Beginning
Column 17

Element Values:

- 1 Male
- 2 Female
- 9 Unknown

Source: Primary source is interviewee; secondary sources include police report and official records (e.g., medical).

Remarks:

Self-explanatory.

OCCUPANT FORM

011

Variable Name: Occupant's Height

Format: 2 columns - numeric

Beginning
Column 18

Element Values:

Level 2 Range: 12 through 85 inches
99 Unknown

Source: Investigator determined--inputs include interviewee or official records (e.g., medical).

Remarks:

Code actual height to nearest inch.

The PAR may be used as a source if it contains this data, but it is superceded if other data exists.

Variable Name: Occupant's Weight

Format: 3 columns - numeric

Beginning
Column 20

Element Values:

Level 2 Range: 005 through 300 pounds
999 Unknown

Source: Investigator determined--inputs include interviewee or official records (e.g., medical).

Remarks:

Code actual weight to nearest pound.

The PAR may be used as a source if it contains this data, but it is superceded if other data exists.

Variable Name: Occupant's Role

Format: 1 column - numeric

Beginning
Column 23

Element Values:

- 1 Driver
- 2 Passenger
- 9 Unknown

Source: Primary source is interviewee; secondary source is police report.

Remarks:

Hit-and-run vehicles are assumed to have only one occupant (unless reliable evidence to the contrary exists) and that person is assumed to be the driver.

Variable Name: Occupant's Seat Position

Format: 2 columns - numeric

Beginning
Column 24

Element Values:

01 Front seat - left side	10 Front seat - additional passenger
02 Front seat - middle	11 Second seat or beyond - additional passenger
03 Front seat - right side	12 Truck-tractor sleeping section
04 Second seat - left side	13 Other enclosed area (specify)
05 Second seat - middle	14 In or on unenclosed area (specify)
06 Second seat - right side	15 In or on trailing unit (specify)
07 Third seat - left side	99 Unknown
08 Third seat - middle	
09 Third seat - right side	

Source: Primary source is interviewee; secondary source is police report.

Remarks:

More than one person may have the same seating position (e.g., child on or in mother's lap).

For motorcycles, code driver "01" (Front seat - left side), all sidecar passengers "02" (Front seat - middle), all passengers behind the driver "04" (Second seat - left side), and all passengers on lap of driver (in front of) "01".

In coupes and other cars designed for only 2 passengers in front or in back, use codes "01", "03", "04", "06", "07", or "09" when coding occupants.

Codes "10" and "11" can be used to record the position of someone sitting on the floor or lying across the seat. In addition, when two or more persons are sitting abreast of one another in the same seating location (as opposed to on or in someone's lap), since only one can be assigned the seat's position, the additional passenger codes "10" and "11" must be used. Assign the older person the seat's position (i.e., codes "01"- "09").

If the only real seat in the front seating area is a driver's seat and the occupant was in the area but not in the seat, code "10" (Front seat - additional passenger) should be used. This situation could occur because of design (e.g., an RV) or if a seat was removed. If a second or additional seating area can be identified and a person is in the area, but not in a designated seat, then code "11" (Second seat or beyond - additional passenger) should be used.

Code "01" should be assigned to the assumed driver of a hit-and-run vehicle unless evidence indicates a different position for the person or persons.

Variable Name: Occupant's Seat Position (cont'd.)

Codes "11" (Second seat or beyond - additional passenger) and "13" [Other enclosed area (specify)] are differentiated as follows:

Use Code "11" - for occupants in designated seating positions beyond the third seat as well as occupants additional to the second and third seats.

Use Code "13" - for occupants located in the enclosed area where no defined seating exists. Use this code for an occupant using a fold-down type seat in its folded down position.

Code "14" [In or on unenclosed area (specify)] includes those occupants riding on a fender, the boot of a convertible, the open cargo box on a truck, etc. Persons appended to the vehicle for motion are either pedestrians or other nonmotorists.

For buses use the following scheme:

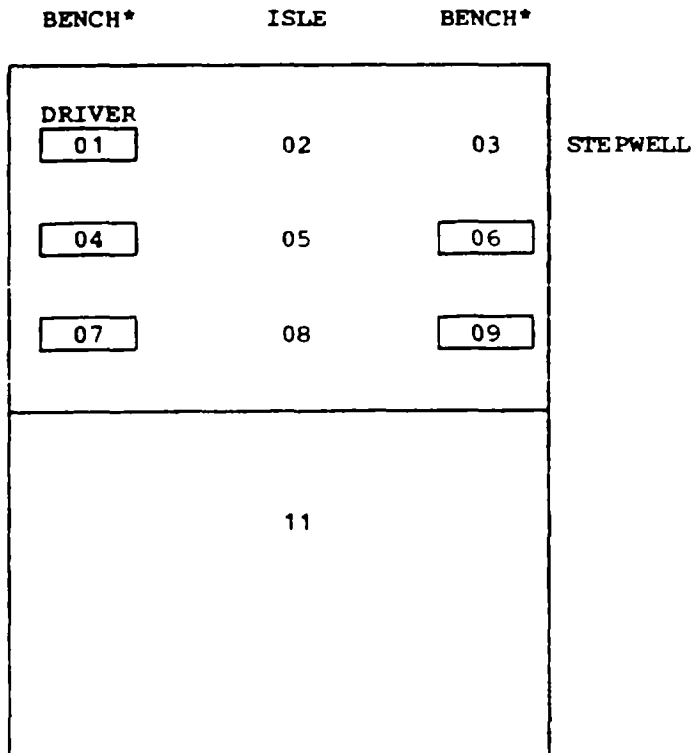

*Regardless of whether seat is lateral or longitudinal.

Variable Name: Entrapment

Format: 1 column - numeric

Beginning
Column 26

Element Values:

- 0 Not entrapped
- 1 Entrapped
- 9 Unknown

Source: Investigator determined--inputs include the vehicle inspection, interviewee, and the police report.

Remarks:

Code "0" (Not entrapped) for the driver or occupants of a motorcycle. However, this does not include the sidecars.

Code "1" (Entrapped) means that part of the occupant was in the vehicle and mechanically restrained by a damaged vehicle component; jammed doors and immobilizing injuries, by themselves, are not sufficient to constitute entrapment. Entrapment by cargo shift is also not sufficient.

Persons who are completely or partially ejected and subsequently become pinned by their own vehicle and any surface other than their own vehicle are not considered entrapped.

If the vehicle is not inspected and/or the occupant is not interviewed but the police report states that the person was "trapped", the investigator must verify through the officer, emergency personnel, or other witnesses that the person was, in fact, in the vehicle and mechanically restrained. This is because the above definition is more restrictive than common usage of the term. Code "9" (Unknown) if unable to obtain verification in the above situation.

The margin indicator, which references the Vehicle Form, should be filled in with the applicable code or with a checkmark (✓) to indicate that the actual crosscheck back to the Vehicle Form has been made prior to coding the investigator's final opinion.

Variable Name: Ejection

Format: 1 column - numeric

Beginning
Column 27

Element Values:

- 0 None
- 1 Complete ejection
- 2 Partial ejection
- 3 Ejection, unknown degree
- 9 Unknown

Source: Investigator determined--inputs include the vehicle inspection, interviewee, and the police report.

Remarks:

Code "0" (None) for the driver or occupants of a motorcycle (not including sidecar) or any persons riding on the exterior of a vehicle, such as the fenders (this does not include pickup beds, flat beds, boot of a convertible, and persons riding on open tailgates).

Ejection refers to persons being completely or partially thrown from the vehicle during the course of the crash.

Code "1" (Complete ejection) refers to a situation where the occupant's body is entirely outside the vehicle but may be in contact with the vehicle.

Code "2" (Partial ejection) refers to a situation where part of the occupant's body remains in the vehicle. This does not apply to occupants who are not initially in the seating compartment of the vehicle [e.g., pickup beds, motorcycle sidecars, flat beds, boot of a convertible, and persons riding on open tailgates, since any ejection for them is coded as "1" (Complete ejection)].

Persons in or on an "other vehicle" (V14, "80" through "89") will have to be handled depending upon the occupant protection provided. If the occupant can be contained (at least from the waist down) inside of the occupant compartment, then ejection is relevant; otherwise, code "0" (None) for those occupants.

Police report d ejections may be coded if there is no vehicle inspection or occupant interview, provided that the ejectee was in the seating compartment

OCCUPANT FORM

016

(2)

Variable Name: Ejection (cont'd.)

of the vehicle and there is no evidence which contradicts the reported ejection.

The margin indicator, which references the Vehicle Form, should be filled in with the applicable code or with a checkmark (✓) to indicate that the actual crosscheck back to the Vehicle Form has been made prior to coding the investigator's final opinion.

Variable Name: Ejection Area

Format: 1 column - numeric

Beginning
Column 28

Element Values:

- 0 No ejection
- 1 Windshield
- 2 Left front
- 3 Right front
- 4 Left rear
- 5 Right rear
- 6 Rear
- 7 Roof
- 8 Other area (e.g., sidecar, back of pickup, etc.)
- 9 Unknown

Source: Investigator determined--inputs include the vehicle inspection, interviewee, and the police report.

Remarks:

Code "0" (No ejection) applies to persons who are not ejected, to motorcycle occupants in other than a sidecar, or to persons riding on fenders.

Code "6" (Rear) is restricted to persons riding in a passenger compartment, who are ejected through the rear window, open tailgate (e.g., station wagon), hatchback, etc.

Codes "1" through "7" are designated for use with areas designed for passenger protection (e.g., passenger cars, vans, truck cabs, self-contained RVs and motor homes). Trailers, add-on campers, haywagons, etc., are to be assigned code "8" (Other area).

Code "7" (Roof) applies to all hardtops, convertibles, sun roofs, t-bar roofs, and detachable hardtops (such as fiberglass tops) that are used to cover areas designed for passenger protection..

Examples of how variables 018 (Ejection Medium) and 019 (Medium Status) should be coded when 017 = 7 follows.

Variable Name: Ejection Area (cont'd.)

016	Roof Type	Roof Status	017	018	019
No ejection 0	Any roof	Open or closed	0	0	0
Ejection 1-3	Hardtop	Ripped open	7	8	4
Ejection 1-3	Hardtop	Detached	7	2	1
Ejection 1-3	Convertible	In down or open position	7	2	1
Ejection 1-3	Convertible	In closed position	7	8	3
Ejection 1-3	Sun or t-bar	Ripped open	7	8	4
Ejection 1-3	Sun or t-bar	Open/removed	7	2	1
Ejection 1-3	Sun or t-bar	Closed	7	8	3
Unknown 9	Any roof	Open or closed	9	9	9

Code "8" (Other area) also applies to persons riding on open tailgates. Persons ejected from other vehicles with waist down protection but not encapsulated should also be coded here.

Code "9" (Unknown) if the sole source for the ejection is the police report.

The margin indicator, which references the Vehicle Form, should be filled in with the applicable code or with a checkmark (✓) to indicate that the actual crosscheck back to the Vehicle Form has been made prior to coding the investigator's final opinion.

Variable Name: Ejection Medium

Format: 1 column - numeric

Beginning
Column 29

Element Values:

- 0 No ejection
- 1 Door
- 2 Open roof structure
- 3 Fixed windows
Operable Windows
- 4 Roll down type
- 5 Hinged type
- 6 Sliding type
- 7 Other type (specify)
- 8 Other medium (specify)
- 9 Unknown

Source: Investigator determined--inputs include the vehicle inspection, interviewee, and the police report.

Remarks:

Code "0" (No ejection) applies to persons who are not ejected, to motorcycle occupants in other than a sidecar, or to persons riding on fenders.

Code "8" (Other medium) applies to persons riding in pickup beds, on flat beds, in sidecars, on open tailgates, and for other situations which cannot be classified in codes "1"- "7", such as standard roofs which are torn open.

In addition, use "8" when someone is ejected from a trailer or from an add-on camper, haywagon, other vehicle with only waist down protection etc.

Codes "4"- "7" all refer to windows.

Code "2" (Open roof structure) applies only to convertible, sun roofs, and t-bar roofs.

Code "9" (Unknown) if the sole source for the ejection is the police report.

The margin indicator, which references the Vehicle Form, should be filled in with the applicable code or with a checkmark (✓) to indicate that the actual crosscheck back to the Vehicle Form has been made prior to coding the investigator's final opinion.

Variable Name: Medium Status

Format: 1 column - numeric

Beginning
Column 30

Element Values:

- 0 No ejection
- 1 Open
- 2 Separation
- 3 Closed, closed when damaged
- 4 Integral structure ripped open
- 9 Unknown

Source: Investigator determined--inputs include the vehicle inspection, interviewee, and the police report.

Remarks:

Code "0" (No ejection) applies to persons who are not ejected, to motorcycle occupants in other than a sidecar, or to persons riding on fenders.

Code "1" (Open) applies to convertible roofs, sun roofs, t-bar roofs, windows, doors or tailgates that are open immediately prior to impact, or to other open areas of vehicles such as pickup beds, motorcycle sidecars, other vehicles with only waist down protection and flat bed trucks.

Codes "1" (Open) and "3" (Closed, closed when damaged) refer to the status of the medium immediately prior to the impact.

Code "2" (Separation) is restricted to use only with bonded windows, and it reflects a separation which may be attributable to either the forces of the collision or to internal contact.

Code "3" (Closed, closed when damaged) refers to a window that is closed or partially closed when damaged, or to a convertible, sun, or t-bar roof that is closed when damaged. Sun and t-bar roofs are coded here if the ejection occurred through the designed opening in the sun or t-bar roof. However, if the roof was of a sun or t-bar type but the ejection occurred because a sizeable opening was torn in the roof structure, then code "4" (Integral structure ripped open) should be used.

Code "3" (Closed, closed when damaged) also refers to a door that is closed, but when damaged, experiences latch and/or hinge failure causing the door to open.

Code "4" (Integral structure ripped open) should be used when any vehicle structure, not designed to be opened (.g., standard roof), is torn open during the accident such as to permit ejection.

OCCUPANT FORM

019

(2)

Variable Name: Medium Status (cont'd.)

Code "9" (Unknown) if the sole source for the ejection is the police report.

The margin indicator, which references the Vehicle Form, should be filled in with the applicable code or with a checkmark (✓) to indicate that the actual crosscheck back to the Vehicle Form has been made prior to coding the investigator's final opinion.

Variable Name: Treatment - Mortality

Format: 1 column - numeric

Beginning
Column 31

Element Values:

- 1 Fatal
- 2 Fatal - ruled disease
Nonfatal
- 3 Hospitalization
- 4 Transported and released
- 5 Treatment - other (specify)
- 6 No treatment
- 9 Unknown

Source: Investigator determined--inputs include interviewee, police report,
and medical records.

Remarks:

Official sources (if they exist) take precedence over interview data.

Code "1" (Fatal) when death occurs within 30 days of accident. Death must have occurred as a consequence of injuries sustained in the traffic accident.

Code "2" (Fatal - ruled disease) is used in two situations. The first is when the effects of a disease can be deemed as a cause of the accident. Cause means that the on-set of the disease occurred prior to the first harmful event. When determining the time of on-set (relative to the first harmful event), the investigator can use any information source available. The investigator makes his/her determination after weighing all the evidence. (NOTE: The use of all available information sources is restricted to the determination of when the on-set occurred.) Additionally, code "2" (Fatal - ruled disease) is used when a medical examiner (or other official vested by the state to verify the cause of death) or an official medical report verifies that the death resulted from either (1) a diseased condition, or (2) not from accident related injuries.

Code "3" (Hospitalization) when hospitalization occurs as a result of injury (need not be taken directly to a hospital). See Hospital Stay (021) for hospitalization criteria. Also use this code if a person is treated and released then subsequently hospitalized as a result of injuries sustained in the accident.

Variable Name: Treatment - Mortality (cont'd.)

Code "4" (Transported and released) when the person went directly from the accident scene to a treatment facility (hospital, clinic, doctor's office, etc.), and the person is examined for injuries at the facility. The person need not have been injured. The means of transportation is not a consideration.

Code "5" (Treatment - other) includes doctor treatment, treatment at scene, first aid, self-treatment, hospital (if other than directly from scene but treated and released), etc.

Code "6" (No treatment) includes persons transported to a hospital but who refuse treatment. As long as there was transportation directly from the scene, a refusal of treatment will not, on its own, affect the Final Stratification (A08) of the case.

If a person survives the injuries and receives treatment at a hospital, but is not admitted for hospitalization, that person's treatment is to be coded as either "4" or "5", depending upon whether the person went directly or indirectly to the hospital. It does not matter if the person is treated for one hour or twelve, only that the person is released following treatment. Nor does it matter if the treatment begins prior to midnight and spans into the following day.

Injury Data From Interviewee

This page is separated into four body diagrams: front and back soft tissue injuries and front and back skeletal injuries. These diagrams allow the documentation of all injuries sustained by an occupant in the accident, as stated by the interviewee.

The nature, location, and injury source should be documented as follows:

Nature - As stated by the interviewee, document the lesion sustained (e.g., laceration, fracture, concussion, etc.) and its extent (e.g., size, severity, depth, etc.). The terms used by the interviewee may not necessarily coincide with the terms found in the OIC, but the injury should be documented as stated by the interviewee for ease of completion of this form during the interview. Length of unconsciousness, or state of consciousness on first observation by medical authorities, and whether unconsciousness was a result of a head contact, should be noted.

Location - The location of the injury, as stated by the interviewee, should be documented in two ways:

- By arrows, shading, bracketing (for large areas) on the body diagram; or
- By written description (e.g., left lower arm, right third rib, etc.). The written description may be abbreviated to aid in completion of the page during the interview. Refer to the Injury Coding Manual for standard abbreviations and symbols.

Source - The interviewee should be queried as to the source of the injury. This information gained from the interviewee may aid in the final coding of injury source in variables O33, O40, O47, O54, O61 and O68 and in the vehicle inspection (if not done previous to interview), and accident reconstruction. The injury source should be written immediately below the nature and written location of the injury and delineated by a horizontal line. If the interviewee does not know the source of the injury, unknown should be documented on the form.

Variable Name: Hospital Stay

Format: 2 columns - numeric

Beginning
Column 32

Element Values:

Level 1 Range: 00-61, 99

00 Not hospitalized

Code number of days hospitalized up through 60

61 61 days or more

99 Unknown

Source: Investigator determined--inputs include interviewee and medical reports.

Remarks:

Official sources (if they exist) take precedence over interview data.

Code "00" (Not hospitalized) if not injured or injured but not admitted.

Code "00" (Not hospitalized) if fatal at scene, pronounced dead on arrival, or survival does not extend beyond the emergency room.

The basis for the number of days coded is an overnight criterion. Every time a person remains past midnight subsequent to admission, it is one day. The only exception is when a person dies on the same day as the admission.

In the event that the person survives the emergency room but dies subsequent to admission, then code at least "01", even if the person expires the same day as admitted.

If a person is admitted, lived four days in the hospital, then expired, code "04".

Variable Name: Working Days Lost

Format: 2 columns - numeric

Beginning
Column 34

Element Values:

Level 1 Range: 00-62, 99

00 No working days lost

Code number of days for which work was lost up through 60

61 61 days or more

62 Fatally injured

99 Unknown

Source: Primary source is the interviewee; a secondary source is the person's employer.

Remarks:

Report the actual number of "work" days lost due to the accident by an employed person or a full-time college student. Children, adolescents, retirees, or unemployed persons are not included.

Employed is defined to mean that the person was scheduled to work at least four hours on each of the days lost. Each such day is counted as a full day so long as the person was scheduled to work at least four hours on the day lost. Do not accumulate the hours and convert to equivalent full-time days; however, indicate on the form if the person works less than full-time but greater than four hours per day by annotating "part-time" or "PT".

If during the interview a reasonable projection of future days lost can be made, then add those days to those already known to have been lost. If a reasonable projection cannot be made, then code "99" (Unknown).

The days lost need not be due to injury.

Days lost include Saturdays, Sundays, and afternoon and evening shifts if so scheduled. Do not count double shifts or days at time and one-half pay, etc., as more than one day.

If a person is not employed, not a full-time college student, or works less than four hours per day, then code "00" (No working days lost). This code includes all persons (except fatals) who do not qualify to lose working days.

If a person is fatal - ruled disease, fatal at scene, pronounced dead on arrival, or survival does not extend beyond the emergency room, then code "62" (Fatally injured) is used.

OCCUPANT FORM

022

(2)

Variable Name: Working Days Lost (cont'd.)

If a person expires within thirty days following the accident, code "62" regardless of whether or not the person missed any working days.

If the reported work days lost includes a fraction, round one-half (1/2) day or greater up to a whole day. Less than one-half day should be excluded (rounded down).

If someone gets fired and loses their job as a result of the accident, count only the work days lost between the accident and the date of termination, inclusive.

Do not include days lost by persons who were not directly involved in the accident but who lost days because of it (e.g., husband who was not in accident but stayed home to take care of wife who was injured and required assistance).

If no interview is obtained, there is a rebuttable presumption that persons over 65 or under 17 are not employed full-time; for these persons code "00" (No working days lost) should be used unless the person is fatally injured [codes "1" (Fatal) or "2" (Fatal - ruled disease) for O20, Treatment - Mortality].

Variable Name: Manual (Active) Restraint System Availability

Format: 1 column - numeric

Beginning
Column 36

Element Values:

- 0 None available
- 1 Shoulder belt
- 2 Lap belt
- 3 Lap belt and shoulder belt
- 4 Motorcycle helmet
- 5 Child safety seat (designed without tether or unknown design)
- 6 Child safety seat (designed with tether - properly installed)
- 7 Child safety seat (designed with tether - improperly installed)
- 8 Restraint available - type unknown or other (specify)
- 9 Unknown

Source: Investigator determined--inputs include vehicle inspection, interviewee, and police report.

Remarks:

Select the system which was available for use, if so desired, by the occupant. Restraints which were installed but subsequently removed or cut should not be considered to be available. In other words, availability is determined by presence and functional status; use is not to be considered in making this determination.

Belts which are knotted, buckled at the rear of the seat bench, stored below the bench, etc., should be considered as available if they were otherwise operative.

Persons such as children who are held by another person are not considered to be restrained, nor to have restraints available.

A motorcycle helmet (code "4") is to be considered available to all riders of the motorcycle, even if there are more riders than helmets. However, if it is in use by a person, then it is available only to that person.

Codes "5", "6", and "7" (Child safety seat) is considered available if located so as to be retrievable by a person while in the passenger compartment (i.e., the safety seat is not in the trunk, trailer, etc.). It should be coded as available for all applicable children (i.e., less than 50 pounds and less than 40 inches) if it exists, even if there are more children than safety seats. However, if it is in use by a child, then it is available only to that person.

Variable Name: Manual (Active) Restraint System Availability [cont'd.]

Code "5" [Child safety seat (designed without tether or unknown design)] should be used when a child safety seat is designed to be restrained by means other (e.g., lap belt) than a tether or when an unknown design is available.

Code "6" [Child safety seat (designed with tether - properly installed)] should be used when a child safety seat equipped with a tether--designed to be attached to a rear seat lap belt or to a special attachment mounted on the backlight package shelf--is available and is properly installed in the vehicle. This type of child safety seat must also, in most cases, be further restrained by a lap belt to be considered properly installed.

Code "6" may be used only when the tether-designed child seat is available and properly installed. If a child safety seat which is designed with a tether is improperly or incompletely installed (i.e., tether not used), then use code "7" [Child safety seat (designed with tether - improperly installed)].

If the child seat is designed with tether but the properness of the installation is unknown and available information does not support improper installation, then code the restraint system availability as code "6" [Child safety seat (designed with tether - properly installed)].

Identify any "other" restraint if the variable is coded "8" (Restraint available - type unknown or other). If there is no vehicle inspection or interview but the PAR indicates that: (1) belts were used, or (2) belts were not used, then code "8" (Restraint available - type unknown or other) should be used. If the PAR indicates the type of belts available and there was no vehicle inspection or interview, then the appropriate code "1", "2", "3", "4", or "5" may be used; however, codes "6" and "7" may not be coded strictly from the PAR since proper installation must be assessed.

The margin indicator, which references the Vehicle Form, should be filled in with the response from the Vehicle Form to aid the actual crosscheck prior to coding the investigator's final opinion.

Variable Name: Manual (Active) Restraint System Use

Format: 1 column - numeric

Beginning
Column 37

Element Values:

- 0 None used
- 1 Shoulder belt
- 2 Lap belt
- 3 Lap belt and shoulder belt
- 4 Motorcycle helmet
- 5 Child safety seat - used properly
- 6 Child safety seat - used improperly
- 7 Child safety seat - unknown if used properly
- 8 Restraint used - type unknown or other (specify)
- 9 Unknown

Source: Investigator determined--inputs include vehicle inspection, interviewee, and police report.

Remarks:

Code "3" (Lap belt and shoulder belt) is used when the occupant is "encompassed" both in the lap and upper torso region by a lap and shoulder belt combination. Defeated interlock or buzzer warning systems, as well as maladjustment of the belts do not detract from the usage; however, if the inertia reel, retracting mechanism, or latch mechanism malfunctioned, the lap and/or shoulder belt which failed should not be considered as used. If a person has an integral lap and shoulder belt but is only "encompassed" by the lap portion (having the shoulder belt behind his or her back), code "2" (Lap belt).

Codes "1" (Shoulder belt) and "2" (Lap belt) must be similarly considered.

Code "4" (Motorcycle helmet) is to be used if the helmet is worn; it is not necessary for the chin strap to be used.

Code "5" (Child safety seat - used properly) is to be indicated only when the safety seat is installed so as to comply with the manufacturer's directions (i.e., seat must be integrated with the vehicle via the seat belts, through the use of a tether, etc.), and it is occupied by the child.

Code "6" (Child Safety Seat - used improperly) is to be indicated when a child safety seat is not installed according to the manufacturer's directions, and it is occupied by the child.

Variable Name: Manual (Active) Restraint System Use [cont'd.]

Code "7" (Child safety seat - unknown if used properly) is to be indicated when a child safety seat is occupied by a child, but it is unknown if the seat was installed according to the manufacturer's directions.

Code "8" (Restraint used - type unknown or other) if there is no vehicle inspection or interview and the PAR indicates "belts were used". However, code "0" (None used) if the PAR indicates "belts were not used".

The PAR is a legitimate source for belt usage only if no interview was conducted, no vehicle inspection was completed, and the PAR indicates both restraint availability and restraint usage. In most states these code(s) are collapsed and while they may be used for coding of restraint availability, they are too vague to actually indicate restraint usage. The team should consult their Zone Center for proper coding of restraint usage with the PAR as the sole source of data. A field response column is provided on the form for the investigator to indicate the assessment of restraint usage on the PAR.

The margin indicator, which references the Vehicle Form, should be filled in with the response from the Vehicle Form to aid in the actual crosscheck prior to coding the investigator's final opinion.

Variable Name: Automatic (Passive) Restraint System Availability

Format: 1 column - numeric

Beginning
Column 38

Element Values:

- 0 Not equipped
- 1 Airbag
- 2 Airbag - disconnected
- 3 Airbag - not reinstalled
- 4 2 point automatic belts
- 5 3 point automatic belts
- 6 Automatic belts destroyed
- 9 Unknown

Source: Investigator determined--inputs include vehicle inspection, interviewee, and police report (if listed).

Remarks:

Code "0" (Not equipped) if the vehicle did not have any automatic restraints.

Code "1" (Airbag) if the vehicle was equipped with an airbag. [Note: Deployment of the airbag is considered in variable O26, Automatic (Passive) Restraint Function.]

Code "2" (Airbag disconnected) refers to a situation where components of the system are rendered inoperative prior to the collision (e.g., fuse removed.)

Code "3" (Airbag not reinstalled) refers to a situation where the bag is not repositioned, the gas cannister is not charged, etc., following a deployment previous to the present accident.

Code "4" (2 point automatic belts) or "5" (3 point automatic belts) depending on how the vehicle was equipped. (Note: The 3 point system became available with certain 1980 model vehicles.)

Add-on passive restraints are available for pre-1972 model year vehicles. However, if a vehicle is not inspected and no interview is obtained, code "9" (Unknown) for occupants of post-1971 passenger cars, and code "0" (Not equipped) for occupants of all other vehicles.

The margin indicator, which references the Vehicle Form, should be filled in with the response from the Vehicle Form to aid in the actual crosscheck prior to coding the investigator's final opinion.

Variable Name: Automatic (Passive) Restraint Function

Format: 1 column - numeric

Beginning
Column 39

Element Values:

- 0 Not equipped
- 1 Automatic belt in use
- 2 Automatic belt not in use
- 3 Deployed airbag
- 4 Nondeployed airbag
- 9 Unknown

Source: Investigator determined--inputs include vehicle inspection, interviewee, and police report (if listed).

Remarks:

Code "2" (Automatic belt not in use) if the shoulder belt is disconnected or placed behind the person's back.

Code "3" (Deployed airbag) or "4" (Non-deployed airbag) solely on whether or not the airbag deployed. No consideration is to be made regarding whether or not it should have deployed. This determination will be made by your Zone Center or NCSA. (Note: An airbag is not designed to deploy in every collision.)

If the vehicle was not inspected and no interview was obtained, code "9" (Unknown) for occupants of post-1971 passenger cars, and code "0" (Not equipped) for occupants of all other vehicles.

The margin indicator, which references the Vehicle Form, should be filled in with the response from the Vehicle Form to aid in the actual crosscheck prior to coding the investigator's final opinion.

Variable Name: Relation of Interviewee to Occupant

Format: 1 column - numeric

Beginning
Column 40

Element Values:

- 0 No interview
- 1 Same person
- 2 Other accident involved person (specify)
Uninvolved Person
- 3 Relative or friend
- 4 Other uninvolved person (specify)
Combination of Persons
- 5 One of which was accident involved
- 6 None of which were accident involved
- 9 Unknown

Source: Element chosen

Remarks:

There is a presumption that the interviewee(s), other than the occupant under consideration (i.e., surrogate codes "2"- "6"), will have sufficient familiarity with the occupant to answer most questions relative to this person's demographic characteristics, treatment-mortality, hospitalization, working days lost, and extent of injuries. Conversely, individuals whose association with this person is limited to and a result of the accident, are presumed to have an insufficient basis for answering the preceding questions.

It should be noted that acceptable Occupant Form surrogates may not be acceptable for all portions of the Driver Form; refer to the introduction section of this manual for proper surrogates for the Occupant and Driver data forms.

Official Injury Data
Specific Medical Record Data Used in Coding OIC/AIS

The official injury data page contains the four body diagrams previously seen on page 3 (Injury Data from Interviewee). The same guidelines should be used to document the nature and the locations of all injuries, but medical records will be used as the only source of information. At times, the medical records will also aid in the determination of source of injuries (e.g., glass in wound) and should be documented on this page as stated in the description of source of injury for page 3.

On the official injury data page the injuries should be clearly and precisely located on the diagrams and the medical record classification of the injury and its extent should be completely annotated. All data used to code the OIC/AIS of injuries [e.g., size of lacerations, level of consciousness on first observation by a medical authority, length of unconsciousness, loss of consciousness, size of hematoma or hemothorax (in cc of blood), etc.], should be written with the diagram or, if the description is too long, written on the additional medical record data used in coding OIC/AIS (reverse of page 5).

NASS Injury Coding Conventions

1. If an AIS is determined to be one of two consecutive numbers, but a clear indication cannot be made after reviewing all the information provided, assign the lower AIS. Uncertainty Rule #1—code lower
2. When there is uncertainty about the location of minor multiple abrasions, contusions and lacerations to the body surface, they should be aggregated, regardless of their location(s), and the code OW__-1 should be used. Uncertainty Rule #2—whole body
3. If the medical or interview information indicates a contused knee, elbow, wrist, ankle, etc., and does not specifically state whether the contusion is to the bone or joint, code the injury as integumentary, __CI-1. If the contusion is known to be to the bone, use __CS-; if to the joint, use __CJ-. Example: contused knee, K.CI-1. Uncertainty Rule #3—most superficial system if unknown system/organ
4. Cervical spine strain may, in some cases, still be referred to as "whiplash". "Whiplash" is not a medical term and is not used in AIS-80. If an injury is described as "whiplash", it should be coded as cervical spine acute strain, no fracture or dislocation, NPTM-1. "Whiplash" NPTM-1
5. All internal structures of the mouth, with the exception of the teeth, are coded as part of the digestive system (D). Teeth are coded as skeletal (S). Mouth - teeth = D
6. Body region code 0 (whole body) should be used only if 50% or more of the whole body surface (0) is affected. An exception is made for burns affecting more than one body region (see below). Aspect code W (whole region) is used only if 50% or more of the body region is affected. 50% rule
7. If a lesion involves more than one aspect of a body region:
 - a. Try to determine if one of the aspects is predominant. If so, code that aspect.
 - b. If not, use the aspect code W (whole).Aspect Whole (W) Code
8. Burn injuries should be coded using the following guidelines: Burn injuries and the rule of nines
 - a. If only one body region is burned, use that body region code (e.g., ARBI-1, burned right upper arm 1°).
 - b. If more than one body region is burned, but a single injury code will adequately describe the regions affected, use the single injury code (e.g., XRBI-2, burned right whole arm 2°).
 - c. If more than one body region is burned and one injury code cannot be used to specify the body regions involved, the injury is coded OWRI-_. This will be the most likely case in coding burns.
 - d. The Rule of Nines is used in the AIS severity level for (a), (b), and (c) above. See the Rule of Nines diagram.

9. The following definitions have been used traditionally to differentiate "sprain" and "strain" injuries:

Strain versus
sprain

sprain - a joint injury which causes pain and disability depending on the degree of injury to ligaments and muscle tendons near the joint.

strain - an injury to a muscle or musculotendinous unit that results from overstretching and may be associated with a sprain or fracture.

In common medical practice, however, physicians often do not adhere strictly to these definitions, and may use the terms interchangeably. AIS-80 distinguishes sprains from strains. Care should be exercised in selection of the proper code, use __ SJ for sprains and __ TM-1 for strains.

Neck injuries may sometimes be described as "strains" and sometimes as "sprains". For NASS purposes, neck injuries should be coded as "strains" (see above definitions).

No sprains to neck

10. Intequimentary lesions to the forehead are coded "face superior", or FS __ - __ in the NASS Injury Coding Manual. Fractures to the frontal bone are coded Head Anterior (HAFS-__).

Coding the fore-
head

11. Coding of substantiated anatomic lesions to the brain:

Anatomic Brain
Lesions

- a. If there are no substantiated anatomic lesions to the brain, the OIC and AIS will be coded as they appear in the Non-Anatomic Injuries section (see HEAD, Part C, Non-Anatomic Injuries).
- b. If only one substantiated anatomic lesion to the brain and the length of unconsciousness are known, the OIC will consist of the four letters describing the injury as it is specified in the "Anatomic Injuries" section (see HEAD, Part B, Anatomic Injuries). The AIS assigned will be determined by comparing: (1) the AIS which accompanies the specified injury in the "Anatomic Injuries" section, with (2) the AIS of the comparable injury in the "Non-Anatomic Injuries" section. The higher of the two AIS scores will be the one coded.
- c. If there are two or more substantiated anatomic lesions to the brain, the OIC and the AIS will be coded as they appear in the "Anatomic Injuries" section.

12. "Friction Burns" are to be coded as abrasions. The same criteria for assigning AIS applies (see definitions of abrasion - major and superficial, in the Glossary). If there is information as to the degree (e.g., 1°, 2° or 3°) code: AIS = 1 for 1°, 2° or unspecified, AIS = 2 for 3°.

Friction Burns

13. When an injury is described as a "_____ type of laceration" (e.g., avulsion tpe laceration, flap laceration) use the "L" (laceration) lesion code. For all ambiguous situation use "laceration" over puncture, perforation, or avulsion.

Laceration Type
Injuries

14. A single compression fracture of the spine involving > 1 vertebra and overlapping adjacent regions of the spine is to be coded as one injury (i.e., one line of code). Choose the more superior of the two regions for the aspect code. Compression Fractures
15. For axilla (armpit) injuries code the Body Region for whatever can be determined to be nearest; A (arm), C (chest) or if in between S (shoulder). If unknown or unspecified use A (arm). Axilla Injuries
16. When "closed head injury," "head trauma," or other ambiguous phrase is the only information available, code HUU-7. Closed Head Injury
17. The AIS codes individual injuries only. Injuries to body parts which are present on both sides of the body (bilateral) are coded as two separate injuries. It should be remembered that within the OIC "Aspect" measures the location of the injury being reported. Therefore, bilateral is not used to code the occurrence of hemo- or pneumothorax (results) present bilaterally. Instead, an upgraded AIS will account for the presence of bilateral results. Bilateral Limited
18. The distinction in coding individual skull fractures versus subsuming them under the crush classification lies in the displacement of brain tissue. If it can be determined that brain matter is forcibly extracted or moved from the cranium in conjunction with extensive fracturing, then the term "crushed skull" is applicable. Lack of specificity regarding the displacement of brain tissue tells the coder not to use the crush code and to code the fracturing as individual injuries. An HUU-7 may be added if brain injuries are present but not specifically described. Crushed Skull
19. In the absence of other medical information, code broken neck as cervical spine, fracture, unspecified (NPPS-2), if all neck injuries are believed to be AIS 2 or 3. Otherwise code NPPS-7 (e.g., fatal with only listed injury being broken neck. Broken Neck

NASS Injury Coding Procedures

1. The first four rules below are given in the NASS field forms on how to select injuries for coding and are included here for the convenience of the coder.
 - a. If there are six or less injuries listed in the O.I.C. reduction section, code all of the injuries ordered by Source of Data (1st—autopsy, 2nd—hospital/medical, 3rd—emergency room, 4th—private physician, or 5th—unofficial sources) and by AIS severity within source. Order by source
 - b. If there are more than six injuries, order the injuries by source and by AIS severity within source. Code this ordering, injury-by-injury. If a group of ordered injuries has the same source, the same AIS, and the group includes at least the sixth and seventh injuries in the ordering, then a choice must be made as to which injury or injuries to code. Then by severity within source
 - c. Choose the injury or injuries that will enable the maximum number of different ISS body regions to be represented in the coded data. If no new ISS body region can be added, then simply code in accordance with the rule concerning known injury sources below. Maximize ISS within that source
 - d. If you cannot increase the number of different ISS body regions or if you can choose between two or more injuries of the same source and AIS severity any of which constitute the 3rd ISS region, then choose the injury that has a known injury source. Maximize by contact points
 - e. If the occupant has less than six injuries, then the number of rows required to be completed is equal to the number of injuries plus one (e.g., no injuries requires one row). In the additional row "not injured" will be coded for all variables including AIS severity. If < 6 rows, close out next row with zeros
2. An AIS-6 should be used only for injuries specifically coded AIS-6 in the Abbreviated Injury Scale and not because the victim died. Watch your "6"s
3. Try to associate contact points with individual injuries. List individual injured areas (i.e., body regions) if possible, instead of lumping them together into a code of X, Y, or O. For instance, if there are lacerations to both thigh and shin, code both TLLI-1 and LLLI-1 instead of YLLI-1. Individualize injuries;
4. The coder should take care not to code the same injury twice simply because information concerning it is available from two different sources. For example, if the interview is used in gathering data, only the injuries not already coded based upon medical records should be coded. Don't double count
5. Pain, asphyxia, and hemorrhage represent results of injuries and are not injuries, per se; therefore, they are not coded. The AIS-80 revision is designed to code the injury itself (e.g., MIUW-3, retroperitoneum injury involving hemorrhage). Pain, asphyxia and hemorrhage not valid
6. In NASS, "not injured" is defined as AIS=0. Code "0" for all OIC variables, including AIS severity, for cases in which there are no injuries, or as the last injury listing for occupants sustaining less than six injuries. Closeout or no injury = 0

7. Definitions and procedures for the NASS for coding Injury Source for direct, induced, and noncontact injuries are:

Injury Sources

direct injury - an injury to a particular body region caused by the traumatic contact of that body region with a vehicle component or other object. The vehicle component or other object is coded as the injury source for that injury.

indirect or induced injury - an injury to a particular body region caused by a blow or a traumatic contact in some other body region (e.g., knee/acetabulum). The injury source for an induced injury would be the vehicle component contacted by the other body region (i.e., the occupant contact that initiates the injury mechanism).

Injury source is, therefore, defined as the vehicle component or object that initiated the injury mechanism (induced injury) or directly caused the injury (direct injury).

The noncontact injury source code ("90") is to be used only for the following specific types of injuries:

Non-contact Injury Sources

- (1) twisting or stretching of muscles in the arm, leg, back, etc. with no associated contact identifiable (most often these injuries will be minor muscle strain injuries);
- (2) head or neck injuries in which the torso is supported (e.g., by seat back or belt) and head or neck experiences traumatic forces due to inertial motion;
- (3) burns and flying glass injuries.

The following examples should be helpful in illustrating the above definitions.

Injury	Injury Mechanism Determined from Crash Evidence	Injury Source
Example 1		
Neck dislocation NPDV-3	a. head strikes windshield	a. (01) windshield
	b. forehead hits roof or convertible top	b. (34) roof or convertible top
	c. head strikes steering assembly	c. (03) steering assembly
	d. back hits seatback, no head restraint, head rolls back over seat	d. (90) noncontact injury source
	e. neck forced into lateral flexion by impact forces	e. (90) noncontact injury source
	f. torso restrained by belt, head and neck inertia causes neck injury	f. (90) noncontact injury source
	g. back hits seat back, head hits head restraint, neck is injured	g. (23) head restraint

Injury	Injury Mechanism Determined from Crash Evidence	Injury Source
Example 2		
Hip Dislocation P.DJ-3	Knee strikes dash, forces transmitted along femur forcing femoral head out of the acetabulum	(05) instrument panel
Example 3		
Shoulder elbow- wrist fracture/ dislocation _ZJ-2	Occupant braced hands on instrument panel, transmitting forces to wrist, elbow, and shoulder	(05) instrument panel
Example 4		
Acute lumbar strain BITM-1	Jackknife over seat belt, rotation about seat belt stretches back muscles	(22) belt restraint
Example 5		
Muscle strain in arms, back, chest, neck	Strain of muscles from twisting due to impact forces	(90) noncontact injury source

8. When no other injury information is available, data from the PAR is to be coded. If specific injuries are detailed, code accordingly. If only a PAR injury severity rating is assigned, code: "injured, severity unknown". This implies the existence of an unspecified injury of unknown severity. Do not code: "unknown if injured". This denotes lack of knowledge concerning the existence of injury, which is contrary to information documented in the PAR. Consider the five example situations below and code according to the instructions given, for example, in variable O28 et al. (1st O.I.C. - Body Region).

- a. No interview; no medical; PAR injury severity rating: "K", "A", "B", or "C"; code: "injured, severity unknown"—9UUU79709.
- b. No interview; no medical; PAR injury severity rating: "U"; code: "unknown if injured"—9999999999.
- c. No interview; no medical; PAR injury severity rating: "O"; code: "not injured"—0000000000.
- d. No interview; no medical; PAR injury severity rating: "C", in addition "laceration to forehead" is reported; code: 6FSLI1 __ 09.
- e. No interview; no medical; no PAR mention of injury; hit & run vehicle/driver reported; code: "unknown if injured"—9999999999.

9. If the PAR is "blank" where the injury severity is accessed and the person was at the scene during the police investigation, code no injury. However, if the person was not present during the police inspection, code unknown if injured.

Coding PAR injury data

Presumption of "no injury" or "unknown if injured" from PAR

10. NASS does not code possible injuries, but injuries whose existence is considered to be probable are coded. If the words "possible" or "probable" are used, code accordingly (i.e., code the probable injuries only). If it is difficult to determine if an injury is probable or possible (i.e., use of other indistinct language such as "suspected," "appears" to be," etc), judge whether "possible" or "probably" based on the specific situation.

Code "Probable"
Injuries

OCCUPANT FORM

028
035
042
049
056
063

Variable Name: 1st O.I.C. - Body Region
2nd O.I.C. - Body Region
3rd O.I.C. - Body Region
4th O.I.C. - Body Region
5th O.I.C. - Body Region
6th O.I.C. - Body Region

Format: 1 column - alphanumeric

Beginning
Column 41
50
59
68
77
86

Element Values:

M Abdomen	L Leg (lower)
Q Ankle - foot	Y Lower limb(s) (whole or unknown part)
A Arm (upper)	N Neck - cervical spine
B Back - thoracolumbar spine	P Pelvic - hip
C Chest	S Shoulder
E Elbow	T Thigh
F Face	X Upper limb(s) (whole or unknown part)
R Forearm	O Whole body
H Head - skull	W Wrist - hand
U Injured, unknown region	Ø Not injured
K Knee	9 Unknown if injured

Source: Variables 034, 041, 048, 055, 062, and 069 respectively.

Remarks:

The NASS Injury Coding Manual 1983 contains a listing of most injuries. Use the manual to code, for each injury, both its O.I.C. and I.S.S. body region and record them on the form. Ordering instructions are on page 7 of the Occupant Form.

OCCUPANT FORM

028
035
042
049
056
063
(2)

Variable Name: 1st O.I.C. - Body Region (cont'd.)
2nd O.I.C. - Body Region (cont'd.)
3rd O.I.C. - Body Region (cont'd.)
4th O.I.C. - Body Region (cont'd.)
5th O.I.C. - Body Region (cont'd.)
6th O.I.C. - Body Region (cont'd.)

For coding the following situations, the correct procedure is:

	R	A	L	S	A	I	S	S	O	
	E	S	E	Y	.	N	O	O	F	
	G	P	S	S	I	J	U	U	D	
	I	E	I	T	.	U	R	R	A	
	O	C	O	E	S	R	C	C	T	
	N	T	N	M	.	Y	E	E	A	
Not injured:	$\frac{0}{41}$	$\frac{0}{42}$	$\frac{0}{43}$	$\frac{0}{44}$	$\frac{0}{45}$	$\frac{0}{46}$	$\frac{0}{47}$	$\frac{0}{48}$	$\frac{0}{49}$	
Injured, severity unknown:	$\frac{U}{41}$	$\frac{U}{42}$	$\frac{U}{43}$	$\frac{U}{44}$	$\frac{7}{45}$	$\frac{9}{46}$	$\frac{7}{47}$	$\frac{0 \text{ or } 9}{48}$	$\frac{1,2,3,4,5,6,7,8 \text{ or } 9}{49}$	
	$\frac{0}{50}$	$\frac{0}{51}$	$\frac{0}{52}$	$\frac{0}{53}$	$\frac{0}{54}$	$\frac{0}{55}$	$\frac{0}{56}$	$\frac{0}{57}$	$\frac{0}{58}$	
Unknown if injured:	$\frac{9}{41}$	$\frac{9}{42}$	$\frac{9}{43}$	$\frac{9}{44}$	$\frac{9}{45}$	$\frac{9}{46}$	$\frac{9}{47}$	$\frac{9}{38}$	$\frac{9}{49}$	
	$\frac{0}{50}$	$\frac{0}{51}$	$\frac{0}{52}$	$\frac{0}{53}$	$\frac{0}{54}$	$\frac{0}{55}$	$\frac{0}{56}$	$\frac{0}{57}$	$\frac{0}{58}$	

Note: Be sure to complete one additional row with zeros ("0") when the person is injured but has less than six injuries. This is true even when the person is injured but the severity is unknown, or if it is unknown whether or not the person is injured. Refer to the last O.I.C. note on page 7 of the Occupant Form.

When the person has several injuries from the same Source of Data, one of which is "injured, severity unknown," code this injury last.

OCCUPANT FORM

029
036
043
050
057
064

Variable Name: 1st O.I.C. - Aspect of Injury
2nd O.I.C. - Aspect of Injury
3rd O.I.C. - Aspect of Injury
4th O.I.C. - Aspect of Injury
5th O.I.C. - Aspect of Injury
6th O.I.C. - Aspect of Injury

Format: 1 column - alphanumeric

Beginning
Column 42
51
60
69
78
87

Element Values:

A Anterior - front	P Posterior - back
C Central	R Right
I Inferior - lower	S Superior - upper
U Injured, unknown aspect	W Whole region
L Left	Ø Not injured
	9 Unknown if injured

Source: Variables 034, 041, 048, 055, 062, and 069 respectively.

Remarks:

The NASS Injury Coding Manual 1983 contains a listing of most injuries. Use the manual to code, for each injury, the aspect of the injury and record it on the form.

NOTE: Bilateral (B) was deleted from Aspect of Injury beginning with the 1983 CSS.

OCCUPANT FORM

030
037
044
051
058
065

Variable Name: 1st O.I.C. - Lesion
2nd O.I.C. - Lesion
3rd O.I.C. - Lesion
4th O.I.C. - Lesion
5th O.I.C. - Lesion
6th O.I.C. - Lesion

Format: 1 column - alphanumeric

Beginning
Column 43
52
61
70
79
88

Element Values:

A Abrasion	U Injured, unknown lesion
M Amputation	I Laceration
V Avulsion	O Other
B Burn	P Perforation, puncture
K Concussion	R Rupture
C Contusion	S Sprain
N Crush	T Strain
G Detachment, separation	E Total severance, transection
D Dislocation	Ø Not injured
F Fracture	9 Unknown if injured
Z Fracture and dislocation	

Source: Variables 034, 041, 048, 055, 062, and 069 respectively.

Remarks:

The NASS Injury Coding Manual 1983 contains a listing of most injuries. Use the manual to code, for each injury, its lesion and record it on the form.

OCCUPANT FORM

031
038
045
052
059
066

Variable Name: 1st O.I.C. - System/Organ
2nd O.I.C. - System/Organ
3rd O.I.C. - System/Organ
4th O.I.C. - System/Organ
5th O.I.C. - System/Organ
6th O.I.C. - System/Organ

Format: 1 column - alphanumeric

Beginning
Column 44
53
62
71
80
89

Element Values:

W All systems in region	M Muscles
A Arteries - veins	N Nervous system
B Brain	P Pulmonary - lungs
D Digestive	R Respiratory
E Ears	S Skeletal
O Eye	C Spinal cord
H Heart	Q Spleen
U Injured, unknown system	T Thyroid, other endocrine gland
I Integumentary	G Urogenital
J Joints	V Vertebrae
K Kidneys	Ø Not injured
L Liver	9 Unknown if injured

Source: Variables 034, 041, 048, 055, 062, and 069 respectively.

Remarks:

The NASS Injury Coding Manual 1983 contains a listing of most injuries. Use the manual to code, for each injury, its system/organ and record it on the form.

OCCUPANT FORM

032
039
046
053
060
067

Variable Name: 1st O.I.C. - Abbreviated Injury Scale
2nd O.I.C. - Abbreviated Injury Scale
3rd O.I.C. - Abbreviated Injury Scale
4th O.I.C. - Abbreviated Injury Scale
5th O.I.C. - Abbreviated Injury Scale
6th O.I.C. - Abbreviated Injury Scale

Format: 1 column - alphanumeric

Beginning
Column 45
54
63
72
81
90

Element Values:

0 Not injured
1 Minor injury
2 Moderate injury
3 Severe injury
4 Serious injury
5 Critical injury
6 Maximum (untreatable)
7 Injured, unknown severity
9 Unknown if injured

Source: Variables 034, 041, 048, 055, 062, and 069 respectively.

Remarks:

The NASS Injury Coding Manual 1983 contains a listing of most injuries. Use the manual to code, for each injury, its A.I.S. value and record it on the form.

OCCUPANT FORM

033
040
047
054
061
068

Variable Name: 1st O.I.C. - Injury Source
2nd O.I.C. - Injury Source
3rd O.I.C. - Injury Source
4th O.I.C. - Injury Source
5th O.I.C. - Injury Source
6th O.I.C. - Injury Source

Format: 2 columns- numeric

Beginning
Column 46
55
64
73
82
91

Element Values:

00 Not injured

Front

- 01 Windshield
- 02 Mirror
- 03 Steering assembly, including transmission selector lever when column mounted
- 04 Add-on equipment (e.g., CB, tape deck, air conditioner)
- 05 Instrument panel and below, excluding foot controls and parking brake
- 06 Sunvisor
- *09 Other front object

Side

- 11 Side interior surface, excluding hardware or armrests
- 12 Side hardware or armrests
- 13 A pillar
- 14 B pillar
- *15 Other pillar
- 16 Window glass or frame
- *19 Other side object

Interior

- 21 Seat, back support
- 22 Belt restraint system
- 23 Head restraint
- 24 Air cushion
- 25 Other occupants
- 26 Interior loose objects
- *29 Other interior objects

OCCUPANT FORM

033
040
047
054
061
068
(2)

Variable Name: 1st O.I.C. - Injury Source (cont'd.)
2nd O.I.C. - Injury Source (cont'd.)
3rd O.I.C. - Injury Source (cont'd.)
4th O.I.C. - Injury Source (cont'd.)
5th O.I.C. - Injury Source (cont'd.)
6th O.I.C. - Injury Source (cont'd.)

Roof

31 Front header
32 Rear header
33 Roof side rails
34 Roof or convertible top

Floor

41 Floor
42 Floor or console mounted transmission lever, including console
43 Parking brake handle
44 Foot controls including parking brake

Rear

45 Backlight (rear window)
46 Backlight storage rack, door, etc.
*49 Other rear objects

Exterior of Occupant's Vehicle

51 Hood
52 Outside hardware (e.g., outside mirror, antenna)
*53 Other exterior surface or tires
59 Unknown exterior objects

Cycle

61 Handle bars or attachments
62 Frame or suspension component or fender
63 Seat
64 Foot pedal, foot rest, foot pegs
65 Wheel or tire
66 Engine or transmission
67 Gas tank, gas tank filling cap or neck
*69 Other cycle part

Exterior of Striking Motor Vehicle

71 Bumper
72 Hood edge
*73 Other front of vehicle
74 Hood

OCCUPANT FORM

033
040
047
054
061
068
(3)

Variable Name: 1st O.I.C. - Injury Source (cont'd.)
2nd O.I.C. - Injury Source (cont'd.)
3rd O.I.C. - Injury Source (cont'd.)
4th O.I.C. - Injury Source (cont'd.)
5th O.I.C. - Injury Source (cont'd.)
6th O.I.C. - Injury Source (cont'd.)

75 Hood ornament
76 Windshield, roof rail, A-pillar
77 Side surface
78 Side mirrors
*79 Other side protrusions
80 Rear surface
81 Undercarriage
82 Tires and wheels
*83 Other exterior of striking motor vehicle
84 Unknown exterior of striking motor vehicle

Other Vehicle or Object in the Environment

86 Ground
*87 Other vehicle or object
89 Unknown vehicle or object

Noncontact Injury

90 Noncontact injury source (e.g., impact force, heat or flame from fire, battery acid, etc.)
97 Injured, unknown source
99 Unknown if injured

Source: Investigator determined--inputs include vehicle inspection and interviewee.

Remarks:

Interior flying glass refers to the person being struck by glass which has already fractured and is airborne. This is coded as "90" (Noncontact injury source). This does not refer to a person causing glass to shatter upon impacting it.

Investigator should record only those contact mechanisms which can be documented by some physical evidence (e.g., scuffs, hair, smudges, dents,

OCCUPANT FORM

O33
O40
O47
O54
O61
O68
(4)

Variable Name: 1st O.I.C. - Injury Source (cont'd.)
2nd O.I.C. - Injury Source (cont'd.)
3rd O.I.C. - Injury Source (cont'd.)
4th O.I.C. - Injury Source (cont'd.)
5th O.I.C. - Injury Source (cont'd.)
6th O.I.C. - Injury Source (cont'd.)

cracks. etc.). Use page 3 of the Occupant Form and page 7 of the Vehicle Form to record the injury source evidence.

The element values encoded can be based on physical evidence, occupant kinematics, and interviewee information. Although physical evidence is preferred, it does not have to be present to support a contact mechanism.

If a parked (not in transport) vehicle is impacted by an occupant of a vehicle in transport, use the "87" (other vehicle or object) code.

*NOTE: Whenever an "other" code (i.e., "09", "15", "19", "29", "49", "53", "69", "73", "79", "83", or "87") is coded as injury source, clearly identify, in the space provided at the top of page 8 of the form, each description by value and injury number.

OCCUPANT FORM

034
041
048
055
062
069

Variable Name: 1st O.I.C. - Source of Data
2nd O.I.C. - Source of Data
3rd O.I.C. - Source of Data
4th O.I.C. - Source of Data
5th O.I.C. - Source of Data
6th O.I.C. - Source of Data

Format: 2 columns - numeric

Beginning
Column 48
57
66
75
84
93

Element Values:

Official	Unofficial
01 Autopsy records with or without hospital/medical records	05 Lay coroner report
02 Hospital/medical records other than emergency room (e.g., discharge summary)	06 E.M.S. personnel
03 Emergency room records only (including associated x-rays or other lab reports)	07 Interviewee
04 Private physician - walk-in or emergency clinic	08 Other source (specify)
	09 Police
	99 Unknown if injured
	00 Not injured

Source: Element chosen

Remarks:

Code "01" (Autopsy records with or without hospital/medical records) excludes records from lay, nonmedical personnel; they must be the result of an autopsy by a physician or other similarly qualified life scientist. A non-invasive external exam by a physician though, should be coded "02" (Hospital medical records other than emergency room) or "04" (Private physician) since it is generally a superficial listing of external injuries and possible internal injuries; therefore, injuries from this source should not be grouped with those from a thorough autopsy report.

Code "02" [Hospital/medical records other than emergency room (e.g., discharge summary)] is used whenever the injury is listed on the official post-emergency room records of a hospital or medical facility. If the injury was also listed on a facility's associated emergency room records, then this

OCCUPANT FORM

034
041
048
055
062
069
(2)

Variable Name: 1st O.I.C. - Source of Data (cont'd.)
2nd O.I.C. - Source of Data (cont'd.)
3rd O.I.C. - Source of Data (cont'd.)
4th O.I.C. - Source of Data (cont'd.)
5th O.I.C. - Source of Data (cont'd.)
6th O.I.C. - Source of Data (cont'd.)

code takes precedence. If the injury is also contained in an autopsy record--where the autopsy was performed by a physician or similarly qualified life scientist--then, code "01" (Autopsy records with or without hospital/medical records) takes precedence. However, this code includes non-invasive (external) examinations conducted by a physician on a deceased victim and documented as a hospital or medical examiner's record.

Code "03" [Emergency room records only (including associated x-rays or other lab reports)] is used when the injury only appears on a facility's emergency room record or on records that were completed in support of the person's examination in an emergency room. For example, an x-ray report that was completed because the emergency room physician requested it as a part of his/her examination would be included under this code. This code should not be used if the injury is subsequently listed on a post-emergency room record or in a medical autopsy.

If both types of records (emergency room and post-emergency room) refer to the same injury, code "02" [Hospital/medical records other than emergency room (e.g., discharge summary)] is used as the code even if the detail provided on the emergency room records exceeds the detail provided on the post-emergency room records.

Code "04" (Private physician, walk-in or emergency clinic) refers to any physician (in private practice) who saw the injured person and who has records of that treatment (i.e., other than hospital or autopsy records). Also included in this code are non-invasive (external) examinations conducted by a private physician or similarly qualified life scientist on a deceased victim and documented as other than a hospital record (e.g., coroner's report).

In summary, examinations of deceased persons are distinguished first by qualifications of examiner [official (codes "01", "02", and "04) versus unofficial (code "05")], second by the type of examination [autopsy (code "01") versus non-invasive (codes "02" or "04")], and third by type of examination record [hospital (code "02") versus other than hospital (code "04")].

OCCUPANT FORM

034
041
048
055
062
069
(3)

Variable Name: 1st O.I.C. - Source of Data (cont'd.)
2nd O.I.C. - Source of Data (cont'd.)
3rd O.I.C. - Source of Data (cont'd.)
4th O.I.C. - Source of Data (cont'd.)
5th O.I.C. - Source of Data (cont'd.)
6th O.I.C. - Source of Data (cont'd.)

Code "05" (Lay coroner report) is used if the injury data is contained in a report where a non-invasive examination of the deceased was performed by a non-physician, or lay coroner.

Code "06" (E.M.S. personnel) refers to a person certified by the state as trained in emergency medical service techniques. Code "06" should not be used for ambulance attendants, police, or other personnel not trained in E.M.S. techniques.

Code "07" (Interviewee) refers to the person who was interviewed to get the information on this form (not necessarily the person described on this form). The interviewee is defined in variable 027.

Code "08" (Other) is used when data are obtained from an unofficial source different from those explicitly listed above (e.g., chiropractors).

Code "09" (Police) can be used, but only when no other source of injury information is available. See last sentence of first paragraph on page 6, Occupant Form.

Code "00" (Not injured) is to be used when no injury was reported. In other words, this variable reports only the source of the injury information.

Variable Name: Injury Severity (Police Rating)

Format: 1 column - numeric

Beginning
Column 95

Element Values:

- 0 No injury (O)
- 1 Possible injury (C)
- 2 Nonincapacitating injury (B)
- 3 Incapacitating injury (A)
- 4 Killed (K)
- 5 Injury, severity unknown
- 6 Died prior to accident
- 9 Unknown

Source: Police report

Remarks:

Code the police reported injury severity for this occupant. It is possible that the police could have updated the PAR between the time it was stratified (A02, Case Number--Stratification) and when it was picked up. For example, a person might have been listed originally with incapacitating injuries ("3"). Later the person dies ("4"), and the PAR is changed accordingly. Therefore, use the latest information on the PAR at the time it was obtained from the police agency.

If the police report contains a detailed description of the injuries but does not translate the injuries into the KABCO codes, use the police method for doing so. For example, injuries which are considered to be of an incapacitating nature are classified as "A" (code "3"), nonincapacitating-evident injuries are "B" (code "2"), and possible injuries are "C" (code "1"). Property damage only is classified as "O" (code "0").

Code "5" (Injury, severity unknown) if the police report indicates a "U" or in any other way communicates the idea that the person was injured but their severity is unknown.

Code "6" (Died prior to accident) should only be coded if the police explicitly so indicate.

As a general rule, if the PAR is "blank" where the injury severity is accessed and the person was at the scene during the police investigation, code "0" (No injury). If the PAR is "blank" and the person was not present during the police investigation, code "9" (Unknown).

OCCUPANT FORM

070
(2)

Variable Name: Injury Severity (Police Rating) (cont'd.)

Not all states use the KABCOU scheme. Listed below, by state, are alternative schemes; a mapping to the NASS scheme is provided.

State	PAR Code/Definition	NASS Scheme/Code
Alabama	K = Killed	K - 4
	A = Visible or carried from scene	A - 3
	B = Bruise/abrasion/swelling	B - 2
	C = No visibility - has pain/faint	C - 1
	Blank = No documentation of driver or occupant injury = No set unknown code	Blank - 0 - 9
Arizona	1 = No injury	O - 0
	2 = Possible injury	C - 1
	3 = Nonincapacitating injury	B - 2
	4 = Incapacitating injury	A - 3
	5 = Fatal	K - 4
	6 = Unknown	J - 5
California	1 = Fatal	K - 4
	2 = Severe wound/distorted member	A - 3
	3 = Other visible injury	B - 2
	4 = Complaint of pain	C - 1
	blank = Occupant present blank = Occupant not present	O - 0 - 9
Colorado*	5 = Fatal	K - 4
	4 = Evident - incapacitating	A - 3
	3 = Evident - nonincapacitating	B - 2
	2 = Possible injury	C - 1
	1 = No injury	O - 0
Florida	1 = No injury	O - 0
	2 = Fatal "in 90 days" injury	K - 4
	3 = Incapacitating injury	A - 3
	4 = Nonincapacitating injury	B - 2
	5 = Possible injury	C - 1
	6 = Non-traffic fatality = No set unknown code	K - 4 - 9

*There is a box at the top of the PAR indicating number of persons injured. If this box is marked 0 and the injury code is left "blank", assume "No injury". If the box is marked 1 (or more) pertaining to the vehicle occupants in question and the injury code is "blank", assume "Injured, severity unknown". If "blanks" are present in both the persons injured box and the injury code box, assume "Unknown".

OCCUPANT FORM

070
(3)

Variable Name: Injury Severity (Police Rating) (cont'd.)

State	PAR Code/Definition			NASS Scheme/Code	
Indiana	Nature of Most Severe Injury	Location of Most Severe Injury	Victim's Injury Status		
	1-11 Any Entry	1-12 Any Entry	6 Dead	K - 4	
	1-11 Any Entry	1-12 Any Entry	2 Semiconscious 3 Incoherent 4 Unconscious	A - 3	
	1 Severed 2 Internal 4 Severe Burn 7 Severe Bleed (Arterial) 8 Fracture/dislocation	1-12 Any Entry	1 Conscious 5 Shock 7 Refused Med	A - 3	
	3 Minor Burn 6 Minor Bleed 10 Complaint of Pain 11 None Visible	3 Eye	1 Conscious 5 Shock 7 Refused Med	A - 3	
	3 Minor Burn 6 Minor Bleed	1-2, 4-12 (Any EXCEPT Eye)	1 Conscious 5 Shock 7 Refused Med	B - 2	
	5 Abrasion 9 Contusion/Bruise	1-12 Any Entry	1 Conscious 5 Shock 7 Refused Med	B - 2	
	10 Complaint of Pain 11 None Visible	1-2, 4-12 (Any EXCEPT Eye)	1 Conscious 5 Shock 7 Refused Med	C - 1	
	11 None Visible	Blank or Slashed	1 Conscious	O - 0	
	Blank or Slashed	Blank or Slashed	Blank or Slashed	O - 0	
	Unknown	Unknown	Unknown	U - 9	
	Iowa	1 = Fatal			K - 4
		2 = Major (incapacitating)			A - 3
		3 = Minor (bruises and abrasions)			B - 2
		4 = Possible (complaint of pain)			C - 1
Ø = Unknown				U - 9	
Blank = No documentation of driver or occupants on back of PAR				O - 0	
Louisiana	1 = Fatal			K - 4	
	2 = Severe			A - 3	
	3 = Noticeable			B - 2	
	4 = Complaint of pain or momentary unconsciousness			C - 1	
	5 = None			O = 0	

Variable Name: Injury Severity (Police Rating) (cont'd.)

<u>State</u>	<u>PAR Code/Definition</u>	<u>NASS Scheme/Code</u>
Maryland	5 = Fatal	K - 4
	4 = Incapacitating	A - 3
	3 = Nonincapacitating	B - 2
	2 = Possible injury	C - 1
	1 = No injury/Damage only	D = 0
	Blank = No documentation of driver or occupants on front of PAR	
Massachusetts	K = Killed	K - 4
	A = Visible signs of injury, as bleeding wound or distorted member; or had to be carried from scene	A - 3
	B = Other visible injury, as bruises, abrasions, swelling, limping, etc.	B - 2
	C = No visible injury but complaint of pain or momentary unconsciousness	C - 1
	Blank = No documentation of driver or occupants on front of PAR	O - 0
	= No set unknown code	- 9
Missouri	A = Fatal	K - 4
	B = Disabling	A - 3
	C = Evident (Not Disabling)	B - 2
	D = Probable - Not Apparent	C - 1
	E = None Apparent	O - 0
	F = Unknown	U - 9
Nebraska	4 = Fatal	K - 4
	3 = Incapacitating injury	A - 3
	2 = Nonincapacitating injury	B - 2
	1 = Possible injury	C - 1
	0 = No injury	O - 0
	blank = Occupant present	O - 0
blank = Occupant not present	- 9	

Variable Name: Injury Severity (Police Rating) (cont'd.)

New Jersey	Location of Injury	Type of Injury	Victim's Condition	
	Any entry	Any entry	Killed	K - 4
	Any entry	Any entry	Incapacitated	A - 3
	Any entry	amputation, concussion, internal, fracture/dislocation	Moderate injury Complaint of pain	A - 3
	Eye	burn, bleeding, complaint of pain	Moderate injury Complaint of pain	A - 3
	Any entry	bleeding, contusion, bruise, abrasion	Moderate injury	B - 2
	Any entry (except eye)	complaint of pain	Complaint of pain	C - 1
	-	-	-	O - 0
	U	U	U	- 9

State	PAR Code/Definition			NASS Scheme/Code
New York	Location of Injury	Type of Complaint	Victim's Status	
	Any entry	Any entry	Apparent death	K - 4
	Any entry	Any entry	Unconscious, Semi-conscious, Incoherent	A - 3
	Any entry	amputation, concussion, internal, severe bleeding, severe burn, moderate burn, fracture - dislocation	Shock, Normal	A - 3
	Eye	minor bleeding, minor burn, complaint of pain	Shock, Normal	A - 3
	All but eye	minor bleeding, minor burn	Shock, Normal	B - 2
	Any entry	contusions-bruise, abrasion	Shock, Normal	B - 2
	All but eye	complaint of pain	Shock, Normal	C - 1
	-	-	-	O - 0
	X	X	X	- 9

Variable Name: Injury Severity (Police Rating) (cont'd.)

<u>State</u>	<u>PAR Code/Definition</u>	<u>Scheme/Code</u>
Pennsylvania	0 = No injury	C - 0
	1 = Death	F - 4
	2 = Major injury	A - 3
	3 = Moderate injury	E - 2
	4 = Minor injury [and] Type of Apparent Injury	
	- amputation	
	- bleeding	
	- broken bone(s)	E - 2
	- burns	
	- concussion	
- abrasions/bruises		
- other		
4 = Minor injury [and] Type of Apparent Injury		
- shock	C - 1	
- dizziness		
- complaint of pain		
Rhode Island	1 = Fatal injury at scene	F - 4
	2 = Visible signs of injury - bleeding or broken bones	A - 3
	3 = Other visible injury - bruises or abrasions	E - 2
	4 = No visible injury, but complaints of pain	C - 1
	Blank = No injury	C - 0
Tennessee	4 = Dead at time of report	F - 4
	3 = Bleeding wound, distorted member	A - 3
	2 = Bruises, abrasions, swelling, limping, etc.	E - 2
	1 = Complaint of pain, no visible injury	C - 1
	Blank = No documentation of driver or occupants on front of PAR or on supplement	C - 0

Variable Name: Injury Severity (Police Rating) (cont'd.)

<u>State</u>	<u>PAR Code/Definition</u>	<u>Scheme/Code</u>
Washington	1 = No injury	O - 0
	2 = Dead at scene	K - 4
	3 = Dead on arrival	K - 4
	4 = Died in hospital	K - 4
	5 = Disabling injury	A - 3
	6 = Nondisabling injury	B - 2
	7 = Possible injury	C - 1
	blank = Unknown	- 9

Variable Name: Time of Death

Format: 2 columns - numeric

Beginning
Column 96

Element Values:

Level 1 Range: 00 through 24, 31 through 60, 96, 99
00 Not fatal
96 Fatal - ruled disease
99 Unknown

Source: Police report, hospital/medical records, autopsy report, or other official records for actual time of death for fatally injured occupants.

Remarks:

Code "00" should identify (from any source) all occupants who are not fatally injured (i.e., death does not occur, or death does not occur within thirty days of the accident).

All occupants who die within thirty days of the accident should have their time-of-death recorded unless their death meets the criteria of the fatal - ruled disease code "96".

Code "96" (Fatal - ruled disease) is used in two situations. The first is when the effects of a disease can be deemed as a cause of the accident. Cause means that the onset of the disease occurred prior to the first harmful event. When determining the time of on-set (relative to the first harmful event), the investigator can use any information source available. The investigator makes his/her determination after weighing all the evidence. (NOTE: The use of all available information sources is restricted to the determination of when the on-set occurred.) Additionally, code "96" (Fatal - ruled disease) is used when a medical examiner (or other official vested by the state to verify the cause of death) or an official medical report verifies that the death resulted from either (1) a diseased condition, or (2) not from accident related injuries.

Code "01" should identify occupants who die within (less than) one and a half hours of the time of the accident.

Codes "02" through "24" should identify occupants who die in the period of time between one and a half hours from the time of the accident to twenty-four hours after the accident. The variable should be coded to the nearest hour except for code "24" which is used only for the period between twenty-three and a half hours after the accident and twenty-four hours after the accident.

OCCUPANT FORM

071

(2)

Variable Name: Time of Death (con't.)

Code "31" through "60" should identify occupants who die in the period of time between greater than twenty-four hours after the accident (24 hours and one minute is coded as "31" while 24 hours is coded as "24") and thirty days after the accident. (NOTE: One day = "31", two days "32", ..., twenty-nine days = "59", and thirty days = "60".) The number of days should be rounded off to the nearest whole day except for code "60" which is used for the period between twenty-nine days and twelve hours and thirty days after the accident.

The exact time period which applies to each code is shown in the table below.

Variable Name: Time of Death (cont'd.)

Code	Time period in hours
01	0 - < 1 1/2
02	1 1/2 - < 2 1/2
03	2 1/2 - < 3 1/2
04	3 1/2 - < 4 1/2
05	4 1/2 - < 5 1/2
06	5 1/2 - < 6 1/2
07	6 1/2 - < 7 1/2
08	7 1/2 - < 8 1/2
09	8 1/2 - < 9 1/2
10	9 1/2 - < 10 1/2
11	10 1/2 - < 11 1/2
12	11 1/2 - < 12 1/2
13	12 1/2 - < 13 1/2
14	13 1/2 - < 14 1/2
15	14 1/2 - < 15 1/2
16	15 1/2 - < 16 1/2
17	16 1/2 - < 17 1/2
18	17 1/2 - < 18 1/2
19	18 1/2 - < 19 1/2
20	19 1/2 - < 20 1/2
21	20 1/2 - < 21 1/2
22	21 1/2 - < 22 1/2
23	22 1/2 - < 23 1/2
24	23 1/2 - 24

Code	Time period in days
31	> 1 - < 1 1/2
32	1 1/2 - < 2 1/2
33	2 1/2 - < 3 1/2
34	3 1/2 - < 4 1/2
35	4 1/2 - < 5 1/2
36	5 1/2 - < 6 1/2
37	6 1/2 - < 7 1/2
38	7 1/2 - < 8 1/2
39	8 1/2 - < 9 1/2
40	9 1/2 - < 10 1/2
41	10 1/2 - < 11 1/2
42	11 1/2 - < 12 1/2
43	12 1/2 - < 13 1/2
44	13 1/2 - < 14 1/2
45	14 1/2 - < 15 1/2
46	15 1/2 - < 16 1/2
47	16 1/2 - < 17 1/2
48	17 1/2 - < 18 1/2
49	18 1/2 - < 19 1/2
50	19 1/2 - < 20 1/2
51	20 1/2 - < 21 1/2
52	21 1/2 - < 22 1/2
53	22 1/2 - < 23 1/2
54	23 1/2 - < 24 1/2
55	24 1/2 - < 25 1/2
56	25 1/2 - < 26 1/2
57	26 1/2 - < 27 1/2
58	27 1/2 - < 28 1/2
59	28 1/2 - < 29 1/2
60	29 1/2 - 30

UNIFORM SYMBOLS FOR ACCIDENT DIAGRAMMING

Vehicle and Pedestrian Symbols

	<p>Automobile (pre-impact or at-impact position) Exception: draw <u>solid</u> outline if stopped at-impact.</p>
	<p>Automobile (final rest position—showing damaged area)</p>
	<p>Automobile (final position on its top)</p>
	<p>Automobile (final position on its right side) (reverse for left side)</p>
	<p>Automobile involved in the accident as as a temporary environmental factor, but not physically involved in the collision. (Non-Contact Unit)</p>
	<p>Parked automobile not struck (give it a number if it was struck)</p>
	<p>Vehicle in which a witness was an occupant</p>
	<p>Truck (Panel, Van, Dump, etc.)</p>
	<p>Truck tractor and semi-trailer</p>
	<p>Utility trailer</p>
	<p>Bus or streetcar</p>
	<p>Motorcyclist; bicyclist (handlebars are curved opposite the direction of travel)</p>

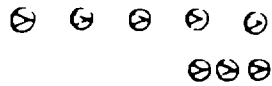

Pedestrian (pointer oriented to show direction of movement and dot spacing to show rate of movement; i.e., 3' apart walking and 6' apart running



Final position of body



Pedestrian who witnessed accident

All symbols referring to colliding vehicles (plus Non-Contact, Witness and Parked vehicles) are to have a broken outline if they are moving at the point in which they are depicted; the outline should be solid if the vehicle is stopped where depicted, or at final rest. Be careful to insure proper placement (location) and orientation on the diagram.

SCENE ROAD MARKINGS



Point of impact



Skidmarks

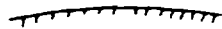

Centripetal curve scuffs



Tire scuff marks

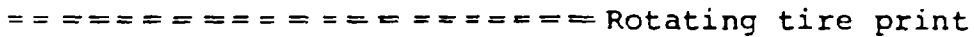

Rotating tire print



Gouges



Scratches















Liquids (puddle and run-off)



Debris (funnel out away from point of impact to show direction of force)

Any other accident-induced markings, components from vehicles, etc should be shown in their approximate location and a reasonable likeness sketched on the diagram. However, do not clutter diagram; make an additional diagram, if necessary.

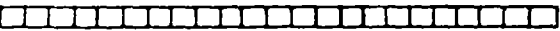
Topographical Highway & Environment Symbols

	Pavement edge
	Shoulder edge line (non-formal)
	Shoulder edge line (formal)
	Broken center or lane lines (15' long - 25' apart)
	Broken center line with No-Passing line
	Double yellow center lines
	Raised island and Grass median
	Painted median
	Curb
	Paved shoulders with diagonal lines
	Turn arrows
	Wall
	Bridge abutment and railing
	Guard rail

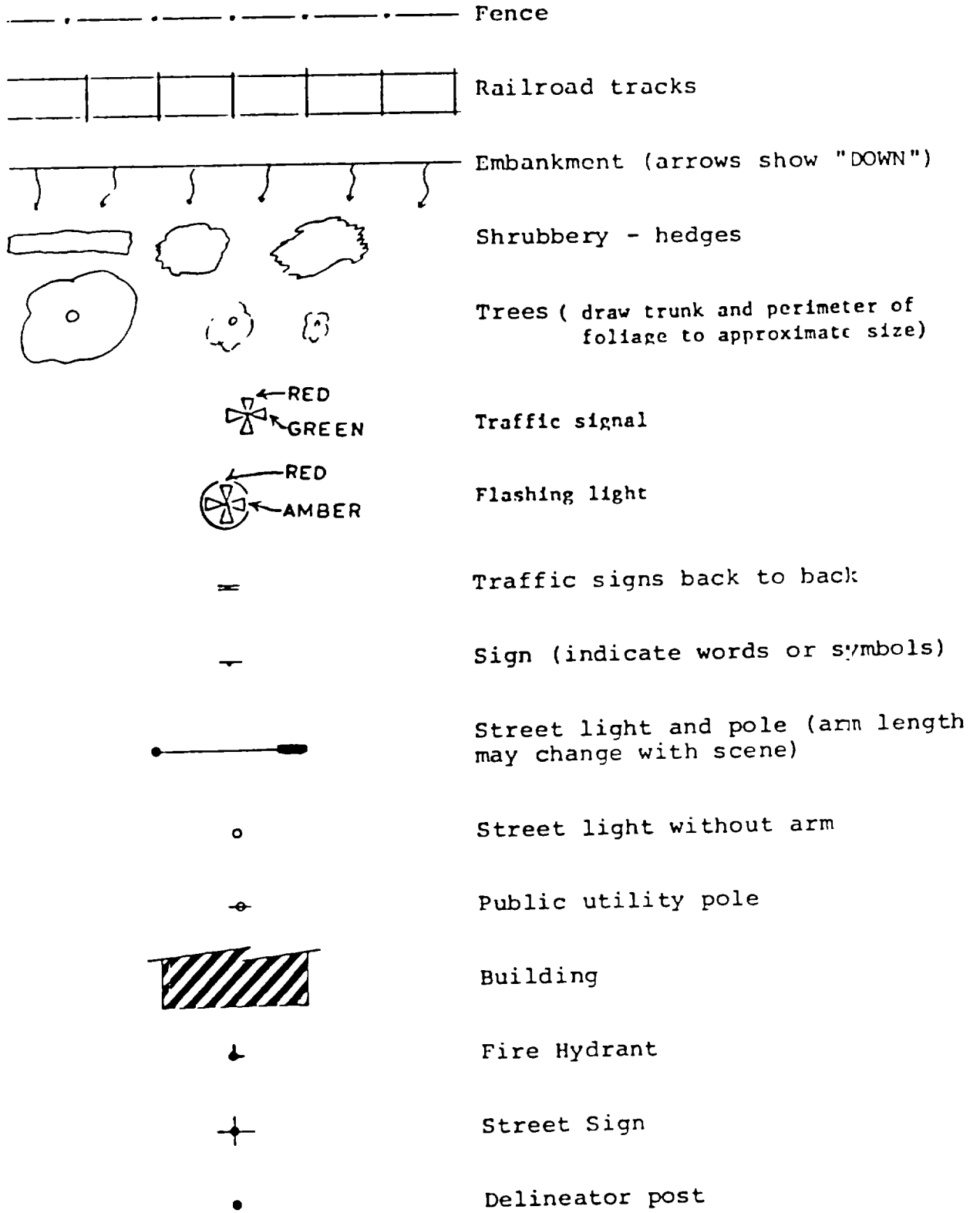

All crosswalks, road surface symbols and other relevant markings should be depicted and drawn to approximate scale on the diagram as much as possible.

PHOTOGRAPHY

Case photographs are an important part of each NASS report for several reasons: (1) they document details which are often difficult to describe, (2) they permit subsequent interpretation of factors which are not otherwise recorded, and (3) they are essential in the quality control program to ensure that all teams interpret and record information uniformly, and (4) they provide a verification of encoded data.

Equipment

Preferred equipment for this type of program is a 35 mm camera with a wide angle lens (35mm) and an electronic flash unit. The use of a film such as Kodak Ektachrome-X, ASA 64 is recommended. Processing is simple and the ASA 64 film works well for the type of photography typically performed by accident investigators. In discussing investigation photography, it should be noted that a common error involves the failure to use the flash unit. Even in daylight, under overcast conditions or where background lighting is a problem, the flash should be used for vehicle exterior photography. The flash should be used for all interior photographs.

Relative size of objects in slides is sometimes difficult to determine. To alleviate this problem, a scale should be used in all close-up view photographs. The scale should have alternating solid (dark colored) and blank (white) coloring at one-inch increments, and each foot should be clearly noted by a visible target and foot number given (see Figure 1). A four foot long scale is suggested. The scale should be placed immediately adjacent to the principal item of interest in a given photograph in such a way as to avoid hiding significant features of interest of the object struck. Align the scale so as to minimize distortion of the scale in the resulting photograph (that is: if camera is aimed near horizontal, place the scale in a vertical position; if

All close-up photographs
must include this scale.



4"

Figure 1

the camera is essentially looking down on top of a structure, place the scale horizontally.

Photographic Coverage

Photographs in this study are taken for the specific purpose of documenting the condition of the vehicle interior and exterior (with emphasis on vehicle damage and occupant contact points) and the accident scene and scene evidence. The coverage indicated in the sketches in this section represents the minimum number of photographs required. At least 9 exterior and 5 interior photographs should be taken for each vehicle. Four scene photographs are also required as a minimum. However, in most cases, it will be clear that additional photographs will be needed to document the damage and occupant contacts properly. The cost of a roll of film is far less than that of the data lost if a sufficient number of photographs is not taken. The slides contained within a case should be considered as photographic verification of all coded and noncoded data.

Vehicle

Photographs should be taken from a crouched position at a level slightly above the vehicle belt line. General camera placement for typical accident types is illustrated on the following page. In end impacts, one photograph should be taken directly in front of the damaged end A, one directly along each side of the vehicle B to illustrate any body distortion, and one at 45 degrees to each corner to show the damaged end and sides C.

A sixth and seventh photograph D should be taken at right angle to the end damage photographs. These photographs should provide right angle views along the foremost part of the car. Photograph E is a centered side view of the entire car, and F is a three-quarter view of the two undamaged sides of the vehicle. Tak additional shots as needed.

VEHICLE: FRONT AND REAR IMPACT

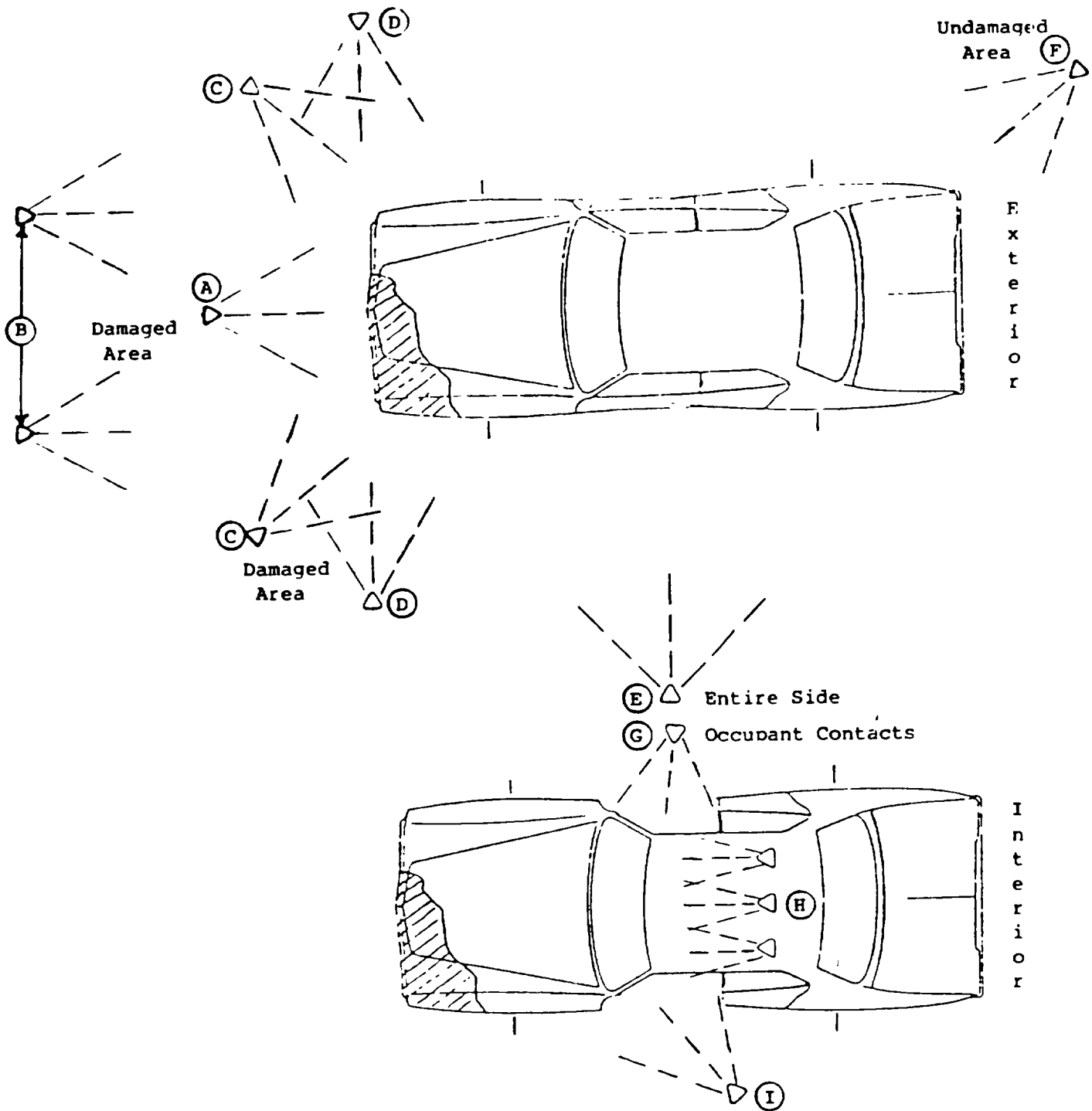

NOTE: If an impact involves underride or override, photograph damage at the appropriate height to properly document the extent. If additional photographs are needed to provide adequate coverage in certain cases, they should be taken.

Interior photographs should include one from the right front door G (or left front, if necessary or appropriate and three from the rear seat H to show occupant contacts. The latter should be taken of the left, center, and right front interior, as illustrated. These views should overlap somewhat and include the area from the header to the lower instrument panel (for a normal size vehicle you will need to turn the camera 90 degrees). An additional photograph I is needed to document driver contacts. This should be taken in a crouched position through the open door and should include the lower instrument panel. Close-ups of all other possible interior contact areas are also required.

In side impacts a side photograph of the damaged area only A, a centered side view of the entire vehicle B, and two angled photographs to show depth of penetration C --one taken from forward and the other taken from the rear of the damaged area, are needed. Two photographs should be taken from either front or rear (as best illustrates distortion or bowing of the vehicle) along the body line D . A final three-quarter view should be taken of the undamaged side of the vehicle E (from the rear if the D photographs are from the front, and from the front if D photographs are taken from the rear).

Two photographs should be taken of the front and rear interior from the side of the vehicle which was not damaged F . These photographs are to show intrusion (or lack thereof) as well as occupant contacts. Take two photographs from the rear seat into both A-pillar and door areas G to show occupant contacts. Be sure that photographs document all possible areas of intrusion and occupant contacts (including rear-seated occupants)/and restraint system availability and usage.

Scene

In general, a photograph should be taken along the path of each vehicle from perhaps ten feet behind the first tire markings (if present) at point of

VEHICLE: SIDE IMPACT

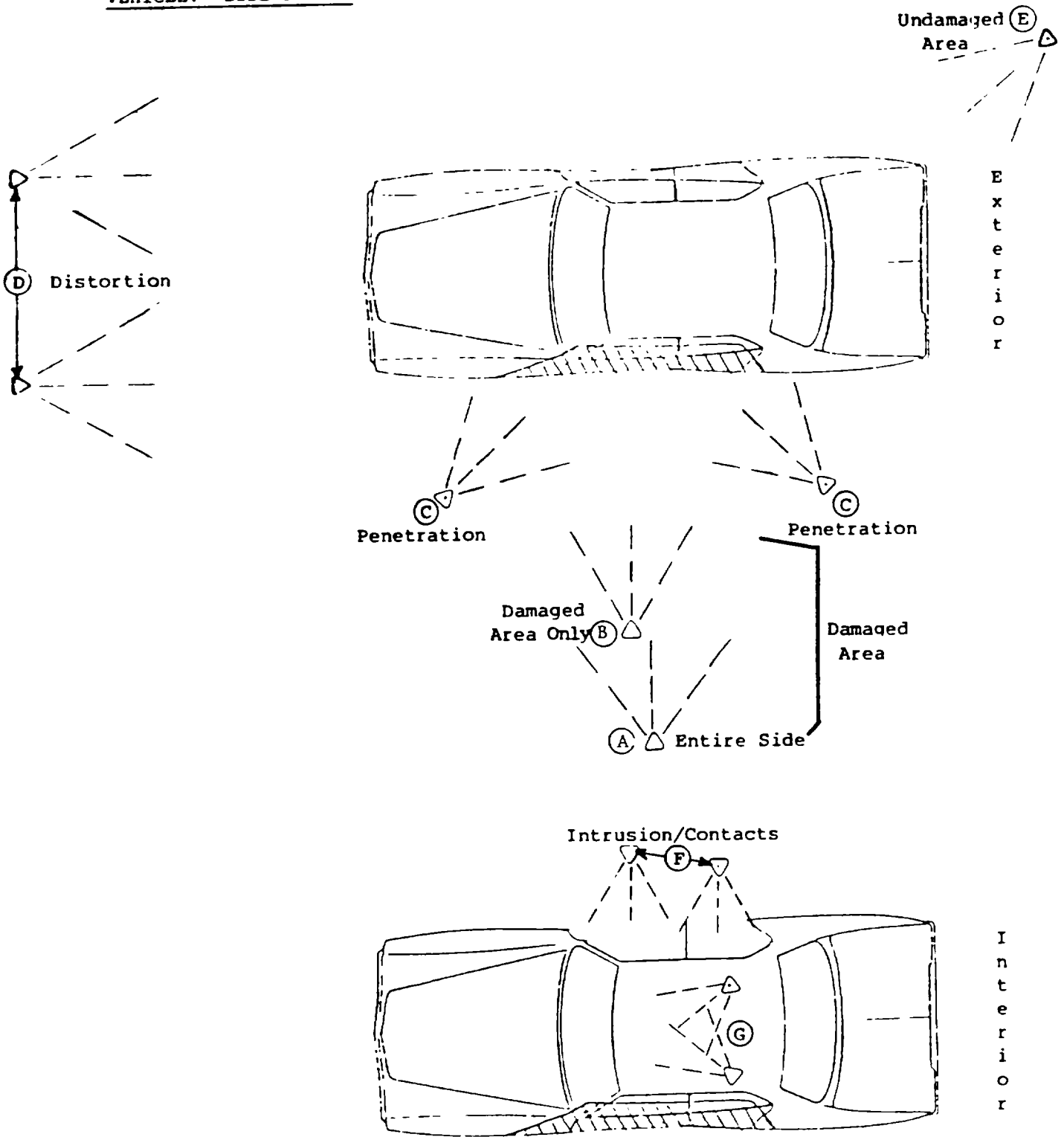

NOTE: If an impact involves underride or override, photograph damage at the appropriate height to properly document the extent. If additional photographs are needed to provide adequate coverage in certain cases, they should be taken.

unstabilized event or first harmful event - which ever occurs first. All photographs should be taken at increments of twenty-five feet. the point of impact and vehicle rest positions should also be shown. Uniform symbols for scene marking, made with yellow lumber crayons or paint, should highlight the available physical evidence. The uniform symbols simplify the communication between the investigator and reviewer regarding interpretation of photographically depicted scene evidence.

Roadway delineation, signs, and markings may have played a role in the accident. In order to provide information on these aspects of the event, photographic documentation of the approach roadway upstream from the accident location is required. Photographs of the road and adjacent terrain beginning at approximately 1000 ft. upstream and approximately 200 ft. intervals should document this need. In general, one photograph looking in the direction of the road at each location should suffice. Be sure that lane lines, edge lines, highway signs and signals are visible in the photographs.

Roadside

In collisions in which a case vehicle ran-off-the road, additional photographs of the roadside are required to provide information on the role of the roadside in the event. Photographs of the road and adjacent terrains as requested above will be helpful in this regard. In addition, photographs at approximately 50-100 foot intervals along the likely path of the vehicle(s) after the vehicles(s) left the road will be useful.

For impacts involving a roadside fixed-object, more extensive photographic coverage is required to adequately document the event. It is possible that additional data may be desired at a later date on certain data items and photographs become the only available source of information. In general, the following photographs will be required in fixed-object collisions in addition

to 1) the vehicle and scene photographs requested for all CSS cases and (2) the mentioned vehicle path photographs for all roadside collisions:

1. For each impact, two photographs should be taken showing general views of the accident site in the direction of vehicle travel. These photographs should be taken at different distances (e.g., 50-100 feet apart) from the point of impact.
2. For each impact, two photographs should be taken showing general views of the accident site opposite the direction of vehicle travel. These photographs should be taken at different distances from the point of final rest or separation from the struck object.
3. One or more photographs should be taken along the path of the vehicle travel between impacts so as to provide a complete coverage of the accident sequence from the point of departure from the roadway to the point of final rest.
4. For each roadside structure/object struck, at least two photographs should be taken. One photograph should show a general view of the roadside structure/object contacted while the second photograph should be a close-up view which includes the scale in Figure 1 to illustrate the damage sustained by the roadside structure/object.

Usually, the damages sustained by the roadside structure/object cannot reasonably be described in one close-up photograph, thus several close-up photographs of damage and vehicle marks will be required. For example, the following photographs should be taken for guardrail, median barrier and bridge rail collisions:

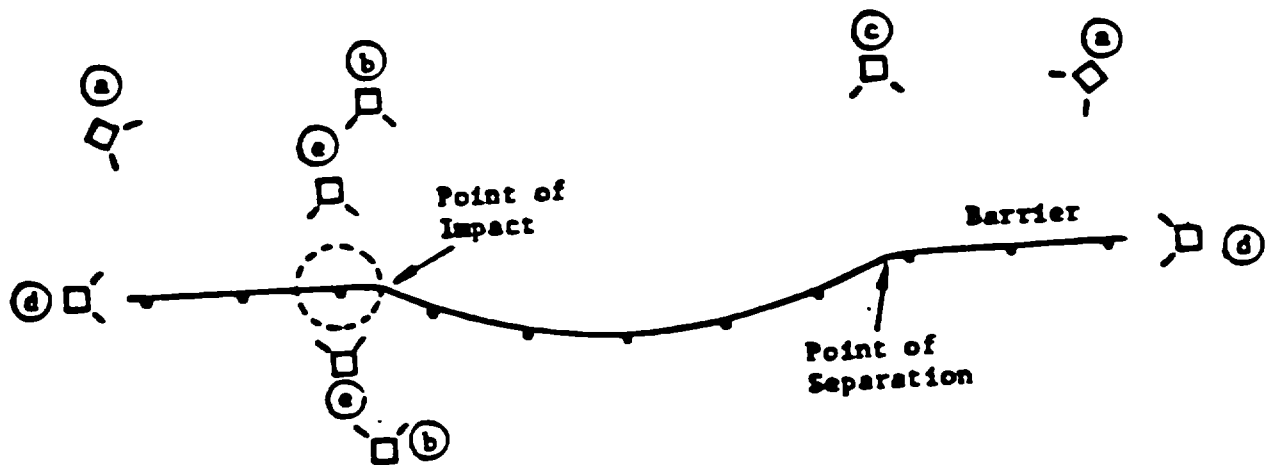

If the distance between the point of impact and the point of separation is greater than twenty-five (25) feet, additional frontal photographs should be taken.