



NATIONAL ACCIDENT SAMPLING SYSTEM
1991 CRASHWORTHINESS DATA SYSTEM
DATA COLLECTION, CODING, AND EDITING MANUAL

U.S. DEPARTMENT OF TRANSPORTATION
NATIONAL HIGHWAY TRAFFIC SAFETY ADMINISTRATION
NATIONAL CENTER FOR STATISTICS AND ANALYSIS
WASHINGTON, D.C. 20590

January 1991

ACKNOWLEDGEMENT

NASS CDS DATA COLLECTION, CODING, AND EDITING MANUAL

The first edition (Pilot Study-1978) of this manual was originally developed by Indiana University under a contract sponsored by the National Highway Traffic Safety Administration. The work was performed under the direction of staff at the National Center for Statistics and Analysis (NCSA).

The second and third editions (1979 and 1980 calendar year versions) of this manual were developed by Indiana University and Calspan Corporation in consultation with NASS staff at the NCSA. Final illustrations, editing, and production of camera ready copies were performed at Indiana University.

The fourth through eleventh editions (the 1981-1988 calendar year versions) were collaborated productions by the NASS Zone Centers: Transportation Research Center at Indiana University, Calspan Corporation, Southwest Research Institute, and Dynamic Science, Inc. The twelfth edition (the 1989 calendar year version) was also a collaborative effort of the NASS Zone Centers: Transportation Research Center at Indiana University and Franklin Research Division of ARVIN/CALSPAN. The work was performed under the direction of NASS staff at the NCSA. Final illustrations, editing, and production of camera ready copies were performed at the Transportation Research Center.

The 13th edition of this manual (the 1990 calendar year version) was produced by staff at the National Center for Statistics and Analysis. A collaborated and comprehensive review was performed by the NASS Zone Centers: Transportation Research Center at Indiana University and Franklin Research Division of ARVIN/CALSPAN.

The current edition (the 1991 calendar year version) is a collaborated effort of the NASS Zone Centers: Transportation Research Center at Indiana University and Franklin Research Division of ARVIN/CALSPAN, and; staff at the NCSA. The work was performed under the direction of NASS staff at the NCSA. Final illustrations, editing, and production of camera ready copies were performed at the National Center for Statistics and Analysis.

The production of this and previous editions of the NASS CDS Data Collection, Coding, and Editing Manual could not have been made possible without contributions from many unidentified sources within the U.S. Department of Transportation, the NASS Zone Centers and PSU teams, and the transportation community.

TABLE OF CONTENTS

	Page

1.0 INTRODUCTION	1
1.1 Purpose of the Manual	1
1.2 Overview	1
1.3 How to Use This Manual	2
2.0 DESCRIPTION OF THE SAMPLING FRAME	5
2.1 Accidents Which Qualify for NASS	5
Figure 2-1--Incident to NASS Accident Flowchart	6
Figure 2-2--Rural Trafficway	10
Figure 2-3--Urban Trafficway	11
Figure 2-4--Divided Trafficway	12
Figure 2-5--Parking Lot Situations	14
Figure 2-6--ANSI Flowchart & Definitions	17
Figure 2-7--NASS Accident Overview	26
2.1.1 Questions and Answers About Which Incidents Qualify for NASS	28
2.2 NASS PAR Sampling	30
2.2.1 Sampling Variables	30
2.2.2 Sampling Strata	32
Table 2-1--1991 NASS CDS Strata	33
Table 2-2--1991 NASS GES Strata	33
Figure 2-8--NASS Stratification	37
2.2.3 Questions and Answers Regarding Stratification Figure 2-9--Parking and In-Transport Situations	38 40
3.0 OVERVIEW OF SAMPLING ACTIVITIES	43
3.1 Listing and Sampling Forms	43
3.1.1 Contact Day Assignment Sheet (CDAS)	43
3.1.2 PAR Stratification Record (SR)	43
3.2 Listing and Sampling Instructions	43
3.2.1 Contacting Police Jurisdictions	43
Table 3-1--Contact Day Assignment Sheet	44
Table 3-2--PAR Stratification Record	45
3.2.2 Completing the PAR Stratification Record	46
3.2.3 The NASS CDS Automated Case Selection System (ACSS)	50
3.2.4 Special Instructions for Automated Sampling Procedures	50
Table 3-3--NASS CDS Automated Case Selection System Report (ACSSR)	51
3.3 CDS Sampling Problems: How to Handle Them	52
Table 3-4--PAR Disposition Versus Team Research	54
3.4 Beginning of Year Sampling Instructions	55
4.0 OVERVIEW OF COLLECTED INFORMATION ON SAMPLED CDS ACCIDENTS	57
4.1 Required Forms for CDS Cases	57
4.2 Sequencing of Case Materials	57
Table 4-1--Required Forms for NASS CDS Cases	58
Figure 4-1--Sequence of Case Materials	59
4.3 Information Required on Field Forms (File Structuring Variables)	61
4.4 Update Procedures for Hardcopy Field Forms	62
4.5 Potential Safety Problem Bulletin	64
4.6 CDS Criteria for Acceptable Data Completion	64
Figure 4-2--Potential Safety Problem Bulletin	65
Table 4-2--Specific Areas Of Interest To NHTSA Rulemaking	66

TABLE OF CONTENTS (Continued)

	Page

5.0 CDS SUBMISSION INSTRUCTIONS	71
5.1 Quality Control Checks for PSU Teams	71
5.1.1 Quality Control Checks Prior to Microcomputer Data Entry	71
5.1.2 Quality Control Checks Resulting from Microcomputer Data Entry	71
Table 5-1--MDE Checks: Format, Designations, and Tables	72
5.1.3 Check to Make Sure Administrative Procedures Are Being Followed	74
5.1.4 Check Sampling Procedures	74
5.1.5 Check Data Collection Procedures	74
5.1.6 Check to Make Sure Updates Are Being Processed Properly	74
5.1.7 Check Individual Effort and Accuracy in Collecting Evidence and Skill in Interpretation	74
5.2 Case Submission	74
Table 5-2--1991 CDS Case Submissions Schedule	76
Table 5-3--1991 CDS File Closeout Schedule	77
Table 5-4--Administrative Log - A	78
5.3 Case Deletion Procedures	79
6.0 GES QUALITY CONTROL AND SUBMISSION INSTRUCTIONS	83
6.1 Quality Control Checklist for GES Sampling and Mailing	83
6.2 GES Submission Instructions	83
Table 6-1--Quality Control Checklist	84
7.0 CODING INSTRUCTIONS	87

	Page(s)

Case Summary Form (Noncoded Information, NCI)	CS-1 - CS-3
Accident Form (Variables AC01-AC46)	
Accident Collision Measurement Table	
Accident Collision Diagram	
Slide Index	
o AC01-AC11	AC-1 - AC-7
o Accident Events Overview	AC-8 - AC-9
o AC12-AC46	AC-12 - AC-20
General Vehicle Form (Variables GV01-GV55)	
CRASHPC Program Summary	
OLDMISS Program Summary	
o GV03-GV05	GV-1 - GV-4
o GV06	GV-5 - GV-48
o GV07-GV08	GV-49 - GV-60
o GV09-GV12	GV-61 - GV-66
o GV13-GV15	GV-67 - GV-75
o GV16-GV18	GV-76 - GV-78
o GV19-GV20	GV-79 - GV-81
o GV21-GV24	GV-82 - GV-86
o GV25-GV28	GV-87 - GV-91
o Reconstruction Programs Overview	GV-92 - GV-98
o GV29-GV36	GV-99 - GV-107

TABLE OF CONTENTS (Continued)

	Page(s)

General Vehicle Form (Variables GV01-GV55) (Continued)	
o Other Drug Overview	GV-108 - GV-114
o GV37-GV39	GV-115 - GV-119
o GV40-GV55	GV-120 - GV-142
Exterior Vehicle Form (Variables EV01-EV32)	
o Instructions for Completion of CDS Applicable Field Measurements Page	EV-1 - EV-3
o Instructions for Completion of Vehicle Damage Sketch . . .	EV-4 - EV-6
o EV04/EV12, EV05/EV13	EV-7 - EV-21
o CDC Related Remarks	EV-22 - EV-23
o EV06/EV14-EV11/EV19	EV-24 - EV-30
o Crush Profile Overview	EV-31 - EV-32
o End Damage Measurement Protocol	EV-31
o Side Plane Damage Measurement Protocol	EV-32
o EV20-EV28	EV-33 - EV-39
o EV29-EV32	EV-40 - EV-47
Interior Vehicle Form (Variables IV01-IV97)	
o IV04	IV-1 - IV-3
o Door, Tailgate, or Hatch Opening Overview	IV-4
o IV05-IV14	IV-5 - IV-9
o Glazing Damage Overview	IV-10 - IV-11
o IV15-IV46	IV-12 - IV-22
o Occupant Area Intrusion Overview	IV-23 - IV-26
o IV47-IV86	IV-27 - IV-36
o Steering Column Overview	IV-37
o IV87	IV-38
o IV88-IV91 (Blank)	IV-39
o IV92-IV97	IV-40 - IV-48
o Instructions for Completion of Vehicle Interior Sketches And Points of Occupant Contact Pages	IV-49 - IV-51
o Manual Restraints	IV-52
o Child Safety Seat Field Assessment	IV-52
Occupant Assessment Form (Variables OA01-OA48)	
o OA03-OA04	OA-1 - OA-2
o Occupant's Characteristics Overview	OA-3
o OA05-OA11	OA-4 - OA-12
o Ejection/Entrapment Overview	OA-13 - OA-15
o OA12-OA16	OA-16 - OA-21
o Restraint System and Seats Overview	OA-22 - OA-24
o OA17-OA27	OA-25 - OA-45
o Child Restraint Overview	OA-46 - OA-47
o OA28-OA33	OA-48 - OA-59
o Injury/Consequences Overview	OA-60
o OA34-OA48	OA-61 - OA-88
o Table of Vehicles with Automatic Restraint Systems . . .	OA-89 - OA-95
Occupant Injury Form (Variables OI01-OI104)	
o Injury Data Overview	OI-1 - OI-9
o OI05-OI104	OI-10 - OI-24

TABLE OF CONTENTS (Continued)

	Page(s)	

Update Form	UD-1	- UD-8
Interview Form (Noncoded Information, NCI)	IN-1	- IN-7
APPENDICES		
o Uniform Symbols for Scene Marking		AP-1
o Uniform Symbols for Accident Diagramming	AP-2	- AP-5
o Variable Computer Formats	AP-7	- AP-17

1.0 INTRODUCTION

1.1 Purpose of the Manual

In order to produce a national traffic accident data base for the evaluation of old and the development of new highway and vehicle safety standards and to identify highway safety needs, the National Accident Sampling System was created. The system consists of thirty-six teams of accident researchers situated throughout the country. At each site (Primary Sampling Unit - PSU), the accident research team researches a probability sample of police reported accidents involving passenger cars, light trucks, and vans which were towed, according to the police report, from the scene due to damage. This system has been termed the Crashworthiness Data System (CDS).

Zone centers have been established to provide for the quality control of the CDS data collected and the technical management of the teams within their zone. Quality control is carried out through zone center site visits to the PSUs and through the review of accident case report materials received at the zone center. The zone centers provide quality control in the areas of sampling, completeness of data, reliability, and validity of data. In addition, the zone centers provide annual team evaluations, training, extra PSU staff (when needed), and act as a communication link between the PSU teams and the staff of the National Center for Statistics and Analysis.

The purpose of this manual is to provide PSU team members, zone centers, the Transportation Safety Institute (TSI) NASS Training Program Coordinator, and the National Center for Statistics and Analysis with a consistent, standardized set of instructions for sampling accidents and collecting, coding, and editing the data.

1.2 Overview

The manual includes seven substantive sections; each is summarized below.

Section 2.0 Description of the Sampling Frame describes, first, the procedure for determining whether or not the incident reported on a police accident report (PAR) qualifies for inclusion in the NASS, second, the variables used to classify the NASS qualifying sampled PARs, and third, which data collection forms are required to be submitted with a NASS CDS case. The PAR sampling strata for the CDS are defined in terms of the values of the these variables. In addition, the **General Estimates System (GES)** and its relationship to CDS is discussed.

Section 3.0 Overview of Sampling Activities describes the procedures for compiling the sampling frame list and selecting the accidents to be researched for the CDS and obtained for the GES. Detailed instructions for use of the automated system are found in the MDE User's Manual.

Section 4.0 Overview of Information to be Collected on Sampled CDS Accidents describes the forms which are to be filled out on each accident, the different records (e.g., injury records), photographs, and other information (e.g., CRASH runs) which make up a completed case report. Also discussed are the file structuring data items and forms which must be encoded before a case can qualify for submission. In addition, the NASS CDS criteria for acceptable data completion are presented.

Section 5.0 CDS Submission Instructions describes when, where, and how to submit case reports. It also describes the quality control procedures to be used at the PSU sites. In addition, MDE consistency checks and the procedures for deleting a case are discussed.

Section 6.0 GES Quality Control and Submission Instructions presents the quality control checklist and the instructions for submission of GES sampling materials.

Section 7.0 Coding Instructions provides the general instructions for collecting and coding the data called for in the Case Summary Form and the field forms. Documentation for each data element includes variable name, element values (attributes), definitions (where needed), data sources, collection method, reference materials (if needed), and remarks.

The Appendices contain some of the necessary references, including: (1) the Uniform Symbols for Scene Marking, (2) the Uniform Symbols for Accident Diagramming, (3) the Photography Instructions, and (4) the listing of Variable Computer Formats.

Other references to be used in NASS CDS not contained in this manual include: (1) the Fifth Edition of ANSI D16.1-1989; (2) the CRASH3 Technical Manual; (3) SAE J224 MAR80; (4) the 1988 NASS Injury Coding Manual; (5) NATB books (see variable GV08); (6) Passenger Car and Truck Investigators Manual (see variable GV08); (7) the Branham Automobile Reference Book; (8) Diesel and Gasoline Truck Indices; (9) the MVMA - Passenger Car Specifications (see variable GV19); (10) Microcomputer Data Entry User's Manual for the NASS; and (11) the NASS Accident Investigation Procedures Manual.

1.3 How to Use This Manual

This manual is designed to be updated periodically without the need for replacing the entire document. This will be accomplished by adding, deleting, and changing pages. Additions will be inserted in their proper location and will be identified by a different month and year. Pages which are changed will have the same month and year identifier.

When potential data encoding problems are detected in the NASS CDS Data Collection, Coding, and Editing Manual or interpretations of specific circumstances (including NASS CDS definitions) are required, the following procedures, outlined by NCSA, will be followed:

(a) Potential problems that are identified at the team level will be sent to the cognizant zone center via the NASS CDS message system.

(b) The zone center will review the potential problem.

(1) If it is a misinterpretation of the manual, a clarification will be provided by the cognizant zone center via the NASS CDS message system (with a telephone follow-up, if necessary).

(2) If the potential problem is determined to be valid, the cognizant zone center will broadcast the potential problem with a recommended solution to the other two (2) zone centers for review and concurrence. The final recommended solution will be sent to NCSA by the cognizant zone center for review and approval. This includes all additions, deletions, modifications or substantive interpretations that redefine, broaden, or narrow the established definition of NASS CDS variables or attributes.

(c) Changes or interpretations which affect field data encoding and are approved by the NCSA will be given an effective implementation date and included in the NASS CDS Coding Manual.

The above procedures were not established to restrict team or zone center operations but to ensure that program objectives and goals are not inadvertently changed (i.e., a variable is redefined beyond its intended purpose). When defining variables, NCSA must consider their operational use within the restrictions of the data collection time frame and their intended purpose. Any diversions from these established procedures may destroy the data validity and/or result in serious analysis problems.

2.0 DESCRIPTION OF THE SAMPLING FRAME

2.1 Accidents Which Qualify for NASS

The procedures for properly developing the list of motor vehicle accidents within the study area which qualify for research are shown in Figure 2-1 and described below.

Start with a Police Reported Incident--All incidents which meet the criteria of a motor vehicle traffic accident, as defined in ANSI D16.1-1989, Section 2.4.20 (see figure 2-6, page 21), and are (a) reported on the state accident form, or on local accident forms, (b) signed by a police officer, and (c) available through the police agency files, are to be considered for study. Other accident report forms, such as special driver report forms, that do not meet the requirements above are excluded from consideration.

Must Be Reported to the State--For an incident to qualify as a NASS accident, the police jurisdiction must send a copy of the Police Accident Report (PAR) to the state for inclusion in the state accident statistics. If a report will not be included in the state file, then the incident is not to be included in the list. If the researcher cannot determine whether or not an incident will be reported to the state, then he/she should include it in the list.

Must Involve a Harmful Event--If the incident does not involve property damage and/or personal injury, do not include it in the list. The presence of a Police Accident Report (PAR) creates a rebuttable presumption that a harmful event has occurred. It is the duty of the researcher to scrutinize any PAR which alleges the absence of a harmful event.

The Harmful Event Must Have Occurred as a Result of an Accident--An accident involves at least one harmful event (ANSI D16.1-1989, section 2.4.1; see figure 2-6 page 20) produced by an unstabilized situation (ANSI D16.1-1989, section 2.4.4; see figure 2-6 pages 24-25). There are four (4) ways in which a harmful event occurs that are not a result of an accident. They are: (a) the harmful event results from a diseased condition, (b) the unstabilized situation was the result of deliberate intent, (c) the unstabilized situation was the result of legal intervention, or (d) the harmful event results from a cataclysm (ANSI D16.1-1989, section 2.4.5, see figure 2-6, page 18). To clarify the meaning of each of these "intervening circumstances", consider the examples below.

Disease: Even if the unstabilized situation is initiated by a disease such as cerebral hemorrhage, heart attack, diabetic coma, or epileptic seizure, which affects the driver of a motor vehicle in-transport, any subsequent harmful event which occurs is considered an accident. This includes any nonvehicular damage that this vehicle causes. The disease itself is not a harmful event for our classification as a traffic accident.

Deliberate Intent: A harmful event which has been intentionally produced does not fall within the definition of an unstabilized situation and, thus, is not an accident.

A driver kills himself/herself (suicide) or self-inflicts injury by driving a motor vehicle: (1) against a fixed object, (2) into a body of water, or (3) otherwise misuses a motor vehicle in transport, and this intent is

FIGURE 2-1

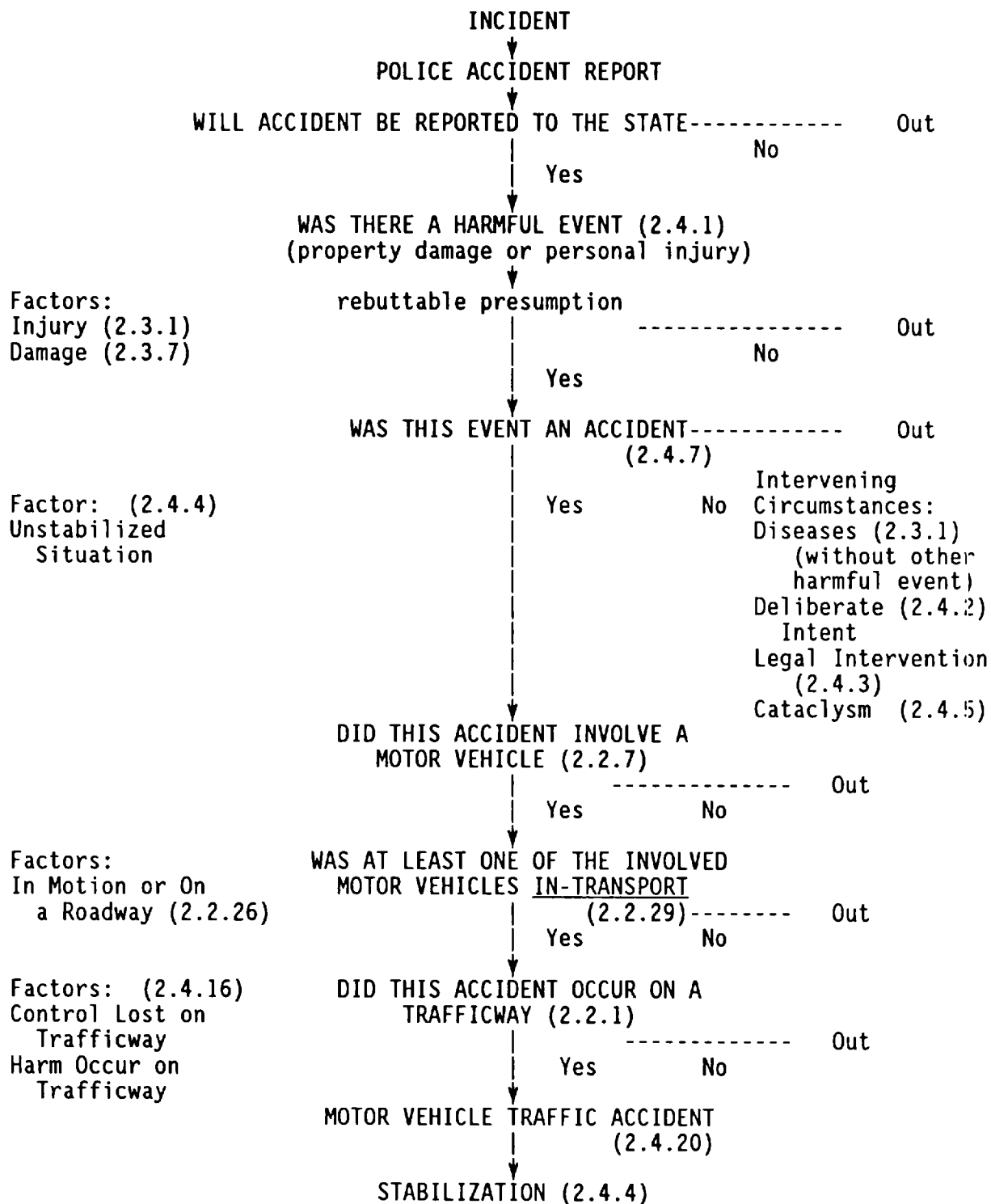

A motor vehicle traffic accident (MVT) originates on a police accident report (PAR) filed with the state. It involves (a) a harmful event not directly resulting from a cataclysm, (b) produced by an unstabilized situation, (c) involving at least one motor vehicle, (d) in-transport [in motion or on a roadway] such that (e) the harmful event occurred on a trafficway or the unstabilized situation originated on a trafficway.

DESCRIPTION OF THE SAMPLING FRAME

verified in some manner: such intentional events are not motor vehicle accidents. If during such intentional acts other injury or damage occurs that goes beyond the original intent, then these events are accidental and meet the specifications of a motor vehicle accident, unless the contrary can be clearly established.

Example 1: A driver who intends to commit suicide by driving head-on into another vehicle is involved in an accident, since any harmful event which results to the other vehicle or occupants goes beyond the original intent of the driver.

A person, having announced intent in some manner, causes death, injury, or damage by driving a motor vehicle against persons, motor or other road vehicles, or other property, with **homicidal, injury, or damage inflicting intent**; such intended acts are not motor vehicle accidents. If, in doing such intended acts, other injury or damage occurs that goes beyond the original intent (i.e., **unintended consequences**), these events are accidental and meet the specifications of a motor vehicle accident, unless the contrary can be clearly established.

Example 2: A driver (not connected with a law enforcement agency) who intentionally rams another vehicle, intending to inflict harm upon the vehicle or its occupants, is not involved in an accident. In Example 1 above, if the driver intended to inflict harm upon the other vehicle or its occupants, as well as inflict harm upon himself/herself, then this also would not be an accident.

However, **malicious mischief**, such as throwing a rock toward a motor vehicle, dropping an object from an overpass, or rolling an object upon a trafficway, is not considered to be deliberate intent unless it is clearly established that the act was directed toward a specified person or motor vehicle. This is defined in ANSI D16.1-1989, section 2.4.2 (see figure 2-6, page 19).

For the purposes of NASS PAR listing (given limited information on a PAR), a first harmful event resulting from deliberate intent should not be classified as a NASS accident, except where a subsequent harm occurs to a different vehicle or person such that the harm was an unintended consequence of the original event.

When in doubt, follow the instructions for listing the accident contained in Section 3.0 of this manual and call your zone center for guidance.

Legal Intervention: Legal intervention is a type of deliberate intent involving intentional acts by a law enforcement agent, officer, or other official. If in doing such intended acts, injury or damage occurs that goes beyond the original intent, then the other events are accidental and meet the specifications of a motor vehicle accident, unless the contrary can be clearly established. The following are examples of legal intervention and should not be classified as accidents:

- (a) A road block is set up to stop a lawbreaker, and the lawbreaker crashes into it, either intentionally or unintentionally.
- (b) A police unit cuts in front of another vehicle to force it to the curb or shoulder and, as a result, the two vehicles collide.

- (c) A vehicle loses control as a result of bullets fired into it from a police officer's gun, and crashes.

The following are examples of an accident:

- (d) A driver, other than a lawbreaker, crashes unintentionally into a roadblock.
- (e) A lawbreaker, while eluding the police, loses control of his vehicle and crashes into another vehicle.
- (f) A police car skids and crashes while chasing a law violator.

If in (c) above, the vehicle had created a harmful event with another vehicle or person, then the presumed unintended consequences of the action would qualify this situation as an accident.

One example which has previously been encountered is as follows: A prisoner jumps out of a police car and is injured. An officer in another car who observes this event, writes a report. Is this an accident? Yes. Although the prisoner exited the car intentionally, the subsequent injury harmful event) occurred as an unintended consequence of the prisoner's escape attempt, thus constituting this event as an accident. It should be assumed that the injury was an unintended consequence of the prisoner's action unless the contrary can be clearly established.

For the purposes of NASS PAR listing, the same guidance as given above applies.

Cataclysm: ANSI D16.1-1989 lists the following events as catastrophic: a cloudburst, cyclone, earthquake, flood, hurricane, lightning, tidal wave, torrential rain, tornado, or volcanic eruption. If any one of these events was on-going at the time of the accident and produced the unstabilized situation which led to the harm, then the event(s) is (are) not considered an accident. One key phrase is "on-going". Consider the following example: A motor vehicle in-transport was overwhelmed by a landslide or an avalanche which was a direct result of a cataclysm, such as an earthquake, torrential rain, etc. This circumstance would not be considered an accident. However, this exclusion would not apply if a cataclysm were not in existence at the time of the event; nor would this exclusion apply if the motor vehicle was unintentionally driven against any fallen materials covering a trafficway as a result of any landslide or avalanche. As this example points out, the catastrophic event "exclusion" should occur very rarely.

Another key phrase is "produced the unstabilized situation". The situation in which a vehicle hydroplanes in a torrential rain and exits the roadway, striking another motor vehicle or object, would fit the criteria for a NASS accident, but the situation in which a cloudburst/torrential rain washes a roadway out from under a vehicle travelling on a roadway would be excluded from consideration as a NASS accident. (Remember, the cataclysm must be on-going at the time of the accident.)

For the purposes of NASS PAR listing, list any accidents which you believe should be excluded under the cataclysm exception. Confirm their exclusion by relating the events to your zone center before drawing the NASS CDS sample.

After a NASS CDS accident has been selected the accident can be dropped if either subsequent research or an official ruling (e.g., by the police, by a medical examiner, etc.) reveals that one of the exceptions (i.e., disease, deliberate intent, legal intervention, or cataclysm) applies. When dropping the accident, notify your zone center and follow the procedures outlined in Section 5.3.

Must Involve A Motor Vehicle as Defined by ANSI--If a police report does not involve at least one motor vehicle as defined by ANSI D16.1-1989, section 2.2.7 (see figure 2-6, page 21), then it should be returned to the file and not included in the list which qualifies for inclusion.

Example: A bicycle which runs off the road and hits a tree is not a motor vehicle accident and should not be listed.

Must Involve a Motor Vehicle in-Transport--Use the ANSI D16.1-1989, section 2.2.29 (see figure 2-6, page 20) definition to determine if the motor vehicles in the accident are in-transport. There must be at least one motor vehicle in the accident in-transport for the accident to qualify. (NOTE: Any driverless vehicle of which any portion is located on the roadway is considered as a vehicle in-transport)

Example 1: A bicyclist running into a car which is parked off the roadway does not constitute a motor vehicle accident for this study and would be excluded. If a police report has been filled out on such an incident, return the police report to the file because it does not qualify.

Example 2: Vehicles parked on roads of reduced width, such as result from snow accumulation and incomplete snow removal, are to be considered in-transport if any portion is on the roadway.

Must Involve a Motor Vehicle In-Transport on a Trafficway--Exclude accidents which occur in places other than a trafficway. Examples of places which are not on the trafficway include private driveways and parking lots (except entrances and roadways within parking lots which are customarily used to get from the entrance to a parking aisle). Review carefully the diagrams depicting rural, urban, and divided trafficways in Figures 2-2, 2-3, and 2-4.

Example: An abandoned vehicle, a portion of which is on the roadway, is struck by a bicyclist, causing injury to the bicyclist. A police report is filled out by an investigating officer. Is this a motor vehicle accident? Yes it is, because there is a police reported incident involving a motor vehicle in-transport on a trafficway.

In each of these figures (2-2, 2-3, and 2-4) any harmful event: (1) resulting from an unstabilized situation, (2) involving an in-transport motor vehicle, and (3) which occurs between the two right-of-way lines, occurred on a trafficway. This means that "the harmful event" need not necessarily be the first harmful event; see the discussion of stabilization which follows. It is only necessary that "a harmful event" occur between the right-of-way lines. Further, any harmful event satisfying the conditions above which occurs on the "roadside" (Figures 2-2 and 2-4), in the "median" (Figure 2-4), or at or beyond the curbed area (Figure 2-3), qualifies as a NASS accident.

FIGURE 2-2

Example of a Rural Trafficway

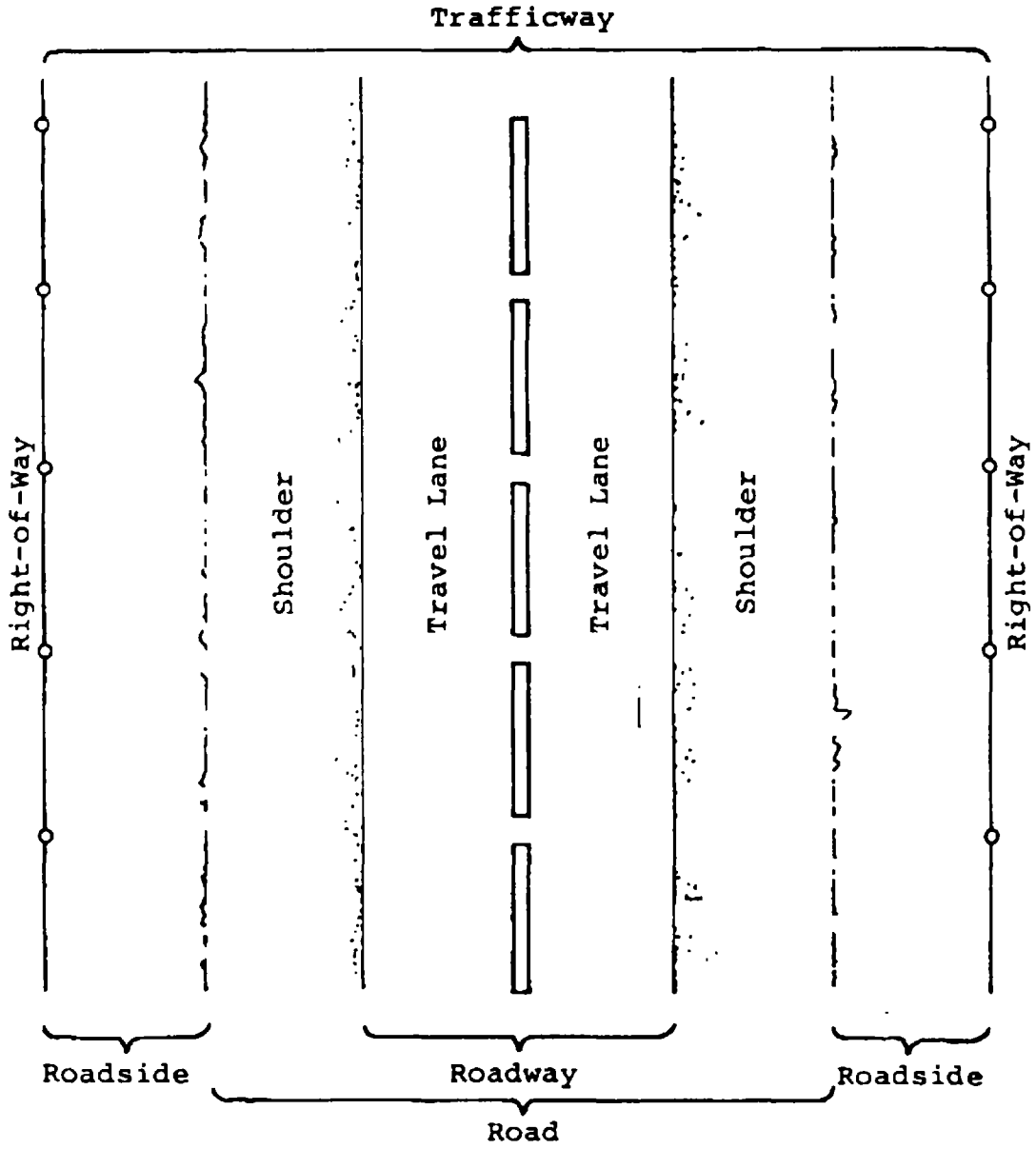
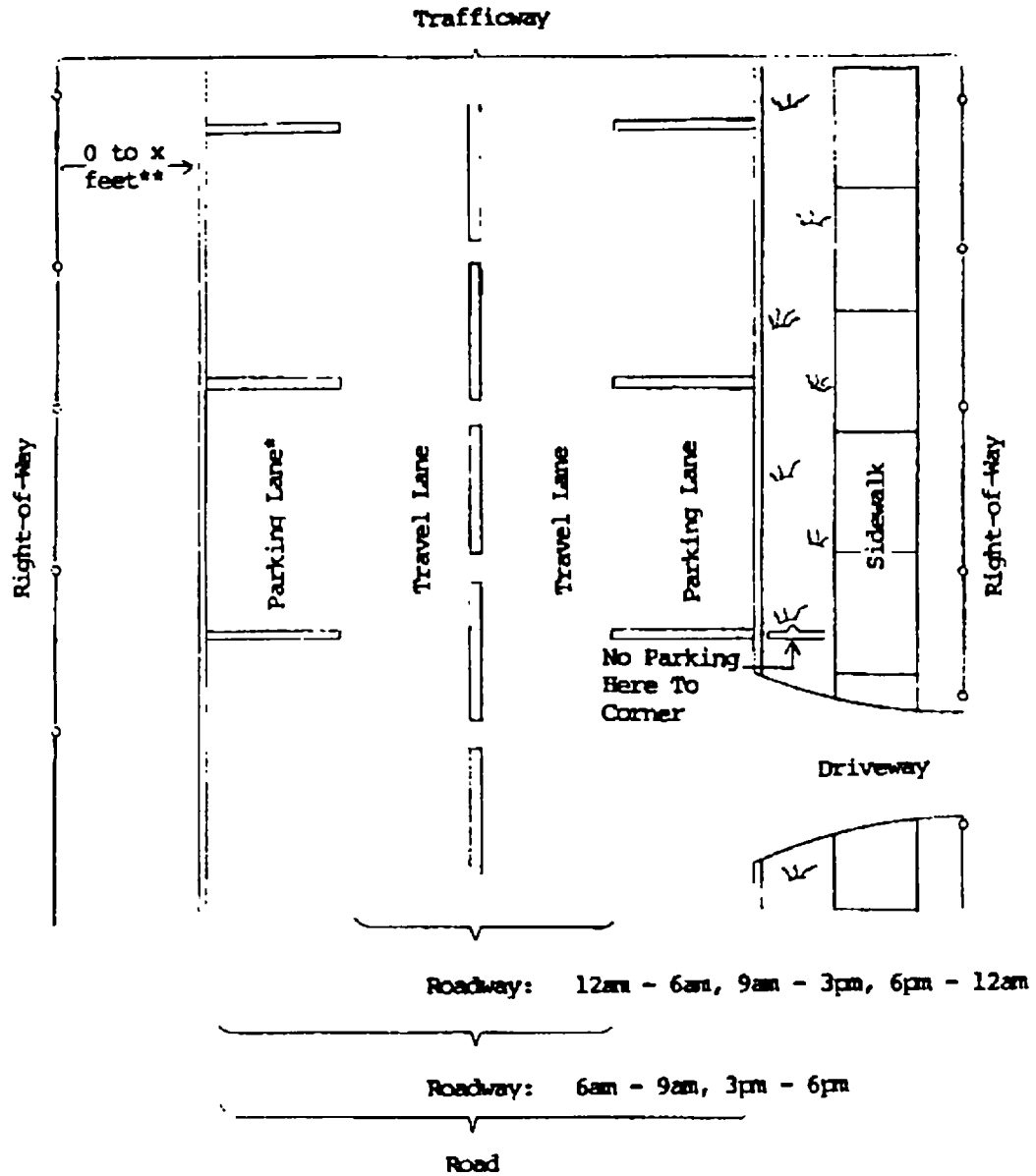

FIGURE 2-3

Example of an Urban Trafficway



* No parking allowed 6 to 9 a.m. or 3 to 6 p.m.

** The actual right-of-way in many cases will not be known. But it is clear that the trafficway always goes from curb to curb or from shoulder to shoulder.

FIGURE 2-4

Example of a Divided Trafficway

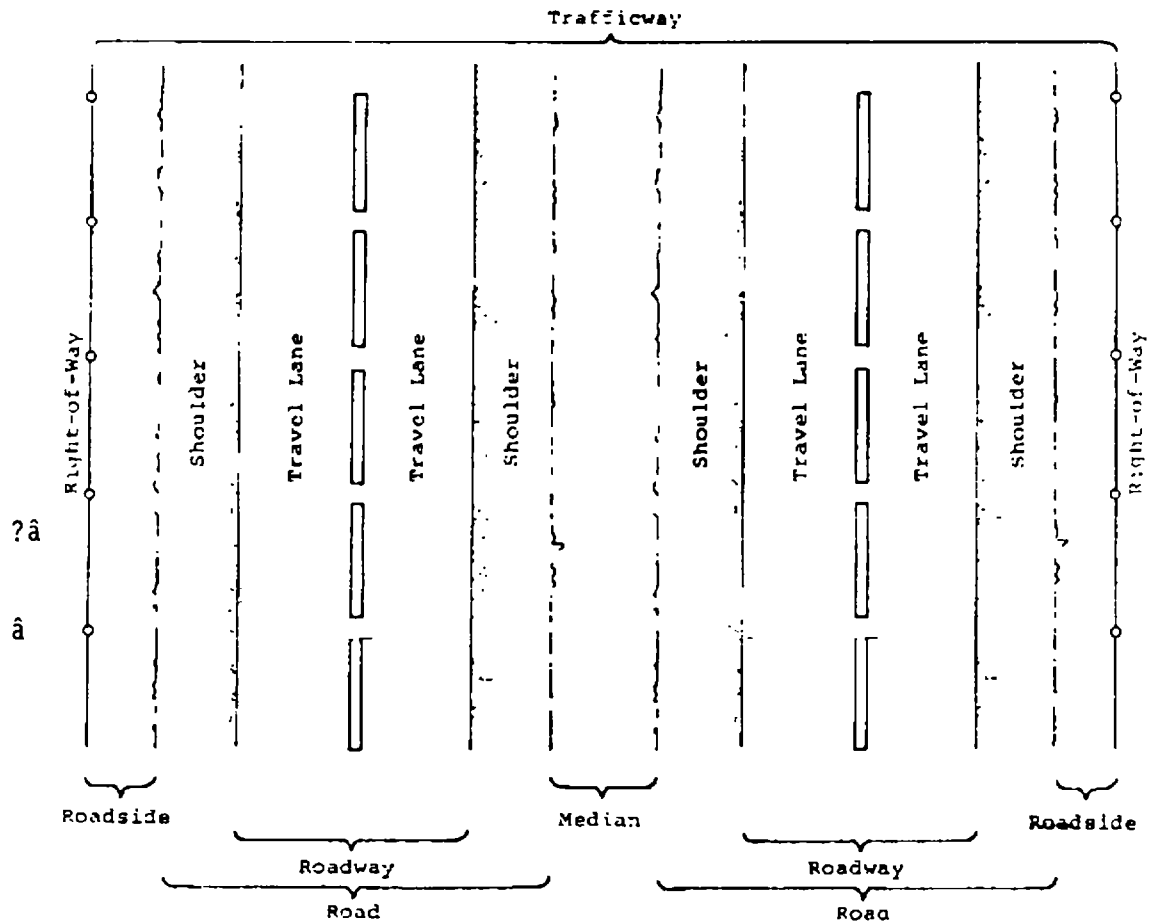

Example: An in-transport motor vehicle entering or exiting the driveway (Figure 2-3) is involved in a harmful event between the right-of-way line and the beginning of the "road". Because the harmful event occurred on a trafficway, this police reported incident is a NASS accident.

A driveway is usually a private way providing access to property adjacent to a trafficway. An alley is an unnamed private way providing access, in general, to the rear of houses or buildings, some of which may be further served by a driveway.

Most driveways (but not all) and alleys are not trafficways in NASS. Examples of non-NASS trafficways are driveways to: (1) service stations, (2) residential dwellings, and (3) most apartment complexes, hotels, motels, and other commercial establishments.

As a general rule, assume sidewalks adjacent to roads are part of the public domain and thus are located within the right-of-way. This assumption also applies to utility poles located along a road.

Certain driveways within parking or shopping lots qualify as trafficways in NASS if they satisfy the three criteria discussed below.

The phrase "open to the public as a matter of right or custom" (ANSI D16.1-1989, section 2.2.1; see figure 2-6, page 23) causes problems when the property is privately owned. One problem area centers around shopping centers. Private ownership does not automatically disqualify a PAR for consideration as a NASS accident. The nature and extent of "land ways" (ANSI D16.1-1989, section 2.1.11, see figure 2-6, page 20) on private property, and the differences in accident reporting criteria by police, have brought about the narrowing of the definition of a trafficway (ANSI D16.1-1989, section 2.2.1; see figure 2-6, page 23) to that which can be operationally defined. In parking or shopping lots three criteria must be met:

- * There must exist two or more contiguous lanes of travel, usually these are clearly marked;
- * The land way must intersect another land way inside the lot or center; and
- * The junction of the internal land ways must have traffic controls (i.e., STOP or YIELD signs or markings).

The intent is to select those land ways which serve the purpose of getting traffic to and from the parking area; however, the fact that parking is allowed immediately adjacent to the land way does not disqualify it from consideration. Figure 2-5 (containing four schematics) does not attempt to cover the entire spectrum of possibilities but only illustrates some common examples. For situations A, B, and C none of the land ways should be considered as trafficways, since the criteria are not met. However, a NASS accident could occur at each of these locations if a harmful event occurred on the existing trafficway (i.e., Main Street), or an unstabilized situation originated on the trafficway which resulted in a harmful event on the private way or to the commercial property itself. In situation D the screened-in areas are roadways since they meet the criteria.

FIGURE 2-5

Situation A

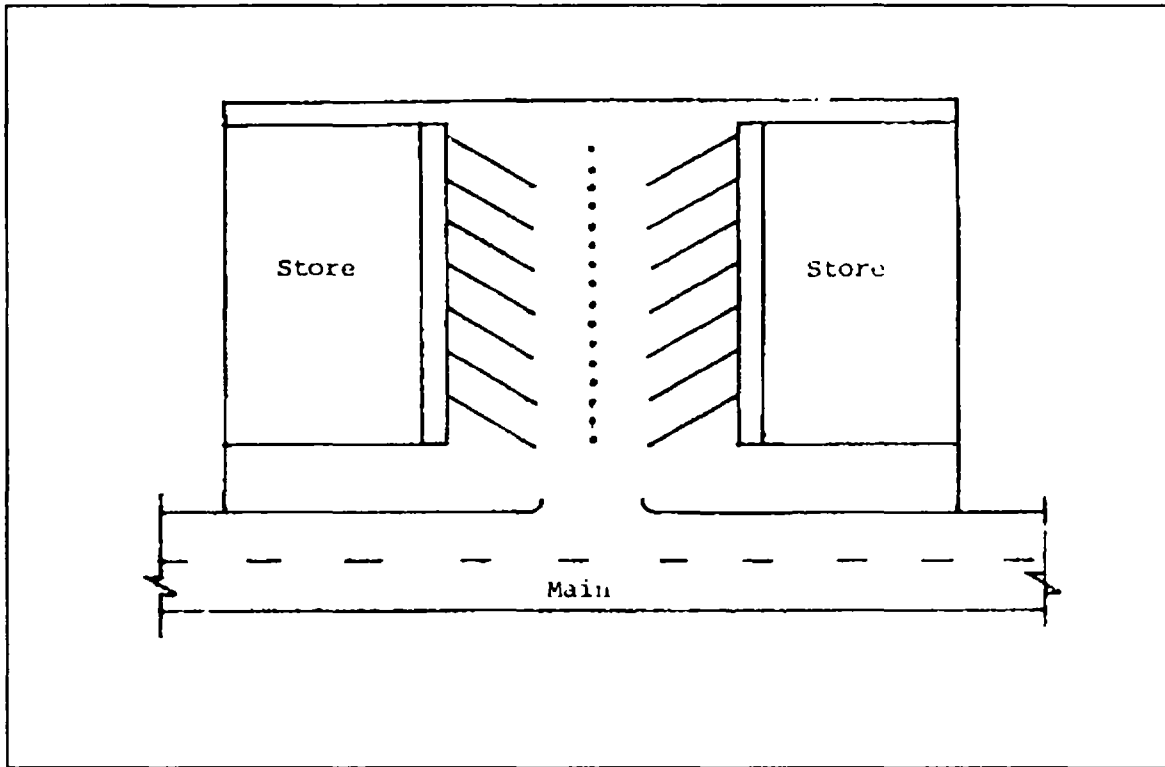

Situation B

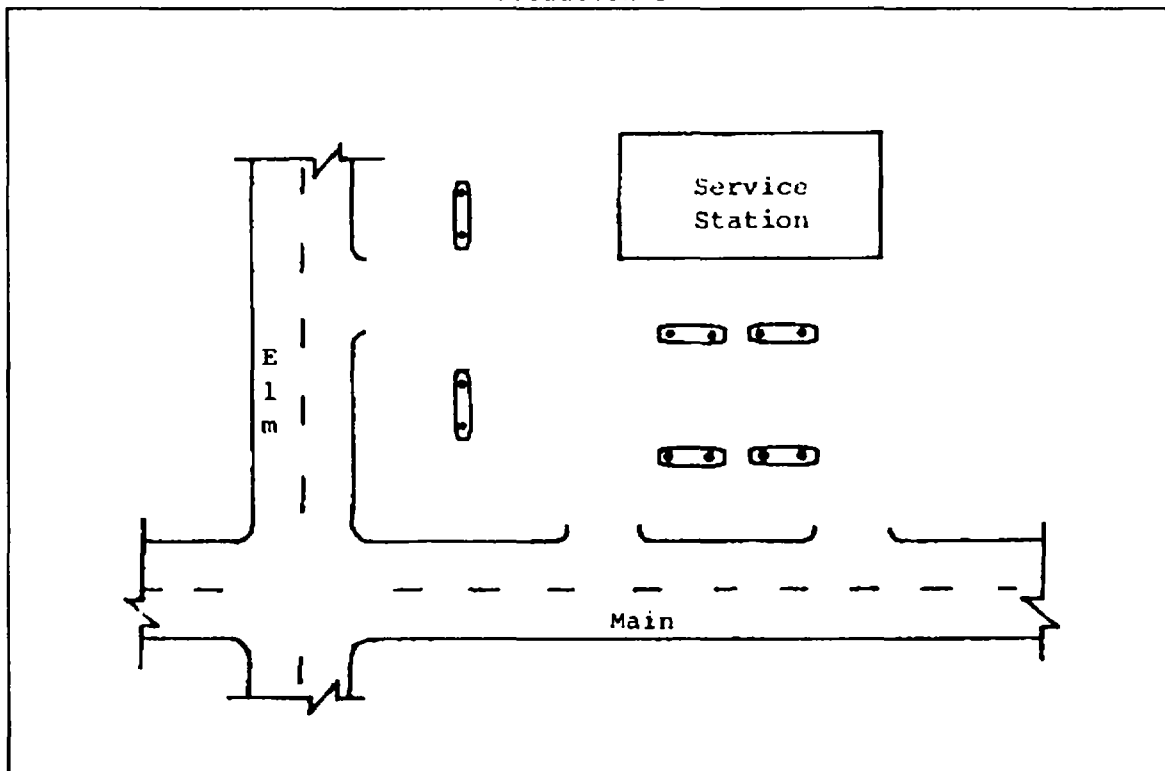
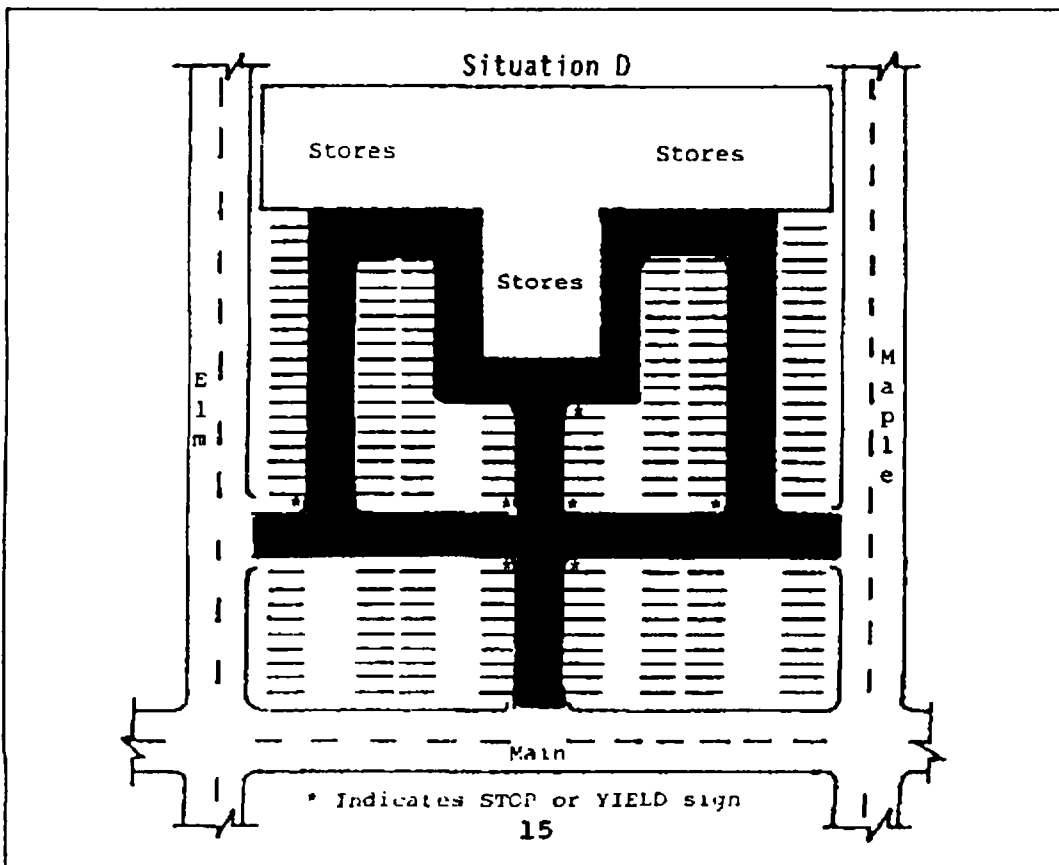
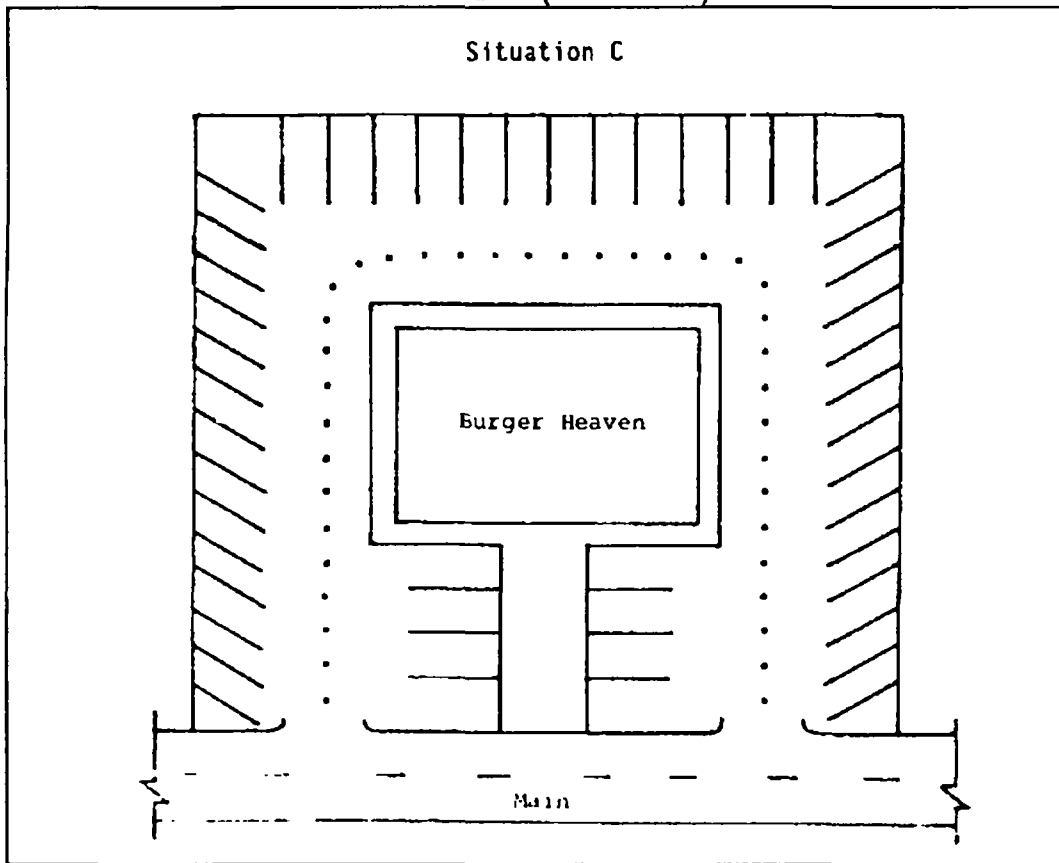

FIGURE 2-5 (Continued)



In summary, each of the preceding questions is designed to focus your attention to the specific subset of transportation-related incidents characterized as "motor vehicle traffic accidents". In NASS, you research Motor Vehicle Traffic Accidents. To put this subset of accidents which qualify for NASS in perspective, see Figure 2-6. This figure outlines the major definitional sections of ANSI D16.1-1989 into meaningful groups and shows how the phenomenon of motor vehicle traffic accidents fits into the overall transportation accident picture. Accompanying Figure 2-6 are the primary ANSI definitions of interest to NASS. Figure 2-6 refers to these definitions. These definitions are provided here as both a reference source to you, the NASS researcher, as well as enabling you to understand the larger transportation accident picture to which ANSI refers. Be sure to remember the location in this manual of Figures 2-1 and 2-6; together, they can serve as a handy reference source to remind you of what constitutes a "NASS accident".

Figure 2-7 depicts the relationship between the ANSI definitions and NASS. Shown in this figure are the four types of transport accidents (ANSI D16.1- 1989, section 2.4.7, see figure 2-6, page 23): aircraft accidents, watercraft accidents, railway accidents, and road vehicle accidents. A priority scheme exists when a transport accident involves more than one type of transport vehicle. Any unstabilized situation that results from an aircraft is considered an aircraft accident. This means that if a plane crashes, impacting an in-transport motor vehicle, any damage or injury in the motor vehicle is considered part of the aircraft accident and is not a road vehicle accident; thus, if the associated motor vehicle is listed on a PAR, that PAR cannot be sampled in NASS. Similarly, if the unstabilized situation is caused by a watercraft, then all resulting damage is considered part of the watercraft accident. Aircraft accidents take precedence over watercraft accidents. Aircraft and watercraft accidents take precedence over railway and road vehicle accidents. If a road vehicle and a railway vehicle impact, the accident is classified according to which transport vehicle type produced the unstabilized situation. An example of an unstabilized situation produced by a railway vehicle is a derailment. If after a derailment a railway vehicle impacts a road vehicle, then the accident is classified as a railway accident. The vast majority of motor vehicle-train impacts are the result of an unstabilized situation created by the motor vehicle. Specifically, any time a train is on its tracks and is impacted by a motor vehicle, then the accident should be considered a road vehicle accident.

Figure 2-7 expands upon the four cell road vehicle accident matrix presented in Figure 2-6. Three of the cells contain examples of accidents that are not motor vehicle traffic accidents--Motor Vehicle Nontraffic Accident, Other Road Vehicle Traffic Accident, and Other Road Vehicle Nontraffic Accident. As this figure depicts, motor vehicle traffic accidents represent the vast majority of road vehicle accidents. NASS researches motor vehicle traffic accidents--except for those not reported to the State. All reported MVTAs are part of the General Estimates System (GES). MVTAs qualifying for the Crashworthiness Data System (CDS) are but a part of all MVTAs. The shaded area of the MVTA cell represents the three types of GES accidents that do not qualify for the CDS. The definition of NASS sampling and the respective CDS and GES strata are covered in Section 2.2.

Ideally a police report should report only one accident. Unfortunately, this is not always true. There are practical and understandable reasons why this occurs. This manual would be remiss if it failed to discuss the issue of stabilization.

FIGURE 2-6

Manual on Classification of Motor Vehicle Traffic Accidents -- 5th Edition ANSI
D16.1-1989

	Section
Person	2.1.1
Property	2.1.2
Transport device	2.1.3
Animal	- -
Transport vehicle	2.1.4
Aircraft	2.1.5
Watercraft	2.1.6
Land vehicle	2.1.7
Railway vehicle	2.2.4
Road vehicle	2.2.6
Motor vehicle	2.2.7
Other road vehicle	2.2.8
In-transport	2.2.29
Transport way	2.1.8
Airway	2.1.9
Waterway	2.1.10
Land way	2.1.11
Railway	2.2.3
Private way	2.2.2
Trafficway	2.2.1
Road	2.2.28
Shoulder	2.2.27
Roadway	2.2.26
Roadside	- -
Median	- -
Accidents	2.4
Harmful event	2.4.1
Injury	2.3.1
Damage	2.3.7
Unstabilized situation	2.4.4
Deliberate intent	2.4.2
Legal intervention	2.4.3
Cataclysm	2.4.5
Accident	2.4.6
Transport accident	2.4.7
Aircraft accident	2.4.8
Watercraft accident	2.4.9
Railway accident	2.4.11
Road vehicle accident	2.4.15
Motor vehicle accident	2.4.10
Other road vehicle accident	2.4.12
or	
Traffic Accident	2.4.16
Nontraffic accident	2.4.18
	2.4.17
	2.4.19

Motor Vehicle Traffic Accident

	Traffic Accident	Nontraffic Accident
Motor Vehicle	2.4.20	2.4.21
Other Road Vehicle	2.4.22	2.4.23

FIGURE 2-6 (Definitions)

ACCIDENT: (2.4.6)

An accident is an unstabilized situation which includes at least one harmful event.

AIRCRAFT: (2.1.5)

An aircraft is a transport vehicle designed primarily for, or in use for, moving persons or property through the air from one place to another. Inclusions: airplane, balloon, dirigible, glider, parachute, spacecraft, and others.

AIRCRAFT ACCIDENT: (2.4.8)

An aircraft accident is a transport accident that involves an aircraft in-transport.

AIRWAY: (2.1.9)

An airway is a transport way reserved primarily for use by aircraft taking off, in flight, or landing.

AT-GRADE INTERSECTION: (2.5.12)

An at-grade intersection is an intersection where all roadways cross or join at the same level.

AUTOMOBILE: (2.2.10)

An automobile is a motor vehicle other than a motorcycle consisting primarily of a transport device designed for carrying ten or fewer persons. Automobiles may be classified by size or weight, or both. Size classification is based on wheelbase. Weight classification is based on curb weight, the weight of an automobile with standard equipment and a full complement of fuel and other fluids, but with no load of persons or property. Before classification, wheelbase should be rounded to the nearest inch and curb weight should be rounded to the nearest 100 pounds.

Primary automobile size categories are: [THREE-CATEGORY SET: (3.10.2.1)]

Small	-----	wheelbase 99 inches (2.51 meters) or less
Midsized	-----	wheelbase 100 to 109 inches (2.54 to 2.77 meters)
Large	-----	wheelbase 110 inches (2.79 meters) or more

Secondary automobile size categories are: [SEVEN-CATEGORY SET: (3.10.2.2)]

Ultrasmall	-----	wheelbase 89 inches (2.26 meters) or less
Minicompact	-----	wheelbase 90 to 94 inches (2.29 to 2.39 meters)
Subcompact	-----	wheelbase 95 to 99 inches (2.41 to 2.51 meters)
Compact	-----	wheelbase 100 to 104 inches (2.54 to 2.64 meters)
Intermediate	-----	wheelbase 105 to 109 inches (2.67 to 2.77 meters)
Full-size	-----	wheelbase 110 to 114 inches (2.79 to 2.90 meters)
Largest	-----	wheelbase 115 inches (2.92 meters) or more

Primary automobile weight categories are: [THREE-CATEGORY SET: (3.11.2.1)]

Light	-----	curb weight 2400 pounds (1089 kilograms) or less
Midweight	-----	curb weight 2500 to 3400 pounds (1134 to 1542 kilograms)
Heavy	-----	curb weight 3500 pounds (1588 kilograms) or more

Secondary automobile weight categories are: [SEVEN-CATEGORY SET: (3.11.2.2)]

A	-----	curb weight 1400 pounds (635 kilograms) or less
B	-----	curb weight 1500 to 1900 pounds (680 to 862 kilograms)
C	-----	curb weight 2000 to 2400 pounds (907 to 1089 kilograms)
D	-----	curb weight 2500 to 2900 pounds (1134 to 1315 kilograms)
E	-----	curb weight 3000 to 3400 pounds (1361 to 1542 kilograms)
F	-----	curb weight 3500 to 3900 pounds (1588 to 1769 kilograms)
G	-----	curb weight 4000 pounds (1814 kilograms) or more

BUS: (2.2.11):

A bus is a motor vehicle consisting primarily of a transport device designed for carrying more than ten persons.

CATAclysm: (2.4.5)

A cataclysm is an avalanche, cloudburst, cyclone, earthquake, flood, hurricane, landslide, lightning, tidal wave, tornado, torrential rain, or volcanic eruption.

CLASSIFICATION OF ROAD VEHICLES BY DAMAGE SEVERITY -- MOTOR VEHICLES: (3.2.2.1)

In order of precedence, motor vehicle categories by severity of damage are:

- Disabling damage to motor vehicle
- Functional damage to motor vehicle
- Other motor vehicle damage
- No damage to motor vehicle

COLLISION ACCIDENT: (2.6.2)

A collision accident is a road vehicle accident other than an overturning accident in which the first harmful event is a collision of a road vehicle in-transport with another road vehicle, other property or pedestrians (pedestrians or nonmotorists).

FIGURE 2-6 (Definitions - continued)

DAMAGE: (2.3.7)

Damage is harm to property that reduces the monetary value of that property. Inclusions: harm to wild animals, or birds, which have monetary value, and others. Exclusions: harm to wild animals, or birds, which have no monetary value. Harm to a snowbank unless, for example, additional snow-removal costs are incurred because of the harm. Mechanical failure during normal operation, such as tire blowout, broken fan belt, or broken axle, and others.

DELIBERATE INTENT: (2.4.2)

Deliberate intent is the classification given to the cause of an event which occurs when a person acts deliberately to cause the event or deliberately refrains from prudent acts which would prevent the occurrence of the event. Inclusions: suicide, self-inflicted injury, homicide, injury or damage purposely inflicted, and others. Exclusions: injury or damage beyond that which was intended, and others.

Examples:

1. When a driver intentionally kills or injures himself with a motor vehicle, by driving it against a fixed object or into a body of water, for example, the driver's death or injury is a result of deliberate intent.
2. When a driver intentionally kills or injures another person with a motor vehicle, by running into a pedestrian, for example, the death or injury is a result of deliberate intent.
3. When a driver intentionally causes damage with a motor vehicle, by ramming another vehicle, for example, the damage is a result of deliberate intent.

DISABLING DAMAGE: (2.3.11)

Disabling damage is road vehicle damage which precludes departure of the vehicle from the scene of the accident in its usual operating manner by daylight after simple repairs. Inclusions: vehicles which could be driven but would be further damaged thereby, and others.

Exclusions:

Damage which can be remedied temporarily at the scene without special tools or parts other than tires;
Tire disablement without other damage even if no spare tire is available;
Headlamp or taillight damage, which would make night driving hazardous but would not affect daytime driving;
Damage to turn signals, horn, or windshield wipers which makes them inoperative; and
Others.

DRIVER: (2.2.32)

A driver is an occupant who is in actual physical control of a transport vehicle or, for an out-of-control vehicle, an occupant who was in control until control was lost.

DRIVEWAY ACCESS: (2.5.9)

A driveway access is a roadway providing access to property adjacent to a trafficway. Inclusions: entrances to gas stations and others. Exclusions: any area not within a trafficway.

FULL TRAILER: (2.2.16)

A full trailer is a trailer, other than a pole trailer, designed for carrying property and so constructed that no part of its weight rests upon or is carried by the towing road vehicle. An auxiliary undercarriage assembly, commonly known as a converter dolly and consisting of a chassis, fifth wheel and one or more towbars, is sometimes used to convert a semitrailer to a full trailer.

FUNCTIONAL DAMAGE: (2.3.12)

Functional damage is any road vehicle damage, other than disabling damage, which affects operation of the road vehicle or its parts.

Inclusions:

Doors, windows, hood, and trunk lids which will not operate properly;
Broken glass which obscures vision;
Any damage which would prevent the motor vehicle from passing an official motor vehicle inspection;
Tire damage even though the tire may be changed at the scene;
Bumpers which are loose; and
Others.

Exclusions:

Dented or bent fenders, bumpers, grills, body panels, destroyed hubcaps, and others.

GRADE SEPARATION: (2.5.14)

A grade separation is a crossing at different levels of two trafficways, or a trafficway and a railway.

GROSS WEIGHT: (2.2.20)

Gross weight is the weight of a road vehicle including the weight of the road vehicle, its load of persons and property, and all added equipment.

GROSS VEHICLE WEIGHT RATING: (2.2.21)

A gross vehicle weight rating is (1) a value specified by the manufacturer for a single-unit truck, truck tractor or trailer, or (2) the sum of such values for the units which make up a truck combination. In the absence of a gross vehicle weight rating, an estimate of the gross weight of a fully loaded unit may be substituted for such a rating.

FIGURE 2-6 (Definitions - continued)

HARMFUL EVENT: (2.4.1)

A harmful event is an occurrence of injury or damage.

Inclusions:

Injury or damage resulting when a driver dies or loses consciousness because of a disease condition such as a stroke, heart attack, diabetic coma, or epileptic seizure. In such a case the immediate effect of the disease, such as the driver's death or loss of consciousness, is not itself considered to be a harmful event.

HEAVY TRUCK: (2.2.24)

A heavy truck is a truck which has a gross vehicle weight rating of more than 26,000 pounds (11,793 kilograms).

INJURY: (2.3.1)

An injury is bodily harm to a person. Exclusions: effects of diseases, such as stroke, heart attack, diabetic coma, epileptic seizure, and others.

INTERSECTION: (2.5.10)

An intersection is an area which (1) contains a crossing or connection of two or more roadways not classified as driveway access and (2) is embraced within the prolongation of the lateral curb lines or, if none, the lateral boundary lines of the roadways. Where the distance along a roadway between two areas meeting these criteria is less than 10 meters (33 feet), the two areas and the roadway connecting them are considered to be parts of a single intersection.

IN-TRANSPORT: (2.2.29)

The term "in-transport" denotes the state or condition of a transport vehicle which is in-motion or within the portion of a transport way ordinarily used for travel by similar transport vehicles.

When applied to motor vehicles, "in-transport" means in-motion or on a roadway. Inclusions: motor vehicle in traffic on a highway, driverless motor vehicle in-motion, motionless motor vehicle abandoned on a roadway, disabled motor vehicle on a roadway, and others.

In roadway lanes used for travel during rush hours and parking during off-peak periods, a parked motor vehicle is in-transport during periods when parking is forbidden.

JACKKNIFE ACCIDENT: (2.6.4)

A jackknife accident is a noncollision accident in which the first harmful event results from unintended contact between any two units of a multiunit road vehicle such as a truck combination.

JUNCTION: (2.5.11)

A junction is either an intersection or the connection between a driveway access and a roadway other than a driveway access.

LAND VEHICLE: (2.1.7)

A land vehicle is a transport vehicle which is neither an aircraft nor a watercraft.

LAND WAY: (2.1.11)

A land way is the space within property lines or other boundary lines of any transport way that is neither an airway nor a waterway.

LARGE MOTORCYCLE: (2.2.9.2)

A large motorcycle is any motorcycle other than a motor-driven cycle.

LEGAL INTERVENTION: (2.4.3)

Legal intervention is a category of deliberate intent in which the person who acts or refrains from acting is a law-enforcing agent or other official.

Examples:

1. If a lawbreaker crashes either intentionally or unintentionally into a road block set up by police to stop him, the crash is considered a result of legal intervention. If a driver other than the lawbreaker crashes into the road block, the crash is not considered to be a result of legal intervention.
2. If a police car is intentionally driven into another vehicle, the crash is considered to result from legal intervention. If a lawbreaker being pursued by the police loses control of his vehicle and crashes, the crash is not considered to result from legal intervention unless the police intended that the lawbreaker crash.

LIGHT TRUCK: (2.2.22)

A light truck is a truck which has a gross vehicle weight rating of less than 10,000 pounds (4,536 kilograms).

MEDIUM TRUCK: (2.2.23)

A medium truck is a truck which has a gross vehicle weight rating of from 10,000 to 26,000 pounds (4,536 to 11,793 kilograms).

FIGURE 2-6 (Definitions - continued)

MOPED: (2.2.9.4)

A moped is a speed-limited motor-driven cycle which may be propelled by pedalling. Exclusions: motor scooters, motorized or motor-assisted bicycles, and others.

MOTORCYCLE: (2.2.9)

A motorcycle is any motor vehicle having a seat or saddle for the use of its operator and designed to travel on not more than three wheels in contact with the ground. Exclusions: construction, farm, or industrial machinery. Inclusions: large motorcycle, motor-driven cycle, speed-limited motor-driven cycle, moped, motor scooter, motorized or motor-assisted bicycle, and others.

MOTOR-DRIVEN CYCLE: (2.2.9.1)

A motor-driven cycle is any motorcycle having an engine with less than 150 cubic centimeters displacement or with five brake horsepower or less.

MOTOR VEHICLE: (2.2.7)

A motor vehicle is any motorized (mechanically or electrically powered) road vehicle not operated on rails.

MOTOR VEHICLE ACCIDENT: (2.4.10)

A motor vehicle accident is a transport accident that (1) involves a motor vehicle in-transport, (2) is not an aircraft accident or watercraft accident, and (3) does not include any harmful event involving a railway train in-transport prior to involvement of a motor vehicle in-transport.

MOTOR VEHICLE NONTRAFFIC ACCIDENT: (2.4.21)

A motor vehicle nontraffic accident is a motor vehicle accident which is a nontraffic accident.

MOTOR VEHICLE TRAFFIC ACCIDENT: (2.4.20)

A motor vehicle traffic accident is a motor vehicle accident which is a traffic accident.

NONCOLLISION ACCIDENT: (2.6.3)

A noncollision accident is any road vehicle accident other than a collision accident.

Inclusions:

- overturning accident;
- jackknife accident;
- accidental poisoning from carbon monoxide generated by a road vehicle in-transport;
- breakage of any part of a road vehicle in-transport, resulting in injury or in further property damage;
- explosion of any part of a road vehicle in-transport;
- fire starting in a road vehicle in-transport;
- fall or jump from a road vehicle in-transport;
- occupant hit by an object in, or thrown against some part of a road vehicle in-transport;
- injury or damage from moving part of a road vehicle in-transport;
- object falling from, or in, a road vehicle in-transport;
- object falling on a road vehicle in-transport;
- toxic or corrosive chemicals leaking out of a road vehicle in-transport;
- injury or damage involving only the road vehicle that is of a noncollision nature, such as a bridge giving way under the weight of a road vehicle, striking holes or bumps on the surface of the trafficway, or driving into water, without overturning or collision;
- and others.

NONCONTACT ROAD VEHICLES: (3.6.3)

A "phantom" or "noncontact" road vehicle, such as one which forces another off the road but is itself not damaged, is not counted as one of the road vehicles involved in an accident.

NONTRAFFIC ACCIDENT: (2.4.17)

A nontraffic accident is a road vehicle accident which is not a traffic accident.

OCCUPANT: (2.2.30)

An occupant is any person who is part of a transport vehicle.

OTHER ROAD VEHICLE: (2.2.8)

An other road vehicle is any road vehicle other than a motor vehicle. Inclusions: animal-drawn vehicle (any type), animal harnessed to a conveyance, animal carrying a person, street car, pedalcycle, and others.

OTHER-ROAD-VEHICLE ACCIDENT: (2.4.12)

An other-road-vehicle accident is a transport accident that (1) involves an other road vehicle in-transport and (2) is not an aircraft accident, watercraft accident, motor vehicle accident, or railway accident.

OTHER-ROAD-VEHICLE NONTRAFFIC ACCIDENT: (2.4.23)

An other-road-vehicle nontraffic accident is an other-road-vehicle accident which is a nontraffic accident.

OTHER-ROAD-VEHICLE TRAFFIC ACCIDENT: (2.4.22)

An other-road-vehicle traffic accident is an other-road-vehicle accident which is a traffic accident.

FIGURE 2-6 (Definitions - continued)

OVERTURNING ACCIDENT: (2.6.1)

An overturning accident is a road vehicle accident in which the first harmful event is the overturning of a road vehicle.

PARKING LOT: (2.5.22)

A parking lot is an area used primarily for parking road vehicles. When paved and marked it commonly includes the following areas:

- (1) Parking stalls--areas reserved primarily for parked road vehicles
- (2) Parking lot aisles--areas used primarily for vehicular access to parking stalls. Parking lot aisles are not trafficways.
- (3) Parking lot ways--land ways which are used primarily for vehicular circulation within parking lots and for vehicular access to parking lot aisles. Parking lot ways in parking lots open to the public are trafficways.

PASSENGER: (2.2.33)

A passenger is any occupant of a road vehicle other than its driver.

PEDALCYCLE: (2.2.25)

A pedalcycle is a nonmotorized other road vehicle propelled by pedalling. Inclusions: bicycle, tricycle, unicycle, pedalcar, and others.

PERSON: (2.1.1)

A person is any living human. Within the context of this manual, a fetus is considered to be part of a pregnant woman rather than a separate individual. After death, a human body is not considered to be a person.

POLE TRAILER: (2.2.14)

A pole trailer is a trailer designed to be attached to the towing road vehicle by means of a reach or pole, or by being boomed or otherwise secured to the towing road vehicle, and ordinarily used for carrying property of a long or irregular shape such as poles, pipes, or structural members that are generally capable of sustaining themselves as beams between the supporting connections.

PRIVATE WAY: (2.2.2)

A private way is any land way other than a trafficway. The space within a crossing of a private way and a trafficway shall be considered to be (a) trafficway.

PROPERTY: (2.1.2)

Property is any physical object other than a person. Inclusions: real property, personal property, animals-- wild or domestic, signs, guardrails, impact attenuators, and others.

RAILWAY: (2.2.3)

A railway is any private way reserved primarily for land vehicles moving persons or property from one place to another on rails.

RAILWAY ACCIDENT: (2.4.11)

A railway accident is a transport accident that (1) involves a railway train in-transport and (2) is not an aircraft accident, watercraft accident or motor vehicle accident.

RAILWAY VEHICLE: (2.2.4)

A railway vehicle is any land vehicle that is (1) designed primarily for, or in use for, moving persons or property from one place to another on rails and (2) not in use on a land way other than a railway. Inclusions: street car on private way, and others. Exclusions: street car operating on trafficway and others.

ROAD: (2.2.28)

Road is that part of a trafficway which includes both the roadway and any shoulder alongside the roadway.

ROADWAY: (2.2.26)

A roadway is that part of a trafficway designed, improved, and ordinarily used for motor vehicle travel or, where various classes of motor vehicles travel or motor vehicles are segregated, that part of a trafficway used by a particular class. Separate roadways may be provided for northbound and southbound traffic or for trucks and automobiles. Exclusions: bridle paths, bicycle paths, and others.

ROAD VEHICLE: (2.2.6)

A road vehicle is any land vehicle other than a railway vehicle.

ROAD VEHICLE ACCIDENT: (2.4.15)

A road vehicle accident is a transport accident that is either a motor vehicle accident or an other-road-vehicle accident.

ROAD VEHICLE DAMAGE: (2.3.8)

Road vehicle damage is damage to a road vehicle. Inclusions: damage to any part of a road vehicle. Exclusions: injury to any person, whether or not the person is part of the road vehicle.

FIGURE 2-6 (Definitions - continued)

ROAD VEHICLE NONTRAFFIC ACCIDENT: (2.4.19)

A road vehicle nontraffic accident is a nontraffic accident.

ROAD VEHICLE TRAFFIC ACCIDENT: (2.4.18)

A road vehicle traffic accident is a traffic accident.

RURAL AREA: (2.5.2)

A rural area is any area which is not within urban areas.

SEMITRAILER: (2.2.15)

A semitrailer is a trailer, other than a pole trailer, designed for carrying property and so constructed that part of its weight rests upon or is carried by the towing road vehicle.

SHOULDER: (2.2.27)

A shoulder is that part of a trafficway contiguous with the roadway for emergency use, for accommodation of stopped road vehicles, and for lateral support of the roadway structure.

SINGLE-UNIT TRUCK: (2.2.17)

A single-unit truck is a truck consisting primarily of a single motorized transport device. When connected to a trailer, such a device may be part of a truck combination.

SPEED-LIMITED MOTOR-DRIVEN CYCLE: (2.2.9.3)

A speed-limited motor-driven cycle is any motor-driven cycle which:

- (1) will not attain a speed of more than 30 miles per hour (48 kilometers per hour) in one mile (1.609 kilometers) from a standing start,
- (2) has an engine with not more than 50 cubic centimeters displacement or with two brake horsepower or less, and
- (3) has a power drive system which does not require its operator to shift gears.

TRAFFICWAY: (2.2.1)

A trafficway is any land way open to the public as a matter of right or custom for moving persons or property from one place to another.

Inclusions:

Within areas with guarded entrances, such as military posts or private residential developments, land ways are trafficways if the guards customarily admit public traffic.

Exclusions:

A land way under construction is not a trafficway if traffic is prohibited from entering by signing or barriers which are in conformance with applicable standards. However, if any part of the land way is open to travel while the remainder is closed, that part which is open for traffic is a trafficway. Likewise, any temporary bypass of a construction site is a trafficway.

A land way temporarily closed to travel and marked by signing or barriers which are in conformance with applicable standards is not a trafficway even though used by authorized vehicles, such as maintenance vehicles, or when intentionally or inadvertently used by unauthorized vehicles. A land way open only to local traffic is not considered closed.

TRAFFIC ACCIDENT: (2.4.16)

A traffic accident is a road vehicle accident in which (1) the unstabilized situation originates on a trafficway or (2) a harmful event occurs on a trafficway.

TRAILER: (2.2.13)

A trailer is a road vehicle designed to be drawn by another road vehicle. Inclusions: pole trailer, semitrailer, full trailer.

TRANSPORT ACCIDENT: (2.4.7)

A transport accident is an accident (1) that involves a transport vehicle in-transport, (2) in which the first harmful event is not produced by the discharge of a firearm or explosive device, and (3) that does not directly result from a cataclysm. Inclusions: motor vehicle driven into water after a bridge was washed out during a hurricane or flood (cataclysm), motor vehicle driven into fall materials covering a roadway after a landslide or avalanche (cataclysm), and others.

TRANSPORT DEVICE: (2.1.3)

A transport device is any device designed primarily for moving persons or property along with the device itself from one place to another, except (1) a weapon, (2) a device used primarily within the confines of a building and its premises, or (3) a human-powered nonmotorized device not propelled by pedalling.

Inclusions:

Airplane, helicopter, hovercraft, ship, submarine, train, boxcar, caboose, snowmobile, automobile, bus, truck, trailer, semitrailer, motorcycle, bicycle, moped, and others.

Exclusions:

Devices not designed primarily for moving persons or property, such as construction machinery, farm or industrial machinery, snow plows, army tanks, etc.

FIGURE 2-6 (Definitions - continued)

Devices which do not move from one place to another, such as pipelines, elevators, escalators, ski lifts, conveyor belt systems, etc.

Weapons, such as guns, torpedoes, etc.

Devices used primarily within buildings and their premises, such as fork lifts in factories or lumber yards, motorized baggage trucks in railroad stations, etc.

Human-powered nonmotorized devices not propelled by pedalling, such as skis, scooters, roller skates, baby carriages, etc.

TRANSPORT VEHICLE: (2.1.4)

A transport vehicle consists of one or more devices or animals and their load. Such devices or animals must include at least one of the following:

- (1) a transport device, or a unit made up of connected transport devices, while idle or in use for moving persons or property from one place to another,
- (2) an animal or team of animals while in use for moving persons or property other than the animal or team itself from one place to another, or
- (3) a movable device such as construction, farm, or industrial machinery outside the confines of a building and its premises while in use for moving persons, the device itself, or other property from one place to another.

If such a device or animal has a load, the load is part of the transport vehicle. Loads include:

Persons or property upon, or set in motion by, the device or animal;

Persons boarding or alighting from the device or animal;

Persons or property attached to and in position to move with the device or animal.

If the load upon a transport device includes another transport device, the entire unit including the load is considered to be a single transport vehicle.

Inclusions:

- (1) Transport Devices--airplane towing a sailplane, tugboat pushing a barge, boxcar coupled to a caboose, truck tractor towing a semitrailer and a trailer, snowmobile towing a skier, automobile towing another automobile, and others;
- (2) Animals--horse and rider, dog team drawing a sled, team of horses drawing a sled, burro carrying a load of firewood, mule towing a boat on a canal, and others; and
- (3) Other Movable Devices--road grader while traveling under its own power from a maintenance depot to a working place, lawn mower while being ridden down a street under its own power, farm tractor while pulling a wagon loaded with corn from a field to a storage place, army tank while moving under its own power from a firing range to a motor pool, and others.

Exclusions:

- (1) Transport Devices--pickup truck while being used to power a saw, dump truck while spreading its load, tow truck while using its winch, jeep while pulling a device picking up golf balls, transit-mix concrete truck while discharging its load, dump truck while plowing snow, and others.

TRANSPORT WAY: (2.1.8)

A transport way is any way or place reserved or commonly used for the operation of transport vehicles. Exclusions: hiking trail, sidewalk, footpath, and others.

TRUCK: (2.2.12)

A truck is a motor vehicle designed primarily for carrying property. Inclusions: single-unit truck, truck combination. Exclusions: truck tractor.

TRUCK COMBINATION: (2.2.19)

A truck combination is a truck consisting primarily of a transport device which is a single-unit truck or truck tractor together with one or more attached trailers. Inclusions: truck tractor with semitrailer, truck tractor with semitrailer and one or more full trailers, single-unit truck with one or more full trailers, and others.

TRUCK TRACTOR: (2.2.18)

A truck tractor is a motor vehicle consisting of a single motorized transport device designed primarily for drawing trailers.

UNSTABILIZED SITUATION: (2.4.4)

An unstabilized situation is a set of events not under human control. It originates when control is lost and terminates when control is regained or, in the absence of persons who are able to regain control, when all persons and property are at rest.

Exclusions: Sets of events which are the result of deliberate intent or legal intervention.

Examples:

1. If intentional acts cause injury or damage beyond that reasonably to be expected from the acts, the unexpected injury or damage is not the result of deliberate intent. There is, therefore, an unstabilized situation unless the contrary can be clearly established.
2. In a motor vehicle crash live electric wires fall on a motor vehicle, but there is no injury from the electric current while the occupants remain in the motor vehicle. The unstabilized situation ends with the occupants in a temporary position of safety. Any subsequent injury resulting from attempts by the occupants to leave the motor vehicle, or attempts by others to rescue the occupants, is a part of a new unstabilized situation.

FIGURE 2-6 (Definitions - continued)

3. In a motor vehicle crash the occupants of the motor vehicle are carried or thrown into water, but there is no injury from the submersion and the occupants reach a temporary position of safety. At this point the unstabilized situation has ended. Any subsequent injury from attempts by the occupants to reach shore, or from attempts by others to rescue the occupants is part of a new unstabilized situation.
4. In a motor vehicle crash objects are loosened but remain in place until all persons are removed from danger from objects that might fall or roll. No property damage would result if the objects fell or rolled. This ends the unstabilized situation. Any subsequent injury attributable to the fall or roll of the loosened objects is not part of the original unstabilized situation.
5. In a motor vehicle crash the motor vehicle catches on fire and is burning, but all occupants have been rescued and the fire is under control. No additional property damage is expected. This is the end of the unstabilized situation. If the heat of the fire ignites nearby combustible materials, any subsequent injury or damage from the induced ignition is not part of the original unstabilized situation.
6. In a motor vehicle crash an involved motor vehicle carrying explosive materials is stopped and occupants and bystanders are removed from the scene. At this point the unstabilized situation is ended. If the explosive materials detonate during later attempts to remove or salvage them, any injury or damage resulting from the explosion is not part of the original unstabilized situation.

URBAN AREA: (2.5.1)

An urban area is an area whose boundaries shall be those fixed by responsible state and local officials in cooperation with each other and approved by the Federal Highway Administration, U.S. Department of Transportation. Such boundaries are established in accordance with the provisions of Title 23 of the United States Code. Urban area boundary information is available from State highway or transportation departments. In the event that boundaries have not been fixed as above for any urban place designated by the Bureau of the Census having a population of 5,000 or more, the area within boundaries fixed by the Bureau of the Census shall be an urban area.

WATERCRAFT: (2.1.6)

A watercraft is a transport vehicle designed primarily for, or in use for, moving persons or property on or through, and supported by, water from one place to another.

WATERCRAFT ACCIDENT: (2.4.9)

A watercraft accident is a transport accident if (1) it involves a watercraft in-transport and (2) is not an aircraft accident.

WATERWAY: (2.1.10)

A waterway is a transport way reserved primarily for use by watercraft.

Figure 2-7

NASS ACCIDENT OVERVIEW

Aircraft Accidents
 Watercraft Accidents
 Railway Accidents
 Road Vehicle Accidents

	TRAFFIC ACCIDENT	NONTRAFFIC ACCIDENT																																																								
MOTOR VEHICLE	General Estimate System	For example: (1) snowmobile hits tree in woods, (2) Two cars impact in a service station, (3) on-farm vehicular accident, or (4) golfer overturns golf cart near 13th green.																																																								
	<u>X. Y. Z. Strata</u>																																																									
	<table border="1" style="width: 100%; border-collapse: collapse;"> <thead> <tr> <th colspan="7">Crashworthiness Data System</th> </tr> <tr> <th rowspan="2">Late Model Year (LMY)</th> <th rowspan="2">FATAL INJURY "K"</th> <th colspan="4">Most Severe Police Reported Injury</th> <th rowspan="2">Injured or Unknown If Injured "B", "C", or "U"</th> <th colspan="2">Not Transported</th> </tr> <tr> <th colspan="2">Transported</th> <th colspan="2">Not Transported</th> <th rowspan="2">Injured, Not Injured or Unknown If Injured "A", "B", "C", "D", or "U"</th> <th rowspan="2">At least One CDS Applicable Vehicle Was Towed</th> <th rowspan="2">No CDS Applicable Vehicles Were Towed</th> </tr> <tr> <th>Vehicle Involvement</th> <th></th> <th>Single CDS Applicable Vehicle</th> <th colspan="2">Multiple CDS Applicable Vehicle</th> <th></th> <th></th> <th></th> <th></th> </tr> <tr> <th></th> <th></th> <th>Towed</th> <th>At least Two Towed</th> <th>Only One Towed</th> <th></th> <th></th> <th></th> <th></th> </tr> </thead> <tbody> <tr> <td>Injury in Towed, LMY, CDS Applicable Vehicle</td> <td>A</td> <td colspan="2">C</td> <td>E</td> <td>G</td> <td colspan="2">NOT IN SCOPE</td> </tr> <tr> <td>Injury not in Towed, LMY, CDS Applicable Vehicle</td> <td>B</td> <td colspan="2">D</td> <td>F</td> <td>H</td> <td colspan="2">SEE Table 2-2</td> </tr> </tbody> </table>	Crashworthiness Data System							Late Model Year (LMY)	FATAL INJURY "K"	Most Severe Police Reported Injury				Injured or Unknown If Injured "B", "C", or "U"	Not Transported		Transported		Not Transported		Injured, Not Injured or Unknown If Injured "A", "B", "C", "D", or "U"	At least One CDS Applicable Vehicle Was Towed	No CDS Applicable Vehicles Were Towed	Vehicle Involvement		Single CDS Applicable Vehicle	Multiple CDS Applicable Vehicle								Towed	At least Two Towed	Only One Towed					Injury in Towed, LMY, CDS Applicable Vehicle	A	C		E	G	NOT IN SCOPE		Injury not in Towed, LMY, CDS Applicable Vehicle	B	D		F	H	SEE Table 2-2	
Crashworthiness Data System																																																										
Late Model Year (LMY)	FATAL INJURY "K"	Most Severe Police Reported Injury				Injured or Unknown If Injured "B", "C", or "U"	Not Transported																																																			
		Transported		Not Transported			Injured, Not Injured or Unknown If Injured "A", "B", "C", "D", or "U"	At least One CDS Applicable Vehicle Was Towed	No CDS Applicable Vehicles Were Towed																																																	
Vehicle Involvement		Single CDS Applicable Vehicle	Multiple CDS Applicable Vehicle																																																							
		Towed	At least Two Towed	Only One Towed																																																						
Injury in Towed, LMY, CDS Applicable Vehicle	A	C		E	G	NOT IN SCOPE																																																				
Injury not in Towed, LMY, CDS Applicable Vehicle	B	D		F	H	SEE Table 2-2																																																				
OTHER ROAD VEHICLE	For example: (1) pedalcycle impacts parked (not in-intransport) motor vehicle on road, (2) horse-drawn hay wagon loses a wheel ejecting and injuring wagon occupants, or (3) animal carrying a person bolts ejecting and injuring occupant.	For example: pedalcycle impacts vehicle parked in parking stall in a parking lot.																																																								

Stabilization--At times, one police report will contain more than one accident. This will happen when events constituting an accident have stabilized (as defined in ANSI D16.1-1989, section 2.4.4, see figure 2-6, page 24-25) and units involved in the first sequence are subsequently involved in another accident sequence which is recorded on the same police report. If more than one accident is recorded on a police report, based on the ANSI definition of stabilized, then use the following protocol to determine which of the accidents is to be listed and stratified.

First, identify all NASS accidents and exclude from consideration those that are not NASS accidents.

Second, three situations exist (identified below as A, B, and C). Identify the situation that is applicable to the PAR under consideration and follow the protocol provided.

Situation A:

If only one accident qualifies for the CDS (Strata A-H--see section 2.2 below) and one or more GES (General Estimates System) accidents not applicable to the CDS (X Stratum, Y Stratum, or Z Stratum--see section 2.2 below) exist on the same PAR, choose the CDS accident.

Situation B:

If more than one accident qualifying for the CDS exists on the same PAR, follow steps (1) through (4) below to select the CDS accident to stratify. Ignore any GES accidents not applicable to the CDS which may also be on the PAR.

- (1) If injury is involved and you can determine the relative degree of injury between accidents and one accident is of higher severity, then choose that accident.
- (2) If injury is involved and you determine that the relative injury between accidents is approximately equal, then choose the first of the highest equal injury accidents.
- (3) If injury is involved but you cannot determine the relative injury between accidents, then choose the first accident.
- (4) If no injuries, then choose the first accident.

Situation C:

If no accident qualifying for the CDS exists on a PAR but more than one GES accident not applicable to the CDS exists on the PAR, then choose the X Stratum, Y Stratum, or Z Stratum by following the criteria in (1) through (4) above to select the GES accident to stratify.

In those cases where an accident, by NASS criteria, other than the one reported on the PAR, is alluded to (e.g., in the narrative), there is a rebuttable presumption that this PAR is the only PAR that will be submitted to report both accidents. This presumption may be overridden if the researcher has knowledge of: (1) another PAR on file, (2) a statement in the narrative indicating that there is, or will be, another PAR, or (3) the dispatcher or other police personnel having knowledge of the accidents, indicates that there is, or will be, another report filed.

Example: The PAR narrative states: "Vehicle #1 had been struck by an unidentified vehicle that did not stop. As driver of Vehicle #1 opened door

to get out, door caught rear wheels of trailer of Vehicle #2." There is no other mention of the unidentified vehicle which failed to stop anywhere else on the PAR. The PAR contains two separate accidents. The injury severity for both is "no injury"; therefore, the first is used for NASS CDS stratification purposes, independent of the police emphasis on the second.

However, caution must be exercised when separating accidents on a PAR. At times, it will appear that two distinct events of an accident sequence should be considered separately. According to ANSI D16.1-1989, section 2.4.4 (see figure 2-6, page 24), an unstabilization terminates "...when all persons and property are at rest..." "Property" can refer to the damaged vehicles, separated components of the vehicles, or cargo. Often the interviews will be the only source for determining whether or not stabilization occurred before the second event.

Example: Two vehicles collide in the eastbound lanes of a divided trafficway. Cargo from one vehicle spills into the westbound lanes and another vehicle is damaged. If it can be determined that stabilization never occurred (i.e., the cargo struck the vehicle, or the vehicle struck the moving cargo), the two harmful events would be considered one accident, and all three vehicles considered applicable to the NASS accident. If it should be discovered during the research that the cargo came to rest for a period of time prior to being struck by the third vehicle, then the events would be considered as two separate accidents.

2.1.1 Questions and Answers About Which Incidents Qualify for NASS

Please find below a list of questions aimed at helping researchers determine if an accident report qualifies for the NASS.

Question: If a motor vehicle in-transport hits a pothole, causing damage to a tire and wheel or to the exhaust system, is this incident eligible for NASS?

Answer: Yes, it is eligible for NASS. To be eligible, recall that, first, a police report must be filed and, second, that the criteria set forth in ANSI D16.1-1989, section 2.3, have been met. In essence, these criteria mandate that the following occurs: (a) a harmful event (damage or injury), (b) involving a motor vehicle, (c) in-transport, and (d) that the unstabilized situation originated (i.e., control was lost) on a trafficway or the harmful event occurred on a trafficway. If the parties involved suffered damage to the wheels, suspension, exhaust system, or undercarriage of their vehicles, then you have a valid accident for NASS; however, ANSI D16.1-1989, section 2.3.7 (see figure 2-6, page 19) specifically excludes damage from mechanical failure during normal operation. The intent is to exclude a "blow-out" incident where the driver brings the vehicle safely to the side of the road without incurring other damage. This exclusion was not meant to exclude an incident where a "blow-out" led to other vehicle damage (e.g., ran into a tree) while the driver was attempting to regain control.

Question: A man driving a motor home slams on his brakes to avoid another vehicle in his lane; he succeeds. However, his young daughter is thrown against the instrument panel and suffers injury. Is this a motor vehicle accident?

Answer: It is a motor vehicle traffic accident involving one vehicle. The other vehicle is not involved.

Question: A car loses control on a trafficway, leaves the trafficway, and does

damage to a private lawn. There is no damage to the car and the driver is not hurt. Is this a traffic accident?

Answer: Yes! It would also be a traffic accident if the motor vehicle left the scene before the police arrived (i.e., a hit-and-run vehicle). In these situations, the determining factor is whether the police filed an accident report that was eventually reported to the state.

Question: A pulp wood truck is travelling down a public road with an insecure load; the load shifts and all of the wood falls off the truck. The wood bounces and rolls, and then strikes a fence on the side of the road, doing approximately \$500 worth of damage to the fence. There is no damage to anything except the fence and no other vehicles are involved; however, there is a police report made out on the incident, which is eventually included in the state file. Does this incident qualify for NASS?

Answer: Yes this situation does qualify for NASS. The harmful event is the damage to the fence.

Question: A power line falls onto a motor vehicle in-transport, causing personal damage. Is this incident applicable for NASS? A tree falls onto a motor vehicle as it was driving down the road. Is this incident applicable for NASS.

Answer: Both of the above situations, plus many similar ones (e.g., rocks fell onto the vehicle), fall into the category of near cataclysmic events. ANSI D16.1-1989, section 2.4.7 (see figure 2-6, page 23) excludes, from the definition of a transport accident, harmful events resulting from a cataclysm. To further define this exclusion, the cataclysm must have been on-going at the time the accident happened. Cataclysms are defined in ANSI D16.1-1989, section 2.4.5, (see figure 2-6, page 18). Therefore, to exclude the situation of an object (power line, rock, etc.) falling on a motor vehicle in-transport, the cataclysm which caused the object to fall must have been on-going at the time of the incident. In terms of the specific questions, they are NASS accidents.

Question: We have a rare situation where a bystander dropped his gun; it struck the ground and discharged. A bullet struck the windshield of a vehicle in-transport. Should this incident be listed as a motor vehicle accident?

Answer: No, this is a firearms accident. However, it is entirely possible that a firearms accident could trigger a traffic accident.

Question: A convertible is traveling with its top down, and occupants are riding on its boot. The vehicle swerves to avoid another vehicle; one of the occupants falls from the vehicle and is injured. Is this incident a NASS accident?

Answer: Yes, it is a noncollision (as defined in ANSI D16.1-1989, section 2.6.3) type NASS accident.

Question: A tow truck is towing a pickup. The towed pickup truck loses an axle, which subsequently strikes a vehicle parked in a parking lot. Is this a NASS accident?

Answer: Yes it is. A motor vehicle in-transport loses part of its cargo (axle of pickup), which strikes (harmful event) a vehicle not in-transport.

Question: A motor vehicle, parked in a driveway, slipped out of gear, rolled down the drive, crossed the street, and struck a tree on the other side. Is this an applicable accident?

Answer: It depends on the location of the vehicle when control was lost and the location when the harm occurred. To be an applicable NASS accident, the control must have been lost on a trafficway or the harmful event must have occurred on a trafficway. If the vehicle was up in its driveway (i.e., outside of the trafficway--it must be clearly beyond the curb, utility poles, or any sidewalk boarding the curb), then control was lost (i.e., control is assumed lost when the gears slipped) off a trafficway. If the tree that was struck was off the trafficway (same as above), then it is not an applicable NASS accident and whether the vehicle is on or off the roadway at impact is irrelevant. Given that you have to make a decision at the police station (must have a police report to start with), scrutinize the police report for any information which would help you in determining the locations of the key elements. If the police report is uninformative concerning these key elements, include the accident for listing purposes. If selected in the NASS CDS sample, a review of the scene should determine whether or not the accident remains.

2.2 NASS PAR Sampling

Before a NASS accident, represented by a PAR, can be selected for research in either the CDS or the GES (GENERAL ESTIMATES SYSTEM) it must first be listed with all other qualifying PARs (the process of listing PARs is described in Section 3.2). From the listed PARs a CDS and a GES sample will be chosen.

To increase the efficiency of the samples, qualifying PARs are grouped into sampling Strata based on accident outcome, and the samples are selected. The information used to stratify the PARs is found in the police report itself and includes the following five sampling variables.

2.2.1 Sampling Variables

Type of Vehicle is the indication on the police report of the types of vehicles involved in the NASS accident. Vehicles are classified as either "CDS applicable vehicles", "Medium/heavy trucks", or as "other vehicles". CDS applicable vehicles include the vehicle types: automobile, automobile derivative and short utility vehicles, van based light trucks, and light conventional trucks where the qualifying trucks must have a gross vehicle weight rating (GVWR) of less than or equal to 10,000 pounds. The exact distinction among a CDS applicable vehicle, a medium/heavy truck, and an other vehicle is defined in terms of the variable Body Type (GV07). CDS applicable vehicles are in-transport vehicles whose Body Type (GV07) equals: "01" through "49". Medium/heavy trucks are in-transport vehicles whose Body Type (GV07) equals: "60" through "69". Other vehicles are in-transport vehicles whose Body Type (GV07) equals: "50" through "59" and "70" through "99". If there is no indication by the police officer of the type of vehicles involved in the NASS accident (e.g., a hit-and-run accident), then classify the vehicle as an other vehicle (GV07="99").

Where Body Type (GV07) is known but not distinguishable on the PAR for CDS applicable vehicle identification purposes (e.g., "passenger car", "truck", "van"), refer to your VIN reference materials to decode the VIN if the VIN is present, or refer to other sections (i.e., diagram, narrative, etc.) of the PAR that may provide identifying information. If the VIN is not present and GV07 is still unknown, then consider, for sampling purposes, the GV07 code to be: "09"

if the PAR only indicates that a passenger car was involved; "29" if the PAR only indicates that a van was involved; "39" if the PAR only indicates that a pickup was involved; "48" if the PAR indicates truck without reference to pickup or van and the GVWR is known to be less than 10,000 pounds; or "49" if the vehicle's Body Type (automobile, light truck or van) is unknown but the GVWR is known to be less than 10,000 pounds. Consider the vehicle in question to be a CDS applicable vehicle. If the PAR indicates that the vehicle's Body Type is a truck but does not reference the GVWR, then consider the GV07 code to be "69", and consider the vehicle in question to be a non-CDS applicable vehicle (medium/heavy truck).

Most severe police reported injury is the indication on the police report of injury severity, if any, to any person involved in the NASS accident. Each person's severity should be translated into the KABCO codes, if necessary (see explanation of variable OA34 of this manual).

For purposes of stratification, the CDS is only concerned with the most severely injured occupant of any towed CDS applicable vehicle. The injury severity to persons not in a towed CDS applicable vehicle is not considered. On the other hand, the GES is concerned with the most severely injured person in the NASS accident.

Disposition of the injured is the indication on the police report that at least one occupant not sustaining a "K" injury of a towed CDS applicable vehicle went directly from the accident scene to a treatment facility (hospital, clinic, doctor's office, etc.) for treatment (e.g., not transported solely to have a blood alcohol test conducted). The means of transportation is not a consideration nor is the length of stay at the facility.

For purposes of stratification, the CDS is only concerned with the transportation of occupants of towed CDS applicable vehicles who did not sustain a "K" injury. The transportation of any one occupant of a towed CDS applicable vehicle, not sustaining a "K" injury, qualifies the NASS CDS accident as "transported". The transportation or nontransportation of any person who: (1) sustained a "K" injury or (2) was not in a towed CDS applicable vehicle, is not considered. On the other hand, the GES does not consider the disposition of the injured for sampling purposes.

If the PAR does not indicate the disposition of the injured occupant(s) of the towed CDS applicable vehicle(s), then consider the NASS accident as having no transported occupants.

Tow status of the vehicles is the indication on the police report that an in-transport vehicle involved in the NASS accident was towed due to damage from the accident scene. Any item on the PAR may be used to help determine tow status (e.g., damage severity, narrative). If no CDS applicable vehicle is indicated on the police report as towed due to damage from the accident scene, then the NASS accident is not of interest to the CDS, but is classified in the GES as either a X Stratum, Y Stratum or Z Stratum accident. However, there is an exception. Even if the police report indicates that an in-transport CDS applicable vehicle was towed from the scene due to damage and the only harmful event occurring to this vehicle is a noncollision which resulted from a fire, explosion, an intraunit damage (other than a jackknife), or a noncollision injury, then do not consider this vehicle as "towed due to damage" for CDS stratification purposes.

Unfortunately, PARs do not identify with one-hundred percent certainty which

towed vehicles were towed as a result of damage. Therefore, when a vehicle is listed on the police accident report as towed, the default assumption is that the vehicle was towed due to damage. In addition, the PAR may be blank or unclear as to whether the vehicle was towed at all. If so, use the default assumption that the vehicle was not towed.

Model Year of Vehicle is the indication on the police report of each accident involved vehicle's production (model) year. The production year is not necessarily the same as the actual calendar year in which the vehicle was produced. For purposes of CDS stratification, all in-transport vehicles are separated into either "late model year vehicles" or "nonlate model year vehicles". In calendar year 1991 a late model year vehicle is one whose production year is 1987 through 1992. Any vehicle whose production year is 1986 or before is considered a nonlate model year vehicle. GES does not consider the model year of the vehicles.

2.2.2 Sampling Strata

The eight PAR sampling Strata used by the CDS are listed below and shown in Table 2-1.

Stratum A-NASS accidents in which at least one occupant of a towed CDS applicable late model year vehicle had a police reported injury of "K" (fatal injury).

Stratum B-NASS accidents not qualifying for Stratum A in which at least one occupant of a towed CDS applicable nonlate model year vehicle had a police reported injury of "K" (fatal injury).

Stratum C-NASS accidents not qualifying for Strata A or B in which at least one occupant of a towed CDS applicable late model year vehicle had a police reported injury of "A" (incapacitating injury) AND was transported to a treatment facility for treatment. If the accident involved more than one CDS applicable vehicle, then at least two CDS applicable vehicles must be towed.

Stratum D-NASS accidents not qualifying for Strata A, B, or C in which at least one occupant of a towed CDS applicable nonlate model year vehicle had a police reported injury of "A" (incapacitating injury) AND was transported to a treatment facility for treatment. If the accident involved more than one CDS applicable vehicle, then at least two CDS applicable vehicles must be towed.

Stratum E-NASS accidents not qualifying for Strata A, B, C, or D in which at least one occupant of a towed CDS applicable late model year vehicle was transported to a treatment facility for treatment.

Stratum F-NASS accidents not qualifying for Strata A, B, C, D, or E in which at least one occupant of a towed CDS applicable nonlate model year vehicle was transported to a treatment facility for treatment.

Stratum G-NASS accidents not qualifying for Strata A, B, C, D, E, or F which involve at least one CDS applicable late model year vehicle that was towed from the scene.

Stratum H-NASS accidents not qualifying for Strata A, B, C, D, E, F, or G which involve at least one CDS applicable nonlate model year vehicle that

TABLE 2-1

1991 NASS CDS Strata

Late Model Year (LMY)	Most Severe Police Reported Injury					
	F A T A L INJURY	Transported			Not Transported	
Vehicle Involvement		"K"	Single CDS Applicable Vehicle	Multiple CDS Applicable Vehicles	Injured or Unknown If Injured "B", "C", or "U"	Injured, Not Injured or Unknown If Injured "A", "B", "C", "O", or "U"
	Towed		At Least Two Towed	Only One Towed		At least One CDS Applicable Vehicle Was Towed
Injury in Towed, LMY, CDS Applicable Vehicle	A	C		E	G	NOT IN SCOPE
Injury not in Towed, LMY, CDS Applicable Vehicle	B	D		F	H	See Table 2-2

Note: Late Model Year refers to 1987 through 1992 model years.

TABLE 2-2

1991 NASS GES Strata/Non-CDS Accidents

No Towed CDS Applicable Vehicles in this Accident		
Most Severe Police Reported Injury to Any Occupant, Pedestrian, or Nonmotorist		
Medium/Heavy Truck	No Trucks	Other
Towed Non-CDS Vehicle "OR" PAR Code of: "K", "A", or "B"	PAR Code of: "K", "A", or "B"	PAR Code of: "C", "U", or "O"
X	Y	Z

DESCRIPTION OF THE SAMPLING FRAME

was towed from the scene.

All other NASS accidents that do not qualify for Strata A, B, C, D, E, F, G, or H are further separated for the purposes of the **General Estimates System (GES)** into either the X Stratum, Y Stratum, or the Z Stratum. See Table 2-2 above. The **GES** includes all NASS accidents. The four main columns of the Stratification Record are: No Trucks (Strata A-H); Medium/Heavy Trucks (Strata A-H, X); Other Injury (Stratum Y) and; Other (Stratum Z).

Be aware that all CDS applicable accidents are also GES applicable accidents while the converse is not true (i.e., the majority of GES applicable accidents are not CDS applicable). Non-CDS accidents are classified as follows:

X Stratum-NASS accidents not qualifying for the CDS Strata, involving at least one medium or heavy truck in which a non-CDS vehicle was towed due to damage, or at least one involved person had a police reported injury of "K" (fatal injury), "A" (incapacitating injury), or "B" (nonincapacitating injury).

Y Stratum-NASS accidents not qualifying for the CDS Strata or X Stratum in which none of the vehicles involved in the accident was a medium or heavy truck and at least one person involved in the accident had a police reported injury of "K" (fatal injury), "A" (incapacitating injury), or "B" (nonincapacitating evident injury).

Z Stratum-NASS accidents not qualifying for the CDS Strata, X Stratum, or Y Stratum.

Notice that the eight CDS PAR sampling Strata are hierarchical. PARs included in Stratum A are not considered for Strata B, C, D, E, F, G, or H and so forth. Therefore, in reviewing PARs for stratification, proceed as follows:

First, identify all in-transport CDS applicable vehicles in the NASS accident. If no in-transport CDS applicable vehicles were present, then classify this NASS accident for GES purposes into either the X Stratum, Y Stratum, or the Z Stratum.

Second, from among the CDS applicable vehicles present in the NASS accident, identify those the police accident report indicates were "towed" as a result of damage received in this NASS accident; however, exclude towed CDS applicable vehicles whose only event is a nonqualifying noncollision event. If no in-transport "towed" CDS applicable vehicles were present in this NASS accident, then classify this NASS accident for GES purposes into either the X Stratum, Y Stratum, or the Z Stratum.

Third, if at least one in-transport towed CDS applicable vehicle was present, then determine the most severe police reported injury to the occupant(s) of all towed CDS applicable vehicles present. If one or more occupants of a towed CDS applicable vehicle was killed ("K" injury), then classify this NASS accident in:

- o Stratum A if at least one of the killed persons was an occupant of a late model year vehicle; or
- o Stratum B if no killed person was an occupant of a late model year vehicle.

Fourth, if no occupant of a towed CDS applicable vehicle was killed, but at least one occupant of a towed CDS applicable vehicle received an "A" injury, then determine if one or more of those receiving an "A" injury was transported to a medical facility for treatment purposes. If only one CDS applicable vehicle was

DESCRIPTION OF THE SAMPLING FRAME

present and it was towed due to damage and an occupant received an "A" injury and was transported, then classify this NASS accident in:

- o Stratum C if at least one of the transported, "A" injured persons was an occupant of a late model year vehicle; or
- o Stratum D if no transported, "A" injured person was an occupant of a late model year vehicle.

If two or more CDS applicable vehicles were present, then at least two must be towed due to damage. Therefore, if at least two CDS applicable vehicles were present and at least two were towed due to damage and one of the towed CDS applicable vehicles had an occupant who received an "A" injury and was transported, then classify this NASS accident in:

- o Stratum C if at least one of the transported, "A" injured persons was an occupant of a late model year vehicle; or
- o Stratum D if no transported, "A" injured person was an occupant of a late model year vehicle.

However, if two or more CDS applicable vehicles were present, but only one was towed due to damage and an occupant received an "A" injury and was transported, then classify this NASS accident in:

- o Stratum E if at least one of the transported, "A" injured persons was an occupant of a late model year vehicle; or
- o Stratum F if no transported, "A" injured person was an occupant of a late model year vehicle.

On the other hand, if no "A" injured occupant was transported to a medical facility for treatment purposes, then classify this NASS accident in:

- o Stratum G if at least one of the "A" injured persons was an occupant of a late model year vehicle; or
- o Stratum H if no "A" injured person was an occupant of a late model year vehicle.

Fifth, if the most severe police reported injury to any occupant(s) of the towed CDS applicable vehicle(s) present was a "B", "C", or "U" injury, then determine if one or more of those receiving "B", "C", or "U" injuries was transported from the scene to a medical facility for treatment purposes. If at least one "B", "C", or "U" injured occupant was transported to a medical facility for treatment purposes, then classify this NASS accident in:

- o Stratum E if at least one of the transported, "B", "C", or "U" injured persons was an occupant of a late model year vehicle; or
- o Stratum F if no transported, "B", "C", or "U" injured person was an occupant of a late model year vehicle.

Sixth, if no "B", "C", or "U" injured occupant of a towed CDS applicable vehicle was transported to a medical facility for treatment purposes, then classify this NASS accident in:

- o Stratum G if at least one of the "B", "C", or "U" injured persons was an occupant of a late model year vehicle; or
- o Stratum H if no "B", "C", or "U" injured person was an occupant of a late model year vehicle.

Seventh, if the PAR indicates that no occupant of a towed CDS applicable vehicle was injured (PAR "O" classification), then classify this NASS accident in:

- o Stratum G if there was at least one person who was an occupant of a late model year vehicle; or
- o Stratum H if no person was an occupant of a late model year vehicle.

DESCRIPTION OF THE SAMPLING FRAME

The three non-CDS PAR sampling Strata (X Stratum, Y Stratum and Z Stratum) used by the GES are distinguished as follows.

- o Given that no in-transport towed CDS applicable vehicles are present in the NASS accident, determine if at least one medium or heavy truck was involved in the accident in which a non-CDS vehicle was towed or if any person in the accident received a "K" (fatal injury), "A" (incapacitating injury), or "B" (nonincapacitating evident injury) injury. If so, then classify this NASS accident in the X Stratum.
- o If no medium or heavy truck was involved in the accident but at least one person received a "K", "A", or "B" injury, then classify this NASS accident in the Y Stratum.
- o If no person received a "K", "A", or "B" injury, then classify this accident in the Z Stratum.

It does not matter for the purpose of distinguishing between the X Stratum, Y Stratum, and the Z Stratum whether any person was transported or the vehicles involved are either late model or non-late model year. Also, the tow status is not considered when distinguishing between the Y Stratum and the Z Stratum.

Figure 2-8 presents a flowchart of the NASS stratification.

Examples:

1. NASS Accident: A heavy truck (other vehicle: GV07=60-69) and a motorcycle (other vehicle: GV07=70-79) crash. The driver of the motorcycle is killed.

Stratification: This is a "X Stratum" accident because it does not involve a towed CDS applicable vehicle (i.e., GV07 must be "01" through "49"), and one of the non-CDS vehicles is a medium/heavy truck, and a PAR reported "K" injury occurred.

2. NASS Accident: A late model year CDS applicable vehicle and a motorcycle (other vehicle) crash. The CDS applicable vehicle is towed, the driver has an "A" injury, and was transported to a medical facility for treatment. The motorcyclist is killed ("K" injury).

Stratification: This is a Stratum "C" accident. It has one CDS applicable vehicle, and the CDS applicable vehicle was towed. The most severe injury to an occupant of a towed CDS applicable vehicle is an "A" injury and the "A" injured occupant was transported. The injured person was an occupant of a late model year CDS applicable vehicle. The injury to the motorcyclist is not considered.

3. NASS Accident: A CDS applicable vehicle rolls over ejecting and causing a "K" injury to one of the occupants; the nonlate model year vehicle is towed.

Stratification: This is a Stratum "B" accident because it does have a towed CDS applicable vehicle, the most severely injured occupant of the vehicle receives a "K" injury, and the fatally injured person is not an occupant of a late model year CDS applicable vehicle.

FIGURE 2-8

NASS Stratification

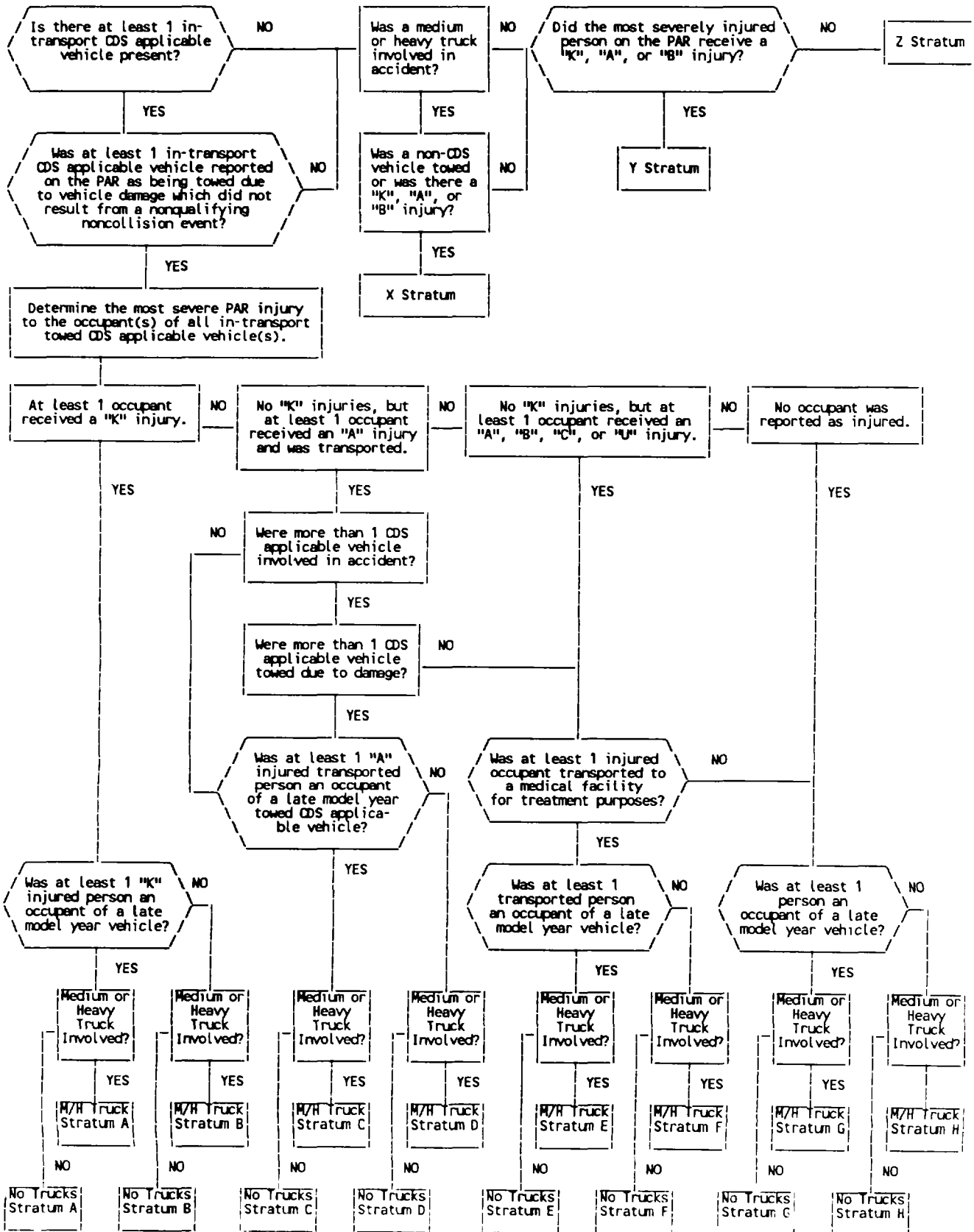

4. NASS Accident: A CDS applicable vehicle and a bicycle crash. The bicyclist ejects shattering the vehicle's windshield. The nonlate model year CDS applicable vehicle is towed, but only minor injuries ("C" injuries) occur to the occupants. None of the occupants are transported. The bicyclist receives an incapacitating injury ("A" injury).

Stratification: This is a Stratum "H" accident. There is one towed CDS applicable vehicle, but no one in a towed CDS applicable vehicle receives a "K" injury or is transported. The most severely injured person in the towed CDS applicable vehicle is not an occupant of a late model year vehicle. The incapacitating injury to the bicyclist does not affect the stratification. The only injuries that affect stratification are those suffered by occupants of towed CDS applicable vehicles.

5. NASS Accident: Two CDS applicable vehicles crash. Vehicle 1, which is a late model year vehicle, is towed, but none of the occupants are injured. Vehicle 2, which is not a late model year vehicle, is not towed; however, an unbelted infant hits the instrument panel and receives an "A" (incapacitating) injury.

Stratification: This is a Stratum "G" accident. Stratification is determined first by the most severe injury to an occupant in a towed CDS applicable vehicle and second by the model year of the most severely injured occupant's vehicle. Vehicle model year and most severe police reported injury are not independent variables for stratification purposes.

6. NASS Accident: A heavy truck and two CDS applicable vehicles crash. The heavy truck catches on fire and its occupant subsequently dies of burn injuries. Both CDS applicable vehicles are towed. One CDS applicable vehicle is a late model year vehicle, and its occupant receives a "C" injury. The other CDS applicable vehicle is not a late model year vehicle, and its occupant receives a "B" injury. All occupants are transported for treatment.

Stratification: This is a Stratum "E" accident involving a medium or heavy truck. The most severe injury to the occupant of the towed CDS applicable late model year vehicle determines the Stratum.

2.2.3 Questions and Answers Regarding Stratification

The following questions are aimed at helping researchers classify CDS accidents.

Question: A vehicle ran off the road, struck a small tree, and continued on, eventually striking a pedalcyclist. Would this be considered a motor vehicle accident, since ANSI requires that in a pedalcycle accident (section 2.4.14, page 16), the first harmful event must involve a collision with a pedalcyclist?

Answer: In CDS we are concerned with the definition of a motor vehicle traffic accident (MVTA) as defined in ANSI D16.1-1989, section 2.4.20 (see figure 2-6, page 21). The components of a MVTA are: (a) a police report, (b) a harmful event, (c) from an unstabilized situation, (d) involving at least one motor vehicle, (e) in-transport [in motion or on a roadway], such that (f) the harmful event occurred on a trafficway or the unstabilized situation originated on a trafficway. Beyond this, we are not concerned with subdividing accidents according to ANSI. For this accident to be stratified in Strata A, B, C, D, E, F, G, or H, the vehicle must have been a "CDS applicable vehicle", and it must have been towed, according to the police

report, as a result of the damage it sustained in the accident. In addition, consider the most severe police reported injury to an occupant of a towed CDS applicable vehicle, the transported status of the occupant(s) of only the towed CDS applicable vehicle(s), and the vehicle model year of the vehicle in which the most severely injured person was an occupant. If the accident does not involve a towed CDS applicable vehicle, classify it as "all other NASS accidents" (X Stratum, Y Stratum, or Z Stratum).

Question: When a hit-and-run accident occurs which involves a single in-transport vehicle, and no information is available about the hit-and-run vehicle or its occupant(s), how do you classify the accident on the stratification record?

Answer: Stratify the PAR as a Z Stratum accident since no information about the vehicle is equivalent to GV07, Body Type, equalling "99" (Unknown), and no information about the occupant(s) does not equate to a known "K", "A", or "B" injury which is required in order to classify the accident in the Y Stratum.

Question: How do you stratify a vehicle not in-transport? The vehicle is unoccupied.

Answer: Vehicles not in-transport are not considered when determining the PAR sampling Stratum.

Question: It is, at times, difficult to determine whether or not a parked vehicle was on the roadway from simply reviewing a police accident report. Usually, the PAR merely states that the vehicle was parked. Unless one is familiar with the roadway, how do you determine if the vehicle was in-transport or not?

Answer: Vehicles which are legally parked are not in-transport. In certain situations illegally parked vehicles are in-transport; however, the fact that a vehicle was illegally parked when struck has never automatically made that vehicle in-transport.

Originally, this issue was resolved for bus zones. Figure 2-9 presents six bus stop parking area situations which were discussed and resolved over two zone center seminars. For situations I through V any vehicle in the bus zone was considered in-transport. In situation VI a non-bus in the bus zone was considered in-transport. The mid-block bus zone concept was extended as well to fire hydrants located mid-block.

More recently, the question of vehicles illegally parked beyond the end of legal parking (either implicit or explicit) near an intersection was considered. The resolution is that if a vehicle is illegally parked because of time, then the vehicle is not in-transport. If a vehicle is illegally parked because of location, then the vehicle is in-transport. One major exception is when time changes the character of the parking location. See Figure 2-3 above. If any part of a struck vehicle is beyond the end of legal parking, then this vehicle is in-transport. This means that any vehicle not authorized to be in a bus zone, fire hydrant zone, loading/unloading zone, NO PARKING area, or yellow curbed area is in-transport regardless of where that area is located (i.e., end of block or mid-block).

FIGURE 2-9

Bus Stop Parking Area Situations I - VI

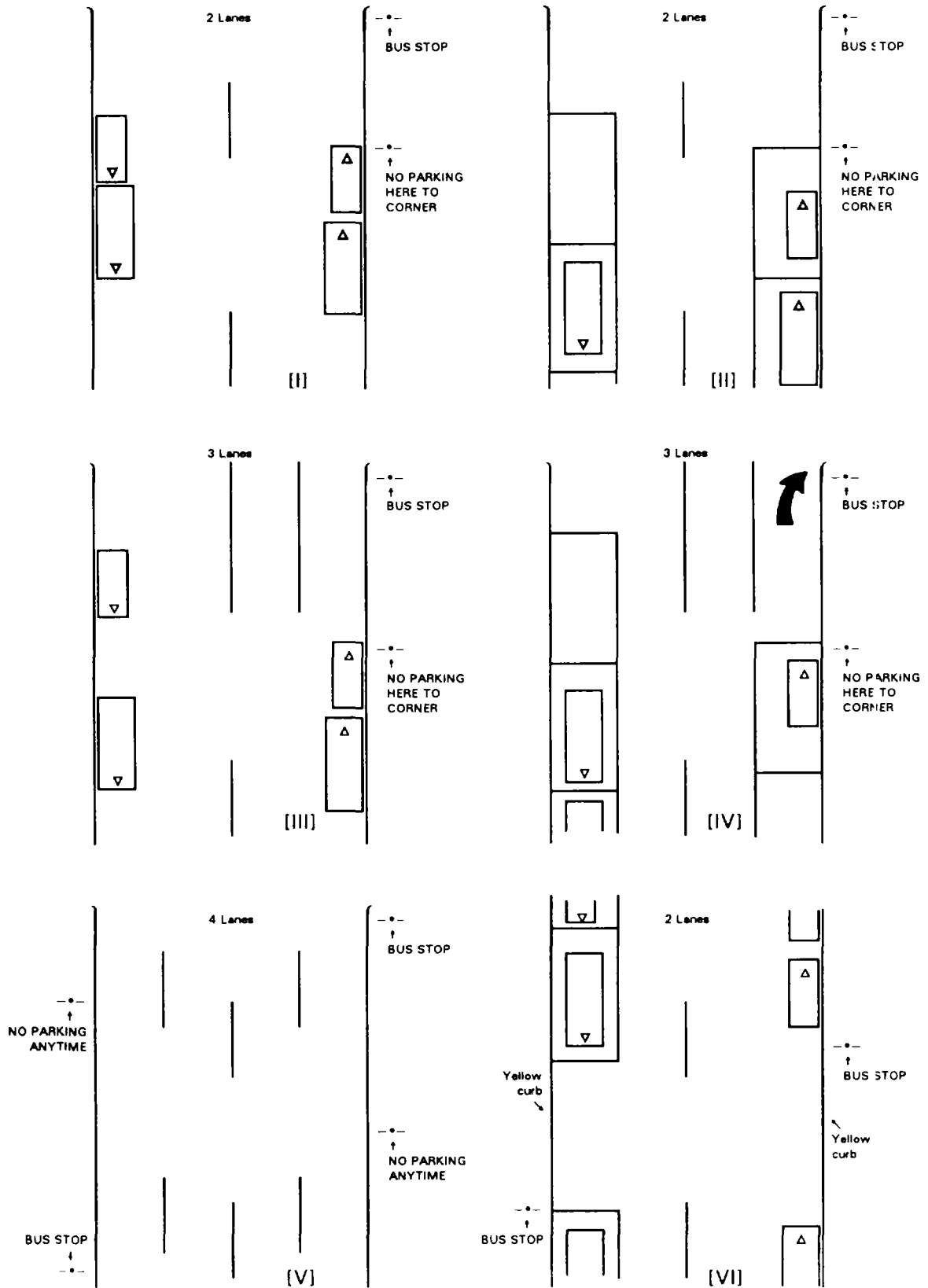

For CDS sampling purposes, the PAR scene sketch should be used in conjunction with the violations issued section to determine if a vehicle was illegally parked because of location.

Illegal parking includes any occupied vehicle which is stopped in an illegal location. Any vehicle entering or exiting one of the above mentioned areas (i.e., bus zone, fire hydrant zone, loading/unloading zone, NO PARKING zone, or yellow curbed area) is, of course, in-motion and thus in-transport.

Question: A vehicle had several persons riding on top of it. The police spotted the vehicle and started to give chase. The persons jumped off. In the process, one was injured. Is this person an occupant or a nonmotorist? What about the vehicle and its occupants?

Answer: The persons riding on the roof do not fit the appended-to-the-vehicle-for-motion exclusion (e.g., person on a bicycle or skateboard who is holding onto the back of a vehicle for added motion) cited under variables OA04, Occupant Number, and OA10, Occupant's Seat Position; therefore, these persons are occupants of the in-transport vehicle. Regarding the injured person, if that injury (harmful event) occurred as a result of exiting from the vehicle, then stabilization did not occur for that person. Therefore, in addition to those in the vehicle, consider the person who was injured while jumping from the vehicle as an occupant also. Since the police would not report the vehicle as towed due to damage, it makes no difference whether the vehicle was a CDS applicable vehicle or not. The Y Stratum or the Z Stratum would be assigned to this PAR depending upon the police report injury severity.

Question: A pickup truck was towing (pulling) a friend's passenger car to a service station. The car broke loose and impacted a tree. No damage occurred to the pickup. How would you stratify for CDS purposes this NASS accident?

Answer: Any motor vehicle on a roadway is in-transport. An exception occurs where the vehicle is attached to another vehicle by means of fixed linkage. The critical issue is whether or not the vehicle being towed has any control over its movement. In this instance, the answer depends on how the car and truck were attached. If the car was attached by a tow bar or any other form of fixed linkage, then the car is considered a trailing unit and the tow status of that vehicle is not considered when stratifying. On the other hand, if the linkage was nonfixed (e.g., rope, chain, etc.), then the car was in-transport, and its police reported tow status is considered. A fixed linkage is defined as one which has the property of keeping the towed unit separated from the power unit by a distance which is essentially constant. Included within this definition are cradle linkages where the towed unit has two or more wheels off the ground. If the linkage was fixed this is a Y Stratum or a Z Stratum accident since the pickup would not be reported by the police as towed due to damage. If the linkage was nonfixed and if the car was reported by the police as towed due to damage, then the accident qualifies for CDS Strata A, B, C, D, E, F, G, or H.

Question: How do you stratify fatal occupants of CDS applicable vehicles for which the PAR includes the annotations "heart attack", "gunshot wound", or other disease or nonaccident injury?

DESCRIPTION OF THE SAMPLING FRAME

Answer: There must be medically supported or other positive information on the PAR which indicates that an occupant of a CDS applicable vehicle died of a disease or nonaccident inflicted injury. If such information is present on the PAR, then consider this person's injury as Unknown ("U") for stratification purposes. Otherwise, consider that the occupant died due to accident inflicted injuries.

3.0 OVERVIEW OF SAMPLING ACTIVITIES

The procedure for selecting the NASS CDS accident sample consists of three tasks:

- Task 1: Contact sampled police jurisdictions on specified days to review the police accident reports (PARs).
- Task 2: At each jurisdiction, list and stratify, using the NASS Stratification Record (SR), all PARs which qualify for NASS (CDS and GES). First, classify each into one of the four main columns on the NASS SR. Second, if the NASS accident is CDS applicable, then classify it into one of the eight CDS Sampling Strata.
- Task 3: Using the Microcomputer Data Entry (MDE) system, enter the listed PARs (CDS and GES) into the NASS CDS Automated Case Selection System. The automated system will specify the sample of CDS accidents to be researched.

Most teams will perform these tasks on Monday and Thursday of each week. Alternatively, a few teams will perform these tasks on Tuesday and Friday of each week. Still other teams will sample only on Mondays or more than twice a week. Section 3.2 below discusses the Monday-Thursday example. However, the procedure to be followed is the same regardless of the schedule.

3.1 Listing and Sampling Forms

The Contact Day Assignment Sheet (CDAS) and the PAR Stratification Record (SR) are attached as examples.

3.1.1 Contact Day Assignment Sheet (CDAS)

The Contact Day Assignment Sheet (Table 3-1) provided to your PSU is unique to your PSU. It specifies the dates on which the contacts are to be made and indicates the Max Sample (maximum caseload) for each contact day. The CDAS must be initialed by a COTR and by Sample Design staff from the Mathematical Analysis Division.

3.1.2 PAR Stratification Record (SR)

All teams will use the same PAR Stratification Record form (Table 3-2). Make photocopies as needed of the form provided. Instructions for completing the form are given in Section 3.2.2.

3.2 Listing and Sampling Instructions

3.2.1 Contacting Police Jurisdictions

Contact each of the jurisdictions on the day(s) of the week specified. For most teams, the jurisdictions are given in two different visitation patterns. For example, some jurisdictions are to be contacted on both Monday and Thursday while others are to be contacted on either Monday or Thursday (i.e., only one visit each week). If a team wishes to change the contact day for any jurisdiction, it must notify both its respective zone center and COTR for approval to implement the change.

TABLE 3-1

1 9 9 1 N A S S

C O N T A C T D A Y A S S I G N M E N T S H E E T

P S U		Period	
13 - Muskegon MI		01-Jan-91	to 30-Jun-91
Contact Date		Contact Date	
07-Jan-91		08-Apr-91	
14-Jan-91		15-Apr-91	
21-Jan-91		22-Apr-91	
28-Jan-91		29-Apr-91	
04-Feb-91		06-May-91	
11-Feb-91		13-May-91	
18-Feb-91		20-May-91	
25-Feb-91		27-May-91	
04-Mar-91		03-Jun-91	
11-Mar-91		10-Jun-91	
18-Mar-91		17-Jun-91	
25-Mar-91		24-Jun-91	
01-Apr-91			

Max Sample: 6 Maximum Cases per Contact Day

Approved--MAD:

Approved--COTR:

Date: 27-Nov-90

TABLE 3-2

**NASS CRASHWORTHINESS DATA SYSTEM
and
GENERAL ESTIMATE SYSTEM**

PAR STRATIFICATION RECORD

Page of

PSU:	JURISDICTION:	LISTED BY:	CONTACT DATE: / /			
PAR INFORMATION		(1)	(2)	(3)	(4)	
		NO TRUCKS	MEDIUM OR HEAVY TRUCKS	OTHER INJURY	OTHER	
		Strata A, .H	Strata A, H,X	Stratum Y	Stratum Z	
		Interval:	Interval.	Interval	Interval	
		Carryover.	Carryover	Carryover	Carryover	
Date	Time	Number	Line No.	Stratum	Line No.	
-	-91					
-	-91					
-	-91					
-	-91					
-	-91					
-	-91					
-	-91					
-	-91					
-	-91					
-	-91					
-	-91					
-	-91					
-	-91					
-	-91					
-	-91					
-	-91					
-	-91					
-	-91					

Page Totals: (No Trucks) A-H= (Trucks) A-H= X= Y= Z=
 Day Totals: A-H= A-H= X= Y= Z=

Page Totals:

A=	C=	F=	G=	X=	Z=
B=	D=	F=	H=	Y=	

 Day Totals:

A=	C=	E=	G=	X=	Z=
B=	D=	F=	H=	Y=	

3.2.2 Completing the PAR Stratification Record

At each police jurisdiction, follow the guidelines in Section 2 (2.0-2.2) to identify the PARs which qualify as NASS accidents and are to be listed. Complete the PAR Stratification Record as follows:

- A. At the top of the SR enter the contact date and the name or initials of the team member making the visit.

- B. GES Carryover:

On or before the first 1990 contact day, four random numbers, one for each main column, will be provided by NCSA. Enter the random numbers on the GES Carryover line for the appropriate main column. The random numbers constitute this jurisdiction's initial GES Carryover values and serve to ensure that all PARs have an equal chance of selection. On each subsequent 1990 contact day, the GES Carryover entered at the top of the SR will be equal to the last Line Number listed for that main column on the previous contact day.

- C. GES Interval:

On or before the first 1990 contact day, a supply of Stratification Records will be provided. These Stratification Records will have the following information: (1) PSU Number, (2) PJ Number and Name, and (3) four GES Interval values, one for each main column. The GES Interval is used to indicate which PARs are sampled. When the Line Number matches the GES Interval for that stratum, "highlight" that accident with a yellow marker and make the next line number, number 1. Line numbers will never exceed the GES Interval for that main column. The highlighted lines represent the sampled PARs for the GES.

Example: If the GES Interval for the "No Trucks" column is 4, then enter the line numbers: 1, 2, 3, 4*, 1, 2, 3, 4*, etc. Every time the line number 4 is recorded, that PAR is highlighted (*). If the GES Interval is 1, meaning every PAR in that column is sampled, highlight only the line numbers.

- D. Line Number:

For each contact day the first line number entered for a main column will be one more than the GES Carryover for that main column unless the GES Carryover is equal to the GES Interval in which case the first line number is: number 1. Except for the first 1990 contact day, the GES Carryover is equal to the last line number listed for that main column on the previous day or page.

Example: If the last line number used for the "No Trucks" column on the previous contact day is 3, the GES Carryover for the CDS column on this day will be 3. The first NASS CDS accident listed for the CDS column this day will have a line number 4.

Similarly, within a single contact day, the GES Carryover is used from page to page and must be entered for all main columns when a new PAR SR is started. Verify the carryover by checking the last line number on the previous page for that main column; these numbers must be the same.

OVERVIEW OF SAMPLING ACTIVITIES

In addition, record the GES Carryover number at the top of each main column on the page to be used for the next visit to that jurisdiction.

E. For each qualifying PAR:

First, identify all in-transport CDS applicable vehicles in the NASS accident. If no in-transport CDS applicable vehicles were present, then follow the procedures below in subsection "E. 2." and classify this NASS accident for GES purposes into either the X Stratum, Y Stratum, or the Z Stratum.

Second, from among the CDS applicable vehicles present in the NASS accident, identify those the police accident report indicates were "towed" as a result of damage received in this NASS accident; however, exclude towed CDS applicable vehicles whose only event is a nonqualifying noncollision event. If no in-transport "towed" CDS applicable vehicles were present in this NASS accident, then follow the procedures below in subsection "E. 2." and classify this NASS accident for GES purposes into either the X Stratum, Y Stratum, or the Z Stratum.

Third, if at least one in-transport, towed CDS applicable vehicle was present and a medium or heavy truck was not involved, then follow the procedures below in subsection "E. 1." and classify this NASS accident for CDS purposes into one of the eight CDS Strata under "No Trucks" column. If at least one in-transport, towed CDS applicable vehicle was present and a medium heavy truck was involved, then follow the procedures below in subsection "E.1." and classify this NASS accident for CDS purposes into one of the eight CDS Strata under the "Medium or Heavy Truck" column.

1. Determine the CDS sampling Stratum:

- a. Determine if at least one occupant of a towed CDS applicable late model year vehicle involved in the accident was killed ("K" injury),
 - (1) If so, it belongs in Stratum A.
 - (2) If not,
- b. Determine if at least one occupant of a towed CDS applicable nonlate model year vehicle involved in the accident was killed ("K" injury),
 - (1) If so, it belongs in Stratum B.
 - (2) If not,
- c. Determine if at least one occupant of a towed CDS applicable late model year vehicle involved in the accident had an "A" injury,
 - (1) If so, then determine if any "A" injured occupant was transported to a medical facility for treatment purposes [go to (a) below],
 - (2) If not, then proceed to E. 1. d. below,
 - (a) If so, recall, first, how many CDS applicable vehicles were present in the accident and, second, how many towed CDS applicable vehicles were present [go to (c) below],

OVERVIEW OF SAMPLING ACTIVITIES

- (b) If not, then proceed to E. 1. d. below,
 - (c) If only one CDS applicable vehicle was present and it was towed, then it belongs in Stratum C.
 - (d) If more than one CDS applicable vehicle was present and two or more CDS applicable vehicles were towed, then it belongs in Stratum C.
 - (e) If more than one CDS applicable vehicle was present but only the late model year CDS applicable vehicle which contained the transported "A" injured occupant was towed, then it belongs in Stratum E.
- d. Determine if at least one occupant of a towed CDS applicable nonlate model year vehicle involved in the accident had an "A" injury,
- (1) If so, then determine if any "A" injured occupant was transported to a medical facility for treatment purposes [go to (a) below],
 - (2) If not, then proceed to E. 1. e. below,
 - (a) If so, recall, first, how many CDS applicable vehicles were present in the accident and, second, how many towed CDS applicable vehicles were present [go to (c) below],
 - (b) If not, then proceed to E. 1. e. below,
 - (c) If only one CDS applicable vehicle was present and it was towed, then it belongs in Stratum D.
 - (d) If more than one CDS applicable vehicle was present and two or more CDS applicable vehicles were towed, then it belongs in Stratum D.
 - (e) If more than one CDS applicable vehicle was present but only the nonlate model year CDS applicable vehicle which contained the transported "A" injured occupant was towed, then it belongs in Stratum F.
- e. Determine if at least one injured ("B", "C", or "U") occupant of a towed CDS applicable late model year vehicle involved in the accident was transported directly from the accident scene to a medical facility for treatment purposes,
- (1) If so, it belongs in Stratum E.
 - (2) If not,
- f. Determine if at least one injured ("B", "C", or "U") occupant of a towed CDS applicable nonlate model year vehicle involved in the accident was transported directly from the accident scene to a medical facility for treatment purposes,
- (1) If so, it belongs in Stratum F.
 - (2) If not,
- g. Determine if at least one towed CDS applicable late model year vehicle was involved in the accident,
- (1) If so, it belongs in Stratum G.
 - (2) If not,

OVERVIEW OF SAMPLING ACTIVITIES

- h. Determine if at least one towed CDS applicable nonlate model year vehicle was involved in the accident,
 - (1) If so, it belongs in Stratum H.
 - (2) If not, it belongs either in the X Stratum, Y Stratum (Non-CDS Injury Accidents), or the Z Stratum (Other Non-CDS Accidents).
2. Determine the non-CDS/GES sampling Stratum:
 - a. Determine if at least one medium or heavy truck was involved in the accident, AND either a non-CDS vehicle was towed OR at least one involved person received a "K", "A", or "B" injury.
 - (1) If so, it belongs in the X Stratum.
 - (2) If not,
 - b. Determine if at least one involved person received a "K" (fatal injury), "A" (incapacitating injury), or "B" (nonincapacitating evident injury) injury.
 - (1) If so, it belongs in the Y Stratum.
 - (2) If not,
 - c. It belongs in the Z Stratum.
3. Enter the accident date, accident time, and PAR number in the "PAR Information" column for all qualifying NASS accidents that have accumulated since the last visit to the police jurisdiction.
 - a. If the PAR has been classified into stratum A through Stratum H, and a medium or heavy truck is NOT involved, then enter the stratum (A through H) on the line corresponding to the PAR information in column 1 (No Trucks/Strata A-H).
 - b. If the PAR has been classified into stratum A through Stratum H, and a medium or heavy truck is involved, then enter the stratum (A through H) on the line corresponding to the PAR information in column 2 (Medium or Heavy Truck/Strata A-H,X).
 - c. If the PAR has been classified into stratum X, then enter the stratum X on the line corresponding to the PAR information in column 2 (Medium or Heavy Truck/Strata A- H,X).
 - d. If the PAR has been classified into stratum Y, then enter the stratum Y on the line corresponding to the PAR information in column 3 (Other Injury/Stratum Y).
 - e. For PARs classified into stratum Z, enter the stratum Z on the line corresponding to the PAR information in column 4 (Other/Stratum Z).

When entering PARs on successive pages, be sure to enter the page number in the "Page ___ of ___" field to keep pages in their proper sequence.

4. After all PARs for that day have been listed, enter the "line

numbers" for each of the four main columns, based on that main column's GES Carryover and GES Interval. Be sure to enter line numbers in a column only for lines which have entries in that column.

5. Enter the "page" totals at the bottom of the page to indicate the total number of PARs listed for each stratum and for each main column on that page. After listing all the PARs for that day, sum the page totals to ensure that all PARs have been listed. Enter the "day" totals for each stratum and for each main column at the bottom of the last PAR SR used for that jurisdiction for that contact day.

F. Completing the GES Sample:

All GES sampling is done manually. Obtain a copy of all sampled GES PARs before leaving the police jurisdiction. The sampled GES PARs are the highlighted lines identified as a part of the NASS PAR listing process described above. Thus, NASS CDS applicable accidents can be sampled independently in either the CDS or GES and may occasionally be selected in both systems.

3.2.3 The NASS CDS Automated Case Selection System (ACSS)

The NASS CDS Automated Case Selection System will be executed for each contact date listed on the Contact Day Assignment Sheet. The Microcomputer Data Entry User's Manual for NASS (1/90) includes instructions for using the ACSS. Any problems or difficulties that are not identified in the manual should be referred to your zone center.

The ACSS reports the selected CDS PARs on the NASS CDS Automated Case Selection System Report (ACSSR). See Table 3-3 for an example of the ACSSR.

3.2.4 Special Instructions for Automated Sampling Procedures

Occasionally emergency conditions require special sampling procedures. Hardware or software problems may prevent sampling for a short or even an extended period. Case load assignments can possibly generate problems too. The information below is intended to provide some guidance on how to cope with some of these situations. Remember, the basic sources for help are:

- o Hotline - for hardware or software problems, and
- o NASS CDS Sampling Coordinator - for case load or selection problems.

Condition A: Your micro-computer working and you have successfully closed your PAR file, but

Problem 1: The mainframe doesn't answer when you try to connect:

Action: Try two or three times to make a mainframe connection. Wait a short while (wait 15-20 minutes between calls) to allow temporary trouble to clear. If you are still unsuccessful, then call Hotline.

Problem 2: You have connected okay initially, but the connection is broken in the middle of the process:

Action: Call Hotline immediately.

TABLE 3-3

```

=====
                N A S S                                VER 4.00
      * *    A U T O M A T E D   C A S E    * *
      S E L E C T I O N   S Y S T E M   R E P O R T
      * * * * *
PSU: 02      CONTACT DATE: 03/25/91      LAST CASE NUMBER: 069
THE SAMPLE SELECTION PROGRAM EXECUTED SUCCESSFULLY.
THE FOLLOWING PARS WERE SELECTED:
Case      Police      PAR      Accident      PAR
Number  Jurisdiction  Stratum  Date      Time      Number
-----+-----+-----+-----+-----+-----
070G      04              G      03/20/91  01:00      5546
    
```

- Problem 3: The connection has apparently completed, but there is something missing or garbled in the output:
- Action: Call **Hotline** immediately.
- Condition B: Your micro-computer is not working.
- Action: Call **Hotline** to get help for a local fix or to arrange for replacement. If the prognosis is for more than a day's delay, follow the mail-in procedure for Condition C.
- Condition C: The prospect of an extended outage for either of the above conditions exists.
- Action: Express mail a copy (keep your originals) of your Stratification Records to headquarters.
- Action: Notify headquarters ("HDQ" - attention COTR) that an extended outage is in progress.
- Action: Headquarters will do the sampling and tell the team by phone which PARs were selected.
- Action: When your micro-computer is running again, send a message to headquarters ("HDQ" and "DBB") announcing that your team is back on line.

3.3 CDS Sampling Problems: How To Handle Them

The following section describes problems that sometimes arise in sampling and outlines ways to address them. A critical element in each case is time; that is, the longer the period between the occurrence of the problem and the implementation of some corrective action, the less likely are the Mathematical Analysis Division's (MAD) chances of resolving it. If a problem occurs which is not listed below, the researcher should inform his/her COTR or the MAD sampling design staff at once.

- Problem 1: A team lists and stratifies accidents correctly, but the PAR for the selected case is missing when the researcher returns to the police jurisdiction after sampling.
- Action: After all attempts to locate the PAR have been exhausted unsuccessfully, call your zone center to have the case dropped. Follow the case deletion procedures in Section 5.3.
- Problem 2: A team does not find any CDS accidents to list.
- Action: No CDS cases will be selected this day. However, the MDE must be entered to close the Listed Cases File, even though it will be empty, and a Mainframe connect must be made to receive the next contact date.

OVERVIEW OF SAMPLING ACTIVITIES

- Problem 3:** A team cannot list and select on the designated contact date due to extreme weather conditions (in particular, snow hazards) or holiday.
- Action:** When circumstances are foreseen, make arrangements with MAD to visit the jurisdiction(s) either the day before or the day after. When circumstances are unforeseen and the jurisdictions can be visited prior to the next contact date, list and select on the first practical day. In either situation list only PARs with accident dates prior to or equal to the missed contact day. If the jurisdiction(s) cannot be visited before the next contact day, notify the MAD sample design staff immediately.
- Problem 4:** Upon visiting the accident scene it is determined that the selected accident occurred outside of the PSU.
- Action:** First, determine the jurisdiction of the police agency that worked the accident. If the agency's jurisdiction includes territory outside the PSU (e.g., State Police posts often are assigned to cover multiple counties some of which are outside the PSU boundary), then drop the case and follow the Case Deletion Procedures (Section 5.3). If the agency's jurisdiction resides within the PSU and the PAR is for a CDS accident which occurred outside of the PSU (i.e., police agencies often help out other police agencies by handling accidents for them when the responsible agency is overcommitted or otherwise unavailable), then the research is to be completed as long as it meets all other requirements for a NASS accident (i.e., Section 2.1 of the NASS CDS Data Collection, Coding, and Editing Manual).
- Problem 5:** A team lists and properly selects an accident according to the information on the PAR. However, during the research it is determined that the case does not meet the criteria (i.e., Section 2.1 above) for accidents which qualify for NASS.
- Action:** If the incident is not a NASS accident, then follow the case deletion procedures (see Section 5.3).
- Problem 6:** A team improperly lists and selects an accident according to the information on the PAR. During the research it is determined that the case does not meet the criteria for selection in the CDS.
- Action:** Using Table 3-4 below, if cell i, iv, v, or vi applies, then drop the case and follow the case deletion procedures (see Section 5.3). If cell ii or iii applies, then code GV09, Police Reported Vehicle Disposition, equal to "1" (Towed due to vehicle damage) and EV27, Researcher's Assessment of Vehicle Disposition, equal to "0" (Not towed due to vehicle damage) or "9" (Unknown).

TABLE 3-4

CDS Sampling Problems: How To Handle Them			
PAR DISPOSITION VERSUS TEAM RESEARCH			
Basis for Team's Stratification	EV27--Research by the Team Indicates:		
	No CDS applicable vehicle in accident (GV07 ≥ 50)	At least one CDS applicable vehicle present	
		No CDS applicable vehicle involved in accident was towed	At least one towed CDS applicable vehicle involved, but none were towed due to damage
Correctly read PAR (GV07 < 50 and GV09=1)	D R O P i	D O N O T D R O P ii	D O N O T D R O P iii
Incorrectly read PAR (i.e., missed information present which would have changed their stratification)	D R O P iv	D R O P v	D R O P vi

OVERVIEW OF SAMPLING ACTIVITIES

It is extremely important, when problems 1 and 5 arise, that the zone center and Headquarters (COTR and MAD sample design staff) are notified immediately. Dropped cases are to be reported to headquarters at the end of each quarter, along with the reasons why they were dropped.

3.4 Beginning of Year Sampling Instructions

At the beginning of a new calendar year, some accidents that occurred in the previous year will be listed at your police jurisdictions. It is important that the accidents in each calendar year be kept separate for sampling purposes. Special instructions will be issued in December of each calendar year detailing how the separate sampling will be accomplished.

4.0 OVERVIEW OF COLLECTED INFORMATION ON SAMPLED CDS ACCIDENTS

For each case sampled, include in the case report a copy of the police report, Case Summary Form, newspaper photos and articles, correspondence, collision diagram, collision measurement table, slides (including index), the applicable crashworthiness data system data collection forms with field logs, medical injury records, reconstruction algorithm results, and MDE output.

4.1 Required Forms for CDS Cases

It is very important to remember that only the injuries to the occupants of towed CDS applicable vehicles and the model year of those occupants' vehicle(s) determine the Stratum. Also, once a NASS accident is selected for research as a CDS case all the CDS applicable vehicles, towed or nontowed, are candidates for a vehicle inspection. An exterior inspection is required for nontowed CDS applicable vehicles. Towed CDS applicable vehicles require both an exterior and an interior inspection. In addition, all drivers and occupants of the towed CDS applicable vehicles are candidates for an interview. The other vehicles in these accidents are not inspected nor are their occupants interviewed. Likewise, occupants of nontowed CDS applicable vehicles are not interviewed. Table 4-1 is aimed at assisting researchers in form selection.

4.2 Sequencing of Case Materials

Case report forms and miscellaneous materials are to be sequenced in conformity with the guidelines depicted in Figure 4-1. There are eight distinct groupings which may exist with each case, and while the number of groupings may vary with each accident, it is important for the case reviewer (team or zone center) that the composition of the eight groups be maintained.

The first document is the police accident report (PAR). Do not attach any other material to the PAR.

The second group contains the CDS Case Summary Form, newspaper photographs, articles, and other miscellaneous, non-CDS generated materials. This group will give the zone center reviewer a general appreciation of the accident from non-CDS sources and facilitates review of sampling. The documents in this group should be bound with a paper clip. The group will appear in every case, although it will often be composed only of the CDS Case Summary Form.

The third group contains the Accident Collision Diagram, Accident Collision Measurement Table, slides, and the slide index; thus, it provides the reviewer with a general overview of the case based upon the CDS research. Differences between the two versions (Non-CDS and CDS) are to be expected periodically, and preliminary review of this and the preceding group will alert the reviewer to those differences and their eventual resolution in the final CDS version. This group should appear in every case, bound together with a paper clip.

Fourth, the Accident Form will appear in every case.

The fifth group contains: [1] a General Vehicle (all vehicles) Form, [2] an Exterior Vehicle (inspected CDS applicable vehicles) Form, [3] an Interior Vehicle (inspected towed CDS applicable vehicles) Form, [4] the Occupant Assessment Forms--for only those occupants of an in-transport towed CDS applicable

OVERVIEW OF COLLECTED INFORMATION ON SAMPLED CDS ACCIDENTS

TABLE 4-1

REQUIRED FORMS FOR NASS CDS CASES

Each NASS CDS accident requires one Case Summary Form, one collision diagram, and one Accident Form. The remaining forms depend upon: (1) the type of vehicles involved in the accident, (2) their police reported tow status, and (3) the level of vehicle inspection. For each vehicle involved in the accident, select the table below which corresponds to the vehicle's tow and "CDS Applicable" status and determine the appropriate forms to submit.

In-transport Towed CDS Applicable Vehicle

	General Vehicle	Exterior Vehicle	Interior Vehicle	Interview	Occupant Assessment	Occupant Injury
Inspected	Yes	Yes	Yes	Yes ¹	Yes	Yes ²
Not Inspected	Yes	No	No	Yes ¹	Yes	Yes ²

In-transport Nontowed CDS Applicable Vehicle

	General Vehicle	Exterior Vehicle	Interior Vehicle	Interview	Occupant Assessment	Occupant Injury
Inspected	Yes	Yes ³	No	No	No	No
Not Inspected	Yes	No	No	No	No	No

In-transport Nontowed CDS Applicable AOPS Vehicle

	General Vehicle	Exterior Vehicle	Interior Vehicle	Interview	Occupant Assessment	Occupant Injury
Inspected	Yes	Yes	Yes	Yes ¹	Yes	Yes ²
Not Inspected	Yes	No	No	Yes ¹	Yes	Yes ²

In-transport Non-CDS Applicable Vehicle

	General Vehicle	Exterior Vehicle	Interior Vehicle	Interview	Occupant Assessment	Occupant Injury
No Inspection Required	Partial ⁴	No	No	No	No	No

CDS Applicable Vehicle is defined by variable GV07, Body Type. GV07 must equal codes "01"- "49" (i.e., Automobiles, Automobile Derivatives, Utility Vehicles, Van Based Light Trucks, Light Conventional Trucks, and Other Light Trucks).

Non-CDS Applicable Vehicle is defined as GV07 not equal to codes "01"- "49" (i.e., GV07 greater than or equal to "50").

- =====
- ¹ Submit only when an interview is obtained.
 - ² If applicable.
 - ³ Complete pages 1-3 of the Exterior Vehicle Form for CDS Applicable vehicles not in-transport (i.e., for speed reconstruction purposes).
 - ⁴ Complete variables GV01 through GV15 (i.e., page 1) and GV37 through GV55 (i.e., page 4).

OVERVIEW OF COLLECTED INFORMATION ON SAMPLED CDS ACCIDENTS

FIGURE 4-1

SEQUENCE OF CASE MATERIALS

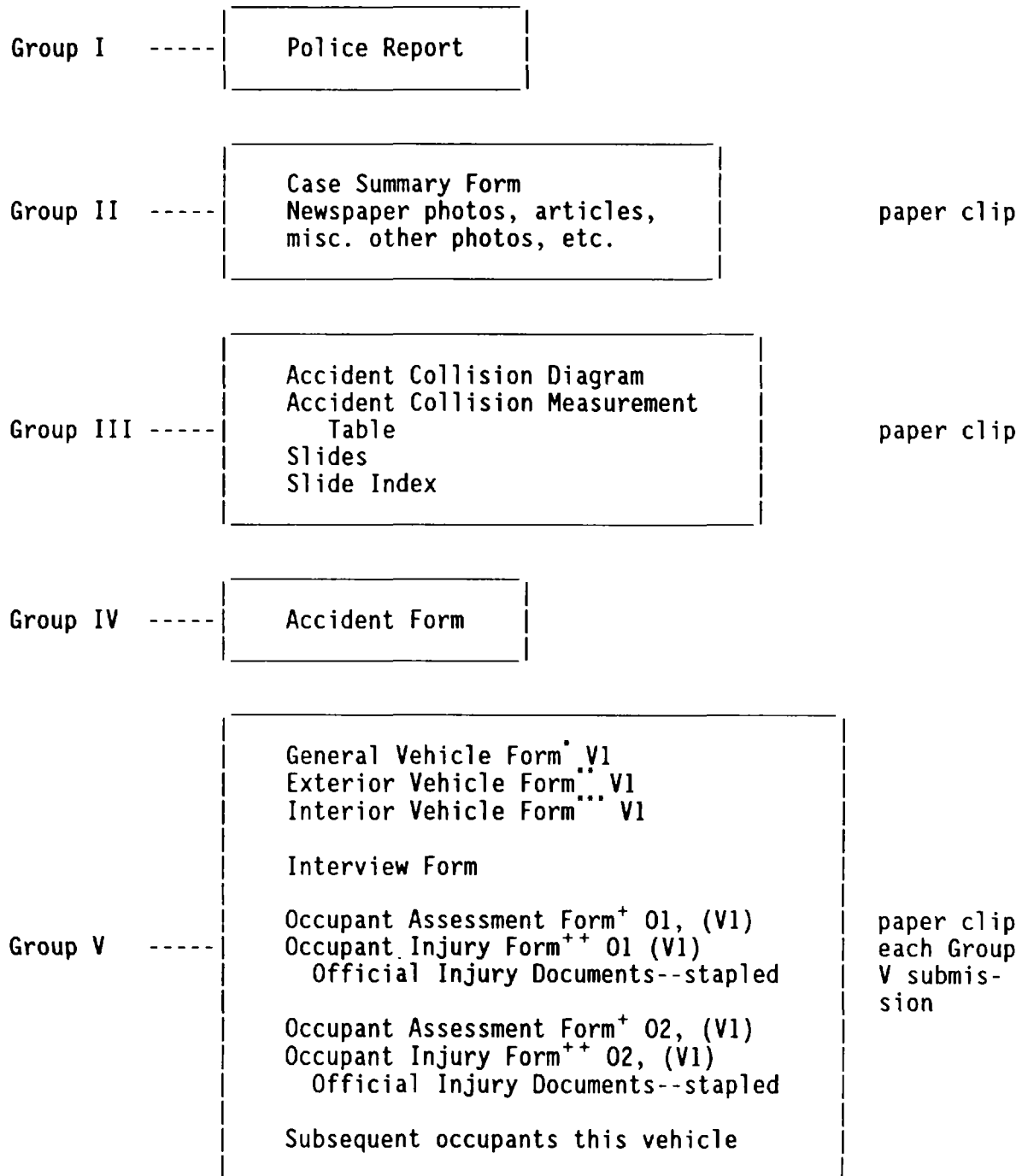

- ∴ All in-transport motor vehicles
- ** All inspected in-transport CDS applicable vehicles
- *** All inspected in-transport towed CDS applicable vehicles
- + Submitted only for all occupants of in-transport towed CDS applicable vehicles
- ++ Submitted for all injured occupants of in-transport towed CDS applicable vehicles--exception: exclude if "Injured, unknown severity" or "Unknown if injured"

OVERVIEW OF COLLECTED INFORMATION ON SAMPLED CDS ACCIDENTS

FIGURE 4-1 (Continued)

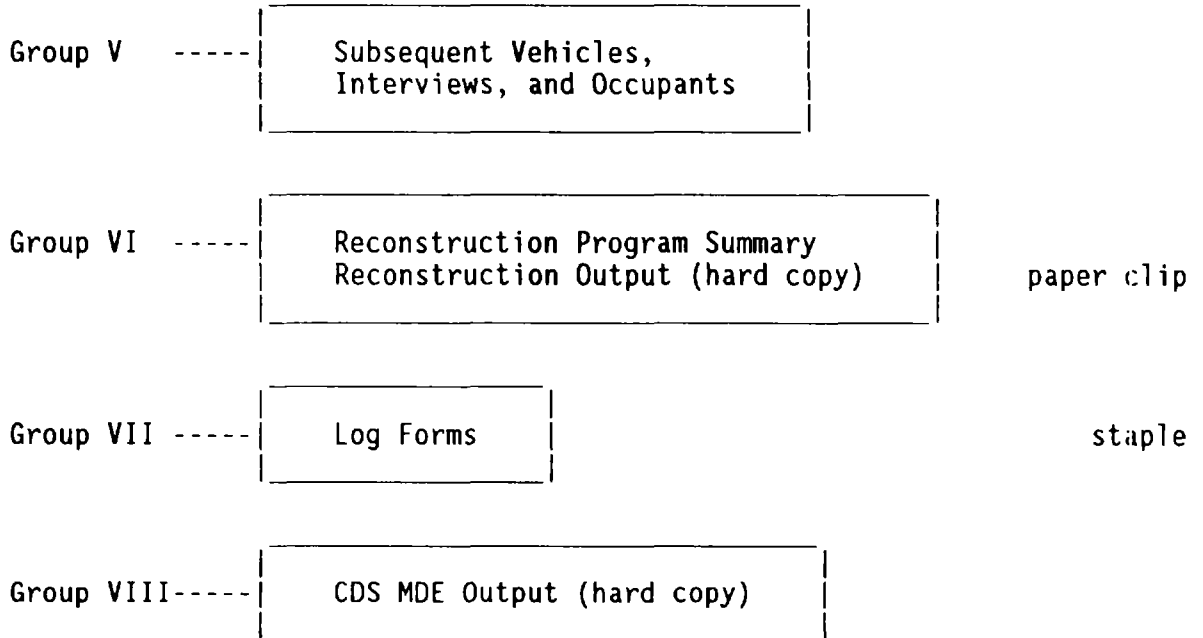

Variable Name: Vehicle Number
(1st through 5th or higher)

Element Values:

Range: 01 through 30

Source: Police Accident Report

Remarks:

Code assigned number. See variable GV03, Vehicle Number, for definitions of the attributes and coding conventions.

OVERVIEW OF COLLECTED INFORMATION ON SAMPLED CDS ACCIDENTS

Number of General Vehicle Forms Submitted, Date of Accident, and Number of Recorded Events in This Accident.

General Vehicle Form--For each accident researched, at least one General Vehicle Form must be submitted. The additional file structuring information to be included on this form consists of the assigned **Vehicle Number, Body Type, Police Reported Vehicle Disposition, Number of Occupant Forms Submitted, and Type of Vehicle Inspection.**

Exterior Vehicle Form--When Exterior Vehicle Forms are filled out, **Vehicle Number** is required for file structuring purposes.

Interior Vehicle Form--When Interior Vehicle Forms are filled out, **Vehicle Number** is required for file structuring purposes.

Occupant Assessment Form--When Occupant Assessment Forms are filled out, **Vehicle Number, Occupant Number, and Number of Recorded Injuries For This Occupant** are required for file structuring purposes.

Occupant Injury Form--When Occupant Injury Forms are filled out, **Vehicle Number and Occupant Number** are required for file structuring purposes.

Treatment of Missing Data--The file (i.e., the computerized database file) structure used in the CDS minimizes the handling of missing data. For example, neither the Exterior Vehicle Form nor the Interior Vehicle Form are present for other vehicles. The Interior Vehicle Form is absent for police reported nontowed CDS applicable vehicles except for AOPS vehicles. Further, neither form is present for uninspected towed CDS applicable vehicles. In addition, no occupant forms are required for occupants of other vehicles and nontowed CDS applicable vehicles except for AOPS vehicles. Finally, Occupant Injury Forms are only submitted when required--see the discussion above in Section 4.2, fifth group. However, when accident-involved vehicles or occupants cannot be fully inspected or interviewed and data items are missing, the appropriate form must be filled out with missing data codes and submitted with the case.

4.4 Update Procedures for Hard Copy Field Forms

Data elements which may be updated in the hard copy case report are restricted to certain variables which appear on either vehicle or occupant forms. Other data will not be updated if it is acquired after the initial submission of the case. Note, most variables may be updated before the case is forwarded to the zone center. An update record has been developed for those variables which are allowable hard copy update candidates. The update record, which has been specially designed to accommodate these variables, is not to be included with the initial submission of the case; instead, it is retained at the PSU and partially filled out upon initial case submission. Subsequently, it is completed when the update information arrives. On the original case form, all data variables which the researcher intends to update should be coded with any available appropriate information or the code designating "Unknown". In addition, the variable number should be circled. This will "signal" that an attempt will be made to update that data variable. In the case of injury updates, the "Update Candidate" circle should be marked in the affirmative. This procedure applies only to those data variables on the vehicle or occupant forms which are designated below as candidates for updating.

OVERVIEW OF COLLECTED INFORMATION ON SAMPLED CDS ACCIDENTS

The researcher is to complete the required sections prior to initial case submission so that the subsequently acquired information may be associated with the right case and vehicle or occupant number. The newly acquired information should be entered on the front of the Update Form and any supporting documents attached to the back.

Update Record--This form should be used when the researcher expects to receive data after the initial submission. Additional information required on this form prior to initial case submission comes from the General Vehicle Form, the Occupant Assessment Form, and the Occupant Injury Form and allows the researcher to update variables: GV12, GV39-GV55, OA05-OA08, OA17, OA18, OA21, OA22, OA35-OA45, and the injury variables OI05 through OI104, etc.; based on subsequent receipt of official data. These data would be difficult to update without recorded knowledge regarding the initial coding of Alcohol Test Result For Driver (GV12), Other Drug Specimen Test Type for Driver GV39, Other Drugs Test Results for Driver (GV40-GV55), Occupant's Age (OA05), Occupant's Sex (OA06), Occupant's Height (OA07), Occupant's Weight (OA08), Manual (Active) Belt System Availability (OA17), Manual (Active) Belt System Use (OA18), Air Bag System Availability-/Function (OA21), Air Bag System Deployment (OA22), Treatment - Mortality (OA35), Type Of Medical Facility (for Initial Treatment) (OA36), Hospital Stay (OA37), Working Days Lost (OA38), Time to Death (OA39), Medically Reported Cause of Death (OA40-OA42), Number of Recorded Injuries For This Occupant (OA43), Automatic (Passive) Belt System Availability/Function (OA44), Automatic (Passive) Belt System Use (OA45) and the injury data (OI05-OI104, etc.). This initial information may then be combined with the new noninjury and injury data using the NASS injury coding rules to revise the variables on the updated version. Also, a copy of the "Vehicle Interior Sketches" and "Points of Occupant Contact" pages (pages 4 and 5 of the Interior Vehicle Form) are made prior to the initial submission, so that the researcher will be able to check for specific components contacted by the occupant when coding the injury sources on the Update Form. In addition, if the vehicle sustained intrusion, include the "Occupant Area Intrusion" page (page 2 of the Interior Vehicle Form) so that the Occupant Area Intrusion No. variables (OI14 et al. on the Occupant Injury Form) can be linked to injury sources that are intruded components.

Update Filing and Submission Instructions--The researcher must complete each of the sections on the above form, as required, prior to the initial submission. This allows the new information (update form) to be associated with the corresponding field form in the initial submission, and this allows the originally coded data to be combined with the new data (e.g., using the NASS injury coding rules).

All update records may then be stored in a three-ring binder. Each new addition of an update record may then be indexed by Case Number - Stratum, Vehicle Number, and Occupant Number. They may also be partially cross-indexed alphabetically based on the name of the driver or occupant. This will facilitate the processing of inquiries from zone centers as well as the retrieval of the update record when the official medical data is received.

The name of the individual, and any other descriptive information unique to the team which may identify the individual, should be sanitized from the Update Record and/or the attached medical reports after the information from the latter has been included on the update record.

Update records should be accumulated, packaged in an individual zone center approved size manila envelope (but not one envelope for each update) which identifies the PSU and is boldly marked: **UPDATES**, and sent to the zone center

OVERVIEW OF COLLECTED INFORMATION ON SAMPLED CDS ACCIDENTS

on a periodic basis according to the schedule in Section 5.2. If the updates are not obtainable by the due date, the reasons the updates could not be obtained are to be indicated on the update record and sent to the zone center. All updates

or reasons the updates were not obtainable must be submitted to the zone center within 84 days of the date the case was sampled.

This eighty-four day time-frame is a guideline established in order to keep the processing of update records proceeding at an orderly pace. Sometimes medical records are not available within 84 days. A team can extend, with zone center permission, the length of time available to obtain a medical update. The exact length of the extension will depend upon the time of year the case was selected. Medicals from cases selected in January can be held open much longer than medicals from cases selected in December. At issue from the zone center perspective is the total number of medical updates outstanding (i.e., effort required of zone center to finish processing the updates) and the likelihood of the medicals being eventually obtained.

The update record, described above, will be attached by the zone center to the corresponding forms included in the initial submission to the zone center.

4.5 Potential Safety Problem Bulletin

All teams will be provided with bulletins (forms)--Figure 4-2, to report any potential vehicle safety problems which they encounter. Submit bulletins to Mr. Vernon Roberts at NHTSA. Each team has been placed on the mailing list for reports of active defect investigations. Teams should become familiar with current investigations and be on the lookout for accidents which are relevant to these investigations; although, other defects or vehicle problems encountered are also of interest and should be reported. Attach a copy of the bulletin submitted to NHTSA to either the Exterior Vehicle Form or Interior Vehicle Form before submitting the case to your zone center. A list of potential safety problems of current interest to NHTSA is contained in Table 4-2. This list is provided for guidance and is not intended to be inclusive.

4.6 CDS Criteria for Acceptable Data Completion

The data completion criteria are used as a standard among all PSUs when determining the minimum acceptable data for completion of a case.

Scene Inspection: The Accident Collision Diagram and slides are required. No excuse is acceptable. If the photo slides did not turn out, a return visit to the scene is required.

Where no evidence of the accident is present, provide a sketch (not scaled) which includes:

1. Approximate vehicle orientation at impact and final rest;
2. Applicable road/roadway delineation (e.g., curbs/edge lines, lane markings, median markings, pavement markings, etc.);
3. Applicable traffic controls (e.g., speed limit); and
4. North arrow placed on diagram.

FIGURE 4-2

POTENTIAL SAFETY PROBLEM BULLETIN

Reporting Date: _____

SEND TO: Vernon Roberts, NRD-32
National Highway Traffic Safety Administration
Nassif Building, Room 6213
400 Seventh Street, S.W.
Washington, D.C. 20590

SUBJECT: _____

IDENTIFICATION:

TEAM _____ CASE NO. _____ ACCIDENT DATE: _____

ACCIDENT LOCATION _____

INVESTIGATING POLICE AGENCY _____

VEHICLE MODEL YEAR _____ MAKE/MODEL _____

VIN _____ ODOMETER READING _____

ACCIDENT DESCRIPTION (include sanitized police report)

(continue on back)

ITEM DESCRIPTION (include hardware and photograph if possible)

TABLE 4-2

SPECIFIC AREAS OF INTEREST TO NHTSA RULEMAKING

CRASH AVOIDANCE

1. Accidents involving vehicles driven by handicapped drivers.
2. Accidents involving vehicles equipped with adaptive aids.
3. Accidents in which failure of a multipiece rim (not a tire failure) caused or contributed to the severity of the accident.
4. Accidents involving malfunction of a speed governor or speed control unit.
5. Accidents where the driver reported confusion about the location of display or control elements of the vehicle.
6. Accidents where underinflation of tires caused or contributed to the severity of accident.
7. Accidents involving pedestrian and/or cyclist injured by impact with outside mirrors.
8. Accidents involving injury to motorcycle drivers due to impact with the motorcycle mirrors.
9. Accidents where driver reported that distortion of image in convex mirror confused him (especially late model GM cars).
10. Accidents where commercial vehicle drivers reported that they could not see car, pedestrian, or cycle in a specific blind spot (such as in the right front area of large truck-tractors).
11. Accidents where driver or a passenger car or light truck reported that they could not see because of an obstruction of view by some part of the vehicle (such as inside mirror or roof support pillar).
12. Accidents where the vehicle's defrost/defog system or wiper system could not provide an adequate view of the traffic scene through the windshield.
13. Accidents involving pickup trucks pulling fifth-wheel type trailer.

CRASHWORTHINESS

1. Seat and/or seat back failures in crashes and their contributions to occupant injury.
2. Identify external vehicle components (i.e., hood, grill, windshield wiper, etc.) that penetrate the windshield and the degree of such penetration in crashes involving vans and light trucks.

OVERVIEW OF COLLECTED INFORMATION ON SAMPLED CDS ACCIDENTS

TABLE 4-2 (continued)

3. Ejections through the hatchback or station wagon rear doors in rear impacts. Identify whether ejection was through window opening or through door or hatchback opening because of latch failure.
4. Cars involving child restraints that break or involve injury. Identify the restraint by make and model, how and which position used.

CORROSION

1. Structural rust of uni-body undercarriage, vehicle chassis frames, floor boards in areas of seat belt attachment points, seat or seat track anchorages.
2. Rust which develops in areas where the owner can observe the rust and therefore be forewarned, but which might have safety implications such as cowl area and wipers, around windshield or backlite.
3. Rust on weight bearing or vehicle guidance components, the failure of which could affect vehicle safety and do not normally wear out in service, such as tie rods, control arms, strut rods.
4. Rust of areas where the owners report exhaust intrusion such as wheel wells, wagon tire wells and rear floor pans.

OVERVIEW OF COLLECTED INFORMATION ON SAMPLED CDS ACCIDENTS

Where physical evidence of the accident is present, in addition to points two through four above, the following detail must be incorporated in the scene diagram:

1. Documented reference point and reference line relative to physical features present at the scene;
2. Scaled documentation of all accident induced physical evidence;
3. Scaled documentation of all roadside objects contacted;
4. Roadway Surface Type and Surface Condition for all applicable roadways;
5. Grade measurements for all applicable roadways; and
6. Scaled representations of the vehicle(s) at pre-impact, impact, and final rest based upon either:
 - (a) physical evidence, or
 - (b) reconstructed accident dynamics.

Vehicle Exterior Inspections: To be credited as "inspected", at a minimum, slides of the exterior of the damaged vehicle must be submitted along with the completed form. If the vehicle has been repaired prior to the inspection, then photo slides of the repaired vehicle and damaged exterior components (where circumstances permit) along with a completed form are required. Crush dimensions and a CDC must be provided when data permit. If there is no measureable damage, then slides of the vehicle and a completed Exterior Vehicle Form will suffice. Other vehicles are not inspected.

Vehicle Interior Inspections: To be credited as "inspected", at a minimum, slides of the interior of the damaged vehicle must be submitted along with the completed form. If the vehicle has been repaired prior to the inspection, then photo slides of the repaired interior and damaged interior components (where circumstances permit) along with a completed form are required. Documentation of Integrity, Glazing, Intrusions, Steering Column, Restraint Systems, Seat Types, Instrument Panel, and Occupant Contacts must be provided when data permit. If there is no visible or discernible interior damage or contact, slides of the vehicle and a completed Interior Vehicle Form will suffice.

Accident Circumstance Interviews: If the driver was contacted and the accident circumstances section of the Interview Form completed (i.e., the information provided is sufficient enough to support that a partial or complete interview was obtained) and submitted, then it is recorded as an interview. An interview with the driver is desired; however, if an interview cannot be obtained because the driver is fatally injured or incapacitated, the accident circumstances must be provided by another occupant of the same vehicle or an eyewitness (including occupants of uninvolved vehicles).

Occupant Interviews: If the occupant was contacted and the occupant section of the Interview Form completed (i.e., the information provided is sufficient enough to support that a partial or complete interview was obtained) and submitted, then it is recorded as an interview. An interview with either a driver, occupant, relative, or friend is acceptable as a surrogate interview for other occupants. Police officers, occupants of other involved vehicles, and witnesses, who know

OVERVIEW OF COLLECTED INFORMATION ON SAMPLED CDS ACCIDENTS

the occupant under consideration only because of the accident, cannot be considered as surrogates and, therefore, no partial or complete interview credit can be assigned to researchers.

Official Medical Data: A copy of a hospital records department or other clinical institute final discharge medical summary is required. Copies of an emergency room or other abbreviated and advanced medical reports are acceptable with prior zone center approval only if established relations dictate (i.e., hospital will not or does not provide a more comprehensive medical report). Copies of physician reports are acceptable when appropriate (i.e., PAR reports victim as injured but driven to private physician). Substitute procedures, including handwritten or transcribed information, are acceptable only with the prior approval of the zone center with COTR concurrence. Only official copies of autopsy reports are acceptable. Reports from lay coroners and certificates of death are not considered official medical records.

Finally, before alternative methods for acquiring official records (i.e., handwritten copies or telephone transcripts of medical data) are authorized, all avenues for obtaining the hard copy must be exhausted. Therefore, establishment of PSU relations will be closely monitored by each zone center to ensure that teams do not default to alternative methods because they are easier to establish.

OVERVIEW OF COLLECTED INFORMATION ON SAMPLED CDS ACCIDENTS

5.0 CDS SUBMISSION INSTRUCTIONS

5.1 Quality Control Checks for PSU Teams

Please find below a list of quality control checks to be made by PSU teams.

5.1.1 Quality Control Checks Prior to Microcomputer Data Entry

Each case should be reviewed by a person other than the originating researcher prior to entering the case via MDE. This effort tends to minimize encoding errors resulting from values which are either illegal or legal but incorrect. The noncoded items in the case should also be checked. The primary researcher is to be informed (preferably in writing) of any problems detected during this review and that researcher is to assume the responsibility for their resolution. Some suggested areas where problems may occur are as follows:

- o Has the case passed in-house review?
- o Are all official records and slides present?
- o Check slides and official records to make sure they correspond to the case submitted (slides and police report shouldn't be placed next to each other because the photocopied police report tends to "bleed" on the slide folders).
- o Have portions of update record forms been filled out where needed?
- o Do the control charts properly reflect how much of the case report has been completed?
- o Make sure medical reports are properly sanitized.
- o Are all data collection forms present?
- o Are the logs properly completed on the forms?
- o Make sure case materials are sequenced properly and the case report envelope is stamped and properly identified.
- o Check noncoded data for correctness and its interface with coded data.
- o Check to make sure that the coded data are properly and legibly entered on the data collection forms.
- o Have "+"s or "-"s been circled for GV31 and GV32 on the General Vehicle Form, for EV22 and EV25 on the Exterior Vehicle Form?

5.1.2 Quality Control Checks Resulting from Microcomputer Data Entry

Inconsistencies, out-of-range values, and other error diagnostics encountered during the MDE are explained in CDS MDE error checks and tables. All errors detected by the computer edits are corrected by the PSU before the case is forwarded to the zone center--unless the zone center is notified and suggests

TABLE 5-1

MDE Checks: Format, Designations, and Tables

Digit Location:	1st	2nd	3rd	4th	5th	6th
MDE Check Format:	Letter	Letter	Number	Number	Number	Number

LETTERS

Definition	IntraForm Designators
A = Accident Form	AA = Accident intraform edit checks
G = General Vehicle Form	GG = General Vehicle intraform edit checks
E = Exterior Vehicle Form	EE = Exterior Vehicle intraform edit checks
C = Interior Vehicle Form	CC = Interior Vehicle intraform edit checks
H = Occupant Assessment Form	HH = Occupant Assessment intraform edit checks
T = Occupant Injury Form	TT = Occupant Injury intraform edit checks

InterForm Designators

AG = Accident--General Vehicle interform edit checks
AE = Accident--Exterior Vehicle interform edit checks
GE = General Vehicle--Exterior Vehicle interform edit checks
GC = General Vehicle--Interior Vehicle interform edit checks
EC = Exterior Vehicle--Interior Vehicle interform edit checks
AH = Accident--Occupant Assessment Interform edit checks
GH = General Vehicle--Occupant Assessment interform edit checks
CH = Interior Vehicle--Occupant Assessment interform edit checks
HT = Occupant Assessment--Occupant Injury interform edit checks
AT = Accident--Occupant Injury interform edit checks
AC = Accident--Interior Vehicle interform edit checks
EH = Exterior Vehicle--Occupant Assessment interform edit checks

The above two letter designations denote that the interform consistency check is written solely or primarily between the two indicated forms.

TABLE 5-1 (Continued)

T A B L E S

Table	Variables Involved	MDE Check(s)
A1	OA05, Occupant's Age OA06, Occupant's Sex OA07, Occupant's Height	HH002
A2	OA06, Occupant's Sex OA07, Occupant's Height OA08, Occupant's Weight	HH007
A4	GV07, Body Type GV19, Vehicle Curb Weight	GG008
A5	OI06 et al., O.I.C. - Body Region OI07 et al., O.I.C. - Aspect of Injury OI08 et al., O.I.C. - Lesion OI09 et al., O.I.C. - System/Organ	TT002
A6	GV31, Longitudinal Component of Delta V GV32, Lateral Component of Delta V EV06, 1st C.D.C. - Direction of Force	GE017, GE018
A7	GV05, Vehicle Make GV07, Body Type	GG005
A11	GV15, Accident Type (pair check)	GG032
A12	GV08, Vehicle Identification Number (check digit algorithm)	GG092
A13	OA40 1st Medically Reported Cause of Death OA41 2nd Medically Reported Cause of Death OA42 3rd Medically Reported Cause of Death OI06 Body Region OI09 System Organ OI10 AIS Severity	HT016 HT017 HT018
A14	AC17 Contact Class GV07 Body Type	AG028
A15	IV48, Intruding Component OI11, Injury Source OI14 Occupant Area Intrusion No.	CT009

shipment of an incompletely entered case. MDE intraform and interform checks appear on the computer screen when they are tripped. MDE checks consist of two letters followed by four numbers. The fourth number is actually the line number within the check. When contacting your zone center regarding an MDE check, please reference the check according to its two letters and first three numbers. Table 5-1 above explains the reference system used in the MDE checks. Eleven tables accompany the MDE checks. These tables are: A-1, A-2, A-4 through A-7, and A-11 through A-15. These tables are also discussed above.

5.1.3 Check to Make Sure Administrative Procedures Are Being Followed

- o Are control charts and activity logs (when used) updated weekly?
- o Are monthly reports and sampling materials sent to the zone center?
- o Are manuals up-to-date and properly displayed?
- o Are needed supplies in stock (e.g., film, etc.)?

5.1.4 Check Sampling Procedures

- o Periodically review sampling procedures in team meetings.
- o Document any problems in the monthly report.

5.1.5 Check Data Collection Procedures

- o Periodically review procedures. Document when meetings are held and any problems discovered with the data collection procedures or forms. Indicate problems in the monthly report or over the Message System to your zone center. Keep a file of problems encountered and go over them with a zone center representative during the next zone center site visit.

5.1.6 Check to Make Sure Updates Are Being Processed Properly

- o Are the medical update records filed by case number?
- o Do zone center and PSU records agree (see zone center list of outstanding updates)?

5.1.7 Check Individual Effort and Accuracy in Collecting Evidence and Skill in Interpretation

- o Discuss data collection procedures and efficient ways to execute them in team meetings. Discuss how much follow-up effort is needed for obtaining interviews and think about methods other than the phone and personal contact for obtaining more interviews (e.g., letters).

5.2 Case Submission

The final date for the remaining submission of December 1990 cases (exclusive of updates) is February 15, 1991. All remaining updates for 1990 cases are to be received at the zone center by April 12, 1991.

Cases acquired in 1991 shall be submitted to the zone centers on an approximately

bi-weekly basis. The materials for each case are to be ordered in the recommended format discussed in Section 4.2; each case is to be packaged in a separate envelope with the appropriate identification and account of contents on the Administrative log. These procedures will provide uniformity across teams and, in turn, reduce the variation encountered by the zone center upon receipt of the cases. Furthermore, the bi-weekly submission will minimize the peaks and valleys in the zone center case review workload.

Submission Schedule--Cases shall be submitted on an approximately bi-weekly basis beginning February 1, 1991, according to the schedule (Table 5-2). Essentially, there will be at least one month to make the initial submission of any case. All cases are to be submitted within four weeks following the date on which they were sampled. This means that the maximum time available to submit a case will be twenty-eight days from the date of sample. Interviews, vehicle inspections, and scenes not completed in the allowed time period will not be updated. Table 5-3 contains the 1990 file closeout schedule.

Those variables which are allowed updates, but have not been completed within the time available for the initial case submission, should be documented on the appropriate record and submitted as updates in accordance with the schedule. The update time schedule may be extended with prior approval of the zone center. See Section 4.4 (Update Procedures for Hard Copy Field Forms).

Cases which are completed (i.e., no updates needed) prior to elapsing of the available time period should be submitted on the next, earliest case submission.

Case Envelope--The standardized case envelope is 10 x 12 inches. The case envelope belongs inside the shipping envelope. The Administrative log, Table 5-4, belongs on the case envelope. The PSU number, case number, accounting of case materials, and the status of the case at the time of submission, as shown in Table 5-4, are to be entered on the log. The log is to be positioned on the right-hand side of the envelope when the envelope is positioned with its flap on the underside and to the right.

This information helps the zone center effectively sort the case at the inception of the quality control process; the standardized envelopes will facilitate storage and retrieval.

Case update records should be submitted in the same type of envelope. Identify the PSU, and boldly mark the front of the envelope: UPDATES. The updates will be removed from the envelope and collated with the original forms in their respective cases by the zone center.

Shipment of Cases--The envelopes containing the individual cases which are eligible for shipment, according to the schedule shown in Table 5-2, should be packaged in a box or other suitable container and mailed to the zone center. Do not use overnight or Express Mail services without prior approval of the COTR. The PSU should provide an acknowledgement of delivery card, return receipt, or similar confirmation to ensure the shipment was received by the zone center.

TABLE 5-2

CDS Case Submission Schedule

CASES SAMPLED ON OR BEFORE	MUST BE SUBMITTED ON OR BEFORE (+ 4 weeks)	MUST BE RECEIVED ON OR BEFORE (+ 5 weeks)	MUST BE REVIEWED ON OR BEFORE (+ 7 weeks)	MUST RECEIVE UPDATES ON OR BEFORE (+ 12 weeks)
--	---	--	--	---

1990

12-Oct-90	09-Nov-90	16-Nov-90	30-Nov-90	04-Jan-91
26-Oct-90	23-Nov-90	30-Nov-90	14-Dec-90	18-Jan-91
09-Nov-90	07-Dec-90	14-Dec-90	28-Dec-90	01-Feb-91
23-Nov-90	21-Dec-90	28-Dec-90	11-Jan-91	15-Feb-91
07-Dec-90	04-Jan-91	11-Jan-91	25-Jan-91	01-Mar-91
21-Dec-90	18-Jan-91	25-Jan-91	08-Feb-91	15-Mar-91
04-Jan-91	01-Feb-91	08-Feb-91	22-Feb-91	29-Mar-91
18-Jan-91	15-Feb-91	22-Feb-91	08-Mar-91	12-Apr-91

1991

04-Jan-91	01-Feb-91	08-Feb-91	22-Feb-91	29-Mar-91
18-Jan-91	15-Feb-91	22-Feb-91	08-Mar-91	12-Apr-91
01-Feb-91	01-Mar-91	08-Mar-91	22-Mar-91	26-Apr-91
15-Feb-91	15-Mar-91	22-Mar-91	05-Apr-91	10-May-91
01-Mar-91	29-Mar-91	05-Apr-91	19-Apr-91	24-May-91
15-Mar-91	12-Apr-91	19-Apr-91	03-May-91	07-Jun-91
29-Mar-91	26-Apr-91	03-May-91	17-May-91	21-Jun-91
12-Apr-91	10-May-91	17-May-91	31-May-91	05-Jul-91
26-Apr-91	24-May-91	31-May-91	14-Jun-91	19-Jul-91
10-May-91	07-Jun-91	14-Jun-91	28-Jun-91	02-Aug-91
24-May-91	21-Jun-91	28-Jun-91	12-Jul-91	16-Aug-91
07-Jun-91	05-Jul-91	12-Jul-91	26-Jul-91	30-Aug-91
21-Jun-91	19-Jul-91	26-Jul-91	09-Aug-91	13-Sep-91
05-Jul-91	02-Aug-91	09-Aug-91	23-Aug-91	27-Sep-91
19-Jul-91	16-Aug-91	23-Aug-91	06-Sep-91	11-Oct-91
02-Aug-91	30-Aug-91	06-Sep-91	20-Sep-91	25-Oct-91
16-Aug-91	13-Sep-91	20-Sep-91	04-Oct-91	08-Nov-91
30-Aug-91	27-Sep-91	04-Oct-91	18-Oct-91	22-Nov-91
13-Sep-91	11-Oct-91	18-Oct-91	01-Nov-91	06-Dec-91
27-Sep-91	25-Oct-91	01-Nov-91	15-Nov-91	20-Dec-91
11-Oct-91	08-Nov-91	15-Nov-91	29-Nov-91	03-Jan-92
25-Oct-91	22-Nov-91	29-Nov-91	13-Dec-91	17-Jan-92
08-Nov-91	06-Dec-91	13-Dec-91	27-Dec-91	31-Jan-92
22-Nov-91	20-Dec-91	27-Dec-91	10-Jan-92	14-Feb-92
06-Dec-91	03-Jan-92	10-Jan-92	24-Jan-92	28-Feb-92
20-Dec-91	17-Jan-92	24-Jan-92	07-Feb-92	13-Mar-92
03-Jan-92	31-Jan-92	07-Feb-92	21-Feb-92	27-Mar-92
17-Jan-92	14-Feb-92	21-Feb-92	06-Mar-92	10-Apr-92

TABLE 5-3

CDS File Closeout Schedule

CASES SAMPLED ON OR BEFORE	MUST BE APPROVED ON OR BEFORE (+ 13 weeks)	MUST BE CLOSED OUT ON OR BEFORE (+ 13 weeks)	QUARTERLY REPORT DUE ON OR BEFORE (+ 14 weeks)	SHIP CASES TO STORAGE CONTRACTOR (+ 23 weeks)
1990				
1990 ANNUAL REPORT DUE				10-May-91
12-Oct-90	11-Jan-91	11-Jan-91	18-Jan-91	22-Mar-91
26-Oct-90	25-Jan-91	THIRD QTR	THIRD QTR	THIRD QTR
09-Nov-90	08-Feb-91			
23-Nov-90	22-Feb-91			
07-Dec-90	08-Mar-91			
21-Dec-90	22-Mar-91			
04-Jan-91	05-Apr-91			
18-Jan-91	19-Apr-91	19-Apr-91	26-Apr-91	28-Jun-91
		FOURTH QTR	FOURTH QTR	FOURTH QTR
1991				
1991 ANNUAL REPORT DUE				08-May-92
04-Jan-91	05-Apr-91			
18-Jan-91	19-Apr-91			
01-Feb-91	03-May-91			
15-Feb-91	17-May-91			
01-Mar-91	31-May-91			
15-Mar-91	14-Jun-91			
29-Mar-91	28-Jun-91			
12-Apr-91	12-Jul-91			
26-Apr-91	26-Jul-91	26-Jul-91	02-Aug-91	04-Oct-91
10-May-91	09-Aug-91	FIRST QTR	FIRST QTR	FIRST QTR
24-May-91	23-Aug-91			
07-Jun-91	06-Sep-91			
21-Jun-91	20-Sep-91			
05-Jul-91	04-Oct-91			
19-Jul-91	18-Oct-91			
02-Aug-91	01-Nov-91	01-Nov-91	08-Nov-91	10-Jan-92
16-Aug-91	15-Nov-91	SECOND QTR	SECOND QTR	SECOND QTR
30-Aug-91	29-Nov-91			
13-Sep-91	13-Dec-91			
27-Sep-91	27-Dec-91			
11-Oct-91	10-Jan-92			
25-Oct-91	24-Jan-92	24-Jan-92	31-Jan-92	03-Apr-92
08-Nov-91	07-Feb-92	THIRD QTR	THIRD QTR	THIRD QTR
22-Nov-91	21-Feb-92			
06-Dec-91	06-Mar-92			
20-Dec-91	20-Mar-92			
03-Jan-92	03-Apr-92			
17-Jan-92	17-Apr-92	17-Apr-92	24-Apr-92	26-Jun-92
		FOURTH QTR	FOURTH QTR	FOURTH QTR

TABLE 5-4

Performance Assessment NASS/CDS
ADMINISTRATIVE LOG-A

TO BE COMPLETED BY TEAM						
1. PSU Number	__ __					
2. Case Number - Stratum	__ __ __ __					
3. Assigned Researcher Number	__					
4. Accident Date	__ __ / __ __ / __ __					
5. Sample Date	__ __ / __ __ / __ __					
6. Date Due at Zone Center	__ __ / __ __ / __ __					
7. Special Studies Case	<table style="margin-left: auto; margin-right: 0;"> <tr> <td style="border-bottom: 1px solid black; width: 40px;">SS12</td> <td style="border-bottom: 1px solid black; width: 40px;">SS13</td> <td style="border-bottom: 1px solid black; width: 40px;">SS14</td> <td style="border-bottom: 1px solid black; width: 40px;">SS15</td> <td style="border-bottom: 1px solid black; width: 40px;">SS16</td> </tr> </table>	SS12	SS13	SS14	SS15	SS16
SS12	SS13	SS14	SS15	SS16		
8. Jurisdiction	__ __					
9. Number Of Non-Towed CDS Applicable Vehicles	__ __					
10. Number Of Towed CDS Applicable Vehicles	__ __					
11. Number Of General Vehicle Forms Submitted	__ __					
12. Number Of Exterior Vehicle Forms Submitted	__ __					
13. Number Of Interior Vehicle Forms Submitted	__ __					
14. Number Of Occupant Assessment Forms Submitted	__ __					
15. Number Of Occupants With Official Medical Records Submitted	__ __					
16. Reconstruction In Case (1) CRASH (2) OLDMISS (3) None	__					
17. _____	__					
18. _____	__					

HS Form 431C (1/91)

The addresses for the zone centers are as follows:

Z01, Northern	Robert Woodill Calspan Corporation Post Office Box 400 Buffalo, New York 14225	(716)-631-6975 {U.S. mail}
	4455 Genesee Street Cheektowaga, New York 14225	{UPS, Federal Express, etc.}
Z02, Southern	A. B. (Chip) Chidester Calspan Corporation 521 Clanton Road, Suite B Charlotte, North Carolina 28217	(704)-522-1707 {U.S. mail} {UPS, Federal Express, etc.}
Z03, Western	Transportation Research Center Attention: NASS Receiving Indiana University SPEA Building, Room 430 Bloomington, Indiana 47405	(812)-855-3908 {U.S. mail, UPS, Federal Express, etc.}

5.3 Case Deletion Procedures

PSUs

The following procedure for deleting cases should be adhered to for all CDS cases:

1. Call your zone center for approval. Let it be known that a case is being dropped and give the reason why.
2. Send a follow-up message informing the zone center and NCSA (HDQ) of the case to be dropped. Include the following information in the message.
 - a. Case Number
 - b. Sample Date
 - c. Accident Date
 - d. Accident Time
 - e. PAR Number
 - f. Jurisdiction
 - b. Dropped Date (date Zone Center/HDQ gave approval)
 - c. Reason Dropped (list provided by COTR)
 - d. Dropped By (person who authorized dropping the case)
3. The case must be MDE'ed by the PSU and subsequently released to the zone center. To MDE the case, complete the **Accident Form** and one **General Vehicle Form**. This may differ from the actual structure of the case, but it is desired to minimize the number of forms required for the case to be released. To MDE the case, proceed as follows:
 - a. Case and Form Selection
 - (1) On Main Menu: **Press F3-Add or Change Case Data**
 - (2) On Case Selection Menu: **Select Case Number - Press Enter**
 - (3) On MDE Menu: **Press F1-MDE Add**

b. Accident Form

- (1) Complete data fields as follows:

<u>Variable Number</u>	<u>Valid Codes</u>
AC03	01
AC07	0
AC11	01
AC13-AC18	\$ in first position of each variable with spaces in additional positions

- (2) Press Enter
 (3) Press F3
 (4) Intra Errors - Press Enter
 (5) Redisplay Accident Form(N)? - Press Enter
 (6) Display Next Form(Y)? - Press Enter

c. General Vehicle Form

- (1) Complete data fields as follows:

<u>Variable Number</u>	<u>Valid Codes</u>
GV04-GV06	\$ in first character position of each variable
GV07	99
GV08	\$ in first character position
GV09	0
GV10-GV15	\$ in first character position of each variable with spaces in additional positions
GV37-GV55	0

- (2) Press Enter
 (3) Intra Errors - Press Enter
 (4) Redisplay General Vehicle Form(N)? - Press Enter
 (5) Inter Errors - Press Enter
 (6) Display Next Form(Y)? - Press Enter
 (7) On MDE Menu: Press Esc

d. Release Case

- (1) On Main Menu: Press F4-Release Case
 (2) On Case Selection Menu: Select Case Number - Press Enter
 (3) On Error Summary Screen: Press Enter
 (NOTE: You will get some errors on your Error Summary Screen;
ignore these and continue with procedure.)
 (4) Do you want to release case with errors?-Enter Y - Press Enter
 (5) Are you sure?-Enter Y - Press Enter
 (6) Make sure printer is on so that printout of case can be made

4. Send the dropped hardcopy case report to the zone center. Each dropped case is to be sent to the zone center in a separate standard envelope.

a. Label the outside of the envelope as follows:

- (1) Place the Administrative log and write in the PSU number and case number
 (2) Write in large letters: **DROPPED** (under the Administrative log)
 (3) Write the date the zone center approved to drop the case
 (4) Write the person(s) who gave zone center approval to drop the case

- b. Place inside the envelope:
- (1) PAR
 - (2) Accident Form
 - (3) General Vehicle Form
 - (4) MDE printout
 - (5) Any additional case related materials

Zone Centers

The case will be deleted from the zone center's active case file at a later date--after the zone center reviews the hardcopy case report and agrees that the case should be dropped.

Zone centers will list the case number and reason why the case was dropped in their monthly, quarterly, and annual reports.

NCSA - COTR

The COTR will:

1. Use the monthly report as a record for advising Accident Investigation Division (AID) of cases to be deleted from the file.
2. Determine the disposition of the dropped case report (e.g., shipped to NHTSA for review or destroyed at the zone center).

6.0 GES QUALITY CONTROL AND SUBMISSION INSTRUCTIONS

6.1 Quality Control Checklist for GES Sampling and Mailing

Complete the checklist shown in Table 6-1 for each submission of GES PARs.

6.2 GES Submission Instructions

The following guidelines should be carefully reviewed and adhered to.

1. The contents of each envelope should include the following:
 - (a) One GES Package Inventory Sheet;
 - (b) Stratification Record(s) for each jurisdiction visited; and
 - (c) Copy of each PAR highlighted on the Stratification Record.
 - (d) One quality control checklist
2. Use only 10 x 13 inch Manila envelopes and write GES and your PSU number in the lower right-hand corner.
3. Address this envelope as follows:

Automated Science Group, Inc.
General Estimates System
Mr. Scott Memenga
1010 Wayne Avenue
Silver Spring, MD 20910
4. Arrange the contents in the following manner.
 - o The top sheet should be the Inventory Sheet;
 - o Paper clip (**DO NOT STAPLE**) the Stratification Records to the PARs individually for each jurisdiction;
 - o Sequence the PARS in the order in which they were selected on the SR forms.

NOTE: If a jurisdiction was visited more than once you will have more than one set of Stratification Records for that jurisdiction. In this case group all the SRs for that jurisdiction together in order. Then place all the PARs for that jurisdiction together in order beneath them and paper clip them together.

- o Arrange these groups in the same order shown on your Inventory Sheet.

GES QUALITY CONTROL AND SUBMISSION INSTRUCTIONS

TABLE 6-1

QUALITY CONTROL CHECKLIST

1. Verify that the sampling procedure was correctly executed.
 - () The line # sequences have been correctly executed.
 - () The correct Interval Numbers have been used.
 - () The line #s matching the Interval Numbers have been highlighted.

2. Verify that the correct PARs have been copied.
 - () Copies of all PARs which have been sampled are present.
 - () All the pages for each PAR have been copied.
 - () There are no non-sampled PARs.
 - () Ensure you write the PJ number and column number (e.g., P3/C2).

3. Verify that the Inventory Sheet data are correct.
 - () All header and PJ information have been completed.
 - () All column entries are correct.
 - () The column totals match the number of forms submitted.

4. Prepare batch for mailing following the guidelines.
 - () The mailing guidelines have been read and followed.

5. Enclose a copy of this form with each batch to ASG.

PSU # _____

REVIEWER _____
(PRINT: First Name, Last Name)

Inventory Sheet		
paper clip	Stratification Record(s) Page 1 PARs Page 2 PARs .	Jurisdiction 1
paper clip	Stratification Record(s) Page 1 PARs Page 2 PARs .	Jurisdiction 2
	etc.	
Quality Control Checklist		
<p>Note: If a jurisdiction was visited more than once, you will have more than one set of Stratification Records for that jurisdiction. In this case, group all the SRs for that jurisdiction together in order. Then place all the PARs for that jurisdiction together in order beneath them and paper clip them together.</p>		

5. The Inventory Sheet should reflect the contents of the envelope. The entries for each jurisdiction should equal the SRs and PARs contained in the envelope for that jurisdiction. The "PSU TOTALS" row at the bottom should equal the totals for each of these categories.

Type all of your jurisdiction names on the Inventory Sheet in the numerical order of the jurisdictions. It is also preferable that you use the jurisdiction names used by NCSA rather than personal abbreviations which can be difficult to recognize. Use this form as a master and make copies from it for use during sampling.

Any jurisdictions which were not visited during the period, specified at the top of the Inventory Sheet, should have the phrase "not visited" written under the CDS, X Stratum, Y Stratum, and Z Stratum columns across from the jurisdiction name.

If no PARs were selected in a given category (CDS, X, Y, Z) for a given jurisdiction, then enter a 0 (zero) in that column.

6. Have a second person look over the Stratification Record and Inventory Sheet to verify its accuracy. It is important that these records leave your office completed correctly. When you indicate on the Inventory Sheet that the envelope contains 10 PARs but only include 8, it creates confusion and delays in processing.
7. Be sure that the PAR copies are legible. If you cannot read them, the GES staff cannot read them.

GES QUALITY CONTROL AND SUBMISSION INSTRUCTIONS

8. Next, you need to label the PAR copies with the correct PJ number, slash, and column number from the Stratification Record, exactly as in the example below.

For example, if you visited PJ3 and had sampled a case from column 2, you would label the PAR in the top right corner: P3/C2

You should not include any other information, such as the stratum.

Things not to do

1. Do not include anything other than the Inventory Sheet, the Stratification Records, the PAR copies, and the quality control checklist.
2. Do not send packages without copies of all selected PARs. If even one PAR is not available (but will be by the following mail date), then do not send the data. Wait until the following mail date and send everything as one package. If a PAR is not available for a period of time longer than the next mailing date, then you should call Dorothy Reitwiesner at ASG, (301-587-8750, ext. 169).
3. In order for a batch to be complete, it must contain at least one (1) sampled PAR. If, during your usual collection period, no PARs were sampled, **DO NOT** send these materials to ASG. Continue to list and sample according to your normal schedule until your next planned mailing date. Assuming by this time you now have at least one sampled PAR, group all relevant materials (accumulated since the last mailing) together as one batch and mail to ASG. During most of the year, this would be a rare occurrence. During the first few weeks of the new year, however, listing without sampling any PARs is fairly common.
4. If you are a PSU responsible for an adjacent site, then treat it as a separate site and use its PSU number on all forms related to that PSU. Do not use your CDS PSU number on forms related to the adjacent site.
5. Do not put data for both CDS and adjacent sites in the same 10 x 13 inch envelope. If you wish to mail them together, then follow the previous instructions for each site and place the two 10 x 13 inch envelopes into a larger envelope and mail.
6. Sometimes you may realize you have made a mistake after mailing a batch, such as omitting a PAR that should have been included or mailing any incorrect PAR. Then you should mail a separate envelope to the coding contractor including a note specifically describing the contents of the envelope. Be sure to indicate PSU number, PJ number, and batch number. **Never send an envelope containing only PARs without a written explanation.**

7.0 CODING INSTRUCTIONS

This section provides the general instructions for collecting and coding the data called for in the field forms. Documentation for each data element includes variable name, element values (attributes), definitions where needed, data sources, collection methodology, reference materials (if needed), and remarks.



CASE SUMMARY

PSU _____ CASE NO. _____ TYPE OF ACCIDENT _____

A. DESCRIPTION OF THE ACCIDENT SEQUENCE AND ACCIDENT PECULIARITIES

(Provide a summary of the accident sequence as well as any particular event of the accident that is noteworthy. Injury mechanism and vehicle crashworthiness is the focus, not driver culpability. Do not include any personal identifiers. Use reverse side if needed.)

B. VEHICLE PROFILE(S)

Vehicle No.	Class of Vehicle	Year/Make/Model	Most Severe Damage		Component Failure
			Damage Plane	Severity Description	

C. PERSON PROFILE(S)

Vehicle No.	Person Role	Seat Position	Restraint Use	Most Severe Injury			
				Body Region	Lesion	AIS	Injury Source

DO NOT SANITIZE THIS FORM

CASE SUMMARY FORM

The Case Summary Form is a noncoded description of the vehicle(s) and person(s) involved in the accident. Further, the accident sequence and case peculiarities (vehicle or environmental) are noted. The form is divided into four sections:

Identification

- A. Description of the Accident Sequence and Accident Peculiarities
- B. Vehicle Profiles
- C. Person Profiles

Through this form, the researcher is able to provide the zone center, a clinical user, or any other person interested in the NASS CDS case a quick reference of accident particulars. The form should be typed. However, legible hand written print is acceptable. The form must be neat and legible. Subsection A, Description of the Accident Sequence and Accident Peculiarities, must be double spaced, if typed. No coded values (except where indicated below) should be used. The form provides a non-jargon account of the accident.

IDENTIFICATION:

The header items are used to identify the PSU and case number. In addition, a general description of the accident type is provided. This section contains the following variables.

PSU: Indicate the appropriate PSU number.

Case No.: Indicate the case number and stratum for which the Case Summary Form is being completed.

Type of Accident: Provide a general description of the accident configuration in terms common to the traffic safety community. The pattern to be used is as follows: **vehicle / vehicle - configuration**. Appropriate vehicle and configuration terms are listed below; however, additional terms can be used if warranted.

Vehicle

car
light truck
light van
straight truck
step van
semi-tractor
tractor-trailer
motorcycle
bicycle
train
pedestrian
nonmotorist
animal
parked _____
abandoned _____
stalled _____

Configuration

ran-off-road
rollover on road
rollover off road
head-on
obtuse angle
right angle
acute angle
rear-end
sideswipe opposing direction
sideswipe same direction
object on road
non-impact

Some examples of the Type of Accident pattern desired are as follows:

car - ran-off-road
 car/car - right angle
 car/light truck - head-on
 car/parked car - rear-end
 light van/motorcycle - obtuse angle
 car/train - right angle
 car/tractor-trailer - acute angle
 light truck - object on-road
 light truck - rollover off-road

Researchers should attempt to make the best possible fit of the existing responses. However, additional responses may be more appropriate.

A. DESCRIPTION OF THE ACCIDENT SEQUENCE AND ACCIDENT PECULIARITIES

This part of the summary should provide a brief synopsis of the accident sequence as reconstructed by the researcher. Do not identify vehicle/driver culpability. For example, suppose vehicle #1 ran a stop sign and struck vehicle #2 in its left side. This situation should be described as follows:

Vehicle #1 was traveling north and vehicle #2 was traveling east on an intersecting roadway. The front of vehicle #1 impacted the left side of vehicle #2.

Thus, the impact configuration is emphasized rather than who was at fault. Any particulars concerning vehicle crashworthiness should be highlighted. Include any abnormal accident occurrences that may be of interest to quality control or the data user. Make sure personal identifiers are not used (i.e., highway/road/street names or names of persons).

B. VEHICLE PROFILES

All vehicles involved in the NASS CDS case should be documented in this section. This section contains the following variables.

Vehicle No.: See variable GV03.

Class of Vehicle: See variable AC14. Note that the written attribute (e.g., Compact", "Pickup truck", etc.) should be used, not the code.

Year/Make/Model: See variables GV04-GV06. Provide the actual vehicle year, make, and model for each vehicle involved in the NASS CDS accident (e.g., '87/Ford/Mustang). Do not use coded values.

Most Severe Damage: Document the following for the accident impact which caused the most damage to the vehicle.

- o Damage Plane - The plane first crossed in the impact (i.e., Front, Left, Right, Back, Top, or Undercarriage).
- o Severity Description - A gross indication of the damage severity. The terms light, moderate, or severe are adequate.

Component Failure: Any vehicular component that failed during the accident sequence should be noted. The components of special interest to the user may be noted by reviewing the field form variables (e.g., steering columns, seat backs, restraints, glazing, etc.).

C. PERSON PROFILES

All persons involved in the NASS CDS case and who were in a towed CDS applicable vehicle, should be noted in this section. This section contains the following variables.

Vehicle No: See variable GV03.

Person Role: Indicate if the person was the driver or a passenger in the vehicle. Write "driver" or "passenger"; do not use their coded values.

Seat Position: See variable OA10. Note that codes should not be used; instead, write "front left", "second middle", etc.

Restraint Use: Indicate the type of restraint "used" by the person (i.e., lap, lap & shoulder, air bag, passive belt, child restraint, combination).

Most Severe Injury: The most severe (i.e., highest AIS) injury to the person should be documented by noting the injury's **Body Region, Lesion, AIS, and Injury Source**--see variables OI05-OI11. Use the coded value only for AIS. If more than one injury has the highest AIS, choose one with the highest order source of data (i.e., autopsy over post-ER, post-ER over ER, etc.). If the person did not sustain an injury, write "not injured".



ACCIDENT FORM

1. Primary Sampling Unit Number _____
 2. Case Number – Stratum _____

IDENTIFICATION

3. Number of General Vehicle Forms Submitted _____
 4. Date of Accident (Month, Day, Year) _____ / _____ / **9 1**
 5. Time of Accident _____
 Code reported military time of accident
 NOTE Midnight – 2400
 Unknown – 9999

SPECIAL STUDIES INDICATORS

Check () each special study (SS12-SS16 below) that has been completed, code 1 for the checked special studies and 0 for the special studies not checked.

6. ____SS12 **Not Active** _____ **0**
 7. ____SS13 **Not Active** _____ **0**
 8. ____SS14 _____ _____
 9. ____SS15 _____ _____
 10. ____SS16 _____ _____

NUMBER OF EVENTS

11. Number of Recorded Events in This Accident _____
 Code the number of events which occurred in this accident.

ACCIDENT EVENTS

For each event that occurred in the accident, code the lowest numbered vehicle in the left columns and the other involved vehicle or object on the right.

Accident Event Sequence Number	Vehicle Number	Class of Vehicle	General Area of Damage	Vehicle Number or Object Contacted	Class of Vehicle	General Area of Damage
12. 0 1	13. _____	14. _____	15. _____	16. _____	17. _____	18. _____
19. 0 2	20. _____	21. _____	22. _____	23. _____	24. _____	25. _____
26. 0 3	27. _____	28. _____	29. _____	30. _____	31. _____	32. _____
33. 0 4	34. _____	35. _____	36. _____	37. _____	38. _____	39. _____
40. 0 5	41. _____	42. _____	43. _____	44. _____	45. _____	46. _____

IF GREATER THAN FIVE EVENTS, CONTINUE CODING ON THE ACCIDENT EVENTS SUPPLEMENT

CODES FOR CLASS OF VEHICLE

- (00) Not a motor vehicle
- (01) Subcompact mini (wheelbase 100)
- (02) Compact (wheelbase 100 - 104)
- (03) Intermediate (wheelbase - 105 - 109)
- (04) Full size (wheelbase 110 - 114)
- (05) Largest (wheelbase 115)
- (09) Unknown passenger car size
- (11) Short utility vehicle
- (12) Truck based utility (10,000 lbs GVWR)
- (13) Passenger van (10,000 lbs GVWR)
- (14) Other van (10,000 lbs GVWR)
- (15) Pickup truck (10,000 lbs GVWR)
- (18) Other truck (10,000 lbs GVWR)
- (19) Unknown light truck type
- (20) School bus
- (21) Other bus
- (22) Truck (10,000 lbs GVWR)
- (23) Tractor without trailer
- (24) Tractor-trailer(s)
- (25) Motored cycle
- (28) Other vehicle
- (99) Unknown

CODES FOR GENERAL AREA OF DAMAGE (GAD)

CDC APPLICABLE AND OTHER VEHICLES

TDC APPLICABLE VEHICLES

- | | |
|-------------------------|--|
| (0) Not a motor vehicle | (0) Not a motor vehicle |
| (N) Noncollision | (N) Noncollision |
| (F) Front | (F) Front |
| (R) Right side | (R) Right side |
| (L) Left side | (L) Left side |
| (B) Back | (B) Back of unit with cargo area (rear of trailer or straight truck) |
| (T) Top | (D) Back (rear of tractor) |
| (U) Undercarriage | (C) Rear of cab |
| (9) Unknown | (V) Front of cargo area |
| | (T) Top |
| | (U) Undercarriage |
| | (9) Unknown |

CODES FOR VEHICLE NUMBER OR OBJECT CONTACTED

(01-30) - Vehicle number

Noncollision

- (31) Overturn - rollover
- (32) Fire or explosion
- (33) Jackknife
- (34) Other intraunit damage (specify)

- (35) Noncollision injury
- (38) Other noncollision (specify)

(39) Noncollision - details unknown

Collision with Fixed Object

- (41) Tree (4 inches in diameter)
- (42) Tree (4 inches in diameter)
- (43) Shrubbery or bush
- (44) Embankment
- (45) Breakaway pole or post (any diameter)

Nonbreakaway Pole or Post

- (50) Pole or post (4 inches in diameter)
- (51) Pole or post (4 but 12 inches in diameter)
- (52) Pole or post (12 inches in diameter)
- (53) Pole or post (diameter unknown)

- (54) Concrete traffic barrier
- (55) Impact attenuator
- (56) Other traffic barrier (specify):

- (57) Fence
- (58) Wall
- (59) Building
- (60) Ditch or culvert
- (61) Ground
- (62) Fire hydrant
- (63) Curb
- (64) Bridge
- (68) Other fixed object (specify)

(69) Unknown fixed object

Collision with Nonfixed Object

- (71) Motor vehicle not in-transport
- (72) Pedestrian
- (73) Cyclist or cycle
- (74) Other nonmotorist or conveyance (specify):

- (75) Vehicle occupant
- (76) Animal
- (77) Train
- (78) Trailer, disconnected in transport
- (88) Other nonfixed object (specify):

(89) Unknown nonfixed object

(98) Other event (specify)

(99) Unknown event or object

ACCIDENT LOG

Performance Assessment

TO BE COMPLETED BY TEAM	DATA STATUS OF VARIABLE NUMBERS 1-81																																																																																																																																																																																																																																																		
<p>1. PSU Number _____</p> <p>2. Case Number - Stratum _____</p> <p>3. Assigned Researcher Number _____</p> <p>4. PSU Reviewer Number _____</p> <p>5. Sample Date _____/_____/_____</p> <p>6. Date Scene Field Work Completed _____/_____/_____</p>	<table style="width: 100%; border-collapse: collapse;"> <tr> <td style="text-align: center;">1</td><td style="text-align: center;">2</td><td style="text-align: center;">3</td><td style="text-align: center;">4</td><td style="text-align: center;">5</td><td style="text-align: center;">6</td><td style="text-align: center;">7</td><td style="text-align: center;">8</td><td style="text-align: center;">9</td><td style="text-align: center;">10</td><td style="text-align: center;">11</td> </tr> <tr> <td style="border: 1px solid black; width: 20px; height: 20px;"></td><td style="border: 1px solid black; width: 20px; height: 20px;"></td><td style="border: 1px solid black; width: 20px; height: 20px;"></td><td style="border: 1px solid black; width: 20px; height: 20px;"></td><td style="border: 1px solid black; width: 20px; height: 20px;"></td><td style="border: 1px solid black; width: 20px; height: 20px;"></td><td style="border: 1px solid black; width: 20px; height: 20px;"></td><td style="border: 1px solid black; width: 20px; height: 20px;"></td><td style="border: 1px solid black; width: 20px; height: 20px;"></td><td style="border: 1px solid black; width: 20px; height: 20px;"></td><td style="border: 1px solid black; width: 20px; height: 20px;"></td> </tr> <tr> <td style="text-align: center;">12</td><td style="text-align: center;">13</td><td style="text-align: center;">14</td><td style="text-align: center;">15</td><td style="text-align: center;">16</td><td style="text-align: center;">17</td><td style="text-align: center;">18</td> <td colspan="4"></td> </tr> <tr> <td style="border: 1px solid black; width: 20px; height: 20px;"></td><td style="border: 1px solid black; width: 20px; height: 20px;"></td><td style="border: 1px solid black; width: 20px; height: 20px;"></td><td style="border: 1px solid black; width: 20px; height: 20px;"></td><td style="border: 1px solid black; width: 20px; height: 20px;"></td><td style="border: 1px solid black; width: 20px; height: 20px;"></td><td style="border: 1px solid black; width: 20px; height: 20px;"></td> <td colspan="4"></td> </tr> <tr> <td style="text-align: center;">19</td><td style="text-align: center;">20</td><td style="text-align: center;">21</td><td style="text-align: center;">22</td><td style="text-align: center;">23</td><td style="text-align: center;">24</td><td style="text-align: center;">25</td> <td colspan="4"></td> </tr> <tr> <td style="border: 1px solid black; width: 20px; height: 20px;"></td><td style="border: 1px solid black; width: 20px; height: 20px;"></td><td style="border: 1px solid black; width: 20px; height: 20px;"></td><td style="border: 1px solid black; width: 20px; height: 20px;"></td><td style="border: 1px solid black; width: 20px; height: 20px;"></td><td style="border: 1px solid black; width: 20px; height: 20px;"></td><td style="border: 1px solid black; width: 20px; height: 20px;"></td> <td colspan="4"></td> </tr> <tr> <td style="text-align: center;">26</td><td style="text-align: center;">27</td><td style="text-align: center;">28</td><td style="text-align: center;">29</td><td style="text-align: center;">30</td><td style="text-align: center;">31</td><td style="text-align: center;">32</td> <td colspan="4"></td> </tr> <tr> <td style="border: 1px solid black; width: 20px; height: 20px;"></td><td style="border: 1px solid black; width: 20px; height: 20px;"></td><td style="border: 1px solid black; width: 20px; height: 20px;"></td><td style="border: 1px solid black; width: 20px; height: 20px;"></td><td style="border: 1px solid black; width: 20px; height: 20px;"></td><td style="border: 1px solid black; width: 20px; height: 20px;"></td><td style="border: 1px solid black; width: 20px; height: 20px;"></td> <td colspan="4"></td> </tr> <tr> <td style="text-align: center;">33</td><td style="text-align: center;">34</td><td style="text-align: center;">35</td><td style="text-align: center;">36</td><td style="text-align: center;">37</td><td style="text-align: center;">38</td><td style="text-align: center;">39</td> <td colspan="4"></td> </tr> <tr> <td style="border: 1px solid black; width: 20px; height: 20px;"></td><td style="border: 1px solid black; width: 20px; height: 20px;"></td><td style="border: 1px solid black; width: 20px; height: 20px;"></td><td style="border: 1px solid black; width: 20px; height: 20px;"></td><td style="border: 1px solid black; width: 20px; height: 20px;"></td><td style="border: 1px solid black; width: 20px; height: 20px;"></td><td style="border: 1px solid black; width: 20px; height: 20px;"></td> <td colspan="4"></td> </tr> <tr> <td style="text-align: center;">40</td><td style="text-align: center;">41</td><td style="text-align: center;">42</td><td style="text-align: center;">43</td><td style="text-align: center;">44</td><td style="text-align: center;">45</td><td style="text-align: center;">46</td> <td colspan="4"></td> </tr> <tr> <td style="border: 1px solid black; width: 20px; height: 20px;"></td><td style="border: 1px solid black; width: 20px; height: 20px;"></td><td style="border: 1px solid black; width: 20px; height: 20px;"></td><td style="border: 1px solid black; width: 20px; height: 20px;"></td><td style="border: 1px solid black; width: 20px; height: 20px;"></td><td style="border: 1px solid black; width: 20px; height: 20px;"></td><td style="border: 1px solid black; width: 20px; height: 20px;"></td> <td colspan="4"></td> </tr> <tr> <td style="text-align: center;">47</td><td style="text-align: center;">48</td><td style="text-align: center;">49</td><td style="text-align: center;">50</td><td style="text-align: center;">51</td><td style="text-align: center;">52</td><td style="text-align: center;">53</td> <td colspan="4"></td> </tr> <tr> <td style="border: 1px solid black; width: 20px; height: 20px;"></td><td style="border: 1px solid black; width: 20px; height: 20px;"></td><td style="border: 1px solid black; width: 20px; height: 20px;"></td><td style="border: 1px solid black; width: 20px; height: 20px;"></td><td style="border: 1px solid black; width: 20px; height: 20px;"></td><td style="border: 1px solid black; width: 20px; height: 20px;"></td><td style="border: 1px solid black; width: 20px; height: 20px;"></td> <td colspan="4"></td> </tr> <tr> <td style="text-align: center;">54</td><td style="text-align: center;">55</td><td style="text-align: center;">56</td><td style="text-align: center;">57</td><td style="text-align: center;">58</td><td style="text-align: center;">59</td><td style="text-align: center;">60</td> <td colspan="4"></td> </tr> <tr> <td style="border: 1px solid black; width: 20px; height: 20px;"></td><td style="border: 1px solid black; width: 20px; height: 20px;"></td><td style="border: 1px solid black; width: 20px; height: 20px;"></td><td style="border: 1px solid black; width: 20px; height: 20px;"></td><td style="border: 1px solid black; width: 20px; height: 20px;"></td><td style="border: 1px solid black; width: 20px; height: 20px;"></td><td style="border: 1px solid black; width: 20px; height: 20px;"></td> <td colspan="4"></td> </tr> <tr> <td style="text-align: center;">61</td><td style="text-align: center;">62</td><td style="text-align: center;">63</td><td style="text-align: center;">64</td><td style="text-align: center;">65</td><td style="text-align: center;">66</td><td style="text-align: center;">67</td> <td colspan="4"></td> </tr> <tr> <td style="border: 1px solid black; width: 20px; height: 20px;"></td><td style="border: 1px solid black; width: 20px; height: 20px;"></td><td style="border: 1px solid black; width: 20px; height: 20px;"></td><td style="border: 1px solid black; width: 20px; height: 20px;"></td><td style="border: 1px solid black; width: 20px; height: 20px;"></td><td style="border: 1px solid black; width: 20px; height: 20px;"></td><td style="border: 1px solid black; width: 20px; height: 20px;"></td> <td colspan="4"></td> </tr> <tr> <td style="text-align: center;">68</td><td style="text-align: center;">69</td><td style="text-align: center;">70</td><td style="text-align: center;">71</td><td style="text-align: center;">72</td><td style="text-align: center;">73</td><td style="text-align: center;">74</td> <td colspan="4"></td> </tr> <tr> <td style="border: 1px solid black; width: 20px; height: 20px;"></td><td style="border: 1px solid black; width: 20px; height: 20px;"></td><td style="border: 1px solid black; width: 20px; height: 20px;"></td><td style="border: 1px solid black; width: 20px; height: 20px;"></td><td style="border: 1px solid black; width: 20px; height: 20px;"></td><td style="border: 1px solid black; width: 20px; height: 20px;"></td><td style="border: 1px solid black; width: 20px; height: 20px;"></td> <td colspan="4"></td> </tr> <tr> <td style="text-align: center;">75</td><td style="text-align: center;">76</td><td style="text-align: center;">77</td><td style="text-align: center;">78</td><td style="text-align: center;">79</td><td style="text-align: center;">80</td><td style="text-align: center;">81</td> <td colspan="4"></td> </tr> <tr> <td style="border: 1px solid black; width: 20px; height: 20px;"></td><td style="border: 1px solid black; width: 20px; height: 20px;"></td><td style="border: 1px solid black; width: 20px; height: 20px;"></td><td style="border: 1px solid black; width: 20px; height: 20px;"></td><td style="border: 1px solid black; width: 20px; height: 20px;"></td><td style="border: 1px solid black; width: 20px; height: 20px;"></td><td style="border: 1px solid black; width: 20px; height: 20px;"></td> <td colspan="4"></td> </tr> </table>	1	2	3	4	5	6	7	8	9	10	11												12	13	14	15	16	17	18																19	20	21	22	23	24	25																26	27	28	29	30	31	32																33	34	35	36	37	38	39																40	41	42	43	44	45	46																47	48	49	50	51	52	53																54	55	56	57	58	59	60																61	62	63	64	65	66	67																68	69	70	71	72	73	74																75	76	77	78	79	80	81															
1	2	3	4	5	6	7	8	9	10	11																																																																																																																																																																																																																																									
12	13	14	15	16	17	18																																																																																																																																																																																																																																													
19	20	21	22	23	24	25																																																																																																																																																																																																																																													
26	27	28	29	30	31	32																																																																																																																																																																																																																																													
33	34	35	36	37	38	39																																																																																																																																																																																																																																													
40	41	42	43	44	45	46																																																																																																																																																																																																																																													
47	48	49	50	51	52	53																																																																																																																																																																																																																																													
54	55	56	57	58	59	60																																																																																																																																																																																																																																													
61	62	63	64	65	66	67																																																																																																																																																																																																																																													
68	69	70	71	72	73	74																																																																																																																																																																																																																																													
75	76	77	78	79	80	81																																																																																																																																																																																																																																													
TO BE COMPLETED BY ZONE CENTER																																																																																																																																																																																																																																																			
<p>7. Assessment Of Complexity Of Scene _____ (1) Level 1 <u>Level 2</u> (2) Routine (3) Difficult</p> <p>8. Field Documentation Of Physical Plant _____ (0) Not applicable (1) Substandard (2) Standard (3) Above standard</p> <p>9. Field Documentation Of Physical Evidence _____ (0) Not applicable (1) Substandard (2) Standard (3) Above standard</p> <p>10. Quality Of Scene Diagram _____ (0) Not applicable (1) Substandard (2) Standard (3) Above standard</p> <p>11. Scene Slides Subject Quality _____ (0) Not applicable (1) Substandard (2) Standard (3) Above standard</p> <p>12. Scene Slides Quality _____ (0) Not applicable (1) Substandard (2) Standard (3) Above standard</p> <p>13. Number Of Researcher Coded Events _____</p> <p>14. Number Of Events Added By Zone Center _____</p> <p>15. Number Of Events Deleted By Zone Center _____</p> <p>16. Correct Stratum Character _____</p>	<p>Data Status Codes:</p> <p>(Blank) Correct (1) Derived error (2) Non-correctable error (3) Correctable error (4) Change - no error (5) Sequencing error (8) MDE error (9) Unknown coded</p>																																																																																																																																																																																																																																																		

ACCIDENT EVENTS SUPPLEMENT

1. Primary Sampling Unit Number _____

2. Case Number - Stratum _____

Accident Event Sequence Number	Vehicle Number	Class of Vehicle	General Area of Damage	Vehicle Number or Object Contacted	Class of Vehicle	General Area of Damage
47. <u>0</u> <u>6</u>	48. _____	49. _____	50. _____	51. _____	52. _____	53. _____
54. <u>0</u> <u>7</u>	55. _____	56. _____	57. _____	58. _____	59. _____	60. _____
61. <u>0</u> <u>8</u>	62. _____	63. _____	64. _____	65. _____	66. _____	67. _____
68. <u>0</u> <u>9</u>	69. _____	70. _____	71. _____	72. _____	73. _____	74. _____
75. <u>1</u> <u>0</u>	76. _____	77. _____	78. _____	79. _____	80. _____	81. _____
82. <u>1</u> <u>1</u>	83. _____	84. _____	85. _____	86. _____	87. _____	88. _____
89. <u>1</u> <u>2</u>	90. _____	91. _____	92. _____	93. _____	94. _____	95. _____
96. <u>1</u> <u>3</u>	97. _____	98. _____	99. _____	100. _____	101. _____	102. _____
103. <u>1</u> <u>4</u>	104. _____	105. _____	106. _____	107. _____	108. _____	109. _____
110. <u>1</u> <u>5</u>	111. _____	112. _____	113. _____	114. _____	115. _____	116. _____
117. <u>1</u> <u>6</u>	118. _____	119. _____	120. _____	121. _____	122. _____	123. _____
124. <u>1</u> <u>7</u>	125. _____	126. _____	127. _____	128. _____	129. _____	130. _____
131. <u>1</u> <u>8</u>	132. _____	133. _____	134. _____	135. _____	136. _____	137. _____
138. <u>1</u> <u>9</u>	139. _____	140. _____	141. _____	142. _____	143. _____	144. _____
145. <u>2</u> <u>0</u>	146. _____	147. _____	148. _____	149. _____	150. _____	151. _____



ACCIDENT COLLISION MEASUREMENT TABLE

Primary Sampling Unit Number _____ Case Number – Stratum _____

ACCIDENT COLLISION DIAGRAM		CRASH DATA		
LEVEL I PHYSICAL EVIDENCE ABSENT	LEVEL II (Cont'd) accomplished when physical evidence is present:	VEH #1	VEH #2	VEH #3
<p>To be accomplished when there is no physical evidence present at the scene:</p> <ul style="list-style-type: none"> *approximate vehicle orientation at impact and final rest *applicable road/roadway delineation (e.g., curbs/edge lines, lane markings, median markings, pavement markings, etc.) *applicable traffic controls (e.g., speed limit) *north arrow placed on diagram *sketch required 	<ul style="list-style-type: none"> *document reference point and reference line relative to physical features present at the scene *scaled documentation of all accident induced physical evidence *scaled documentation of all roadside objects contacted *roadway surface type and condition of applicable roadways *grade measurements for all applicable roadways *scaled representations of the vehicle(s) at pre-impact, impact, and final rest based upon either: <ol style="list-style-type: none"> a) physical evidence, or b) reconstructed accident dynamics 	Heading Angle	_____	_____
		Surface Type	_____	_____
		Surface Condition	_____	_____
		Grade Measurement (v/h)	_____	_____

Reference Point: _____ Reference Line: _____

Item	Distance and Direction from Reference Point	Distance and Direction from Reference Line



US Department of Transportation
National Highway Traffic Safety
Administration

NATIONAL ACCIDENT SAMPLING SYSTEM
CRASHWORTHINESS DATA SYSTEM

ACCIDENT COLLISION DIAGRAM

PSU No. ____

Case Number - Stratum ____

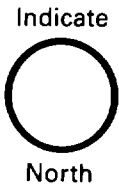

Variable Name: Primary Sampling Unit Number

Element Values:

Zone Center One

- 02 Ulster County, New York
- 03 Kings County, New York
- 04 Ocean County, New Jersey
- 05 Montgomery County, Pennsylvania
- 06 Philadelphia, Pennsylvania
- 08 Allegheny County, Pennsylvania (minus Pittsburgh City)
- 09 Charles and Prince Georges Counties, Maryland
- 11 Washtenaw County, Michigan
- 12 Genesee County, Michigan
- 13 Muskegon County, Michigan

Zone Center Two

- 41 Ft. Lauderdale and Hollywood, Florida
- 43 Wake County, North Carolina
- 45 Knox County, Tennessee
- 48 Tuscaloosa and Bibb Counties, Alabama
- 49 Dallas, Texas

Zone Center Three

- 72 Chicago, Illinois
- 73 Lake County, Indiana
- 74 Douglas County, Nebraska
- 75 Gilpin, Jefferson Counties, Colorado
- 76 Gila, Graham, Greenlee Counties, Arizona
- 78 Yuma and La Paz Counties, Arizona
- 79 Los Angeles County, California (minus Los Angeles City and Long Beach City)
- 81 King County, Washington (minus Seattle City)
- 82 Seattle, Washington

Source: Defined by NCSA.

Remarks:

Variable Name: Case Number - Stratum

Element Values:

Range: Case Number--001 through 599
CDS Sampling Stratum--A, B, C, D, E, F, G, H

Source: Assigned by Automated Case Selection System

Remarks:

The Case Number - Stratum is assigned by the Automated Case Selection System and is composed of two parts: the first three digits are a number ranging from 001 to 599; the last digit is the letter identifying from which CDS sampling stratum the case was selected (A, B, C, D, E, F, G, H).

Except as noted below, no numbers will be skipped. If a case must be dropped, the number will not be reused.

Refer to section 2.2 of this manual for CDS stratification and case selection procedures. For GES stratification (strata X, Y, and Z) refer to section 2.2.2 of this manual.

Variable Name: Number of General Vehicle Forms Submitted

Element Values:

Range: 01 through 30

Source: Researcher determined--inputs include police report, scene inspection, and interviews.

Remarks:

Each accident must have at least one General Vehicle Form submitted. The value recorded must equal the total number of General Vehicle Forms present in the case.

This variable is a file structuring variable.

A General Vehicle Form must be submitted for each in-transport motor vehicle involved in the accident. For example, one CDS applicable vehicle is towing another by a nonfixed linkage (e.g., rope, chain, etc.). Assuming both vehicles are involved in the accident, a form is required for both vehicles. If the linkage was fixed (see GV03, Vehicle Number, for a definition of "fixed linkage"), only the power unit would be considered in-transport and only one form required.

Hit-and-run accidents occasionally cause some confusion on this variable. A General Vehicle Form is filled out for each in-transport motor vehicle involved in the accident independent of the amount of information collected on the vehicles by the police. Parked vehicles may or may not require a form depending on whether or not they were in-transport. A thorough discussion of the sampling protocol for NASS is found in section 2.0 of the Introduction (pages 5 through 42).

Variable Name: Date of Accident (Month, Day, Year)

Element Values:

Month

01	January	07	July
02	February	08	August
03	March	09	September
04	April	10	October
05	May	11	November
06	June	12	December

Day

Range: 01 through 31

Year

91 1991 (precoded value)

Source: Police Report.

Remarks:

If the PAR indicates (usually a hit-and-run) that the accident occurred between some p.m. and a.m. time (e.g., 8:00 p.m. and 6:00 a.m.) on either a preceding or following day, code the accident as occurring on the following day. If a range of days is indicated (e.g., between Sunday and Friday), code the last date of the range (e.g., Friday).

If the month and year of accident occurrence is unknown, code the contact date's month, day, and year.

Variable Name: Time of Accident

Element Values:

Code reported military time of accident.

For example: 1200 - Noon
 2400 - Midnight

9999 Unknown

Source: Police report.

Remarks:

Code to the nearest minute (e.g., 10:19 p.m. = 2219 hours). The time coded is taken from the "accident time" block on the PAR (usually at the top of the first page). If this block is left blank, then "9999" (Unknown) is coded.

If the block is coded "midnight" (i.e., 12:00 a.m., 0000, or 2400) a determination must be made for sampling purposes as to whether the police consider this accident to be the first or last accident on the date indicated on the PAR. Because of variability among police jurisdictions in how they handle midnight, researchers must look at the PAR date, day-of-week, and PAR number (if available) or question police personnel and make a determination regarding whether the particular jurisdiction considers the accident being sampled to be the first or last accident on the date indicated on the PAR. Technically, midnight (i.e., 12:00 a.m.) begins a new day, but not all jurisdictions treat midnight as such. If the jurisdiction considers the accident as the last (or one of the last) on the "date" indicated, code this variable as "2400" (Midnight); however, if the jurisdiction considers the accident as the first (or one of the first) on the "date" indicated, code this variable as "0001". Code "0000" is not allowed! Thus, 12:00 a.m. (0000, 2400) can be coded either "2400" or "0001" depending on how the particular jurisdiction handles midnight.

If the PAR indicates the accident occurred during some time interval of greater than one hour (e.g., 8:00 p.m. to 6:00 a.m., or 8:00 a.m. to 5:00 p.m.), code "9999" (Unknown). However, if the interval was one hour or less, code the midpoint of the interval (e.g., 8:00 p.m. to 9:00 p.m., code "2030").

AC06
AC07
AC08
AC09
AC10

Variable Name: SS12 - Not Active (precoded "0")
SS13 - Not Active (Precoded "0")
SS14 - Not used
SS15 - Not used
SS16 - Not used

Element Values:

0 No
1 Yes

Source: Special study procedures.

Remarks:

Code "0" (No) means there is no special study form included in the case.

Code "1" (Yes) means there is a special study form included in the case.

Variable Name: Number of Recorded Events in This Accident

Element Values:

Range: 01-98

Code the number of (qualifying) events which occurred in this accident.

Source: Researcher determined based on police report, scene investigation, and interviews

Remarks:

This variable is a file structuring variable.

Not all events are coded; code only "qualifying" events. A qualifying event is an "event" that involves at least one in-transport motor vehicle. The in-transport vehicle can be either CDS applicable or non-CDS applicable. If the in-transport vehicle is a CDS applicable vehicle, then it can be either a towed or a nontowed in-transport vehicle. Any event in the accident that does not involve an in-transport motor vehicle is to be dropped from the sequence and not reported on the NASS CDS forms. A further discussion concerning "events" and those which qualify follows in the Accident Events Overview.

Unknown is not a valid code for this variable. Researchers must determine the number of qualifying events.

ACCIDENT EVENTS OVERVIEW

An "accident" is the total set of "events" (one or more) that results from an unstabilized situation such that at least one harmful event occurs not directly resulting from a cataclysm. The "accident" is concluded in time when all events which originated from the unstabilized situation have stabilized.

An accident is considered applicable to the NASS CDS if one of its events resulted in harm (except for nonqualifying noncollision events; see Section 2.2.1, page 31--seventh paragraph) and that event involved an in-transport CDS applicable vehicle which was reported on a police report as being towed from the scene of the accident due to damage.

Harm can be either an impact or a noncollision event. An impact is defined as any vehicle to vehicle or vehicle to object (fixed or nonfixed, stationary or nonstationary) contact which may or may not result in vehicle damage. Noncollision events such as fire/explosion, occupant fell from vehicle, occupant injury without vehicle impact, etc., are also included in these variables unless this noncollision event is the only event in the accident.

The NASS CDS is only interested in those events that involve in-transport motor vehicles. The motor vehicle can be a: towed CDS applicable vehicle, nontowed CDS applicable vehicle, or a non-CDS applicable vehicle. Events that involve only not in-transport motor vehicles and/or pedestrians and/or non-motorists are not considered; they are dropped by the researcher from the accident sequence. Below are some examples of nonqualifying events.

- o Not in-transport vehicle (e.g., parked vehicle) impacts pedestrian, pedalcyclist, or other nonmotorist
- o Not in-transport vehicle impacts an object (fixed or nonfixed)
- o Not in-transport vehicle impacts another not in-transport vehicle
- o Pedestrian (pedalcyclist, other nonmotorist) impacts an object
- o Pedestrian (pedalcyclist, other nonmotorist) impacts another not in-transport vehicle
- o Pedestrian, pedalcyclist, or other nonmotorist inter-impact.

The accident events variables are designed to provide a coded description of all qualifying events which occurred in the accident sequence. Events are encoded in chronological sequence. Two groups of variables are provided for each event. The first (or left) group always describes the in-transport motor vehicle with the lowest vehicle number in the event. The second group describes either the other in-transport vehicle or the object involved in the event with the in-transport motor vehicle described by the left group.

ACCIDENT EVENTS OVERVIEW

With this coded chronological sequence of accident events on the CDS database, analysts can review the entire series of events involving in-transport motor vehicles. Various areas of concern to the highway safety community will be easily assessed using these variables. For instance, the injury severity in accidents can be assessed relative to the number and type of impacts involved.

Likewise, certain collision configurations may create a greater hazardous condition for the occupants. A possible area of analysis would be the mix of vehicle sizes or the types of objects the different classes of vehicles impact.

Complete these variables based upon an accurate and complete reconstruction of the vehicular dynamics involved in the accident. All of the injury or damage producing events or circumstances for the in-transport motor vehicle(s) are coded.

An example of a properly coded accident sequence follows for the accident described below.

Vehicle 1 (a compact passenger car) went out of control on a wet roadway and struck a median guardrail with its front. The vehicle was redirected by the guardrail and reentered the roadway, where it struck vehicle 2 (a pickup truck) in the left side with its front. Vehicle 1 spun to a stop in the roadway, and the driver, due to the spinning, hit his head on the door pillar breaking his neck. Vehicle 2, out-of-control, ran off the roadway and struck a pedestrian with its front.

<u>Accident Event Sequence Number</u>	<u>Vehicle Number</u>	<u>Class of Vehicle</u>	<u>General Area of Damage</u>	<u>Vehicle Number or Object Contacted</u>	<u>Class of Vehicle</u>	<u>General Area of Damage</u>
12. <u>0 1</u>	13. <u>0 1</u>	14. <u>0 2</u>	15. <u>F</u>	16. <u>5 6</u>	17. <u>0 0</u>	18. <u>0</u>
19. <u>0 2</u>	20. <u>0 1</u>	21. <u>0 2</u>	22. <u>F</u>	23. <u>0 2</u>	24. <u>1 5</u>	25. <u>L</u>
26. <u>0 3</u>	27. <u>0 2</u>	28. <u>1 5</u>	29. <u>F</u>	30. <u>7 2</u>	31. <u>0 0</u>	32. <u>0</u>
33. <u>__ __</u>	34. <u>__ __</u>	35. <u>__ __</u>	36. <u>__</u>	37. <u>__ __</u>	38. <u>__ __</u>	39. <u>__</u>

Note, for the driver of vehicle 1, breaking his neck is not a separate codeable event. Rather, this injury, and almost all occupant injuries resulting from occupant interior contact, is a result of a collision event.

Variable Name: Accident Event Sequence Number
(1st through 5th or higher)

Element Values:

Range: 01-98--precoded values: 01 through 05

Source: Researcher Determined

Remarks:

This variable is precoded for events "01" through "05". If more than 5 events are involved, use the Accident Events Supplement.

The codes are for the chronological sequence of events in the accident.

Variable Name: Vehicle Number
(1st through 5th or higher)

Element Values:

Range: 01 through 30

Source: Police Accident Report

Remarks:

Code assigned number. See variable GV03, Vehicle Number, for definitions of the attributes and coding conventions.

Variable Name: Class of Vehicle--1st
(1st through 5th or higher)

Element Values:

- 01 Subcompact/mini (wheelbase <100")
- 02 Compact (wheelbase = 100" - 104")
- 03 Intermediate (wheelbase = 105"- 109")
- 04 Full size (wheelbase = 110" - 114")
- 05 Largest (wheelbase ≥115")
- 09 Unknown passenger car size
- 11 Short utility vehicle
- 12 Truck based utility (≤10,000 lbs GVWR)
- 13 Passenger van (≤10,000 lbs GVWR)
- 14 Other van (≤10,000 lbs GVWR)
- 15 Pickup truck (≤10,000 lbs GVWR)
- 18 Other truck (≤10,000 lbs GVWR)
- 19 Unknown light truck type
- 20 School bus
- 21 Other bus
- 22 Truck (>10,000 lbs GVWR)
- 23 Tractor without trailer
- 24 Tractor-trailer(s)
- 25 Motored cycle
- 28 Other vehicle
- 99 Unknown

Source: Researcher determined--inputs include police report, vehicle inspection, VIN breakdown, and interviews.

Remarks:

The Passenger Car Classification Subcommittee, A3B11(1), of the Transportation Research Board, Traffic Records and Accident Analysis Committee, A3B11, assesses size based on the vehicle wheelbase. The guidelines for this classification can be found in the report entitled Recommended Definitions for Passenger Car Size Classification by Wheelbase and Weight, August 1984 by the previously mentioned subcommittee.

Codes "01" through "05" rely on the guidelines for wheelbase alone. Round the actual wheelbase value to the nearest inch before choosing the correct code. For example, if the actual wheelbase is 99.7 inches, then code "02" (Compact) is the correct code because 99.7 inches rounds to 100 inches; normal rounding rules apply. If one of these codes is used, then the vehicle's Body Type, GV07, must be coded as an automobile (codes "01"- "06", "08") or automobile derivative (codes "10"- "12").

Variable Name: Class of Vehicle--1st (Cont'd.)
(1st through 5th or higher)

- Code "09" (Unknown passenger car size) is used when it is known that a vehicle is a passenger car (codes "01" through "05"), but the wheelbase is unknown (i.e., Original Wheelbase, EV28, equals "9999"). If this code is used, then the vehicle's Body Type, GV07, must be coded "09" (Unknown automobile type).
- Code "11" (Short utility vehicle) refers to vehicles defined in code "13" (Short utility vehicle) in variable GV07, Body Type.
- Code "12" (Truck based utility) refers to vehicles defined in code "14" (Truck based utility) in variable GV07, Body Type.
- Code "13" (Passenger van) includes all vehicle types defined in codes "20", "21", "28", and "29" in variable GV07, Body Type, and designed with seats installed for passengers in excess of two seat positions.
- Code "14" (Other van) includes all vehicles as described in variable GV07, Body Type, codes "20", "21", "28", and "29" and not fitting into the definition of code "13" above.
- Code "15" (Pickup truck) is defined in variable GV07, Body Type, codes "30", "31", "32", and "35".
- Code "18" (Other truck) is defined in codes "33", "34", "39", "40", "41", "42", and "47" in variable GV07, Body Type.
- Code "19" (Unknown light truck type) is defined in code "48" [Unknown other light truck type (not a pickup)] in variable GV07, Body Type.
- Code "20" (School bus) refers to those vehicles described by code "50" (School bus) in variable GV07, Body Type.
- Code "21" (Other bus) describes those vehicles included in codes "58" and "59" in variable GV07, Body Type.
- Code "22" (Truck) is defined in variable GV07, Body Type, as codes "60" through "63", "68", and "69".
- Code "23" (Tractor without trailer) refers to code "64" (Truck-tractor with no cargo trailer) in variable GV07, Body Type.
- Code "24" (Tractor-trailer(s)) is defined in codes "65", "66", and "67" in variable GV07, Body Type.
- Code "25" (Motored cycle) refers to GV07, Body Type, codes "70" through "79".

Variable Name: Class of Vehicle--1st (Cont'd.)
(1st through 5th or higher)

Code "28" (Other vehicle) refers to all vehicles described by codes "80" or "88" in variable GV07, Body Type.

Code "99" (Unknown) is used when there is a lack of information regarding the type of vehicle. This lack of information prohibits the accurate classification of this vehicle using one of the preceding codes. This code is equivalent to Body Type, GV07, codes "49" [Unknown light vehicle type (automobile, van, or light truck)] or "99" (Unknown body type).

Variable Name: General Area of Damage--1st
(1st through 5th or higher)

Element Values:

N Noncollision
9 Unknown

CDC Applicable and Other Vehicles

F Front
R Right side
L Left side
B Back
T Top
U Undercarriage

TDC Applicable Vehicles

F Front
R Right side
L Left side
B Back of unit with cargo area
(rear of trailer or straight
truck)
D Back (rear of tractor)
C Rear of cab
V Front of cargo area
T Top
U Undercarriage

Source: Researcher determined.

Remarks:

Code "N" (Noncollision) must be used whenever the corresponding Vehicle Number or Object Contacted (AC16 et al.) is coded "32"- "39". Since AC18 et al., General Area of Damage--2nd, will also equal "N" when AC16 et al. equals "32"- "39", this variable (AC15 et al.) and AC18 et al. will be identically coded.

Code "9" (Unknown) must be coded when the General Area of Damage--1st (AC15 et al.) on a vehicle is not known from any reliable source. Note, for all vehicles the rules developed in SAE J224MAR80 and SAE J1301, for determining the plane of damage, should be used for completion of this variable.

For vehicles which are CDC applicable (e.g., pickups, light vans, and passenger cars) the guidelines from J224MAR80 must be applied, and the codes provided under the "CDC Applicable and Other Vehicles" category must be used. This includes rollovers (i.e., AC16 et al. = "31").

For vehicles which are TDC applicable (i.e., medium/heavy trucks) use the guidelines from J1301, and use the codes provided under the "TDC Applicable Vehicles" category.

Variable Name: Vehicle Number or Object Contacted
(1st through 5th or higher)

Element Values:

01-30 Vehicle Number

Noncollision

- 31 Overturn - rollover
- 32 Fire or explosion
- 33 Jackknife
- 34 Other intraunit damage
(specify)
- 35 Noncollision injury
- 38 Other noncollision (specify)
- 39 Noncollision - details
unknown

Collision with Fixed Object

- 41 Tree (≤ 4 inches in diameter)
- 42 Tree (> 4 inches in diameter)
- 43 Shrubbery or bush
- 44 Embankment
- 45 Breakaway pole or post (any diameter)

Nonbreakaway Pole or Post

- 50 Pole or post (≤ 4 inches in diameter)
- 51 Pole or post (> 4 but ≤ 12 inches in diameter)
- 52 Pole or post (> 12 inches in diameter)
- 53 Pole, post (diameter unknown)

- 54 Concrete traffic barrier
- 55 Impact attenuator

- 56 Other traffic barrier
(specify)
- 57 Fence
- 58 Wall
- 59 Building
- 60 Ditch or culvert
- 61 Ground
- 62 Fire hydrant
- 63 Curb
- 64 Bridge
- 68 Other fixed object
(specify)
- 69 Unknown fixed object

Collision with Nonfixed Object

- 71 Motor vehicle not in-transport
- 72 Pedestrian
- 73 Cyclist or cycle
- 74 Other nonmotorist or conveyance (specify)
- 75 Vehicle occupant
- 76 Animal
- 77 Train
- 78 Trailer, disconnected in transport
- 88 Other nonfixed object (specify)
- 89 Unknown nonfixed object
- 98 Other event (specify)
- 99 Unknown event or object

Source: Researcher determined.

Remarks:

Refer to variables GV03, Vehicle Number, and EV05, Object Contacted, for definitions of the attributes and coding conventions.

Variable Name: Class of Vehicle--2nd
(1st through 5th or higher)

Element Values:

- 00 Not a motor vehicle
- 01 Subcompact/mini (wheelbase <100")
- 02 Compact (wheelbase = 100" - 104")
- 03 Intermediate (wheelbase = 105" - 109")
- 04 Full size (wheelbase = 110" - 114")
- 05 Largest (wheelbase ≥115")
- 09 Unknown passenger car size
- 11 Short utility vehicle
- 12 Truck based utility (≤10,000 lbs GVWR)
- 13 Passenger van (≤10,000 lbs GVWR)
- 14 Other van (≤10,000 lbs GVWR)
- 15 Pickup truck (≤10,000 lbs GVWR)
- 18 Other truck (≤10,000 lbs GVWR)
- 19 Unknown light truck type
- 20 School bus
- 21 Other bus
- 22 Truck (>10,000 lbs GVWR)
- 23 Tractor without trailer
- 24 Tractor-trailer(s)
- 25 Motored cycle
- 28 Other vehicle
- 99 Unknown

Source: Researcher determined--inputs include police report, vehicle inspection, VIN breakdown, and interviews.

Remarks:

The Passenger Car Classification Subcommittee, A3B11(1), of the Transportation Research Board, Traffic Records and Accident Analysis Committee, A3B11, assesses size based on the vehicle wheelbase. The guidelines for this classification can be found in the report entitled Recommended Definitions for Passenger Car Size Classification by Wheelbase and Weight, August 1984 by the previously mentioned subcommittee.

Codes "01" through "05" rely on the guidelines for wheelbase alone. Round the actual wheelbase value to the nearest inch before choosing the correct code. For example, if the actual wheelbase is 99.7 inches, then code "02" (Compact) is the correct code because 99.7 inches rounds to 100 inches; normal rounding rules apply. If one of these codes is used, then the vehicle's Body Type, GV07, must be coded as an automobile (codes "01"- "06", "08") or automobile derivative (codes "10"- "12").

Variable Name: Class of Vehicle--2nd (Cont'd.)
(1st through 5th or higher)

- Code "09" (Unknown passenger car size) is used when it is known that a vehicle is a passenger car (codes "01" through "05"), but the wheelbase is unknown (i.e., Original Wheelbase, EV28, equals "9999"). If this code is used, then the vehicle's Body Type, GV07, must be coded "09" (Unknown automobile type).
- Code "11" (Short utility vehicle) refers to vehicles defined in code "13" (Short utility vehicle) in variable GV07, Body Type.
- Code "12" (Truck based utility) refers to vehicles defined in code "14" (Truck based utility) in variable GV07, Body Type.
- Code "13" (Passenger van) includes all vehicle types defined in codes "20", "21", "28", and "29" in variable GV07, Body Type, and designed with seats installed for passengers in excess of two seat positions.
- Code "14" (Other van) includes all vehicles as described in variable GV07, Body Type, codes "20", "21", "28", and "29" and not fitting into the definition of code "13" above.
- Code "15" (Pickup truck) is defined in variable GV07, Body Type, codes "30", "31", "32", and "35".
- Code "18" (Other truck) is defined in codes "33", "34", "39", "40", "41", "42", and "47" in variable GV07, Body Type.
- Code "19" (Unknown light truck type) is defined in code "48" [Unknown other light truck type (not a pickup)] in variable GV07, Body Type.
- Code "20" (School bus) refers to those vehicles described by code "50" (School bus) in variable GV07, Body Type.
- Code "21" (Other bus) describes those vehicles included in codes "58" and "59" in variable GV07, Body Type.
- Code "22" (Truck) is defined in variable GV07, Body Type, as codes "60" through "63", "68", and "69".
- Code "23" (Tractor without trailer) refers to code "64" (Truck-tractor with no cargo trailer) in variable GV07, Body Type.
- Code "24" (Tractor-trailer(s)) is defined in codes "65", "66", and "67" in variable GV07, Body Type.
- Code "25" (Motored cycle) refers to GV07, Body Type, codes "70" through "73".

Variable Name: Class of Vehicle--1st (Cont'd.)
(1st through 5th or higher)

Code "28" (Other vehicle) refers to all vehicles described by codes "80" or "88" in variable GV07, Body Type.

Code "99" (Unknown) is used when there is a lack of information regarding the type of vehicle. This lack of information prohibits the accurate classification of this vehicle using one of the preceding codes. This code is equivalent to Body Type, GV07, codes "49" [Unknown light vehicle type (automobile, van, or light truck)] or "99" (Unknown body type).

When AC16 et al., Vehicle Number or Object Contacted, equals "31" through "98", code AC17 et al., is equal to "00" (Not a motor vehicle).

Variable Name: General Area of Damage--2nd
(1st through 5th or higher)

Element Values:

Ø Not a motor vehicle
N Noncollision
9 Unknown

CDC Applicable and Other Vehicles

F Front
R Right side
L Left side
B Back
T Top
U Undercarriage

TDC Applicable Vehicles

F Front
R Right side
L Left side
B Back of unit with cargo area
(rear of trailer or straight
truck)
D Back (rear of tractor)
C Rear of cab
V Front of cargo area
T Top
U Undercarriage

Source: Researcher determined.

Remarks:

Code "Ø" (Not a motor vehicle) for AC18 et al., when AC16 et al., Vehicle Number or Object Contacted, equals "41" through "89".

Code "N" (Noncollision) must be used whenever the corresponding Vehicle Number or Object Contacted (AC16 et al.) is coded "31"-"39". Since AC15 et al., General Area of Damage--1st, will also equal "N" when AC16 et al. equals "32"-"39", this variable (AC18 et al.) and AC15 et al. will be identically coded for the AC16 et al. values of "32"-"39". However, this code will be used on this variable when AC16 et al. equals "31" even though AC15 et al. will not take this code.

Code "9" (Unknown) must be coded when the General Area of Damage--1st (AC15 et al.) on a vehicle is not known from any reliable source. Note, for all vehicles the rules developed in SAE J224MAR80 and SAE J1301, for determining the plane of damage, should be used for completion of this variable.

For vehicles which are CDC applicable (e.g., pickups, light vans, and passenger cars) the guidelines from J224MAR80 must be applied, and the codes provided under the "CDC Applicable and Other Vehicles" category must be used.

For vehicles which are TDC applicable (i.e., medium/heavy trucks) use the guidelines from J1301, and use the codes provided under the "TDC Applicable Vehicles" category.



1 Primary Sampling Unit Number _____

2 Case Number – Stratum _____

3. Vehicle Number _____

VEHICLE IDENTIFICATION

4. Vehicle Model Year _____
Code the last two digits of the model year
(99) Unknown

5. Vehicle Make (specify): _____

Applicable codes are found in your
NASS CDS Data Collection, Coding, and
Editing Manual.
(99) Unknown

6. Vehicle Model (specify): _____

Applicable codes are found in your
NASS CDS Data Collection, Coding, and
Editing Manual.
(999) Unknown

7. Body Type _____
Note: Applicable codes are found on
the back of this page.

8. Vehicle Identification Number _____

Left justify. Slash zeros and letter Z (0 and Z)
No VIN – Code all zeros
Unknown – Code all nine's

OFFICIAL RECORDS

9. Police Reported Vehicle Disposition _____
(0) Not towed due to vehicle damage
(1) Towed due to vehicle damage
(9) Unknown

10. Police Reported Travel Speed _____

Code to the nearest mph (NOTE: 00 means
less than 0.5 mph)
(97) 96.5 mph and above
(99) Unknown

11. Police Reported Alcohol Presence _____
(0) No alcohol present
(1) Yes (alcohol present)
(7) Not reported
(8) No driver present
(9) Unknown

Note: See Variables 37 through 55 (Page 4)
for Information on Other Drugs

12. Alcohol Test Result for Driver _____
Code actual value (decimal implied before
first digit – 0.xx)
(95) Test refused
(96) None given
(97) AC test performed, results unknown
(98) No driver present
(99) Unknown

Source _____

ACCIDENT RELATED

13. Speed Limit _____
(00) No statutory limit
Code posted or statutory speed limit
(99) Unknown

14. Attempted Avoidance Maneuver _____
(00) No impact
(01) No avoidance actions
(02) Braking (no lockup)
(03) Braking (lockup)
(04) Braking (lockup unknown)
(05) Releasing brakes
(06) Steering left
(07) Steering right
(08) Braking and steering left
(09) Braking and steering right
(10) Accelerating
(11) Accelerating and steering left
(12) Accelerating and steering right
(97) No driver present
(98) Other action (specify) _____
(99) Unknown

15. Accident Type _____
Applicable codes may be found on the back
of page two of this field form
(00) No impact
Code the number of the diagram that
best describes the accident circumstance
(98) Other accident type (specify) _____
(99) Unknown

****SKIP TO VARIABLE GV37 IF GV07 DOES NOT EQUAL 01-49****

CODES FOR BODY TYPE

CDS APPLICABLE VEHICLES

Automobiles

- (01) Convertible (excludes sun-roof, t bar)
- (02) 2 door sedan hardtop, coupe
- (03) 3 door 2 door hatchback
- (04) 4-door sedan hardtop
- (05) 5-door 4-door hatchback
- (06) Station wagon (excluding van and truck based)
- (08) Other automobile type (specify)

(09) Unknown automobile type

Automobile Derivatives

- (10) Auto based pickup (includes El Camino, Caballero, Ranchero, and Brat)
- (11) Auto based panel (cargo station wagon, includes auto based ambulance hearse)
- (12) Large limousine - more than four side doors or stretched chassis

Utility Vehicles

- (13) Short utility - not truck based (includes Jeep CJ-5, Jeep CJ 7, Renegade, Landrover, Pre-78 Bronco, Landcruiser, Thing)
- (14) Truck based utility (2-door, includes Blazer, Bronco - 78 on, Bronco II, Jimmy, Ramcharger, Cherokee Trailduster, Scout)

Van Based Light Trucks (≤ 10,000 lbs GVWR)

- (20) Minivan (Lumina APV, Astro, Caravan, Plymouth Vista, Aerostar, Safari, Voyager [84 and after], Dodge Vista, Mini Ram Van, Toyota Cargo Van, Toyota Van, Vanagon, VW Bus, Kombi)
- (21) Standard van (Sportvan, Chevy Van, Club Wagon, Ford Econoline, Ram Van, Chateau, Ram Wagon, Vandura, Rally, Voyager [83 and before], Beauville, Sportsman)
- (28) **Other van type (Hi-Cube Van, Kary) (specify):**

(29) Unknown van type

Light Conventional Trucks (Pickup Style Cab, 10,000 lbs GVWR)

- (30) Compact pickup (≤ 4,500 lbs GVWR, S-10, LUV, Ram 50, Rampage, Courier, Ranger, S-15 Pup, Mazda Pickup, Mitsubishi Truck, Nissan Pickup, Arrow Pickup, Scamp, Toyota Pickup, VW Pickup)
- (31) Standard pickup (4,500 to 10,000 lbs GVWR, C10 - C30, K10 - K30, T10, D100 - D350, W150 - W350, F100 - F350, Comanche, J10 - J30, Dakota)
- (32) Pickup with slide-in camper
- (33) Truck based station wagon (4-door includes Suburban, Travelall, Wagoneer)
- (34) Light truck based suburban limousine
- (35) Convertible pickup
- (39) Unknown (pickup style) light conventional truck type

Other Light Trucks (≤ 10,000 lbs GVWR)

- (40) Cab chassis based (includes rescue vehicle, light stake dump, and tow truck)
- (41) Truck based panel
- (42) Light truck based motorhome (chassis mounted)
- (47) **Other light conventional truck type (not a pickup - includes step vans ≤ 10,000 lbs GVWR, Grumman LLV vehicle) (specify):**

-
- (48) Unknown other light truck type (not a pickup)
 - (49) Unknown light vehicle type (automobile, van, or light truck)

OTHER VEHICLES

Buses (Excludes Van Based)

- (50) School bus (designed to carry students, not cross country or transit)
- (58) Other bus type (e.g. transit, intercity, bus based motorhome) (specify)

(59) Unknown bus type

Medium Heavy Trucks (> 10,000 lbs GVWR)

- (60) Step van
- (61) Single unit straight truck (10,000 lbs GVWR 26,000 lbs)
- (62) Single unit straight truck (> 26,000 lbs GVWR)
- (63) Medium heavy truck based motorhome
- (64) Truck tractor with no cargo trailer
- (65) Truck-tractor pulling one trailer
- (66) Truck-tractor pulling two or more trailers
- (67) Truck-tractor (unknown if pulling trailer)
- (68) Unknown medium heavy truck type
- (69) Unknown truck type (light medium heavy)

Motored Cycles (Does Not Include All-Terrain Vehicles Cycles)

- (70) Motorcycle
- (71) Moped (motorized bicycle)
- (78) Other motored cycle type (minibike motorscooter) (specify)

(79) Unknown motored cycle type

Other Vehicles

- (80) ATV (All Terrain Vehicle) and ATC (All Terrain Cycle)
- (88) Other vehicle type (specify)

(99) Unknown body type

OCCUPANT RELATED

16. Driver Presence in Vehicle _____
 (0) Driver not present
 (1) Driver present
 (9) Unknown
17. Number of Occupants This Vehicle _____
 (00-96) Code actual number of occupants
 for this vehicle
 (97) 97 or more
 (99) Unknown
18. Number of Occupant Forms Submitted _____

24. Rollover _____
 (0) No rollover (no overturning)
- Rollover (primarily about the longitudinal axis)
 (1) Rollover, 1 quarter turn only
 (2) Rollover, 2 quarter turns
 (3) Rollover, 3 quarter turns
 (4) Rollover, 4 or more quarter turns (specify)

- (5) Rollover – end-over-end (i.e., primarily
 about the lateral axis)
 (9) Rollover (overturn), details unknown

VEHICLE WEIGHT ITEMS

19. Vehicle Curb Weight _____ **00**
 _____ Code weight to nearest
 100 pounds.
 (010) Less than 1050 pounds
 (135) 13,500 lbs or more
 (999) Unknown

Source _____

20. Vehicle Cargo Weight _____ **00**
 _____ Code weight to nearest
 100 pounds.
 (00) Less than 50 pounds
 (97) 9,650 lbs or more
 (99) Unknown

OVERRIDE/UNDERRIDE (THIS VEHICLE)

25. Front Override/Underride (this vehicle) _____
26. Rear Override/Underride (this vehicle) _____
- (0) No override/underride, or
 not an end-to-end impact
- Override (see specific CDC)
 (1) 1st CDC
 (2) 2nd CDC
 (3) Other not automated CDC (specify)

- Underride (see specific CDC)
 (4) 1st CDC
 (5) 2nd CDC
 (6) Other not automated CDC (specify)

- (7) **Medium/heavy truck or bus override**
 (9) Unknown

RECONSTRUCTION DATA

21. Towed Trailing Unit _____
 (0) No towed unit
 (1) Yes – towed trailing unit
 (9) Unknown
22. Documentation of Trajectory Data
 for This Vehicle _____
 (0) No
 (1) Yes
23. Post Collision Condition of Tree or Pole
 (for Highest Delta V) _____
 (0) Not collision (for highest delta V) with
 tree or pole
 (1) Not damaged
 (2) Cracked/sheared
 (3) Tilted 45 degrees
 (4) Tilted -45 degrees
 (5) Uprooted tree
 (6) Separated pole from base
 (7) Pole replaced
 (8) Other (specify)

 (9) Unknown

**HEADING ANGLE AT IMPACT FOR
HIGHEST DELTA V**

Values (000)-(359) Code actual value
 (997) Noncollision
 (998) Impact with object
 (999) Unknown

27. Heading Angle for This Vehicle _____
28. Heading Angle for Other Vehicle _____

Category	Configuration	ACCIDENT TYPES (Includes Intent)					
I Single Driver	A Right Roadside Departure	01 DRIVE OFF ROAD	02 CONTROL/ TRACTION LOSS	03 AVOID COLLISION WITH VEH PED ANIM	04 SPECIFICS OTHER	05 SPECIFICS UNKNOWN	
	B Left Roadside Departure	06 DRIVE OFF ROAD	07 CONTROL/ TRACTION LOSS	08 AVOID COLLISION WITH VEH PED ANIM	09 SPECIFICS OTHER	10 SPECIFICS UNKNOWN	
	C Forward Impact	11 PARKED VEH	12 STA OBJECT	13 PEDESTRIAN/ ANIMAL	14 END DEPARTURE	15 SPECIFICS OTHER	16 SPECIFICS UNKNOWN
II Same Trafficway Same Direction	D Rear End	20 STOPPED 21 22 23	24 SLOWER 25 26 27	28 DECEL 29 30 31	(EACH • 32) SPECIFICS OTHER	(EACH • 33) SPECIFICS UNKNOWN	
	F Forward Impact	34 CONTROL/ TRACTION LOSS	36 CONTROL/ TRACTION LOSS	38 AVOID COLLISION WITH VEH	40 AVOID COLLISION WITH OBJECT	(EACH • 42) SPECIFICS OTHER	(EACH • 43) SPECIFICS UNKNOWN
	F Sideswipe Angle	44 45 46 47	(EACH • 48) SPECIFICS OTHER	(EACH • 49) SPECIFICS UNKNOWN			
III Same Trafficway Opposite Direction	G Head On	50 LATERAL MOVE	(EACH • 52) SPECIFICS OTHER	(EACH • 53) SPECIFICS UNKNOWN			
	H Forward Impact	54 CONTROL/ TRACTION LOSS	56 CONTROL/ TRACTION LOSS	58 AVOID COLLISION WITH VEH	60 AVOID COLLISION WITH OBJECT	(EACH • 62) SPECIFICS OTHER	(EACH • 63) SPECIFICS UNKNOWN
	I Sideswipe Angle	64 LATERAL MOVE	(EACH • 66) SPECIFICS OTHER	(EACH • 67) SPECIFICS UNKNOWN			
IV Change Trafficway Vehicle Turning	J Turn Across Path	68 INITIAL OPPOSITE DIRECTIONS	70 INITIAL SAME DIRECTIONS	(EACH • 74) SPECIFICS OTHER	(EACH • 75) SPECIFICS UNKNOWN		
	K Turn Into Path	76 TURN INTO SAME DIRECTION	78 TURN INTO OPPOSITE DIRECTIONS	(EACH • 84) SPECIFICS OTHER	(EACH • 85) SPECIFICS UNKNOWN		
V Intersecting Paths (Vehicle Damage)	L Straight Paths	86 87	88 89	(EACH • 90) SPECIFICS OTHER	(EACH • 91) SPECIFICS UNKNOWN		
VI Miscellaneous	M Backing Etc	92 BACKING VEH	93 OTHER VEH OR OBJECT	98 Other Accident Type 99 Unknown Accident Type 00 No Impact			

29. Basis for Total Delta V (Highest) _____

Delta V Calculated

- (1) CRASH program – damage only routine
- (2) CRASH program – damage and trajectory routine
- (3) Missing vehicle algorithm

Delta V Not Calculated

- (4) At least one vehicle (which may be this vehicle) is beyond the scope of an acceptable reconstruction program, regardless of collision conditions.
- (5) All vehicles within scope (CDC applicable) of CRASH program but one of the collision conditions is beyond the scope of the CRASH program or other acceptable reconstruction techniques, regardless of adequacy of damage data.
- (6) All vehicles and collision conditions are within scope of one of the acceptable reconstruction programs, but there is insufficient data available

COMPUTER GENERATED DELTA V

30. Total Delta V _____

_____ Nearest mph _____

(NOTE 00 means less than 0.5 mph)
 (97) 96.5 mph and above
 (99) Unknown

31. Longitudinal Component of Delta V _____

_____ Nearest mph _____

(NOTE ___00 means greater than -0.5 and less than -0.5 mph)
 (+ 97) + 96.5 mph and above
 (___ 99) Unknown

32. Lateral Component of Delta V _____

_____ Nearest mph _____

(NOTE: ___00 means greater than -0.5 and less than +0.5 mph)
 (+ 97) ± 96.5 mph and above
 (___ 99) Unknown

33. Energy Absorption _____ 00

_____ Nearest 100 foot-lbs _____

(NOTE: 0000 means less than 50 Foot-Lbs)
 (9997) 999,650 foot-lbs or more
 (9999) Unknown

34. Confidence in Reconstruction Program Results (for Highest Delta V) _____

- (0) No reconstruction
- (1) Collision fits model – results appear reasonable
- (2) Collision fits model – results appear high
- (3) Collision fits model – results appear low
- (4) Borderline reconstruction – results appear reasonable

35. Type of Vehicle Inspection _____

- (0) No Inspection
- (1) Complete inspection
- (2) Partial inspection (specify): _____

36 Is this an AOPS Vehicle? _____

- (0) No
- (1) Yes

IS OLDMISS APPLICABLE FOR THIS VEHICLE? [] YES [] NO
 IF YES: IS A COMPLETED OLDMISS PROGRAM SUMMARY INCLUDED? [] YES [] NO

<p>37. Police Reported Other Drug Presence _____</p> <p>(0) No other drugs present (1) Yes (other drug present) (7) Not reported (8) No driver present (9) Unknown</p> <p>38. Police Reported Observation/Perception _____</p> <p>Test Type For Driver</p> <p>(0) No observation/perception test given (1) Drug recognition technician (DRT) determination (2) Behavioral (3) Other physical observation/perception determination (specify): _____</p> <p>(7) Other observation/perception test (8) No driver present</p> <p>(9) Unknown if observation/perception test given</p> <p>39. Other Drug Specimen Test Type For Driver _____</p> <p>(0) No specimen test given (1) Blood test (2) Urine test (3) Other specimen tests (specify): _____</p> <p>(7) Unspecified specimen test (8) No driver present (9) Unknown if specimen test given</p>	<p style="text-align: center;">OTHER DRUGS TEST RESULTS FOR DRIVER</p> <table style="width: 100%; border-collapse: collapse;"> <thead> <tr> <th style="width: 60%;"></th> <th style="width: 20%; text-align: center;">Observation/ Perception Test Results</th> <th style="width: 20%; text-align: center;">Specimen Test Results</th> </tr> </thead> <tbody> <tr> <td>Narcotic Drug</td> <td style="text-align: center;">40. _____</td> <td style="text-align: center;">41. _____</td> </tr> <tr> <td>Depressant Drug</td> <td style="text-align: center;">42. _____</td> <td style="text-align: center;">43. _____</td> </tr> <tr> <td>Stimulant Drug</td> <td style="text-align: center;">44. _____</td> <td style="text-align: center;">45. _____</td> </tr> <tr> <td>Hallucinogen Drug</td> <td style="text-align: center;">46. _____</td> <td style="text-align: center;">47. _____</td> </tr> <tr> <td>Cannabinoid Drug</td> <td style="text-align: center;">48. _____</td> <td style="text-align: center;">49. _____</td> </tr> <tr> <td>Phencyclidine (PCP)</td> <td style="text-align: center;">50. _____</td> <td style="text-align: center;">51. _____</td> </tr> <tr> <td>Inhalant Drug</td> <td style="text-align: center;">52. _____</td> <td style="text-align: center;">53. _____</td> </tr> <tr> <td>Other Drug (Excluding Nicotine, Aspirin, Alcohol, Drugs Administered Post-Crash)</td> <td style="text-align: center;">54. _____</td> <td style="text-align: center;">55. _____</td> </tr> </tbody> </table> <p style="text-align: center;">Codes For Observation/Perception Test Results</p> <p>(0) No observation/perception test given (1) Passed observation/perception test (2) Failed observation/perception test (3) Observation/perception test given - results unknown (8) No driver present (9) Unknown if observation perception test given</p> <p style="text-align: center;">Codes for Specimen Test Results</p> <p>(0) No specimen test given (1) Drug not found in specimen (2) Drug found in specimen (8) No driver present (9) Unknown if specimen test given</p>		Observation/ Perception Test Results	Specimen Test Results	Narcotic Drug	40. _____	41. _____	Depressant Drug	42. _____	43. _____	Stimulant Drug	44. _____	45. _____	Hallucinogen Drug	46. _____	47. _____	Cannabinoid Drug	48. _____	49. _____	Phencyclidine (PCP)	50. _____	51. _____	Inhalant Drug	52. _____	53. _____	Other Drug (Excluding Nicotine, Aspirin, Alcohol, Drugs Administered Post-Crash)	54. _____	55. _____
	Observation/ Perception Test Results	Specimen Test Results																										
Narcotic Drug	40. _____	41. _____																										
Depressant Drug	42. _____	43. _____																										
Stimulant Drug	44. _____	45. _____																										
Hallucinogen Drug	46. _____	47. _____																										
Cannabinoid Drug	48. _____	49. _____																										
Phencyclidine (PCP)	50. _____	51. _____																										
Inhalant Drug	52. _____	53. _____																										
Other Drug (Excluding Nicotine, Aspirin, Alcohol, Drugs Administered Post-Crash)	54. _____	55. _____																										

***** IF THE CDS APPLICABLE VEHICLE WAS NOT INSPECTED (I.E., GV35 = 0), ***
DO NOT COMPLETE THE EXTERIOR AND INTERIOR VEHICLE FORMS.**

***** IF GV07 DOES NOT EQUAL 01-49, DO NOT COMPLETE ***
THE EXTERIOR VEHICLE, INTERIOR VEHICLE,
OCCUPANT ASSESSMENT, AND OCCUPANT INJURY FORMS.**

GENERAL VEHICLE LOG

Performance Assessment

TO BE COMPLETED BY TEAM	TO BE COMPLETED BY ZONE CENTER																																																																																																																														
<p>1. PSU Number _____</p> <p>2. Case Number - Stratum _____</p> <p>3. Researcher Completing Form _____</p> <p>4. Vehicle Number _____</p> <p>5. Vehicle Disposition/Type _____ (1) Towed, CDS applicable (2) Non-towed, CDS applicable (3) Non-CDS applicable</p> <p>6. Reason Vehicle Inspection Not Completed _____ (00) Non-CDS applicable vehicle (01) Complete inspection (02) Partial inspection (03) Vehicle cannot be located (04) Vehicle destroyed (05) Vehicle outside of study area (06) Vehicle impounded (07) Vehicle sold (08) Hit and run vehicle (09) Owner could not be located (10) Owner refusal (11) Insurance company refusal (12) Attorney refusal or litigation (13) Repair or tow facility refusal (14) Stolen (15) Wrong name and address on PAR (16) Caseload/staff turnover (17) Other (specify): _____</p> <p>7. Knowledge Of Highest Delta V Results _____ <u>Known</u> (01) CRASH-PC damage only (02) CRASH-PC damage and trajectory (03) OLDMISS</p> <p><u>Unknown</u> (04) Rollover (05) Other non-horizontal force (06) Sideswipe type damage/severe override (07) Vehicle out of scope/pedestrian (08) Yielding object (09) Overlapping damage (10) Insufficient data (11) Other (specify): _____</p> <p>8. Presence Of Non-coded Reconstruction Program? _____ (0) No (1) Yes</p> <p>9. Data Obtained For This Vehicle's Most Severe Impact (Regardless Of Usage) _____ (0) No data obtained (1) CDC data only (2) Trajectory data only (3) CDC and crush profile only (4) CDC and trajectory data only (5) CDC, crush profile, and trajectory data</p>	<p>10. Reconstruction Program (Most Severe Impact) _____ (0) Not present (1) Added (2) Dropped (3) Changed (4) Correct</p> <p>11. Reason(s) Program Results Dropped Or Changed a. Algorithm choice b. Collision type c. Vehicle type d. Size/stiffness/weight e. Improved PDOF f. CDC g. Trajectory data h. Damage data i. Heading angle for Oldmiss</p> <table style="width:100%; text-align: center; border-collapse: collapse;"> <tr> <td>a</td><td>b</td><td>c</td><td>d</td><td>e</td><td>f</td><td>g</td><td>h</td><td>i</td> </tr> <tr> <td style="border: 1px solid black; width: 20px; height: 20px;"></td> <td style="border: 1px solid black; width: 20px; height: 20px;"></td> <td style="border: 1px solid black; width: 20px; height: 20px;"></td> <td style="border: 1px solid black; width: 20px; height: 20px;"></td> <td style="border: 1px solid black; width: 20px; height: 20px;"></td> <td style="border: 1px solid black; width: 20px; height: 20px;"></td> <td style="border: 1px solid black; width: 20px; height: 20px;"></td> <td style="border: 1px solid black; width: 20px; height: 20px;"></td> <td style="border: 1px solid black; width: 20px; height: 20px;"></td> </tr> </table> <p>(Blank) Correct or no reconstruction (1) Incorrect</p> <p style="text-align: center;">DATA STATUS OF VARIABLE NUMBERS 3-55</p> <table style="width:100%; text-align: center; border-collapse: collapse;"> <tr> <td>3</td><td>4</td><td>5</td><td>6</td><td>7</td><td>8</td><td>9</td><td>10</td><td>11</td><td>12</td><td>13</td> </tr> <tr> <td style="border: 1px solid black; width: 20px; height: 20px;"></td> <td style="border: 1px solid black; width: 20px; height: 20px;"></td> <td style="border: 1px solid black; width: 20px; height: 20px;"></td> <td style="border: 1px solid black; width: 20px; height: 20px;"></td> <td style="border: 1px solid black; width: 20px; height: 20px;"></td> <td style="border: 1px solid black; width: 20px; height: 20px;"></td> <td style="border: 1px solid black; width: 20px; height: 20px;"></td> <td style="border: 1px solid black; width: 20px; height: 20px;"></td> <td style="border: 1px solid black; width: 20px; height: 20px;"></td> <td style="border: 1px solid black; width: 20px; height: 20px;"></td> <td style="border: 1px solid black; width: 20px; height: 20px;"></td> </tr> <tr> <td>14</td><td>15</td><td>16</td><td>17</td><td>18</td><td>19</td><td>20</td><td>21</td><td>22</td><td>23</td><td>24</td> </tr> <tr> <td style="border: 1px solid black; width: 20px; height: 20px;"></td> <td style="border: 1px solid black; width: 20px; height: 20px;"></td> <td style="border: 1px solid black; width: 20px; height: 20px;"></td> <td style="border: 1px solid black; width: 20px; height: 20px;"></td> <td style="border: 1px solid black; width: 20px; height: 20px;"></td> <td style="border: 1px solid black; width: 20px; height: 20px;"></td> <td style="border: 1px solid black; width: 20px; height: 20px;"></td> <td style="border: 1px solid black; width: 20px; height: 20px;"></td> <td style="border: 1px solid black; width: 20px; height: 20px;"></td> <td style="border: 1px solid black; width: 20px; height: 20px;"></td> <td style="border: 1px solid black; width: 20px; height: 20px;"></td> </tr> <tr> <td>25</td><td>26</td><td>27</td><td>28</td><td>29</td><td>30</td><td>31</td><td>32</td><td>33</td><td>34</td><td>35</td> </tr> <tr> <td style="border: 1px solid black; width: 20px; height: 20px;"></td> <td style="border: 1px solid black; width: 20px; height: 20px;"></td> <td style="border: 1px solid black; width: 20px; height: 20px;"></td> <td style="border: 1px solid black; width: 20px; height: 20px;"></td> <td style="border: 1px solid black; width: 20px; height: 20px;"></td> <td style="border: 1px solid black; width: 20px; height: 20px;"></td> <td style="border: 1px solid black; width: 20px; height: 20px;"></td> <td style="border: 1px solid black; width: 20px; height: 20px;"></td> <td style="border: 1px solid black; width: 20px; height: 20px;"></td> <td style="border: 1px solid black; width: 20px; height: 20px;"></td> <td style="border: 1px solid black; width: 20px; height: 20px;"></td> </tr> <tr> <td>36</td><td>37</td><td>38</td><td>39</td><td>40</td><td>41</td><td>42</td><td>43</td><td>44</td><td>45</td><td>46</td> </tr> <tr> <td style="border: 1px solid black; width: 20px; height: 20px;"></td> <td style="border: 1px solid black; width: 20px; height: 20px;"></td> <td style="border: 1px solid black; width: 20px; height: 20px;"></td> <td style="border: 1px solid black; width: 20px; height: 20px;"></td> <td style="border: 1px solid black; width: 20px; height: 20px;"></td> <td style="border: 1px solid black; width: 20px; height: 20px;"></td> <td style="border: 1px solid black; width: 20px; height: 20px;"></td> <td style="border: 1px solid black; width: 20px; height: 20px;"></td> <td style="border: 1px solid black; width: 20px; height: 20px;"></td> <td style="border: 1px solid black; width: 20px; height: 20px;"></td> <td style="border: 1px solid black; width: 20px; height: 20px;"></td> </tr> <tr> <td>47</td><td>48</td><td>49</td><td>50</td><td>51</td><td>52</td><td>53</td><td>54</td><td>55</td> </tr> <tr> <td style="border: 1px solid black; width: 20px; height: 20px;"></td> <td style="border: 1px solid black; width: 20px; height: 20px;"></td> <td style="border: 1px solid black; width: 20px; height: 20px;"></td> <td style="border: 1px solid black; width: 20px; height: 20px;"></td> <td style="border: 1px solid black; width: 20px; height: 20px;"></td> <td style="border: 1px solid black; width: 20px; height: 20px;"></td> <td style="border: 1px solid black; width: 20px; height: 20px;"></td> <td style="border: 1px solid black; width: 20px; height: 20px;"></td> <td style="border: 1px solid black; width: 20px; height: 20px;"></td> <td style="border: 1px solid black; width: 20px; height: 20px;"></td> <td style="border: 1px solid black; width: 20px; height: 20px;"></td> </tr> </table> <p>Data Status Codes: (Blank) Correct (1) Derived error (2) Non-correctable error (3) Correctable error (4) Change - no error (5) MDE error (9) Unknown coded</p>	a	b	c	d	e	f	g	h	i										3	4	5	6	7	8	9	10	11	12	13												14	15	16	17	18	19	20	21	22	23	24												25	26	27	28	29	30	31	32	33	34	35												36	37	38	39	40	41	42	43	44	45	46												47	48	49	50	51	52	53	54	55											
a	b	c	d	e	f	g	h	i																																																																																																																							
3	4	5	6	7	8	9	10	11	12	13																																																																																																																					
14	15	16	17	18	19	20	21	22	23	24																																																																																																																					
25	26	27	28	29	30	31	32	33	34	35																																																																																																																					
36	37	38	39	40	41	42	43	44	45	46																																																																																																																					
47	48	49	50	51	52	53	54	55																																																																																																																							
<p>IF THIS CDS VEHICLE WAS NOT INSPECTED OR IF THIS WAS NOT A CDS VEHICLE, DO NOT COMPLETE AN EXTERIOR OR INTERIOR VEHICLE LOG</p>																																																																																																																															



CRASHPC PROGRAM SUMMARY

Identifying Title

Primary
Sampling Unit

Case No - Stratum

Accident Event
Sequence No

Date (month, day, year) of Run

CRASHPC Vehicle Identification

Vehicle 1	_____	_____	_____	_____
Vehicle 2	_____	_____	_____	_____
	Year	Make	Model	NASS Veh. No.

GENERAL INFORMATION

VEHICLE 1				VEHICLE 2			
Size	_____			Size	_____		
Weight	_____ + _____ + _____ = _____			Weight	_____ + _____ + _____ = _____		
	Curb Occupant(s) Cargo				Curb Occupant(s) Cargo		
CDC	_____			CDC	_____		
PDOF	_____			PDOF	_____		
Stiffness	_____			Stiffness	_____		

SCENE INFORMATION

Rest and Impact Positions No, Go To Damage Information Yes

VEHICLE 1		VEHICLE 2	
Rest Position		Rest Position	
X	_____ . _____	X	_____ . _____
Y	_____ . _____	Y	_____ . _____
PSI	_____ . _____	PSI	_____ . _____
Impact Position		Impact Position	
X	_____ . _____	X	_____ . _____
Y	_____ . _____	Y	_____ . _____
PSI	_____ . _____	PSI	_____ . _____
Slip Angle	_____	Slip Angle	_____

VEHICLE MOTION

Sustained Contact No Yes

VEHICLE 1				VEHICLE 2			
Skidding	<input type="checkbox"/> No <input type="checkbox"/> Yes			Skidding	<input type="checkbox"/> No <input type="checkbox"/> Yes		
Skidding Stop Before Rest	<input type="checkbox"/> No <input type="checkbox"/> Yes			Skidding Stop Before Rest	<input type="checkbox"/> No <input type="checkbox"/> Yes		
End-of-Skidding Position				End-of-Skidding Position			
X	_____ . _____			X	_____ . _____		
Y	_____ . _____			Y	_____ . _____		
PSI	_____ . _____			PSI	_____ . _____		
Curved Path	<input type="checkbox"/> No <input type="checkbox"/> Yes			Curved Path	<input type="checkbox"/> No <input type="checkbox"/> Yes		
Point on Path				Point on Path			
X	_____ . _____	Y	_____ . _____	X	_____ . _____	Y	_____ . _____
Rotation Direction	<input type="checkbox"/> None <input type="checkbox"/> CW <input type="checkbox"/> CCW			Rotation Direction	<input type="checkbox"/> Non <input type="checkbox"/> CW <input type="checkbox"/> CCW		
Rotation > 360°	<input type="checkbox"/> No <input type="checkbox"/> Yes			Rotation > 360°	<input type="checkbox"/> No <input type="checkbox"/> Yes		

National Accident Sampling System - Crashworthiness Data System: CrashPC Program Summary

FRICTION INFORMATION	TRAJECTORY INFORMATION
Coefficient of Friction . _____ Rolling Resistance Option _____ Vehicle 1 Rolling Resistance LF _____ RF _____ LR _____ RR _____ Vehicle 2 Rolling Resistance LF _____ RF _____ LR _____ RR _____	Trajectory Data <input type="checkbox"/> No <input type="checkbox"/> Yes <i>If No, Go To Damage Information</i> Vehicle 1 Steer Angles LF _____ RF _____ LR _____ RR _____ Vehicle 2 Steer Angles LF _____ RF _____ LR _____ RR _____ Terrain Boundary <input type="checkbox"/> No <input type="checkbox"/> Yes First Point X _____ . _____ Y _____ . _____ Second Point X _____ . _____ Y _____ . _____ Secondary Friction Coefficient . _____

DAMAGE INFORMATION			
	VEHICLE 1		VEHICLE 2
Damage Length	_____ . _____	Damage Length	_____ . _____
Crush Depths	C1 _____ . _____	Crush Depths	C1 _____ . _____
	C2 _____ . _____		C2 _____ . _____
	C3 _____ . _____		C3 _____ . _____
	C4 _____ . _____		C4 _____ . _____
	C5 _____ . _____		C5 _____ . _____
	C6 _____ . _____		C6 _____ . _____
Damage Offset	± _____ . _____	Damage Offset	± _____ . _____

IF THIS COMMON IMPACT WAS WITH A MOTOR VEHICLE *NOT IN TRANSPORT*, FILL IN THE INFORMATION BELOW

Model Year: _____ Make: _____ Model: _____ VIN: _____	The Weight, CDC, Scene Data and Damage Information for this vehicle should be recorded above.
--	---

Complete and ATTACH the appropriate vehicle damage sketch and dimensions to the Form.



OLDMISS PROGRAM SUMMARY

Identifying Title

Primary Sampling Unit

Case No — Stratum

Accident Event Sequence No

Date (mm dd yy) of Run

OLDMISS Vehicle Identification

Vehicle 1 _____

Vehicle 2 _____

Year Make Model NASS Vehicle No.

GENERAL INFORMATION

VEHICLE 1	VEHICLE 2
Size _____	Size _____
Weight _____ + _____ + _____ = _____ Curb Occupant(s) Cargo	Weight _____ + _____ + _____ = _____ Curb Occupant(s) Cargo
Damaged Area of Vehicle (F = Front, L = Left, R = Right, B = Back) _____ Vehicle 1	Damage Area of Vehicle (F = Front, L = Left, R = Right, B = Back) _____ Vehicle 2
Vehicle Heading Angles At Impact, in Degrees + _____ ° Vehicle 1	Vehicle Heading Angles At Impact, in Degrees + _____ ° Vehicle 2
Stiffness Category for Vehicle _____ Vehicle 1	Stiffness Category for Vehicle _____ Vehicle 2

DAMAGE INFORMATION

For Which Vehicle is The Damage Known? _____	Crush Measurements for Known Vehicle (Inches) C ₁ _____ C ₂ _____ C ₃ _____ C ₄ _____ C ₅ _____ C ₆ _____
PDOF for Know Vehicle in Degrees (– 180 to + 180) + _____ - _____	Damage Midpoint Offset (D) for Known Vehicle (Inches) + _____ - _____
Damage Length in Inches L for Known Vehicle _____	Estimated Damage Midpoint Offset (D) for Unknow Vehicle (Inches) + _____ - _____

Variable Name: Vehicle Number

Element Values:

Range: 01 through 30

Code the number assigned to this vehicle

Source: Police report.

Remarks:

Numbers assigned to vehicles must be consecutive starting with "01" and no numbers can be missing . Each in-transport motor vehicle must be assigned a unique number. Vehicle numbers are to be assigned consecutively according to the order NASS vehicles are listed on the PAR. If there are any NASS vehicles not listed on the PAR, then use the next consecutive number.

When one motor vehicle is towing another, the vehicle number or numbers assigned depends on the accident circumstances and the type of linkage between the vehicles. A fixed linkage is defined as one which has the property of keeping the towed unit separated from the power unit by a distance which is essentially constant. Included within this definition are cradle linkages where the towed unit has two or more wheels off the ground. A nonfixed linkage (such as a rope or a chain) requires the towed unit to be manually controlled.

If the linkage between the units is fixed, assign a vehicle number to the power (i.e., towing) unit only and consider the towed unit as cargo throughout the entire accident sequence, regardless of subsequent events/impacts sustained by the towed unit. In other words, a vehicle towed by a fixed linkage: (1) is never considered as an in-transport vehicle, (2) will not require vehicle forms, and (3) will be considered as cargo associated with the power unit.

If the linkage between the units is nonfixed, each vehicle is considered to be in-transport, and a vehicle number is assigned only to the vehicle(s) involved in the accident sequence.

Do not assign a vehicle number to any struck motor vehicle not in-transport (e.g., a vehicle parked off the roadway). Vehicle and occupant forms are not required for these vehicles. However, the vehicle is shown on the accident diagram and referred to as P-1, etc. Also, data which may be required to exercise the CRASH program are collected. The necessary data questions are located at the bottom of the second page of the CRASHPC Program Summary.

Variable Name: Vehicle Model Year

Element Values:

Range: 00 through 92

Code the last two digits of the model year

99 Unknown

Source: Primary source is the VIN during vehicle inspection; secondary sources include the police report and interviews.

Remarks:

Code the last two digits of the model year for which the vehicle was manufactured. A vehicle manufactured as a 1992 model is coded "92".

Code "99" (Unknown) if the vehicle model year cannot be determined.

Variable Name: Vehicle Make (specify):

Element Values:

Passenger Vehicles/Light Trucks (01-69)

	<u>GV06</u> <u>Subpage</u>		<u>GV06</u> <u>Subpage</u>
01 American Motors	1st	30 Volkswagen	(20)
02 Jeep (includes Kaiser-Jeep)	(2)	31 Alfa Romeo	(21)
03 AM General	(2)	32 Audi	(21)
06 Chrysler	(3)	33 Austin/Austin Healey	(22)
07 Dodge	(4)	34 BMW	(22)
08 Imperial	(6)	35 Nissan/Datsun	(23)
09 Plymouth	(6)	36 Fiat	(24)
10 Eagle	(7)	37 Honda	(25)
12 Ford	(8)	38 Isuzu	(26)
13 Lincoln	(10)	39 Jaguar	(27)
14 Mercury	(11)	40 Lancia	(27)
		41 Mazda	(28)
		42 Mercedes Benz	(29)
		43 MG	(30)
18 Buick	(12)	44 Peugeot	(30)
19 Cadillac	(13)	45 Porsche	(31)
20 Chevrolet	(14)	46 Renault	(31)
21 Oldsmobile	(16)	47 Saab	(32)
22 Pontiac	(17)	48 Subaru	(32)
23 GMC	(18)	49 Toyota	(33)
24 Saturn	(19)	50 Triumph	(34)
		51 Volvo	(35)
29 Other domestic: GV06 =	(19)	52 Mitsubishi	(36)
001 - Studebaker/Avanti		53 Suzuki	(37)
002 - Checker		54 Acura	(37)
398 - Other domestic (i.e., DeSoto Hudson, Packard)		55 Hyundai	(38)
		56 Merkur	(38)
		57 Yugo	(38)
		58 Infiniti	(39)
		59 Lexus	(39)
		60 Daihatsu	(39)
		69 Other foreign	(40)

Motored Cycle/ATC/ATV (70-79)

	<u>GV06</u> <u>Subpage</u>		<u>GV06</u> <u>Subpage</u>
70 BSA	(41)	78 All mopeds other than those above	(41)
71 Ducati	(41)	79 Other Motored Cycle	(41)
72 Harley-Davidson	(41)		
73 Kawasaki	(41)	Also see: [34] - BMW	(22)
74 Moto-Guzzi	(41)	[37] - Honda	(25)
75 Norton	(41)	[50] - Triumph	(34)
76 Yamaha	(41)	[53] - Suzuki	(37)

Medium/Heavy Trucks and Buses (80-89)

	<u>GV06</u> <u>Subpage</u>	Also see:	<u>GV06</u> <u>Subpage</u>
80 Brockway	(43)		
81 Diamond Reo/Reo	(43)		
82 Freightliner/White	(43)	[03] AM General	(2)
83 FWD	(43)	[07] Dodge	(5)
84 International	(42)	[12] Ford	(9)
Harvester/Navistar		[20] Chevrolet	(15)
85 Kenworth	(43)	[23] GMC	(18)
86 Mack	(43)	[35] Nissan/Datsun	(23)
87 Peterbilt	(43)	[36] Fiat	(24)
88 Iveco/Magirus	(43)	[38] Isuzu	(26)
89 Other: GV06 =	(43)	[42] Mercedes Benz	(29)
801 - Autocar		[51] Volvo	(35)
802 - Auto-Union-DKW		[52] Mitsubishi	(36)
803 - Divco			
804 - Western Star			
805 - Oshkosh			
898 - Other truck (e.g., Ward LaFrance, Marmon)			
901 - Grumman (bus)			
902 - NeoPlan (bus)			
950 - Truck based motorhome			
997 - Other bus			
998 - Other vehicle (i.e., farm vehicle, go-kart)			

Unknown (99)

99 Unknown

Source: Vehicle inspection, police report, and interview

Remarks:

Write the Vehicle Make in the available space for ready visual reference.

Code "99" (Unknown) is used for a "hit-and-run" vehicle unless reliable evidence indicates the vehicle's make.

Variable Name: Vehicle Model (specify):

Element Values:

MAKE "01"

AMERICAN MOTORS*

CODE	MODEL	INCLUDES	YEAR	SIZE	STIFFNESS
001	Rambler/American	Rogue, Scrambler, 220, 440	all	3	3
002	Rebel/Matador	Barcelona, Classic Brougham, 550, 660, 770 Matador (-78), Marlin	all	114" WB = 4 118" WB = 5	4 5
003	Ambassador	Brougham, DPL, SST, DL, Limited, 880, 990	all	5	5
004	Pacer	Limited, DL	75-80	2	2
005	AMX	(2 seater only)	68-70	2	2
006	Javelin	SST, AMX (71-74)	all	2	2
007	Hornet/Concord	Sportabout, Limited, DL, SC-360, SST, AMX (75-78)	all	2	2
008	Spirit/Gremlin	Limited, DL, Custom, X, GT (83-on) AMX (79-on)	all	2	2
009	Eagle	Concord based	80-87	3	3
010	Eagle SX-4	Spirit/Gremlin based	81-84	2	2
398	Other passenger vehicle		-	-	-
999	Unknown		-	-	-

* Alliance, Encore, Premier--See Renault - Make "48"

Variable Name: Vehicle Model (specify): [cont'd.]

MAKE "02" JEEP (Includes KAISER-JEEP)

CODE	MODEL	INCLUDES	YEAR	SIZE	STIFFNESS
401	CJ-2/CJ-3/CJ-4	Military	-66	81" WB = 1 101" WB = 2	7** 7**
402	CJ-5/CJ-6/CJ-7	Scrambler, Golden Eagle, Renegade, Laredo, Wrangler	67-on	84" WB = 1 104" WB = 3	7**
403	YJ-series	Wrangler	86-on	1	7**
404	Wagoneer	Custom, Brougham Limited Grand Wagoneer	71-on	2 3	7** 7**
405	Cherokee	Wide Track, Chief, Commando, Jeepster	all	2	7**
410	Pickup	J-10, J-20, Honcho	all	per WB	7**
411	Comanche	Chief	86-on	111" WB = 3 119" WB = 4	7** 7**
498	Other light truck		-	-	-
999	Unknown		-	-	-

** Applies to front and rear impacts. Use size value for side impacts.

MAKE "03" AM GENERAL

CODE	MODEL	INCLUDES	YEAR	SIZE	STIFFNESS
401	Dispatcher	Post Office (Jeep)	all	1	1
420	Dispatcher	DJ-series-Post Office Van	all	N/A	N/A
498	Other light truck		-	-	-
884	Medium/Heavy	Military off-road	-	-	-
898	Other medium/heavy truck		-	-	-
903	Bus (rear engine)	Transit	all	N/A	N/A
997	Other bus		all	N/A	N/A
999	Unknown		-	-	-

Variable Name: Vehicle Model (specify): [cont'd.]

MAKE "06"

CHRYSLER

CODE	MODEL	INCLUDES	YEAR	SIZE	STIFFNESS
009	Cordoba	Crown, 300, LS	75-83	4	4
010	New Yorker/Newport/ 5th Avenue/Imperial	Custom, Royal, Brougham, Town and Country, 300 (-71) (excludes all FWD)	-78 79-81 82-89	6 5 4	6 5 4
014	New Yorker/E Class/ Imperial (90-on)	FWD vehicles, Turbo	83-on	3	9***
015	Laser	Turbo, XE, XT	84-86	2	9***
016	Lebaron	Medallion, Salon (RWD) FWD except GTS or GTC Sport Coupe	77-81 82-on	4 2	4 9***
017	Lebaron GTS/GTC	GTS-Turbo GTC-Sport Coupe	85-on 87-on	3 2	9*** 9***
031	TC (Maserati Sport)	Turbo Convertible	88-on	1	1
035	Conquest	TSI, Turbo	87-on	2	2
398	Other passenger vehicle		-	-	-
472	Town and Country	Minivan	90-on	5	7**
999	Unknown		-	-	-

*** Code 9 applies only to frontal impacts. Use size code for stiffness for side or rear impacts.

Variable Name: Vehicle Model (specify): [cont'd.]

MAKE "07"

DODGE

CODE	MODEL	INCLUDES	YEAR	SIZE	STIFFNESS
001	Dart	Custom, Swinger, Sport, GT, Demon, Special, Special Edition, 170, 270, 340, 360	62-70 71-76	111" WB = 4 108" WB = 3	4 3
002	Coronet/Charger (-78)/ Magnum	Brougham, Custom, Superbee, Crestwood, Deluxe, XE, R/T, SE 440, 500, Police	-79	4	4
003	Polara/Monaco Royal Monaco	Custom, Special, Crestwood, Brougham, Police, Taxi	-76 77-78	5 4	5 4
005	Challenger	R/T, T/A, Rallye	70-74	3	3
006	Aspen	Custom, Special Edition, Police, R/T, Sport	76-80	113" WB = 4 109" WB = 3	3 3
007	Diplomat	Medallion, Salon, S	77-on	4	4
008	Omni/Charger (83 on)	024, DeTomaso, Miser, GLH, GLHS Shelby, Charger 2.2, America, Expo	78-on	2	2
009	Mirada		80-83	4	4
010	St. Regis	Police, Taxi	79-81	5	5
011	Aries (K)	Custom, SE, LE	81-on	2	9***
012	400	LS	82-83	2	9***
013	Rampage (car based pickup)	2.2, GT, Sport	82-84	2	2
014	600	ES, Turbo	83-88	2	9***
015	Daytona	Turbo Z, Shelby Z, Pacifica, C/S Competition	84-on	2	9***
016	Lancer	Pacifica, Turbo, ES, Shelby	85-on	3	9***
017	Shadow	ES, Turbo	87-on	2	9***
018	Dynasty		88-on	-	-
019	Spirit	ES, Shelby, R/T	89-on	3	9***
033	Challenger	all imported	78-83	2	2
034	Colt (excludes Vista)	RS, Turbo, Custom, GTS, DL, E, Premier, Deluxe, Carousel, GT	74-76 77-80	2 <93" WB = 1	2 1
			80-on	1	1
035	Conquest	Turbo	84-86	2	2
039	Stealth		91-on		
040	Monaco		90-on	3	3
398	Other passenger vehicle		-	-	-

*** Code 9 applies only to frontal impacts. Use size code for stiffness for side or rear impacts.

Variable Name: Vehicle Model (specify): [cont'd.]

MAKE "07"

DODGE (Continued)

CODE	MODEL	INCLUDES	YEAR	SIZE	STIFFNESS
443	D50, Colt P/U Ram 50		-82 83-on	per WB per WB	8** 8**
444	Vista	4 x 4	84-on	3	7**
445	Raider	Sport	8	1	8**
471	Ramcharger		all	3	8**
472	Caravan	Mini-Ram, 112 and 119 WB, SE	84-on	112" WB = 4 119" WB = 5	7** 7**
473	B, W-series pickup	Ram, Custom, Royal, Miser	all	per WB	8**
474	D-series vans	Sportsman, Royal, Maxiwagon, Ram	all	7	7**
475	Van derivative	Kary Van	all	7	7**

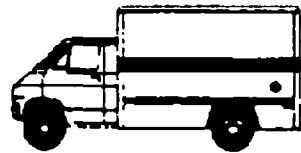

Parcel Van

477	Dakota		87-on	112" WB = 3 124" WB = 6	8**
498	Other light truck		-	-	-
881	Medium/Heavy: CBE		all	N/A	N/A
882	Medium/Heavy: COE low entry		all	N/A	N/A
883	Medium/Heavy: COE high entry		all	N/A	N/A
898	Other medium/heavy truck		all	N/A	N/A
901	Medium bus	(not van based)	all	N/A	N/A
997	Other bus		all	N/A	N/A
999	Unknown		-	-	-

** Applies to front and rear impacts. Use size value for side impacts.

*** Code 9 applies only to frontal impacts. Use size code for stiffness for side or rear impacts.

Variable Name: Vehicle Model (specify): [cont'd.]

MAKE "08"

IMPERIAL

CODE	MODEL	INCLUDES	YEAR	SIZE	STIFFNESS
010	Imperial	Lebaron Mark Cross, Frank Sinatra editions	-76 81-83	6 4	6 4
398	Other passenger vehicle		-	-	
999	Unknown		-	-	

MAKE "09"

PLYMOUTH

CODE	MODEL	INCLUDES	YEAR	SIZE	STIFFNESS
001	Valiant/Duster (-76)/ Scamp	100, 200, Brougham, Signet Custom, Special 340/360, 340, 360, Twister	-76	108" WB = 3 111" WB = 4	3 4
002	Satellite/Belvedere	Belvedere I/II, GTX, Roadrunner (-74), Sebring, Sebring Plus, Superbird, Brougham	-74	4	4
003	Fury	I, II, III, Roadrunner (75), Salon, VIP, Sport, Salon, Suburban	-74 75-78	5 4	5 4
004	Gran Fury	Sedan, Brougham, Custom Sport, Suburban	75-81 82-on	5 4	5 4
005	Barracuda	Formula, S, 340, AAR, 'Cuda Gran Coupe	65-73	3	3
006	Volare'	Custom, Premier, Roadrunner (76-on), Police	76-80	109" WB = 3 113" WB = 4	3 4
007	Caravelle	Turbo, SE	85-on	3	9***
008	Horizon	TC-3, Miser, Turismo 2.2, Custom, SE, Duster (85-on) America, Expo	78-on	2	2
011	Reliant (K)	SE, LE	81-on	2	9***
013	Scamp (car based pickup)	GT, 2.2	82-84	2	2
017	Sundance	Turbo	87-on	2	9***
019	Acclaim	LX, LE	89-on	3	9***
031	Cricket		71-72	2	2
032	Arrow	Fire Arrow, GS, GT	76-80	1	1
033	Sapparo	all imported	78-83	2	2

*** Code 9 applies only to frontal impacts. Use size code for stiffness for side or impacts.

Variable Name: Vehicle Model (specify): [cont'd.]

MAKE "09"

PLYMOUTH (Continued)

CODE	MODEL	INCLUDES	YEAR	SIZE	STIFFNESS
034	Champ/Colt (excludes Vista)	Turbo, Custom - Station Wagon (84-on)	79-on 84-on	1 103" WB = 3	1 2
035	Conquest	TSI	84-89	2	2
036	CHANGED TO CODE 037 IN 1990				
037	Laser	RS, Turbo	89-on	2	2
398	Other passenger vehicle				
444	Vista	4 x 4	87-on	3	7**
471	Trailduster		all	3	8**
472	Voyager (minivan)	SE	84-on	112" WB = 4 119" WB = 5	7** 7**
474	Van-fullsize	Voyager, Sport, Premier	all	7	7**
477	Arrow pickup (foreign)		all	per WB	8**
498	Other light truck				
999	Unknown				

MAKE "10"

EAGLE

CODE	MODEL	INCLUDES	YEAR	SIZE	STIFFNESS
034	Summit	DL, LX	89-on	3	3
037	Talon		90-on	2	2
040	Premier	LX, ES	88-on	3	3
044	Medallion	DL, LX	88-on	3	3
398	Other passenger vehicle				
999	Unknown				

** Applies to front and rear impacts. Use size for side impacts.

Variable Name: Vehicle Model (specify): [cont'd.]

MAKE "12"

FORD

CODE	MODEL	INCLUDES	YEAR	SIZE	STIFFNESS
001	Falcon	Sprint, GT, Futura	thru-70	4	3
002	Fairlane	Torino thru 1970	thru-70	4	4
003	Mustang/Mustang II	Mach, Boss, Grande, Cobra Ghia, SVO, GT, LX, Shelby	65-73 74-on	3 2	3 2
004	Thunderbird (all sizes)	Landau, Heritage, Turbo coupe, Elan, Fila, Sport, LX SC	72-76 58-71, 77-79 55-57, 80-88 89-on	5 4 3 4	6 4 3 4
005	LTD II	S, Squire, Brougham	77-79	4	4
006	LTD/Custom/Galaxie (all sizes)	XL, Landau, Ranch Wagon, Country Squire, S, 500, Brougham, XL GT	thru-77 78-82 83-on	5 4 3	5 4 3
007	Ranchero	Falcon/Fairlane based Torino/LTD II based	thru-71 72-79	3 4	3 4
008	Maverick	Grabber	70-77	3	3
009	Pinto	Pony, MPG, ESS	71-80	1	1-Front 2-Rear
010	Torino/Gran Torino/Elite	GT, Cobra, Sport, Squire, Brougham	71-76	4	4
011	Granada	ESS, Ghia	75-82	3	3
012	Fairmont	Futura, Sport Coupe	78-83	3	3
013	Escort/EXP	L, GL, GLX, SS, GT	81-on	1	9***
015	Tempo	L, GL, GLX, Sport, 4 x 4	84-on	2	9***
016	Crown Victoria		81-on	4	4
017	Taurus	MT-5, L, GL, LX, SHO	86-on	3	3
018	Probe	GL, LX, GT	88-on	2	2
031	English Ford	Cortina		per WB	per WB
032	Fiesta	Sport, Ghia	78-80	1	1
033	Festiva		88-on	1	1
398	Other passenger vehicle	Laser	all	per WB	per WB

*** Code 9 applies only to frontal impacts. Use size code for stiffness for side or rear impacts.

Variable Name: Vehicle Model (specify): [cont'd.]

MAKE "12"

FORD (Continued)

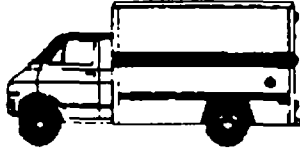
CODE	MODEL	INCLUDES	YEAR	SIZE	STIFFNESS
470	Bronco II/Bronco (-77)/ Explorer	Eddie Bauer, XL, XLT, Explorer (90-on)	83-on	1	7**
471	Bronco-fullsize	Eddie Bauer, Custom, XL, XLT	78-on	3	8**
472	Aerostar	XLT, Cargo Van	86-on	7	7**
473	F-series pickup	F-100 - F-350	all	per WB	8**
474	E-series vans	Econoline, Clubwagon, Chateau	all	7	7**
475	Van derivative	i.e.:	all	7	7**
					
Parcel Van					
477	Ranger	Supercab, 4 x 4, STX	82-on	108" WB = 3 114" WB = 4	8** 8**
478	Courier	Imported pickup	all	7	7**
498	Other light truck		-	-	-
881	Medium/Heavy CBE	F-5 through F-8 L-series, FT-series	all	N/A	N/A
882	Medium/Heavy COE low entry	C/CT series	all	N/A	N/A
883	Medium/Heavy COE high entry	C/CLT series	all	N/A	N/A
898	Other medium/heavy truck		-	-	-
901	Medium bus	B-series (not van based)	all	N/A	N/A
997	Other bus		all	N/A	N/A
998	Other vehicle		-	-	-
999	Unknown		-	-	-

** Applies to front and rear impacts. Use size value for side impacts.

Variable Name: Vehicle Model (specify): [cont'd.]

MAKE "13"

LINCOLN

CODE	MODEL	INCLUDES	YEAR	SIZE	STIFFNESS
001	Continental/Town Car	Continental (-81), Town Car (82-on)	thru-79 80-on	6 4	6 5
002	Mark	I, II, III, IV, V, VI, VII, LSC, all Signature/Designer Series	-70 71-80 80-83 84-on	4 5 4 3	4 5 4 3
005	Continental (82-on)	All Signature/Designer Series	82-87 88-on	4 3	5 3
011	Versailles		77-80	3	3
398	Other passenger vehicle		-	-	-
999	Unknown		-	-	-

Variable Name: Vehicle Model (specify): [cont'd.]

MAKE "14" MERCURY (MERKUR: See "56")

CODE	MODEL	INCLUDES	YEAR	SIZE	STIFFNESS
002	Cyclone	GT, CJ, Spoiler	thru-71	4	4
003	Capri-domestic	RS, Turbo, GS, Black Magic	79-86	2	2
004	Cougar/XR7	XR-7, RS, LS, GS, Eliminator, Bougham, Villager, (includes all body styles)	67-76 77-79 80-88 89-on	4 114" WB = 4 118" WB = 5 3 4	4 4 5 3 4
006	Marquis/Monterey	Marauder, X-100, Parklane, S-55, Custom, Brougham, Montclair, Grand Marquis	thru-78 79-82 82-on	121" WB = 5 124" WB = 6 4 106" WB = 3 114" WB = 4	5 6 4 3 4
008	Comet	Caliente, GT, Voyager, 202, Capri (66-67)	62-67 71-77	4 3	4 3
009	Bobcat	Runabout, Villager	75-80	1	1-Front 2-Rear
010	Montego	Comet (68-70), GT, MX, Villager, Brougham	68-73 72-76	3 114" WB = 3 118" WB = 4	3 3 4
011	Monarch	Ghia	75-80	3	3
012	Zephyr	GS, Z-7	78-83	3	3
013	Lynx/LN-7 (82-83)	L, LS, GS, RS, XR-3	81-on	1	9***
015	Topaz	L, LS, GS, 4 x 4	84-on	2	9***
017	Sable	LS, GS	86-on	3	3
031	Capri - foreign	Capri II 2 + 2	70-77 90-on	2 1	2 1
033	Pantera	deTomaso	72-74	2	2
036	Tracer	L, GL	88-on	1	1
398	Other passenger vehicle		-	-	-
999	Unknown		-	-	-

*** Code 9 applies only to frontal impacts. Use size code for stiffness for side or rear impacts.

Variable Name: Vehicle Model (specify): [cont'd.]

MAKE "18"

BUICK

CODE	MODEL	INCLUDES	YEAR	SIZE	STIFFNESS
001	Special/Skylark	GS, GS-350, GS-400, GS-455, GS California, Sport wagon, Custom	thru 72	4	4
002	LeSabre/Centurion/ Wildcat	Estate Wagon, Luxus, Invicta, Custom, Limited T-Type	-76 77-85 86-on	6 4 4	6 4 9***
003	Electra/Electra 225/ Park Avenue (91-on)	Limited, Park Avenue, Ultra	-76 77-84 85-on	6 5 4	6 5 9***
004	Roadmaster	Estate Wagon, Limited	91-on	4	4
005	Riviera	S-Type, T-Type	63-65 66-76 77-85 86	4 5 4 3	4 5 4 9***
007	Century	Luxus, T-Type, FWD (82-on) Custom, Regal (72-77)	thru 77 78-81 82-on	4 3 3	4 3 9***
008	Apollo/Skylark*	Skylark (75)*, S/R	73-76	4	4
010	Regal	Turbo, Luxus, Grand National, GNX, T-Type	78-88	3	3
012	Skyhawk	S-Type, Roadhawk, T-Type, GT	75-81 82-on	2 2	2 9***
015	Skylark (76-85)	(except 75), S/R, S, Limited, Sport, T-Type	76-79 80-85	4 3	4 9***
018	Somerset/Skylark**	Skylark (86-on)**, Somerset Regal, Custom, Limited, T-Type	85-on	3	9***
020	Regal (FWD)	Limited	88-on	3	9***
021	Reatta		88-on	TBD	TBD
031	Opel Kadett		-75	2	2
032	Opel Manta	1900, Luxus, Rallye, Sports Coupe	-75	2	2
033	Opel GT		-75	2	2
034	Opel Isuzu	Deluxe, Sport	76-79	1	1
398	Other passenger vehicle		-	-	-
999	Unknown		-	-	-

*** Code 9 applies only to frontal impacts. Use size code for stiffness for side or rear impacts.

Variable Name: Vehicle Model (specify): [cont'd.]

MAKE "19"

CADILLAC

CODE	MODEL	INCLUDES	YEAR	SIZE	STIFFNESS
003	Deville/Fleetwood (except Limousine)	Coupe de Ville, Sedan de Ville, Fleetwood Bougham, Fleetwood 60 Special, d'Elegance	-76 RWD 77-on FWD 85-on	6 5 4	6 5 9***
004	Limousine	Fleetwood 75, Formal DeVillie-based	all	6	6
005	Eldorado	Biarritz, El-doro, Touring Coupe	-78 79-85 86-on	6 4 3	6 4 9***
006	Commercial Series	Ambulance/Hearse	all	6	6
009	Allante'		87-on	2	2
014	Seville	Elegante	76-85 86-on	4 3	4 9***
016	Cimarron	D'oro	82-88	2	9***
398	Other passenger vehicle		-	-	-
999	Unknown		-	-	-

*** Code 9 applies only to frontal impacts. Use size code for stiffness for side or rear impacts.

Variable Name: Vehicle Model (specify): [cont'd.]

MAKE "20"

CHEVROLET

CODE	MODEL	INCLUDES	YEAR	SIZE	STIFFNESS
001	Chevelle/Malibu	Classic, Concours, S-3, Laguna, Nomad, 300, Greenbriar, Estate, Deluxe, SS 396/454	64-77 78-83	4 3	4 3
002	Impala/Caprice	Biscayne, Belair, Super Sport, Classic, Classic Brougham, Townsman Brookwood, Kingswood	-76 77-on	5 St. Wgn.=6 4	5 6 4
004	Corvette	Stingray	53-62 63-on	3 2	3 2
006	Corvair	Monza, Corsa, 500, Yenko	60-69	N/A	N/A
007	El Camino	Royal Knight, SS	59-60 64-77 78-on	5 4 3	8** 8** 8**
008	Nova (-79)	Chevy II, LN, LE, Concours SS-350/396, Rally	62-79	4	4
009	Camaro	SS, RS, LT, Berlinetta, IROC-Z, Z28	67-on	3	3
010	Monte Carlo	LS, SS, Aerocoupe, Landau	70-77 78-88	4 3	4 3
011	Vega	GT, Cosworth	71-77	2	2
012	Monza	Spyder, 2 + 2, Towne Coupe	75-80	2	2
013	Chevette	S, Scooter, CS	76-87	2dr-1 4dr-2	1 2
015	Citation	X-11, Citation II	80-85	3	9***
016	Cavalier	CS, RS, Z24	82-on	2	9***
017	Celebrity	CS, Eurosport, VR	82-on	3	9***
019	Beretta/Corsica	GT	88-on	3	9***
020	Lumina	(GM-10 based), Z-34	90-on	3	9***
031	Spectrum		85-on	1	1
032	Nova/Geo Prizm	CL, NUMMI-built vehicles	85-on	2	9**
033	Sprint/Geo Sprint		85-on	1	1
034	Geo Metro	LSi	89-on	1	1
035	Geo Storm		85-on	1	1
398	Other passenger vehicle		-	-	-

** Applies to front and rear impacts. Use size value for side impacts.

*** Code 9 applies only to frontal impacts. Use size code for stiffness for side or rear impacts.

Variable Name: Vehicle Model (specify): [cont'd.]

MAKE "20" CHEVROLET (Continued)

CODE	MODEL	INCLUDES	YEAR	SIZE	STIFFNESS
470	S-10 Blazer	S-10 p/u based (100.5" WB)	83-on	2	7**
471	Fullsize Blazer	K-series, fullsize p/u based	69-on	3	8**
472	Astro Van	Minivan	85-on	7	7**
473	C-series pickup	C10-C30, Silverado K-series	all	per WB	8**
474	G-series van	Beauville, Chevy Van, Sport Van	all	7	7**
475	Van derivative	Hi-cube, Parcel Van	all	7	7**
476	Suburban	All models	all	6	8**
477	S-10		82-on	per WB	8**
478	LLV	Imported pickup	all	7	7**
479	Geo Tracker	LSi	89-on	2	8**
480	Lumina APV		90-on	per WB	TBD
498	Other light truck	Includes Grumman LLV Postal Vehicle	-	-	-
881	Medium/Heavy CBE	C50/60/65; M60/65; H70/80/90; J70/80/90; Bison 90; all other CBE	all	N/A	N/A
882	Medium/Heavy COE low entry	T60/65 - all other COE low entry	all	N/A	N/A
883	Medium/Heavy COE high entry	Titan 90, all other COE high entry	all	N/A	N/A
898	Other medium/heavy truck	-	all	N/A	N/A
901	Bus	S-60 series	all	N/A	N/A
997	Other bus		all	N/A	N/A
999	Unknown	-	-	-	-

** Applies to front and rear impacts. Use size value for side impacts.

Variable Name: Vehicle Model (specify): [cont'd.]

MAKE "21"

OLDSMOBILE

CODE	MODEL	INCLUDES	YEAR	SIZE	STIFFNESS
001	Cutlass (RWD-only)	Supreme, S, LS, Salon Brougham, Vista Cruiser, F85 (thru 72) Rallye 350, Hurst Olds, 442, Calais, Classic (88)	-77 78-88	4 3	4 3
002	Delta 88	Royale, Custom, Delta, Jetstar 88, Delmont 88, Starfire (thru 66), Custom Cruiser	-76 77-85 86-on	6 4 4	6 4 9***
003	Ninety-Eight	Regency, Luxury	-76 77-84 85-on	6 5 4	6 5 4
005	Toronado	XSR, Trofeo, Brougham Custom	66-78 79-85 86-on	5 4 3	5 4 3
006	Commercial Series	Ambulance/Hearse	all	6	6
012	Starfire	SX, GT	75-80	2	2
015	Omega	X-body type	RWD 75-79 FWD 80-85	4 3	4 9
016	Firenza	S, LS, SX, Cruiser, GT	82-88	2	9***
017	Ciera	Cutlass Ciera, Brougham, ES	82-on	3	9***
018	Calais	GT, ES, 500	85-on	3	9***
020	Cutlass (FWD)	Supreme	88-on	3	9***
398	Other passenger vehicle		-	-	-
470	Bravado		91-on	TBD	1BD
480	Silhouette		90-on	per WB	1BD
999	Unknown		-	-	-

*** Code 9 applies only to frontal impacts. Use size code for stiffness for side or rear impacts.

Variable Name: Vehicle Model (specify): [cont'd.]

MAKE "22"

PONTIAC

CODE	MODEL	INCLUDES	YEAR	SIZE	STIFFNESS
001	Lemans/Tempest (thru 79)	Safari, T-37, Luxury, Grand Sport, GTO (-73), GT-37, Sprint, Judge Grand AM (73-75) Grand Lemans	thru 77 78-79	4 3	4 3
002	Bonneville/Catalina/ Parisienne*	Brougham, Grand Safari, Safari, Grandville, 2+2 Executive, Starchief SE, SSE * Parisienne	-68 69-76 77-81 82-84 87-on 83-84	5 6 4 3 4 4	5 6 4 3 4 4
005	Fiero	2M4, 2M6, GT, SE	84-88	1	1
008	Ventura	II, SJ, Sprint, GTO (74-on) Custom	71-77	4	4
009	Firebird/Trans AM	Esprit, Formula, GTA, Redbird, Yellowbird, Skybird, SE	67-81 82-on	3 2	3 2
010	Grand Prix (RWD)	J, LJ, SJ, Brougham, 2+2	63-72 73-77 78-87	5 4 3	5 4 3
011	Astre	Safari, SJ, Custom	75-77	2	2
012	Sunbird (thru 80)	Safari, Sport, Formula	76-80	2	2
013	T-1000/1000		81-87	2dr-1 4dr-2	1 2
015	Phoenix	LJ, SJ	77-79 80-84	4 3	4 9***
016	J2000/2000/Sunbird	Sunbird (85-on), LE, SE, GT, Convertible	82-on	2	9***
017	6000	STE, SE, LE	82-on	3	9***
018	Grand AM	SE, LE	80 85-on	3 3	3 9***
020	Grand Prix (FWD)	SE, McLaren Turbo, GTP	88-on	3	9***
031	Lemans (88-on)	SE, Tempest (Canadian)	88-on	2	2
398	Other passenger vehicle		-	-	-
480	Trans Sport		90-on	per WB	TBD
999	Unknown		-	-	-

*** Code 9 applies only to frontal impacts. Use size code for stiffness for side or rear impacts.

Variable Name: Vehicle Model (specify): [cont'd.]

MAKE "23"

GMC

CODE	MODEL	INCLUDES	YEAR	SIZE	STIFFNESS
007	Caballero/Sprint	Sierra Madre del Sur, SP	-77 78-on	4 3	E** E**
398	Other passenger vehicle		-	-	-
470	Jimmy	S15 based (100.5" WB)	83-on	2	7**
471	Fullsize Jimmy	fullsize pickup based	all	3	E**
472	Safari (Minivan)		86-on	7	7**
473	C and K-series pickup	C15-35: K15-35	all	per WB	E**
474	G-series van	Rally Van, Vandura	all	7	7**
475	Van derivative	Hicube, parcel van, Value Van, Magna Van, P-series	all	7	7**
476	Suburban	all models	all	6	E**
477	S15		82-on	per WB	E**
498	Other light truck		-	-	-
881	Medium/Heavy CBE	W5000/6000/7000 series, Brigadier/General models	all	N/A	N/A
882	Medium/Heavy COE low entry	W6000/W7000, all other COE, low entry	all	N/A	N/A
883	Medium/Heavy COE high entry	Astro 95, all other COE, high entry	all	N/A	N/A
898	Other medium/heavy truck		all	N/A	N/A
901	Bus	B6000	all	N/A	N/A
997	Other bus		all	N/A	N/A
999	Unknown		-	-	-

** Applies to front and rear impacts. Use size value for side impacts.

Variable Name: Vehicle Model (specify): [cont'd.]

MAKE "24"

SATURN

CODE	MODEL	INCLUDES	YEAR	SIZE	STIFFNESS
001	SL		91-on	3	3
002	SC		91-on	2	2
398	Other passenger vehicle		-	-	-
999	Unknown		-	-	-

** Applies to front and rear impacts. Use size value for side impacts.

MAKE "29"

OTHER DOMESTIC MANUFACTURER

CODE	MODEL	INCLUDES	YEAR	SIZE	STIFFNESS
001	Studebaker/Avanti	Lark, Gran Turismo, Hawk, Cruiser, all associated subseries	thru-66	per WB	= size
002	Checker	Marathon, Superba, Taxi, Aerobus	thru-82	per WB	= size
398	Other auto	Desoto, Excaliber, Stutz, Hudson, Packard	all	per WB	= size

Variable Name: Vehicle Model (specify): [cont'd.]

MAKE "30"

VOLKSWAGEN

CODE	MODEL	INCLUDES	YEAR	SIZE	STIFFNESS
031	Karmann Ghia		-74	1	1
032	Beetle 1300/1500	flat windshield, 94.5" WB	-77	1	1
033	Super Beetle	distinguished by curved windshield, 95.3" WB	71-80	2	1
034	411/412	Squareback/Fastback	71-74	2	1
035	Squareback/Fastback	Type 3, 1600	-74	1	1
036	Rabbit	L, GTI, Sport, LS, Custom, DL, Deluxe	75-84	1	1
037	Dasher		74-81	2	2
038	Scirocco	16V	75-on	1	1
039	The Thing (181)		73-75	1	1
040	Jetta	GL, GLI	81-on	2	2
041	Quantum (82-88)/	Synco	82-on	2	2
042	Golf	Synco, GTI, Cabriolet, GT, GL	85-on	2	1
043	Rabbit pickup	car/based pickup	80-83	1	1
044	Fox		87-on	1	1
045	Corrado		89-on	TBD	TBD
046	Passat		90-on	2	2
398	Other imported auto		-	-	-
472	Vanagon/Camper	Bus, Kombi, Van	all	1	7**
498	Other light truck		-	-	-
999	Unknown		-	-	-

** Applies to front and rear impacts. Use size value for side impacts.

Variable Name: Vehicle Model (specify): [cont'd.]

MAKE "31"

ALFA ROMEO

CODE	MODEL	INCLUDES	YEAR	SIZE	STIFFNESS
031	Spider	All roadsters, Veloce, 1750/2000 roadsters	all	1	1
032	Sports Sedan	All 4 door sedans; Milano (86), Giulia, Super, Berlina, Alfetta, 1750/2000 sedans	all	per WB	= size
033	Sprint Veloce	All 2-door coupes; Alfetta GT, 1750/2000 GTV, Sprint GT	all	per WB	= size
034	GTV-6		81-on	1	1
035	164		89-on	TBD	TBD
398	Other passenger vehicle		-	-	-
999	Unknown		-	-	-

MAKE "32"

AUDI

CODE	MODEL	INCLUDES	YEAR	SIZE	STIFFNESS
031	Super 90		70-72	2	2
032	100	S, LS, GL Quattro (89-on)	70-77 89-on	3 3	3 3
033	Fox		74-79	2	2
034	4000	Quattro, Coupe GT, CS, S	80-	2	2
035	5000	Quattro, CS, S, Turbo	78-	3	3
036	80/90	Quattro	88-on	2	2
037	200	Quattro	89-on	TBD	TBD
038	V-8 Quattro		90-on	TBD	TBD
398	Other passenger vehicle		-	-	-
999	Unknown		-	-	-

Variable Name: Vehicle Model (specify): [cont'd.]

MAKE "33"

AUSTIN/AUSTIN HEALEY

CODE	MODEL	INCLUDES	YEAR	SIZE	STIFFNESS
031	Marina	GT	all	2	2
032	America		all	1	1
033	Healey Sprite		all	1	1
034	Healy 3000	Healy 100	all	1	1
035	Mini		all	1	1
398	Other passenger vehicle		-	-	-
999	Unknown		-	-	-

MAKE "34"

BMW

CODE	MODEL	INCLUDES	YEAR	SIZE	STIFFNESS
031	1600, 2002	Tii, 1800, 2000CS	-76	2	2
032	Coupe	2800CS, 3.0CS	69-76	3	3
033	Bavaria Sedan	2500, 2800	69-74	3	3
034	3-series	318i, 320i, 325e, 325es	77-on	2	2
035	5-series	524i, 528i, 530i, 533i, 535i, TD	75-on	3	3
036	6-series	630, 633, 635, csi	77-on	3	3
037	7-series	733i, 735i, L7	78-on	3	3
038	8-series	850	90-on		
398	Other passenger vehicle		-	-	-
	<u>Motorcycles</u>				
701	0-50cc				
702	51-124cc				
703	125-349cc				
704	350-449cc				
705	450-749cc				
706	750cc-over				
999	Unknown				

Variable Name: Vehicle Model (specify): [cont'd.]

MAKE "35"

NISSAN/DATSUN

CODE	MODEL	INCLUDES	YEAR	SIZE	STIFFNESS
031	F10		77-78	1	1
032	200/240 SX		78-83 84-on	1 2	1 2
033	1200/210/B210	Honeybee	71-82	1	1
034	Z-car, ZX	240/260/280Z, 300 ZX, Turbo 2 + 2 2 + 2	70-on 75-78 79-on	1 3 2	1 3 2
035	310		79-82	1	1
036	510	PL	68-73 78-81	2 1	2 1
037	610	PL	73-76	2	2
038	710	PL	74-77	2	2
039	810/Maxima		77-on	3	3
040	Roadster	SPL 311, SRL 311, 1600, 2000, convertible	-70	1	1
041	PL 411, RL 411		-67	1	1
042	Stanza	XE	82-on	2	2
043	Sentra		83-on	1	1
044	Pulsar	NX, EXA (86-on)	83-on	2	2
045	Micra		87-on	1	1
398	Other passenger vehicle		-	-	-
470	Pathfinder	MPV, 4 x 4	86-on	-	-
472	Van	XE, GXE	88-on	1	7**
477	Datsun/Nissan Pickup	PL620, King Cab, Hardbody	73-on	per WB	8**
480	Axxess		89-on	3	TBD
498	Other light truck	Patrol (1960)	-	-	-
883	Medium/Heavy COE high entry		all	N/A	N/A
898	Other medium/heavy truck		all	N/A	N/A
999	Unknown		-	-	-

** Applies to front and rear impacts. Use size values for side impacts.

Variable Name: Vehicle Model (specify): [cont'd.]

MAKE "36"

FIAT

CODE	MODEL	INCLUDES	YEAR	SIZE	STIFFNESS
031	124 (Coupe/Sedan)	Sport	67-75	1	1
032	124 Spider/Racer	Spider 2000/1500	68-83	1	1
033	Brava - 131		75-82	2	2
034	850 (Coupe/Spyder)		67-73	1	1
035	128		72-79	2	2
036	X-1/9		75-83	1	1
037	Strada		79-83	2	2
398	Other passenger vehicle	600, 1100	-	-	-
882	Medium/Heavy COE low entry		all	N/A	N/A
883	Medium/Heavy COE high entry		all	N/A	N/A
898	Other medium/heavy truck		all	N/A	N/A
999	Unknown		-	-	-

Variable Name: Vehicle Model (specify): [cont'd.]

MAKE "37" HONDA (ACURA: See "54")

CODE	MODEL	INCLUDES	YEAR	SIZE	STIFFNESS
031	Civic/CRX	1300, 1500, CVCC, DX CRX, S, Si, HF, 4WD Wagon	all	1	1
032	Accord	LX, CVCC, SE-i, LX-i, EX wagon	-81 82-86 87	1 2 3	1 9*** 9***
033	Prelude	Si	80-83 84-on	1 2	1 9***
034	600	Coupe, Sedan	all	1	1
398	Other passenger vehicle	all Honda's not listed above	all	per WB	= size
<u>Motorcycle</u>					
701	0-50cc				
702	51-124cc				
703	125-349cc				
704	350-449cc				
705	450-749cc				
706	750cc or greater				
<u>All Terrain Cycles/Vehicles</u>					
731	0-50cc	includes all ATCs/ATVs			
732	51-124cc	designed solely for			
733	125-249cc	off-road use.			
734	350cc or greater				
999	Unknown		-	-	-

*** Code 9 applies only to frontal impacts. Use size code for stiffness for side or rear impacts.

Variable Name: Vehicle Model (specify): [cont'd.]

MAKE "38"

ISUZU

CODE	MODEL	INCLUDES	YEAR	SIZE	STIFFNESS
031	I-Mark	S, RS, Turbo	85-on	1	1
032	Impulse	Turbo, RS	84-on	2	2
033	Stylus		90-on	2	2
398	Other passenger vehicle		-	-	-
470	Trooper II	Deluxe, LS	84-on	2	7
471	Rodeo		91-on	TBD	TBD
477	P'up (pickup)	4 x 4	all	3	8**
479	Amigo		89-on	2	8**
498	Other light truck		-	-	-
881	Medium/Heavy - CBE		all	N/A	N/A
882	Medium/Heavy COE low entry		all	N/A	N/A
883	Medium/Heavy COE high entry		all	N/A	N/A
898	Other medium/heavy truck		all	N/A	N/A
999	Unknown		-	-	-

** Applies to front and rear impacts. Use size value for side impacts.

Variable Name: Vehicle Model (specify): [cont'd.]

MAKE "39"

JAGUAR

CODE	MODEL	INCLUDES	YEAR	SIZE	STIFFNESS
031	XJ-S Coupe		76-on	3	3
032	XJ6/12 Sedan/Coupe	L, XJ, C, 340/420 Sedan	all	3	3
033	XKE	V12, Roadster, 120 2 + 2	all	2 3	3 3
398	Other passenger vehicle		-	-	-
999	Unknown		-	-	-

MAKE "40"

LANCIA

CODE	MODEL	INCLUDES	YEAR	SIZE	STIFFNESS
031	Beta Sedan - HPG		-80	2	2
032	Beta Coupe - Zagato		-82	1	1
033	Scorpion		-78	1	1
398	Other passenger vehicle		-	-	-
999	Unknown		-	-	-

Variable Name: Vehicle Model (specify): [cont'd.]

MAKE "41"

MAZDA

CODE	MODEL	INCLUDES	YEAR	SIZE	STIFFNESS
031	RX2		72-74	2	2
032	RX3		72-78	1	1
033	RX4		74-78	2	2
034	RX7	S, GS, GSL, SE	79-on	2	2
035	323/GLC/Protege	DX, Protege (90-on)	77-on	1	1
036	Cosmo		76-78	2	2
037	626	GT, GS, GSL, SE	79-on	2	2
038	808		72-77	1	1
039	Mizer		76	1	1
040	R-100		-72	1	1
041	616/618		-72	2	2
042	1800		-72	2	2
043	929		88-on	-	-
044	MX-6	Turbo	88-on	2	2
045	Miata		90-on	1	1
046	Galaxy		92-on	1	1
398	Other passenger vehicle		-	-	-
470	Navajo		91-on	3	8**
472	MPV		89-on	3	7**
477	Mazda pickup	B-2000, B2200, SE-5, LX,	all	per WB	8**
498	Other light truck		-	-	-
999	Unknown		-	-	-

** Applies to front and rear impacts. Use size value for side impacts.

Variable Name: Vehicle Model (specify): [cont'd.]

MAKE "42"

MERCEDES BENZ

(Check "INCLUDES" comments carefully to determine proper code.)

CODE	MODEL	INCLUDES	YEAR	SIZE	STIFFNESS
031	200/220/230/240/250/260/ 280/300	Sedan and 5 passenger "C" only, SE, CD, D, SD, TD, TE, CE, E. <u>DOES NOT</u> include <u>280 SE</u> (75 on), <u>300 SD</u> - see code 037	all	3	3
032	230/280 SL	2 seater only	all	1	1
033	300/350/380/450/500 SL/ 560 SL	2 seater only, 300/500 SL (90-on)	all	2	2
034	350/380/420/450/560 SLC		all	4	4
035	280/300 SEL		all	4	4
036	380/420/450/500/560 SEL and 500/560 SEC/350 SDL/ 300 SDL		all	4	4
037	300 SE/380/450 SE	280 S, 280 SE (75 on), 300 SD Sedan/350 SD	all	4	4
038	600, 6.9 Sedan	Pullman	all	6	6
039	190	D, E, 2.3, 2.5	all	3	3
398	Other passenger vehicle		-	-	-
475	Van derivative	Kurbstar	82-on	N/A	N/A
498	Other light truck		-	-	-
881	Medium/Heavy - CBE		all	N/A	N/A
882	Medium/Heavy - COE low entry		all	N/A	N/A
883	Medium/Heavy - COE high entry		all	N/A	N/A
898	Other medium/heavy		all	N/A	N/A
901	Medium bus		all	N/A	N/A
997	Other bus		-	-	-
999	Unknown		-	-	-

Variable Name: Vehicle Model (specify): [cont'd.]

MAKE "43"

MG

CODE	MODEL	INCLUDES	YEAR	SIZE	STIFFNESS
031	Midget	MK111, 1500	-79	1	1
032	MGB	GT	-79	1	1
034	MGA		all	1	1
035	TA/TC/TD/TF		all	1	1
036	MGC	GT	-69	1	1
398	Other passenger vehicle	Sport Sedan	-	-	-
999	Unknown		-	-	-

MAKE "44"

PEUGEOT

CODE	MODEL	INCLUDES	YEAR	SIZE	STIFFNESS
031	304		71-73	3	3
032	403		-67	3	3
033	404		-70	3 4-SW	3 4-SW
034	504/505	STI, STX, Turbo, S, GL, GLS, Liberte,	70-on	3 4-SW	3 4-SW
035	604	SL, D	77-84	3	3
036	405	Mi-16	89-on	3	9***
398	Other passenger vehicle		-	-	-
	<u>Motorcycle</u>				
701	0-50cc				
702	51-124cc				
999	Unknown		-	-	-

*** Code 9 applies only to frontal impacts. Use size code for stiffness for side or rear impact.

Variable Name: Vehicle Model (specify): [cont'd.]

MAKE "45"

PORSCHE

CODE	MODEL	INCLUDES	YEAR	SIZE	STIFFNESS
031	911	L, S, E, T, SC, Carrera, Slopenose	all	1	1
032	912	E, T	-69	1	1
033	914	S, 1.8, 2.0, 914/6	70-76	2	2
034	924	Turbo, S	77-88	1	1
035	928	S	78-on	2	2
036	930	Turbo	79	1	1
037	944	Turbo, S	83-on	1	1
398	Other passenger vehicle	Spyder, Speedster, 356	-	-	-
999	Unknown		-	-	-

MAKE "46"

RENAULT

CODE	MODEL	INCLUDES	YEAR	SIZE	STIFFNESS
031	LeCar	5	76-83	2	2
032	Dauphine/10/R-8 Caravelle	all models	thru-'71	1	1
033	12	R12L, R12TL	72-77	2	2
034	15	R15TL	73-76	2	2
035	16	R16	69-72	3	3
036	17	R17, Gordini Coupe, R17TL	73-80	2	2
037	R18i	Sportwagon	81-on	2	2
038	Fuego	TL, TS, GTL, GTS, Turbo	82-85	2	2
039	Alliance/Encore GTA, Convertible	L, DL, Limited, X-37,	83-on	2	2
044	Medallion	DL, LX	87-only	3	3
045	Premier		87-only	3	3
398	Other passenger vehicle		-	-	-
999	Unknown		-	-	-

Variable Name: Vehicle Model (specify): [cont'd.]

MAKE "47"

SAAB

CODE	MODEL	INCLUDES	YEAR	SIZE	STIFFNESS
031	99/99E/900	S, Turbo, Cabriolet	all	2	2
032	Sonnett	II, III, V-4	68-74	1	1
033	95/96/97		-73	2	2
034	9000	S, Turbo	85-on	3	3
398	Other passenger vehicle	Monte Carlo 850	-	-	-
999	Unknown		-	-	-

MAKE "48"

SUBARU

CODE	MODEL	INCLUDES	YEAR	SIZE	STIFFNESS
031	DL/FE/G/GF/GL/GLF/STD/ Loyale	4 wheel drive, Turbo	72-89 90-on	per WB	= size
032	Star		70-71	2	2
033	360		69-70	1	1
034	Legacy		89-on	2	2
035	XT/XT6	4WD Turbo, convertible, DL	86-on	2	2
036	Justy	DL, GL	87-on	1	1
043	Brat	DL, GL	78-on	2	2
398	Other passenger vehicle		-	-	-
999	Unknown		-	-	-

Variable Name: Vehicle Model (specify): [cont'd.]

MAKE "49"

TOYOTA

CODE	MODEL	INCLUDES	YEAR	SIZE	STIFFNESS
031	Corona	Mark II, Custom, 1900, 2000, Deluxe	-82	2	2
032	Corolla	1100, 1200, 1600, SR-5, LE, Deluxe, Custom, FX16	69-85 FWD 86-on	1 2	1 9***
033	Celica	1900, 2000, GT, ST, GTS	72-on	2	2
034	Supra	Celica Supra, Soarer	79-on	3	3
035	Cressida		78-on	3	3
036	Crown	2300, 2600	-71	3	3
037	Carina	2000	72-73	2	2
038	Tercel	Corolla Tercel, 4WD Wagon	80-on	2	2
039	Starlet		81-84	1	1
040	Camry	LE, Deluxe	83-on	3	3
041	MR-2		85-on	1	1
042	Paseo		92-on	1	1
398	Other passenger vehicle	2000 GT Coupe (1960s)	-	-	-
471	Landcruiser		76-on	1	8**
472	Minivan Previa	LE, Cargo	84-90 91-on	1	7**
473	4-Runner		85-on	3	8**
477	Pickup	SR-5, Extra Cab, Sport, LN44, Chinook, Wonder Wagon	74-on	per WB	8**
498	Other light truck		-	-	-
999	Unknown		-	-	-

** Applies to front and rear impacts. Use size value for side impacts.

*** Code 9 applies only to frontal impacts. Use size code for stiffness for side or rear impact.

Variable Name: Vehicle Model (specify): [cont'd.]

MAKE "50"

TRIUMPH

CODE	MODEL	INCLUDES	YEAR	SIZE	STIFFNESS
031	Spitfire	I, II, III, IV, 1500	-81	1	1
032	GT-6	MKS	67-73	1	1
033	TR4	TR2, TR3, TR4A	-68	1	1
034	TR6		69-76	1	1
035	TR7/8		75-81	1	1
036	Herald	Vitesse	-	-	-
037	Stag		71-73	2	2
398	Other passenger vehicle	2000, 1200 series	-	-	-
	<u>Motorcycles</u>				
701	0-50cc				
702	51-124cc				
703	125-349cc				
704	350-449cc				
705	450-749cc				
706	750cc or greater				
999	Unknown				

Variable Name: Vehicle Model (specify): [cont'd.]

MAKE "51"

VOLVO

CODE	MODEL	INCLUDES	YEAR	SIZE	STIFFNESS
031	122	S	-68	3	3
032	142/144/145	S, E, GL, GLS, Deluxe	-74	3	3
033	164	S, E	69-75	3	3
034	240/242/244/245	DL, GL, GLE, GLT, Deluxe	75-	3	3
035	262/264/265	GL	76-82	-	-
036	1800	E, S, ES	-73	2	2
037	P-544				
038	760 780	GLE, Turbo	83-on 87-on	3 3	3 3
039	740	GLE, GT, Turbo, GL	86-on	3	3
398	Other passenger vehicle		-	-	-
881	Medium/Heavy COE		all	N/A	N/A
882	Medium/Heavy COE low entry		all	N/A	N/A
883	Medium/Heavy COE high entry		all	N/A	N/A
898	Other medium/heavy truck		all	N/A	N/A
901	Medium bus		all	N/A	N/A
997	Other bus		all	N/A	N/A
999	Unknown		-	-	-

Variable Name: Vehicle Model (specify): [cont'd.]

MAKE "52"

MITSUBISHI

CODE	MODEL	INCLUDES	YEAR	SIZE	STIFFNESS
031	Starion	2 + 2, LE, Turbo	83-on	2	2
032	Tredia	L, LS, Turbo	83-88	2	2
033	Cordia	L, Turbo	83-88	2	2
034	Galant	ECS, Sigma (thru 88)	85-on	3	3
035	Mirage	L, Turbo	85-on	1	1
036	Precis		88-on	1	1
037	Eclipse		90-on	2	2
038	Sigma		89-on		
039	3000GT		91-on		
398	Other passenger vehicle		-	-	-
470	Montera	Sport	85-on	1	8**
472	Minivan	LS	87-on	1	7**
477	Pickup	Mighty Max, SPX, 4 x 4	all	3	8**
498	Other light truck		-	-	-
882	Medium/Heavy - COE low entry	FUSO FE	all	N/A	N/A
898	Other medium/heavy truck		-	-	-
999	Unknown		-	-	-

** Applies to front and rear impacts. Use size value for side impacts.

Variable Name: Vehicle Model (specify): [cont'd.]

MAKE "53"

SUZUKI

CODE	MODEL	INCLUDES	YEAR	SIZE	STIFFNESS
031	SA310	GLX	86-on	1	1
034	Swift	GTi, GTX	89-on	1	1
398	Other passenger vehicle		-	-	-
470	Samurai	Standard, Deluxe	85-on	1	8**
471	CHANGED TO CODE 479 IN 1990				
479	Sidekick		89-on	2	8**
498	Other light truck		-	-	-
<u>Motorcycles</u>					
701	0-50cc				
702	51-124cc				
703	125-349cc				
704	350-449cc				
705	450-749cc				
706	750cc-over				
<u>All Terrain Cycles/Vehicles</u>					
731	0-50cc	includes all ATCs/ATVs			
732	51-124cc	designed solely for			
733	125-349cc	off-road use.			
734	350cc or greater				
999	Unknown		-	-	-

** Applies to front and rear impacts. Use size value for side impacts.

MAKE "54"

ACURA

CODE	MODEL	INCLUDES	YEAR	SIZE	STIFFNESS
031	Integra	RS, LS, GS	86-on	2	9***
032	Legend		86-on	3	9***
033	NSX		91-on		
398	Other passenger vehicle		-	-	-
999	Unknown		-	-	-

*** Code 9 applies only to frontal impacts. Use code for stiffness for side or rear impact.

Variable Name: Vehicle Model (specify): [cont'd.]

MAKE "55"

HYUNDAI

CODE	MODEL	INCLUDES	YEAR	SIZE	STIFFNESS
031	Pony		84-on	2	2
032	Excel	GL, GLS	84-on	1	1
033	Sonata		89-on	3	3
034	Scoupe		91-on	1	1
035	Elantra		92-on	2	2
398	Other passenger vehicle		-	-	-
999	Unknown		-	-	-

MAKE "56"

MERKUR

CODE	MODEL	INCLUDES	YEAR	SIZE	STIFFNESS
031	XR4Ti	Turbo	85-on	3	3
032	Scorpio	Turbo	87-on	3	3
398	Other passenger vehicle		-	-	-
999	Unknown		-	-	-

MAKE "57"

YUGO

CODE	MODEL	INCLUDES	YEAR	SIZE	STIFFNESS
031	GV	GVX, Cabriolet	86-on	1	1
398	Other passenger vehicle		-	-	-
999	Unknown		-	-	-

Variable Name: Vehicle Model (specify): [cont'd.]

MAKE "58"

INFINITI

CODE	MODEL	INCLUDES	YEAR	SIZE	STIFFNESS
031	M30		90-on	3	3
032	Q45		90-on	4	4
033	G20		91-on		
398	Other passenger vehicle		-	-	-
999	Unknown		-	-	-

MAKE "59"

LEXUS

CODE	MODEL	INCLUDES	YEAR	SIZE	STIFFNESS
031	ES-250		90-on	3	3
032	LS-400		90-on	4	4
398	Other passenger vehicle		-	-	-
999	Unknown		-	-	-

MAKE "60"

DAIHATSU

CODE	MODEL	INCLUDES	YEAR	SIZE	STIFFNESS
031	Charade		90-on	3	3
398	Other passenger vehicle		-	-	-
479	Rocky		90-on		
498	Other light truck		-	-	-
999	Unknown		-	-	-

Variable Name: Vehicle Model (specify): [cont'd.]

MAKE "69"

OTHER IMPORTS

CODE	MODEL	INCLUDES	YEAR	SIZE	ST FFNESS
031	Aston Martin	Lagonda, Vantage, Volante, Saloon	all	per WB	= size
032	Bricklin		all	per WB	= size
033	Citreon		all	per WB	= size
034	Delorean		all	per WB	= size
035	Ferrari		all	per WB	= size
036	Hillman		all	per WB	= size
037	Jensen	Healy	all	per WB	= size
038	Lamborghini	Countach 5000S, Jalpa	all	per WB	= size
039	Lotus	Europe, Esprit	all	per WB	= size
040	Maserati	Biturbo	all	per WB	= size
041	Morris	Minor	all	per WB	= size
042	Rolls Royce/Bentley	Cloud/shadow series	all	per WB	= size
043	Rover		all	per WB	= size
044	Simca		all	per WB	= size
045	Sunbeam		all	per WB	= size
046	TVR		all	per WB	= size
048	DeSoto		all	per WB	= size
049	Reliant		all	per WB	= size
052	Bertone	X/19	all	per WB	= size
053	Lada		all	per WB	= size
055	Sterling	8255/8255L	all	per WB	= size
398	Other imported auto	Morgan, Singer	all	per WB	= size

Variable Name: Vehicle Model (specify): [cont'd.]

Vehicle Classification: Motored Cycle/ATC/ATV

Variable GV05 Vehicle Make				Code	Variable GV06 Vehicle Model	Code
	<u>M</u>	<u>C</u>	<u>ATC</u>	<u>ATV</u>		
BMW	x				Motored Cycles 0-50cc	701
Honda	x	x	x		51-124cc	702
Peugeot	X				125-349cc	703
Triumph	x				350-449cc	704
Suzuki	x	x	x		450-749cc	705
BSA	x				750cc-or greater	706
Ducati	x					
Harley-Davidson	x				All Terrain Cycles/Vehicles	
Kawasaki	x	x	x		0-50cc	731
Moto-Guzzi	x				51-124cc	732
Norton	x				125-349cc	733
Yamaha	x	x	x		350cc or greater	734
Moped other than listed above	x				Unknown	999
Other motorized cycle	x	x	x			
Unknown						99

Variable Name: Vehicle Model (specify): [cont'd.]

MAKE "84"

INTERNATIONAL HARVESTER

CODE	MODEL	INCLUDES	YEAR	SIZE	STIFFNESS
471	Scout	Scout II, Utility pickup, SS-2, Roadstar, 800 series, Traveler, Terra Traveltop	all	per WB	8**
472	Pickup/Panel	R-100-500, 900A-1500C/D, 1010-1510	all	per WB	8**
475	Multistop Van	Metro RM, 120-160, MS 1210, MS 1510	all	per WB	7**
476	Travelall	1010-1210, 100-200	all	per WB	8**
498	Other light truck		-	-	-
881	Medium Heavy - CBE	Loadstar/Fleetstar, Paystar, CBE Transtar, 4200, S-series Mixer	all	N/A	H/A
882	Medium/Heavy - COE low entry	CO, VCO, DCO, 190-1950, Cargostar, LFM, 5370	all	N/A	H/A
883	Medium/Heavy - COE high entry	DCO, DCOE, UCO, VCOE, 405-series, COE Transtar, Unistar, Conco 707B, 9600	all	N/A	H/A
898	Other medium/heavy truck		all	N/A	H/A
901	Conventional bus	R153-1853 - Loadstar, 1603-1853	all	N/A	H/A
902	Bus-flat front, front engine	173FC, 183FC	all	N/A	H/A
903	Bus-flat front, rear engine	183RE, 193RE-transit	all	N/A	H/A
950	Motorhome		all	N/A	H/A
997	Other bus		all	N/A	H/A
998	Other vehicle		-	-	-
999	Unknown		-	-	-

** Applies to front and rear impacts. Use size value for side impacts.

Variable Name: Vehicle Model (specify): [cont'd.]

Vehicle Classification: Medium/Heavy Trucks and Buses

Variable GV05 Vehicle Make	Code		Variable GV06 Vehicle Model	Code
	Truck	Bus		
AM General	x	x	03 Medium/Heavy - CBE	881
Dodge	x	x	07 Medium/Heavy - COE/low entry	882
Ford	x	x	12 Medium/Heavy - COE/high entry	883
Chevrolet	x	x	20 Medium/Heavy - Other	898
GMC	x	x	23	
Nissan/Datsun	x		35 Bus - conventional front	901
Fiat	x		36 engine	
Isuzu	x		38 Bus - front engine/flat front	902
Mercedes Benz	x	x	42 Bus - rear engine/flat front	903
Volvo	x	x	51	
Mitsubishi	x		52 Truck based motorhome	950
Brockway	x		80	
Diamond Reo/Reo	x		81 Unknown	999
Freightliner/White	x		82	
FWD	x		83	
International Har-			84	
vester/Navistar	x	x		
Kenworth	x		85	
Mack	x		86	
Peterbilt	x		87	
Iveco/Magirus	x		88	
Other: (if code "89" is used for GV05, then GV06 must be 801-805, 898, 901, 902, 950, 997, or 998, irrespective of Body Type)			89 Autocar	801
			Auto-Union-DKW	802
			Divco	803
			Western Star	804
			Oshkosh	805
			Other truck: e.g., Marmon, Ward LaFrance, specify	898
			Grumman (bus)	901
			Neoplan (bus)	902
			Truck based motorhome	950
			Other bus	997
			Other vehicle	998

Variable Name: Vehicle Model (specify): [cont'd.]

Source: Vehicle inspection, police report, and interview.

Remarks:

For the purposes of the Model codes the following applies.

- 001 - 397 - Passenger vehicles
- 398 - Other passenger vehicle

- 401 - 497 - Light trucks
- 498 - Other light truck

- 701 - 797 - Motored Cycles/ATCs/ATVs
- (701 - 706 motorcycles/mopeds)
- (731 - 734 ATCs/ATVs)
- 798 - Other motored cycle

- 801 - 897 - Medium/heavy trucks
- 898 - Other medium/heavy truck

- 901 - 996 - Buses
- 997 - Other bus
- 998 - Other vehicle (i.e., farm vehicle, go-kart, etc.)
- 999 - Unknown

The stiffness codes assigned in GV06, Vehicle Model (specify):, are based upon either limited crash test data, wheelbase, or a correlation with vehicles currently listed in the CRASH3 manual. These assignments replace the vehicle assignments in "Table 8-2 Vehicle Stiffness Categories" in the "CRASH3 User's Guide and Technical Manual".

Variable Name: Body Type

Element Values:

CDS APPLICABLE VEHICLES

Automobiles

- 01 Convertible (excludes sun-roof, t-bar)
- 02 2-door sedan, hardtop, coupe
- 03 3-door/2-door hatchback
- 04 4-door sedan, hardtop
- 05 5-door/4-door hatchback
- 06 Station wagon (excluding van and truck based)
- 08 Other automobile type (specify):
- 09 Unknown automobile type

Automobile Derivatives

- 10 Auto based pickup (includes El Camino, Caballero, Ranchero and Brat)
- 11 Auto based panel (cargo station wagon, includes auto based ambulance/hearse)
- 12 Large limousine - more than four side doors or stretched chassis

Utility Vehicles

- 13 Short utility - not truck based (includes Jeep CJ-5, Jeep CJ-7, Renegade, Landrover, Pre-78 Bronco, Landcruiser, Thing)
- 14 Truck based utility (2-door; includes Blazer, Bronco - 78 on, Bronco II, Jimmy, Ramcharger, Cherokee, Trailduster, Scout)

Van Based Light Trucks (\leq 10,000 lbs. GVWR)

- 20 Minivan (Lumina APV, Astro, Caravan, Plymouth Vista, Aerostar, Safari, Voyager [84 and after], Dodge Vista, Mini Ram Van, Toyota Cargo Van, Toyota Van, Vanagon, VW Bus, Kombi)
- 21 Standard Van (Sportvan, Chevy Van, Club Wagon, Ford Econoline, Ram Van, Chateau, Ram Wagon, Vandura, Rally, Voyager [83 and before], Beauville, Sportsman)
- 28 Other van type (Hi-Cube Van, Kary) (specify):
- 29 Unknown van type

Light Conventional Trucks (Pickup style cab, \leq 10,000 lbs. GVWR)

- 30 Compact pickup (< 4,500 lbs. GVWR, S-10, LUV, Ram 50, Rampage, Courier, Ranger, S-15, Pup, Mazda Pickup, Mitsubishi Truck, Nissan Pickup, Arrow Pickup, Scamp, Toyota Pickup, VW Pickup)
- 31 Standard pickup (4,500 to 10,000 lbs. GVWR, C10-C30, K10-K30, T-10, D100-D350, W150-W350, F100-F350, Comanche, J10-J30, Dakota)
- 33 Pickup with slide-in camper
- 33 Truck based station wagon (4-door; includes Suburban, Travelall, Wagoneer)
- 34 Light truck based suburban limousine
- 35 Convertible pickup
- 39 Unknown (pickup style) light conventional truck type

Variable Name: Body Type (cont'd.)

Other Light Trucks (< 10,000 lbs. GVWR)

- 40 Cab chassis based (includes rescue vehicle, light stake, dump, and tow truck)
- 41 Truck based panel
- 42 Light truck based motorhome (chassis mounted)
- 47 Other light conventional truck type (not a pickup - includes step vans ≤ 10,000 lbs GVWR, Grumman LLV vehicle) (specify):
- 48 Unknown other light truck type (not a pickup)
- 49 Unknown light vehicle type (automobile, van, or light truck)

OTHER VEHICLES

Buses (Excludes Van Based)

- 50 School bus (designed to carry students, not cross country or transit)
- 58 Other bus type (e.g., transit, intercity, bus based motorhome) (specify):
- 59 Unknown bus type

Medium/Heavy Trucks (> 10,000 lbs. GVWR)

- 60 Step van
- 61 Single unit straight truck (10,000 lbs. < GVWR ≤ 26,000 lbs.)
- 62 Single unit straight truck (> 26,000 lbs. GVWR)
- 63 Medium/heavy truck based motorhome
- 64 Truck-tractor with no cargo trailer
- 65 Truck-tractor pulling one trailer
- 66 Truck-tractor pulling two or more trailers
- 67 Truck-tractor (unknown if pulling trailer)
- 68 Unknown medium/heavy truck type
- 69 Unknown truck type (light/medium/heavy)

Motored Cycles (Does Not Include All-Terrain Vehicles/Cycles)

- 70 Motorcycle
- 71 Moped (motorized bicycle)
- 78 Other motored cycle (minibike, motorscooter) (specify):
- 79 Unknown motored cycle type

Other Vehicles

- 80 ATV (All-Terrain Vehicle) and ATC (All-Terrain Cycle)
- 88 Other type vehicle (specify):
- 99 Unknown body type

Source: Vehicle inspection, police report, and interview.

Remarks:

NASS CDS VARIABLE COMPUTER FORMATS - Continued

Occupant Injury Form (Continued)

Name	Variable Identifier	SAS Variable Number	Variable Type	Variable Column Length	Beginning Column Number
7th Source of Injury Data	0165		Numeric	1	83
7th O.I.C. - Body Region	0166		Alphanumeric	1	84
7th O.I.C. - Aspect	0167		Alphanumeric	1	85
7th O.I.C. - Lesion	0168		Alphanumeric	1	86
7th O.I.C. - System/Organ	0169		Alphanumeric	1	87
7th Abbreviated Injury Scale Severity	0170		Numeric	1	88
7th Injury Source	0171		Numeric	2	89
7th Injury Source Confidence Level	0172		Numeric	1	91
7th Direct/Indirect Injury	0173		Numeric	1	92
7th Occupant Area Intrusion Number	0174		Numeric	2	93
8th Source of Injury Data	0175		Numeric	1	95
8th O.I.C. - Body Region	0176		Alphanumeric	1	96
8th O.I.C. - Aspect	0177		Alphanumeric	1	97
8th O.I.C. - Lesion	0178		Alphanumeric	1	98
8th O.I.C. - System/Organ	0179		Alphanumeric	1	99
8th Abbreviated Injury Scale Severity	0180		Numeric	1	100
8th Injury Source	0181		Numeric	2	101
8th Injury Source Confidence Level	0182		Numeric	1	103
8th Direct/Indirect Injury	0183		Numeric	1	104
8th Occupant Area Intrusion Number	0184		Numeric	2	105
9th Source of Injury Data	0185		Numeric	1	107
9th O.I.C. - Body Region	0186		Alphanumeric	1	108
9th O.I.C. - Aspect	0187		Alphanumeric	1	109
9th O.I.C. - Lesion	0188		Alphanumeric	1	110
9th O.I.C. - System/Organ	0189		Alphanumeric	1	111
9th Abbreviated Injury Scale Severity	0190		Numeric	1	112
9th Injury Source	0191		Numeric	2	113
9th Injury Source Confidence Level	0192		Numeric	1	115
9th Direct/Indirect Injury	0193		Numeric	1	116
9th Occupant Area Intrusion Number	0194		Numeric	2	117
10th Source of Injury Data	0195		Numeric	1	119
10th O.I.C. - Body Region	0196		Alphanumeric	1	120
10th O.I.C. - Aspect	0197		Alphanumeric	1	121
10th O.I.C. - Lesion	0198		Alphanumeric	1	122
10th O.I.C. - System/Organ	0199		Alphanumeric	1	123
10th Abbreviated Injury Scale Severity	01100		Numeric	1	124
10th Injury Source	01101		Numeric	2	125
10th Injury Source Confidence Level	01102		Numeric	1	127
10th Direct/Indirect Injury	01103		Numeric	1	128
10th Occupant Area Intrusion Number	01104		Numeric	2	129

Variable Name: Body Type (cont'd.)

Automobile Derivatives

Codes "10"- "12" are used to describe certain passenger cars that have been modified to perform cargo-related tasks.

Code "10" [Auto based pickup (includes El Camino, Caballero, Ranchero and Brat)] refers to a passenger car based, pickup type vehicle. The roof area (and side glass) rearward of the front seats on a station wagon have been removed and converted into a pickup-type cargo box.

Code "11" [Auto based panel (cargo station wagon, includes auto based ambulance/hearse)] refers an automotive station wagon with sheet metal rearward of the B-pillar rather than glass.

Code "12" (Large limousine - more than four side doors or stretched chassis) refers to an automobile that has sections added within its wheelbase to increase length and passenger/cargo carrying capacity.

Utility Vehicles

Codes "13" and "14" are used to describe **multi-purpose vehicles** (MPV) that are designed to have off-road capabilities. These vehicles are: generally four wheel drive (4 x 4), have increased ground clearance, and are equipped with a strong frame. Four wheel drive automobiles are not considered MPVs.

Code "13" [Short utility - not truck based (includes Jeep CJ-5, Jeep CJ-7, Renegade, Landrover, Pre-78 Bronco, Landcruiser, Thing)] refers to a "jeep" type multi-purpose vehicle designed to operate in rugged terrain by virtue of large ramp angles, short wheelbase, and narrow body styles.

Code "14" [Truck based utility (2-door; includes Blazer, Bronco - 78 on, Bronco II, Jimmy, Ramcharger, Cherokee, Trailduster, Scout)] refers to a multi-purpose vehicle designed around a shortened pickup truck chassis. While generally a station wagon style body, some models are equipped with a removable fiberglass hardtop.

Van Based Light Trucks (≤ 10,000 lbs. GVWR)

Codes "20"- "29" are used to describe light trucks (≤ 10,000 lbs. GVW) that are designed to maximize cargo/passenger area versus overall length. Basically a "box on wheels" these vehicles are identifiable by their enclosed cargo/passenger area and relatively short (or non-existent) hood.

Code "20" [Minivan (Lumina APV, Astro, Caravan, Plymouth Vista, Aerostar, Safari, Voyager [84 and after], Dodge Vista, Mini Ram Van, Toyota Cargo Van, Toyota Van, Vanagon, VW Bus, Kombi)] is used to describe all front wheel drive cargo or passenger van-type vehicles and rear wheel drive vans with an overall length of less than 178 inches.

Variable Name: Body Type (cont'd.)

Code "21" [Standard Van (Sportvan, Chevy Van, Club Wagon, Ford Econoline, Ram Van, Chateau, Ram Wagon, Vandura, Rally, Voyager [83 and before], Beauville, Sportsman)] is used to describe cargo or passenger van-type vehicles with an overall length of 178 inches or greater. This code excludes cutaway vans which are included in code "42" [Light truck based motorhome (chassis mounted)].

Code "28" [Other van type (Hi-Cube Van, Kary)] is used if a van cannot be defined by codes "20" or "21". Annotate the van type when using this code.

Code "29" (Unknown van type) is used when it is known that this vehicle is a light van, but its specific type cannot be determined.

Light Conventional Trucks (Pickup Style Cab, \leq 10,000 lbs. GVWR)

Codes "30"- "39" are used to describe vehicles commonly referred to as pickup trucks and some of their derivatives. These light trucks are characteristically designed: with a small cab containing a single row of seats (extended cabs with additional seats are available for some models), a large hood covering a conventional engine placement, and a separate open box area (typically 6 or 8 feet long) for cargo.

Code "30" [Compact pickup (< 4,500 lbs. GVWR, S-10, LUV, Ram 50, Rampage, Courier, Ranger, S-15, Pup, Mazda Pickup, Mitsubishi Truck, Nissan Pickup, Arrow Pickup, Scamp, Toyota Pickup, VW Pickup)] is used to describe a pickup truck having a width of 75 inches or less and/or a length--measured from the back of the cab to the front bumper, of less than 101 inches.

Code "31" [Standard pickup (4,500 to 10,000 lbs. GVWR, C10-C30, K10-K30, T-10, D100-D350, W150-W350, F100-F350, Comanche, J10-J30, Dakota)] is used to describe a pickup truck having a width of greater than 75 inches and/or length--measured from the back of the cab to the front bumper, of 101 inches or greater.

Code "32" (Pickup with slide-in camper) is used to describe any pickup truck that is equipped with a slide-in camper. A slide-in camper is a unit that mounts within a pickup bed. Pickup bed caps, tonneau covers, or frame mounted campers are not applicable for this code.

Code "33" [Truck based station wagon (4-door; includes Suburban, Travelall, Wagoneer)] generally refers to a "Suburban"; use this code for a vehicle that is based upon a pickup truck chassis and resembles an enlarged station wagon.

Code "34" (Light truck based suburban limousine) is used to describe a truck based station wagon (see code "33") that has been modified by lengthening the frame to create additional passenger/cargo space.

Variable Name: Body Type (cont'd.)

Code "35" (Convertible pickup) refers to a pickup truck equipped with a removable or retractable roof. To qualify for this code, the entire roof must open. Convertible roofs are generally fabric; however, removable hardtops are also included. This code takes priority over compact and standard pickups (codes "30" and "31").

Code "39" [Unknown (pickup style) light conventional truck] is used when this vehicle qualifies for a code in the "30" to "34" range, but there is insufficient data to determine the specific code.

Other Light Trucks (< 10,000 lbs. GVWR)

Codes "40"- "49" are used to describe vehicles that are based upon a conventional light pickup frame, but a commercial or recreational body has been affixed to the frame rather than a pickup box.

Code "40" [Cab chassis based (includes rescue vehicle, light stake, dump, and tow truck)] is used to describe a light vehicle with a pickup style cab and a commercial (nonpickup) body attached to the frame. Included are pickup based ambulances and tow trucks.

Code "41" (Truck based panel) is used to describe a truck based station wagon that has sheet metal rather than glass above the beltline rearward of the B-pillars.

Code "42" [Light truck based motorhome (chassis mounted)] is used to describe a frame mounted recreational unit attached to a light van or conventional chassis.

Code "47" [Other light conventional truck type (not a pickup - includes step vans ≤ 10,000 lbs GVWR, Grumman LLV vehicle)] is used to describe a light truck chassis based vehicle that cannot be described under the Utility (codes "13"- "14"), Van (codes "20"- "29"), Conventional (codes "30"- "39"), or Other Light Truck (codes "40"- "42") elements.

Code "48" [Unknown other light truck type (not a pickup)] is used when it can be determined that this vehicle would qualify for codes "40"- "42" or "47", but insufficient data exists to specify the proper code.

Code "49" [Unknown light vehicle type (automobile, van, or light truck)] is used when it is known that the vehicle is a light vehicle, but insufficient data exists to specify between codes "09", "10"- "14", "29", "39", or "40"- "48".

Buses (Excludes Van Based)

Codes "50", "58", and "59" are defined as any medium/heavy motor vehicle designed primarily to transport large groups of passengers.

Variable Name: Body Type (cont'd.)

Code "50" [School bus (designed to carry students, not cross country or transit)] is a bus designed to carry passengers to and from educational facilities and/or related functions. The vehicles are characteristically painted yellow and clearly identified as school busses. Use this code regardless of whether the vehicle is owned by a school system or a private company. School buses converted for other uses (e.g., church bus) also take this code.

Code "58" [Other bus type (e.g., transit, intercity, bus based motorhome)] is a transport device designed to carry passengers for longer periods of time. These vehicles may be classified as over-the-road, transit, intercity, bus related motorhome (other than school bus based), or other.

Code "59" (Unknown bus type) is used when it is known the transport device is a bus but there is insufficient data to choose between codes "50" and "58".

Medium/Heavy Trucks (> 10,000 lbs. GVWR)

Codes "60"- "63" describe a single unit truck specifically designed for carrying cargo on the same chassis as the cab.

Codes "64"- "67" pertain to a truck-tractor designed for towing trailers or semi-trailers. Although towing is their primary purpose, some truck-tractors are equipped with cargo areas located rearward of the cab.

Code "60" (Step van) defines a single unit enclosed body with an integral driver's compartment and cargo area. Step vans are generally equipped with a folding driver seat mounted on a pedestal and a sliding door for easy ingress/egress.

Code "61" [Single unit straight truck (10,000 lbs. < GVWR ≤ 26,000 lbs.)] describes a non-articulated truck designed to carry cargo. The gross vehicle weight rating of the vehicle must exceed 10,000 pounds and be less than or equal to 26,000 pounds.

Code "62" [Single unit straight truck (> 26000 lbs. GVWR)] describes a non-articulated truck designed to transport cargo with a gross vehicle weight rating in excess of 26,000 pounds. Use this code if it is known that the GVWR of a single unit straight truck is greater than 10,000 pounds but there is insufficient data to specify between codes "61" and "62".

Code "63" (Medium/heavy truck based motorhome) describes a recreational vehicle mounted on a single unit medium/heavy truck chassis.

Code "64" (Truck-tractor with no cargo trailer) describes a fifth wheel equipped tractor/trailer power unit with no trailer attached.

Variable Name: Body Type (cont'd.)

- Code "65" (Truck-tractor pulling one trailer) describes a fifth wheel equipped tractor (i.e., power unit of a tractor/trailer combination) pulling one semi-trailer.
- Code "66" (Truck-tractor pulling two or more trailers) describes a fifth wheel equipped tractor (i.e., power unit of a tractor/trailer combination) pulling a semi-trailer plus one or more trailers. These additional trailers may be attached with a standard hitch or a converter dolly (for semi-trailers).
- Code "67" [Truck-tractor (unknown if pulling trailer)] is used when the vehicle is known to be a truck-tractor, but it is unknown if a trailer was being towed or if more than one trailer was being towed.
- Code "68" (Unknown medium/heavy truck type) is used when the only available information indicates a truck of medium/heavy size.
- Code "69" [Unknown truck type (light/medium/heavy)] is used when it is known that this vehicle is a truck, but there is insufficient data to classify the vehicle further.

Motored Cycles (Does Not Include All Terrain Vehicles/Cycles)

Codes "70"- "79" define types of motored cycles.

- Code "70" (Motorcycle) is used when the vehicle is a two- or three-wheeled open (i.e., no enclosed body) vehicle propelled by an internal combustion engine. Motorcycles equipped with a side car also take this code.
- Code "71" [Moped (motorized bicycle)] is used when the vehicle is a motorized bicycle capable of moving either by pedaling or by an internal combustion engine.
- Code "78" [Other motored cycle type (minibike, motor scooter)] is used when the vehicle in question does not qualify for codes "70" or "71" (e.g., motor scooter).
- Code "79" (Unknown motored cycle type) is used when it is known that the vehicle is a motored cycle, but no further data is available.

Other Vehicles

Codes "80" and "88" describe all two-, three-, four-, or six-wheeled vehicles that are designed primarily for off-road use.

Variable Name: Body Type (cont'd.)

Code "80" [ATV (All-Terrain Vehicle) and ATC (All-Terrain Cycle)] is used for off-road recreational vehicles which cannot be licensed for use on public roadways. ATVs have 4 or more wheels and ATCs have 2 or 3 wheels. Generally, the tires have low pressure and wide profile (i.e., flotation/balloon).

Code "88" (Other vehicle type) is used when the vehicle in question does not qualify for code "80" (e.g., construction equipment, farm tractor, go-kart, dune buggy, "kit" car, etc.).

Unknown

Code "99" (Unknown body type) is used when there is no available information regarding the type of vehicle. This lack of information prohibits the accurate classification of this vehicle within one of the preceding codes.

Variable Name: Vehicle Identification Number

Element Values:

Code the entire VIN, left justify
 00000000000000000000 No VIN
 99999999999999999999 Unknown

Source: Primary source is vehicle inspection; a secondary source is the police report.

Remarks:

If a vehicle is inspected, the VIN must be obtained from the vehicle. The PAR may be used to obtain a VIN when a vehicle inspection is not required (i.e., nontow CDS applicable and CRASH is not applicable; or GV07, Body Type, equals "50"- "99").

Code and left justify the entire VIN; leave "Blank" any column which does not have a VIN character.

If part of the VIN is missing or not decipherable, leave the column any such character would ordinarily occupy "Blank".

Code "99999999999999999999" (Unknown) if the entire VIN is unknown or missing.

Code "00000000000000000000" if the vehicle is a type which has no VIN (e.g., go-kart).

If the vehicle is a motor home or school bus, the vehicle chassis VIN is coded and the secondary manufacturer's number should be annotated if indicated on the PAR.

If the vehicle is manufactured by the Ford Motor Company and the VIN begins or ends with a script, "ℱ", the "ℱ" is not coded. Proceed to the next character, as in the example below.

VIN: ℱ 3 U 6 2 S 1 0 0 9 3 2 ℱ
 CODE: 3 U 6 2 S 1 0 0 9 3 2 - - - - -

NOTE: For this variable only, slash zeros "0", so that they are not confused with the alphabet character "O", as in DOT.

In addition, if any hyphens, periods, or blank spaces are contained in the string of alphanumeric characters, ignore them as in the example below.

VIN: S M - E 3 0 7 6 4 2 1
 CODE: S M E 3 0 7 6 4 2 1 - - - - -

If the state will not allow transmittal of the complete VIN, code all characters except the sequential production numbers. Code zeros ("0") in place of the sequential numbers.

Variable Name: Vehicle Identification Number (cont'd.)

In those cases where the VIN does not match the references given below (e.g., a character is missing or an invalid character is coded in a space), the encoded VIN must follow the correct format indicated by the references below and a note is made on the form indicating the discrepancy.

The location of the VIN will vary among, and within, vehicles. Reference sources which may prove helpful in locating the VIN include, but are not limited to:

- (1) Passenger Vehicle Identification Manual
National Automobile Theft Bureau

Manuals available from

Station Distributing House
Post Office Box 267
Port Jefferson Station, New York 11776

- (2) Passenger Car and Truck-Accident
Investigator's Manual
MVMA of the U.S., Inc.
300 New Center Building
Detroit, Michigan 48202

- (3) Lee S. Cole
Lee Books
Post Office Box 906
Novato, California 94948-0906
(415) 897-3550
(Vehicle Identification 1938-1968)
(Vehicle Identification 1968-1982)

- (4) N.A.D.A. Official Used Car Guide
National Automobile Dealers Association
8400 Westpark Drive
McLean, Virginia 22102

Vehicles manufactured after September 1980 conform to Federal Motor Vehicle Safety Standard 115. This standard requires that: (1) each VIN have 17 characters, and (2) the VIN does not contain the letters "I", "O", or "Q". There are many other requirements, one of which is that the VIN pass a mathematical test; thus, the use of the "check digit".

Each character in a VIN has a value, and each place has a weight. Each weight is multiplied by the value of the character in it; the products are summed and divided by eleven (11). The remainder (once converted from a decimal to an integer) must be the same as the value of the check digit character (the ninth one), except when the remainder is ten (10), in which case, the check digit character is "X".

Variable Name: Vehicle Identification Number (cont'd.)

<u>VIN Place</u>	<u>Value Factor</u>	<u>Character Values</u>				
1st	8	A-1	B-2	C-3	D-4	E-5
2nd	7					
3rd	6	F-6	G-7	H-8		J-1
4th	5					
5th	4	K-2	L-3	M-4	N-5	
6th	3					
7th	2	P-7		R-9	S-2	T-3
8th	10					
Check Digit	0	U-4	V-5	W-6	X-7	Y-8
10th	9					
11th	8	Z-9				
12th	7					
13th	6	0-0	1-1	2-2	3-3	4-4
14th	5					
15th	4	5-5	6-6	7-7	8-8	9-9
16th	3					
17th	2					

Example:

VIN Character	1	G	4	A	H	5	9	H	4	5	G	1	1	8	3	4	1	Sum
Assigned Value	1	7	4	1	8	5	9	8	4	5	7	1	1	8	3	4	1	
Weight Factor	8	7	6	5	4	3	2	10	0	9	8	7	6	5	4	3	2	
Product	8	49	24	5	32	15	18	80	0	45	56	7	6	40	12	12	2	411

Divide sum by eleven (11): $411/11 = 37.3636\dots = 37$ and $4/11$ s.
Compare integer remainder to check digit: "4" equals "4".

Remainders of Eleven:

<u>Decimal</u>	<u>Integer</u>	<u>Decimal</u>	<u>Integer</u>	<u>Decimal</u>	<u>Integer</u>
.000000	0	.363636	4	.727272	8
.090909	1	.454545	5	.818181	9
.181818	2	.545454	6	.909090	X*
.272727	3	.636363	7		

* The character X is used instead of the integer ten (10) since the field is only one character wide.

Variable Name: Police Reported Vehicle Disposition

Element Values:

- 0 Not towed due to vehicle damage
- 1 Towed due to vehicle damage
- 9 Unknown

Source: Police report.

Remarks:

A "towed" vehicle is defined as a vehicle which is removed from the accident scene other than by means of its own power. For example, a vehicle which is reported by the police as towed out of a ditch and subsequently driven away, is not a towed vehicle. A vehicle which is driven from the scene and subsequently becomes disabled due to accident-related damage, such that towing is then required, is not a towed vehicle (even though that towing may be reported on the police report). Carefully scrutinize the PAR to determine the disposition of the vehicle directly from the scene and, if towing is indicated, the reason for the towing.

If a motorcycle is walked home [or a car pushed (by hand or by another car)] after the accident, then consider the motorcycle (and the car) as a towed vehicle. For tractor-trailer units, the disposition of the power unit (i.e., tractor) is recorded in this variable.

When a police report indicates that more than one event has occurred (i.e., stabilization is apparent), the disposition of this vehicle is based upon the event sequence selected for stratification. In other words, if the PAR indicates this vehicle was towed from the scene, and a researcher determines from the PAR that towing was not due to the damage sustained during this sequence, the correct response for this variable is "0" (Not towed due to vehicle damage).

When the PAR indicates that this vehicle was towed from the scene and it cannot be determined whether or not the towing was due to damage, the correct response for this variable is "1" (Towed due to vehicle damage).

Code "0" (Not towed due to vehicle damage) when:

- o the PAR indicates this vehicle was not towed from the scene, or
- o the PAR indicates this vehicle was towed from the scene but not due to accident-related disabling damage.

Code "1" (Towed due to vehicle damage) when:

- o the PAR indicates this vehicle was towed from the scene due to accident-related disabling damage, or

Variable Name: Police Reported Vehicle Disposition (cont'd.)

- o the PAR indicates this vehicle was towed from the scene and a researcher cannot determine (from the PAR data) if towing was due to accident-related disabling damage.

Code "9" (Unknown) is used when the investigating officer reported that the disposition of the vehicle was unknown at the time the PAR was completed. Also, use this code if the PAR indicates the vehicle was abandoned. However, if the police report specifies that the vehicle was disabled due to accident-related damage, as well as indicating either "unknown" or "abandoned" for disposition, it can be assumed that the vehicle will eventually be towed from the scene. In these instances, code "1" (Towed due to vehicle damage).

Variable Name: Police Reported Travel Speed

Element Values:

Range: 00 through 97, 99

Code to the nearest mph (Note: 00 means less than 0.5 mph)

97 96.5 mph and above

99 Unknown

Source: Police report only

Remarks:

Code the travel speed for this vehicle if indicated on the police report by the investigating officer. Do not use estimates by drivers or witnesses.

Code to the nearest mph, or if the travel speed is reported as a range, code the average. For example:

Reported Speed:	40.2 mph	40.5 mph	45-50 mph
Code:	"40"	"41"	"48"

Code "00" (00 mph) is used if this vehicle is stopped or traveling less than 0.5 mph.

Code "97" (96.5 mph and above) is used if this vehicle's speed is reported as equal to or exceeding 96.5 mph.

Code "99" (Unknown) is used if the estimated travel speed is unknown.

Variable Name: Police Reported Alcohol Presence

Element Values:

- 0 No alcohol present
- 1 Yes (alcohol present)
- 7 Not reported
- 8 No driver present
- 9 Unknown

Source: Police report.

Remarks:

The phrase "alcohol present" means that the driver had consumed an alcoholic beverage. Presence is not an indication that alcohol was in any way a cause of the accident, even though it may have been. Finding opened or unopened alcoholic beverages in the vehicle does not by itself constitute presence.

Code "0" (No alcohol present) is used if the investigating officer's assessment (as reported on the police report) is that no alcohol was present in the driver.

Code "1" [Yes (alcohol present)] is used if the police indicate alcohol presence in the driver via: (1) a specific data element on the police report form, (2) the police charge the driver with DWI, (3) the police mention in the narrative section of the report that the driver had been drinking (or alcohol was present or involved), or (4) the police report has a positive BAC test result (BAC > .00).

Code "7" (Not reported) is used if there is a specific location on the police report for assessment of alcohol presence but the investigating officer fails to make either a positive or negative assessment.

Code "8" (No driver present) is used when an in-transport vehicle was involved in the accident but no driver was in the vehicle at the time.

Code "9" (Unknown) is used if alcohol presence is indicated as unknown. In general, police reports have blocks to check either positive or negative alcohol presence. However, if a police report has provision for the investigating officer to respond "unknown presence", then used this code. In addition, use this code for hit-and-run drivers unless clear evidence to the contrary exists.

Some PARs have a block labeled "Alcohol/Drugs". If "presence" is indicated, and it cannot be determined which was used (e.g., narrative, arrest/charged section, etc.), then assume alcohol presence. If the police report indicates that a driver was charged with DWI (driving while intoxicated or driving while impaired) and no clarification is offered to indicate if the DWI was alcohol related or other drug related (i.e., a specific data element; mentioned in the narrative section; BAC results), then assume alcohol presence.

Variable Name: Alcohol Test Result For Driver

Element Values:

Range: 00-49; 95-99

Code actual value (decimal implied before first digit--0.xx).

95 Test refused
96 None given
97 AC test performed, results unknown
98 No driver present
99 Unknown

Source: Police report, medical reports, or other official sources.

Remarks:

Blood Alcohol Content (BAC) measures the percentage (expressed as a decimal) of the number of grams of alcohol in a liter of blood. The standard measure is expressed as the number of milligrams per deciliter (tenth of a liter) (e.g., .05 = 50 mg/100 ml; .15 = 150 mg/100 ml). A blood alcohol concentration (BAC) test could be a blood, breath, or urine test.

No psychomotor (police observation of driver actions) test results are coded here. Also, be aware of preliminary test results. These preliminary tests, including an instrumented field screening test, indicate the presence of alcohol, but not necessarily the particular content level. Preliminary tests are designed to segregate candidates for further testing from those persons where the suspected presence of alcohol is either nonexistent or too low for additional tests.

If an instrumented field screening test was given and it determined that:

- o no BAC test was required, code "96" (None given);
- o a BAC test was required, but the precise level was not obtained, code "97" (AC test performed, results unknown); or
- o a BAC test was required and the precise level was obtained, code the reported BAC from the subsequent test (codes "00"- "49").

If the BAC was given on the police report or subsequently added after the case was initiated, code the reported value. In essence, if any BAC is obtained, code the reported value. Use normal rounding rules (i.e., the number five or greater is rounded upward, less than five is rounded down). For example, a BAC of 117 mg/dl is coded "12".

For drivers of nontowed CDS applicable and non-CDS applicable vehicles, use only PAR information when coding test results.

Codes "00"- "49" report the actual number value representing the fraction of alcohol present.

Variable Name: Alcohol Test Result For Driver (cont'd.)

Code "00" is used when a test was performed, but no alcohol was detected.

Code "95" (Test refused) is used when the person refuses to voluntarily take a BAC test, and no subsequent test is given. If the person refuses, but a test is performed, code the reported BAC or "97" (AC test performed, results unknown).

Code "97" (AC test performed, results unknown) is used only after all available sources have been exhausted. Verbal BACs obtained from official sources are acceptable if written approval (or approval via the message system) has been obtained from the zone center. Obtain BAC test results whenever possible.

Code "98" (No driver present) is used when an in-transport vehicle was involved in the accident but no driver was in the vehicle at the time.

Code "99" (Unknown) is used when it is not known if a test was administered.

Variable Name: Speed Limit

Element Values:

Range: 00 through 65, 99

00 No statutory limit
Code posted or statutory speed limit
99 Unknown

Source: Primary sources are scene inspection or statutory law. Do not use the police report for selecting this variable's value.

Remarks:

Disregard advisory or other speed signs which do not indicate the legal speed limit. Furthermore, do not confuse advisory signs on entrance/exit ramps or near intersections with the actual legal maximum speed limit.

If no speed limit sign is posted within a reasonable distance from the location of the first accident event along the approach leg of the roadway this vehicle was traveling on, then reference state statutes to obtain the applicable statutory maximum speed limit for the location (local or state).

If a state has a statute that uniformly reduces the maximum allowable speed within or near a construction zone, then code the indicated reduced limit.

Code "00" (No statutory limit) is used on roadways which are neither posted nor have a statutory limit (e.g., parking lot roadways or entrance/exits, service station entrance/exits, or driveways, etc.).

Code "99" (Unknown) is used only in situations where an accident scene cannot be located. Note, speed limit must be identified for all known accident scene locations.

Variable Name: Attempted Avoidance Maneuver

Element Values:

- 00 No impact
- 01 No avoidance actions
- 02 Braking (no lockup)
- 03 Braking (lockup)
- 04 Braking (lockup unknown)
- 05 Releasing brakes
- 06 Steering left
- 07 Steering right
- 08 Braking and steering left
- 09 Braking and steering right
- 10 Accelerating
- 11 Accelerating and steering left
- 12 Accelerating and steering right
- 97 No driver present
- 98 Other action (specify)
- 99 Unknown

Source: Researcher determined--inputs include the driver interview, police report, and the scene inspection.

Remarks:

Attempted avoidance maneuvers (pre-event) are movements/actions taken by the driver to avoid the impending first harmful event after realization of an impending danger, but before the actual event. Because this variable focuses upon the driver's action just prior to the first harmful event it is coded independently of any maneuvers associated with this driver's Accident Type, GV15.

Code the attribute which best describes the actions taken by the driver. When there was a known action, but you cannot determine whether there was more than one action (e.g., braking and steering left) default to the known action (e.g., braking).

Code "01" (No avoidance action) is used whenever the driver did not attempt any evasive (pre-event) maneuvers, or when the driver was not present.

Code "97" (No driver present) is used whenever GV16, Driver Presence in Vehicle, is coded "0" (Driver not present).

Variable Name: Accident Type

Element Values:

Range: 00-16, 20-93, 98, 99

00 No impact

Code the number of the diagram that best describes the accident circumstance.

98 Other accident type (specify)

99 Unknown

Diagrams: See next page.

Source: Researcher determined - inputs include police report, scene inspection, vehicle inspection, and interview.

Remarks:

This variable is used for categorizing the collisions of drivers involved in accidents. A collision is defined here as the first harmful event in an accident between a vehicle and some object, accompanied by property damage or human injury. The object may be another vehicle, a person, an animal, a fixed object, the road surface, or the ground. If the first collision is a rollover, the impact is with the ground or road surface. The collision may also involve plowing into soft ground, if severe vehicle deceleration results in damage or injury. A road departure without damage or injury is not defined as a collision.

To determine the proper accident type (AT), refer to Figure 1 and follow the three step decision process outlined below:

Step 1 - Determine the appropriate category.

Step 2 - Determine the appropriate configuration.

Step 3 - Determine the specific accident type (two digit codes).

The categories are divided into six sections and are described as follows:

- o Category I. Single Driver - The first harmful event involves a collision between an in-transport vehicle and an object. A harmful event involving two in-transport vehicles is excluded from this category. Note, the impact location on the vehicle is not a consideration for accident types in this category.
- o Category II. Same Trafficway, Same Direction - The first harmful event occurred while both vehicles were traveling in the same direction on the same trafficway.
- o Category III. Same Trafficway, Opposite Direction - The first harmful event occurred while both vehicles were traveling in opposite directions on the same trafficway.

Variable Name: Accident Type (cont'd.)

Figure 1

Category	Configuration	ACCIDENT TYPES (Includes Involvement)													
I. Single Driver	A. Right Roadside Departure	01 DRIVE OFF ROAD	02 CONTROL/TRACTION LOSS	03 AVOID COLLISION WITH VEH., PED., ANIM.	04 SPECIFICS OTHER	05 SPECIFICS UNKNOWN									
	B. Left Roadside Departure	06 DRIVE OFF ROAD	07 CONTROL/TRACTION LOSS	08 AVOID COLLISION WITH VEH., PED., ANIM.	09 SPECIFICS OTHER	10 SPECIFICS UNKNOWN									
	C. Forward Impact	11 PARKED VEH.	12 STA. OBJECT	13 PEDESTRIAN/ANIMAL	14 END DEPARTURE	15 SPECIFICS OTHER	16 SPECIFICS UNKNOWN								
II. Same Trafficway Same Direction	D. Rear-End	20 STOPPED 21, 22, 23	21 SLOWER 24, 25, 27	22	23	24	25	26	27	28 DECEL. 29, 30, 31	29	30	31	(EACH - 32) SPECIFICS OTHER	(EACH - 33) SPECIFICS UNKNOWN
	E. Forward Impact	34 CONTROL/TRACTION LOSS	35 CONTROL/TRACTION LOSS	36 AVOID COLLISION WITH VEH.	37	38 AVOID COLLISION WITH OBJECT	39	40	41	(EACH - 42) SPECIFICS OTHER	(EACH - 43) SPECIFICS UNKNOWN				
	F. Sideswipe/Angle	44	45	46	47	(EACH - 48) SPECIFICS OTHER	(EACH - 48) SPECIFICS UNKNOWN								
III. Same Trafficway Opposite Direction	G. Head-On	50 LATERAL MOVE	51 (EACH - 52) SPECIFICS OTHER	(EACH - 53) SPECIFICS UNKNOWN											
	H. Forward Impact	54 CONTROL/TRACTION LOSS	55 CONTROL/TRACTION LOSS	56 AVOID COLLISION WITH VEH.	57	58 AVOID COLLISION WITH OBJECT	59	60	61	(EACH - 62) SPECIFICS OTHER	(EACH - 63) SPECIFICS UNKNOWN				
	I. Sideswipe/Angle	64 LATERAL MOVE	65 (EACH - 66) SPECIFICS OTHER	(EACH - 67) SPECIFICS UNKNOWN											
IV. Change Trafficway Vehicle Turning	J. Turn Across Path	70 INITIAL OPPOSITE DIRECTIONS	71 INITIAL SAME DIRECTIONS	72	73	74	75	76	(EACH - 74) SPECIFICS OTHER	(EACH - 75) SPECIFICS UNKNOWN					
	K. Turn Into Path	77 TURN INTO SAME DIRECTION	78	79 TURN INTO OPPOSITE DIRECTIONS	80	81	82	(EACH - 84) SPECIFICS OTHER	(EACH - 85) SPECIFICS UNKNOWN						
V. Intersecting Paths (Vehicle Damage?)	L. Straight Paths	87	88	(EACH - 89) SPECIFICS OTHER	(EACH - 89) SPECIFICS UNKNOWN										
VI. Miscellaneous	M. Backing Etc.	82 BACKING VEH.	89 OTHER VEH. OR OBJECT	88 Other Accident Type	89 Unknown Accident Type	88 No Impact									

Variable Name: Accident Type (cont'd.)

- o Category IV. Change Trafficway, Vehicle Turning - The first harmful event occurred when the vehicle is either turning or merging while attempting to change from one trafficway to another trafficway. Trafficway for this variable is loosely defined to include driveways, alleys and parking lots when a vehicle is either entering or exiting a trafficway.
- o Category V. Intersecting Paths (Vehicle Damage) - The first harmful event involves situations where vehicle trajectories intersect. It is important to note the location of damage to each vehicle for accident typing.
- o Category VI. Miscellaneous - The first harmful event involves an accident type which cannot be described in Categories I-V and thus is included in this category.

Each category is further defined by an Accident Configuration(s). Configurations A through M are discussed below.

Category I. Single Driver

- o Configurations A and B ... Roadside Departure - The vehicle departed either the right or left side of road with the first harmful event occurring off the road. Right versus left is based on the side of the road departed immediately prior to the first harmful event.
- o Configuration C. Forward Impact - The vehicle struck an object on the road or off the end of a trafficway while moving forward.

Category II. Same Trafficway, Same Direction

- o Configuration D. Rear-End - The front of the overtaking vehicle impacted the rear of the other vehicle.

Note, even if the rear-impacted vehicle had started to make a turn, code here (not in **Category IV**).

- o Configuration E. Forward Impact - The front of the overtaking vehicle impacted the rear of the other vehicle, following a steering maneuver around a noninvolved vehicle or object.
- o Configuration F. Sideswipe/Angle - The two vehicles are involved in a shallow, glancing impact involving the side of one or both vehicles.

Note, CDC guidelines for sideswipes are not considered when assessing this configuration.

Variable Name: Accident Type (cont'd.)

Category III. Same Trafficway, Opposite Direction

- o Configuration G. Head-On - The frontal area of one vehicle impacted the the frontal area of another.
- o Configuration H. Forward Impact - The frontal area of one vehicle impacted the frontal area of another following a steering maneuver around a noninvolved vehicle or an object.
- o Configuration I. Sideswipe/Angle - The two vehicles are involved in a shallow, glancing impact involving the side of one or both vehicles.

Category IV. Changing Trafficway, Vehicle Turning

- o Configuration J. Turn Across Path - The two vehicles were initially on the same trafficway when one vehicle tried to turn onto another trafficway and pulled in front of the other vehicle. Vehicles making a "U" turn are identified in **Category VI. Miscellaneous**.
- o Configuration K. Turn Into Path - The two vehicles were initially on different trafficways when one attempted to turn into the same trafficway as the other vehicle.

Note, the focus of this configuration is on the turning maneuver from one trafficway to another and not on the vehicles' plane of contact.

Category V. Intersecting Paths (Vehicle Damage)

- o Configuration L. Straight Paths - The two vehicles were proceeding (or attempting to proceed) straight ahead.

Category VI. Miscellaneous

- o Configuration M. Backing, Etc. - One of the two vehicles involved was a backing vehicle, regardless of its location on the trafficway or the damage location on the vehicles.

Any accident configuration which cannot be described in **Category I.** through **V.** is included here.

The configurations are delineated into specific accident types. These types can be identified by referring to the accident type diagram in Figure 1.

Variable Name: Accident Type (cont'd.)

The accident types in **Category I. (Single Driver)** involve an impact between a vehicle and an object. **Categories II. through VI.** identify specific collision combinations which must be coded in specified pairs (i.e., the pair code defines the Accident Type). As an example, the combination "20" (Rear-end, stopped) and "32" (Rear-end, specifics other) or "20" (Rear-end, stopped) and "25" (Slower, straight ahead) are not valid since "20" (Rear-end, stopped) only has meaning when linked to codes "21"- "23" (Stopped,).

An accident involving a vehicle impacting a "driverless in-transport vehicle" is coded "..., specifics other" in the appropriate configuration-category. For example, a vehicle which impacts the rear of a driverless in-transport vehicle is encoded "32" (Rear-end, specifics other) and "32".

In accidents involving more than two vehicles or in collision sequences involving a combination of vehicle-to-object-to-vehicle impacts, code the Accident Type for the vehicle(s) involved in the first harmful event. All other vehicles are coded "98" (Other accident type).

Keep in mind that intended actions play an important role in the coding scheme. For example, accident type "26" (Slower, turning left) is selected over type "25" (Slower, straight ahead) if the subject vehicle was traveling slower with the intention of turning left. Note, the turning action need not have occurred prior to the collision. The driver's intent to turn is the key.

The following accident types require clarification.

Code "00" (No impact) identifies noncollision events (fire, immersion, etc.). Rollovers on the road should be coded "98" (Other accident type).

Codes "01" (Right roadside departure, drive off road) and "06" (Left roadside departure, drive off road) are used when the vehicle departed the road under a controlled situation (i.e., the driver was distracted, fell asleep, intentionally departed, etc.).

Codes "02" (Right roadside departure, control/traction loss) and "07" (Left roadside departure, control/traction loss) are used if there is some evidence that the vehicle lost traction or in some other manner "got away" from the driver (i.e., the vehicle spun off the road as a result of surface conditions, oversteer phenomena, or mechanical malfunctions). If doubt exists, code "01" (Right roadside departure, drive off road) or "06" (Left roadside departure, drive off road) respectively.

Codes "03" (Right roadside departure; avoid collision with vehicle, pedestrian, animal) and "08" (Left roadside departure; avoid collision with vehicle, pedestrian, animal) are used when the vehicle departed the road as a result of avoiding something in the road. "Phantom" situations are included here.

Variable Name: Accident Type (cont'd.)

Codes "03" (Right roadside departure; avoid collision with vehicle, pedestrian, animal), "08" (Left roadside departure; avoid collision with vehicle, pedestrian, animal) and "13" (Forward impact, pedestrian/animal) include pedestrians, bicyclists, other cyclists and other nonmotorists.

Codes "04" (Right roadside departure, specifics other) and "09" (Left roadside departure, specifics other) are used for any other stationary or nonstationary objects if the avoidance characteristics of codes "03" or "08" are present.

Codes "11" (Forward impact, parked vehicle), "12" (Forward impact, stationary object), and "13" (Forward impact, pedestrian/animal) involve an impact with an object which can be located on either side of the road.

Code "12" (Forward impact, stationary object) includes a hole in the road, an overhead object (e.g., overpass) or an object projecting over the road edge (e.g., support column of elevated railway).

Code "13" (Forward impact, pedestrian/animal) is used when a pedestrian, non-motorist, or animal is involved with the first harmful event. Vehicle plane of contact is not a consideration.

Code "15" (Forward impact, specifics other) is used for impacted (striking or struck) trains and nonstationary objects on the road.

Codes "44" (Sideswipe/Angle, straight ahead on left), "45" (Sideswipe/Angle, straight ahead on left/right), "46" (Sideswipe/Angle, changing lanes to the right), and "47" (Sideswipe/Angle, changing lanes to the left) identify relative vehicle positions (left versus right) and lane of travel intentions (straight ahead versus changing lanes).

From these four codes, four combinations are permitted. They are: (1) "44" and "45", (2) "46" and "45", (3) "45" and "47", and (4) "46" and "47". When used as a combination these codes refer to a sideswipe or angle collision which involved a vehicle to the left of a vehicle to the right where:

- o (1) neither vehicle (codes "44" and "45") intended to change its lane;
- o (2) the vehicle on the left (code "46") was changing lanes to the right, and the vehicle on the right (code "45") was not intending to change its lane;
- o (3) the vehicle on the left (code "45") was not intending to change its lane, and the vehicle on the right (code "47") was changing lanes to the left; and
- o (4) the vehicle on the left (code "46") was changing lanes to the right, and the vehicle on the right (code "47") was changing lanes to the left.

Variable Name: Accident Type (cont'd.)

In addition, when: (1) the right sides of the two vehicles impact following a 180 degree rotation of the vehicle on the right, or (2) the left sides of the two vehicles impact following a 180 degree rotation of the vehicle on the left; select the appropriate combination ("44"- "45", "46"- "45", "45"- "47", or "46"- "47") depending upon: (3) their positions (i.e., left versus right) and (4) the intended lane of travel (straight ahead versus changing lanes) of their drivers.

Code "48" (Sideswipe/Angle, specifics other) is used if one vehicle was behind the other prior to their **Category II, Configuration F** collision. For example, use this code when two vehicles are on the same trafficway and going the same direction, and one loses control and is struck in the side by the front of the other vehicle. However, if one vehicle rotates such that the impact is front to front, then use code "98" (Other accident type).

Code "64" (Sideswipe/Angle, lateral move--infringing vehicle) identifies the vehicle which infringed upon the other (code "65") in a **Category III, Configuration I** collision.

Codes "68" through "85" (Turn Across Path and Turn Into Path) are used in Configurations J and K where the vehicle's action is the controlling factor, and the plane of contact is irrelevant.

Code "82" (Left turn into opposite direction) is used when the driver's vehicle was in the act of making a left turn (e.g., from a driveway, parking lot or intersection). Do not confuse this situation with Configuration L. Straight Paths. The driver's intended path is the prime concern.

Codes "86" through "89" (Straight Paths) must not be confused with accident types in Configuration K. Turn Into Path. For these codes the vehicles are proceeding (or attempting to proceed) straight ahead, usually at a junction.

Code "98" (Other accident type) is used for those events and collisions which do not reasonably fit any of the specified types. This code includes:

- o rollovers on the road;
- o third or subsequent vehicles involved in an accident; or
- o the second involved vehicle when the first harmful event involved a vehicle-to-object collision.

OFFICIAL INJURY DATA – INTERNAL INJURIES

Indicate the *Location*, *Lesion*, *Detail* (size, depth, fracture type, head injury clinical signs and neurological deficits), and *Source* of all injuries indicated by official sources (or from PAR or other unofficial sources if medical records and interviewee data are unavailable.)

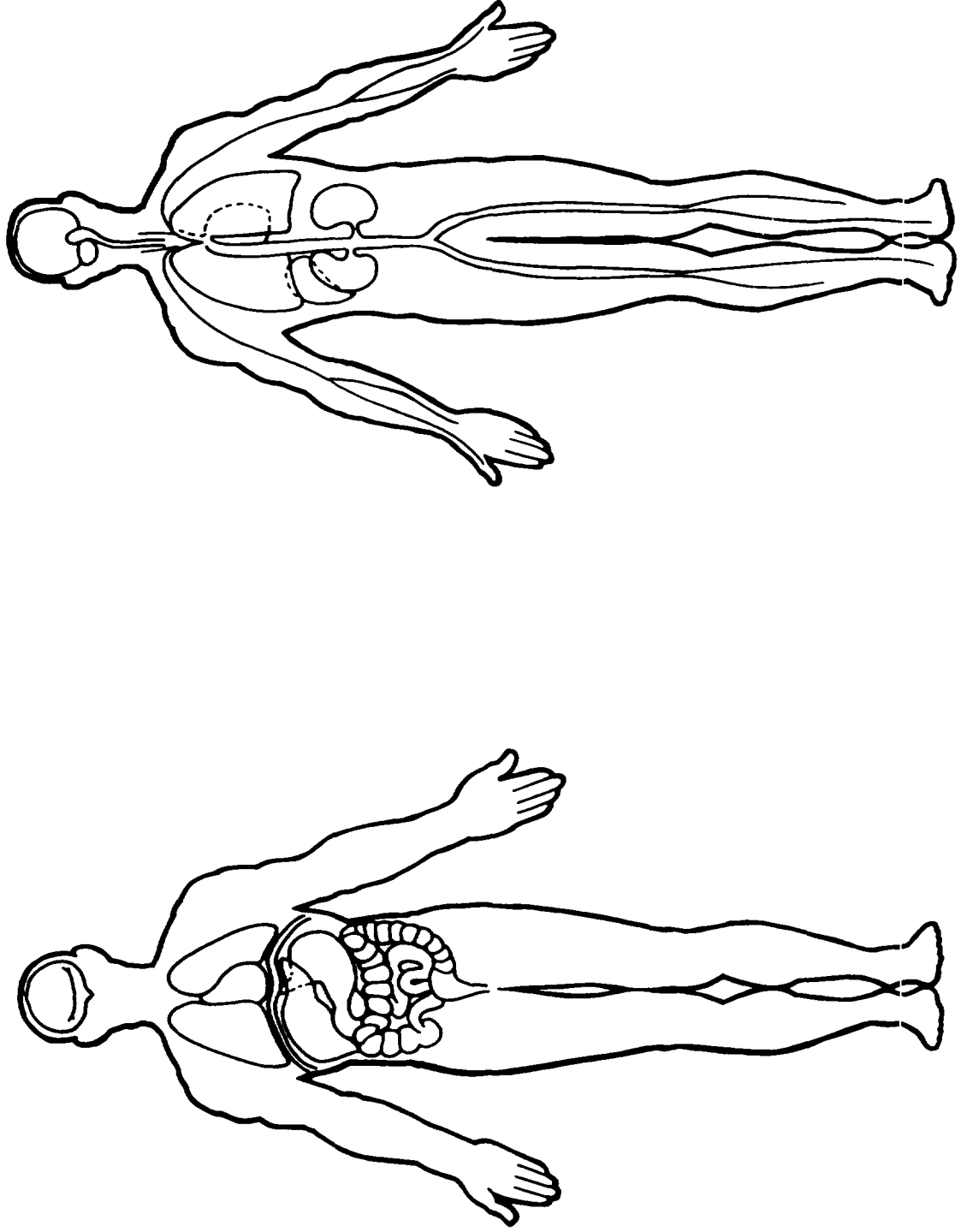

Variable Name: Number of Occupants This Vehicle

Element Values:

Range: 00 through 97, 99, Blank

Blank (GV07 = 50-99)

00-96 Code actual number of occupants for this vehicle

97 97 or more

99 Unknown

Source: Police report and interviewees

Remarks:

Code the actual number of persons (including the driver) that were occupants of this vehicle. The number of Occupant Assessment Forms submitted (GV18, Number of Occupant Forms Submitted) need not equal this value.

Code "99" (Unknown) is used when:

- o the actual number of occupants is unknown, or
- o this vehicle is a "hit-and-run" vehicle--unless reliable evidence clearly establishes the number of occupants present.

Variable Name: Number of Occupant Forms Submitted

Element Values:

Range: 00 through 30, Blank

Blank (GV07 = 50-99)

00-30 Code actual number of Occupant Assessment Forms submitted for this vehicle

Source: Researcher determined; inputs include police report, vehicle inspection, and interviews.

Remarks:

If this vehicle is a police reported towed CDS applicable vehicle [i.e., GV07, Body Type, equals "01"-"49" and GV09, Police Reported Vehicle Disposition, equals "1" (Towed due to vehicle damage)], then an Occupant Assessment Form must be completed for each occupant. Enter the number of forms encoded and submitted for this vehicle. If this vehicle is not a CDS applicable vehicle (i.e., GV07 equals "50"-"99"), then this variable must be left **"Blank"**.

Code "00" (zero Occupant Assessment Forms submitted) when:

- o this vehicle is a police reported nontowed CDS applicable vehicle [i.e., GV07 equals "01"-"49" and GV09 equals "0" (Not towed due to vehicle damage) or "9" (Unknown)] except for AOPS vehicles, or
- o this vehicle was in-transport and unoccupied.

Code "01" (One occupant) is used in the case of a "hit-and-run" police reported towed CDS applicable vehicle, where it is assumed that only one occupant/driver was present. Additional Occupant Assessment Forms (and thus increase the number coded here) can be submitted if reliable evidence exists that additional occupants were present.

Variable Name: Vehicle Curb Weight

Element Values:

Range: 010 through 135, 999, Blank

Blank (GV07 = 50-99)

Code weight to the nearest 100 pounds.

010 Less than 1,050 pounds

135 13,500 lbs. or more

999 Unknown

Source: Primary and secondary sources are listed below.

Remarks:

Code this vehicle's curb weight to the nearest 100 pounds as in the examples.

Weight: 3,230 lbs.
Code: "032"

Weight: 7,500 lbs.
Code: "075"

Do not confuse the rated Gross Vehicle Weight Rating (GVWR) with the curb weight since it is likely to be significantly greater than the curb weight.

"Vehicle" is defined on this variable to mean the same as that coded on GV07, Body Type.

If the vehicle model (GV06) is known, but the engine size is unknown (e.g., 6 or 8 cylinders), code the average between the high and low curb weights for the model and annotate that the "average" was reported.

When the vehicle specifications do not report the vehicle weight with the proper engine size, adjustments must be made. First, try to determine the weight differences from the vehicle specifications. If the weight difference cannot be determined from the specifications, then adjust as follows: 8 cyl. to 6 cyl. - subtract 100 lbs.; 6cyl. to 4 cyl. - subtract 75 lbs.

Add 100 lbs. to the shipping weight to obtain a curb weight on all CDS applicable vehicles.

The primary source for obtaining this vehicle's curb weight is the first source of reference material listed below; the next three sources are secondary.

Variable Name: Vehicle Curb Weight (cont'd.)

Passenger Vehicle Specifications
Motor Vehicle Manufacturers Association
of the U.S., Inc.
300 New Center Building
Detroit, Michigan 48202

Automotive News
Crain Automotive Group, Inc.
965 East Jefferson Avenue
Detroit, Michigan 48207

Branham Automobile Reference Book
Branham Publishing Company
Post Office Box 1948
Santa Monica, California 90406

Gasoline Truck Index and
Diesel Truck Index
Truck Index, Inc.
Post Office Box 4221
Anaheim, California 92803

Annotate the source used in the space provided on the General Vehicle Form under this variable.

If variable GV21, Towed Trailing Unit, is coded "1" (Yes - towed trailing unit), then the weight of the trailer and its cargo is not coded here. Instead, it is coded under variable GV20, Vehicle Cargo Weight. For example, the weight of a boat trailer and its cargo are encoded on Vehicle Cargo Weight (GV20), distinct from the weight of the vehicle.

Code "999" (Unknown) when the curb weight of this vehicle cannot be determined.

Variable Name: Vehicle Cargo Weight

Element Values:

Range: 00 through 97, 99, Blank

Blank (GV07 = 50-99)

Code weight to nearest 100 pounds.

00 Less than 50 pounds

97 9,650 lbs. or more

99 Unknown

Source: Researcher determined -- inputs include vehicle inspection and interviewees.

Remarks:

If variable GV21, Towed Trailing Unit, is coded "1" (Yes - towed trailing unit), then the weight of the trailer and its cargo is coded here. Cargo may also be located in the passenger compartment area and/or trunk.

Do not include the weight of the occupants in the cargo weight. The weight of the occupants is included (along with cargo and vehicle curb weight) as a component of the single value which represents the vehicles combined weight on the CRASH Program Summary Form, if used.

Code this vehicle's cargo weight to the nearest 100 pounds as in the examples.

Weight: 180 lbs.
Code: "02"

Weight: 3,230 lbs.
Code: "32"

Code "00" (Less than 50 pounds) is used if the cargo weight is less than 50 pounds.

Code "97" (9,650 lbs. or more) is used if the cargo weight is 9,650 pounds or more.

Code "99" (Unknown) is used if the cargo weight is unknown.

Variable Name: Towed Trailing Unit

Element Values:

Blank (GV07 = 50-99)
0 No towed unit
1 Yes - towed trailing unit
9 Unknown

Source: Vehicle inspection, interviews, and police report

Remarks:

A trailing unit includes horse trailers, fifth wheel trailers, travel trailers, camper trailers, boat trailers, truck trailers, towed motor vehicles, or any other trailer.

If this variable is coded "1" (Yes - towed trailing unit), then enter the weight of the trailer as well as any cargo it may be carrying in variable GV20, Vehicle Cargo Weight.

Code "0" (No towed unit) is used when a trailing unit is not being towed by this CDS applicable vehicle.

Code "1" (Yes - towed trailing unit) is used when a trailing unit is being towed by this CDS applicable vehicle.

Code "9" (Unknown) is used when it is uncertain whether code "0" or "1" applies.

Variable Name: Documentation of Trajectory Data for This Vehicle

Element Values:

Blank (GV07 = 50-99)

0 No

1 Yes

Source: Researcher determined - inputs include scene inspection, vehicle inspection, police report, and interviews.

The purpose of this variable is to assess the availability of accident induced physical evidence for impact and final rest, including multiple impacts.

Code "0" (No) means there was insufficient accident induced physical evidence to know or approximate the point of impact and final rest position for this vehicle's Highest Delta V CDC (EV06-EV11, Collision Deformation Classification).

Code "1" (Yes) is used when sufficient accident induced physical evidence is available to know or approximate the point of impact and final rest position for this vehicle's Highest Delta V CDC, independently of whether the CRASHPC program trajectory algorithm could be used (e.g., multiple impacts, missing vehicle, etc.).

For multiple impacts assess this variable with respect to the highest delta V impact. To code "Yes" ("1") the point of impact must be known as well its next point of impact or, if the highest delta V impact is the last impact for this vehicle, its final rest position.

When a nonhorizontal and/or rollover type collision is the highest delta V impact for this vehicle, code "Yes" ("1") if the point of impact (trip point or first contact) and final rest position are known.

The word "approximated" as used above means that the impact and final rest positions do not need to be known precisely, but they are reasonable accurate based on the available physical evidence. Approximated does not mean guesstimated (i.e., level I sketch).

Variable Name: Post Collision Condition of Tree or Pole
(for Highest Delta V)

Element Values:

- Blank (GV07 = 50-99)
 0 Not collision (for highest delta V) with tree or pole
 1 Not damaged
 2 Cracked/sheared
 3 Tilted < 45 degrees
 4 Tilted \geq 45 degrees
 5 Uprooted tree
 6 Separated pole from base
 7 Pole replaced
 8 Other (specify):
 9 Unknown

Source: Scene inspection and PAR.

Remarks:

Codes "1" through "8" are used when EV05, Object Contacted, is encoded "41" [Tree (\leq 4 inches in diameter)], "42" [Tree (> 4 inches in diameter)], "45" [Breakaway pole or post (any diameter)], or "50"- "53" (Nonbreakaway Pole or Post).

Code "0" [Not collision (for highest delta V) with tree or pole] is used when the EV05, Object Contacted, that produced this vehicle's highest delta V is not a tree or pole (e.g., vehicle-to-vehicle collision).

Code "1" (Not damaged) is used when the tree or pole has no visible damage or minor surface damage.

Code "2" (Cracked/sheared) describes a pole or tree that is cracked (10% or more of the fibers), sheared, or bent. Bent and cracked poles may be tilted and the bending/cracking can be at any height. This code takes precedence over codes "3" (Tilted < 45 degrees), "4" (Tilted \geq 45 degrees), and "5" (Uprooted tree). Fallen limbs do not constitute "cracked" for a tree; the assessment is made at the tree's trunk. This code does not describe metal breakaway poles sheared at their base [see code "6" (Separated pole from base)].

Code "3" (Tilted < 45 degrees) describes a pole or tree that is inclined at less than a 45 degree angle as a result of this collision. If the tree/pole is also cracked, then use code "2" (Cracked/sheared).

Code "4" (Tilted \geq 45 degrees) describes a pole or tree that is inclined at a 45 degree angle or greater as a result of this collision. If the tree/pole is also cracked, then use code "2" (Cracked/sheared).

Code "5" (Uprooted tree) describes a tree that was completely or partially torn out of the ground; the tree trunk remained intact; however, the root system was pulled from the soil.

INSTRUCTIONS FOR COMPLETION OF CDS APPLICABLE FIELD MEASUREMENTS PAGE

Specific Impact Number contains the impact sequence number specific to this vehicle for which the data are being obtained.

Plane of C-Measurements contains the annotation of the plane at which the crush profile is documented (i.e., bumper, grille, sill, mid-door). This column is annotated "average" when used to indicate the resultant profile from an underride-type impact.

Direct Damage: Width contains the indication of the length of direct damage as measured on the vehicle.

Direct Damage: Max Crush contains the measured maximum crush for the profile being documented. Recall that maximum crush is determined after free space is subtracted. Indicate the free space at Max Crush in the space below the measurement. Use a third line to indicate the resultant maximum crush.

Field L contains the recorded Field L as obtained during the vehicle inspection. Recall that the Field L represents both direct and induced damage as measured along the reference line (shock cord). This measurement is used to locate the position of the C-measurements.

C1-C6 contains the recorded two, four, or six C-measurements (as appropriate) on the line for the crush profile being documented. On the line beneath, annotate the free space to be subtracted. A third line is used to record the resultant crush profile.

± D contains the recorded "D" dimension. The data obtained for the Field L damage locator is used to calculate "D"; indicate whether it is a positive or negative value.

If the spaces provided are not sufficient for the number of impacts which require documentation, include the additional data on the back of the first page of the Exterior Vehicle Form.

In the following example, a crush profile for a frontal bumper underride impact is displayed. This example is used as a guideline when completing the first page of the Exterior Vehicle Form.

Variable Name: Rollover

Element Values:

Blank (GV07 = 50-99)

0 No rollover (no overturning)

Rollover (primarily about the longitudinal axis)

1 Rollover, 1 quarter turn only

2 Rollover, 2 quarter turns

3 Rollover, 3 quarter turns

4 Rollover, 4 or more quarter turns (specify):

5 Rollover--end-over-end (i.e., primarily about the lateral axis)

9 Rollover (overturn), details unknown

Source: Primary sources are the vehicle and scene inspections; secondary sources include photographs, police report, driver interviews, and other interviewees.

Remarks:

Rollover is defined as any vehicle rotation of 90 degrees or more about any true longitudinal or lateral axis. Rollover can occur at any time during the collision and is coded independently of other configuration questions.

Code "0" [No rollover (no overturning)] if uncertainty exists concerning whether or not this vehicle rolled over. In addition, use this code if a trailer attached to the vehicle rolled over but the vehicle itself did not.

Codes "1", "2", "3", and "4" (Rollover,) are coded on the basis of the researcher's accident reconstruction. A "quarter turn" is defined as a rotation of 90 degrees about an axis of the vehicle; this does not include rotation about the vertical axis, commonly called yaw. Therefore, if a vehicle rolled longitudinally onto its roof (i.e., side-to-side roll), then it rolled 180 degrees and is coded "2" (Rollover, 2 quarter turns). When a vehicle rolls four or more quarter turns, code "4" (Rollover, 4 or more quarter turns) and specify the number of quarter turns involved.

Code "5" [Rollover--end-over-end (i.e., primarily about the lateral axis)] is used when the rollover is mainly end-over-end. This code is used when a rollover is a combination of a side-to-side and end-over-end roll and it cannot be determined which type of rollover is most prevalent.

Variable Name: Front Override/Underride (this vehicle)
Rear Override/Underride (this vehicle)

Element Values:

Blank (GV07 = 50-99)

0 No override/underride, or not an end-to-end impact

Override (see specific CDC)

1 1st CDC

2 2nd CDC

3 Other not automated CDC (specify):

Underride (see specific CDC)

4 1st CDC

5 2nd CDC

6 Other not automated CDC (Specify):

7 Medium/heavy truck or bus override

9 Unknown

Source: Vehicle inspection (with exceptions as noted)

Remarks:

Override/Underride is coded from the perspective of vehicle impact configuration and is not based on: coding in columns 5 and/or 6 of the CDC, or vehicle measurement techniques (i.e., the "5-inch" rule for CRASH purposes).

These variables are intended to capture those instances where there is an uneven damage pattern caused by uneven amounts of crush in different vertical zones of the front and/or rear planes of the vehicle. Because of the different crush stiffnesses involved in these locations, these variables are included to alert the vehicle safety analysts to uneven crush patterns in front and rear impacts, which are not identified in the CDC (i.e., columns 5 and/or 6).

For those variables an impact with a not-in-transport vehicle (either CDC applicable or a medium/heavy truck) is considered a vehicle-to-vehicle impact and not a vehicle-to-object impact.

GV25, Front Override/Underride (this vehicle), specifies the override/underride result to the vehicle which sustained the frontal impact. Similarly, GV26, Rear Override/Underride (this vehicle), encodes either override or underride to the vehicle which sustained the rear impact.

The term "override" means a vehicle overrode (i.e., goes on top of) the bumper (front or rear) of the other vehicle.

The term "underride" means a vehicle underrode (i.e., goes below) the bumper (front or rear) of the other vehicle.

GV25
GV26
(2)

Variable Name: Front Override/Underride (this vehicle) [cont'd.]
Rear Override/Underride (this vehicle) [cont'd.]

If a vehicle is not equipped with a bumper (e.g., rear of some pickup trucks), then consider the equivalent end structure for coding these variables.

SITUATION A

GV25	GV26	
"1"- "3"	"0"	(VEH. #1)
"0"	"4"- "6"	(VEH. #2)

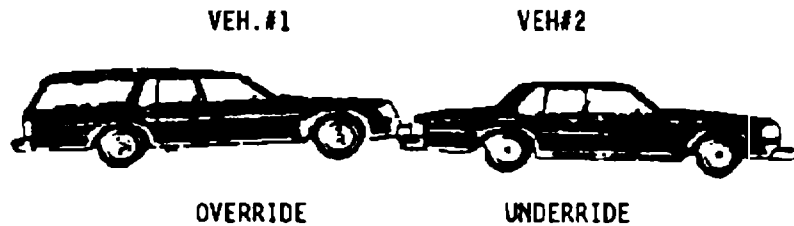

SITUATION B

GV25	GV26	
"4"- "6"	"0"	(VEH. #1)
"0"	"1"- "3"	(VEH. #2)

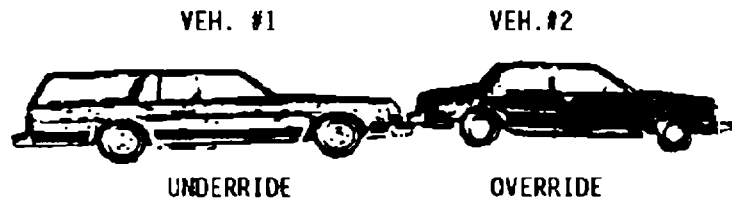

As indicated in **Situation A**, the trunk area of Vehicle #2 is damaged (i.e., "crushed") while the rear bumper is relatively undisturbed. Hence, the uneven damage pattern. Conversely, the front of Vehicle #1 is "crushed" at bumper height only, or is crushed uniformly at the bumper and grille levels (i.e., an "even" damage pattern). Even though Vehicle #1 may not exhibit the uneven damage pattern, it would still receive an applicable override code due to the resultant underride damage to Vehicle #2.

When the bumper receives measurable crush and the area above the bumper also receives measurable crush, the override/underride codes are applicable if the impact configuration applies. For example, (**Situation B**) the front bumper (Vehicle #1) may be crushed 2" rearward and the grille area may be crushed 6" rearward. While the averaging technique rule for CRASH does not apply for the different levels of crush, the impact may in fact meet the configuration rule for the override/underride variables.

When override/underride are applicable, these variables are coded based upon the corresponding CDC. Elements "1" and "4" (1st CDC) are used when EV06- EV11, represents the override or underride damage. Elements "2" and "5" (2nd CDC) are used when EV14-EV19 represents the override/underride damage. Elements "3" and "6" (Other not automated CDC) are used when the override/underride appears on the CDC Worksheet (**Page 3** of the Exterior Vehicle Form) but is not coded in variables EV06-EV11 or EV14-EV19, Collision Deformation Classification.

Variable Name: Front Override/Underride (this vehicle) [cont'd.]
Rear Override/Underride (this vehicle) [cont'd.]

Code "0" (No override/underride, or not an end-to-end impact) when:

- o both vehicles are inspected and no override/underride occurred for the end-to-end impact (code "0" for both vehicles); or
- o the impact configuration is not end-to-end.

Codes "1" through "6" are used to record this CDS applicable vehicle's involvement with another CDS applicable vehicle in an end-to-end impact resulting in this vehicle either overriding or underriding the other involved CDS applicable vehicle.

Code "1", "2", or "3" [Override (see specific CDC)] when:

- o this inspected vehicle is involved in an override situation, and
- o its CDC is entered in: EV06-EV11 (code "1"), EV14-EV19 (code "2"), or on the CDC Worksheet only [Page 3 of the Exterior Vehicle Form (code "3")].

Code "4", "5", or "6" [Underride (see specific CDC)] when:

- o this inspected vehicle is involved in an underride situation, and
- o its CDC is entered in: EV6-EV11 (code "4"), EV14-EV19 (code "5"), or on the CDC Worksheet only [Page 3 of the Exterior Vehicle Form (code "6")].

Code "7" (Medium/heavy truck or bus override) is used if this inspected CDS applicable vehicle's front or rear bumper was underneath (i.e., underride) a medium/heavy truck or bus (GV07 = 50, 58, 59, 60-69) such that an uneven crush pattern resulted to this CDS applicable vehicle's: (1) bumper/grille area (or bumper/"trunk" area), and/or (2) the above-bumper (front or rear) and greenhouse areas.

Code "9" (Unknown) is used when:

- o this vehicle was involved in an end-to-end impact configuration and: (1) it was not inspected, or (2) it was repaired; or
- o this vehicle is inspected but the researcher cannot determine that an override/underride occurred for this vehicle for the end-to-end impact, and the other vehicle is not inspected; or
- o the vehicle-to-vehicle impact configuration type is unknown.

Variable Name: Heading Angle for This Vehicle
Heading Angle for Other Vehicle

Element Values:

Blank (GV07 = 50-99)
000-359 Code actual value
997 Noncollision
998 Impact with object
999 Unknown

Source: Scene inspection, vehicle inspection, and interviews

Remarks:

GV27, Heading Angle for This Vehicle, records the heading angle for this vehicle's highest delta V when this impact was with another vehicle. Variable GV28, Heading Angle for Other Vehicle, records the corresponding angle for the other vehicle. Note, for these variables, parked vehicles are considered other vehicles and not objects.

For vehicle-to-vehicle collisions, use your scene diagram referencing system to determine the heading angles at the point of impact for this vehicle's highest delta V. All measurements are referenced to the north arrow on the diagram. The heading angle of each vehicle is determined by projecting the longitudinal axis of the vehicle through the extension of the north arrow. The angle value is obtained by using a 360° protractor and measuring in a clockwise direction from the north arrow. The north arrow always represents 0° (degrees). The angle is a positive value.

The following diagrams exemplify the measurement technique.

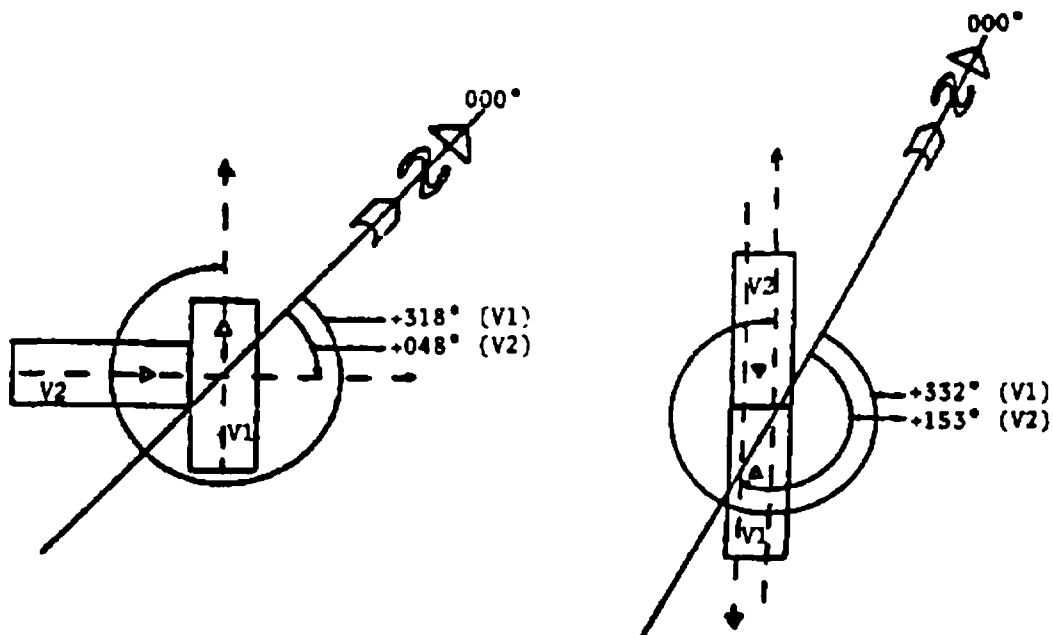

Variable Name: Heading Angle for This Vehicle (cont'd.)
Heading Angle for Other Vehicle (cont'd.)

A value is recorded for all applicable vehicle-to-vehicle collisions regardless of the diagram level. Level I diagrams approximate vehicle orientations at impact (see discussion in Introductory--section 4.5).

- Code "997" (Noncollision) is used for both variables when the Highest Delta V for this vehicle involves a noncollision event. See object contacted codes "31" through "39" for variable AC16 et al., Vehicle Number or Object Contacted, for identification of noncollision events (e.g., rollover).
- Code "998" (Impact with object) is used for both variables when a collision with an object (EV05, Object Contacted, equals "41"-"69" or "72"-"98") results in this vehicle's highest delta V.
- Code "999" (Unknown) is used only for vehicle-to-vehicle collisions and for both variables when either vehicle's impact position cannot be approximated on the scene diagram.

RECONSTRUCTION PROGRAMS OVERVIEW

Two algorithms are available for reconstruction in CDS NASS. Code GV29, Basis for Total Delta V (Highest), and the results GV30-GV33 (... Delta V) whenever a reconstruction program is applicable. Reconstruct and encode the highest delta V. If there is a question as to which impact had the higher delta V, run a reconstruction program on all impacts and use the output to rank their severity. For additional information on each reconstruction program, refer to its particular reference manual.

CRASHPC

CRASHPC is based on (CRASH3) Calspan's Reconstruction of Accident Speeds on the Highway which is the primary algorithm used in CDS NASS. This program is designed to handle vehicle to vehicle or vehicle to barrier collisions. The CRASH3 program makes basic assumptions during its calculations. Because of these assumptions, the following collisions cannot be run on CRASH3.

- o rollovers
- o yielding fixed objects
When GV23 (Post Collision of Tree or Pole) is coded 2-8, then the pole or tree is considered to have yielded and CRASHPC cannot be used.
- o sideswipes
- o nonhorizontal forces
- o severe override/underide
- o undercarriage damage
- o collisions with trains/large trucks
- o collisions with animals/pedestrians/cyclists
- o insufficient data (vehicle inspection required: see OLDMISS)
- o multiple impacts to the same area.

Damage Algorithm (CRASH3)

The damage algorithm is the most often used portion of CRASH3. This subroutine can be used when scene data are not available to generate a speed change. Because the delta V is based entirely on vehicle deformation, care must be taken to provide accurate information.

Shown below is an example output from a damage only run. The General Information screen must be included. It is obtained during the input by depressing the **SHIFT** key and **PRINT SCREEN** key at the same time. The detailed output printout is obtained by selecting **OUTPUT** from the main menu, **DETAIL** from the output menu, and **PRINTER** from the submenu. Next, select **GRAPHICS** from the main menu, **SHOW DAMAGE** from the submenu, and press **P** on the keyboard.

RECONSTRUCTION PROGRAMS

INPUT	CALCULATE	TRAJECTORY	OUTPUT	GRAPHICS	EXIT
-------	-----------	------------	--------	----------	------

TITLE
PSU 99 CASE 123A EVENT 01

GENERAL INFORMATION

VEHICLE 1	
SIZE	1
WEIGHT	2307.
CDC	10LDAW5
PDOF	-70.00
STIFFNESS	1
CANCEL	ACCEPT

VEHICLE 2	
SIZE	6
WEIGHT	3898.
CDC	12FDEW1
PDOF	.000
STIFFNESS	8
CANCEL	ACCEPT

SUMMARY OF CRASHPC RESULTS (USING SPINOUT)

PSU 99 CASE 123A EVENT 01

SPEED CHANGE (DAMAGE)	VEH #1	TOTAL (MPH)	LONG. (MPH)	LAT. (MPH)	ANG. (DEG)
	VEH #1	25.7	-8.8	24.1	-70.0
	VEH #2	15.2	-15.2	.0	.0

ENERGY DISSIPATED BY DAMAGE VEH#1: 53824.3 FT-LB VEH#2: 29017.4 FT-LB

RECONSTRUCTION PROGRAMS OVERVIEW**SUMMARY OF DAMAGE DATA
VEHICLE # 1**

TYPE-----CATEGORY 1
 WEIGHT----- 2307.0 LBS.
 CDC-----10LDAW5
 L----- 107.0 IN.
 C1----- 2.5 IN.
 C2----- 10.0 IN.
 C3----- 14.5 IN.
 C4----- 26.5 IN.
 C5----- 14.5 IN.
 C6----- 2.5 IN.
 D----- 10.4
 RHO----- 1.00
 ANG----- -70.0 DEG.
 D'----- 14.4 IN.

**(* INDICATES DEFAULT T VALUE)
VEHICLE # 2**

TYPE-----CATEGORY 6
 WEIGHT----- 3898.0 LBS.
 CDC-----12FDEW1
 L----- 74.0 IN.
 C1----- 9.5 IN.
 C2----- 3.0 IN.
 C3----- 5.8 IN.
 C4----- 3.8 IN.
 C5----- 2.0 IN.
 C6----- 1.0 IN.
 D----- .0
 RHO----- 1.00
 ANG----- .0 DEG.
 D'----- -8.7 IN.

Trajectory Algorithm (CRASH3)

In this method the scene data as well as vehicle data are used to estimate delta V. This subroutine calculates either a damage and trajectory estimate in axial [velocity vectors are within ten degrees of parallel (e.g., head-on, rear-end)] collisions or a Conservation of Linear Momentum solution in angular collisions. Because the scene data are calculated separately in the Conservation of Linear Momentum solution, a separate delta V is generated and a comparison with the damage delta V can be made for accuracy.

Reconciliation Of Different Results Between Damage And Trajectory (CRASHPC)

1. The axial collision solution is used when the initial velocity vectors are within ten degrees of parallel. Examples of use in CRASHPC are: head-on collisions, rear-end collisions, vehicles sliding sideways traveling straight into an oncoming vehicle or a stationary barrier, barrier impacts, etc.

The transition between the axial and angular solutions (i.e., a velocity vector change from within ten degrees of parallel to just outside ten degrees of parallel) may sometimes produce abrupt changes in delta V results. Therefore, the researcher should remember when running these cases to examine their results carefully.

The axial collision printout will show impact speed (spinout and damage). These results are not coded. The program produces only one estimate [SPEED CHANGE (DAMAGE)] of delta V, which should be coded, if reasonable.

RECONSTRUCTION PROGRAMS

SUMMARY OF CRASHPC RESULTS (USING SPINOUT)

HEAD-ON OFFSET FRONTAL

IMPACT SPEED (SPINOUT AND DAMAGE)		TOTAL(MPH)	LONG.(MPH)	LAT.(MPH)	
	VEH #1	33.7	33.7	.0	
	VEH #2	23.9	23.9	.0	
SPEED CHANGE (DAMAGE)		TOTAL(MPH)	LONG.(MPH)	LAT.(MPH)	ANG.(DEG)
	VEH #1	21.5	-21.5	.0	.0
	VEH #2	32.8	-32.8	.0	.0

ENERGY DISSIPATED BY DAMAGE VEH#1: 57132.1 FT-LB VEH#2:128718.1 FT-LB

Example A

2. The conservation of linear momentum solution is used for angle collisions (greater than ten degrees from parallel). The execution of the reconstruction program produces two independent estimates of delta V. The two results will seldom be precisely equal. The total, longitudinal, and lateral delta Vs associated with speed change "damage" and "linear momentum and spinout" are each compared. Experience indicates that a satisfactory agreement exists between two estimates when their delta V components differ by no more than 2.5 mph or ten (10) percent, whichever is greater, and the angles are within the same o'clock direction. Be sure, when comparing delta Vs, to compare the V₁ total delta V due to "damage" with the V₁ total delta V due to "linear momentum and spinout". Likewise, make the same comparison for V₁ longitudinal delta V, etc. When the agreement is not satisfactory, the data associated with each option should be reviewed for accuracy.

SUMMARY OF CRASHPC RESULTS (USING SPINOUT)

BT1-EXC

IMPACT SPEED (LINEAR MOMENTUM)		TOTAL(MPH)	LONG.(MPH)	LAT.(MPH)	
	VEH #1	29.6	29.5	2.6	
	VEH #2	5.8	5.8	.0	
SPEED CHANGE (DAMAGE)		TOTAL(MPH)	LONG.(MPH)	LAT.(MPH)	ANG.(DEG)
	VEH #1	12.0	-12.0	-.5	2.5
	VEH #2	17.2	-7.9	15.2	-62.5
(LINEAR MOMENTUM AND SPINOUT)		TOTAL(MPH)	LONG.(MPH)	LAT.(MPH)	ANG.(DEG)
	VEH #1	12.1	-12.1	-.6	2.9
	VEH #2	17.3	-8.1	15.3	-62.1

ENERGY DISSIPATED BY DAMAGE VEH#1: 40856.1 FT-LB VEH#2: 40117.9 FT-LB

Example B

RECONSTRUCTION PROGRAMS

Shown above in **Examples A** and **B** are portions of the detailed output printout from one axial (**Example A**) and one angular (**Example B**) damage and trajectory run. The Total, Longitudinal, and Lateral speed changes of (LINEAR MOMENTUM AND SPINOUT) are each compared to the (DAMAGE) results. In **Example B** a good match is present, so additional reruns would not be made to improve the accuracy. Once the speed changes agree satisfactorily, the results for Total, Longitudinal, and Lateral speed changes are each averaged and the averaged results encoded in variables GV30-GV33 (... Delta V) on the General Vehicle Form. If agreement cannot be reached between the two methods, the case is flagged for special review by the zone center.

RECONSTRUCTION PROGRAMS OVERVIEW**OLDMISS**

When the OLDMISS Program is applicable, the OLDMISS Program Summary form should be completed by the researcher and submitted with the case report.

This program is designed to handle vehicle-to-vehicle impacts when data on one of the vehicle's are missing.

Since the OLDMISS algorithm is based on the CRASH3 program the same basic CRASH3 assumptions must not be violated. Due to violations in the basic CRASH3 assumptions or the collision condition being outside of the scope of OLDMISS, the following collision types are not applicable to OLDMISS.

- o Side-to-side collisions
- o Oblique angle collisions
- o Sideswipe
- o Severe underride/override
- o Nonhorizontal force
- o Undercarriage damage
- o Collisions with vehicles "out of scope" (stiffness, size)
- o Multiple impacts to the same area on the known vehicle
- o Insufficient data

Information required on "unknown vehicle"

1. Size and stiffness category
2. Approximate "D" dimension
3. Curb weight (\pm 200 lbs.)
4. Heading angle at impact (approximate)
5. Area of damage (third character of CDC - "Area of Deformation")

Warnings:

- (1) When using the OLDMISS algorithm for pickups and vans, you must know additional information for a valid run.
 - a. Wheelbase [to determine size and stiffness (side impacts)]
 - b. Curb weight (\pm 200 lbs.)
 - c. Stiffness
 - o Rear impacts: Vehicles must have OEM (original equipment manufacturer) bumpers.
 - o Front impacts: Vehicle cannot have add-on equipment (e.g.: plow, winch, Nerf bars, etc.).
- (2) OLDMISS results that are too high or low are not to be entered on the file.
- (3) Do not confuse the heading angle with the PDOF.
- (4) Check the PDOF result for the unknown vehicle. This PDOF must be a reasonably collinear angle for this collision.

RECONSTRUCTION PROGRAMS

Table Of Weights To Be Used For Known Occupants With Unknown Weight

For known occupants with unknown weights, use the occupant's age or age group in the table below to determine the appropriate weight to add.*

Age	0	1	2	3	4	5	6	7	8	9	10	11	12	13
Male	17	26	30	34	39	43	49	55	61	67	77	82	94	107
Female	16	24	28	33	37	42	47	53	61	66	76	89	100	108
XX														
Age	14	15	16	17	18	19	XXX	20-24	25-34	35-44	45-54	55-64	65-97	
Male	124	133	142	145	155	153	XXX	159	171	176	174	171	164	
Female	117	118	123	129	125	126	XXX	128	134	140	145	144	143	
XX														
Age Group	Child (0-12)				Adolescent (13-17)				Adult (18-97)					
Male	50**				135***				170					
Female	50***				120***				138					

* Sources of Information:

- o National Center for Health Statistics, M. F. Najjar and M. Rowland: Anthropometric Reference Data and Prevalence of Overweight: United States, 1976-1980. *Vital and Health Statistics*. Series 11, Number 238. DHHS Publication Number (PHS)87-1688. Public Health Service. Washington. U.S. Government Printing Office, October 1987. Data are from Tables 3-5, 12-14, and 18 on pages 14-16, 23-25, and 29; data are based on 50th percentile rounded to the nearest pound.

** Based on 6 and 7 year olds rounded to the nearest 5 pounds.

*** Based on 15 year olds rounded to the nearest 5 pounds.

Variable Name: Basis for Total Delta V (highest)

Element Values:

Blank (GV07 = 50-99)

Delta V calculated

- 1 CRASH program - damage only routine
- 2 CRASH program - damage and trajectory routine
- 3 Missing vehicle algorithm

Delta V not calculated

- 4 At least one vehicle (which may be this vehicle) is beyond the scope of an acceptable reconstruction program, regardless of collision conditions.
- 5 All vehicles within scope (CDC applicable) of CRASH program but one of the collision conditions is beyond the scope of the CRASH program or other acceptable reconstruction techniques, regardless of the adequacy of damage data.
- 6 All vehicles and collision conditions are within scope of one of the acceptable reconstruction programs, but there is insufficient data available.

Source: Researcher determined -- inputs include CRASH output (if applicable), vehicle inspection, scene inspection, police report, and photographs.

Remarks:

This variable is used to indicate: (1) which reconstruction program or routine was used to compute this vehicle's highest delta V [results encoded in GV30-GV33 (... Delta V)], or (2) the reason a reconstruction program was not applied to the most severe impact.

Code "1" (CRASH program - damage only routine) means the CRASH output [encoded in GV30-GV33 (... Delta V)] is based upon vehicle damage only.

Code "2" (CRASH program - damage and trajectory routine) means that the CRASH output [encoded in GV30-GV33 (... Delta V)] is based on trajectory evidence documented at the scene, in addition to vehicle damage.

Code "3" (Missing vehicle algorithm) means that in a two vehicle impact only one vehicle is inspected (damage measurements and CDC obtained), and for the other vehicle, the damage measurements (including CDC) are missing; however, enough data are available to use the OLDMISS algorithm.

Code "4" (At least one vehicle ... is beyond the scope) means that one of the vehicles (which may be this vehicle) involved in this vehicle's most severe collision cannot be adequately represented by the parameters in an acceptable reconstruction size/stiffness category (e.g., large truck, motorcycle, bus, etc.). As a general rule in CDS NASS, any vehicle that is not applicable for CDC is not applicable for an acceptable reconstruction program.

Variable Name: Basis for Total Delta V (highest) [cont'd.]

Code "5" (... one of the collision conditions is beyond the scope) means that the involved vehicles fit the vehicle parameters for an acceptable reconstruction program; however, the collision type is beyond the scope of the program (e.g., rollover, sideswipe, etc.).

Code "6" (... insufficient data available.) means that the involved vehicles and the collision type are applicable for an acceptable reconstruction program ("1" through "3" above), but due to insufficient data on one (or both) of the vehicles (or object), an acceptable reconstruction program ("1" through "3" above) cannot be used.

Variable Name: Total Delta V

Element Values:

Range: 00 through 97, 99, Blank

Blank (GV07 = 50-99)

Nearest mph

00 Less than 0.5 mph

97 96.5 mph and above

99 Unknown

Source: Reconstruction program

Remarks:

Code the Total Delta V from the results generated by the reconstruction program for this vehicle's most severe impact. This delta V must be for the same impact coded in Highest Delta V (EV04-EV11, Collision Deformation Classification).

Code "99" (Unknown) is used when the results for the most severe impact are unobtainable. If the CDC associated with the reconstruction program was only entered in Second Highest Delta V (EV12-EV19, Collision Deformation Classification), then enter the Total Delta V as shown in the results on the General Vehicle Form in the space available in the Secondary (noncoded) column.

Variable Name: Longitudinal Component of Delta V

Element Values:

Range: -97 to -01, _00, +01 to +97, _99, Blank

Blank (GV07 = 50-99)

Nearest mph

_00 Greater than -0.5 and less than +0.5 mph

±97 ≥96.5 mph and above

_99 Unknown

Source: Reconstruction program

Remarks:

Code the Longitudinal Component of Delta V from the results generated by the reconstruction program for this vehicle's most severe impact. This delta V must be for the same impact coded in the Highest Delta V (EV04-EV11, Collision Deformation Classification).

A plus (+) or minus (-) sign must be circled when encoding a value from a reconstruction program. Codes " 00" (Greater than -0.5 and less than +0.5 mph) and " 99" (Unknown) do not require a sign to be circled.

Code "99" (Unknown) is used when the results for the most severe impact are unobtainable. If the CDC associated with the reconstruction program was only entered in Second Highest Delta V (EV12-EV19, Collision Deformation Classification), then enter the Longitudinal Component of Delta V as shown in the results on the General Vehicle Form in the space available in the Secondary (noncoded) column.

Variable Name: Lateral Component of Delta V

Element Values:

Range: -97 to -01, _00, +01 to +97, _99, Blank

Blank (GV07 = 50-99)

Nearest mph

_00 Greater than -0.5 and less than +0.5 mph

±97 ≥96.5 mph and above

_99 Unknown

Source: Reconstruction program

Remarks:

Code the Lateral Component of Delta V from the results generated by the reconstruction program for this vehicle's most severe impact. This delta V must be for the same impact coded in Highest Delta V (EV04-EV11, Collision Deformation Classification).

A plus (+) or minus (-) sign must be circled when encoding a value from a reconstruction program. Codes "00" (Greater than -0.5 and less than +0.5 mph) and "99" (Unknown) do not require a sign to be circled.

Code "99" (Unknown) is used when the results for the most severe impact are unobtainable. If the CDC associated with the reconstruction program was only entered in Second Highest Delta V (EV12-EV19, Collision Deformation Classification), then enter the Lateral Component of Delta V as shown in the results on the General Vehicle Form in the space available in the Secondary (noncoded) column.

Variable Name: Energy Absorption

Element Values:

Range: 0000 through 9997, 9999, Blank

Blank (GV07 = 50-99)

Nearest 100 foot-pounds

0000 Less than 50 foot-pounds

9997 999,650 foot-pounds or more

9999 Unknown

Source: Reconstruction program

Remarks:

Code the Energy Absorption from the results generated by the reconstruction program for this vehicle's most severe impact. This amount of energy must be for the same impact coded in Highest Delta V (EV04-EV11, Collision Deformation Classification).

Code "9999" (Unknown) is used when the results for the most severe impact are unobtainable. If the CDC associated with the reconstruction program was only entered in Second Highest Delta V (EV12-EV19, Collision Deformation Classification), then enter the Energy Absorption as shown in the results on the General Vehicle Form in the space available in the Secondary (noncoded) column.

Code "9997" (999,650 foot-pounds or more) if the reconstruction program is used and the amount of energy absorbed equals or exceeds 999,650 ft-lbs.

Variable Name: Confidence in Reconstruction Program Results
(for Highest Delta V)

Element Values:

Blank (GV07 = 50-99)

0 No reconstruction

1 Collision fits model - results appear reasonable

2 Collision fits model - results appear high

3 Collision fits model - results appear low

4 Borderline reconstruction - results appear reasonable

Source: Researcher determined from reconstruction program results, vehicle inspection, scene inspection, and injury data.

Remarks:

Determine the quality of this vehicle's reconstruction program by evaluating the results of the reconstruction program and the data used to create those results for the Highest Delta V (EV04-EV11, Collision Deformation Classification). The vehicle inspection, scene inspection, and the injury information must all be reviewed for this determination.

Code "0" (No reconstruction) is used if no reconstruction program was used to determine the Highest Delta V (EV04-EV11, Collision Deformation Classification).

Code "1" (Collision fits model - results appear reasonable) is used if the results of the reconstruction in comparison to the actual collision are believed to be within an acceptable range for the Highest Delta V (EV04-EV11, Collision Deformation Classification).

Code "2" (Collision fits model - results appear high) is used if the results of the reconstruction in comparison to the actual collision appear to over represent the Highest Delta V (EV04-EV11, Collision Deformation Classification) for this vehicle. For example, vehicle damage is minor (bumper stroke only), and the total delta V is 15 mph.

Code "3" (Collision fits model - results appear low) is used if the results of the reconstruction in comparison to the actual collision appear to under represent the Highest Delta V (EV04-EV11, Collision Deformation Classification) for this vehicle. For example, vehicle damage is severe (25" of distributed frontal crush), injury level is high (AIS-3), and the total delta V is 15 mph.

Code "4" (Borderline reconstruction - results appear reasonable) is used if the results of the reconstruction in comparison to the actual collision are within an acceptable range for the Highest Delta V (EV04- EV11, Collision Deformation Classification) for this vehicle; however, some collision conditions were borderline for reconstruction. Code OLDMISS results as a boderline reconstruction if the results are reasonable.

Use this code for all missing vehicles whose delta V is determined by the OLDMISS program.

Variable Name: Type of Vehicle Inspection

Element Values:

- Blank (GV07 = 50-99)
- 0 No inspection
- 1 Complete inspection
- 2 Partial inspection (specify):

Source: Researcher determined

This variable is designed to allow users to identify cases with complete documentation of required damage data (exterior and interior).

Code "0" (No inspection) is used when neither a complete nor a partial inspection of this vehicle was obtained, irrespective of the reason (e.g., refusal, not required, etc.).

Code "1" (Complete inspection) is used when both the exterior and the interior of the unrepaired vehicle were inspected and all applicable measurements and photographs were obtained.

Code "2" (Partial inspection) is used when any phase of the inspection is not completed. This code includes inspection of partially or entirely repaired vehicles and non-towed CDS applicable vehicles when no Interior Vehicle Forms are required.

Variable Name: Is this an AOPS Vehicle?

Element Values:

Blank (GV07 = 50-99)

0 No

1 Yes

Source: Primary sources are the vehicle make/model, VIN, vehicle inspection; a secondary source is the police report.

Remarks:

This variable allows users to identify vehicles equipped with an automatic occupant protection system (AOPS). Automatic occupant protection systems include air bags or automatic (passive) belts. This variable is coded for all vehicle model years.

Code "0" (No) is used when it is determined that this vehicle is not equipped with an AOPS. In addition, use this code when it is unknown if this vehicle had an AOPS.

Code "1" (Yes) is used when available information indicates that the vehicle is equipped with an AOPS or vehicle inspection reveals the presence of an AOPS.

Note: Refer to Table 4-1 for instructions regarding form requirements for vehicles equipped with AOPS.

OTHER DRUGS OVERVIEW

These variables focus upon "other drugs". For the purpose of these variables the word "drug" is defined in nonmedical terms. A "drug" is any chemical substance, natural or synthetic which, when taken into the human body, can impair the ability of the person to operate a motor vehicle safely. The word "other" in this phrase means all "drugs" except alcohol.

Drug observation/perception testing is a new and growing police field. It originated out of a growing frustration with identification of drug-impaired driving. For law enforcement, the following scenario is very familiar.

A driver is stopped on suspicion of alcohol-impaired driving and performs poorly on standardized field sobriety tests, only to "pass" a breath alcohol test. Is the driver ill, injured, or impaired, perhaps by a drug? And, if drugs are suspected, which drugs? Unfortunately, most law enforcement agencies do not have the resources or expertise to answer such questions. They might be able to obtain a urine or blood sample from the suspect but, unless they can give the laboratory some idea about what substances to look for, the analysis of the sample specimen for drugs can be exhaustive and expensive.

The Drug Evaluation and Classification (DEC) process is a standardized, systematic method of examining a driver suspected of impaired driving or some other alcohol-related and/or other drug-related offense. The process is designed to determine: (1) whether the suspect is impaired; and if so, (2) whether the impairment is other drug-related or medically-related (e.g., illness or injury); and if other drug-related, (3) the broad category (or combination of categories) of drugs likely to have caused the impairment.

The systematic process is based on a variety of observable signs and symptoms that are known to be reliable indicators of drug impairment. Conclusions are not based on any one element of the examination, but instead on the totality of facts that emerge. These facts are obtained from careful observations of the driver.

Trained police officers can perform these examinations in order to obtain compelling evidence establishing that a suspect was impaired at the time of the stop, and that the nature of the impairment was consistent with a particular category or subgroup of drugs. This examination evidence is extremely valuable in providing guidance to the laboratory in narrowing the universe of drugs that are to be tested for, decreasing the cost of the analyses, and increasing the odds that the analyses will produce a positive result.

A trained police officer is called a Drug Recognition Technician (DRT). This is the official title for an officer certified through the NHTSA DEC program. Researchers may also encounter police officers with the title DRE (Experts) or DRS (Specialist). Although DRT is the title that researchers should expect to

OTHER DRUGS OVERVIEW

encounter, the titles are interchangeable, provided that the police officer is certified in accordance with standards established by the International Association of Chiefs of Police (IACP).

It is important to understand several things that the DEC process is not.

- a. It is not a field test procedure. The process is a post-arrest investigative procedure that requires a carefully controlled environment that would be difficult if not impossible to secure at roadside.
- b. The process is not a means of determining what drug(s) the suspect has ingested. The evidence that the evaluation discloses does not permit the unique identification of drugs; rather, it permits the presence of drugs to be narrowed down to certain broad categories. For example, a trained police officer usually can determine if the suspect ingested a narcotic analgesic, but usually will not be able to tell whether it was morphine, demerol, heroin, codeine, or some other narcotic.
- c. The process is not a substitute for a chemical test. The process usually does supply a basis for suspecting that a particular category of drugs will be found in the driver's blood or urine, but it remains highly desirable to collect and analyze that blood or urine to secure the scientific evidence to corroborate the suspicion.

There are seven broad categories of drugs that can be identified through the DEC process. These do not exactly correspond to the classification schemes of drugs typically found in medical texts or pharmaceutical catalogs but, rather, are distinguished from one another on the basis of the observable signs they generate during the various examinations that comprise the DEC process.

The seven categories, with examples of each, follow below.

Narcotic Analgesics: Heroin is probably the most notorious member of this category, but the category also includes many other derivatives of opium, such as morphine, codeine, dilaudid, etc. It also includes many synthetic drugs, such as demerol and methadone.

Central Nervous System (CNS) Depressants: Alcohol is the most prominent member of this category, but the category also includes the various derivatives of barbiturate acid (phenobarbital, secobarbital, etc.); the anti-anxiety tranquilizers (Xanax, Valium, Librium, etc.); the anti-psychotic tranquilizers, such as Thorazine; and, many other drugs.

Central Nervous System (CNS) Stimulants: This category contains cocaine, Ritalin, the various members of the amphetamine family (methamphetamine, amphetamine sulfate, etc.), and many others.

OTHER DRUGS OVERVIEW

Hallucinogens: The drugs in this category cause hallucinations (i.e., perceptions of sights, sounds, odors, etc. that do not correspond to reality). Some naturally-occurring substances (e.g., peyote, psilocybin, morning glory seeds, etc.) belong to the hallucinogens, as well as many man-made drugs (e.g., LSD, MDA, STP, etc.).

Cannabis: This category consists of the various forms of the Cannabis Sativa plant (i.e., marijuana, hashish, hashish oil). The active ingredient in cannabis is delta-9 tetrahydrocannabinol, or THC.

Phencyclidine: This category consists of the drug PCP and its various analogs, or "chemical first cousins". PCP, sometimes called "angel dust", is a powerful anesthetic that does not render the user unconscious in recreational doses.

Inhalants: This is the category of the volatile solvents (model airplane glue, paint, gasoline, etc.); aerosols (propellant gases used in household products such as hairspray); and anesthetic gases (nitrous oxide, ether, etc.). Inhaling fumes of these substances can produce severe intoxication.

Each NASS CDS team must determine for the police jurisdictions in their PSU which ones have, or have access to, officers trained and certified in the drug evaluation and classification process (DEC). For each jurisdiction having certified "DRT"s, determine if their evaluations are recorded on the PAR. If evaluations are available, but they are not always recorded on the PAR, then determine how to obtain access to them. Finally, notify your zone center concerning which jurisdictions have certified DRTs and how you are obtaining their evaluations. This information is needed by the zone center for quality control purposes.

No laboratory, no matter how modern its equipment or competent its staff, can identify all drugs that are currently abused. Add to this the fact that new drugs, both licit and illicit, become available every week, and it soon becomes evident that the capacity for drug abuse always stays ahead of the capacity for chemical drug detection. Even if the laboratory does have the capability of identifying a particular drug, it will require that the drug be present at a specific minimum concentration before it can conclude that a "real" chemical detection has occurred. This is referred to as the detection threshold, and it varies from drug to drug, and from one chemical analytic method to another. Some of the analytic methods used by some laboratories to detect certain drugs do not actually seek to find the drug itself, but look instead for a metabolite of the drug. A metabolite is a chemical breakdown product of the drug.

OTHER DRUGS OVERVIEW

Other Drugs Sorted Alphabetically

DRUG	Synonym (or clarification)	Phonetic Spelling	DEC Process Category	Variable Number
Acetaminophen + Codeine	paracetamol	ah-set'ah-me'no-fen	Narcotic	GV40, GV41
Acetylmethadol	methadyl acetate	ae'e-til-meth'ah-dol	Narcotic	GV40, GV41
Alphaprodine Hydrochloride	alphaprodine	al'fah-pro'den	Narcotic	GV40, GV41
Alprazolam		al-pra'zol am	Depressant	GV42, GV43
Amobarbital	amylorbarbitone, iso- amylethylbarbituric acid	am'o-bar'bi-tal	Depressant	GV42, GV43
Amphetamine		am-fet'ah-min	Stimulant	GV44, GV45
Amphetamine Sulfate		am-fet'ah-min	Stimulant	GV44, GV45
Amphetamine Variants	a. phosphate	am-fet'ah-min	Hallucinogen	GV46, GV47
Anileridine	a. hydrochloride	an'i-ler'i-den	Narcotic	GV40, GV41
APC + Codeine	acetylsalicylic acid-ASA (aspirin), phenacetin, & caffeine	ah-se'til-sal'ah-sil'ik fe-nas'e-tin kah-fein'	Narcotic	GV40, GV41
Aspirin + Codeine	acetylsalicylic acid-ASA	ah-se'til-sal'ah-sil'ik	Narcotic	GV40, GV41
Barbital		bar'bi-tal	Depressant	GV42, GV43
Barbiturate	barbituric acid (parent)	bar-bich'oorit	Depressant	GV42, GV43
Benzodiazepines		ben'zo-di-az'e-pe'n	Depressant	GV42, GV43
Benzoylcegonine	benzoyl compound	ben'zo-il	Stimulant	GV44, GV45
Benzphetamine Hydrochloride	benzphetamine	benz-fet'ah-men	Stimulant	GV44, GV45
Bufotenine		bu-fote'nin	Hallucinogen	GV46, GV47
Butobarbital Sodium	butobarbital, barbituric acid (derivative)	bu-tah-bar'bi-tal	Depressant	GV42, GV43
Carbamate	carbamic acid (parent)	kar'bah-mat	Depressant	GV42, GV43
Chloral Hydrate	chloral	klor'al hi'drat	Depressant	GV42, GV43
Chlordiazepoxide Hydrochloride	a benzodiazepine		Depressant	GV42, GV43
Clorazepate Dipotassium	a benzodiazepine	klor-az'e-pat di'po-tas'e-um	Depressant	GV42, GV43
Cocaine	cocaine hydrochloride	ko'kan	Stimulant	GV44, GV45
Codeine	methylmorphine	ko'den	Narcotic	GV40, GV41
Delta-9-Tetrahydrocannabinol	THC, Delta 9		Cannabinoid	GV48, GV49
Dextroamphetamine	d. phosphate, d. sulfate	dek'stro-am-fet'ah-men	Stimulant	GV44, GV45
Diacetylmorphine	heroin, acetomorphine, dimorphine	di'ah-se'til-mor'fen	Narcotic	GV40, GV41
Diazepam	a benzodiazepine	di-az'e-pam	Depressant	GV42, GV43
Diethylpropion Hydrochloride	diethylpropion	di-eth'il-pro'pe-on	Stimulant	GV44, GV45
Dihydrocodeine	drocode	di-hi'dro-ko'den	Narcotic	GV40, GV41
Ethchlorvynol		eth-klor'vi-nol	Depressant	GV42, GV43
Ethylmorphine Hydrochloride	ethylmorphine	eth'il-mor'fen	Narcotic	GV40, GV41
Etorphine		Not listed in PDR/Dorland's	Narcotic	GV40, GV41
Fenethylline Hydrochloride	fenethylline	fen-eth'i-lin	Stimulant	GV44, GV45
Fentanyl Citrate	fentanyl, piperidine (derivative)	fen'tah-nil sit'rat	Narcotic	GV40, GV41
Fiorinal + Codeine	butalbital, aspirin, & caffeine	fe-o'ri-nol bu-tal'bi-tal	Narcotic	GV40, GV41
Flurazepam Hydrochloride	a benzodiazepine	floo-az'e-pam	Depressant	GV42, GV43
Glytethimide		Not listed in PDR/Dorland's	Depressant	GV42, GV43
Halazepam		hal-az'e-pam	Depressant	GV42, GV43
Hashish	charas, churus	hash-esh'	Cannabinoid	GV48, GV49
Hashish Oil		hash-esh'	Cannabinoid	GV48, GV49
Heroin	diacetylmorphine	her'o-in	Narcotic	GV40, GV41
Hexobarbital	h. sodium	hek'so-bar'bi-tal	Depressant	GV42, GV43
Hydrocodone Bitartrate	dihydrocodeinone b.	hi'dro-ko'don	Narcotic	GV40, GV41
Hydromorphone	h. hydrochloride, dihydromorphanone h.	hi'dro-mor'fon	Narcotic	GV40, GV41
Hydroxyzine	h. hydrochloride, h. pamoate	hi-drok'si-zen	Depressant	GV42, GV43
l-bogaine		i-bo'gah-en	Hallucinogen	GV46, GV47

OTHER DRUGS OVERVIEW

Other Drugs Sorted Alphabetically (Cont'd.)

DRUG	Synonym (or clarification)	Phonetic Spelling	DEC Process Category	Variable Number
Levorphanol Tartrate		le-vor'fah-nol tahr'trat	Narcotic	GV40, GV41
Lorazepam		lor-ah'zei-pam	Depressant	GV42, GV43
Lysergic Acid Diethylamide	LSD, lysergide	li-sur'jik di'eth-il-am'in	Hallucinogen	GV46, GV47
Lysergic Acid-25		li-sur'jik	Hallucinogen	GV46, GV47
Marijuana	marihuana	mar'ii-hwah'nah	Cannabinoid	GV48, GV49
Marinol	dronabinol, THC		Cannabinoid	GV48, GV49
Mazindol		ma'zin-dol	Stimulant	GV44, GV45
Meperidine Hydrochloride	meperidine, isonipecaine, pethidine hydrochloride	me-per'i-den	Narcotic	GV40, GV41
Mephobarbital		me'fo-bar'bi-tal	Depressant	GV42, GV43
Meprobanate		me-pro'bah-mat	Depressant	GV42, GV43
Mescaline		mes'kah-lin	Hallucinogen	GV46, GV47
Methadone Hydrochloride	methadone	meth'ah-don	Narcotic	GV40, GV41
Methamphetamine	m. hydrochloride	meth'am-fe'ah-me'n	Stimulant	GV44, GV45
Methaprylon		Not listed in PDR/Dorland's	Depressant	GV42, GV43
Methaqualone	m. hydrochloride	me-thah'kwah-lon	Depressant	GV42, GV43
Metharbital		me-thar'bi-tal	Depressant	GV42, GV43
Methylphenidate Hydrochloride	methylphenidate	meth'il-fe'ni-dat	Stimulant	GV44, GV45
Morphine	dimethyl m., m. hydro- chloride, m. sulfate	mor'fen	Narcotic	GV40, GV41
Nalorphine	n. hydrochloride, allorphine, antorphine	nal'or-fen	Narcotic	GV40, GV41
Opium	anhydrous morphine	o'pe-un	Narcotic	GV40, GV41
Oxazepam	a benzodiazepine	oks-az'e-pam	Depressant	GV42, GV43
Oxycodone Hydrochloride	oxycodone	ok'se-ko'don	Narcotic	GV40, GV41
Oxymorphone Hydrochloride	oxymorphone	ok'se-mor'fon	Narcotic	GV40, GV41
Paregoric	opium (parent)	par'te-gor'ik	Narcotic	GV40, GV41
Parepectolin	paregoric (equivalent)		Narcotic	GV40, GV41
Pemoline		pe'mo-len	Stimulant	GV44, GV45
Pentazocine	p. hydrochloride, p. lactate	pen-taz'o-sen	Narcotic	GV40, GV41
Pentobarbital	p. sodium, pentobarbitone	pen'to-bar'bi-tal	Depressant	GV42, GV43
Pethidine Hydrochloride	meperidine hydrochloride	peth'i-din	Narcotic	GV40, GV41
Peyote	peyotl	pa-d'te pa-d't'l	Hallucinogen	GV46, GV47
Phencyclidine Analogues	PCP	fen-si'kli-den	Phencyclidine	GV50, GV51
Phencyclidine Hydrochloride	PCP	fen-si'kli-den	Phencyclidine	GV50, GV51
Phendimetrazine Tartrate	phendimetrazine (generic)		Stimulant	GV44, GV45
Phenmetrazine Hydrochloride	phenmetrazine	fen-met'rah-ze'n	Stimulant	GV44, GV45
Phenobarbital	p. sodium, phenobarbitone, phenylethylbarbituric acid	fe'no-bar'bi-tal	Depressant	GV42, GV43
Phentermine	p. hydrochloride	fen'ter-me'n	Stimulant	GV44, GV45
Prazepam	a benzodiazepine derivative	prah'ze-pam	Depressant	GV42, GV43
Propoxyphene	p. hydrochloride, p. napsylate	pro-pok'se-fen	Narcotic	GV40, GV41
Psilocybin		si'lo-si'bin	Hallucinogen	GV46, GV47
Psilocyn		Not listed in PDR/Dorland's	Hallucinogen	GV46, GV47
Secobarbital	s. sodium, quinalbarbitone	se'ko-bar'bi-tal	Depressant	GV42, GV43
Talbutal		tal'bu-tal	Depressant	GV42, GV43
Temazepam		te-maz'e-pam	Depressant	GV42, GV43
Tetrahydrocannabinol	THC	tet'rah-hi'dro-kah-nab'i-nol	Cannabinoid	GV48, GV49
Triazolam		tri-a'zol am	Depressant	GV42, GV43
Tybamate		ti'bah-mat	Depressant	GV42, GV43

OTHER DRUGS OVERVIEW

Other Drugs Sorted by General Vehicle Form Variable Numbers

D R U G	Synonym (or clarification)	Phonetic Spelling	DEC Process Category	Variable Number
Acetaminophen + Codeine	paracetamol	ah-set"ah-me'no-fen	Narcotic	GV40, GV41
Acetylmethadol	methadyl acetate	as"e-til-meth'ah-dol	Narcotic	GV40, GV41
Alphaprodine Hydrochloride	alphaprodine	al"feh-pro'den	Narcotic	GV40, GV41
Anileridine	a. hydrochloride	an"i-ler'i-den	Narcotic	GV40, GV41
APC + Codeine	acetylsalicylic acid-ASA (aspirin), phenacetin, & caffeine	ah-se'til-sal"ah-sil"ik fe-nas'e-tin kah-fen'	Narcotic	GV40, GV41
Aspirin + Codeine	acetylsalicylic acid-ASA	ah-se'til-sal"ah-sil"ik	Narcotic	GV40, GV41
Codeine	methylmorphine	ko'den	Narcotic	GV40, GV41
Diacetylmorphine	heroin, acetomorphine, dimorphine	di"ah-se"til-mor'fen	Narcotic	GV40, GV41
Dihydrocodeine	drocode	di-hi"dro-ko'den	Narcotic	GV40, GV41
Ethylmorphine Hydrochloride	ethylmorphine	eth"il-mor'fen	Narcotic	GV40, GV41
Etorphine		Not listed in PDR/Dorland's	Narcotic	GV40, GV41
Fentanyl Citrate	fentanyl, piperidine (derivative)	fen'tah-nil sit'rat	Narcotic	GV40, GV41
Fiorinal + Codeine	butalbital, aspirin, & caffeine	fe-o'ri-nol bu-tal'bi-tal	Narcotic	GV40, GV41
Heroin	diacetylmorphine	her'o-in	Narcotic	GV40, GV41
Hydrocodone Bitartrate	dihydrocodeinone b.	hi"dro-ko'don	Narcotic	GV40, GV41
Hydromorphone	h. hydrochloride, dihydromorphinone h.	hi"dro-mor'fon	Narcotic	GV40, GV41
Levorphanol Tartrate		le-vor'fah-nol tahr'trat	Narcotic	GV40, GV41
Meperidine Hydrochloride	meperidine, isonipecaine, pethidine hydrochloride	me-per'i-den	Narcotic	GV40, GV41
Methadone Hydrochloride	methadone	meth'ah-don	Narcotic	GV40, GV41
Morphine	dimethyl m., m. hydro- chloride, m. sulfate	mor'fen	Narcotic	GV40, GV41
Nalorphine	n. hydrochloride, allorphine, antorphine	nal'or-fen	Narcotic	GV40, GV41
Opium	anhydrous morphine	o'pe-um	Narcotic	GV40, GV41
Oxycodone Hydrochloride	oxycodone	ok"se-ko'don	Narcotic	GV40, GV41
Oxymorphone Hydrochloride	oxymorphone	ok"se-mor'fon	Narcotic	GV40, GV41
Paregoric	opium (parent)	par"e-gor'ik	Narcotic	GV40, GV41
Panepectolin	paregoric (equivalent)		Narcotic	GV40, GV41
Pentazocine	p. hydrochloride, p. lactate	pen-taz'o-sen	Narcotic	GV40, GV41
Pethidine Hydrochloride	meperidine hydrochloride	peth'i-din	Narcotic	GV40, GV41
Propoxyphene	p. hydrochloride, p. napsylate	pro-pok'se-fen	Narcotic	GV40, GV41
Alprazolam		al-praz'ol am	Depressant	GV42, GV43
Amobarbital	amylbarbitone, iso- amylethylbarbituric acid	am'o-bar'bi-tal	Depressant	GV42, GV43
Barbital		bar'bi-tal	Depressant	GV42, GV43
Barbiturate	barbituric acid (parent)	bar-bich'oorit	Depressant	GV42, GV43
Benzodiazepines		ben'tzo-di-az'e-pen	Depressant	GV42, GV43
Butobarbital Sodium	butabarbital, barbituric acid (derivative)	bu-tah-bar'bi-tal	Depressant	GV42, GV43
Carbamate	carbamic acid (parent)	kar'bah-mat	Depressant	GV42, GV43
Chloral Hydrate	chloral	klor'al hi'drat	Depressant	GV42, GV43
Clordiazepoxide Hydrochloride	a benzodiazepine		Depressant	GV42, GV43
Clorazepate Dipotassium	a benzodiazepine	klor-az'e-pat di"po-tas'e-um	Depressant	GV42, GV43
Diazepam	a benzodiazepine	di-az'e-pam	Depressant	GV42, GV43
Ethchlorvynol		eth-klor'vi-nol	Depressant	GV42, GV43
Flurazepam Hydrochloride	a benzodiazepine	floo-az'e-pam	Depressant	GV42, GV43
Glytethimide		Not listed in PDR/Dorland's	Depressant	GV42, GV43

OTHER DRUGS OVERVIEW

Other Drugs Sorted by General Vehicle Form Variable Numbers (Cont'd.)

D R U G	Synonym (or clarification)	Phonetic Spelling	DEC Process Category	Variable Number
Halazepam		hal-az'e-pam	Depressant	GV42, GV43
Hexobarbital	h. sodium	hek"so-bar'bi-tal	Depressant	GV42, GV43
Hydroxyzine	h. hydrochloride, h. pamoate	hi-drok'si-zen	Depressant	GV42, GV43
Lorazepam		lor-ah'ze-pam	Depressant	GV42, GV43
Mephobarbital		mef"no-bar'bi-tal	Depressant	GV42, GV43
Meproamate		me-pro'bah-mat	Depressant	GV42, GV43
Methaprylon		Not listed in PDR/Dorland's	Depressant	GV42, GV43
Methaqualone	m. hydrochloride	me-thah'kwah-lon	Depressant	GV42, GV43
Metharbital		me-thar'bi-tal	Depressant	GV42, GV43
Oxazepam	a benzodiazepine	oks-az'e-pam	Depressant	GV42, GV43
Pentobarbital	p. sodium, pentobarbitone	per"to-bar'bi-tal	Depressant	GV42, GV43
Phenobarbital	p. sodium, phenobarbitone, phenylethylbarbituric acid	fe"no-bar'bi-tal	Depressant	GV42, GV43
Prazepam	a benzodiazepine derivative	prah'ze-pam	Depressant	GV42, GV43
Secobarbital	s. sodium, quinalbarbitone	se"ko-bar'bi-tal	Depressant	GV42, GV43
Talbutal		tal'bu-tal	Depressant	GV42, GV43
Temazepam		te-maz'e-pam	Depressant	GV42, GV43
Triazolam		tri-azol'am	Depressant	GV42, GV43
Tybamate		ti'bah-mat	Depressant	GV42, GV43
Amphetamine		am-fe'tah-min	Stimulant	GV44, GV45
Amphetamine Sulfate		am-fe'tah-min	Stimulant	GV44, GV45
Benzoylcegonine	benzoyl compound	ber'zo-il	Stimulant	GV44, GV45
Benzphetamine Hydrochloride	benzphetamine	benz-fe'tah-men	Stimulant	GV44, GV45
Cocaine	cocaine hydrochloride	ko'kan	Stimulant	GV44, GV45
Dextroamphetamine	d. phosphate, d. sulfate	dek"stro-am-fe'tah-men	Stimulant	GV44, GV45
Diethylpropion Hydrochloride	diethylpropion	di-eth'il-pro'pe-on	Stimulant	GV44, GV45
Fenethylamine Hydrochloride	fenethylamine	fen-eth'i-lin	Stimulant	GV44, GV45
Mazindol		ma'zin-dol	Stimulant	GV44, GV45
Methamphetamine	m. hydrochloride	meth'am-fe'tah-men	Stimulant	GV44, GV45
Methylphenidate Hydrochloride	methylphenidate	meth"il-fe'ri-dat	Stimulant	GV44, GV45
Pemoline		per'lo-len	Stimulant	GV44, GV45
Phendimetrazine Tartrate	phendimetrazine (generic)		Stimulant	GV44, GV45
Phenmetrazine Hydrochloride	phenmetrazine	fen-met'rah-zen	Stimulant	GV44, GV45
Phentermine	p. hydrochloride	fer'ter-men	Stimulant	GV44, GV45
Amphetamine Variants	a. phosphate	am-fe'tah-min	Hallucinogen	GV46, GV47
Bufotenine		bu-fote'nin	Hallucinogen	GV46, GV47
Ibogaine		i-bo'gah-en	Hallucinogen	GV46, GV47
Lysergic Acid Diethylamide	LSD, lysergide	li-sur'jik di"eth-il-am'in	Hallucinogen	GV46, GV47
Lysergic Acid-25		li-sur'jik	Hallucinogen	GV46, GV47
Mescaline		mes'kah-lin	Hallucinogen	GV46, GV47
Peyote	peyotl	pa'ote pa-d't'l	Hallucinogen	GV46, GV47
Psilocybin		si"lo-si'bin	Hallucinogen	GV46, GV47
Psilocyn		Not listed in PDR/Dorland's	Hallucinogen	GV46, GV47
Delta-9-Tetrahydrocannabinol	THC, Delta 9		Cannabinoid	GV48, GV49
Hashish	charas, churus	hash-e'sh'	Cannabinoid	GV48, GV49
Hashish Oil		hash-e'sh'	Cannabinoid	GV48, GV49
Marijuana	marihuana	mar"i-hwah'nah	Cannabinoid	GV48, GV49
Marinol	dronabinol, THC		Cannabinoid	GV48, GV49
Tetrahydrocannabinol	THC	tet"rah-hi"dro-kah-nab'i-nol	Cannabinoid	GV48, GV49
Phencyclidine Analogues	PCP	fen-si'kli-den	Phencyclidine	GV50, GV51
Phencyclidine Hydrochloride	PCP	fen-si'kli-de'n	Phencyclidine	GV50, GV51

Variable Name: Police Reported Other Drug Presence

Element Values:

- 0 No other drugs present
- 1 Yes (other drug present)
- 7 Not reported
- 8 No driver present
- 9 Unknown

Source: Police report.

Remarks:

The phrase "other drug present" includes prescription and "over-the-counter" medications as well as "illicit" substances (e.g., in most cases, marijuana, cocaine, heroin, etc. where usage has not been prescribed by a doctor). Also, "other drug present" means that the driver had ingested an other drug prior to the accident, but it is not an indication that the drug usage was in any way the cause of the accident (or event), even though it may have been. Finding other drugs in the vehicle does not by itself constitute presence.

Code "0" (No other drugs present) is used if the investigating officer's assessment (as reported on the police report) is that no other drugs were present in the driver.

Code "1" [Yes (other drug present)] is used if the police indicate an other drug presence in the driver via: (1) a specific data element on the PAR, or (2) the police mention in the narrative section of the report that the driver had ingested an other drug.

Code "7" (Not reported) is used if there is a specific location on the police report for assessment of other drug presence but the investigating officer fails to make either a positive or negative assessment.

Code "8" (No driver present) is used when an in-transport vehicle was involved in the accident but no driver was in the vehicle at the time.

Code "9" (Unknown) is used if other drug presence is indicated as unknown. A growing number of police reports have blocks to check either positive or negative other drug presence. However, if a police report has provision for the investigating officer to respond "unknown presence", then use this code. In addition, use this code for hit-and-run drivers unless clear evidence to the contrary exists.

Some PARs have a block labeled "Alcohol/Drugs". If "presence" is indicated, and it cannot be determined which was used (e.g., narrative, arrest/charged section, etc.), then assume alcohol presence. If the police report indicates that a driver was charged with DWI (driving while intoxicated or driving while impaired) and no clarification is offered to indicate if the DWI was alcohol related or other drug related (i.e., a specific data element; mentioned in the narrative section; BAC results), then assume alcohol presence.

Variable Name: Police Reported Observation/Perception Test Type
for Driver

Element Values:

- 0 No observation/perception test given
- 1 Drug recognition technical (DRT) determination
- 2 Behavioral
- 3 Other physical observation/perception determination (specify)
- 7 Other observation/perception test
- 8 No driver present
- 9 Unknown if observation/perception test given

Source: Police report.

Remarks:

Code "0" (No observation/perception test given) is used whenever a "no" (code "0") is coded in GV37, Police Reported Other Drug Presence, and the PAR makes no mention that an observation/perception test for other drugs was given to the driver. In other words, if the presence of other drugs is not suspected (e.g., "normal" is coded in a driver appearance/behavior block), then assume that no observation/perception test for other drugs was given to the driver unless there is evidence on the PAR to the contrary.

Also, if the PAR does not have a block for coding the presence of other drugs, then use this code unless the narrative indicates that other drugs were present. In addition, use this code if GV37 is coded "9" (Unknown).

Code "1" [Drug recognition technical (DRT) determination] is used whenever a "yes" or "no" (codes "1" or "0") is coded in GV37, Police Reported Other Drug Presence, and the PAR indicates that an observation/perception test for other drugs was given to the driver by a certified DRT. This code cannot be used if the police jurisdiction completing the PAR does not have, or have access to, a certified DRT.

Code "2" (Behavioral) is used whenever a "yes" or "no" (codes "1" or "0") is coded in GV37, Police Reported Other Drug Presence, and the determination (1) was not made by a certified DRT and (2) was based upon the behavior of the driver. Behavior means that the driver did or said something that the police observed or perceived to indicate the presence of an other drug.

If the police jurisdiction completing the PAR does not have, or have access to, a certified DRT and the police are not using any other observation/perception test (code "7") and GV37 is coded "1" [Yes (other drug present)] and it is unknown how the police reached their conclusion, then assume that their determination was derived by behavior observations or perceptions.

Variable Name: Police Reported Observation/Perception Test Type
for Driver (cont'd.)

Code "3" (Other physical observation/perception determination) is used whenever a "yes" or "no" (codes "1" or "0") is coded in GV37, Police Reported Other Drug Presence, and the determination (1) was not made by a certified DRT and (2) was not based upon the behavior of the driver. For example, this code is used if police reached their conclusion based upon the driver's appearance. Also, the presence of "drug-related paraphernalia" in the driver's possession would satisfy the definition of this code. When uncertainty exists as to the basis of the police determination and their determination was not based upon an observation/perception test, then choose a behavioral basis [code "2" (Behavioral)] rather than this code. See the discussion above.

Code "7" (Other observation/perception test) is used whenever a "yes" or "no" (codes "1" or "0") is coded in GV37, Police Reported Other Drug Presence, and the determination is based upon an observation/perception test other than the Drug Evaluation and Classification (DEC) process (code "1" above). The **Standardized Field Sobriety Tests (SFST)** are not "other tests" within the meaning of this code because they are (1) designed to detect alcohol instead of other drugs and (2) part of the DEC process.

Researchers should determine from their police jurisdictions if there are any other observation/perception tests being used. If a team learns of a "test", then contact your zone center with details of the test. The zone center will contact NCSA and a determination will be made whether this is the appropriate code.

Code "8" (No driver present) is used when an in-transport vehicle was involved in the accident but no driver was in the vehicle at the time.

Code "9" (Unknown if observation/perception test given) is used whenever GV37, Police Reported Other Drug Presence, is coded "7" (Not reported).

Variable Name: Other Drug Specimen Test Type for Driver

Element Values:

- 0 No specimen test given
- 1 Blood test
- 2 Urine test
- 3 Other specimen test (specify)
- 7 Unspecified specimen test
- 8 No driver present
- 9 Unknown if specimen test given

Source: Police report, medical reports, or other official sources.

Remarks:

If a medical, police report, or other official source says that a certain drug was "screened for" or that it was "not detected", then you know that a specimen test was used. In addition, the presence of a measured quantity of an "other drug(s)" means that a specimen test was given. The specimen used in the test that obtained the measurement could be blood, urine, or an other specimen (e.g., nasal swab, saliva). Some drugs are tested using a particular type of specimen; others can be tested in multiple ways. Researchers need to review toxicology (or other official) records carefully to determine which specimen or specimens were used for the driver's evaluation. Specimens are hierarchically ordered with a blood test taking preference over a urine test and urine over other. Thus, if a driver was tested for cocaine by means of a blood test and a nasal swab, then code "1" (Blood test) would be encoded.

Code "0" (No specimen test given) is used whenever there is no indication that any of the driver's specimens were tested for other drugs. Medicals routinely report blood chemistry/gases for patients. Do not confuse these routine medical specimen examinations with a test for other drugs. In addition, use this code for hit-and-run drivers unless clear evidence to the contrary exists.

Code "1" (Blood test) is used whenever the specimen or specimens evaluated for other drugs included the driver's blood.

Code "2" (Urine test) is used whenever the specimen or specimens evaluated for other drugs included the driver's urine and did not include the driver's blood.

Code "3" (Other specimen test) is used whenever the only specimen or specimens evaluated for other drugs were other than blood and urine. Examples of other specimens include, but are not limited to, a nasal swab and saliva.

Code "7" (Unspecified specimen test) is used whenever it is known, or can be implied, that an evaluation for other drugs occurred but it is unknown exactly which specimen or specimens were evaluated.

Variable Name: Other Drug Specimen Test Type for Driver (Cont'd.)

- Code "8" (No driver present) is used when an in-transport vehicle was involved in the accident but no driver was in the vehicle at the time.
- Code "9" (Unknown if specimen test given) is used whenever GV37, Police Reported Other Drug Presence, is coded "1" [Yes (other drug present)] and no records (medical or otherwise) are available to confirm or deny that the police made their evaluation on the basis of a specimen test.

Variable Name: Narcotic Drug: Observation/Perception Test Results

Element Values:

- 0 No observation/perception test given
- 1 Passed observation/perception test
- 2 Failed observation/perception test
- 3 Observation/perception test given - results unknown
- 8 No driver present
- 9 Unknown if observation/perception test given

Source: Police report or other official sources.

Remarks:

Narcotic Analgesics: Heroin is probably the most notorious member of this category, but the category also includes many other derivatives of opium, such as morphine, codeine, dilaudid, etc. It also includes many synthetic drugs, such as demerol and methadone.

Code "0" (No observation/perception test given) is used when GV38, Police Reported Observation/Perception Test Type for Driver, is coded "0" (No observation/perception test given).

Code "1" (Passed observation/perception test) is used if it is known that the driver passed an observation/perception test (i.e., GV38 equals "1") administered by a DRT. The other observation/perception test types (GV38 equal to "2", or "3") are not normally capable of identifying the category of drugs that the driver is suspected of ingesting. If the PAR identifies which other drugs or drug categories that the driver is suspected of ingesting and narcotic drugs are not one of the suspected drugs or drug categories, then you may assume a positive result and use this code.

Do not use the fact that a negative specimen result was obtained for a narcotic drug [i.e., GV41, Narcotic Drug: Specimen Test Results, equals "1" (Drug not found in specimen)] to conclude what the police found. The PAR must at least state that some specific other drug was suspected as a result of their observation/perception test. If researchers conclude from specimen results what the police found in their observation/perception testing, then NHTSA will not be able to test the accuracy of police observation/perception testing.

Code "2" (Failed observation/perception test) is used if it is known that the driver failed an observation/perception test (i.e., GV38 equals "1", "2", "3" or "7") and that a narcotic drug is at least one of the suspected drugs identified as a result of the observation/perception test.

Do not use the fact that a positive specimen result was obtained for a narcotic drug [i.e., GV41, Narcotic Drug: Specimen Test Results, equals "2" (Drug found in specimen)] to conclude what the police found. The PAR must state that a narcotic drug was suspected as a

Variable Name: Narcotic Drug: Observation/Perception Test Results (Cont'd.)

result of their observation/perception test. If researchers conclude from specimen results what the police found in their observation/perception testing, then NHTSA will not be able to test the accuracy of police observation/perception testing.

Code "3" (Observation/perception test given - results unknown) is used if GV38 is coded "2" (Behavioral), "3" (Other physical observation/perception determination), or "7" (Other observation/perception test). This code is also used if it is known that the driver failed an observation/perception test given by a certified DRT (i.e., GV38 equals "1") but the PAR fails to identify which drugs or drug categories the driver was suspected of ingesting.

Code "8" (No driver present) is used when an in-transport vehicle was involved in the accident but no driver was in the vehicle at the time.

Code "9" (Unknown if observation/perception test given) is used when GV38, Police Reported Observation/Perception Test Type for Driver, is coded "9" (Unknown if observation/perception test given).

Variable Name: Narcotic Drug: Specimen Test Results

Element Values:

- 0 No specimen test given
- 1 Drug not found in specimen
- 2 Drug found in specimen
- 8 No driver present
- 9 Unknown if specimen test given

Source: Police report, medical reports, or other official sources.

Remarks:

Narcotic Analgesics: Heroin is probably the most notorious member of this category, but the category also includes many other derivatives of opium, such as morphine, codeine, dilaudid, etc. It also includes many synthetic drugs, such as demerol and methadone.

Code "0" (No specimen test given) is used when GV39, Other Drug Specimen Test Type for Driver, is coded "0" (No specimen test given). In addition, use this code if no narcotic drug is listed among the drugs which were tested.

Code "1" (Drug not found in specimen) is used if it is known that the driver had at least one type of specimen tested (i.e., GV39 equals "1", "2", "3", or "7") for a narcotic drug and the test results came back "negative" or the medical (or other) records had no narcotic drug mentioned among the drugs for whom a positive result was found.

Code "2" (Drug found in specimen) is used if it is known that the driver had at least one type of specimen tested (i.e., GV39 equals "1", "2", "3", or "7") and that the driver had a positive test result for a narcotic drug. A positive test result is any measured quantity that exceeds the detection threshold of the laboratory which performed the test.

Code "8" (No driver present) is used when an in-transport vehicle was involved in the accident but no driver was in the vehicle at the time.

Code "9" (Unknown if specimen test given) is used when GV39, Other Drug Specimen Test Type for Driver, is coded "9" (Unknown if specimen test given). In addition, use this code if positive test results were found for drugs other than narcotics and the medical (or other) records fail to specify whether or not at least one narcotic drug was evaluated.

Variable Name: Depressant Drug: Observation/Perception Test Results

Element Values:

- 0 No observation/perception test given
- 1 Passed observation/perception test
- 2 Failed observation/perception test
- 3 Observation/perception test given - results unknown
- 8 No driver present
- 9 Unknown if observation/perception test given

Source: Police report or other official sources.

Remarks:

Central Nervous System (CNS) Depressants: Alcohol is the most prominent member of this category, but the category also includes the various derivatives of barbiturate acid (phenobarbital, secobarbital, etc.); the anti-anxiety tranquilizers (Xanax, Valium, Librium, etc.); the anti-psychotic tranquilizers, such as Thorazine; and, many other drugs.

Code "0" (No observation/perception test given) is used when GV38, Police Reported Observation/Perception Test Type for Driver, is coded "0" (No observation/perception test given).

Code "1" (Passed observation/perception test) is used if it is known that the driver passed an observation/perception test (i.e., GV38 equals "1") administered by a DRT. The other observation/perception test types (GV38 equal to "2", or "3") are not normally capable of identifying the category of drugs that the driver is suspected of ingesting. If the PAR identifies which other drugs or drug categories that the driver is suspected of ingesting and depressant drugs are not one of the suspected drugs or drug categories, then you may assume a positive result and use this code.

Do not use the fact that a negative specimen result was obtained for a depressant drug [i.e., GV43, Depressant Drug: Specimen Test Results, equals "1" (Drug not found in specimen)] to conclude what the police found. The PAR must at least state that some specific other drug was suspected as a result of their observation/perception test. If researchers conclude from specimen results what the police found in their observation/perception testing, then NHTSA will not be able to test the accuracy of police observation/perception testing.

Code "2" (Failed observation/perception test) is used if it is known that the driver failed an observation/perception test (i.e., GV38 equals "1", "2", "3", or "7") and that a depressant drug is at least one of the suspected drugs identified as a result of the observation/perception test.

Do not use the fact that a positive specimen result was obtained for a depressant drug [i.e., GV43, Depressant Drug: Specimen Test Results, equals "2" (Drug found in specimen)] to conclude what the

Variable Name: Depressant Drug: Observation/Perception Test
Results (Cont'd.)

police found. The PAR must state that a depressant drug was suspected as a result of their observation/perception test. If researchers conclude from specimen results what the police found in their observation/perception testing, then NHTSA will not be able to test the accuracy of police observation/perception testing.

- Code "3" (Observation/perception test given - results unknown) is used if GV38 is coded "2" (Behavioral), "3" (Other physical observation/perception determination), or "7" (Other observation/perception test). This code is also used if it is known that the driver failed an observation/perception test given by a certified DRT (i.e., GV38 equals "1") but the PAR fails to identify which drugs or drug categories the driver was suspected of ingesting.
- Code "8" (No driver present) is used when an in-transport vehicle was involved in the accident but no driver was in the vehicle at the time.
- Code "9" (Unknown if observation/perception test given) is used when GV38, Police Reported Observation/Perception Test Type for Driver, is coded "9" (Unknown if observation/perception test given).

Variable Name: Depressant Drug: Specimen Test Results

Element Values:

- 0 No specimen test given
- 1 Drug not found in specimen
- 2 Drug found in specimen
- 8 No driver present
- 9 Unknown if specimen test given

Source: Police report, medical reports, or other official sources.

Remarks:

Central Nervous System (CNS) Depressants: Alcohol is the most prominent member of this category, but the category also includes the various derivatives of barbiturate acid (phenobarbital, secobarbital, etc.); the anti-anxiety tranquilizers (Xanax, Valium, Librium, etc.); the anti-psychotic tranquilizers, such as Thorazine; and, many other drugs.

Code "0" (No specimen test given) is used when GV39, Other Drug Specimen Test Type for Driver, is coded "0" (No specimen test given). In addition, use this code if no depressant drug is listed among the drugs which were tested.

Code "1" (Drug not found in specimen) is used if it is known that the driver had at least one type of specimen tested (i.e., GV39 equals "1", "2", "3", or "7") for a depressant drug and the test results came back "negative" or the medical (or other) records had no depressant drug mentioned among the drugs for whom a positive result was found.

Code "2" (Drug found in specimen) is used if it is known that the driver had at least one type of specimen tested (i.e., GV39 equals "1", "2", "3", or "7") and that the driver had a positive test result for a depressant drug. A positive test result is any measured quantity that exceeds the detection threshold of the laboratory which performed the test.

Code "8" (No driver present) is used when an in-transport vehicle was involved in the accident but no driver was in the vehicle at the time.

Code "9" (Unknown if specimen test given) is used when GV39, Other Drug Specimen Test Type for Driver, is coded "9" (Unknown if specimen test given). In addition, use this code if positive test results were found for drugs other than depressants and the medical (or other) record fails to specify whether or not at least one depressant drug was evaluated.

Variable Name: Stimulant Drug: Observation/Perception Test Results

Element Values:

- 0 No observation/perception test given
- 1 Passed observation/perception test
- 2 Failed observation/perception test
- 3 Observation/perception test given - results unknown
- 8 No driver present
- 9 Unknown if observation/perception test given

Source: Police report or other official sources.

Remarks:

Central Nervous System (CNS) Stimulants: This category contains cocaine, Ritalin, the various members of the amphetamine family (methamphetamine, amphetamine sulfate, etc.), and many others.

Code "0" (No observation/perception test given) is used when GV38, Police Reported Observation/Perception Test Type for Driver, is coded "0" (No observation/perception test given).

Code "1" (Passed observation/perception test) is used if it is known that the driver passed an observation/perception test (i.e., GV38 equals "1") administered by a DRT. The other observation/perception test types (GV38 equal to "2", or "3") are not normally capable of identifying the category of drugs that the driver is suspected of ingesting. If the PAR identifies which other drugs or drug categories that the driver is suspected of ingesting and stimulant drugs are not one of the suspected drugs or drug categories, then you may assume a positive result and use this code.

Do not use the fact that a negative specimen result was obtained for a stimulant drug [i.e., GV45, Stimulant Drug: Specimen Test Results, equals "1" (Drug not found in specimen)] to conclude what the police found. The PAR must at least state that some specific other drug was suspected as a result of their observation/perception test. If researchers conclude from specimen results what the police found in their observation/perception testing, then NHTSA will not be able to test the accuracy of police observation/perception testing.

Code "2" (Failed observation/perception test) is used if it is known that the driver failed an observation/perception test (i.e., GV38 equals "1", "2", "3", or "7") and that a stimulant drug is at least one of the suspected drugs identified as a result of the observation/perception test.

Do not use the fact that a positive specimen result was obtained for a stimulant drug [i.e., GV45, Stimulant Drug: Specimen Test Results, equals "2" (Drug found in specimen)] to conclude what the police found. The PAR must state that a stimulant drug was suspected as a result of their observation/perception test. If researchers conclude

Variable Name: Stimulant Drug: Observation/Perception Test Results
(Cont'd.)

from specimen results what the police found in their observation/perception testing, then NHTSA will not be able to test the accuracy of police observation/perception testing.

- Code "3" (Observation/perception test given - results unknown) is used if GV38 is coded "2" (Behavioral), "3" (Other physical observation/perception determination), or "7" (Other observation/perception test). This code is also used if it is known that the driver failed an observation/perception test given by a certified DRT (i.e., GV38 equals "1") but the PAR fails to identify which drugs or drug categories the driver was suspected of ingesting.
- Code "8" (No driver present) is used when an in-transport vehicle was involved in the accident but no driver was in the vehicle at the time.
- Code "9" (Unknown if observation/perception test given) is used when GV38, Police Reported Observation/Perception Test Type for Driver, is coded "9" (Unknown if observation/perception test given).

Variable Name: Stimulant Drug: Specimen Test Results

Element Values:

- 0 No specimen test given
- 1 Drug not found in specimen
- 2 Drug found in specimen
- 8 No driver present
- 9 Unknown if specimen test given

Source: Police report, medical reports, or other official sources.

Remarks:

Central Nervous System (CNS) Stimulants: This category contains cocaine, Ritalin, the various members of the amphetamine family (methamphetamine, amphetamine sulfate, etc.), and many others.

Code "0" (No specimen test given) is used when GV39, Other Drug Specimen Test Type for Driver, is coded "0" (No specimen test given). In addition, use this code if no stimulant drug is listed among the drugs which were tested.

Code "1" (Drug not found in specimen) is used if it is known that the driver had at least one type of specimen tested (i.e., GV39 equals "1", "2", "3", or "7") for a stimulant drug and the test results came back "negative" or the medical (or other) records had no stimulant drug mentioned among the drugs for whom a positive result was found.

Code "2" (Drug found in specimen) is used if it is known that the driver had at least one type of specimen tested (i.e., GV39 equals "1", "2", "3", or "7") and that the driver had a positive test result for a stimulant drug. A positive test result is any measured quantity that exceeds the detection threshold of the laboratory which performed the test.

Code "8" (No driver present) is used when an in-transport vehicle was involved in the accident but no driver was in the vehicle at the time.

Code "9" (Unknown if specimen test given) is used when GV39, Other Drug Specimen Test Type for Driver, is coded "9" (Unknown if specimen test given). In addition, use this code if positive test results were found for drugs other than stimulants and the medical (or other) records fail to specify whether or not at least one stimulant drug was evaluated.

Variable Name: Hallucinogen Drug: Observation/Perception Test Results

Element Values:

- 0 No observation/perception test given
- 1 Passed observation/perception test
- 2 Failed observation/perception test
- 3 Observation/perception test given - results unknown
- 8 No driver present
- 9 Unknown if observation/perception test given

Source: Police report or other official sources.

Remarks:

Hallucinogens: The drugs in this category cause hallucinations (i.e., perceptions of sights, sounds, odors, etc. that do not correspond to reality). Some naturally-occurring substances (e.g., peyote, psilocybin, morning glory seeds, etc.) belong to the hallucinogens, as well as many man-made drugs (e.g., LSD, MDA, STP, etc.).

Code "0" (No observation/perception test given) is used when GV38, Police Reported Observation/Perception Test Type for Driver, is coded "0" (No observation/perception test given).

Code "1" (Passed observation/perception test) is used if it is known that the driver passed an observation/perception test (i.e., GV38 equals "1") administered by a DRT. The other observation/perception test types (GV38 equal to "2", or "3") are not normally capable of identifying the category of drugs that the driver is suspected of ingesting. If the PAR identifies which other drugs or drug categories that the driver is suspected of ingesting and hallucinogen drugs are not one of the suspected drugs or drug categories, then you may assume a positive result and use this code.

Do not use the fact that a negative specimen result was obtained for a hallucinogen drug [i.e., GV47, Hallucinogen Drug: Specimen Test Results, equals "1" (Drug not found in specimen)] to conclude what the police found. The PAR must at least state that some specific other drug was suspected as a result of their observation/perception test. If researchers conclude from specimen results what the police found in their observation/perception testing, then NHTSA will not be able to test the accuracy of police observation/perception testing.

Code "2" (Failed observation/perception test) is used if it is known that the driver failed an observation/perception test (i.e., GV38 equals "1", "2", "3", or "7") and that a hallucinogen drug is at least one of the suspected drugs identified as a result of the observation/perception test.

Do not use the fact that a positive specimen result was obtained for a hallucinogen drug [i.e., GV47, Hallucinogen Drug: Specimen Test Results, equals "2" (Drug found in specimen)] to conclude what the

Variable Name: Hallucinogen Drug: Observation/Perception Test
Results (Cont'd.)

police found. The PAR must state that a hallucinogen drug was suspected as a result of their observation/perception test. If researchers conclude from specimen results what the police found in their observation/perception testing, then NHTSA will not be able to test the accuracy of police observation/perception testing.

- Code "3" (Observation/perception test given - results unknown) is used if GV38 is coded "2" (Behavioral), "3" (Other physical observation/perception determination), or "7" (Other observation/perception test). This code is also used if it is known that the driver failed an observation/perception test given by a certified DRT (i.e., GV38 equals "1") but the PAR fails to identify which drugs or drug categories the driver was suspected of ingesting.
- Code "8" (No driver present) is used when an in-transport vehicle was involved in the accident but no driver was in the vehicle at the time.
- Code "9" (Unknown if observation/perception test given) is used when GV38, Police Reported Observation/Perception Test Type for Driver, is coded "9" (Unknown if observation/perception test given).

Variable Name: Hallucinogen Drug: Specimen Test Results

Element Values:

- 0 No specimen test given
- 1 Drug not found in specimen
- 2 Drug found in specimen
- 8 No driver present
- 9 Unknown if specimen test given

Source: Police report, medical reports, or other official sources.

Remarks:

Hallucinogens: The drugs in this category cause hallucinations (i.e., perceptions of sights, sounds, odors, etc. that do not correspond to reality). Some naturally-occurring substances (e.g., peyote, psilocybin, morning glory seeds, etc.) belong to the hallucinogens, as well as many man-made drugs (e.g., LSD, MDA, STP, etc.).

Code "0" (No specimen test given) is used when GV39, Other Drug Specimen Test Type for Driver, is coded "0" (No specimen test given). In addition, use this code if no hallucinogen drug is listed among the drugs which were tested.

Code "1" (Drug not found in specimen) is used if it is known that the driver had at least one type of specimen tested (i.e., GV39 equals "1", "2", "3", or "7") for a hallucinogen drug and the test results came back "negative" or the medical (or other) records had no hallucinogen drug mentioned among the drugs for whom a positive result was found.

Code "2" (Drug found in specimen) is used if it is known that the driver had at least one type of specimen tested (i.e., GV39 equals "1", "2", "3", or "7") and that the driver had a positive test result for a hallucinogen drug. A positive test result is any measured quantity that exceeds the detection threshold of the laboratory which performed the test.

Code "8" (No driver present) is used when an in-transport vehicle was involved in the accident but no driver was in the vehicle at the time.

Code "9" (Unknown if specimen test given) is used when GV39, Other Drug Specimen Test Type for Driver, is coded "9" (Unknown if specimen test given). In addition, use this code if positive test results were found for drugs other than hallucinogens and the medical (or other) records fail to specify whether or not at least one hallucinogen drug was evaluated.

Variable Name: Cannabinoid Drug: Observation/Perception Test Results

Element Values:

- 0 No observation/perception test given
- 1 Passed observation/perception test
- 2 Failed observation/perception test
- 3 Observation/perception test given - results unknown
- 8 No driver present
- 9 Unknown if observation/perception test given

Source: Police report or other official sources.

Remarks:

Cannabis: This category consists of the various forms of the Cannabis Sativa plant (i.e., marijuana, hashish, hashish oil). The active ingredient in cannabis is delta-9 tetrahydrocannabinol, or THC.

Code "0" (No observation/perception test given) is used when GV38, Police Reported Observation/Perception Test Type for Driver, is coded "0" (No observation/perception test given).

Code "1" (Passed observation/perception test) is used if it is known that the driver passed an observation/perception test (i.e., GV38 equals "1") administered by a DRT. The other observation/perception test types (GV38 equal to "2", or "3") are not normally capable of identifying the category of drugs that the driver is suspected of ingesting. If the PAR identifies which other drugs or drug categories that the driver is suspected of ingesting and cannabinoid drugs are not one of the suspected drugs or drug categories, then you may assume a positive result and use this code.

Do not use the fact that a negative specimen result was obtained for a cannabinoid drug [i.e., GV49, Cannabinoid Drug: Specimen Test Results, equals "1" (Drug not found in specimen)] to conclude what the police found. The PAR must at least state that some specific other drug was suspected as a result of their observation/perception test. If researchers conclude from specimen results what the police found in their observation/perception testing, then NHTSA will not be able to test the accuracy of police observation/perception testing.

Code "2" (Failed observation/perception test) is used if it is known that the driver failed an observation/perception test (i.e., GV38 equals "1", "2", "3", or "7") and that a cannabinoid drug is at least one of the suspected drugs identified as a result of the observation/perception test.

Do not use the fact that a positive specimen result was obtained for a cannabinoid drug [i.e., GV49, Cannabinoid Drug: Specimen Test Results, equals "2" (Drug found in specimen)] to conclude what the police found. The PAR must state that a cannabinoid drug was suspected as a result of their observation/perception test. If

Variable Name: Cannabinoid Drug: Observation/Perception Test
Results (Cont'd.)

researchers conclude from specimen results what the police found in their observation/perception testing, then NHTSA will not be able to test the accuracy of police observation/perception testing.

Code "3" (Observation/perception test given - results unknown) is used if GV38 is coded "2" (Behavioral), "3" (Other physical observation/perception determination), or "7" (Other observation/perception test). This code is also used if it is known that the driver failed an observation/perception test given by a certified DRT (i.e., GV38 equals "1") but the PAR fails to identify which drugs or drug categories the driver was suspected of ingesting.

Code "8" (No driver present) is used when an in-transport vehicle was involved in the accident but no driver was in the vehicle at the time.

Code "9" (Unknown if observation/perception test given) is used when GV38, Police Reported Observation/Perception Test Type for Driver, is coded "9" (Unknown if observation/perception test given).

Variable Name: Cannabinoid Drug: Specimen Test Results

Element Values:

- 0 No specimen test given
- 1 Drug not found in specimen
- 2 Drug found in specimen
- 8 No driver present
- 9 Unknown if specimen test given

Source: Police report, medical reports, or other official sources.

Remarks:

Cannabis: This category consists of the various forms of the Cannabis Sativa plant (i.e., marijuana, hashish, hashish oil). The active ingredient in cannabis is delta-9 tetrahydrocannabinol, or THC.

Code "0" (No specimen test given) is used when GV39, Other Drug Specimen Test Type for Driver, is coded "0" (No specimen test given). In addition, use this code if no cannabinoid drug is listed among the drugs which were tested.

Code "1" (Drug not found in specimen) is used if it is known that the driver had at least one type of specimen tested (i.e., GV39 equals "1", "2", "3", or "7") for a cannabinoid drug and the test results came back "negative" or the medical (or other) records had no cannabinoid drug mentioned among the drugs for whom a positive result was found.

Code "2" (Drug found in specimen) is used if it is known that the driver had at least one type of specimen tested (i.e., GV39 equals "1", "2", "3", or "7") and that the driver had a positive test result for a cannabinoid drug. A positive test result is any measured quantity that exceeds the detection threshold of the laboratory which performed the test.

Code "8" (No driver present) is used when an in-transport vehicle was involved in the accident but no driver was in the vehicle at the time.

Code "9" (Unknown if specimen test given) is used when GV39, Other Drug Specimen Test Type for Driver, is coded "9" (Unknown if specimen test given). In addition, use this code if positive test results were found for drugs other than cannabinoids and the medical (or other) records fail to specify whether or not at least one cannabinoid drug was evaluated.

Variable Name: Phencyclidine (PCP) Drug: Observation/Perception Test Results

Element Values:

- 0 No observation/perception test given
- 1 Passed observation/perception test
- 2 Failed observation/perception test
- 3 Observation/perception test given - results unknown
- 8 No driver present
- 9 Unknown if observation/perception test given

Source: Police report or other official sources.

Remarks:

Phencyclidine: This category consists of the drug PCP and its various analogs, or "chemical first cousins". PCP, sometimes called "angel dust", is a powerful anesthetic that does not render the user unconscious in recreational doses.

Code "0" (No observation/perception test given) is used when GV38, Police Reported Observation/Perception Test Type for Driver, is coded "0" (No observation/perception test given).

Code "1" (Passed observation/perception test) is used if it is known that the driver passed an observation/perception test (i.e., GV38 equals "1") administered by a DRT. The other observation/perception test types (GV38 equal to "2", or "3") are not normally capable of identifying the category of drugs that the driver is suspected of ingesting. If the PAR identifies which other drugs or drug categories that the driver is suspected of ingesting and phencyclidine drugs are not one of the suspected drugs or drug categories, then you may assume a positive result and use this code.

Do not use the fact that a negative specimen result was obtained for a phencyclidine drug [i.e., GV51, Phencyclidine (PCP) Drug: Specimen Test Results, equals "1" (Drug not found in specimen)] to conclude what the police found. The PAR must at least state that some specific other drug was suspected as a result of their observation/perception test. If researchers conclude from specimen results what the police found in their observation/perception testing, then NHTSA will not be able to test the accuracy of police observation/perception testing.

Code "2" (Failed observation/perception test) is used if it is known that the driver failed an observation/perception test (i.e., GV38 equals "1", "2", "3", or "7") and that a phencyclidine drug is at least one of the suspected drugs identified as a result of the observation/perception test.

Do not use the fact that a positive specimen result was obtained for a phencyclidine drug [i.e., GV51, Phencyclidine (PCP) Drug: Specimen

Variable Name: Phencyclidine (PCP) Drug: Observation/Perception Test Results (Cont'd.)

Test Results, equals "2" (Drug found in specimen)] to conclude what the police found. The PAR must state that a phencyclidine drug was suspected as a result of their observation/perception test. If researchers conclude from specimen results what the police found in their observation/perception testing, then NHTSA will not be able to test the accuracy of police observation/perception testing.

Code "3" (Observation/perception test given - results unknown) is used if GV38 is coded "2" (Behavioral), "3" (Other physical observation/perception determination), or "7" (Other observation/perception test). This code is also used if it is known that the driver failed an observation/perception test given by a certified DRT (i.e., GV38 equals "1") but the PAR fails to identify which drugs or drug categories the driver was suspected of ingesting.

Code "8" (No driver present) is used when an in-transport vehicle was involved in the accident but no driver was in the vehicle at the time.

Code "9" (Unknown if observation/perception test given) is used when GV38, Police Reported Observation/Perception Test Type for Driver, is coded "9" (Unknown if observation/perception test given).

Variable Name: Phencyclidine (PCP) Drug: Specimen Test Results

Element Values:

- 0 No specimen test given
- 1 Drug not found in specimen
- 2 Drug found in specimen
- 8 No driver present
- 9 Unknown if specimen test given

Source: Police report, medical reports, or other official sources.

Remarks:

Phencyclidine: This category consists of the drug PCP and its various analogs, or "chemical first cousins". PCP, sometimes called "angel dust", is a powerful anesthetic that does not render the user unconscious in recreational doses.

Code "0" (No specimen test given) is used when GV39, Other Drug Specimen Test Type for Driver, is coded "0" (No specimen test given). In addition, use this code if no phencyclidine drug is listed among the drugs which were tested.

Code "1" (Drug not found in specimen) is used if it is known that the driver had at least one type of specimen tested (i.e., GV39 equals "1", "2", "3", or "7") for a phencyclidine drug and the test results came back "negative" or the medical (or other) records had no phencyclidine drug mentioned among the drugs for whom a positive result was found.

Code "2" (Drug found in specimen) is used if it is known that the driver had at least one type of specimen tested (i.e., GV39 equals "1", "2", "3", or "7") and that the driver had a positive test result for a phencyclidine drug. A positive test result is any measured quantity that exceeds the detection threshold of the laboratory which performed the test.

Code "8" (No driver present) is used when an in-transport vehicle was involved in the accident but no driver was in the vehicle at the time.

Code "9" (Unknown if specimen test given) is used when GV39, Other Drug Specimen Test Type for Driver, is coded "9" (Unknown if specimen test given). In addition, use this code if positive test results were found for drugs other than phencyclidines and the medical (or other) records fail to specify whether or not at least one phencyclidine drug was evaluated.

Variable Name: Inhalant Drug: Observation/Perception Test Results

Element Values:

- 0 No observation/perception test given
- 1 Passed observation/perception test
- 2 Failed observation/perception test
- 3 Observation/perception test given - results unknown
- 8 No driver present
- 9 Unknown if observation/perception test given

Source: Police report or other official sources.

Remarks:

Inhalants: This is the category of the volatile solvents (model airplane glue, paint, gasoline, etc.); aerosols (propellant gases used in household products such as hairspray); and anesthetic gases (nitrous oxide, ether, etc.). Inhaling fumes of these substances can produce severe intoxication.

Code "0" (No observation/perception test given) is used when GV38, Police Reported Observation/Perception Test Type for Driver, is coded "0" (No observation/perception test given).

Code "1" (Passed observation/perception test) is used if it is known that the driver passed an observation/perception test (i.e., GV38 equals "1") administered by a DRT. The other observation/perception test types (GV38 equal to "2", or "3") are not normally capable of identifying the category of drugs that the driver is suspected of ingesting. If the PAR identifies which other drugs or drug categories that the driver is suspected of ingesting and inhalant drugs are not one of the suspected drugs or drug categories, then you may assume a positive result and use this code.

Do not use the fact that a negative specimen result was obtained for an inhalant drug [i.e., GV53, Inhalant Drug: Specimen Test Results, equals "1" (Drug not found in specimen)] to conclude what the police found. The PAR must at least state that some specific other drug was suspected as a result of their observation/perception test. If researchers conclude from specimen results what the police found in their observation/perception testing, then NHTSA will not be able to test the accuracy of police observation/perception testing.

Code "2" (Failed observation/perception test) is used if it is known that the driver failed an observation/perception test (i.e., GV38 equals "1", "2", "3", or "7") and that an inhalant drug is at least one of the suspected drugs identified as a result of the observation/perception test.

Do not use the fact that a positive specimen result was obtained for an inhalant drug [i.e., GV53, Inhalant Drug: Specimen Test Results, equals "2" (Drug found in specimen)] to conclude what the police

**Variable Name: Inhalant Drug: Observation/Perception Test
Results (Cont'd.)**

found. The PAR must state that an inhalant drug was suspected as a result of their observation/perception test. If researchers conclude from specimen results what the police found in their observation/perception testing, then NHTSA will not be able to test the accuracy of police observation/perception testing.

- Code "3" (Observation/perception test given - results unknown) is used if GV38 is coded "2" (Behavioral), "3" (Other physical observation/perception determination), or "7" (Other observation/perception test). This code is also used if it is known that the driver failed an observation/perception test given by a certified DRT (i.e., GV38 equals "1") but the PAR fails to identify which drugs or drug categories the driver was suspected of ingesting.
- Code "8" (No driver present) is used when an in-transport vehicle was involved in the accident but no driver was in the vehicle at the time.
- Code "9" (Unknown if observation/perception test given) is used when GV38, Police Reported Observation/Perception Test Type for Driver, is coded "9" (Unknown if observation/perception test given).

Variable Name: Inhalant Drug: Specimen Test Results

Element Values:

- 0 No specimen test given
- 1 Drug not found in specimen
- 2 Drug found in specimen
- 8 No driver present
- 9 Unknown if specimen test given

Source: Police report, medical reports, or other official sources.

Remarks:

Inhalants: This is the category of the volatile solvents (model airplane glue, paint, gasoline, etc.); aerosols (propellant gases used in household products such as hairspray); and anesthetic gases (nitrous oxide, ether, etc.). Inhaling fumes of these substances can produce severe intoxication.

Code "0" (No specimen test given) is used when GV39, Other Drug Specimen Test Type for Driver, is coded "0" (No specimen test given). In addition, use this code if no inhalant drug is listed among the drugs which were tested.

Code "1" (Drug not found in specimen) is used if it is known that the driver had at least one type of specimen tested (i.e., GV39 equals "1", "2", "3", or "7") for an inhalant drug and the test results came back "negative" or the medical (or other) records had no inhalant drug mentioned among the drugs for whom a positive result was found.

Code "2" (Drug found in specimen) is used if it is known that the driver had at least one type of specimen tested (i.e., GV39 equals "1", "2", "3", or "7") and that the driver had a positive test result for an inhalant drug. A positive test result is any measured quantity that exceeds the detection threshold of the laboratory which performed the test.

Code "8" (No driver present) is used when an in-transport vehicle was involved in the accident but no driver was in the vehicle at the time.

Code "9" (Unknown if specimen test given) is used when GV39, Other Drug Specimen Test Type for Driver, is coded "9" (Unknown if specimen test given). In addition, use this code if positive test results were found for drugs other than inhalants and the medical (or other) records fail to specify whether or not at least one inhalant drug was evaluated.

Variable Name: Other Drug (Excluding Nicotine, Aspirin, Alcohol, Drugs Administered Post-Crash): Observation/Perception Test Results

Element Values:

- 0 No observation/perception test given
- 1 Passed observation/perception test
- 2 Failed observation/perception test
- 3 Observation/perception test given - results unknown
- 8 No driver present
- 9 Unknown if observation/perception test given

Source: Police report or other official sources.

Remarks:

Code "0" (No observation/perception test given) is used when GV38, Police Reported Observation/Perception Test Type for Driver, is coded "0" (No observation/perception test given).

Code "1" (Passed observation/perception test) is not used for this variable.

Code "2" (Failed observation/perception test) is used if it is known that the driver failed an observation/perception test (i.e., GV38 equals "1", "2", "3", or "7") and that an "other" drug is at least one of the suspected drugs identified as a result of the observation/perception test.

Do not use the fact that a positive specimen result was obtained for an "other" drug [i.e., GV55, Other Drug: Specimen Test Results, equals "2" (Drug found in specimen)] to conclude what the police found. The PAR must state that an "other" drug was suspected as a result of their observation/perception test. If researchers conclude from specimen results what the police found in their observation/perception testing, then NHTSA will not be able to test the accuracy of police observation/perception testing.

Code "3" (Observation/perception test given - results unknown) is used if GV38 is coded "2" (Behavioral), "3" (Other physical observation/perception determination), or "7" (Other observation/perception test). This code is also used if it is known that the driver failed an observation/perception test given by a certified DRT (i.e., GV38 equals "1") but the PAR fails to identify which drugs or drug categories the driver was suspected of ingesting.

Code "8" (No driver present) is used when an in-transport vehicle was involved in the accident but no driver was in the vehicle at the time.

Code "9" (Unknown if observation/perception test given) is used when GV38, Police Reported Observation/Perception Test Type for Driver, is coded "9" (Unknown if observation/perception test given).

Variable Name: Other Drug (Excluding Nicotine, Aspirin, Alcohol, Drugs Administered Post-Crash): Specimen Test Results

Element Values:

- 0 No specimen test given
- 1 Drug not found in specimen
- 2 Drug found in specimen
- 8 No driver present
- 9 Unknown if specimen test given

Source: Police report, medical reports, or other official sources.

Remarks:

Code "0" (No specimen test given) is used when GV39, Other Drug Specimen Test Type for Driver, is coded "0" (No specimen test given). In addition, use this code if no "other" drug is listed among the drugs which were tested.

Code "1" (Drug not found in specimen) is used if it is known that the driver had at least one type of specimen tested (i.e., GV39 equals "1", "2", "3", or "7") for an "other" drug and the test results came back "negative" or the medical (or other) records had no "other" drug mentioned among the drugs for whom a positive result was found.

Code "2" (Drug found in specimen) is used if it is known that the driver had at least one type of specimen tested (i.e., GV39 equals "1", "2", "3", or "7") and that the driver had a positive test result for an "other" drug. A positive test result is any measured quantity that exceeds the detection threshold of the laboratory which performed the test.

Code "8" (No driver present) is used when an in-transport vehicle was involved in the accident but no driver was in the vehicle at the time.

Code "9" (Unknown if specimen test given) is used when GV39, Other Drug Specimen Test Type for Driver, is coded "9" (Unknown if specimen test given). In addition, use this code if positive test results were found for drugs in any of the seven categories of interest and the medical (or other) records fail to specify whether or not at least one "other" drug was evaluated.



EXTERIOR VEHICLE FORM

1. Primary Sampling Unit Number _____	3. Vehicle Number _____
2. Case Number – Stratum _____	

VEHICLE IDENTIFICATION

VIN _____ Model Year _____

Vehicle Make (specify): _____ Vehicle Model (specify): _____

LOCATOR

Locate the end of the damage with respect to the vehicle longitudinal center line or bumper corner for end impacts or an undamaged axle for side impacts.

Specific Impact No.	Location of Direct Damage	Location of Field L	Location of Maximum Crush

CRUSH PROFILE

NOTES: Identify the plane at which the C-measurements are taken (e.g., at bumper, above bumper, at sill, above sill, etc.) and label adjustments (e.g., free space).

Measure C1 to C6 from driver to passenger side in front or rear impacts and rear to front in side impacts.

Free space value is defined as the distance between the baseline and the original body contour taken at the individual C locations. This may include the following: bumper lead, bumper taper, side protrusion, side taper, etc. Record the value for each C-measurement and maximum crush.

Use as many lines/columns as necessary to describe each damage profile.

Specific Impact Number	Plane of C-Measurements	Direct Damage		Field L	C ₁	C ₂	C ₃	C ₄	C ₅	C ₆	± D
		Width (CDC)	Max Crush								

VEHICLE DAMAGE SKETCH

TIRE – WHEEL DAMAGE a. Rotation physically restricted _____ b. Tire deflated _____ RF _____ RF _____ LF _____ LF _____ RR _____ RR _____ LR _____ LR _____ (1) Yes (2) No (8) NA (9) Unk.		ORIGINAL SPECIFICATIONS Wheelbase _____ Overall Length _____ Maximum Width _____ Curb Weight _____ Average Track _____ Front Overhang _____ Rear Overhang _____ Engine Size: cyl./ displ. _____ Undeformed End Width _____		WHEEL STEER ANGLES (For locked front wheels or displaced rear axles only) RF ± _____° LF ± _____° RR ± _____° LR ± _____° Within ± 5 degrees	
TYPE OF TRANSMISSION <input type="checkbox"/> Manual <input type="checkbox"/> Automatic				DRIVE WHEELS <input type="checkbox"/> FWD <input type="checkbox"/> RWD <input type="checkbox"/> 4WD	
				Approximate Cargo Weight _____	

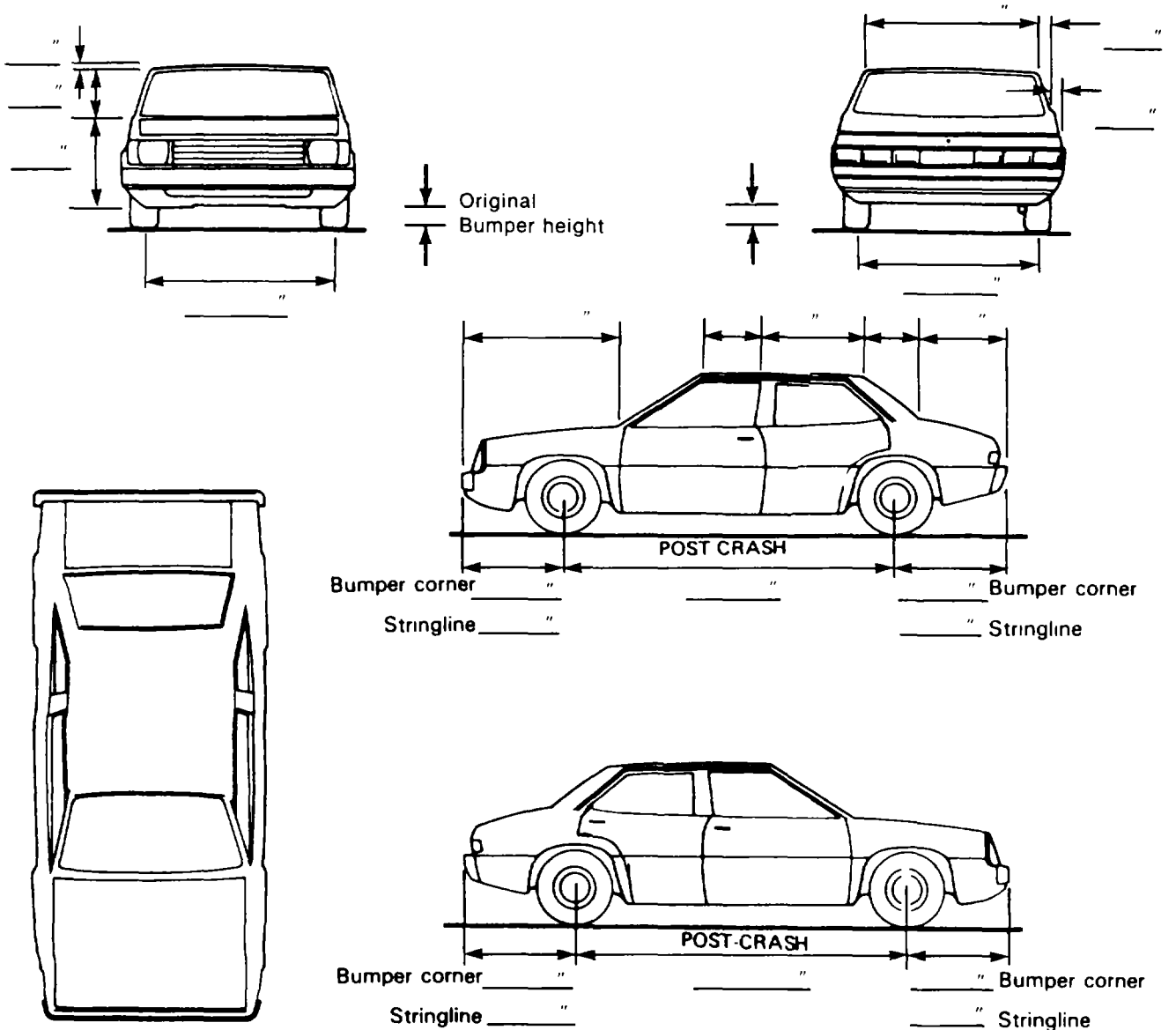

NOTES Sketch new perimeter and cross hatch direct damage and single hatch induced damage on all views. Annotate observations which might be useful in reconstructing the accident (e.g., grass in tire bead, direction of striations, scuff on sidewall, etc.). If pulling trailer, sketch type of trailer and damage received on the back of this page. Annotate any damage caused by extrication such as component removal by torching, prying, or hydraulic shears.

COLLISION DEFORMATION CLASSIFICATION

HIGHEST DELTA "V"

Accident Event Sequence Number	Object Contacted	(1) (2) Direction of Force	(3) Deformation Location	(4) Specific Longitudinal or Lateral Location	(5) Specific Vertical or Lateral Location	(6) Type of Damage Distribution	(7) Deformation Extent
4. _____	5. _____	6. _____	7. _____	8. _____	9. _____	10. _____	11. _____

Second Highest Delta "V"

12. _____	13. _____	14. _____	15. _____	16. _____	17. _____	18. _____	19. _____
-----------	-----------	-----------	-----------	-----------	-----------	-----------	-----------

CRUSH PROFILE

(The crush profile for the damage described in the CDC(s) above should be documented in the appropriate space below. ALL MEASUREMENTS ARE IN INCHES.)

HIGHEST DELTA "V"

20. L	21. C1	C2	C3	C4	C5	C6	22. + - D
_____	_____	_____	_____	_____	_____	_____	_____

Second Highest Delta "V"

23. L	24. C1	C2	C3	C4	C5	C6	25. + - D
_____	_____	_____	_____	_____	_____	_____	_____

26. Are CDCs Documented but Not Coded on The Automated File ? _____

- (0) No
- (1) Yes

27. Researcher's Assessment of Vehicle Disposition _____

- (0) Not towed due to vehicle damage
- (1) Towed due to vehicle damage
- (9) Unknown

28. Original Wheelbase _____

_____ Code to the nearest tenth of an inch (9999) Unknown

Variable Name: Type of Medical Facility (for Initial Treatment) [cont'd.]

consider themselves to be (according to criteria referenced above). Teams should also be alert for communication releases (i.e., newspapers, radio, TV, etc.) which concern the trauma capability status of their area emergency rooms.

Code "2" (Hospital) is used for all "hospitals" which do not fall into the definition of a Level I or Level II Trauma Center as defined.

Code "3" (Medical clinic) is used for treatment facilities which provide outpatient medical care with related in-house laboratory facilities (e.g, x- ray). These are usually a group practice in which several physicians work cooperatively. This code also includes school clinics, work place clinics, or similar facilities if they are staffed by a physician while open. If a doctor is not normally present at a clinic while it is open, then the appropriate code is "8" (Other).

Code "4" (Physician's office) is used when the person is initially treated in an office of a professional health care provider which does not qualify for codes "1" (Trauma center), "2" (Hospital), or "3" (Medical clinic).

Code "5" (Treatment later at medical facility) is used when a person's initial treatment by a health care professional (i.e., doctor) took place more than one hour after the accident. In addition, use this code when OA35, Treatment-Mortality, is coded "6" (Treatment later).

Code "8" (Other) is used when a health care provider's facility is used for the initial treatment, and the facility does not qualify for one of the codes "1" (Trauma center), "2" (Hospital), "3" (Medical clinic), or "4" (Physician's office) above.

Code "9" (Unknown) is used when it is unknown what type of initial treatment facility was used or when it is unknown if treatment of any kind was obtained.

EXTERIOR VEHICLE LOG

Performance Assessment

TO BE COMPLETED BY TEAM																																																											
1. PSU Number _____	13. Number of Coded CDCs (0,1,2) _____																																																										
2. Case Number - Stratum _____	14. Number of Coded Crush Profiles (0,1,2) _____																																																										
3. Researcher Completing Form _____																																																											
4. Vehicle Number _____																																																											
5. Date Vehicle Inspected ____/____/____																																																											
TO BE COMPLETED BY ZONE CENTER																																																											
6. Assessment Of Complexity Of Inspection _____ (1) Level 1 - No measurements required (e.g., vehicle repaired or measurements not obtainable) <u>Level 2</u> (2) Routine (3) Difficult	<p>Highest CDC</p> <table style="width: 100%; text-align: center; border-collapse: collapse;"> <tr> <td style="border: 1px solid black; width: 20px;">4</td> <td style="border: 1px solid black; width: 20px;">5</td> <td style="border: 1px solid black; width: 20px;">6</td> <td style="border: 1px solid black; width: 20px;">7</td> <td style="border: 1px solid black; width: 20px;">8</td> <td style="border: 1px solid black; width: 20px;">9</td> <td style="border: 1px solid black; width: 20px;">10</td> <td style="border: 1px solid black; width: 20px;">11</td> </tr> <tr> <td style="border: 1px solid black; height: 20px;"></td> <td style="border: 1px solid black; height: 20px;"></td> <td style="border: 1px solid black; height: 20px;"></td> <td style="border: 1px solid black; height: 20px;"></td> <td style="border: 1px solid black; height: 20px;"></td> <td style="border: 1px solid black; height: 20px;"></td> <td style="border: 1px solid black; height: 20px;"></td> <td style="border: 1px solid black; height: 20px;"></td> </tr> </table> <p>Secondary CDC</p> <table style="width: 100%; text-align: center; border-collapse: collapse;"> <tr> <td style="border: 1px solid black; width: 20px;">12</td> <td style="border: 1px solid black; width: 20px;">13</td> <td style="border: 1px solid black; width: 20px;">14</td> <td style="border: 1px solid black; width: 20px;">15</td> <td style="border: 1px solid black; width: 20px;">16</td> <td style="border: 1px solid black; width: 20px;">17</td> <td style="border: 1px solid black; width: 20px;">18</td> <td style="border: 1px solid black; width: 20px;">19</td> </tr> <tr> <td style="border: 1px solid black; height: 20px;"></td> <td style="border: 1px solid black; height: 20px;"></td> <td style="border: 1px solid black; height: 20px;"></td> <td style="border: 1px solid black; height: 20px;"></td> <td style="border: 1px solid black; height: 20px;"></td> <td style="border: 1px solid black; height: 20px;"></td> <td style="border: 1px solid black; height: 20px;"></td> <td style="border: 1px solid black; height: 20px;"></td> </tr> </table> <p>Highest Crush Profile</p> <table style="width: 100%; text-align: center; border-collapse: collapse;"> <tr> <td style="border: 1px solid black; width: 20px;">20</td> <td style="border: 1px solid black; width: 20px;">21</td> <td style="border: 1px solid black; width: 20px;">22</td> </tr> <tr> <td style="border: 1px solid black; height: 20px;"></td> <td style="border: 1px solid black; height: 20px;"></td> <td style="border: 1px solid black; height: 20px;"></td> </tr> </table> <p>Secondary Crush Profile</p> <table style="width: 100%; text-align: center; border-collapse: collapse;"> <tr> <td style="border: 1px solid black; width: 20px;">23</td> <td style="border: 1px solid black; width: 20px;">24</td> <td style="border: 1px solid black; width: 20px;">25</td> </tr> <tr> <td style="border: 1px solid black; height: 20px;"></td> <td style="border: 1px solid black; height: 20px;"></td> <td style="border: 1px solid black; height: 20px;"></td> </tr> </table> <p>26 27 28 29 30 31 32</p> <table style="width: 100%; text-align: center; border-collapse: collapse;"> <tr> <td style="border: 1px solid black; width: 20px;">26</td> <td style="border: 1px solid black; width: 20px;">27</td> <td style="border: 1px solid black; width: 20px;">28</td> <td style="border: 1px solid black; width: 20px;">29</td> <td style="border: 1px solid black; width: 20px;">30</td> <td style="border: 1px solid black; width: 20px;">31</td> <td style="border: 1px solid black; width: 20px;">32</td> </tr> <tr> <td style="border: 1px solid black; height: 20px;"></td> <td style="border: 1px solid black; height: 20px;"></td> <td style="border: 1px solid black; height: 20px;"></td> <td style="border: 1px solid black; height: 20px;"></td> <td style="border: 1px solid black; height: 20px;"></td> <td style="border: 1px solid black; height: 20px;"></td> <td style="border: 1px solid black; height: 20px;"></td> </tr> </table> <p>Data Status Codes:</p> <p>(Blank) Correct (1) Derived error (2) Non-correctable error (3) Correctable error (4) Change - no error (5) Sequencing error (8) MDE error (9) Unknown coded</p>	4	5	6	7	8	9	10	11									12	13	14	15	16	17	18	19									20	21	22				23	24	25				26	27	28	29	30	31	32							
4	5	6	7	8	9	10	11																																																				
12	13	14	15	16	17	18	19																																																				
20	21	22																																																									
23	24	25																																																									
26	27	28	29	30	31	32																																																					
7. Applicable Precrash Measurements _____ (0) Not applicable (1) Substandard (2) Standard (3) Above standard																																																											
8. Impact Damage Documentation _____ (0) Not applicable (1) Substandard (2) Standard (3) Above standard																																																											
9. Quality Of Vehicle Damage Sketch _____ (0) Not applicable (e.g., repaired vehicle) (1) Substandard (2) Standard (3) Above standard																																																											
10. Exterior Slides Subject Quality _____ (0) Not applicable (1) Substandard (2) Standard (3) Above standard																																																											
11. Exterior Slides Quality _____ (0) Not applicable (1) Substandard (2) Standard (3) Above standard																																																											
12. Primary Error Source (Vehicle Plane) _____ (0) No error (1) Front (2) Side (left or right) (3) Back (rear) (4) Top (5) Undercarriage (8) Other (specify): _____																																																											

IF THIS VEHICLE WAS NOT TOWED (E.G., GV09 ≠ 1), DO NOT COMPLETE THE INTERIOR VEHICLE LOG

VEHICLE DAMAGE SKETCH

<p>TIRE – WHEEL DAMAGE a. Rotation physically restricted RF ___ LF ___ RR ___ LR ___ b. Tire deflated RF ___ LF ___ RR ___ LR ___ (1) Yes (2) No (8) NA (9) Unk.</p>	<p>ORIGINAL SPECIFICATIONS</p> <p>Wheelbase _____</p> <p>Overall Length _____</p> <p>Maximum Width _____</p> <p>Curb Weight _____</p> <p>Average Track _____</p> <p>Front Overhang _____</p> <p>Rear Overhang _____</p> <p>Engine Size: cyl./ displ. _____</p> <p>Undeformed End Width _____</p>	<p>WHEEL STEER ANGLES (For locked front wheels or displaced rear axles only)</p> <p>RF ± _____ °</p> <p>LF ± _____ °</p> <p>RR ± _____ °</p> <p>LR ± _____ °</p> <p>Within ± 5 degrees</p>
<p>TYPE OF TRANSMISSION</p> <p><input type="checkbox"/> Manual <input type="checkbox"/> Automatic</p>		<p>DRIVE WHEELS</p> <p><input type="checkbox"/> FWD <input type="checkbox"/> RWD <input type="checkbox"/> 4WD</p> <p>Approximate Cargo Weight _____</p>

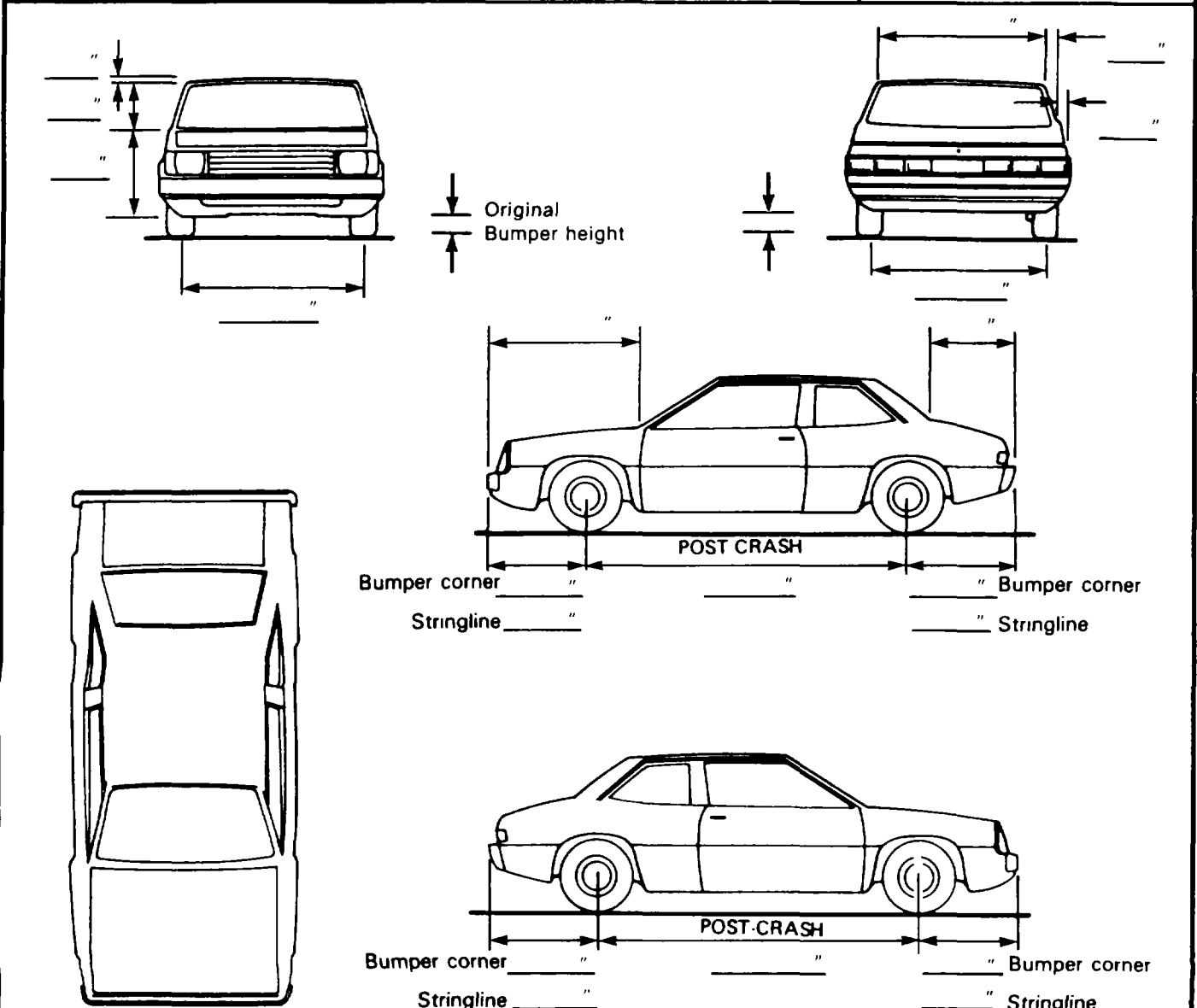

NOTES Sketch new perimeter and cross hatch direct damage and single hatch induced damage on all views. Annotate observations which might be useful in reconstructing the accident (e.g. grass in tire bead, direction of striations, scuff on sidewall, etc.). If pulling trailer, sketch type of trailer and damage received on the back of this page. Annotate any damage caused by extrication such as component removal by torching, prying, or hydraulic shears.

VEHICLE DAMAGE SKETCH

<p>TIRE - WHEEL DAMAGE</p> <p>a. Rotation physically restricted RF ___ LF ___ RR ___ LR ___</p> <p>b. Tire deflated RF ___ LF ___ RR ___ LR ___</p> <p>(1) Yes (2) No (8) NA (9) Unk.</p>	<p>ORIGINAL SPECIFICATIONS</p> <p>Wheelbase _____</p> <p>Overall Length _____</p> <p>Maximum Width _____</p> <p>Curb Weight _____</p> <p>Average Track _____</p> <p>Front Overhang _____</p> <p>Rear Overhang _____</p> <p>Engine Size: cyl./ displ. _____</p> <p>Undeformed End Width _____</p>	<p>WHEEL STEER ANGLES (For locked front wheels or displaced rear axles only)</p> <p>RF + _____ °</p> <p>LF ± _____ °</p> <p>RR ± _____ °</p> <p>LR ± _____ °</p> <p>Within ± 5 degrees</p>
<p>TYPE OF TRANSMISSION</p> <p><input type="checkbox"/> Manual <input type="checkbox"/> Automatic</p>		<p>DRIVE WHEELS</p> <p><input type="checkbox"/> FWD <input type="checkbox"/> RWD <input type="checkbox"/> 4WD</p> <p>Approximate Cargo Weight _____</p>

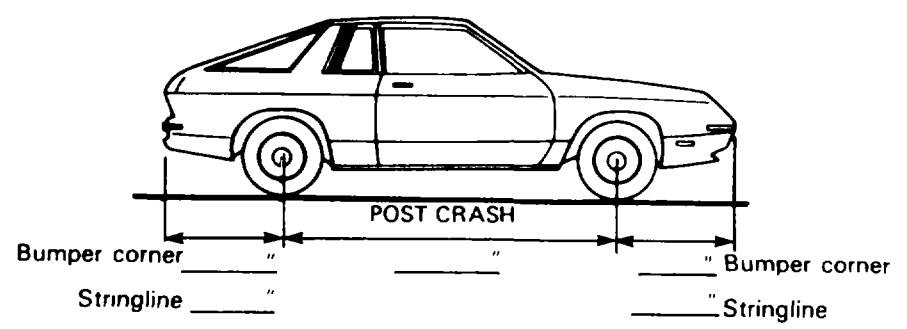
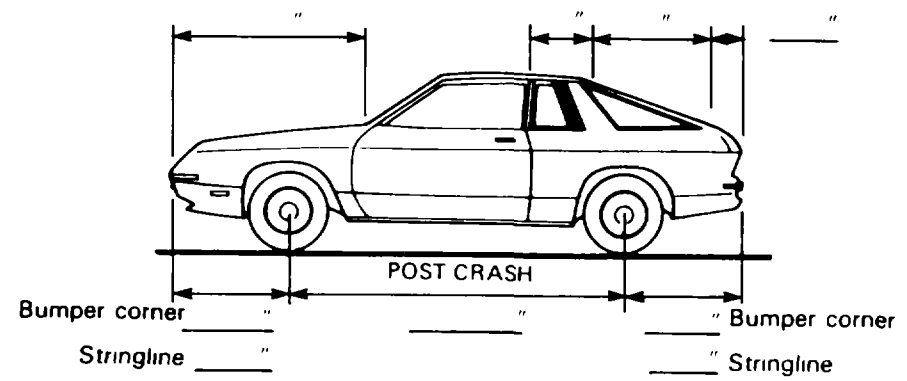
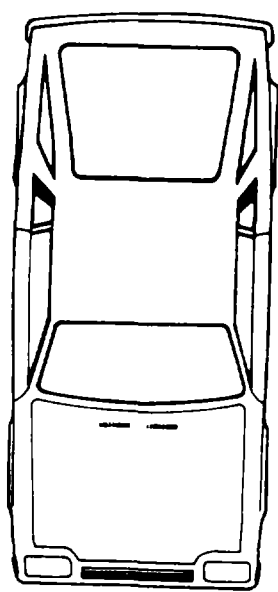
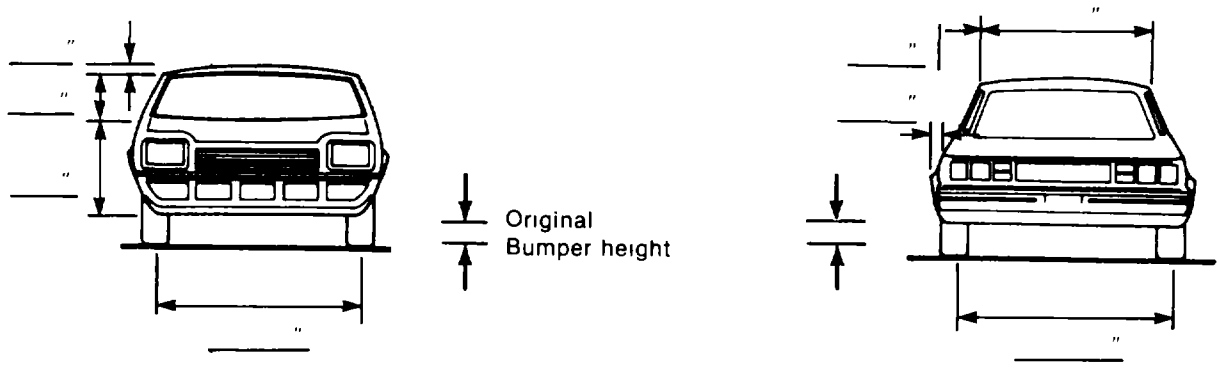

NOTES Sketch new perimeter and cross hatch direct damage and single hatch induced damage on all views. Annotate observations which might be useful in reconstructing the accident (e.g. grass in tire bead, direction of striations, scuff on sidewall, etc.). If pulling trailer, sketch type of trailer and damage received on the back of this page. Annotate any damage caused by extrication such as component removal by torching, prying, or hydraulic shears.

VEHICLE DAMAGE SKETCH

<p>TIRE - WHEEL DAMAGE</p> <p>a. Rotation physically restricted RF ____ LF ____ RR ____ LR ____</p> <p>b. Tire deflated RF ____ LF ____ RR ____ LR ____</p> <p>(1) Yes (2) No (8) NA (9) Unk.</p>	<p>ORIGINAL SPECIFICATIONS</p> <p>Wheelbase _____</p> <p>Overall Length _____</p> <p>Maximum Width _____</p> <p>Curb Weight _____</p> <p>Average Track _____</p> <p>Front Overhang _____</p> <p>Rear Overhang _____</p> <p>Engine Size: cyl./ displ. _____</p> <p>Undeformed End Width _____</p>	<p>WHEEL STEER ANGLES (For locked front wheels or displaced rear axles only)</p> <p>RF ± ____ °</p> <p>LF ± ____ °</p> <p>RR ± ____ °</p> <p>LR ± ____ °</p> <p>Within ± 5 degrees</p>
<p>TYPE OF TRANSMISSION</p> <p><input type="checkbox"/> Manual <input type="checkbox"/> Automatic</p>	<p>DRIVE WHEELS</p> <p><input type="checkbox"/> FWD <input type="checkbox"/> RWD <input type="checkbox"/> 4WD</p>	<p>Approximate Cargo Weight _____</p>

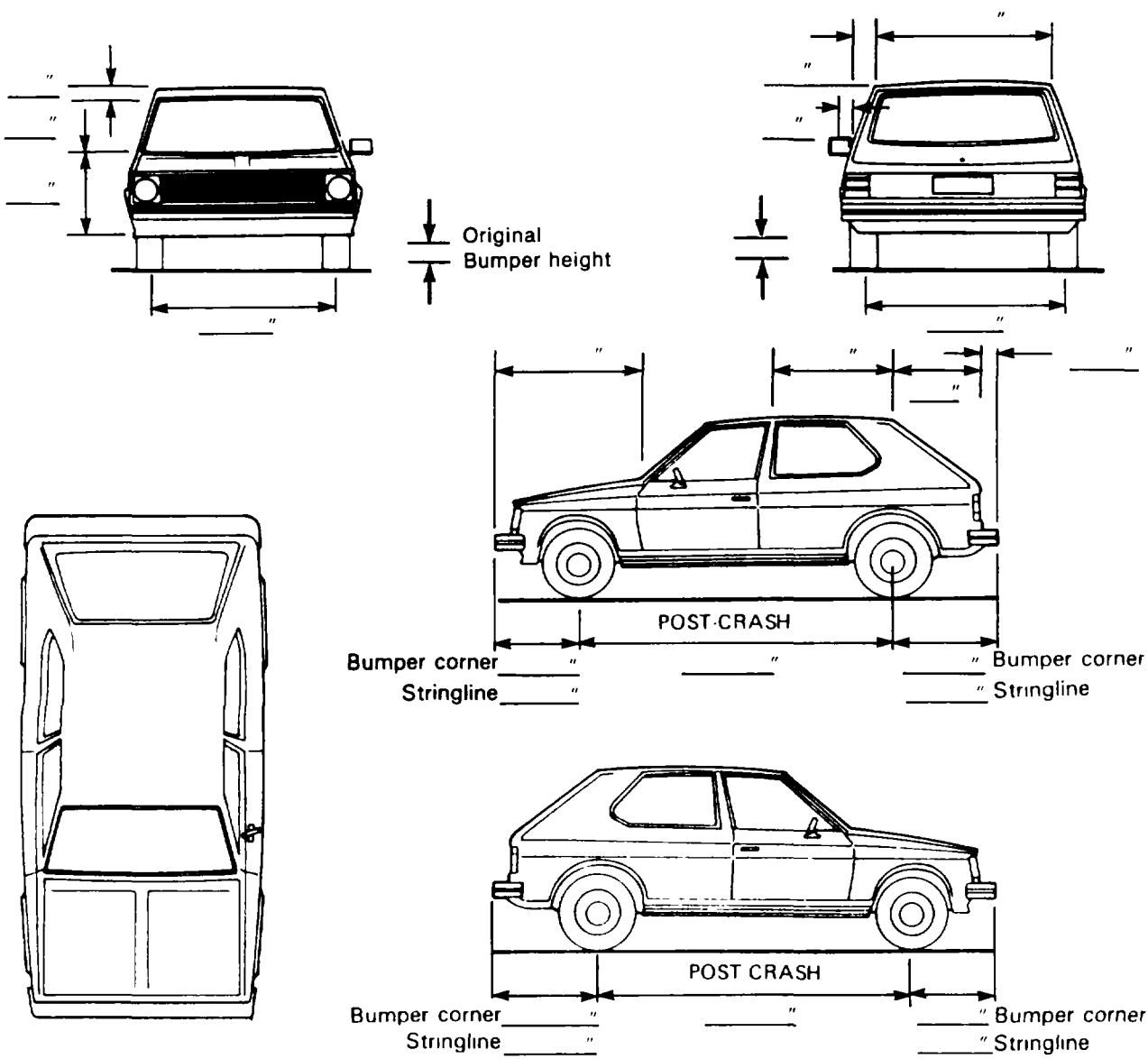

NOTES Sketch new perimeter and cross hatch direct damage and single hatch induced damage on all views. Annotate observations which might be useful in reconstructing the accident (e.g. grass in tire bead, direction of striations, scuff on sidewall, etc.). If pulling trailer, sketch type of trailer and damage received on the back of this page. Annotate any damage caused by extrication such as component removal by torching, prying, or hydraulic shears.

VEHICLE DAMAGE SKETCH

TIRE – WHEEL DAMAGE a. Rotation physically restricted RF ____ LF ____ RR ____ LR ____ (1) Yes (2) No (8) NA (9) Unk.		ORIGINAL SPECIFICATIONS Wheelbase _____ Overall Length _____ Maximum Width _____ Curb Weight _____ Average Track _____ Front Overhang _____ Rear Overhang _____ Engine Size: cyl./ displ. _____ Undeformed End Width _____		WHEEL STEER ANGLES (For locked front wheels or displaced rear axles only) RF ± _____ ° LF ± _____ ° RR ± _____ ° LR ± _____ ° Within ± 5 degrees
TYPE OF TRANSMISSION <input type="checkbox"/> Manual <input type="checkbox"/> Automatic		DRIVE WHEELS <input type="checkbox"/> FWD <input type="checkbox"/> RWD <input type="checkbox"/> 4WD		
		Approximate Cargo Weight _____		

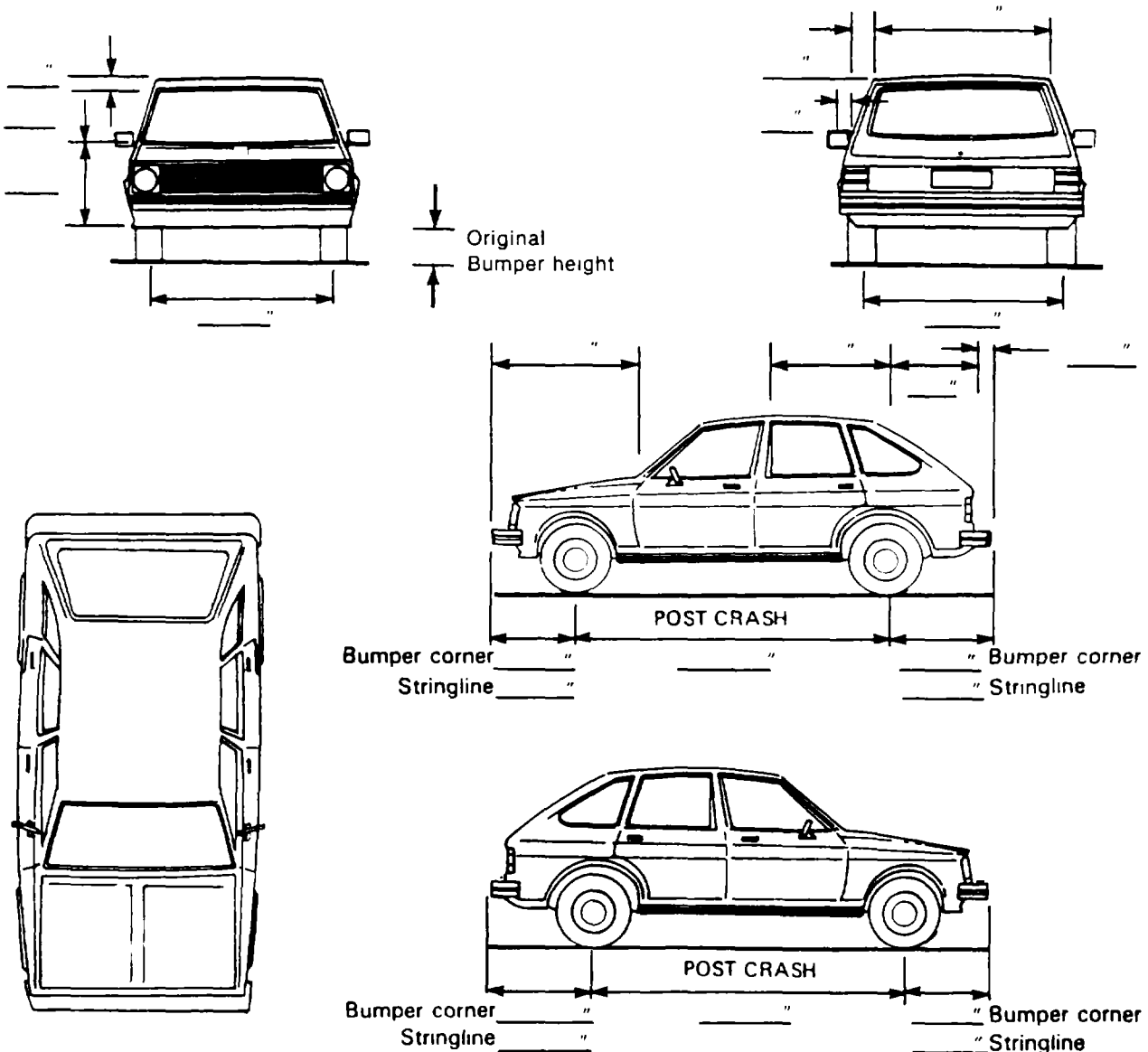

NOTES Sketch new perimeter and cross hatch direct damage and single hatch induced damage on all views. Annotate observations which might be useful in reconstructing the accident (e.g., grass in tire bead, direction of striations, scuff on sidewall, etc.). If pulling trailer, sketch type of trailer and damage received on the back of this page. Annotate any damage caused by extrication such as component removal by torching, prying, or hydraulic shears.

VEHICLE DAMAGE SKETCH

TIRE – WHEEL DAMAGE a. Rotation physically restricted RF ___ LF ___ RR ___ LR ___ b. Tire deflated RF ___ LF ___ RR ___ LR ___ (1) Yes (2) No (8) NA (9) Unk		ORIGINAL SPECIFICATIONS Wheelbase _____ Overall Length _____ Maximum Width _____ Curb Weight _____ Average Track _____ Front Overhang _____ Rear Overhang _____ Engine Size cyl./ displ _____ Undeformed End Width _____	WHEEL STEER ANGLES (For locked front wheels or displaced rear axles only) RF + _____ ° LF + _____ ° RR + _____ ° LR + _____ ° Within + 5 degrees
TYPE OF TRANSMISSION <input type="checkbox"/> Manual <input type="checkbox"/> Automatic		DRIVE WHEELS <input type="checkbox"/> FWD <input type="checkbox"/> RWD <input type="checkbox"/> 4WD	Approximate Cargo Weight _____

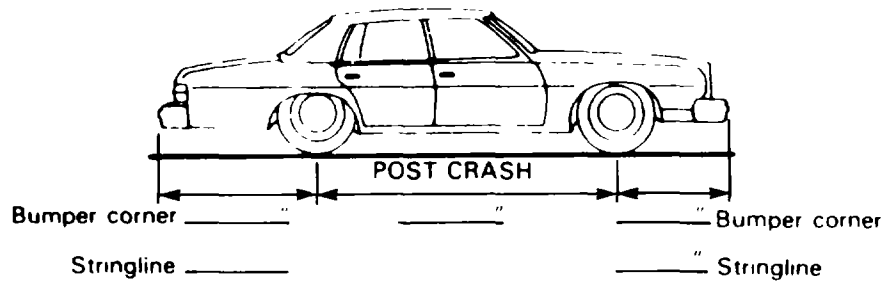
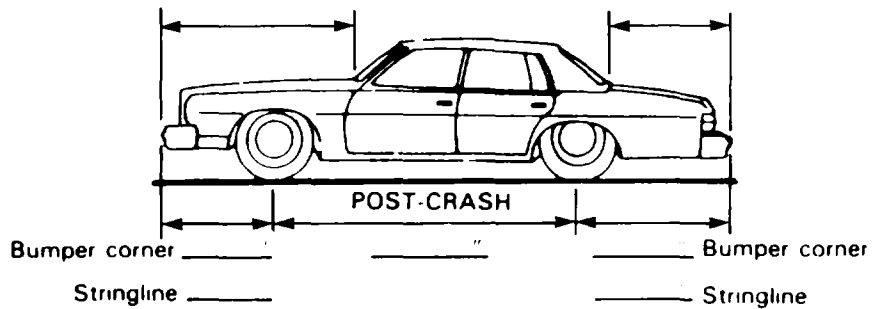
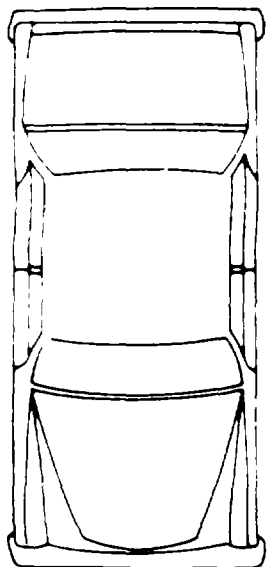
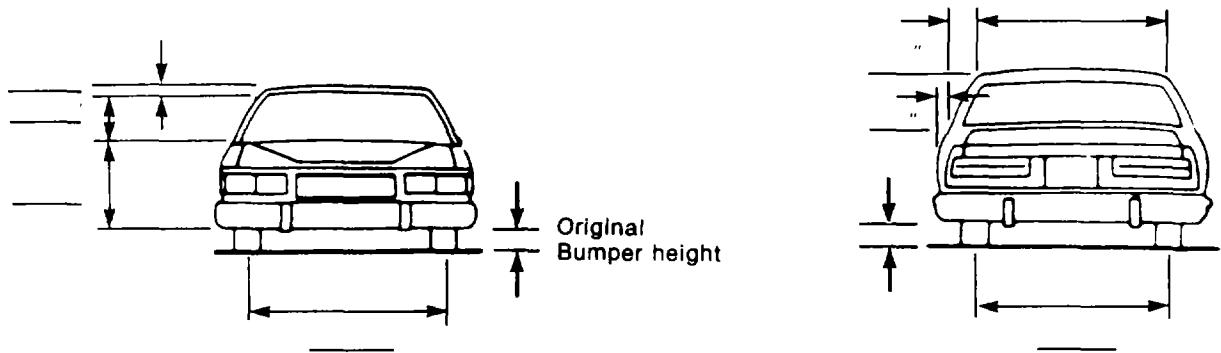

NOTES Sketch new perimeter and cross hatch direct damage and single hatch induced damage on all views. Annotate observations which might be useful in reconstructing the accident (e.g. grass in tire bead, direction of striations, scuff on sidewall, etc.). If pulling trailer, sketch type of trailer and damage received on the back of this page. Annotate any damage caused by extrication such as component removal by torching, prying, or hydraulic shears.

VEHICLE DAMAGE SKETCH

<p>TIRE – WHEEL DAMAGE a. Rotation physically restricted RF ___ LF ___ RR ___ LR ___ b. Tire deflated RF ___ LF ___ RR ___ LR ___ (1) Yes (2) No (8) NA (9) Unk.</p>	<p>ORIGINAL SPECIFICATIONS Wheelbase _____ Overall Length _____ Maximum Width _____ Curb Weight _____ Average Track _____ Front Overhang _____ Rear Overhang _____ Engine Size: cyl./ displ. _____ Undeformed End Width _____</p>	<p>WHEEL STEER ANGLES (For locked front wheels or displaced rear axles only) RF ± _____ ° LF ± _____ ° RR ± _____ ° LR ± _____ ° Within ± 5 degrees</p> <p>DRIVE WHEELS <input type="checkbox"/> FWD <input type="checkbox"/> RWD <input type="checkbox"/> 4WD</p> <p>Approximate Cargo Weight _____</p>
<p>TYPE OF TRANSMISSION <input type="checkbox"/> Manual <input type="checkbox"/> Automatic</p>		

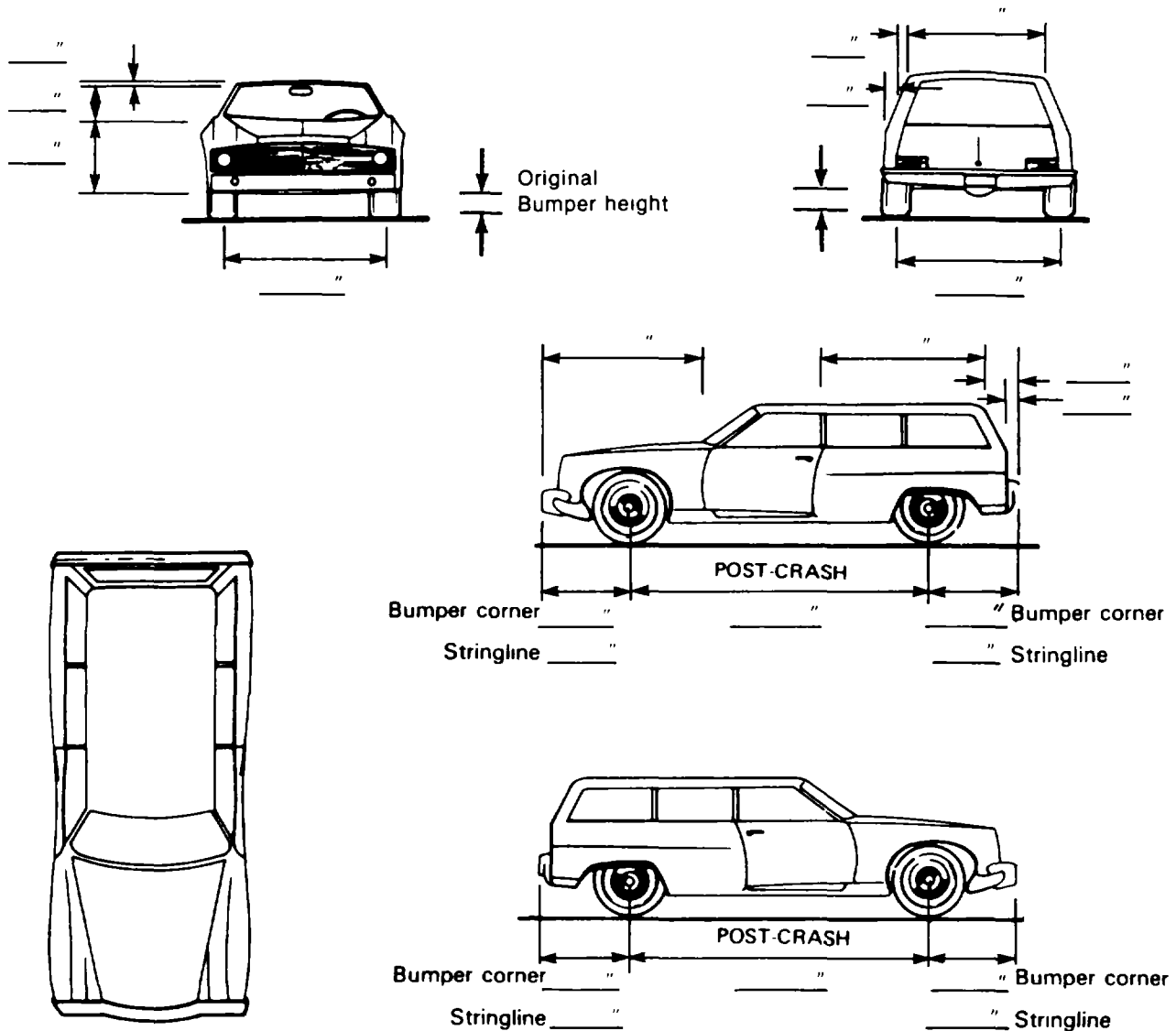

NOTES Sketch new perimeter and cross hatch direct damage and single hatch induced damage on all views. Annotate observations which might be useful in reconstructing the accident (e.g., grass in tire bead, direction of striations, scuff on sidewall, etc.). If pulling trailer, sketch type of trailer and damage received on the back of this page. Annotate any damage caused by extrication such as component removal by torching, prying, or hydraulic shears.

VEHICLE DAMAGE SKETCH

<p>TIRE – WHEEL DAMAGE</p> <p>a. Rotation physically restricted RF ___ LF ___ RR ___ LR ___</p> <p>b. Tire deflated RF ___ LF ___ RR ___ LR ___</p> <p>(1) Yes (2) No (8) NA (9) Unk.</p>	<p>ORIGINAL SPECIFICATIONS</p> <p>Wheelbase _____</p> <p>Overall Length _____</p> <p>Maximum Width _____</p> <p>Curb Weight _____</p> <p>Average Track _____</p> <p>Front Overhang _____</p> <p>Rear Overhang _____</p> <p>Engine Size: cyl./ displ. _____</p> <p>Undeformed End Width _____</p>	<p>WHEEL STEER ANGLES (For locked front wheels or displaced rear axles only)</p> <p>RF ± _____ °</p> <p>LF ± _____ °</p> <p>RR ± _____ °</p> <p>LR ± _____ °</p> <p>Within ± 5 degrees</p> <hr/> <p>DRIVE WHEELS</p> <p><input type="checkbox"/> FWD <input type="checkbox"/> RWD <input type="checkbox"/> 4WD</p> <hr/> <p>Approximate Cargo Weight _____</p>
<p>TYPE OF TRANSMISSION</p> <p><input type="checkbox"/> Manual <input type="checkbox"/> Automatic</p>		

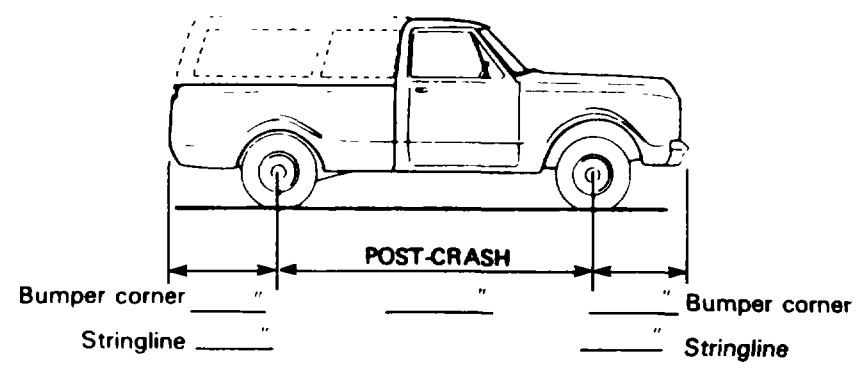
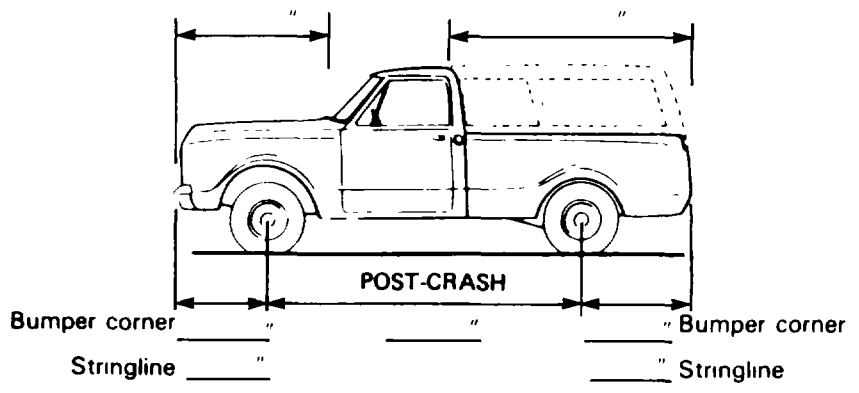
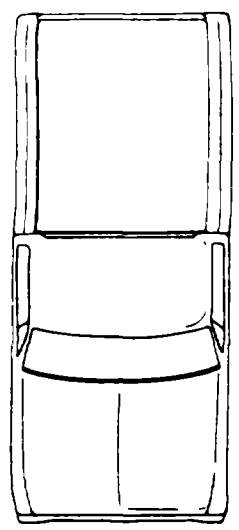
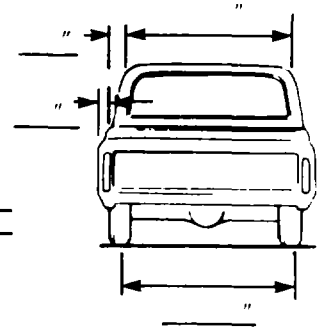
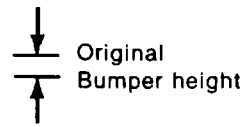
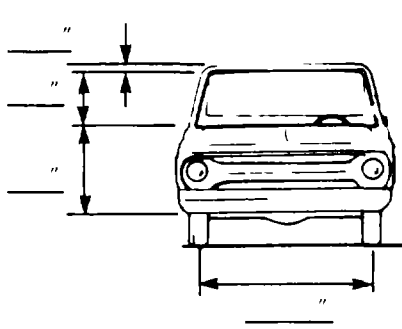

NOTES Sketch new perimeter and cross hatch direct damage and single hatch induced damage on all views. Annotate observations which might be useful in reconstructing the accident (e.g., grass in tire bead, direction of striations, scuff on sidewall, etc.). If pulling trailer, sketch type of trailer and damage received on the back of this page. Annotate any damage caused by extrication such as component removal by torching, prying, or hydraulic shears.

VEHICLE DAMAGE SKETCH

<p>TIRE – WHEEL DAMAGE</p> <p>a. Rotation physically restricted RF ___ LF ___ RR ___ LR ___</p> <p>b. Tire deflated RF ___ LF ___ RR ___ LR ___</p> <p>(1) Yes (2) No (8) NA (9) Unk.</p>	<p>ORIGINAL SPECIFICATIONS</p> <p>Wheelbase _____</p> <p>Overall Length _____</p> <p>Maximum Width _____</p> <p>Curb Weight _____</p> <p>Average Track _____</p> <p>Front Overhang _____</p> <p>Rear Overhang _____</p> <p>Engine Size: cyl./ displ. _____</p> <p>Undeformed End Width _____</p>	<p>WHEEL STEER ANGLES (For locked front wheels or displaced rear axles only)</p> <p>RF ± _____ °</p> <p>LF ± _____ °</p> <p>RR ± _____ °</p> <p>LR ± _____ °</p> <p>Within ± 5 degrees</p> <hr/> <p>DRIVE WHEELS</p> <p><input type="checkbox"/> FWD <input type="checkbox"/> RWD <input type="checkbox"/> 4WD</p> <hr/> <p>Approximate Cargo Weight _____</p>
<p>TYPE OF TRANSMISSION</p> <p><input type="checkbox"/> Manual <input type="checkbox"/> Automatic</p>		

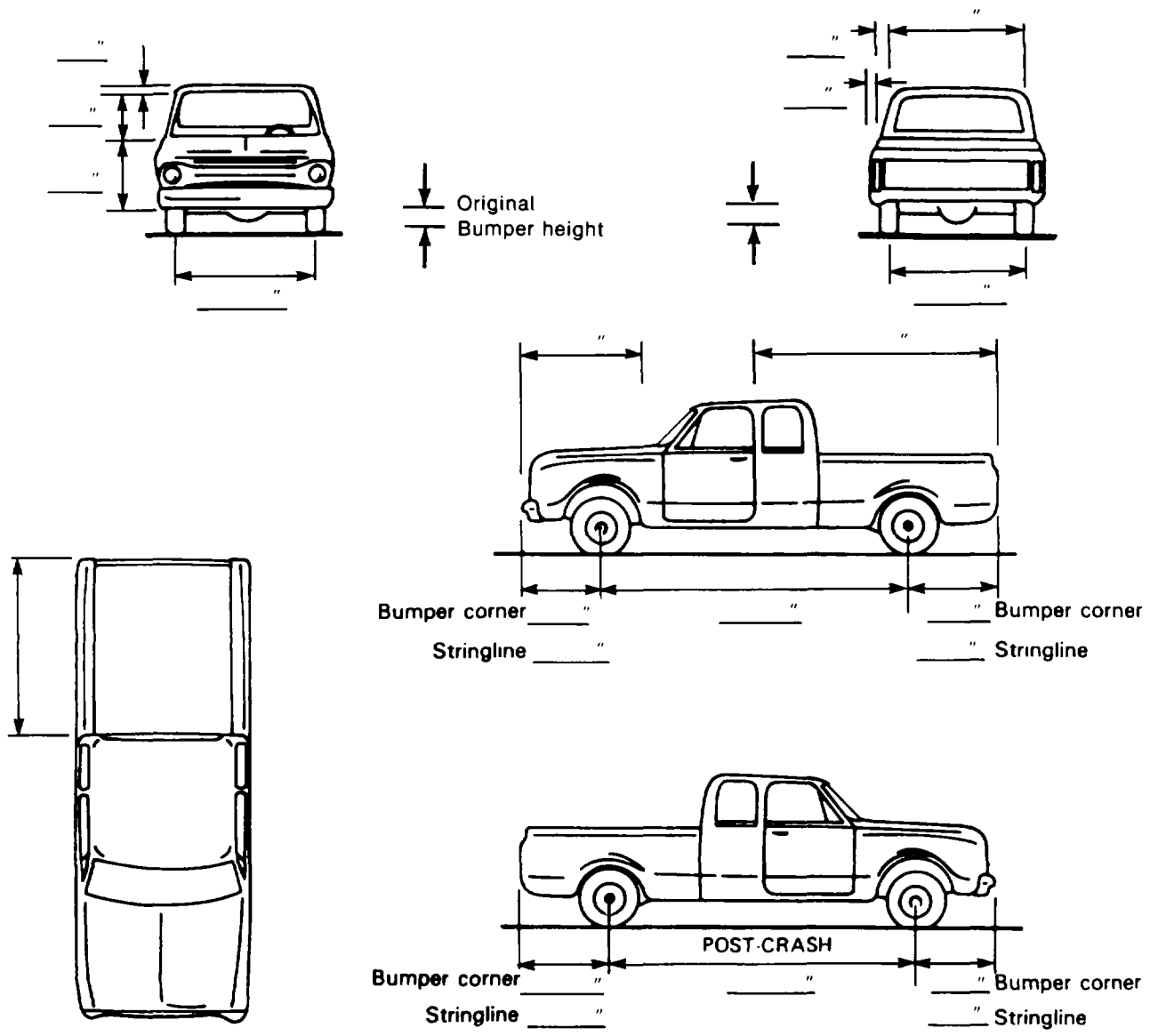

NOTES Sketch new perimeter and cross hatch direct damage and single hatch induced damage on all views. Annotate observations which might be useful in reconstructing the accident (e.g., grass in tire bead, direction of striations, scuff on sidewall, etc.). If pulling trailer, sketch type of trailer and damage received on the back of this page. Annotate any damage caused by extrication such as component removal by torching, prying, or hydraulic shears.

VEHICLE DAMAGE SKETCH

TIRE - WHEEL DAMAGE a. Rotation physically restricted RF ___ LF ___ RR ___ LR ___ b. Tire deflated RF ___ LF ___ RR ___ LR ___ (1) Yes (2) No (8) NA (9) Unk.		ORIGINAL SPECIFICATIONS Wheelbase _____ Overall Length _____ Maximum Width _____ Curb Weight _____ Average Track _____ Front Overhang _____ Rear Overhang _____ Engine Size: cyl./ displ. _____ Undeformed End Width _____		WHEEL STEER ANGLES (For locked front wheels or displaced rear axles only) RF ± _____ ° LF ± _____ ° RR ± _____ ° LR ± _____ ° Within ± 5 degrees	
TYPE OF TRANSMISSION <input type="checkbox"/> Manual <input type="checkbox"/> Automatic				DRIVE WHEELS <input type="checkbox"/> FWD <input type="checkbox"/> RWD <input type="checkbox"/> 4WD	
				Approximate Cargo Weight _____	

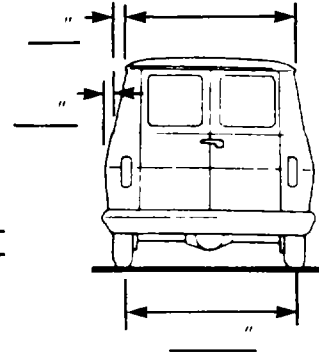
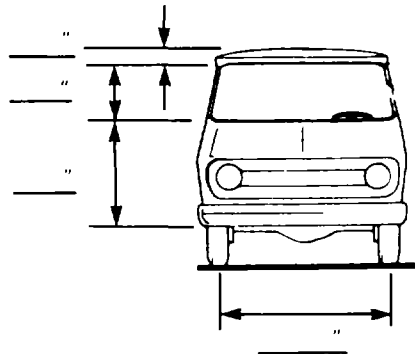

Original Bumper height

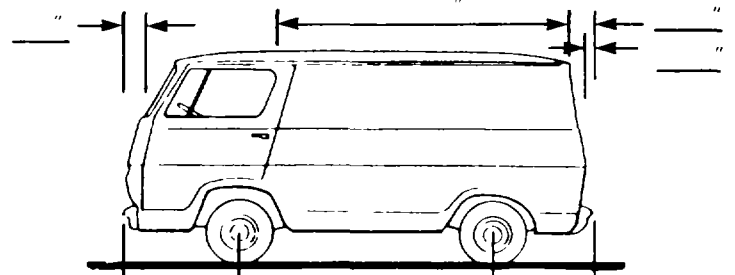

POST-CRASH
 Bumper corner _____" _____" _____" Bumper corner
 Stringline _____" _____" Stringline

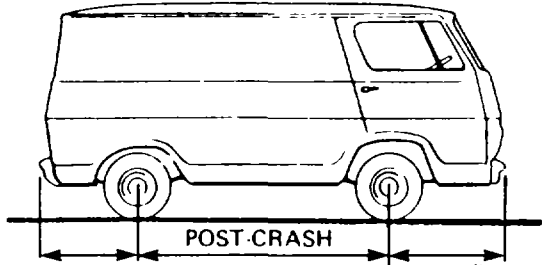
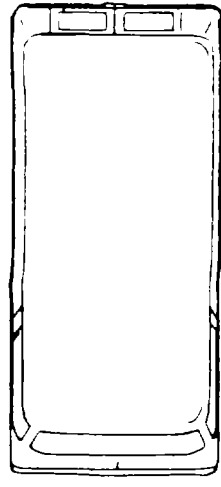

POST-CRASH
 Bumper corner _____" _____" _____" Bumper corner
 Stringline _____" _____" Stringline

NOTES: Sketch new perimeter and cross hatch direct damage and single hatch induced damage on all views. Annotate observations which might be useful in reconstructing the accident (e.g. grass in tire bead, direction of striations, scuff on sidewall, etc.). If pulling trailer, sketch type of trailer and damage received on the back of this page. Annotate any damage caused by extrication such as component removal by torching, prying, or hydraulic shears.

VEHICLE DAMAGE SKETCH

<p>TIRE – WHEEL DAMAGE</p> <p>a. Rotation physically restricted _____</p> <p>b. Tire deflated _____</p> <p>RF _____ RF _____</p> <p>LF _____ LF _____</p> <p>RR _____ RR _____</p> <p>LR _____ LR _____</p> <p>(1) Yes (2) No (8) NA (9) Unk.</p>	<p>ORIGINAL SPECIFICATIONS</p> <p>Wheelbase _____</p> <p>Overall Length _____</p> <p>Maximum Width _____</p> <p>Curb Weight _____</p> <p>Average Track _____</p> <p>Front Overhang _____</p> <p>Rear Overhang _____</p> <p>Engine Size: cyl./ displ. _____</p> <p>Undeformed End Width _____</p>	<p>WHEEL STEER ANGLES (For locked front wheels or displaced rear axles only)</p> <p>RF ± _____ °</p> <p>LF ± _____ °</p> <p>RR ± _____ °</p> <p>LR ± _____ °</p> <p>Within ±5 degrees</p>
<p>TYPE OF TRANSMISSION</p> <p><input type="checkbox"/> Manual <input type="checkbox"/> Automatic</p>	<p>DRIVE WHEELS</p> <p><input type="checkbox"/> FWD <input type="checkbox"/> RWD <input type="checkbox"/> 4WD</p> <p>Approximate Cargo Weight _____</p>	

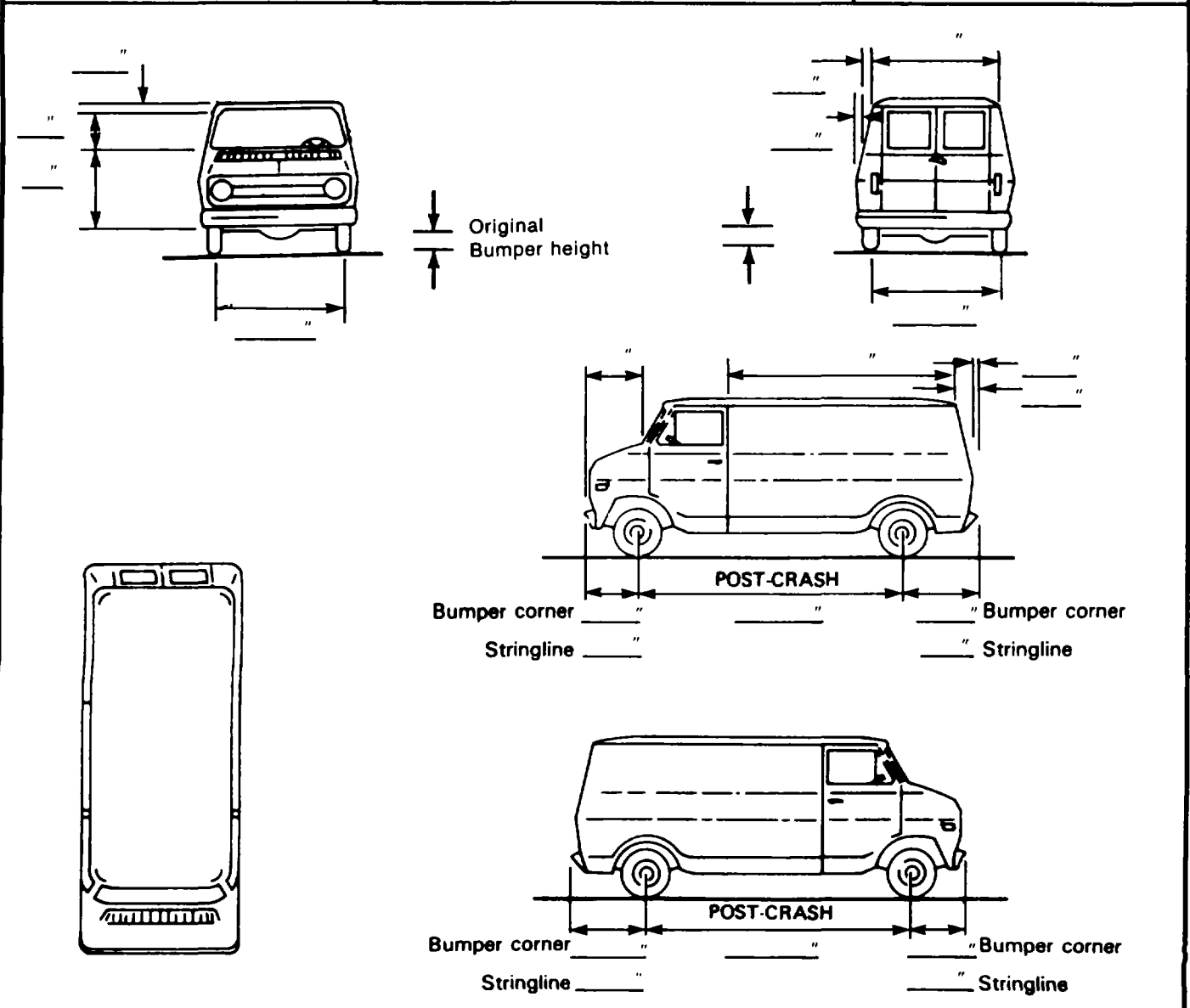

NOTES Sketch new perimeter and cross hatch direct damage and single hatch induced damage on all views. Annotate observations which might be useful in reconstructing the accident (e.g., grass in tire bead, direction of striations, scuff on sidewall, etc.). If pulling trailer, sketch type of trailer and damage received on the back of this page. Annotate any damage caused by extrication such as component removal by torching, prying, or hydraulic shears.

VEHICLE DAMAGE SKETCH

TIRE – WHEEL DAMAGE a. Rotation physically restricted RF ____ LF ____ RR ____ LR ____ (1) Yes (2) No (8) NA (9) Unk.		ORIGINAL SPECIFICATIONS Wheelbase _____ Overall Length _____ Maximum Width _____ Curb Weight _____ Average Track _____ Front Overhang _____ Rear Overhang _____ Engine Size: cyl./ displ. _____ Undeformed End Width _____		WHEEL STEER ANGLES (For locked front wheels or displaced rear axles only) RF ± ____ ° LF ± ____ ° RR ± ____ ° LR ± ____ ° Within ± 5 degrees
TYPE OF TRANSMISSION <input type="checkbox"/> Manual <input type="checkbox"/> Automatic		DRIVE WHEELS <input type="checkbox"/> FWD <input type="checkbox"/> RWD <input type="checkbox"/> 4WD		
		Approximate Cargo Weight _____		

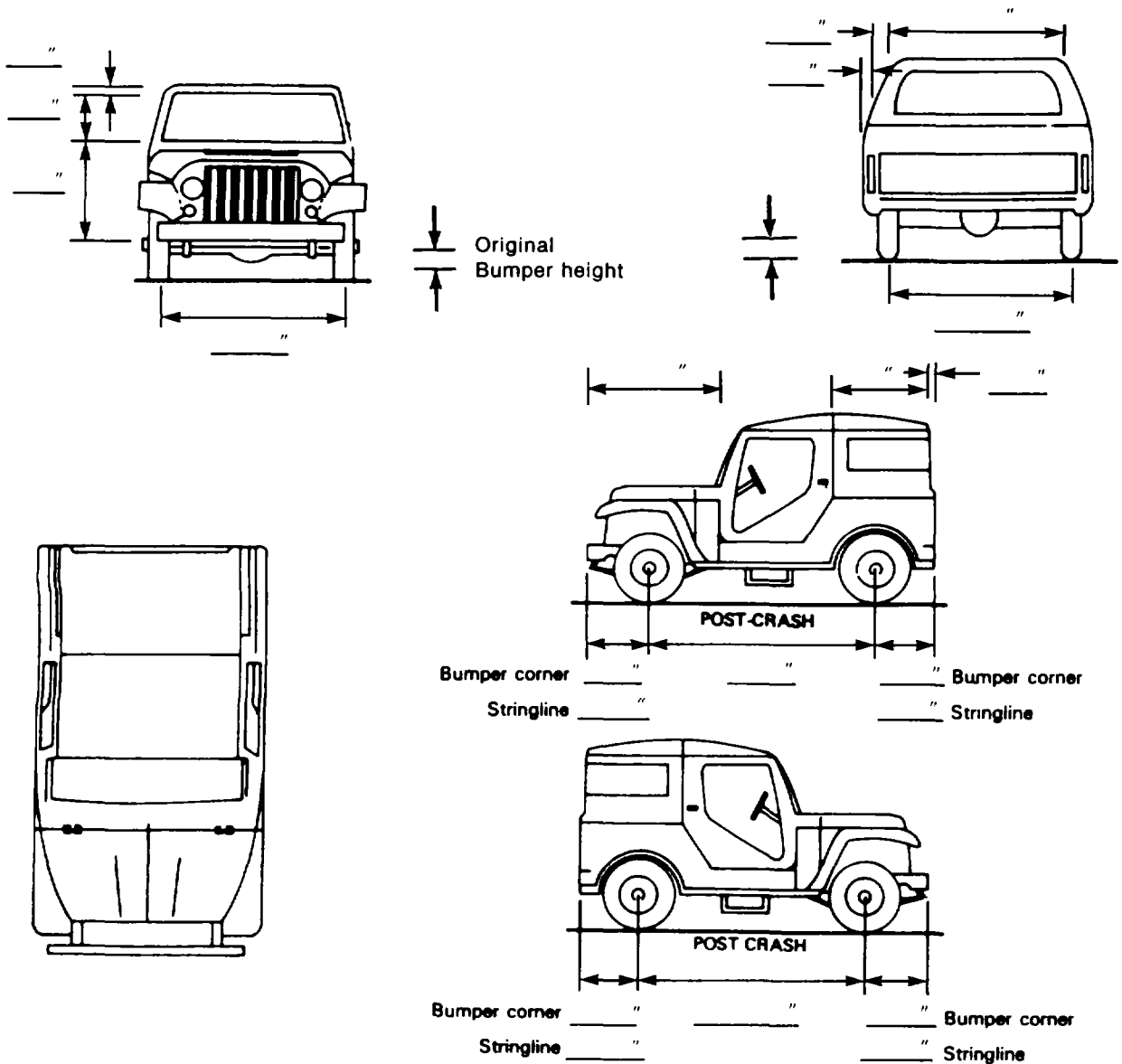

NOTES Sketch new perimeter and cross hatch direct damage and single hatch induced damage on all views. Annotate observations which might be useful in reconstructing the accident (e.g. grass in tire bead, direction of striations, scuff on sidewall, etc.). If pulling trailer, sketch type of trailer and damage received on the back of this page. Annotate any damage caused by extrication such as component removal by torching, prying, or hydraulic shears.

INSTRUCTIONS FOR COMPLETION OF CDS APPLICABLE FIELD MEASUREMENTS PAGE

The first page of the Exterior Vehicle Form is designed to be a comprehensive data collection tool arranged in a format to allow sufficient space for documenting vehicle damage profiles and associated relevant measurements. The established protocol for obtaining crush data is defined in the NASS Accident Investigation Procedures Manual. The procedures for recording that data in a format that will maintain system-wide consistency are included in the following remarks.

Side or End Damage

Undeformed end width is measured and recorded whenever a side or end plane is involved.

End shift at frame (CDC) is assessed to determine whether sufficient end shift or bowing exists to necessitate incrementing the direction of force. Remember, end shift of four inches or more must be present on: both frame rails to allow for incrementation to the left or right, or at least one frame rail for vertical incrementation. If neither frame rail has end shift, this should be annotated on the form.

Locator

Locate end of damage with respect to the centerline or, for side impacts, to an undamaged axle. Spaces are provided to record the "Location of Direct Damage", "Location of Field L", and "Location of Maximum Crush" measurements with respect to the vehicle centerline or bumper corner for end impacts and an undamaged axle for side impacts. These required measurements are used to assist with CDC assignments (direct) and to determine the "D" dimension if not directly measured. The following examples include the data that are required.

Direct Damage:

- o begins 1.5" right of centerline (end plane), or
- o begins 19" rearward of the rear axle (side plane)

Field L:

- o Entire end plane involved, or
- o C₁ is 40" forward of the rear axle

Maximum Crush

- o located 6" left of centerline, or
- o located at C₃, 20" forward of the rear axle

These data are required for each impact. A space is provided to indicate the "Specific Impact Number". If there are more impacts than spaces, the data are listed on the back of the first page of the Exterior Vehicle Form.

Crush Profile

Several data elements are required to properly complete the crush profile data portion of the first page of the Exterior Vehicle Form. These data are grouped together as they are generally obtained during the vehicle inspection. Each column (or associated group of columns) is explained as below.

INSTRUCTIONS FOR COMPLETION OF CDS APPLICABLE FIELD MEASUREMENTS PAGE

Specific Impact Number contains the impact sequence number specific to this vehicle for which the data are being obtained.

Plane of C-Measurements contains the annotation of the plane at which the crush profile is documented (i.e., bumper, grille, sill, mid-door). This column is annotated "average" when used to indicate the resultant profile from an underride-type impact.

Direct Damage: Width contains the indication of the length of direct damage as measured on the vehicle.

Direct Damage: Max Crush contains the measured maximum crush for the profile being documented. Recall that maximum crush is determined after free space is subtracted. Indicate the free space at Max Crush in the space below the measurement. Use a third line to indicate the resultant maximum crush.

Field L contains the recorded Field L as obtained during the vehicle inspection. Recall that the Field L represents both direct and induced damage as measured along the reference line (shock cord). This measurement is used to locate the position of the C-measurements.

C1-C6 contains the recorded two, four, or six C-measurements (as appropriate) on the line for the crush profile being documented. On the line beneath, annotate the free space to be subtracted. A third line is used to record the resultant crush profile.

± D contains the recorded "D" dimension. The data obtained for the Field L damage locator is used to calculate "D"; indicate whether it is a positive or negative value.

If the spaces provided are not sufficient for the number of impacts which require documentation, include the additional data on the back of the first page of the Exterior Vehicle Form.

In the following example, a crush profile for a frontal bumper underride impact is displayed. This example is used as a guideline when completing the first page of the Exterior Vehicle Form.

INSTRUCTIONS FOR COMPLETION OF CDS APPLICABLE FIELD MEASUREMENTS PAGE (3)

Sp cific Impact Number	Plane of C-Measurements	Direct Damage		Field L	C ₁	C ₂	C ₃	C ₄	C ₅	C ₆	=D
		Width (CDC)	Max Crush								
1	GRILLE	19	29	54	29	21	14	11	7	6	0
	-FREESPACE		6		6	4.5	4	4	4.5	6	
	RESULTANT		23		23	16.5	10	7	2.5	0	0
1	BUMPER	19	9	56	9	6	4.5	2	2	1	0
	-FREESPACE		2		2	1	.5	.5	1	2	
	RESULTANT		7		7	5	4	1.5	1	0	0
①	AVERAGE	19	15	56	15	10.75	7	4.25	1.75	0	0

INSTRUCTIONS FOR COMPLETION OF VEHICLE DAMAGE SKETCH

Exterior Vehicle Form Page 2 (and associated Pages 2B-2I) enables researchers to report data that are not encoded and might otherwise be omitted from the case. Pertinent data such as scrapes, scratches, buckling, paint transfers, and other indications of engagement or relative motion are reported on this page. In addition, sketch the vehicle damage profile on the outlines provided, using the established protocol as below.

- Outline the damage profile produced by the impact.
- Use cross hatches to indicate direct damage.
- Highlight induced damage and/or remote buckling with diagonal lines.

The following sketch exemplifies these procedures on the overhead profile.

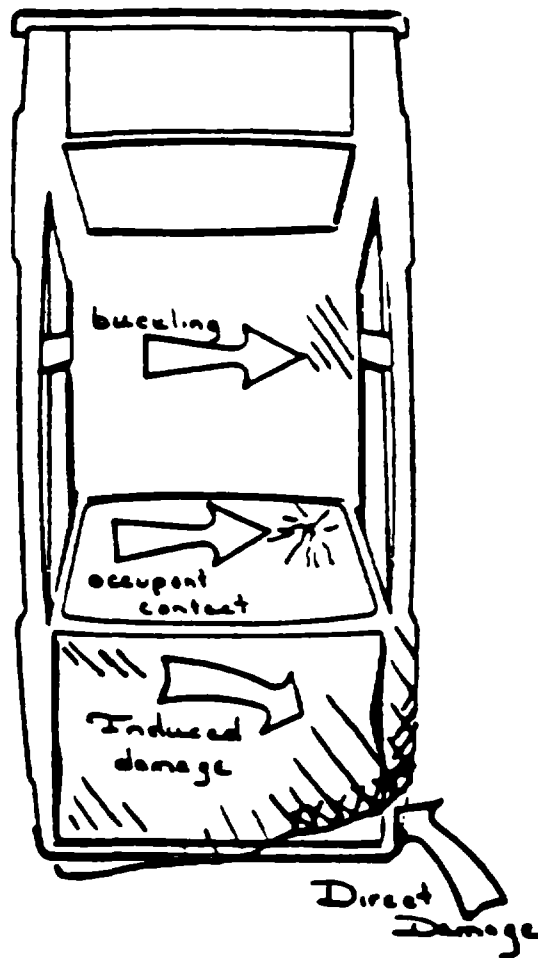

INSTRUCTIONS FOR COMPLETION OF VEHICLE DAMAGE SKETCH

(2)

Although researchers are reporting a vehicle's accident related damage, other damage may be observed which existed prior to the accident. These damaged areas, in addition to any towing related damage, are indicated and annotated accordingly.

Relevant measurements are required on the Vehicle Damage Sketch page in order to support other coded and noncoded data elements. Wheelbase and overhang measurements are necessary to provide relative measurements in support of documented crush profiles. Wheelbase and overhang are required from both sides of the vehicle for all vehicles inspected.

Extent zone measurements are also required; although, only the measurements which pertain to the damage plane are needed (i.e., hood length for frontal, side extents for side impacts, etc.). Obtain all measurements which may be needed when questions arise regarding the damaged plane. If doubt exists concerning whether an impact is to a frontal or a side plane, obtain both front and side extent zone measurements.

In addition, front and back pre-crash bumper height measurements must be obtained for vehicles sustaining any end plane impact with another vehicle (in-transport or not in-transport) [i.e., column (3) of CDC (including non-coded CDCs) must equal "F" or "B"].

- Measure from the bottom of the bumper face (reinforcement bar) to the ground.
- Include a calibrated instrument (contour gauge rod or 4 foot scale) in the photographs of the vehicle's bumper height.

The example below provides wheel base, overhang, and extent zone data for a frontal impact.

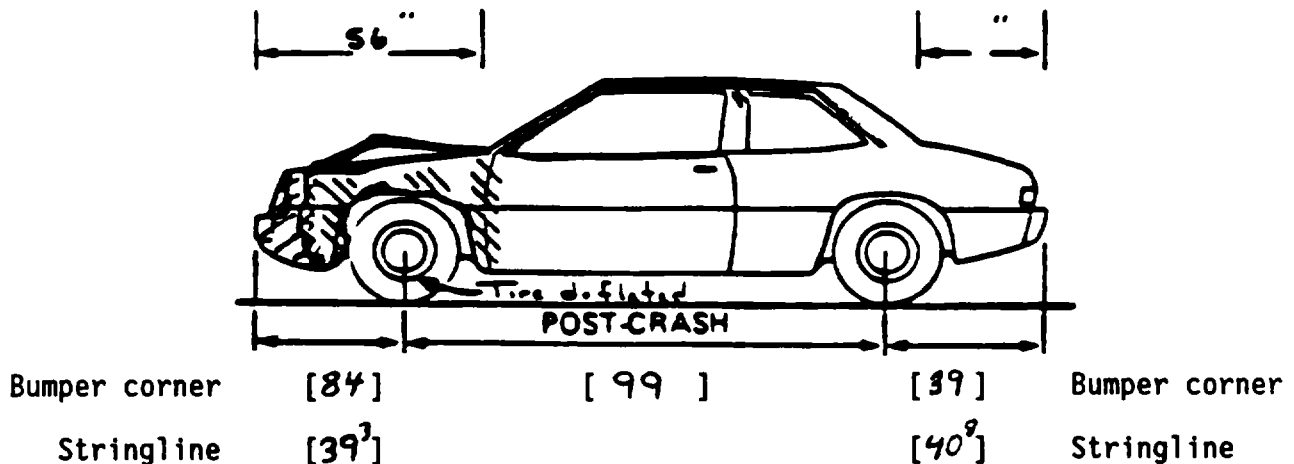

Additional data required on the Vehicle Damage Sketch page includes.

- o Original dimensions including: wheelbase, overall length, maximum width, curb weight, average track, and overhangs

INSTRUCTIONS FOR COMPLETION OF VEHICLE DAMAGE SKETCH

- o The engine displacement (i.e., 302 cu. in. or 5.0 L) and number of cylinders (i.e., 4, 6, V6, or V8)
- o The transmission type: automatic or manual (3, 4, 5 speed, etc.)
- o The drive wheels: front wheel drive, rear wheel drive, or four wheel drive
- o Approximate cargo weight

Variable Name: 1st C.D.C. - Accident Event Sequence Number
2nd C.D.C. - Accident Event Sequence Number

Element Values:

Blank No event or not CDC applicable
01-98 Code the sequence number of the event selected for inclusion in the adjacent variables (i.e., Object Contacted, EV05 and EV13; and CDCs, EV06-EV11 and EV14-EV19).

Source: Primary sources are the scene and vehicle inspections; secondary sources include the police report and interviewee.

Remarks:

In accidents involving multiple events, the events are numbered in sequence by chronology in reference to the entire sequence. This total accident event sequence number is coded adjacent (EV04 or EV12) to the CDC that was produced during this event. For example, three cars are waiting at a red light. A pickup truck rear ends the third car in line and pushes it into the second car which in turn is pushed into the first car. The sequential event numbers in this accident would be as follows.

Event number 1 - pickup vs. 3rd car
Event number 2 - 3rd car vs. 2nd car
Event number 3 - 2nd car vs. 1st car

Do not forget that the numbers are actually encoded in accordance with CDC prioritization. Refer to the Overview section of the CDC Related Remarks (variables EV06-EV11, EV14-EV19 page 2) entitled "CDC Ranking" for comments on selecting the events to be encoded in the CDC variables.

Code "Blank" (No event or not CDC applicable) is used when there is not an event or when an event exists but is not CDC applicable.

Variable Name: 1st C.D.C. - Object Contacted
2nd C.D.C. - Object Contacted

Element Values:

Blank No event or not CDC applicable

01-30 - Vehicle Number: If the object contacted by the vehicle under consideration was a motor vehicle in-transport, code the Vehicle Number assigned to that vehicle.

Noncollision	56 Other traffic barrier (specify):
31 Overturn - rollover	57 Fence
* 32 Fire or explosion	58 Wall
33 Jackknife	59 Building
* 34 Other intraunit damage (specify):	60 Ditch or culvert
* 35 Noncollision injury	61 Ground
38 Other noncollision (specify):	62 Fire hydrant
39 Noncollision - details unknown	63 Curb
	64 Bridge
	68 Other fixed object (specify):
	69 Unknown fixed object
Collision with Fixed Object	Collision with Nonfixed Object
41 Tree (\leq 4 inches in diameter)	71 Motor vehicle not in- transport
42 Tree (> 4 inches in diameter)	72 Pedestrian
43 Shrubbery or bush	73 Cyclist or cycle
44 Embankment	74 Other nonmotorist or conveyance (specify):
45 Breakaway pole or post (any diameter)	75 Vehicle occupant
Nonbreakaway Pole or Post	76 Animal
50 Pole or post (\leq 4 inches in diameter)	77 Train
51 Pole or post (> 4 inches but \leq 12 inches in diameter)	78 Trailer, disconnected in transport
52 Pole or post (> 12 inches in diameter)	88 Other nonfixed object (specify):
53 Pole or post (diameter unknown)	89 Unknown nonfixed object
54 Concrete traffic barrier	98 Other event (specify):
55 Impact attenuator	99 Unknown event or object

* These codes are not valid for use on the Exterior Vehicle Form, but they are retained for use on the Accident Form.

Source: Primary sources are the scene and vehicle inspections; secondary sources include the police report and interviewees.

Remarks:

Variable Name: 1st C.D.C. - Object Contacted (cont'd.)
2nd C.D.C. - Object Contacted (cont'd.)

Code the appropriate object contacted for each event only if the event is CDC applicable. Events in which there is not a corresponding CDC (i.e., fire, explosion, other intraunit damage, or a noncollision injury), are identified on the Accident Form only. If an impact causes a fire or explosion, the impact is coded and the fire or explosion is annotated. The object contacted codes are the same as those listed in the Accident Form under variable AC16, et.al., Vehicle Number or Object Contacted.

The coding priority of object contacted elements is based upon the highest and second highest delta V impacts. Refer to the overview of the "CDC Related Remarks" (EV06-EV11, EV14-EV19).

Code "Blank" (No event or not CDC applicable) is used when there is not an event or when an event exists but is not CDC applicable.

Code "31" (Overturn - rollover) is used whenever a vehicle rolls over or overturns. This event is reported in the accident sequence variables on the Accident Form (AC12-AC18, AC19-AC25, etc.). It is assumed a rollover will generally involve contact with the road surface or ground. In this situation, the object contacted is encoded "31" (Overturn - rollover) and not code "61" (Ground). In the event another object in the environment is contacted during the rollover sequence, the rollover event is listed on the Accident Form, but may not be encoded in the CDC variables on the Exterior Vehicle Form (EV04-EV11, EV12-EV19), unless the rollover is applicable to CDC.

Code "32" (Fire or explosion) refers to those events which result from a non-impact caused fire or explosion. No impact can be associated with this event. If an impact causes a fire or explosion, the impact is encoded and the fire or explosion is annotated by the researcher. This event is outside the scope of CDC and is not encoded in variables EV04-EV19, Collision Deformation Classification.

Code "32" (Fire or explosion) is not to be used on the Exterior Vehicle Form.

Code "33" (Jackknife) is used whenever there is sufficient uncontrolled rotation (articulation) between a towing unit and a trailing unit such that they contact each other resulting in direct damage to the towing unit. Jackknife may occur to any vehicle which is pulling a trailing unit by a fixed linkage so long as the trailing unit and the pulling vehicle are capable of rotating (articulating) with respect to each other.

Code "34" (Other intraunit damage) refers to situations where damage to the towing unit is caused by the trailing unit, but a jackknife did not

Variable Name: 1st C.D.C. - Object Contacted (cont'd.)
2nd C.D.C. - Object Contacted (cont'd.)

occur. This event is outside the scope of the CDC and is not encoded in variables EV04-EV11 or EV14-EV19, Collision Deformation Classification.

Codes "34" (Other intraunit damage) and "35" (Noncollision injury) are not to be used on the Exterior Vehicle Form.

Code "35" (Noncollision injury) refers to situations where an occupant, of a vehicle not involved in an impact, sustains an injury. This includes "falling from vehicle". This event is outside the scope of CDC and is not encoded in variables EV04-EV19, Collision Deformation Classification.

Code "38" (Other noncollision) is used when a vehicle sets an object in motion that strikes or is struck by a vehicle before the object stabilizes. Examples include dislodged cargo, spewed gravel, etc. It may be used in other situations subject to consultation with the zone center. If this event is outside the scope of CDC, it is not encoded in variables EV04-EV19, Collision Deformation Classification.

Code "39" (Noncollision - details unknown) is used when it is known that the event was a noncollision but specifics are not known. If this event is outside the scope of CDC, it is not encoded in variables EV04-EV19, Collision Deformation Classification.

Codes "41" [Tree (≤ 4 inches in diameter)] and "42" [Tree (> 4 inches in diameter)] refer to the diameter of the tree measured on the horizontal plane at the point of impact.

Code "43" (Shrubbery or bush) refers to vegetation which is usually of a woody multi-stemmed variety and in most instances is low growing rather than tall. Some common examples are boxwood, hawthorn, and mountain laurel.

Code "44" (Embankment) is used only when damage or injury results from impacting the embankment.

Codes "45" [Breakaway pole or post (any diameter)] and "50" through "53" (Pole or post) use the words "pole" and "post" in a general sense and include all types of supports for utility lines, light standards, post mounted mailboxes, warning devices, signs, and traffic control signals. Privately owned, as well as publicly owned, highway devices are included in these codes. They may be made of wood, metal, or concrete and may have various cross-sectional shapes and dimensions. The pole or post must be nontemporary (i.e., have a permanent base or be anchored in the ground). Fence posts are not included in these codes.

Variable Name: 1st C.D.C. - Object Contacted (cont'd.)
2nd C.D.C. - Object Contacted (cont'd.)

The following diagrams indicate the proper measurement for determining the "diameter" for use in coding pole/post attributes "45" [Breakaway pole or post (any diameter)] and "50" through "53" (Pole or post).

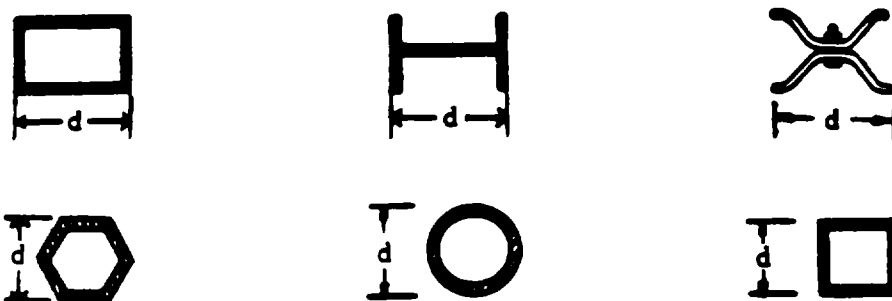

Code "45" [Breakaway pole or post (any diameter)] refers to a pole or post which is mounted on a base designed to readily disengage or fracture from an impacting vehicle above a predetermined force level. A pole or post fitted with such a device is a breakaway pole or post; otherwise, it is a nonbreakaway pole. Common types of breakaway bases are illustrated on the following pages.

Code "50" [Pole or post (≤ 4 inches in diameter)] refers to a pole or post whose diameter, when measured using the method shown above, is less than or equal to 4 inches, and the pole or post is not mounted on a breakaway base.

Code "51" [Pole or post (> 4 but ≤ 12 inches in diameter)] refers to a pole or post which is not mounted on a breakaway base and whose diameter is within the range specified.

Code "52" [Pole or post (> 12 inches in diameter)] refers to poles or posts which are of the correct size and are not mounted on a breakaway base.

Code "53" (Pole, post - diameter unknown) is used for any pole or post, not on a breakaway base, of unknown diameter.

When a vehicle impacts a fixed object whose object contacted code is "41"- "43", "45", or "50"- "53" and causes the fixed object or any portion thereof to become dislodged or airborne such that the object or portion thereof subsequently falls on the vehicle, the appropriate object contacted code for the object in its dislodged or airborne state is the same as when the object was initially impacted (i.e., "41"- "43", "45", "50"- "53").

Variable Name: 1st C.D.C. - Object Contacted (cont'd.)
2nd C.D.C. - Object Contacted (cont'd.)

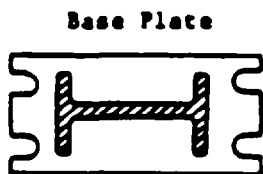
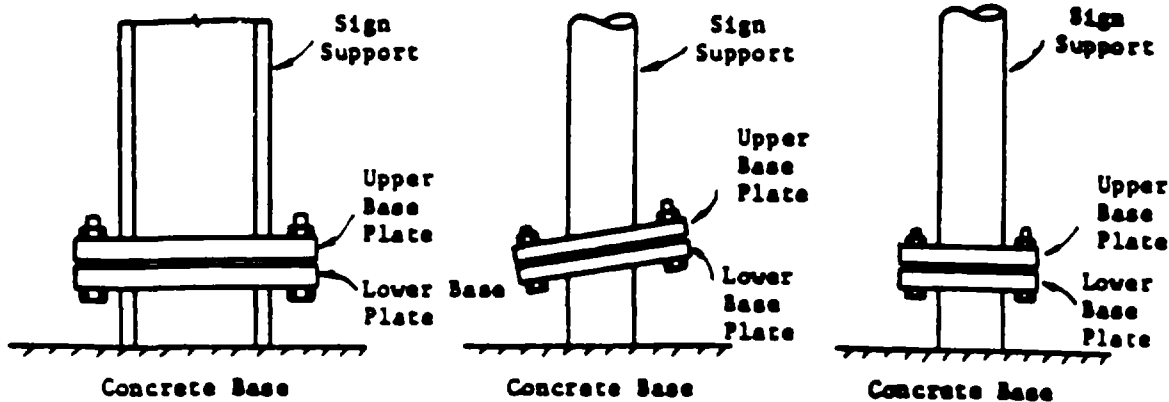

HORIZONTAL
SLIP BASE



INCLINED
SLIP BASE



TRIANGULAR
SLIP BASE

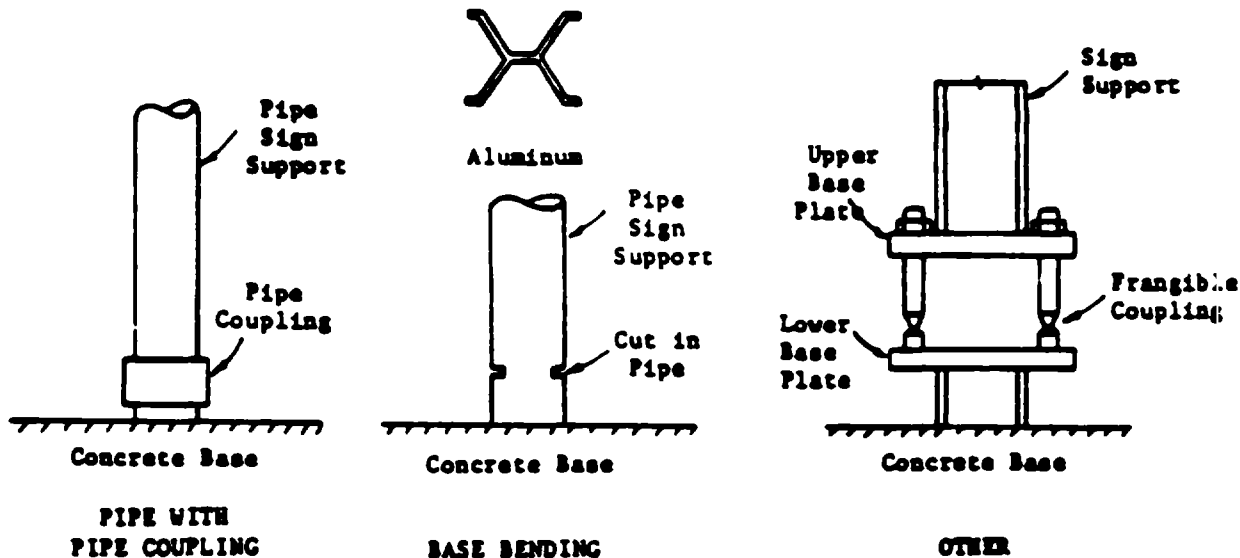

Variable Name: 1st C.D.C. - Object Contacted (cont'd.)
2nd C.D.C. - Object Contacted (cont'd.)

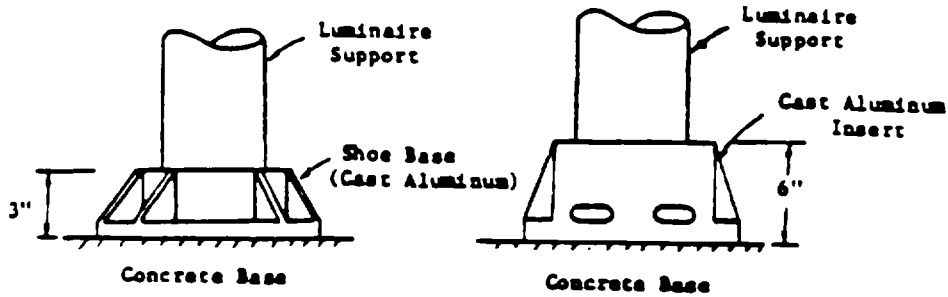

CAST ALUMINUM SHOE BASE/INSERT (FRANGIBLE)

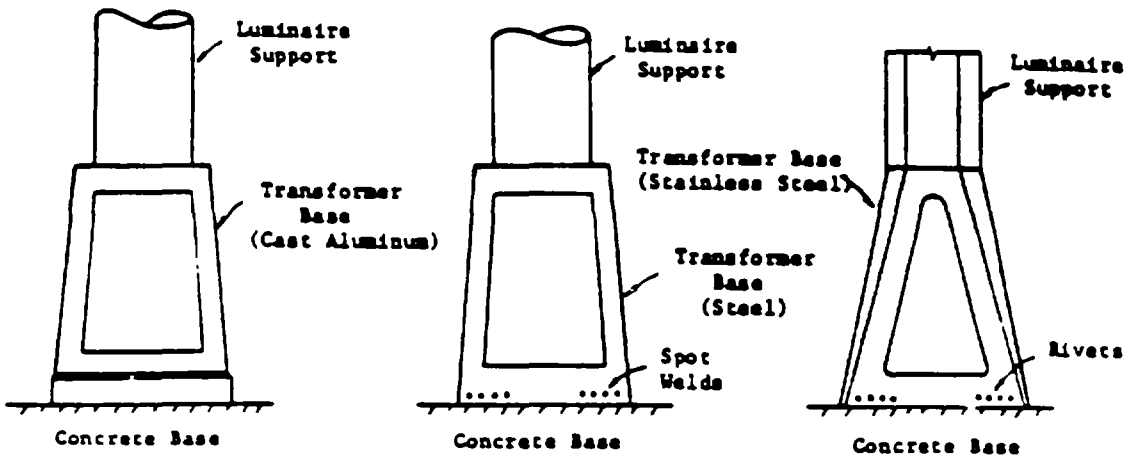

CAST ALUMINUM TRANSFORMER BASE (FRANGIBLE)

PROGRESSIVE SHEAR TRANSFORMER BASE

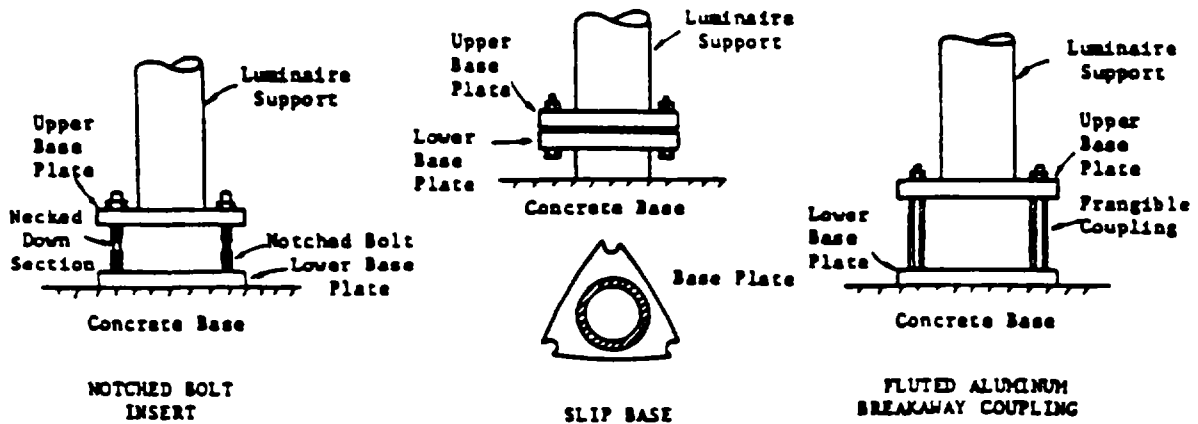

EV05
EV13
(7)

Variable Name: 1st C.D.C. - Object Contacted (cont'd.)
2nd C.D.C. - Object Contacted (cont'd.)

Code "54" (Concrete traffic barrier) refers to the longitudinal traffic barriers constructed of concrete and located: on the outside of the road surface, in a median, or in gore areas. Concrete walls (vertical side surfaces) do not apply here, see code "58" (Wall). Below are a few of the common designs of concrete traffic barriers.

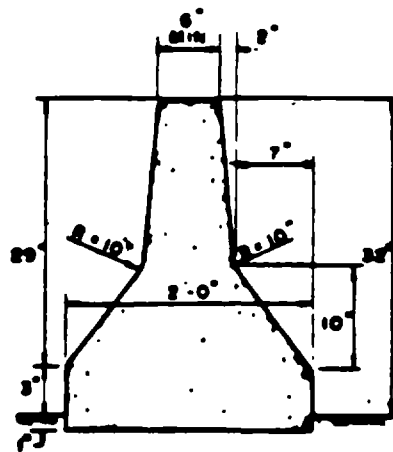

(Footing & Reinforcing Varies)

MB 5

Concrete Median Barrier

Continuously poured, reinforced, sloped faced, concrete section. Barrier can be anchored by dowels or an asphalt key.

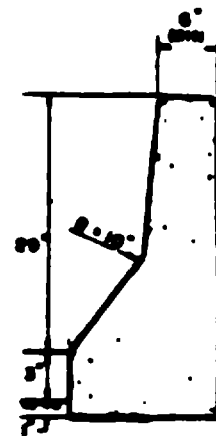

Concrete Safety Shape

Code "55" (Impact attenuator) refers to crash cushions which are barriers placed in front of fixed objects on the highway to absorb energy, and thus, to mitigate the injury effects of collisions at such sites. A number of common impact attenuating devices may be encountered; therefore, be sure to photograph them when encountered. Some common types are shown on continuation pages (12) and (13).

Code "56" (Other traffic barrier) refers to any longitudinal barrier not constructed of concrete. This includes all guardrails, median barriers, and bridge rails. See code "64" (Bridge) for additional coding conventions for bridge structures.

Variable Name: 1st C.D.C. - Object Contacted (cont'd.)
2nd C.D.C. - Object Contacted (cont'd.)

Code "57" (Fence) includes both the fence material and the support posts.

Code "58" (Wall) refers to solid, vertical faced, concrete, brick, stone, or other structurally sound roadside devices which may act as a traffic barrier in some locations. Do not confuse this code with "Fence" (code "57") or "Building" (code "59"). In most instances a wall will be backfilled with soil and will act as a vertically faced embankment.

Code "59" (Building) is used when the vehicle impacts a roofed and walled structure built for permanent use. The type of construction material used is not of interest, nor is the use of the building.

Code "60" (Ditch or culvert) refers to: (1) a man-made structure for drainage purposes, or (2) a man-made structure that allows passage over a drainage area and is that part of the structure which is intended to channel flow through the structure and maintain the stability/integrity of the road bed. If the culvert structure has a portion above the road surface which is of sufficient height to engage above the wheels of an errant CDS applicable vehicle and redirect it, that part of the structure is considered an "Other traffic barrier" (code "56"). When the sides of the ditch are approximately of equal height, it makes no difference which side of the ditch was struck; however, if the struck side is substantially higher than the other side, code the impact with the struck side as an "Embankment" (code "44"). Substantial means that an embankment existed had the ditch not been present.

Code "61" (Ground) refers to an impact with the ground. Collisions which may be classified using this code include (but are not limited to) vehicles which sustain undercarriage damage by (1) straddling the pavement and shoulder and impacting a prominent pavement lip, or (2) free falls or vaults from the road surface to the ground.

Code "62" (Fire hydrant) refers to the roadside device used by fire departments to provide water for fighting fires. Usually made of steel, these devices are also referred to as fireplugs or fire standpipes in some areas.

Variable Name: 1st C.D.C. - Object Contacted (cont'd.)
2nd C.D.C. - Object Contacted (cont'd.)

Code "63" (Curb) is used when the vehicle contacts a raised element at the edge of a roadway. Curbs are used to: control drainage, act as deterrents to vehicles leaving the pavement at hazardous points, delineate the edge of the pavement, present a more finished appearance, and assist in the orderly development of the roadway edge. Often a curb serves two or more of these purposes. Some typical highway curbs are illustrated in the diagrams below. Note that the dimensions are typical dimensions and may differ from the installations observed in the field.

Barrier Curbs

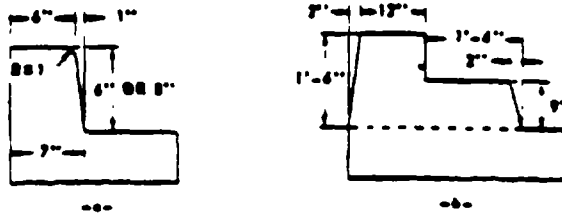

Mountable Curbs

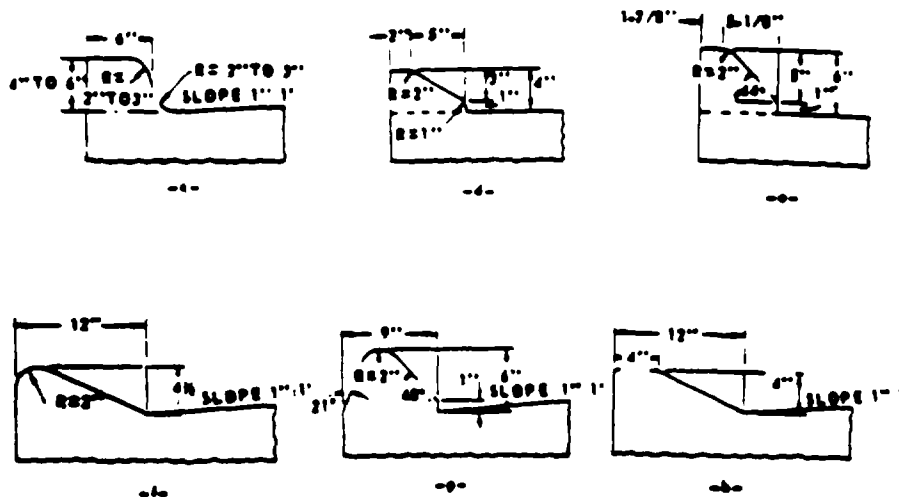

Typical Highway Curbs

Code "64" (Bridge) encompasses all structural members of an overpass structure used for vehicular or pedestrian traffic. This code excludes bridge rails; however, it does include bridge piers, bridge abutments, bridge parapet ends, wing walls associated with bridge abutments, and support columns. See continuation page (14) for a descriptive drawing.

Variable Name: 1st C.D.C. - Object Contacted (cont'd.)
2nd C.D.C. - Object Contacted (cont'd.)

- Code "68" (Other fixed object) is used for any other object of sufficient mass or anchored such that it is not readily movable; compare with code "88" (Other nonfixed object). Examples include large boulders, large logs (fallen trees), etc.
- Code "69" (Unknown fixed object) is used when it is known that the vehicle struck a fixed object but the specific type of object is not known.
- Code "71" (Motor vehicle not in transport) refers to a motor vehicle which is not on the roadway and not in motion (e.g., vehicle located in parking lane).
- Code "72" (Pedestrian) is defined as any person who is on a trafficway or on a sidewalk or path contiguous with a trafficway, and who is not in or on a nonmotorist conveyance. This includes persons who are in contact with the ground, roadway, etc., but who are holding onto a vehicle. A nonmotorist conveyance is defined as any human-powered device by which a nonmotorist may move, or by which a pedestrian or nonmotorist may move another nonmotorist, other than by pedaling. A nonmotorist conveyance includes the following: baby carriage, coaster wagon, ice skates, roller skates, push cart, scooter, skate board, skis, sled, wheelchair, rickshaw, etc. This includes those persons in a nonmotorist conveyance who hold onto a motor vehicle in motion. Excluded are pedalcyclists.
- Code "73" (Cyclist or cycle) refers to any occupant of a pedalcycle (see ANSI D16.1-1983, section 2.2.16, page 9), the cycle, or both. This includes those cyclists who hold onto a motor vehicle in motion.
- Code "74" (Other nonmotorist or conveyance) refers to a person who is not an occupant of a motor vehicle in-transport, a pedestrian, or a cyclist. Use this code if the impact was with a nonmotorist conveyance or a nonmotorist associated with a nonmotorist conveyance [if an animal is associated with this impact, see code "76" (Animal)]. This code also would be used for the occupants of a motor vehicle not in-transport, but only if they become separated from the not in- transport vehicle [see code "71" (Motor vehicle not in transport)].

EXTERIOR VEHICLE FORM

EV05
EV13
(11)

Variable Name: 1st C.D.C. - Object Contacted (cont'd.)
2nd C.D.C. - Object Contacted (cont'd.)

Code "75" (Vehicle occupant) is used when the object contacted was any person who was an occupant of a motor vehicle in-transport; two examples follow. Use this code for an occupant who falls from a vehicle and is subsequently run over before stabilization occurred. In addition, use this code for any motorcyclist who separates from his/her motorcycle during impact and subsequently impacts a motor vehicle before stabilization occurred.

Code "76" (Animal) is used if the object contacted was an animal (stationary or nonstationary). Where a nonmotorist was associated with the animal (i.e., on the animal, or on or in an animal powered nonmotor vehicle transport device) use the following scheme. If the contact is to:

- o (1) the animal; the animal and the person; the animal and the conveyance; or the animal, conveyance, and the person; code "76" (Animal);
- o (2) the conveyance, or to the person, or to both the conveyance and the person, code "74" (Other nonmotorist or conveyance).

Code "77" (Train) refers to any railway train, moving or not moving.

Code "78" (Trailer, disconnected in transport) is used when the vehicle is contacted by or contacts a trailer which has become detached from its towing unit while the towing unit was in-transport. The type of trailer is not of interest; the only factors to consider are the detachment of the trailer and the transport status of the towing unit.

Code "88" (Other nonfixed object) refers to any moveable object that is either readily moveable or is moving and is not specifically named above. Examples include trash cans, grocery carts, unoccupied pedalcycles, small boulders, etc.

Code "98" (Other event) is used when an event occurs which cannot be classified using one of the existing codes or definitions. A complete description should be given as well as describing the event on the Case Summary Form.

Code "99" (Unknown event or object) is used whenever the object contacted is not known or if an unknown event which occurs and the researcher cannot determine what the event consisted of and how to code it.

EV05
EV13
(12)

Variable Name: 1st C.D.C. - Object Contacted (cont'd.)
2nd C.D.C. - Object Contacted (cont'd.)

<p>SYSTEM</p>	<p>C1 Steel Drum</p>	<p>C2 Hi-Dri Cell Sandwich</p>
<p>BARRIER DESCRIPTION</p>	<p>55 gallon tight head drum arranged in regular clusters. Fender panels or "fish scales" fastened to sides for side impact redirection. 3/4" cable used to secure drums for side impacts. "U" bolt nuts used to ensure uniform sliding of drum.</p>	<p>6" diameter, polyvinyl chloride plastic cells filled with water. Fender panels ("fish scales") are provided for redirection.</p>

<p>SYSTEM</p>	<p>C3 Fish Inertial Barrier</p>	<p>C4 Energitic Inertial Barrier</p>
<p>BARRIER DESCRIPTION</p>	<p>Specialty manufactured plastic containers (36" in diameter and height) filled with sand. Standard weights are 200, 400, 700, 1400 and 2100 lb. Volume and density of sand may vary.</p>	<p>Specialty manufactured plastic containers filled with sand. Standard size of container is 36" diameter top, 32" diameter base and 35 3/8" height. Standard weights of modules are 200, 400, 700 and 1400 lb.</p>

<p>SYSTEM</p>	<p>C5 Hi-Dri Cell Cluster</p>	<p>C6 Hi-Dri Cell Cluster</p>
<p>BARRIER DESCRIPTION</p>	<p>Half-cell cartridges are arranged in a cluster along with fender panels. Fish scales to provide capabilities for head-on and side impacts.</p>	<p>6" diameter, polyvinyl chloride plastic cells arranged in a cluster and filled with water.</p>

EV05
EV13
(13)

Variable Name: 1st C.D.C. - Object Contacted (cont'd.)
2nd C.D.C. - Object Contacted (cont'd.)

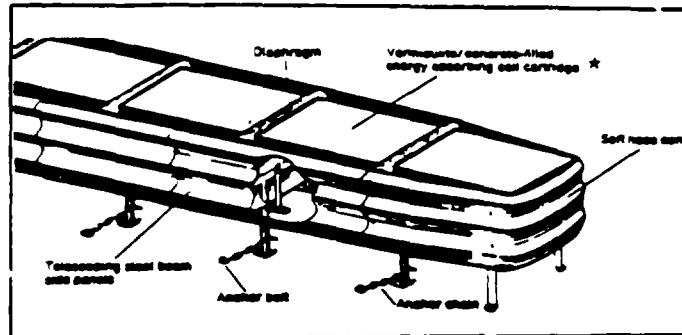

SYSTEM	Guard Rail Energy Absorbing Terminal (G.R.E.A.T.)
BARRIER DESCRIPTION	Maximum width at the bottom: 20" Minimum width at the bottom: 17" 21" with end carriage. Weight: 2,200 lbs. (typical 8-lane unit) Length: 17 to 20' (4 lanes to 10 lanes)

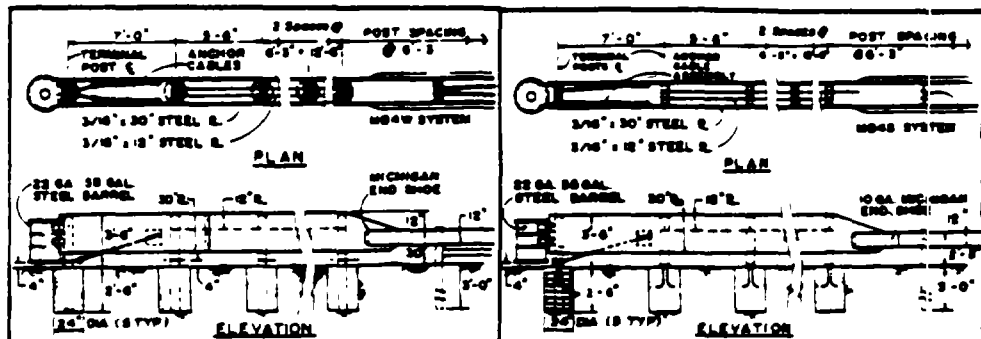

SYSTEM	Section Barrier Broomway Cable Terminal (Model 1000)	Section Barrier Broomway Cable Terminal (Model 1000)
BARRIER DESCRIPTION	TYPICAL POST - 6"Ø Double Flt; TERMINAL POST - 6"Ø Southern Pine with 2 3/8" diameter hole drilled through neutral axis. ANCHORAGE - Cable assembly (see sketch). FOOTING - 24" diameter, 30" deep concrete for terminal posts, other posts require none. TYPICAL RAIL - 12 GA. 1" section, 12 GA. TERMINAL RAIL - 3/16" x 3/8" steel plate; OFFSET BRACKETS - 6"Ø Southern Pine block.	TYPICAL POST - 4x6 5 steel; TERMINAL POST - 736"Ø x 10 1875" (see) broomway design. ANCHORAGE - Cable assembly (see sketch). FOOTING - 24" diameter, 30" deep concrete for terminal posts, other posts require none. TYPICAL RAIL - 12 GA. 1" section, 12 GA. TERMINAL RAIL - 3/16" x 3/8" steel plate; OFFSET BRACKETS - 6"Ø steel blocks.

* The cartridge may also be filled with Hex-Foam which is a matrix of hex-shaped cardboard honeycomb filled with polyurethane foam. The cardboard is stacked in one-inch layers in a cross-hatched fashion.

EV05
EV13
(14)

Variable Name: 1st C.D.C. - Object Contacted (cont'd.)
2nd C.D.C. - Object Contacted (cont'd.)

Bridge Components

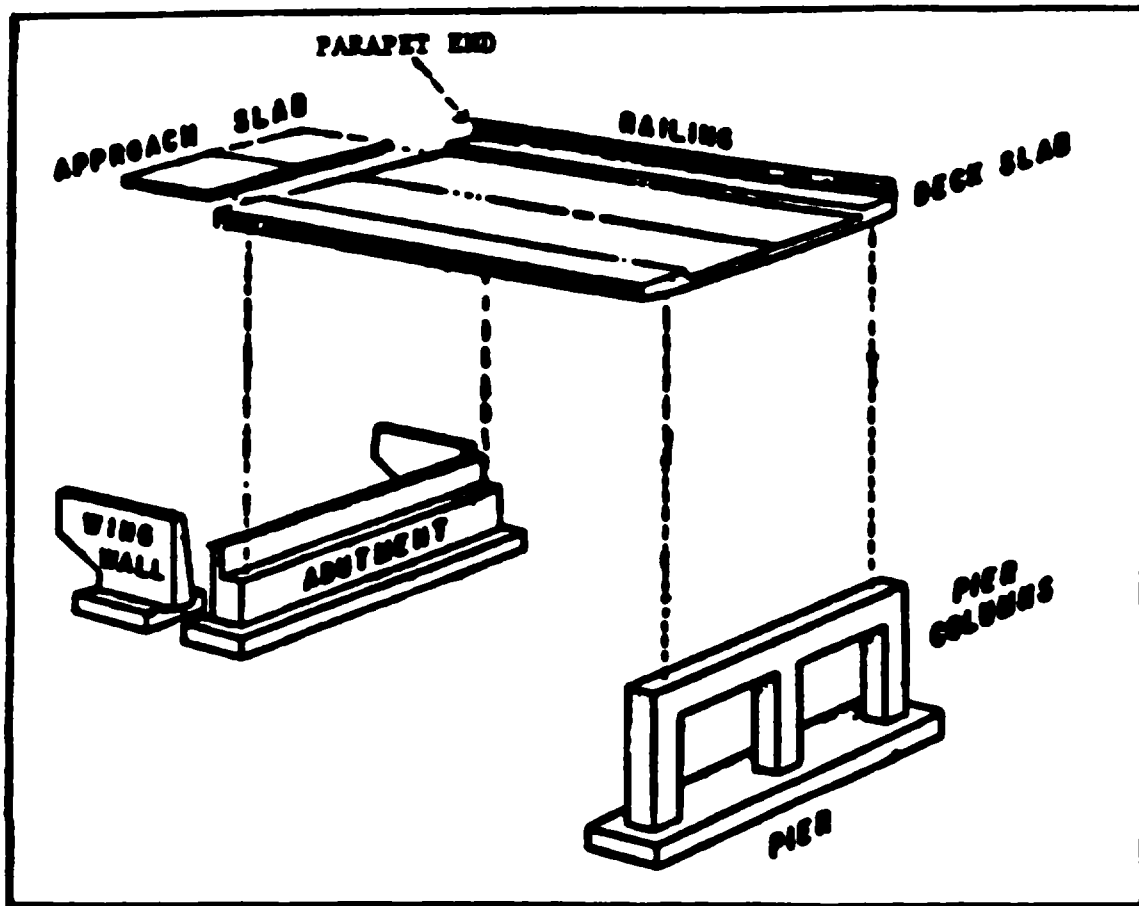

* Individual components of a bridge collectively become the bridge.

CDC RELATED REMARKSDirect Damage

The CDC generated for a particular impact is based upon damage resulting from direct contact only; it does not include induced damage. All CDCs are based entirely upon the procedures in SAE J224 MAR80.

No CDCs may be entered in variables EV06-EV11 and/or EV14-EV19 unless those CDCs are known in their entirety (i.e., "documented" CDCs). Partial CDCs, such as 99-F9EN-99, may be entered on the CDC WORKSHEET (Page 3 of the Exterior Vehicle Form), but are not applicable for coding in the CDC variables [i.e., a partial CDC is coded as an unknown CDC (99-9999-99) in variables EV06-EV11 and/or EV14-EV19]. Only those CDCs which are fully documented or unknown (i.e., 99-9999-99) are applicable for coding in the automated file (i.e., EV06-EV11 and EV14-EV19). Events which are outside the scope of CDC are not listed on the Exterior Vehicle Form in variables EV04-EV19. These events include: fire, intraunit damage caused by cargo shift, noncollision injury, etc.

Intraunit Damage

Intraunit direct damage caused by a jackknife can generate a CDC for the power (i.e., towing) unit only. The towed unit (if towed by a fixed linkage) is considered cargo, and even if that unit is another vehicle, a CDC is not applicable for any damage it may sustain. If the impact is to the cargo unit only and induced damage is incurred by the power unit, no CDC is generated for the induced damage to the power unit. If a trailer disconnects and subsequently causes direct damage to the power unit, then no CDC is generated for that damage because code "34" (Other intraunit damage) cannot be coded for Object Contacted, EV05/EV13. If, during an impact, cargo located in the trailing unit or in the bed of a pickup truck causes direct damage to the power unit or pickup truck respectively, then no CDC is generated for that damage. When intraunit direct damage caused by a jackknife exists, an Accident Event Sequence Number, EV04/EV12, is assigned and the Object Contacted, EV05/EV13, is equal to the Vehicle Number, EV03.

Add-on Components

Add-on components (e.g., snow plow blade, pickup cap, etc.) are considered cargo, and a CDC is not generated for direct damage sustained by the add-on component.

Overlapping Damage

During some accident sequences, a vehicle will sustain "overlapping damage" (i.e., multiple impacts in the same area of the vehicle). If the direct damage caused by each object contacted cannot be separated and described with individual CDCs, then one CDC is generated to describe all of the damage and this CDC is encoded in variables EV06-EV11.

EV06-EV11
EV14-EV19
(2)**CDC RELATED REMARKS**

Next, researchers must choose the object which caused most of the damage and enter: (1) the object's element number (i.e., "01"- "88") in variable EV05, 1st C.D.C. - Object Contacted, and (2) the event number in variable EV04, 1st C.D.C. - Accident Event Sequence Number. Finally, the object which caused the second greatest amount of damage is encoded in variable EV13, 2nd C.D.C. - Object Contacted; its event sequence number is encoded in EV12, 2nd C.D.C. - Accident Event Sequence Number, and an unknown CDC (99-9999-99) is entered in variables EV14-EV19.

Verbal Descriptions

Verbal descriptions by drivers, occupants, or owners may not form the basis for a CDC except in pedestrian accidents or very minor accidents (no residual damage); the vehicle must have been inspected. In cases involving no residual damage and where the vehicle is involved with another vehicle or object, that other vehicle or object must be inspected.

Additional Information

Refer to the document entitled: "Collision Deformation Classification/Truck Deformation Classification Advanced Reference Module", for more detailed discussions regarding CDC guidelines.

Single Impact/Event

If the vehicle sustained only one impact/event, the corresponding CDC (i.e., documented or unknown) is entered in EV06-EV11 and variables EV12-EV19 are left "Blank".

Multiple Impacts/Events

If the vehicle is involved in multiple impacts/events, the corresponding CDCs are ranked in order of highest delta V [i.e., greatest change in velocity experienced by the occupant(s) in the vehicle is usually the "most severe" impact]. If the CRASH program is applicable for every impact, the resultant delta Vs determine the CDC ranking. If CRASH is not applicable for every impact sustained by the vehicle, the CDC ranking must still reflect the greatest change in velocity as determined by the researcher.

All entries selected for coding in variables EV06-EV11 and EV14-EV19 must have encoded a corresponding event sequence number (EV04 and EV12) and object contacted (EV05 and EV13).

Variable Name: 1st C.D.C. - Direction of Force
2nd C.D.C. - Direction of Force

Element Values:

Range: Blank, 00-12, 20-32, 40-52, 60-72, 80-92, 99

Blank No C.D.C.

00 Nonhorizontal force	07 7 o'clock
01 1 o'clock	08 8 o'clock
02 2 o'clock	09 9 o'clock
03 3 o'clock	10 10 o'clock
04 4 o'clock	11 11 o'clock
05 5 o'clock	12 12 o'clock
06 6 o'clock	99 Unknown

Incremental Values for Above Force Directions

00 No shift
20 End shift vertical--up; top shift--forward
40 End shift vertical--down; top shift--rearward
60 End or top shift lateral--right
80 End or top shift lateral--left

Source: Restricted to vehicle inspection or photographs.

Remarks:

Code the principal direction of force incremented to indicate: (1) vertical or lateral shifting of vehicle basic end structures which occurred during horizontal force application, or (2) longitudinal or lateral shifting to the top structure resulting from nonhorizontal force application to the top. In other words, the combined value (Direction of Force + Incremental Value of Shift) is coded under this variable.

Code "00" (Nonhorizontal) (plus any Incremental Value of Shift for a top structure impact) any time a vehicle becomes inverted and impacts any object or vehicle while inverted. In addition, use this code in any other circumstance which is consistent with the directions contained in SAE J224 MAR80.

An estimated CDC is indicated for each impact (Page 3, Exterior Vehicle Form). In this estimate, write the direction of principal force in increments of ten degrees rather than in clock positions. Thus, if the direction appeared to be approximately ten degrees to the right of straight-ahead, indicate "010". If the direction of force appeared to be ten degrees left of straight-ahead, indicate "-010" (or "350"). The final coding of the CDC on Page 4 (Exterior Vehicle Form) reflects the direction of force in clock positions. For example if the principal direction of force (PDOF) is closest to ten degrees to the right of straight-ahead, "010" ["-005" ("355") to "025"], then the estimated Direction of Force is coded according to the clock direction--either "12" or "01" as determined by examining all available inputs to ensure accuracy for

EV06
EV14
(2)

Variable Name: 1st C.D.C. - Direction of Force (cont'd.)
2nd C.D.C. - Direction of Force (cont'd.)

force assignments. If, upon examining all the available inputs, the researcher believes the PDOF is more likely to be within +015 to +025 and classifies the clock direction (EV06 or EV14) as "01", then Page 3 (Direction of Force) still reflects the original value: "010".

When occasional differences which seem to be inconsistent (e.g., PDOF = 010° and clock position = 01) are encountered, they actually reflect the investigative method; therefore, reconcile the differences by reviewing the entire case and any CRASH output to determine if the difference is reasonable. This procedure allows the zone center reviewer to appreciate what the researcher thought the PDOF (Page 3) was, to the closest 10 degrees, based upon examination of that vehicle alone, while the clock position representing the force on Page 4 reflects the final determination after examining all sources (vehicles, objects contacted, scene evidence, CRASH program, etc.). In other words, it is not necessary for the force directions on Page 4 and the PDOFs on Page 3 to be compatible. However, any force direction on the final CRASH output must be compatible with the force direction coded in variable EV06 or EV14.

Refer to the document entitled: "Collision Deformation Classification Training Program: Intermediate Level - Training/Reference Module", for detailed definitions of the element values as well as instruction on proper usage. This document is based upon SAE J224 MAR80.

See the discussion in CDC Related Remarks (EV06-EV11, EV14-EV19) for coding clarifications and procedures.

Code "Blank" (No event or not CDC applicable) is used when there is not an event or when an event exists but is not CDC applicable.

Variable Name: 1st C.D.C. - Deformation Location
2nd C.D.C. - Deformation Location

Element Values:

Blank No C.D.C.
F Front
R Right side
L Left side
B Back (rear)
T Top
U Undercarriage
9 Unknown

Source: Restricted to vehicle inspection or photographs.

Remarks:

Refer to the document entitled: "Collision Deformation Classification Training Program: Intermediate Level - Training/Reference Module", for detailed definitions of the element values as well as instruction on proper usage. This document is based upon SAE J224 MAR80.

See the discussion in CDC Related Remarks (EV06-EV11, EV14-EV19) for coding clarifications and procedures.

Code "Blank" (No C.D.C.) is used when there is not an event or when an event exists but is not CDC applicable.

Variable Name: 1st C.D.C. - Specific Longitudinal or Lateral Location
2nd C.D.C. - Specific Longitudinal or Lateral Location

Element Values:

Blank No C.D.C.

Horizontal Impacts

D Distributed--side or end
L Left--front or rear
C Center--front or rear
R Right--front or rear
F Side front--left or right
P Side center section--L or R
B Side rear--left or right
Y Side (F + P) or end (L + C)
Z Side (P + B) or end (C + R)
9 Unknown

Top or Undercarriage

D Distributed (F+P+B)
F Front Section
P Center Section
B Rear Section
Y F+P
Z P+B
9 Unknown

Source: Restricted to vehicle inspection or photographs.

Remarks:

Element values "F", "P", "B", "Y", "Z", and "D" must be used for vehicles with top or undercarriage deformation ("T" or "U" in variable EV07 and/or EV15).

Refer to the document entitled: "Collision Deformation Classification Training Program: Intermediate Level - Training/Reference Module", for detailed definitions of the element values as well as instruction on proper usage. This document is based upon SAE J224 MAR80.

See the discussion in CDC Related Remarks (EV06-EV11, EV14-EV19) for coding clarifications and procedures.

Code "Blank" (No C.D.C.) is used when there is not an event or when an event exists but is not CDC applicable.

Variable Name: 1st C.D.C. - Specific Vertical or Lateral Location
2nd C.D.C. - Specific Vertical or Lateral Location

Element Values:

Blank No C.D.C.

CDC (Vertical - Front, Rear, or Side Impacts)

A All
H Top of frame to top
E Everything below belt line
G Belt line and above
M Middle--top of frame to belt line or hood
L Frame--top of frame, frame, bottom of frame (including undercarriage)
W Below undercarriage level (wheels and tires only)
9 Unknown

CDC (Lateral - Top and Undercarriage Impacts)

D Distributed
L Left
C Center
R Right
Y Left and Center (L + C)
Z Right and Center (R + C)
9 Unknown

Source: Restricted to vehicle inspection or photographs.

Remarks:

Refer to the document entitled: "Collision Deformation Classification Training Program: Intermediate Level - Training/Reference Module", for detailed definitions of the element values as well as instruction on proper usage. This document is based upon SAE J224 MAR80.

See the discussion in CDC Related Remarks (EV06-EV11, EV14-EV19) for coding clarifications and procedures.

Code "Blank" (No C.D.C.) is used when there is not an event or when an event exists but is not CDC applicable.

Variable Name: 1st C.D.C. - Type of Damage Distribution
2nd C.D.C. - Type of Damage Distribution

Element Values:

Blank No C.D.C.
W Wide impact area
N Narrow impact area
S Sideswipe
O Rollover (includes side)
A Overhanging structure
E Corner
K Conversion in impact type
U No residual deformation
9 Unknown

Source: Restricted to vehicle inspection or photographs.

Remarks:

Refer to the document entitled: "Collision Deformation Classification Training Program: Intermediate Level - Training/Reference Module", for detailed definitions of the element values as well as instruction on proper usage. This document is based upon SAE J224 MAR80.

See the discussion in CDC Related Remarks (EV06-EV11, EV14-EV19) for coding clarifications and procedures.

Code "Blank" (No C.D.C.) is used when there is not an event or when an event exists but is not CDC applicable.

Note: When recording a "K" conversion impact type on the Exterior Vehicle form, page 4, variables EV04-EV19 (Highest and Second Highest Delta V), follow the procedures below:

1. The "K" conversion is the only impact -- Code the first half of the "K" conversion in variables EV04-EV11 (highest delta V); and code the second half of the "K" conversion in variables EV12-EV19 (second highest delta V).
2. There are two or more impacts including a "K" conversion. The "K" conversion is the Highest or Second Highest Delta V. -- Code only the first half of the "K" conversion as the highest or second highest delta V (which-so-ever is appropriate). The other CDC row is coded with the appropriate highest or second highest delta V.

Variable Name: 1st C.D.C. - Deformation Extent Guide
2nd C.D.C. - Deformation Extent Guide

Element Values:

	Blank	No C.D.C.
01	One	
02	Two	
03	Three	
04	Four	
05	Five	
06	Six	
07	Seven	
08	Eight	
09	Nine	
99	Unknown	

Source: Restricted to vehicle inspection or photographs.

Remarks:

Extent zone is coded from direct damage only, even when a body panel is torn loose from the vehicle frame due to impact; consider body panels torn loose from the frame as not representative of residual crush.

Refer to the document entitled: "Collision Deformation Classification Training Program: Intermediate Level - Training/Reference Module", for detailed definitions of the element values as well as instruction on proper usage. This document is based upon SAE J224 MAR80.

See the discussion in CDC Related Remarks (EV06-EV11, EV14-EV19) for coding clarifications and procedures.

Code "Blank" (No C.D.C.) is used when there is not an event or when an event exists but is not CDC applicable.

CRUSH PROFILE OVERVIEW

For the section entitled "Crush Profile", code the CDC associated damage dimensions for the Highest Delta "V" CDC (EV4-EV11) and the Second Highest Delta "V" (EV12-EV19). The encoded "L", "C"s and "D" values must be the actual data set used in the reconstruction program (i.e., CRASH or OLDMIS).

If the damage measurements are known, code the appropriate measurements to the nearest inch regardless of whether a reconstruction algorithm was completed. If only two or four C-values are collected (rare occasions), then leave the remaining C-value fields blank.

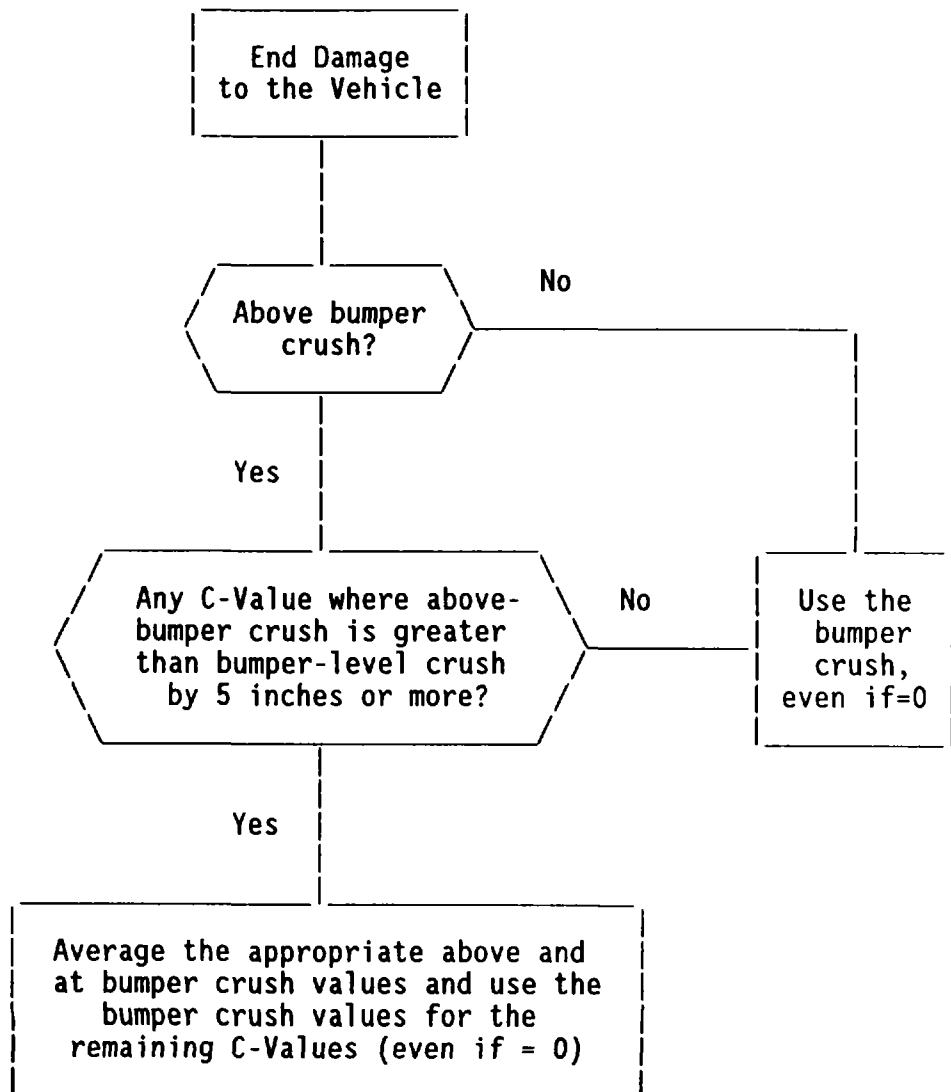
END DAMAGE MEASUREMENT PROTOCOL

CRUSH PROFILE OVERVIEW

SIDE PLANE DAMAGE MEASUREMENT PROTOCOL

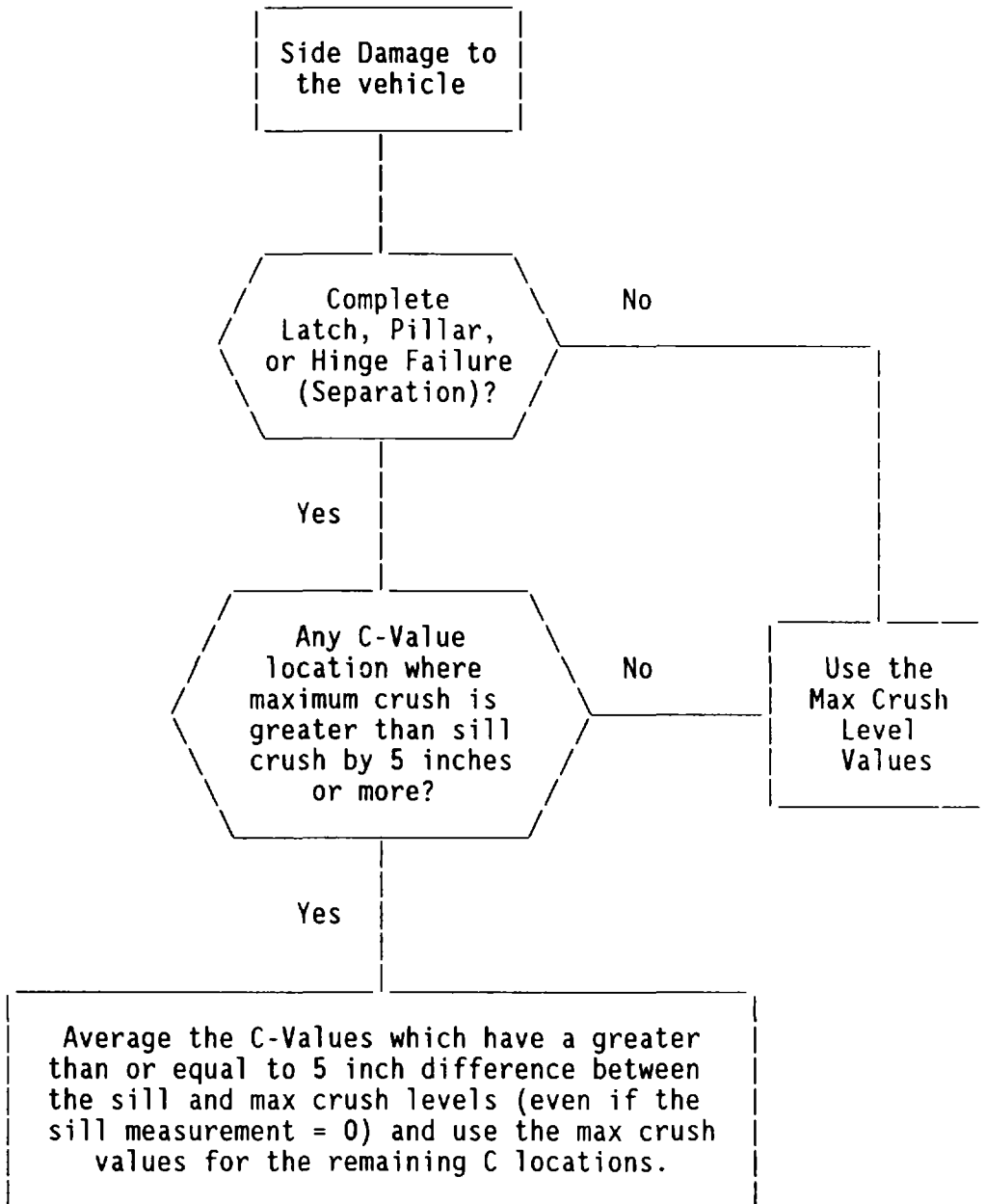

Variable Name: 1st Crush Profile - L
2nd Crush Profile - L

Element Values:

Range: 001 through 250 inches, Blank

Code measured value to the nearest inch.
Blank No crush profile for most severe impact(s)

Source: Vehicle inspection

Remarks:

These variables are the "L" dimensions normally used in the CRASH3 (or OLDMIS) input for the highest (EV04-EV11) and second highest (EV12-EV19) delta V impacts sustained by the vehicle. The damage measurements associated with one of these CDCs may be encoded regardless of the use of a reconstruction program (e.g., when the assumptions of the reconstruction program are not valid).

Code "Blank" [No crush profile for most severe impact(s)] when a reconstruction program is used but no value is entered into the reconstruction program or the measurement is unknown (i.e., CDC only run or OLDMISS where this vehicle's data are missing).

Variable Name: 1st Crush Profile - C1-C6
2nd Crush Profile - C1-C6

Element Values:

Range: 00 through 99, Blank

Code measured value to the nearest inch.

Blank No crush profile for most severe impact(s)

99 99 inches or greater

Source: Vehicle inspection

Remarks:

The damage measurements associated with a priority (i.e., 1st or 2nd highest) CDC are coded regardless of the use of a reconstruction program. Code the obtained C-values for each impact (highest two delta V impacts) to the nearest inch in the space provided.

If a reconstruction program is used, the encoded values of "C" (i.e., C1, C2, C3, C4, C5, and C6) must be the same as the C-values used in the reconstruction program, and they may differ from C-measurements made in the field (e.g., averaged measurements for override).

Code "Blank" [No crush profile for most severe impact(s)] when a reconstruction program is used but no value is entered into the reconstruction program or the measurements are unknown (i.e., CDC only run or OLDMISS where this vehicle's data are missing).

Code "99" if there is 99 or more inches of crush.

Variable Name: 1st Crush Profile - D
2nd Crush Profile - D

Element Values:

Range: -120 to -001, _000, +001 to +120 inches, Blank

Code measured value to the nearest inch.

Blank No crush profile for most severe impact(s)

_000 Greater than -0.5 and less than +0.5

Source: Vehicle inspection

Remarks:

The damage measurement associated with a priority (i.e., 1st or 2nd highest) CDC is coded regardless of the use of a reconstruction program. Encode the measurement normally used in the computer program.

Code "_000" if the measured or calculated "D" value for the particular crush profile is "0" (i.e., greater than -0.5 and less than +0.5) inches; otherwise, code the value to the nearest inch.

Code "Blank" [No crush profile for most severe impact(s)] when a reconstruction program is used but no value is entered into the reconstruction program or the measurement is unknown (i.e., CDC only run or OLDMISS where this vehicle's data are missing).

Variable Name: Are CDCs Documented but Not Coded on the Automated File?

Element Values:

0 No
1 Yes

Remarks:

A CDC must be known in its entirety to be considered "documented". An unknown (i.e., 99-9999-99) CDC is not a "documented" CDC, nor is a partial CDC (e.g., 12-F9EN-99).

Code "1" (Yes) if any "documented" CDC is written on the "CDC Worksheet" (Page 3 of the Exterior Vehicle Form), and it is not coded in variables EV06-EV11 or EV14-EV19 (Collision Deformation Classification); otherwise, code this variable "0" (No).

Variable Name: Researcher's Assessment of Vehicle Disposition

Element Values:

- 0 Not towed due to vehicle damage
- 1 Towed due to vehicle damage
- 9 Unknown

Source: Primary source is the vehicle; secondary source is interviewee(s).

Remarks:

Whereas variable GV09, Police Reported Vehicle Disposition, reports this vehicle's manner of leaving the scene based solely on the police report data, determine this variable (EV27) based on vehicle inspection (which is supplemented by interview data for a repaired vehicle).

"Towing" is defined identically to the definition in variable GV09 (i.e., towing must be a result of event-related disabling damage; towing must occur directly from the scene, etc.). A gray area exists, however, when attempting to define the term "disabling damage".

A police officer may categorize damage such as broken headlights, broken taillights, flat or restricted tires, etc., as "disabling", when, in fact, the vehicle is capable of being driven from the scene. Therefore, when the PAR indicates it was towed due to damage, use the following guideline.

Determine the severity of the damage during the vehicle's inspection. Code "0" (Not towed due to vehicle damage) if the damage is "minor" (i.e., minor mechanical repairs could have been completed at the scene). "Minor mechanical repairs" refers to items such as: replacing headlights or taillights, changing tires, pulling sheet metal away which may be restricting a wheel, etc.

NOTE: These repairs need not have been completed at the scene. They are merely examples of situations which do not require the vehicle to be categorized "disabled" for the NASS CDS study.

Code this variable independently of variable GV09, Police Reported Vehicle Disposition. The tow status reported here is determined primarily during vehicle inspection; however, if the vehicle was repaired, then code this variable based on input from an interviewee. Under no circumstance should the PAR be used as a source for coding this variable.

Annotate the reason for the encoded choice in the blank space at the bottom of Page 4 of the Exterior Vehicle Form. For example, a researcher selects code "0" (Not towed due to vehicle damage) and provides the following annotation: "The vehicle received only broken headlights in the collision; police required that the vehicle be towed".

Code "0" (Not towed due to vehicle damage) when the vehicle was driven from the scene, or when the vehicle was unnecessarily towed from the scene (i.e., could have been driven).

Variable Name: Researcher's Assessment of Vehicle Disposition (cont'd.)

Code "1" (Towed due to vehicle damage) when the vehicle sustained damage from the accident such that towing was required.

Code "9" (Unknown) when:

- o the vehicle was towed from the scene but the reason for the towing cannot be determined, or
- o the disposition of the vehicle from the scene cannot be determined.

Variable Name: Original Wheelbase

Element Values:

Range: 0400-2500, 9999

Code to the nearest tenth of inch.

2500 250 inches or more

9999 Unknown

Source: Primary and secondary source materials are listed in variable GV19, Vehicle Curb Weight.

Remarks:

The wheelbase dimension is obtained from source materials and not from vehicle measurements. This dimension is encoded to the nearest tenth of an inch.

Code "9999" (Unknown) is used when this vehicle's original specification is not available.

Variable Name: Is This a Multi-Stage Manufactured Vehicle And/Or
A Certified Altered Vehicle?

Element Values:

- 0 No post manufacturer modifications
- 1 Yes - post manufacturer modifications (specify)
(Include photograph of CERTIFICATION PLACARD in case report)
- 9 Unknown if vehicle is modified

Source: Vehicle Inspection

Remarks:

Under the "Code of Federal Regulations, Title 49 - Transportation" Chapter V Part 567, Sections 567.5 and 567.7, a label certifying compliance with all Federal Motor Vehicle Safety Standards must be affixed to a multi-stage manufactured vehicle or altered (post manufactured) vehicle.

A multi-stage manufactured vehicle will generally begin as a chassis-cab (incomplete vehicle) and subsequently end up in final-stage as a pickup based utility truck (dump truck, flat bed, stake body, tow truck, etc.) or a van derivative (i.e., van conversion, Hi-cube, motor home, etc.).

Altered vehicles will generally involve a major modification of basic components such as suspension, frame, power plants, etc., with work generally performed by a recognized auto body shop. The lengthening of a standard automobile chassis to create a limousine would be one example of the type of alteration which would qualify for certification.

To determine if the vehicle qualifies, locate the certification label which should include one of the following statements:

Multi-stage vehicle

- o Incomplete manufactured vehicle (chassis-cab) certification label should include the statement: "CHASSIS-CAB MANUFACTURED BY" or "CHASSIS-CAB MFD BY".
- o Intermediate manufactured vehicle certification label should have the following statement: "INTERMEDIATE MANUFACTURED BY" or "INTERMEDIATE MFD BY".
- o Final manufactured vehicle certification label should have the following statements: "MANUFACTURED BY" or "MFD BY" and "INCOMPLETE VEHICLE MANUFACTURED BY" or "INC VEH MFD BY".

Alted vehicle

- o An altered vehicle certification label should include the statement: "This vehicle was altered by (individual or corporate name) in (month and year in which alterations were completed) and as altered it conforms to all applicable Federal Motor Vehicle Safety Standards affected by the alteration and in effect in (month, year)."

Variable Name: Is This a Multi-Stage Manufactured Vehicle And/Or
A Certified Altered Vehicle? (cont'd.)

These labels are generally affixed in one of the following areas on the driver's side of the vehicle:

- o hinge pillar
- o door-latch post
- o door edge that meets the door-latch post
- o left side of the instrument panel
- o inward-facing surface of driver's door

Code "0" (No post manufacturer modifications) is used when this vehicle was a full-line manufactured vehicle. Full-line is interpreted as a vehicle that is completely assembled at the end of a plant assembly line of its original manufacturer. This would include vehicles which only require cosmetic additions such as additional paint, mirrors, wheels, etc., to be customer ready!

Code "1" (Yes - post manufacturer modifications) is used for multi-stage vehicles and/or altered certified vehicles. This includes vehicles which were in various stages of completion (i.e., incomplete, intermediate, final).

Vehicles that are altered via "backyard modification (i.e., addition of air shocks, spring spacers, cosmetic alteration including sheet metal and paint, etc.) are not identified as altered certified vehicles. Only those businesses which specialize in vehicle alterations (i.e., limo body shops, etc.) where a label of alteration is required by federal regulations and is present on the vehicle are identified in this element.

A slide (photo) of the certification label(s) is essential and must be included with the case. Refer to the following illustrations for examples of certifying labels.

MPD. BY: Crescent Cruiser Co.	
DATE OF MFR:	10/88
INC. VEH. MFD. BY: Ford Motor Co.	
DATE OF INC. MFR:	9/88
G.V.W.R.	8100 LBS.
G.A.W.R. FRONT	3095 WITH 225/75R15
TIRES	15X7 0 RIMS AT
	35 PSI COLD SINGLE
REAR	3406 WITH 225/75R15
TIRES	15X7 0 RIMS AT
	35 PSI COLD
THIS VEHICLE CONFORMS TO ALL APPLICABLE FEDERAL MOTOR VEHICLE SAFETY STANDARDS	
IN EFFECT IN:	9/88
V.J.N	
TYPE:	MPV

INCOMPLETE VEHICLE MANUFACTURED BY FORD MOTOR COMPANY MADE IN THE U.S.A.			
DATE: 02/80	GVWR: 8100LB/2786KG		
FRONT GAWR: 3095LB	WITH	REAR GAWR: 3406LB	WITH
1403KG		1644KG	
P225/75R16SL	TIRES	P225/75R16SL	TIRES
15X8 OJK	RIMS	15X8 OJK	RIMS
AT 35 PSI COLD		AT 35 PSI COLD	
			
MJ			08
EXTERIOR PAINT COLOR			
138	E142	D8	T 19 44P
FOTA -1604A10 EA			

Variable Name: Is This a Multi-Stage Manufactured Vehicle And/Or
A Certified Altered Vehicle? (cont'd.)

Code "9" (Unknown) is used in the following situations.

- o The vehicle fits the description of a multi-stage or altered vehicle, but the researcher was not able to view the label(s) for positive identification.
- o The label(s) was removed/destroyed so a clear determination of whether the vehicle was a certified multi-stage or altered vehicle could not be made.

Variable Name: Fire Occurrence

Element Values:

0 No fire

Yes, fire occurred

1 Minor

2 Major

9 Unknown

Source: Vehicle Inspection

Remarks:

In order to classify fire damage, the fire must have occurred as the result of this vehicle impacting with another vehicle or object. Fires which begin from noncollision events (e.g., electrical short circuit, fuel leakage, etc.) are excluded from consideration.

Code "0" (No fire) is used when no fire occurred or a fire did not initiate during an accident.

Code "1" (Minor) is a general term used to describe the degree of fire involvement and is used in the following situations:

- o Engine compartment only fire
- o Trunk compartment only fire
- o Partial passenger compartment only fire
- o Undercarriage only fire
- o Tire(s) only fire

Code "2" (Major) identifies those situations where the vehicle experienced a greater fire involvement than defined under Code "1" above and is used in the following situations:

- o Combined engine and passenger compartment fire (either partial or total passenger compartment involvement).
- o Total passenger compartment fire.
- o Combined trunk and passenger compartment fire (either partial or total passenger compartment involvement).
- o Combined undercarriage and passenger compartment (either partial or total passenger compartment involvement).
- o Combined tire(s) and passenger compartment (either partial or total passenger compartment involvement).

Variable Name: Fire Occurrence (cont'd.)

Code "9" (Unknown) is used in the following situations:

- o It cannot be determined if fire resulted from an impact.
- o The extent of fire damage could not be determined due to missing components or a "clandestine" vehicle inspection.

Variable Name: Origin of Fire

Element Values:

- 0 No fire
- 1 Vehicle exterior (front, side, back, top)
- 2 Exhaust system
- 3 Fuel tank (and other fuel retention system parts)
- 4 Engine compartment
- 5 Cargo/trunk compartment
- 6 Instrument panel
- 7 Passenger compartment area
- 8 Other location (specify):
- 9 Unknown

Source: Vehicle Inspection

Remarks:

This variable identifies the location of fire initiation and should not be confused with magnitude of fire. As an example, if the vehicle appeared totally "burnt", code "7" (Passenger compartment area) would not necessarily be used unless the fire began in the vehicle's interior.

For many fires it will be difficult to determine fire origin especially when the entire vehicle was involved. The researcher should look for "hot" spots which generally appear lighter in coloration and are often accompanied by warped or melted metal.

If multiple fires occur to the same vehicle, choose the fire that started within this vehicle (i.e., choose an interior fire over an exterior fire), then choose the fire with the greater severity.

Code "0" (No fire) is used for vehicles where a fire did not occur as the result of a collision.

Code "1" [Vehicle exterior (front, side, back, top)] identifies fire source as occurring external to the vehicle. This generally occurs in a multiple vehicle collision where another vehicle initiates the fire and the fire is then introduced to this vehicle.

Code "2" (Exhaust system) is used when components of the exhaust system initiated the fire. Components of the exhaust system include: "exhaust" pipes, muffler/resonator, and catalytic converter.

Code "3" [Fuel tank (and other fuel retention system parts)] includes: the fuel tank(s), fuel supply and vent lines, and tank filler neck.

Code "4" (Engine compartment) is used when the fire initiates in the area (open or enclosed) which houses the engine. Generally, most engine compartments are located at the front end of the vehicle under the hood. However, some engines are mounted midway (referred to as mid-engine) on the chassis, and some are located at the rear of the vehicle.

Variable Name: Origin of Fire

The reason for fire initiation in these areas is inconsequential (whether fuel or electrical), but the fire's relative location to the engine is the important consideration.

Code "5" (Cargo/trunk compartment) identifies areas which are separated from the passenger compartment by a solid partition. In passenger automobiles, the partition will generally be formed by the seat back(s), package shelf, and trunk lid. However, areas designed to accommodate cargo (e.g., the area behind the second seat of a station wagon) are not considered a cargo compartment unless these areas were walled off by a solid partition. Please note, a grate fencing is not considered a solid partition. A solid partition is generally composed of a material which limits air flow between areas.

Cargo boxes on pickup trucks are generally separated from the occupant compartment by the back wall of the cab and are classified as a cargo compartment. Please note, operable windows in backlights of pickup cabs are considered part of the solid partition, regardless of opening status.

Light vans will generally not have a separate cargo compartment unless a solid wall was installed.

Code "6" (Instrument panel) is used when the fire originated under the instrument panel. The instrument panel is defined as the panel extending horizontally from A-pillar to A-pillar and vertically from the lower part of the windshield to the lowest vertical edge of the panel (refer to Figure 1 and 2 under variable IV95 for panel illustrations).

Code "7" (Passenger Compartment area) is used when the fire initiated within the designated passenger area. This includes cargo areas adjacent to seating areas which were not separated by a solid partition.

Code "8" (Other location) is used when codes "1"- "7" above do not apply and a fire was involved. Included in this code are fires occurring with wheels or brakes.

Code "9" (Unknown) is used in the following situations:

- o The vehicle was totally destroyed by fire and the origin could not be determined.
- o A combination of areas were involved but an estimate of point of origin could not be made.
- o A fire was reported, but the vehicle was repaired prior to inspection.

Variable Name: Type of Fuel Tank

Element Values:

- 0 No fuel tank (electrical vehicle)
- 1 Metallic
- 2 Non-Metallic
- 9 Unknown

Source: Vehicle Inspection

Remarks:

This variable records the composition of the fuel tank that is permanently affixed to the vehicle as an energy reservoir for the vehicle's engine. Some vehicles may be equipped with reserve fuel tanks (i.e., more than one tank hooked in series and operated by the driver). Extra fuel tanks on-board a vehicle which are not designed to supply fuel to the vehicle's engine are not considered for this variable. Some examples include: fuel cans, bottled gas, and ancillary tanks for occupational related work (i.e., construction, etc.).

Code "0" [No fuel tank (electrical vehicle)] is used when the vehicle is powered solely by electrical means. An electrical vehicle which uses a fossil fuel back-up system such as an attached fuel tank is not be considered here but is classified under codes "1", "2", or "9".

Code "1" (Metallic) is used for fuel tanks made from metal. This would include steel, aluminum (alloys), stainless, etc.

Code "2" (Non-metallic) is used for fuel tanks which are made from plastic.

Code "9" (Unknown) is be used as follows:

- o Researcher could not make a determination due to inaccessibility.
- o Vehicle was dismantled during inspection and the fuel tank(s) was not available.
- o The type of tank material could not be determined.



INTERIOR VEHICLE FORM

1. Primary Sampling Unit Number _____

2. Case Number—Stratum _____

3. Vehicle Number _____

INTEGRITY

4. Passenger Compartment Integrity _____

(00) No integrity loss

Yes, Integrity Was Lost Through

(01) Windshield

(02) Door (side)

(03) Door/hatch (back door)

(04) Roof

(05) Roof glass

(06) Side window

(07) Rear window (backlight)

(08) Roof and roof glass

(09) Windshield and door (side)

(10) Windshield and roof

(11) Side and rear window (side window and backlight)

(12) Windshield and side window

(13) Door and side window

(98) Other combination of above (specify): _____

(99) Unknown

Door, Tailgate Or Hatch Opening

5. LF _____ 6. RF _____ 7. LR _____ 8. RR _____ 9. TG/H _____

(0) No door/gate/hatch

(1) Door/gate/hatch remained closed and operational

(2) Door/gate/hatch came open during collision

(3) Door/gate/hatch jammed shut

(8) Other (specify): _____

(9) Unknown

Damage/Failure Associated with Door, Tailgate or Hatch Opening in Collision. If IVS CODE # 2, THEN CODE 8.

10. LF _____ 11. RF _____ 12. LR _____ 13. RR _____ 14. TG/H _____

(0) No door/gate/hatch or door not opened

Door, Tailgate, or Hatch Came Open During Collision

(1) Door operational (no damage)

(2) Latch/striker failure due to damage

(3) Hinge failure due to damage

(4) Door structure failure due to damage

(5) Door support (i.e., pillar, sill, roof side rail, etc.) failure due to damage

(6) Latch/striker and hinge failure due to damage

(8) Other failure (specify): _____

(9) Unknown

GLAZING

Glazing Damage from Impact Forces

15. WS _____ 16. LF _____ 17. RF _____ 18. LR _____ 19. RR _____

20. BL _____ 21. Roof _____ 22. Other _____

(0) No glazing damage from impact forces

(2) Glazing in place and cracked from impact forces

(3) Glazing in place and holed from impact forces

(4) Glazing out-of-place (cracked or not) and not holed from impact forces

(5) Glazing out-of-place and holed from impact forces

(6) Glazing disintegrated from impact forces

(7) Glazing removed prior to accident

(8) No glazing

(9) Unknown if damaged

Glazing Damage from Occupant Contact

23. WS _____ 24. LF _____ 25. RF _____ 26. LR _____ 27. RR _____

28. BL _____ 29. Roof _____ 30. Other _____

(0) No occupant contact to glazing or no glazing

(1) Glazing contacted by occupant but no glazing damage

(2) Glazing in place and cracked by occupant contact

(3) Glazing in place and holed by occupant contact

(4) Glazing out-of-place (cracked or not) by occupant contact and not holed by occupant contact

(5) Glazing out-of-place by occupant contact and holed by occupant contact

(6) Glazing disintegrated by occupant contact

(9) Unknown if contacted by occupant

If No Glazing Damage **And** No Occupant Contact or No Glazing, Then Code IV 31 Through IV 46 As 0

Type of Window/Windshield Glazing

31. WS _____ 32. LF _____ 33. RF _____ 34. LR _____ 35. RR _____

36. BL _____ 37. Roof _____ 38. Other _____

(0) No glazing contact and no damage, or no glazing

(1) AS-1 — Laminated

(2) AS-2 — Tempered

(3) AS-3 — Tempered-tinted

(4) AS-14 — Glass/Plastic

(8) Other (specify): _____

(9) Unknown

Window Pre-crash Glazing Status

39. WS _____ 40. LF _____ 41. RF _____ 42. LR _____ 43. RR _____

44. BL _____ 45. Roof _____ 46. Other _____

(0) No glazing contact and no damage, or no glazing

(1) Fixed

(2) Closed

(3) Partially opened

(4) Fully opened

(9) Unknown

INTRUSION WORK SHEET

TOP VIEW

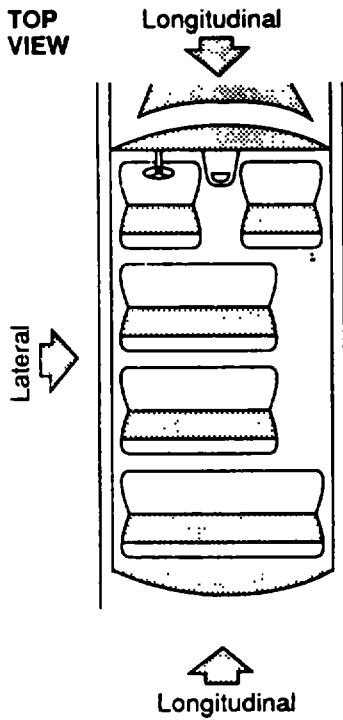

LEFT SIDE VIEW

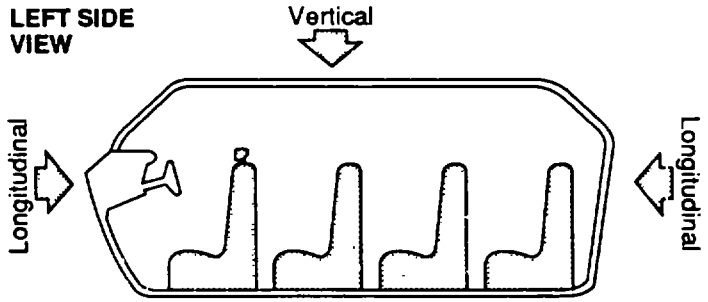

RIGHT SIDE VIEW

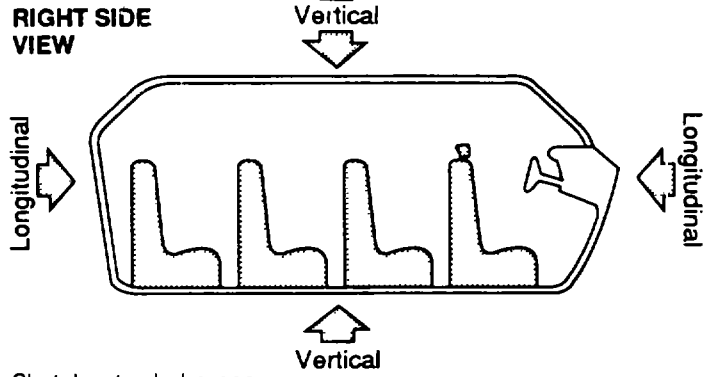

Note: Sketch intruded areas

LOCATION OF INTRUSION	INTRUDED COMPONENT	COMPARISON VALUE	INTRUDED VALUE	= INTRUSION	DOMINANT CRUSH DIRECTION
		-		=	
		-		=	
		-		=	
		-		=	
		-		=	
		-		=	
		-		=	
		-		=	
		-		=	
		-		=	
		-		=	
		-		=	
		-		=	
		-		=	
		-		=	
		-		=	
		-		=	
		-		=	

OCCUPANT AREA INTRUSION

Note: If no intrusions, leave variables IV 47-IV 86 blank.

	<u>Location of Intrusion</u>	<u>Intruding Component</u>	<u>Magnitude of Intrusion</u>	<u>Dominant Crush Direction</u>
1st	47.____	48.____	49.____	50.____
2nd	51.____	52.____	53.____	54.____
3rd	55.____	56.____	57.____	58.____
4th	59.____	60.____	61.____	62.____
5th	63.____	64.____	65.____	66.____
6th	67.____	68.____	69.____	70.____
7th	71.____	72.____	73.____	74.____
8th	75.____	76.____	77.____	78.____
9th	79.____	80.____	81.____	82.____
10th	83.____	84.____	85.____	86.____

LOCATION OF INTRUSION

- | | |
|--|---|
| Front Seat
(11) Left
(12) Middle
(13) Right | Fourth Seat
(41) Left
(42) Middle
(43) Right |
| Second Seat
(21) Left
(22) Middle
(23) Right | (97) Catastrophic
(98) Other enclosed area (specify):
_____ |
| Third Seat
(31) Left
(32) Middle
(33) Right | (99) Unknown |

INTRUDING COMPONENT

- Interior Components**
- (01) Steering assembly
 - (02) Instrument panel left
 - (03) Instrument panel center
 - (04) Instrument panel right
 - (05) Toe pan
 - (06) A-pillar
 - (07) B-pillar
 - (08) C-pillar
 - (09) D-pillar
 - (10) Door panel (side)
 - (12) Roof (or convertible top)
 - (13) Roof side rail
 - (14) Windshield
 - (15) Windshield header
 - (16) Window frame
 - (17) Floor pan (includes sill)
 - (18) Backlight header
 - (19) Front seat back
 - (20) Second seat back
 - (21) Third seat back
 - (22) Fourth seat back
 - (23) Fifth seat back
 - (24) Seat cushion
 - (25) Back door/panel (e.g., tailgate)
 - (26) Other interior component (specify):

 - (27) Side panel - forward of the A-pillar
 - (28) Side panel - rear of the A-pillar
- Exterior Components**
- (30) Hood
 - (31) Outside surface of vehicle (specify):

 - (32) Other exterior object in the environment (specify):

 - (33) Unknown exterior object
 - (97) Catastrophic
 - (98) Intrusion of unlisted component(s) (specify):

 - (99) Unknown

MAGNITUDE OF INTRUSION

- (1) ≥ 1 inch but < 3 inches
- (2) ≥ 3 inches but < 6 inches
- (3) ≥ 6 inches but < 12 inches
- (4) ≥ 12 inches but < 18 inches
- (5) ≥ 18 inches but < 24 inches
- (6) ≥ 24 inches
- (7) Catastrophic
- (9) Unknown

DOMINANT CRUSH DIRECTION

- (1) Vertical
- (2) Longitudinal
- (3) Lateral
- (7) Catastrophic
- (9) Unknown

STEERING RIM/SPOKE DEFORMATION

COMPARISON VALUE	-	DAMAGE VALUE	=	DEFORMATION
	-		=	
	-		=	
	-		=	
	-		=	

Empty area for recording data.

STEERING COLUMN

87. Steering Column Type _____
 (1) Fixed column
 (2) Tilt column
 (3) Telescoping column
 (4) Tilt and telescoping column
 (8) Other column type (specify): _____
 (9) Unknown

88. Blank X X
 (This variable is left blank so that numbering consistency can be maintained with the 1988-90 CDS.)

89. Blank X X X
 (This variable is left blank so that numbering consistency can be maintained with the 1988-90 CDS.)

90. Blank X X X
 (This variable is left blank so that numbering consistency can be maintained with the 1988-90 CDS.)

91. Blank X X X
 (This variable is left blank so that numbering consistency can be maintained with the 1988-90 CDS.)

92. Steering Rim/Spoke Deformation _____
 _____ Code actual measured deformation to the nearest inch.
 (0) No steering rim deformation
 (1-5) Actual measured value
 (6) 6 inches or more
 (8) Observed deformation cannot be measured
 (9) Unknown

93. Location of Steering Rim/Spoke Deformation _____
 (00) No steering rim deformation

Quarter Sections
 (01) Section A
 (02) Section B
 (03) Section C
 (04) Section D



Half Sections
 (05) Upper half of rim/spoke
 (06) Lower half of rim/spoke
 (07) Left half of rim/spoke
 (08) Right half of rim/spoke

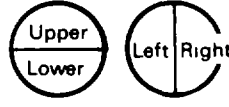

(09) Complete steering wheel collapse
 (10) Undetermined location
 (99) Unknown

INSTRUMENT PANEL

94. Odometer Reading _____,000
 _____ miles – Code mileage to the nearest 1,000 miles
 (000) No odometer
 (001) Less than 1,500 miles
 (300) 299,500 miles or more
 (999) Unknown
 Source: _____

95. Instrument Panel Damage from Occupant Contact? _____
 (0) No
 (1) Yes
 (9) Unknown

96. Knee Bolsters Deformed from Occupant Contact? _____
 (0) No
 (1) Yes
 (8) Not present
 (9) Unknown

97. Did Glove Compartment Door Open During Collision(s)? _____
 (0) No
 (1) Yes
 (8) Not present
 (9) Unknown

VEHICLE INTERIOR SKETCHES

Note area of ejection/entrapment

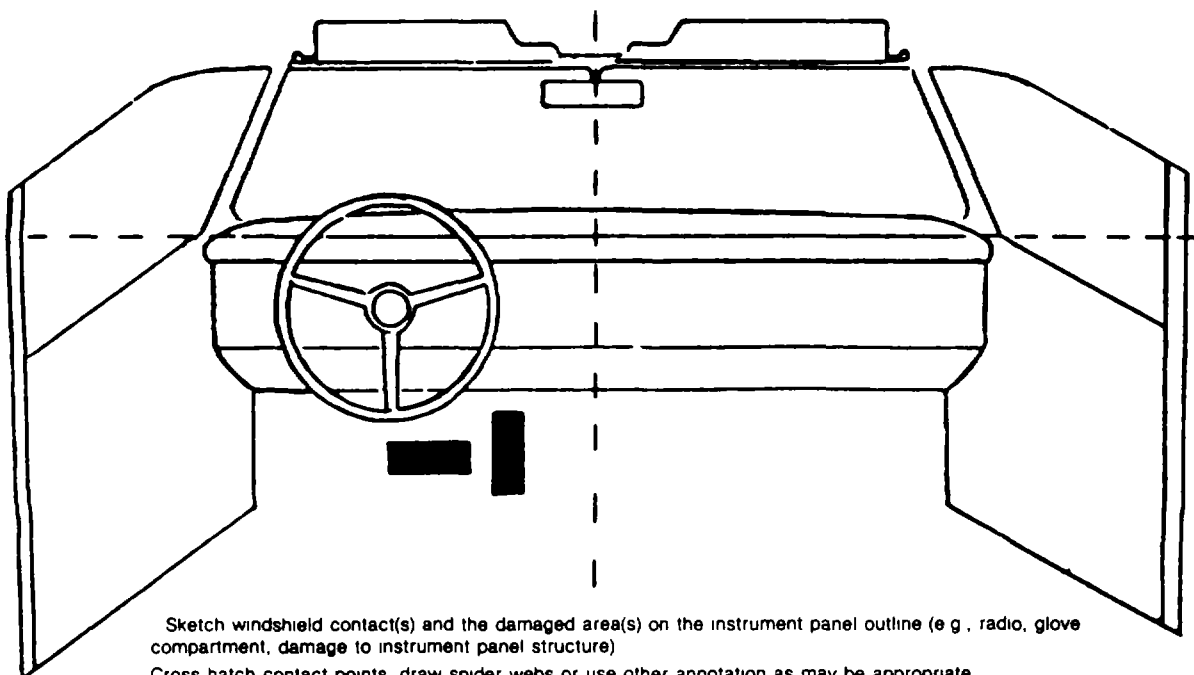
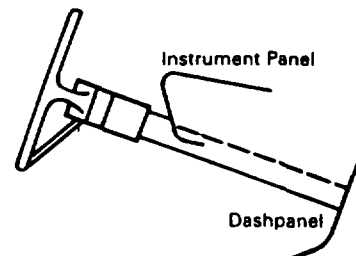
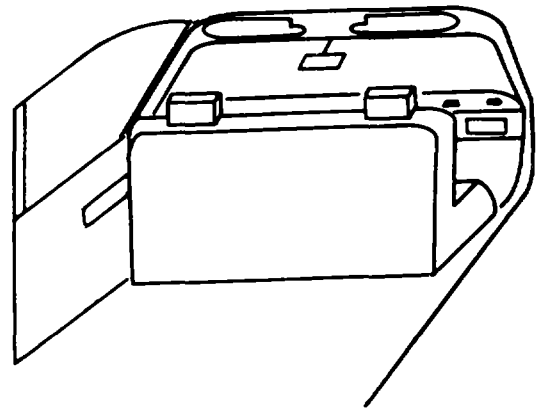
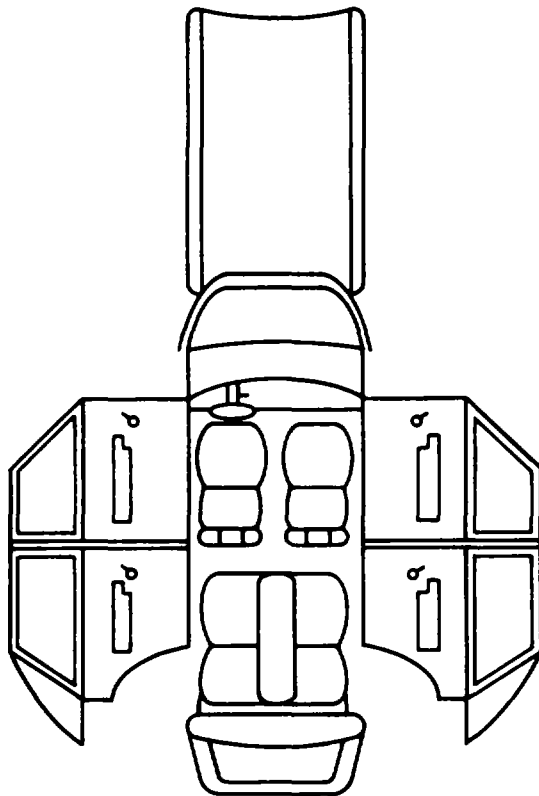

Sketch windshield contact(s) and the damaged area(s) on the instrument panel outline (e.g., radio, glove compartment, damage to instrument panel structure)

Cross hatch contact points, draw spider webs or use other annotation as may be appropriate

Annotate the contacted area with a letter (begin with A) and list on the Points of Occupant Contact page

POINTS OF OCCUPANT CONTACT

Contact	Interior Component Contacted	Occupant No. If Known	Body Region If Known	Supporting Physical Evidence	Confidence Level of Contact Point
A					
B					
C					
D					
E					
F					
G					
H					
I					
J					
K					
L					
M					
N					

CODES FOR INTERIOR COMPONENTS

FRONT

- (01) Windshield
- (02) Mirror
- (03) Sunvisor
- (04) Steering wheel rim
- (05) Steering wheel hub/spoke
- (06) Steering wheel (combination of codes 04 and 05)
- (07) Steering column, transmission selector lever, other attachment
- (08) Add on equipment (e.g., CB, tape deck, air conditioner)
- (09) Left instrument panel and below
- (10) Center instrument panel and below
- (11) Right instrument panel and below
- (12) Glove compartment door
- (13) Knee bolster
- (14) Windshield including one or more of the following: front header, A-pillar, instrument panel, mirror, or steering assembly (driver side only)
- (15) Windshield including one or more of the following: front header, A-pillar, instrument panel, or mirror (passenger side only)
- (16) Other front object (specify): _____

LEFT SIDE

- (20) Left side interior surface, excluding hardware or armrests
- (21) Left side hardware or armrest
- (22) Left A pillar
- (23) Left B pillar
- (24) Other left pillar (specify): _____
- (25) Left side window glass or frame

- (26) Left side window glass including one or more of the following: frame, window sill, A-pillar, B-pillar, or roof side rail
- (27) Other left side object (specify): _____

RIGHT SIDE

- (30) Right side interior surface, excluding hardware or armrests
- (31) Right side hardware or armrest
- (32) Right A pillar
- (33) Right B pillar
- (34) Other right pillar (specify): _____
- (35) Right side window glass or frame
- (36) Right side window glass including one or more of the following: frame, window sill, A-pillar, B-pillar, or roof side rail
- (37) Other right side object (specify): _____

INTERIOR

- (40) Seat, back support
- (41) Belt restraint webbing/buckle
- (42) Belt restraint B-pillar attachment point
- (43) Other restraint system component (specify): _____
- (44) Head restraint system
- (45) Air bag
- (46) Other occupants (specify): _____
- (47) Interior loose objects

- (48) Child safety seat (specify): _____

- (49) Other interior object (specify): _____

ROOF

- (50) Front header
- (51) Rear header
- (52) Roof left side rail
- (53) Roof right side rail
- (54) Roof or convertible top

FLOOR

- (56) Floor including toe pan
- (57) Floor or console mounted transmission lever, including console
- (58) Parking brake handle
- (59) Foot controls including parking brake

REAR

- (60) Backlight (rear window)
- (61) Backlight storage rack, door, etc.
- (62) Other rear object (specify): _____

CONFIDENCE LEVEL OF CONTACT POINT

- (1) Certain
- (2) Probable
- (3) Possible
- (4) Unknown

AUTOMATIC RESTRAINTS

NOTES: Encode the data for each applicable front seat position. The attributes for the variables may be found below. Restraint systems should be assessed during the vehicle inspection then coded on the Occupant Assessment Form.

		Left	Center	Right
F I R S T	Availability			
	Function			
	Failure			

AIR BAGS

Air Bag System Availability/Function

- (0) Not equipped/not available
- (1) Air bag

Non-functional

- (2) Air bag disconnected (specify) _____
- (3) Air bag not reinstalled
- (9) Unknown

Air Bag System Deployment

- (0) Not equipped/not available
- (1) Air bag deployed during accident
- (2) Air bag deployed inadvertently just prior to accident
- (3) Air bag deployed, accident sequence undetermined
- (4) Nondeployed
- (5) Unknown if deployed
- (9) Unknown

Did Air Bag System Fail?

- (0) Not equipped/not available
- (1) No
- (2) Yes (specify). _____
- (9) Unknown

AUTOMATIC BELTS

Automatic (Passive) Belt System Availability/Function

- (0) Not equipped/not available
- (1) 2 point automatic belts
- (2) 3 point automatic belts
- (3) Automatic belts - type unknown

Non-functional

- (4) Automatic belts destroyed or rendered inoperative
- (9) Unknown

Automatic (Passive) Belt System Use

- (0) Not equipped/not available/destroyed or rendered inoperative
- (1) Automatic belt in use
- (2) Automatic belt not in use (manually disconnected, motorized track inoperative)
- (3) Automatic belt use unknown
- (9) Unknown

Automatic (Passive) Belt System Type

- (0) Not equipped/not available
- (1) Non-motorized system
- (2) Motorized system
- (9) Unknown

Proper Use of Automatic (Passive) Belt System

- (0) Not equipped/not available/not used
- (1) Automatic belt used properly
- (2) Automatic belt used properly with child safety seat

Automatic Belt Used Improperly

- (3) Automatic shoulder belt worn under arm
- (4) Automatic shoulder belt worn behind back
- (5) Automatic belt worn around more than one person
- (6) Lap portion of automatic belt worn on abdomen
- (7) Automatic lap and shoulder belt or automatic shoulder belt used improperly with child safety seat (specify): _____
- (8) Other improper use of automatic belt system (specify): _____
- (9) Unknown

Automatic (Passive) Belt Failure Modes During Accident

- (0) Not equipped/not available/not in use
- (1) No automatic belt failure(s)
- (2) Torn webbing (stretched webbing not included)
- (3) Broken buckle or latchplate
- (4) Upper anchorage separated
- (5) Other anchorage separated (specify): _____
- (6) Broken retractor
- (7) Combination of above (specify): _____
- (8) Other automatic belt failure (specify): _____
- (9) Unknown

MANUAL RESTRAINTS

NOTES: Encode the applicable data for **each seat position** in the vehicle. The attributes for the variables may be found below. Restraint systems should be assessed during the vehicle inspection then coded on the Occupant Assessment Form.

If a child safety seat is present, encode the data on the back of this page.

If the vehicle has automatic restraints available, encode the appropriate data on the back of the previous page.

		Left	Center	Right
FIRST	Availability			
	Use			
	Failure Modes			
SECOND	Availability			
	Use			
	Failure Modes			
THIRD	Availability			
	Use			
	Failure Modes			
OTHER	Availability			
	Use			
	Failure Modes			

Manual (Active) Belt System Availability

- (0) Not available
- (1) Belt removed/destroyed
- (2) Shoulder belt
- (3) Lap belt
- (4) Lap and shoulder belt
- (5) Belt available – type unknown
- (8) Other belt (specify):

(9) Unknown

Manual (Active) Belt System Use

- (00) None used, not available, or belt removed/destroyed
- (01) Inoperative (specify):

- (02) Shoulder belt
- (03) Lap belt
- (04) Lap and shoulder belt
- (05) Belt used – type unknown

(08) Other belt used (specify):

- (12) Shoulder belt used with child safety seat
- (13) Lap belt used with child safety seat
- (14) Lap and shoulder belt used with child safety seat
- (15) Belt used with child safety seat – type unknown
- (18) Other belt used with child safety seat (specify):

(99) Unknown if belt used

Manual (Active) Belt Failure Modes During Accident

- (0) No manual belt used or not available
- (1) No manual belt failure(s)
- (2) Torn webbing (stretched webbing not included)
- (3) Broken buckle or latchplate
- (4) Upper anchorage separated
- (5) Other anchorage separated (specify):

(6) Broken retractor
(7) Combination of above (specify):

(8) Other manual belt failure (specify):

(9) Unknown

CHILD SAFETY SEAT FIELD ASSESSMENT

When a child safety seat is present enter the occupant's number in the first row and complete the column below the occupant's number using the codes listed below. Complete a column for each child safety seat present.

Occupant Number						
1. Type of Child Safety Seat						
2. Child Safety Seat Orientation						
3. Child Safety Seat Harness Usage						
4. Child Safety Seat Shield Usage						
5. Child Safety Seat Tether Usage						
6. Child Safety Seat Make/Model	Specify Below for Each Child Safety Seat					

- 1. Type of Child Safety Seat**
 (0) No child safety seat
 (1) Infant seat
 (2) Toddler seat
 (3) Convertible seat
 (4) Booster seat
 (7) Other type child safety seat (specify):

 (8) Unknown child safety seat type
 (9) Unknown if child safety seat used
- 2. Child Safety Seat Orientation**
 (00) No child safety seat
 Designed for Rear Facing for This Age/Weight
 (01) Rear facing
 (02) Forward facing
 (03) Other orientation (specify):

 (04) Unknown orientation
 Designed for Forward Facing for This Age/Weight
 (11) Rear facing
 (12) Forward facing
 (18) Other orientation (specify):

 (19) Unknown orientation
 Unknown Design or Orientation for This Age/Weight, or Unknown Age/Weight
 (21) Rear facing
 (22) Forward facing
 (28) Other orientation (specify):

 (29) Unknown orientation
 (99) Unknown if child safety seat used

- 3. Child Safety Seat Harness Usage**
- 4. Child Safety Seat Shield Usage**
- 5. Child Safety Seat Tether Usage**
 Note: Options Below Are Used for Variables 3-5.
 (00) No child safety seat
 Not Designed with Harness/Shield/Tether
 (01) After market harness/shield/tether added, not used
 (02) After market harness/shield/tether used
 (03) Child safety seat used, but no after market harness/shield/tether added
 (09) Unknown if harness/shield/tether added or used
 Designed with Harness/Shield/Tether
 (11) Harness/shield/tether not used
 (12) Harness/shield/tether used
 (19) Unknown if harness/shield/tether used
 Unknown if Designed with Harness/Shield/Tether
 (21) Harness/shield/tether not used
 (22) Harness/shield/tether used
 (29) Unknown if harness/shield/tether used
 (99) Unknown if child safety seat used
- 6. Child Safety Seat Make/Model**
 (Specify make/model and occupant number)

HEAD RESTRAINTS/SEAT EVALUATION

NOTES: Encode the applicable data for **each seat position** in the vehicle. The attributes for these variables may be found at the bottom of the page. Head restraint type/damage and seat type/performance should be assessed during the vehicle inspection then coded on the Occupant Assessment Form.

		Left	Center	Right
FIRST	Head Restraint Type/Damage			
	Seat Type			
	Seat Performance			
SECOND	Head Restraint Type/Damage			
	Seat Type			
	Seat Performance			
THIRD	Head Restraint Type/Damage			
	Seat Type			
	Seat Performance			
OTHER	Head Restraint Type/Damage			
	Seat Type			
	Seat Performance			

Head Restraint Type/Damage by Occupant at This Occupant Position

- (0) No head restraints
- (1) Integral – no damage
- (2) Integral – damaged during accident
- (3) Adjustable – no damage
- (4) Adjustable – damaged during accident
- (5) Add-on – no damage
- (6) Add-on – damaged during accident
- (8) Other (specify): _____
- (9) Unknown

Seat Performance (This Occupant Position)

- (0) No seat
- (1) No seat performance failure(s)
- (2) Seat adjusters failed
- (3) Seat back folding locks failed
- (4) Seat tracks/anchors failed
- (5) Deformed by impact of occupant
- (6) Deformed by passenger compartment intrusion (specify): _____

Seat Type (This Occupant Position)

- (00) No seat
- (01) Bucket
- (02) Bucket with folding back
- (03) Bench
- (04) Bench with separate back cushions
- (05) Bench with folding back(s)
- (06) Split bench with separate back cushions
- (07) Split bench with folding back(s)
- (08) Pedestal (i.e., van type)
- (09) Other seat type (specify): _____
- (99) Unknown

- (7) Combination of above (specify): _____
- (8) Other (specify): _____
- (9) Unknown

DESCRIBE ANY INDICATION OF ABNORMAL OCCUPANT POSTURE (I.E. UNUSUAL OCCUPANT CONTACT PATTERN)

EJECTION/ENTRAPMENT DATA

Complete the following if the researcher has any indications that an occupant was either ejected from or entrapped in the vehicle. Code the appropriate data on the Occupant Assessment Form.

EJECTION No [] = Yes []

Describe indications of ejection and body parts involved in partial ejection(s):

Occupant Number						
Ejection						
(Note on Vehicle Interior Sketch) Ejection Area						
Ejection Medium						
Medium Status						

<p>Ejection</p> <ul style="list-style-type: none"> (1) Complete ejection (2) Partial ejection (3) Ejection, unknown degree (9) Unknown <p>Ejection Area</p> <ul style="list-style-type: none"> (1) Windshield (2) Left front (3) Right front (4) Left rear (5) Right rear (6) Rear 	<ul style="list-style-type: none"> (7) Roof (8) Other area (e.g., back of pickup, etc.) (specify): _____ (9) Unknown <p>Ejection Medium</p> <ul style="list-style-type: none"> (1) Door/hatch/tailgate (2) Nonfixed roof structure (3) Fixed glazing (4) Nonfixed glazing (specify): _____ 	<ul style="list-style-type: none"> (5) Integral structure (8) Other medium (specify): _____ (9) Unknown <p>Medium Status (Immediately Prior to Impact)</p> <ul style="list-style-type: none"> (1) Open (2) Closed (3) Integral structure (9) Unknown
--	--	--

ENTRAPMENT No [] = Yes []

Describe entrapment mechanism: _____

Component(s): _____

(Note in vehicle interior diagram)

INTERIOR VEHICLE LOG

Performance Assessment

TO BE COMPLETED BY TEAM	
1. PSU Number _____	
2. Case Number - Stratum _____	
3. Researcher Completing Form _____	
4. Vehicle Number _____	
TO BE COMPLETED BY ZONE CENTER	
5. Assessment Of Complexity Of Interior Vehicle Inspection _____ (1) Level 1 - Interior inaccessible or repaired <u>Level 2</u> (2) Routine (3) Difficult	
6. Documentation Of Integrity _____	
7. Documentation Of Glazing _____	
8. Documentation of Intrusions _____	
9. Documentation of Steering Column/Wheel _____	
10. Documentation of Occupant Contacts _____	
11. Documentation of Restraint Systems _____	
12. Documentation of Seats _____	
13. Interior Slides Subject Quality _____	
14. Interior Slides Quality _____	
<p>Codes For Log Variables 6-14 (0) Not applicable (1) Substandard (2) Standard (3) Above Standard</p>	
15. Number of Coded Intrusions _____	

DATA STATUS OF VARIABLE NUMBERS 4-97

Integrity

4	5	6	7	8	9	10	11	12	13	14

Glazing

15	16	17	18	19	20	21	22	23	24	25
26	27	28	29	30	31	32	33	34	35	36
37	38	39	40	41	42	43	44	45	46	

Intrusion

47	48	49	50	51	52	53	54	55	56	57
58	59	60	61	62	63	64	65	66	67	68
69	70	71	72	73	74	75	76	77	78	79
80	81	82	83	84	85	86				

Steering Column/Wheel and Instrument Panel

87	88	89	90	91	92	93	94	95	96	97
	XX	XX	XX	XX						

Data Status Codes:

(Blank) Correct
 (1) Derived error
 (2) Non-correctable error
 (3) Correctable error
 (4) Change - no error
 (5) Sequencing error
 (8) MDE error
 (9) Unknown coded

Variable Name: Passenger Compartment Integrity

Element Values:

00 No integrity loss

Yes, Integrity Was Lost Through:

01 Windshield

02 Door (side)

03 Door/hatch (back door)

04 Roof

05 Roof glass

06 Side window

07 Rear window (backlight)

08 Roof and roof glass

09 Windshield and door (side)

10 Windshield and roof

11 Side and rear window (side window and backlight)

12 Windshield and side window

13 Door and side window

98 Other combination of above (specify):

99 Unknown

Source: Vehicle inspection

Remarks:

Consider the passenger compartment as a "package" which is designed to contain the occupant. If an opening occurs of sufficient magnitude through which an occupant could have been ejected totally or partially (although it is not necessary for an occupant to have been ejected), the integrity of the compartment should be considered to have been lost. While it is difficult to define the magnitude of the opening in a universal manner, the minimum size of the opening would be equivalent to the head of most adults. Components which may lose their integrity are restricted to the windshield glazing, window glazing (side, rear, or roof), door or roof.

The question of integrity loss is assessed with respect to impact related damage. The damage can be either direct or induced. Damage which is not impact related (e.g., fire, extrication) is not considered.

Doors which open upon impact or glazing that is broken during the impact sequence are considered integrity loss. However, doors which were left open prior to an impact do not constitute damage related loss of integrity and should be reported under IV05-IV09 (Door, Tailgate Or Hatch Opening) code "8" (Other).

Code "00" (No integrity loss) is encoded when the doors, roof, and glazing (as listed below) remained intact during the impact sequence.

Code "01" (Windshield) is encoded when the glazing is either holed/slit or displaced sufficiently to allow an adult size head to pass through.

Variable Name: Passenger Compartment Integrity (cont'd.)

- Code "02" [Door (side)] refers to the door structure and excludes glazing areas. All side doors, whether hinged or sliding are considered here.
- Code "03" [Door/hatch (back door)] identifies integrity loss of the back door structure and not the glazing. Back doors include hatchback, tailgate, and liftback. In situations where the rear hatch or upper portion of the tailgate is entirely made of glazing material and secured with a latching mechanism, only the latching mechanism should be considered for this code. Integrity loss through shattered or displaced rear window glazing is identified in code "07" (Rear window).
- Code "04" (Roof) refers only to the roof structure and not glazing areas. Roof structures containing metal panels (e.g., "T" top roofs) are reported here as well as closed convertible tops.
- Code "05" (Roof glass) reports glazing material in the roof structure which is broken or displaced.
- Code "06" (Side window) refers to glazing which was broken or displaced during the accident sequence. Glazing which was totally open prior to the accident and broken (i.e., sidelight rolled down into the door area) is not coded as integrity loss.
- Code "07" [Rear window (backlight)] includes backlights, hatchbacks/tailgates/liftbacks, and rear door glazing which were broken or displaced.
- Code "08" (Roof and roof glass) is coded when each specific component experiences integrity loss.
- Code "09" [Windshield and door (side)] identifies integrity loss through windshield glazing and side door structure, but excludes sidelight glazing.
- Code "10" (Windshield and roof) refers to integrity loss of the windshield glazing and roof structure. Windshield and roof glass is included in Code "98" (Other combination of above).
- Code "11" [Side and rear window (side window and backlight)] identifies integrity loss to glazing areas on either side of the vehicle in combination with hatchback/tailgate/liftback and rear door glazing.
- Code "12" (Windshield and side window) refers to integrity loss of the windshield glazing (see code "01") in combination with glazing on either side of the vehicle (see code "06").
- Code "13" (Door and side window) refers to integrity loss of the door structure (see code "02") in combination with glazing on either side of the vehicle (see code "06").

Variable Name: Passenger Compartment Integrity (cont'd.)

Code "98" (Other combination of above) includes any combination of codes "01"-
"07" above which are not listed in elements "08"-
"13". Integrity loss in areas not identified by elements "01"-
"07" (e.g., floor) is not considered for this variable.

Code "99" (Unknown) is used in the following situations:

- o extrication damage masked integrity loss, and
- o integrity loss could not be determined due to circumstances beyond the researcher's control.

DOOR, TAILGATE, OR HATCH OPENING OVERVIEW

It is the intent of variables IV05-IV09 to capture whether a passenger compartment door, tailgate, or hatch opened or remained closed during the accident sequence. Variables IV10-IV14 only document reasons for why doors came open during the accident.

The areas of interest include the left front, right front, left rear, right rear, and tailgate/hatch doors (i.e., LF, RF, LR, RR, TG/H, respectively). The LF and RF doors are the forwardmost side doors on the left and right sides of a vehicle and the LR and RR doors are the next door (or set of doors) rearward of the LF and RF doors. There are situations where two adjacent doors are used to cover a single opening (i.e., side or rear of a cargo van). These should be treated as a single door. Side doors are applicable whether hinged or on tracks.

Generally, hatch doors meet the following criteria:

- o provide access to the rear cargo area of a passenger car type vehicle, through a large opening backlight,
- o are composed primarily of glass and may or may not be framed,
- o are hinged at the top and latched at the bottom, and
- o are not used in conjunction with a lower door or tailgate.

Some vehicles are equipped with frameless glass hatches which may shatter as a result of an impact. This situation is considered a glazing loss (refer to variables IV15-IV46) rather than a hatch opening unless the hatch did, in fact, open prior to the glass breaking (i.e., release of the latching/hinging mechanism). Some glass hatches may be bordered by a narrow band of metal. The condition of this metal band is the focus of this variable group. These remarks also apply when the upper window of a tailgate assembly is being considered.

Generally, tailgates exist on the rear end plane of station wagon type vehicles. They may be one or two piece assemblies. In the instance of a two piece unit, they will be hinged at the top and bottom with a horizontal seam. One piece units may be hinged at the top for some vehicles or at the bottom with retracting rear windows for others. Pickup truck tailgates are not included in these variables.

Rear doors may be single or double units covering a single opening. The rear doors are hinged on one or both sides with a vertical seam present in dual door applications. Rear doors are most commonly found on van type vehicles and are encoded under variables IV09 and IV14, ... - TG/H.

IV05
 IV06
 IV07
 IV08
 IV09

Variable Name: Door, Tailgate Or Hatch Opening - LF
 Door, Tailgate Or Hatch Opening - RF
 Door, Tailgate Or Hatch Opening - LR
 Door, Tailgate Or Hatch Opening - RR
 Door, Tailgate Or Hatch Opening - TG/H

Element Values:

- 0 No door/gate/hatch
- 1 Door/gate/hatch remained closed and operational
- 2 Door/gate/hatch came open during collision
- 3 Door/gate/hatch jammed shut
- 8 Other (specify):
- 9 Unknown

Source: Vehicle inspection

Remarks:

This variable identifies the operational status of a door, tailgate or hatch during an accident sequence. Priority is given to doors which open during the collision. Where multiple doors cover a single opening, and the disposition of each door was different, select the code for the door which is first identified in the following priority list: "2" (... came open during collision), "3" (... jammed shut), "8" (Other), "1" (... remained closed and operational), and "9" (Unknown). As an example, if one door came open and the other was jammed shut, the proper code would be "2" (... came open during collision). Gaps caused by body deformation are not coded as door opening events. These gaps will be encoded in variable IV04, Passenger Compartment Integrity.

Code "0" (No door/gate/hatch) is used when no door, tailgate, or hatch exists in the appropriate area (i.e., LF, RF, LR, RR, TG/H).

Code "1" (Door/gate/hatch remained closed and operational) for any door, tailgate, or hatch which did not open during the accident sequence and remained operational.

Code "2" (Door/gate/hatch came open during collision) is coded when the door assembly opened during the accident sequence, irrespective of the cause. Further, the magnitude of the opening created is inconsequential when encoding this value. Note, if this code is used then the matching area in variables IV10-IV14 must not equal "0". The researcher must consider the potential that a sprung-mass situation may exist. In this condition, the door may have been opened after the accident, but due to vehicle body stresses the door cannot be shut. This is an important consideration when assessing whether the door came open during the collision.

] V05
] V06
] V07
] V08
] V09
(2)

Variable Name: Door, Tailgate Or Hatch Opening - LF (cont'd.)
Door, Tailgate Or Hatch Opening - RF (cont'd.)
Door, Tailgate Or Hatch Opening - LR (cont'd.)
Door, Tailgate Or Hatch Opening - RR (cont'd.)
Door, Tailgate Or Hatch Opening - TG/H (cont'd.)

Code "3" (Door/gate/hatch jammed shut) is used when a door is rendered inoperable due to being jammed shut. Inoperable is defined as the inability of the researcher to open the door wide enough (through the use of reasonable force) to allow passage of an adult head. It is irrelevant whether the jamming is a result of latch or hinge failure, the displacement of adjacent body panels, or direct damage. Undamaged locked doors should not be coded as jammed or inoperable. Doors which were pried open following the accident are an indication of jamming and should be closely examined. In this situation, the researcher should thoroughly annotate and photograph the door area to support this conclusion.

Code "8" (Other) is used for those situations which cannot be identified with elements "0"- "3". Doors which are open prior to the accident take this code (e.g., hatchbacks open for cargo reasons, ventilation, etc.).

Code "9" (Unknown) is used when the researcher could not make a performance assessment of the door, tailgate or hatch.

IV10
 IV11
 IV12
 IV13
 IV14

Variable Name: Damage/Failure Associated with Door, Tailgate,
 Or Hatch Opening In Collision - LF
 Damage/Failure Associated with Door, Tailgate,
 Or Hatch Opening In Collision - RF
 Damage/Failure Associated with Door, Tailgate,
 Or Hatch Opening In Collision - LR
 Damage/Failure Associated with Door, Tailgate,
 Or Hatch Opening In Collision - RR
 Damage/Failure Associated with Door, Tailgate,
 Or Hatch Opening In Collision - TG/H

Element Values:

0 No door/gate/hatch or door not opened

Door, Tailgate, or Hatch Came Open During Collision

- 1 Door operational (no damage)
- 2 Latch/striker failure due to damage
- 3 Hinge failure due to damage
- 4 Door structure failure due to damage
- 5 Door support (i.e., pillar, sill, roof side rail, etc.) failure due to damage
- 6 Latch/striker and hinge failure due to damage
- 8 Other failure (specify):
- 9 Unknown

Source: Vehicle inspection

Remarks:

This variable is designed to capture the reason a door opened during the collision sequence as identified by code "2" (Door/gate/hatch came open during collision) in variables IV05-IV09, respectively.

Code "0" (No door/gate/hatch or door not opened) is used when no door, tailgate, or hatch exists or the door/tailgate/hatch did not open during the accident sequence. This code is also used when the door/tailgate/hatch is jammed shut. Doors which were open prior to the accident (hatchbacks open for cargo reasons, ventilation, etc.) also take this code.

Code "1" [Door operational (no damage)] is used when the door, tailgate, or hatch opened during the accident sequence, but the unit was undamaged and remained operational.

Code "2" (Latch/striker failure due to damage) is used when the door, tailgate, or hatch opened as a result of a failure of the latch/striker

IV10
 IV11
 IV12
 IV13
 IV14
 (2)

Variable Name: Damage/Failure Associated with Door, Tailgate,
 Or Hatch Opening In Collision - LF (cont'd.)
 Damage/Failure Associated with Door, Tailgate,
 Or Hatch Opening In Collision - RF (cont'd.)
 Damage/Failure Associated with Door, Tailgate,
 Or Hatch Opening In Collision - LR (cont'd.)
 Damage/Failure Associated with Door, Tailgate,
 Or Hatch Opening In Collision - RR (cont'd.)
 Damage/Failure Associated with Door, Tailgate,
 Or Hatch Opening In Collision - TG/H (cont'd.)

assembly. The failure must be due to damage, either direct or induced, and must result in the forced unlatching of the latch/striker assembly or shearing of the striker post.

- Code "3" (Hinge failure due to damage) is used to indicate that a hinge failure exists as a result of either direct or induced damage. A hinge failure includes the complete separation of the hinge assembly from the door structure, pillar or of the two or more components which comprise the hinge assembly.
- Code "4" (Door structure failure due to damage) is used anytime the door structure sustained damage which allowed the latch, striker, or hinge to separate from the mounting surface (i.e., torn metal). The door structure is defined as all components of the door assembly exclusive of the door skin.
- Code "5" [Door support (i.e., pillar, sill, roof side rail, etc.) failure due to damage] is used to define situations where the latch/striker assembly did not fail, but the door support areas are damaged sufficiently to allow for the door to open. This includes, but is not limited to, the failure of pillars, sills and/or roof side rails at its most severe level. Code "6" (Latch/striker and hinge failure due to damage) is used to describe situations where the entire door and adjacent components (i.e., pillars) are torn away by an impact.
- Code "6" (Latch/striker and hinge failure due to damage) is used when both a latch/striker and hinge failure exists. Failure must be present to the latch/striker and at least one hinge, resulting in the door opening (i.e., door partially or completely torn off).
- Code "8" (Other failure) is used to indicate that an opening exists which cannot be described with codes "1"- "6" above. This includes vehicles with a canvas roof and door structure (i.e., Jeeps, etc.).

INTERIOR VEHICLE FORM

IV10
IV11
IV12
IV13
IV14
(3)

Variable Name: Damage/Failure Associated with Door, Tailgate,
Or Hatch Opening In Collision - LF (cont'd.)
Damage/Failure Associated with Door, Tailgate,
Or Hatch Opening In Collision - RF (cont'd.)
Damage/Failure Associated with Door, Tailgate,
Or Hatch Opening In Collision - LR (cont'd.)
Damage/Failure Associated with Door, Tailgate,
Or Hatch Opening In Collision - RR (cont'd.)
Damage/Failure Associated with Door, Tailgate,
Or Hatch Opening In Collision - TG/H (cont'd.)

Code "9" (Unknown) is used when it cannot be determined which code (elements
"1"- "8") applies.

GLAZING DAMAGE OVERVIEW

Glazing is defined for these variables as a covering for openings in the vehicle's structure which has the ability to allow light to pass. The areas of interest include: the windshield, sidelight windows, backlight (hatchback, tailgate, liftback, rear window), and roof. Composition of glazing materials in use today include: glass, plastic, and glass-plastic.

The potential for occupant ejection is a major concern of rulemakers at NHTSA. Variables IV15-IV46 are designed to record the successes and failures of occupant containment by glazing when there is an occurrence of occupant contact to the glazing, or glazing damage by impact forces or vehicle damage.

Current use of glass-plastic (such as Inner Shield, Securiflex, etc.) involves a plastic anti-lacerative layer applied to the inner surface of windshields. Recently, Federal Motor Vehicle Safety Standard 205 was modified to allow voluntary (not compulsory) installation of this type of glazing. Glass-plastic should not be confused with the current design of laminate windshields which are made with a layer of plastic (Polyvinyl Butyral) between two layers of annealed glass. It should be noted that future considerations and uses of glass-plastic involve the side, rear, and roof glazing areas.

Researchers are required to thoroughly inspect all glazing for direct occupant contact/damage and encode their findings. This information is recorded independent of occupant ejection.

Glazing variables are divided into four sections.

- o Glazing Damage from Impact Forces (IV15-IV22)
- o Glazing Damage from Occupant Contact (IV23-IV30)
- o Type of Window/Windshield Glazing (IV31-IV38)
- o Window Pre-crash Glazing Status (IV39-IV46)

These sections are further divided into eight specific areas of interest.

- o WS = windshield
- o LF = left front window (driver's window)
- o RF = right front window
- o LR = left rear window (adjacent to LF window)
- o RR = right rear window (adjacent to RF window)
- o BL = backlight, tailgate/hatchback/liftgate window
- o Roof = sun roof, moon roof, "T" roof, etc.
- o Other = other sidelights, door wing windows, and any other light not identified above

The "other" category (as noted) encompasses areas where glazing may be directly contacted by occupants or damaged from impact forces and not identified by a specific location. This would include wing windows located in door areas. In the event more than one "other" area was involved, select the area with the highest priority number as ranked in variables IV15-IV30. When more than one

GLAZING DAMAGE OVERVIEW

glazing has the highest priority code, the researcher should select the glazing which is closest to the front of the vehicle with the left side taking precedence over the right side. The researcher must specify the selected glazing in the space provided on the form.

IV15
 IV16
 IV17
 IV18
 IV19
 IV20
 IV21
 IV22

Variable Name: Glazing Damage From Impact Forces - WS
 Glazing Damage From Impact Forces - LF
 Glazing Damage From Impact Forces - RF
 Glazing Damage From Impact Forces - LR
 Glazing Damage From Impact Forces - RR
 Glazing Damage From Impact Forces - BL
 Glazing Damage From Impact Forces - Roof
 Glazing Damage From Impact Forces - Other

Element Values:

- 0 No glazing damage from impact forces
- 2 Glazing in place and cracked from impact forces
- 3 Glazing in place and holed from impact forces
- 4 Glazing out-of-place (cracked or not) and not holed from impact forces
- 5 Glazing out-of-place and holed from impact forces
- 6 Glazing disintegrated from impact forces
- 7 Glazing removed prior to accident
- 8 No glazing
- 9 Unknown if damaged

Source: Vehicle inspection

Remarks:

These variables identify damage to the glazing as a result of impact forces and/or vehicle damage (including damage from interior loose objects). Damage caused by direct occupant contact should be recorded in variables IV23-IV30, Glazing Damage From Occupant Contact.

Code "0" (No glazing damage from impact forces) is used when there was no damage to the glazing. Glazing damage for these variables is defined as cracking, holed, out-of-place or disintegrated. Glazing which is scratched is considered not damaged.

Code "2" (Glazing in place and cracked from impact forces) is used when the glazing remained within the confines of its specific area and was cracked. Displaced glazing which was not totally separated from the vehicle should be treated as "in place". This would include windshields with partial bond separation and dislodged side glazing.

Code "3" (Glazing in place and holed from impact forces) is used when the glazing was "holed". "Holed" refers to a hole or slit in the glazing which is large enough in size to allow passage of an adult head.

IV15
 IV16
 IV17
 IV18
 IV19
 IV20
 IV21
 IV22
 (2)

Variable Name: Glazing Damage From Impact Forces - WS (cont'd.)
 Glazing Damage From Impact Forces - LF (cont'd.)
 Glazing Damage From Impact Forces - RF (cont'd.)
 Glazing Damage From Impact Forces - LR (cont'd.)
 Glazing Damage From Impact Forces - RR (cont'd.)
 Glazing Damage From Impact Forces - BL (cont'd.)
 Glazing Damage From Impact Forces - Roof (cont'd.)
 Glazing Damage From Impact Forces - Other (cont'd.)

For the purpose of this variable, the hole or slit must have been produced by impact force and/or vehicle damage and not by direct occupant contact.

Code "4" [Glazing out-of-place (cracked or not) and not holed from impact forces] refers to glazing which was totally separated from the vehicle as the result of impact forces and/or vehicle damage. Windshields with 100 percent bond separation should receive this code. Caution must be exercised by the researcher not to consider shattered tempered glass (i.e., sidelights, etc.) as out-of-place. This situation should be identified under code "6" (Glazing disintegrated from impact forces).

Code "5" (Glazing out-of-place and holed from impact forces) refers to glazing that was totally separated from the vehicle during the accident sequence and was holed/slit as the result of impact forces or vehicle damage. "Holed" refers to a hole or slit in the glazing which is large enough in size to allow passage of an adult head.

Code "6" (Glazing disintegrated from impact forces) refers to glazing that was totally destroyed by impact forces or vehicle damage. This usually occurs with shattered tempered glass (i.e., sidelights, etc.). Windshields that are separated from the vehicle should not be considered disintegrated. Uncertainty may exist when determining the cause of shattered sidelight glazing when the collision occurred adjacent to an occupied seat. As a rule of thumb, impact forces and/or vehicle damage generally cause disintegration of the sidelight prior to occupant contact.

Code "7" (Glazing removed prior to accident) includes sun roofs, "T" tops, etc. which were removed from their respective areas prior to the accident. Glazing retracted into vehicle body panels (i.e., fully open) is assessed under codes "0"- "6" above and are not considered in this element.

IV15
 IV16
 IV17
 IV18
 IV19
 IV20
 IV21
 IV22
 (3)

Variable Name: Glazing Damage From Impact Forces - WS (cont'd.)
 Glazing Damage From Impact Forces - LF (cont'd.)
 Glazing Damage From Impact Forces - RF (cont'd.)
 Glazing Damage From Impact Forces - LR (cont'd.)
 Glazing Damage From Impact Forces - RR (cont'd.)
 Glazing Damage From Impact Forces - BL (cont'd.)
 Glazing Damage From Impact Forces - Roof (cont'd.)
 Glazing Damage From Impact Forces - Other (cont'd.)

Code "8" (No glazing) is used for specific areas where the body structure was not designed to accept glazing (i.e., solid roof structure, etc.).

Code "9" (Unknown if damaged) is used in the following situations.

- o The degree of damage could not be determined as the result of post impact damage (i.e., extrication, towing operations, etc.).
- o Due to factors beyond the researcher's control, an adequate determination of glazing damage could not be made (i.e., catastrophic type vehicle damage, etc.). This should be a rare occurrence.
- o The cause of glazing damage (i.e., impact forces versus occupant contact) could not be determined by the researcher. Caution, it is anticipated this reason will be rarely used. When confronted with this dilemma, every effort must be made to code a known value for damaged glazing.

IV23
 IV24
 IV25
 IV26
 IV27
 IV28
 IV29
 IV30

Variable Name: Glazing Damage from Occupant Contact - WS
 Glazing Damage from Occupant Contact - LF
 Glazing Damage from Occupant Contact - RF
 Glazing Damage from Occupant Contact - LR
 Glazing Damage from Occupant Contact - RR
 Glazing Damage from Occupant Contact - BL
 Glazing Damage from Occupant Contact - Roof
 Glazing Damage from Occupant Contact - Other

Element Values:

- 0 No occupant contact to glazing or no glazing
- 1 Glazing contacted by occupant but no glazing damage
- 2 Glazing in place and cracked by occupant contact
- 3 Glazing in place and holed by occupant contact
- 4 Glazing out-of-place (cracked or not) by occupant contact and not holed by occupant contact
- 5 Glazing out-of-place by occupant contact and holed by occupant contact
- 6 Glazing disintegrated by occupant contact
- 9 Unknown if contacted by occupant

Source: Vehicle inspection

Remarks:

These variables report direct occupant contact to the glazing during the accident sequence. The codes are arranged in an increasing number priority scheme [i.e., code "3" (Glazing in place and holed by occupant contact) takes precedence over code "2" (Glazing in place and cracked by occupant contact), etc.].

Code "0" (No occupant contact to glazing or no glazing) is used when there are no direct occupant contacts detected to the glazing or when variables IV15-IV22, Glazing Damage from Impact Forces, are coded "7" (Glazing removed prior to accident) or "8" (No glazing).

Code "1" (Glazing contacted by occupant but no glazing damage) is used when an occupant directly contacted the glazing, but the contact did not result in glazing damage.

Code "2" (Glazing in place and cracked by occupant contact) refers to glazing that was damaged (not holed) by direct occupant contact. The term "in place" describes glazing which has remained within the confines of its specific area. Displaced glazing which was not totally separated from

IV23
 IV24
 IV25
 IV26
 IV27
 IV28
 IV29
 IV30
 (2)

Variable Name: Glazing Damage from Occupant Contact - WS (cont'd.)
 Glazing Damage from Occupant Contact - LF (cont'd.)
 Glazing Damage from Occupant Contact - RF (cont'd.)
 Glazing Damage from Occupant Contact - LR (cont'd.)
 Glazing Damage from Occupant Contact - RR (cont'd.)
 Glazing Damage from Occupant Contact - BL (cont'd.)
 Glazing Damage from Occupant Contact - Roof (cont'd.)
 Glazing Damage from Occupant Contact - Other (cont'd.)

the vehicle should be treated as "in place". This would include windshields with partial bond separation and dislodged side glazing.

Code "3" (Glazing in place and holed by occupant contact) is used when the glazing was "holed". "Holed" refers to a hole or slit in the glazing which was produced by direct occupant contact. This opening is equivalent in size to the space necessary to allow passage of an adult head.

Code "4" [Glazing out-of-place (cracked or not) by occupant contact and not holed by occupant contact] refers to glazing which was directly contacted by an occupant and was totally separated from the vehicle during the accident sequence. Windshields with 100 percent bond separation take this code. Caution must be exercised by the researcher not to consider shattered tempered glass (i.e., sidelights, etc.) as out-of-place. This situation is reported under code "6" (Glazing disintegrated by occupant contact).

Code "5" (Glazing out-of-place by occupant contact and holed by occupant contact) refers to glazing which was contacted and holed by direct occupant contact and totally separated from the vehicle during the accident sequence. "Holed" refers to a hole or slit in the glazing which was produced by direct occupant contact. This opening is equivalent in size to the space necessary to allow passage of an adult head.

Code "6" (Glazing disintegrated by occupant contact) refers to glazing that was totally destroyed by direct occupant contact. This usually occurs with shattered tempered glass (i.e., sidelights, etc.). Windshields that were separated from the vehicle should not be considered disintegrated.

Code "9" (Unknown if contacted by occupant) is used in the following situations.

IV23
 IV24
 IV25
 IV26
 IV27
 IV28
 IV29
 IV30
 (3)

Variable Name: Glazing Damage from Occupant Contact - WS (cont'd.)
 Glazing Damage from Occupant Contact - LF (cont'd.)
 Glazing Damage from Occupant Contact - RF (cont'd.)
 Glazing Damage from Occupant Contact - LR (cont'd.)
 Glazing Damage from Occupant Contact - RR (cont'd.)
 Glazing Damage from Occupant Contact - BL (cont'd.)
 Glazing Damage from Occupant Contact - Roof (cont'd.)
 Glazing Damage from Occupant Contact - Other (cont'd.)

- o Direct occupant contact/damage could not be determined due to post impact damage (i.e., extrication, towing operations, etc.).
- o Due to factors beyond the researcher's control, an adequate determination of direct occupant contact/damage could not be made.

IV31
 IV32
 IV33
 IV34
 IV35
 IV36
 IV37
 IV38

Variable Name: Type of Window/Windshield Glazing - WS
 Type of Window/Windshield Glazing - LF
 Type of Window/Windshield Glazing - RF
 Type of Window/Windshield Glazing - LR
 Type of Window/Windshield Glazing - RR
 Type of Window/Windshield Glazing - BL
 Type of Window/Windshield Glazing - Roof
 Type of Window/Windshield Glazing - Other

Element Values:

- 0 No glazing contact and no damage, or no glazing
- 1 AS-1 - Laminated
- 2 AS-2 - Tempered
- 3 AS-3 - Tempered-tinted
- 4 AS-14 - Glass/Plastic
- 8 Other (specify):
- 9 Unknown

Source: Vehicle inspection

Remarks:

Glazing types are identified by unique AS (American Standard) numbers which are etched in the glazing surface. The AS numbers are generally grouped with other glazing information and together make up an informational symbol referred to as a "water mark" (see diagram below).

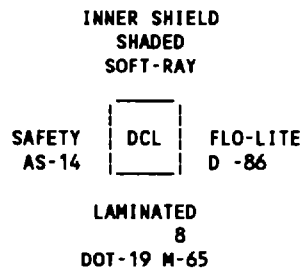

The following codes record information for specific areas identified in variable groups IV15-IV22, Glazing Damage from Impact Forces, and IV23-IV30, Glazing Damage from Occupant Contact.

Code "0" (No glazing contact and no damage, or no glazing) is used when any glazing area was not identified as either damaged from impact forces or contacted by an occupant in variables IV15-IV30. In addition,

IV31
 IV32
 IV33
 IV34
 IV35
 IV36
 IV37
 IV38
 (2)

Variable Name: Type of Window/Windshield Glazing - WS (cont'd.)
 Type of Window/Windshield Glazing - LF (cont'd.)
 Type of Window/Windshield Glazing - RF (cont'd.)
 Type of Window/Windshield Glazing - LR (cont'd.)
 Type of Window/Windshield Glazing - RR (cont'd.)
 Type of Window/Windshield Glazing - BL (cont'd.)
 Type of Window/Windshield Glazing - Roof (cont'd.)
 Type of Window/Windshield Glazing - Other (cont'd.)

use this code when codes "7" (Glazing removed prior to accident) or "8" (No glazing) in variables IV15-IV22, Glazing Damage from Impact Forces, were encoded.

Codes "1"- "4", or "8" are used when any glazing area was identified as damaged from impact forces or direct occupant contact in variable groups IV15-IV22 and IV23-IV30. When all side and rear windows have been broken out, examine the window track or frame for remnants of broken glass. If such glass is present and the remnants are small clear granules (or cracked in granule size pieces), then it is permissible to code "2" (AS-2 - Tempered). If these remnants are tinted, then it is permissible to code "3" (AS-3 - Tempered-Tinted). If these remnants have any plastic tint shield clinging to them, then it is permissible to code "8" (Other).

Code "1" (AS-1 - Laminated) refers to a layer of plastic between two layers of glass. This type of glazing is widely used in current windshield installations.

Code "2" (AS-2 - Tempered) refers to glass which has the ability to break into small glass granules when damaged.

Code "3" (AS-3 - Tempered-tinted) refers to manufactured tinted (privacy) glass which has the ability to break into small glass granules when damaged. Glazing which has an aftermarket plastic tint shield applied should be listed under code "8" (Other).

Code "4" (AS-14 - Glass/Plastic) refers to glazing which uses plastic on its inner surface. This is used in anti-lacerative windshields (i.e., Inner Shield, Securiflex, etc.).

Code "8" (Other) refers to any glazing which has an AS number different from AS-1, AS-2, AS-3 and AS-14. Write the AS number of the glazing in the space provided. This includes plastic (AS-11C), bullet proof (AS-10), aftermarket plastic tint shield, etc.

IV31
IV32
IV33
IV34
IV35
IV36
IV37
IV38
(3)

Variable Name: Type of Window/Windshield Glazing - WS (cont'd.)
Type of Window/Windshield Glazing - LF (cont'd.)
Type of Window/Windshield Glazing - RF (cont'd.)
Type of Window/Windshield Glazing - LR (cont'd.)
Type of Window/Windshield Glazing - RR (cont'd.)
Type of Window/Windshield Glazing - BL (cont'd.)
Type of Window/Windshield Glazing - Roof (cont'd.)
Type of Window/Windshield Glazing - Other (cont'd.)

Code "9" (Unknown) is used in the following situations.

- o Due to factors beyond the researcher's control, an adequate determination of glazing damage and/or direct occupant contact could not be made.
- o A reasonable determination of the AS number could not be made.

IV39
 IV40
 IV41
 IV42
 IV43
 IV44
 IV45
 IV46

Variable Name: Window Pre-crash Status - WS
 Window Pre-crash Status - LF
 Window Pre-crash Status - RF
 Window Pre-crash Status - LR
 Window Pre-crash Status - RR
 Window Pre-crash Status - BL
 Window Pre-crash Status - Roof
 Window Pre-crash Status - Other

Element Values:

- 0 No glazing contact and no damage, or no glazing
- 1 Fixed
- 2 Closed
- 3 Partially opened
- 4 Fully opened
- 9 Unknown

Source: Vehicle inspection.

Remarks:

These variables record the operational modes of the glazing prior to the accident.

Code "0" (No glazing contact and no damage, or no glazing) is used when any glazing area was not identified as either damaged from impact forces or directly contacted by an occupant in variables IV15-IV30. In addition, use this code when codes "7" (Glazing removed prior to accident) or "8" (No glazing) in variables IV15-IV22, Glazing Damage from Impact Forces, are encoded.

Code "1" (Fixed) identifies glazing which is not designed to open (e.g. windshields, etc.).

Code "2" (Closed) refers to any operable glazing which was fully closed (i.e., no air gaps).

Code "3" (Partially opened) refers to any operable glazing which is not firmly closed (i.e., air gaps present) and not fully opened. Note, the researcher should code the placement of the window in relationship to the opening and not by window design limitations.

Code "4" (Fully opened) refers to any operable glazing which is attached to the vehicle (i.e., window tracks) and was placed in the open position such that the glazing was not restricting the opening of the vehicle

IV39

IV40

IV41

IV42

IV43

IV44

IV45

IV46

(2)

Variable Name: Window Pre-crash Status - WS (cont'd.)
 Window Pre-crash Status - LF (cont'd.)
 Window Pre-crash Status - RF (cont'd.)
 Window Pre-crash Status - LR (cont'd.)
 Window Pre-crash Status - RR (cont'd.)
 Window Pre-crash Status - BL (cont'd.)
 Window Pre-crash Status - Roof (cont'd.)
 Window Pre-crash Status - Other (cont'd.)

structure. This element is assessed independently of window design limitations (i.e., side windows designed to only roll down halfway cannot receive this code).

Code "9" (Unknown) is used in the following situations.

- o Damage due to impact forces and/or glazing contact by an occupant could not be determined due to post-impact damage (i.e., extrication, tow operations, etc.).
- o Due to factors beyond the researcher's control, an adequate determination of damage and/or direct occupant contact could not be made.
- o A reasonable determination of the glazing pre-crash status could not be determined.

OCCUPANT AREA INTRUSION OVERVIEW

Intrusion results whenever the internal boundary surface of the passenger compartment is moved inward due to direct or indirect damage resulting from the application of a crushing force to the exterior surface of a vehicle. A passenger compartment is defined as that interior occupant space which is normally available for occupant seating, based upon both the vehicle design and seat configuration at the time of the accident. Adjacent cargo areas and other enclosed areas are included for consideration in the following situations.

- o The area behind the last row of seats designed by the manufacturer for cargo is integral with the passenger compartment.
- o An area where a seat row was either removed or folded down to accommodate cargo.

Intrusion can occur from the vertical, longitudinal, or lateral direction. Intrusion can also occur from the displacement of interior seatbacks and/or seat cushions.

Measurement of Passenger Compartment Intrusion

Types of Intrusion. Two types of intrusions occur most often in accidents. They are:

Type A: Intrusion which is limited to one part of the passenger compartment and where the other side of the vehicle remains relatively free of distortion. This is likely to be the case in the majority of accidents. In many cases it will be possible to obtain undeformed vehicle dimensions as the vehicle is symmetrical about the longitudinal centerline.

Type B: Intrusion which occurs in many sections of the passenger compartment with little of the vehicle remaining free of distortion. In this case, it will be necessary to obtain "original" dimensions by comparison with a second (unintruded) vehicle of the same type.

OCCUPANT AREA INTRUSION OVERVIEW

(2)

An example of Type A and Type B intrusions are shown in Figure 1.

Type A Intrusion:

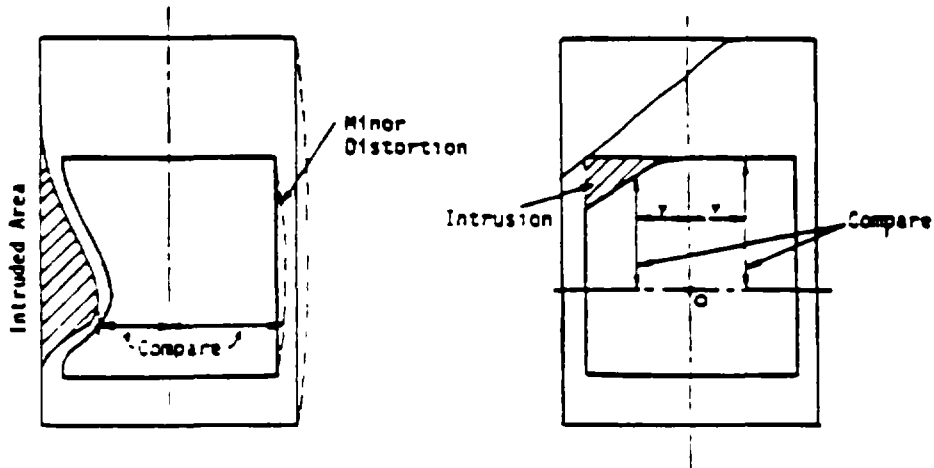

Type B Intrusion:

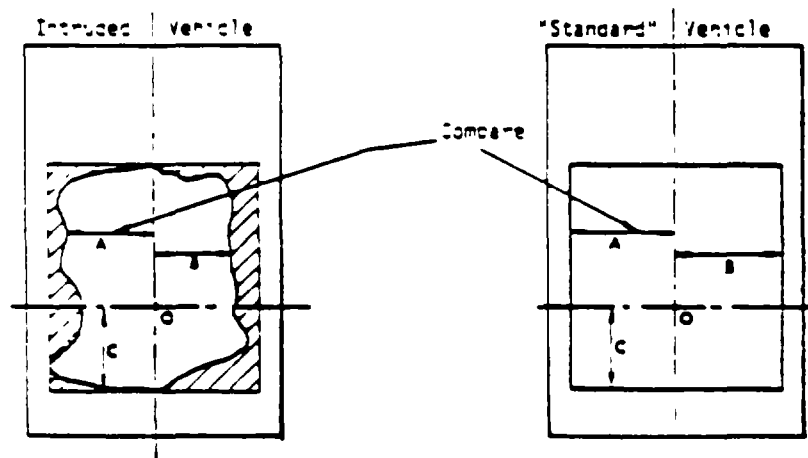

Figure 1

Establishment of Reference Axis. In order to compare one side of a vehicle with the other or compare two vehicles, a coordinate system within the vehicle is required.

OCCUPANT AREA INTRUSION OVERVIEW

(3)

This system is defined by an orthogonal set of axes (x-y-z) and an origin (0) as shown in Figure 2. The position of the origin is typically on the longitudinal centerline of the vehicle and has an arbitrary location, both vertically and longitudinally. However, its location must be identical for the intruded and "reference" vehicle. Note, the axes are referenced to the floor plane of the vehicle.

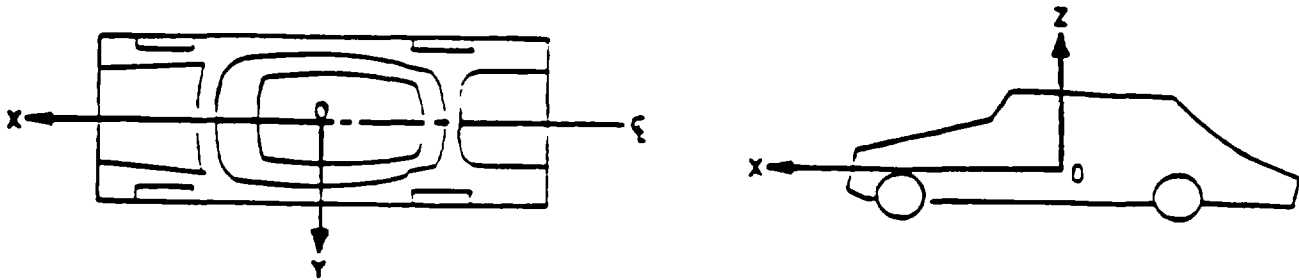

Figure 2

The x-axis is on the longitudinal centerline of the vehicle. This could be set up along the transmission drive shaft tunnel for a rear wheel drive vehicle or along a centerline which is equidistant from the sides of the vehicle in a front wheel drive vehicle.

The y-axis is in a side-to-side or lateral direction. This plane may be set up in any convenient location which can be readily established in the "reference" vehicle.

The z-axis is the vertical axis. A location at the top of the transmission drive shaft tunnel may be convenient to reference roof collapse in many cases. The point established by these intersecting planes defines the origin (0).

Establishing a frame of reference and measuring intrusion can be simplified.

- In a frontal collision, there is rarely intrusion at the rear, and vice-versa for a rear collision.
- Side impacts generally damage only one side of the vehicle.
- Roof impacts leave the floor pan undistorted.

Not all intrusions require the establishment of all three axes.

The ordering of intrusions reflects the intrusion severity as recorded in column three (i.e., Magnitude of Intrusion variables).

OCCUPANT AREA INTRUSION OVERVIEW

An intruded component is assessed for its Dominant Crush Direction (IV50 et al.) as determined from the Magnitude of Intrusion (IV49 et al.). This component must not be coded as having greater than one Dominant Crush Direction in any specific sector.

Code the ten most severe intrusions in descending order, beginning with the most severe, then the second most severe component, etc. If there is no intrusion, variables IV47-IV50 should be left "Blank". If there are less than ten intruding components, the lines following the last encoded intrusion should be left "Blank".

Displacement of less than one inch is not coded as an intrusion.

A passenger compartment that has been damaged catastrophically is encoded as "97", "97", "7", "7" in variables IV47-IV50.

Variable Name: Location of Intrusion
(1st through 10th)

Element Values:

Front Row

- 11 Left
- 12 Middle
- 13 Right

Second Row

- 21 Left
- 22 Middle
- 23 Right

Third Row

- 31 Left
- 32 Middle
- 33 Right

Fourth Row

- 41 Left
- 42 Middle
- 43 Right

97 Catastrophic

98 Other enclosed area (specify):

99 Unknown

Source: Vehicle inspection

Remarks:

The interior space of a vehicle is divided into specific sectors as outlined in the following diagram. These sectors are based upon seat rows and not occupant seat locations. Cargo areas open to the passenger area (i.e., station wagons, vans, etc.) are assessed in these variables. Intrusion into the trunk area of an automobile with a rear seat position or into a cargo area covered by a privacy curtain/shelf is excluded.

	Row 1	Row 2	Row 3	Row 4	
	13	23	33	43	98
<	12	22	32	42	
	11	21	31	41	

Other enclosed area

Variable Name: Location of Intrusion (cont'd.)
(1st through 10th)

Front Row, Second Row, Third Row, Fourth Row are identified by the presence of an installed seat. Each row is equally divided into three sectors. As an example, the Front Row is divided into sectors 11, 12, 13 regardless of the seating configuration.

In the situation where half of the row is folded down (i.e., split back seats) to accommodate cargo, the entire lateral area (wall-to-wall) is divided into three equal sectors. When the entire seat row is folded down or removed prior to the accident, this area is considered an "Other enclosed area" (code "98").

The following rules guide us in the determination of "seat rows" versus "other enclosed areas" and in the derivation of the lateral dimension of each row sector.

- o Cargo areas in passenger cars which are separated from the passenger compartment are not considered for intrusion. This would include trunk areas and rear cargo areas of hatchbacks and station wagons which were covered by a privacy curtain/shelf. The area above the privacy curtain/shelf is considered for intrusion and would be listed under code "98" (Other enclosed area).
- o The lateral occupant space dimension for the front seat row is obtained by measuring the distance from the vehicle's side-surface to side-surface (undamaged dimension) and dividing by three. Note, there is no implied correlation between seating capacity and sectors.
- o The area behind the front row of a pickup truck where jump seats are installed should be identified by the status of these seats prior to the accident. When at least one seat was in the operational mode (i.e., open) at the time of the accident, the entire area is divided into three sectors (i.e., "21", "22", "23"). Otherwise, this area is assessed under code "98" (Other enclosed area).
- o A problematic area in vans is the situation where a row was removed prior to the accident. A seat row area that was removed prior to an accident should be encoded as an "Other enclosed area" (code "98"); however, it should be tabulated as a seat row to identify any sequential rows.
- o Vans with single seating positions behind the Front Row (usually high back swivel chairs) are compressed into a single seat row.
- o The fifth row in a van (envisioned as a rare occurrence) is identified as an "Other enclosed area" (code "98").

Code "11" (Left) is defined as the left sector of the Front Row. The lateral dimension of this area is mathematically determined by dividing the original wall-to-wall dimension by three.

Variable Name: Location of Intrusion (cont'd.)
(1st through 10th)

Code "12" (Middle) is defined as the center sector of the Front Row.

Code "13" (Right) is defined as the right sector of the Front Row.

Code "21" (Left) is defined as the left sector of the Second Row. The lateral dimension of this sector is mathematically determined by dividing the original wall-to-wall dimension by three.

Code "22" (Middle) is defined as the center sector of the Second Row.

Code "23" (Right) is defined as the right sector of the Second Row.

Code "31" (Left) is defined as the left sector of the Third Row. The lateral dimension of this sector is mathematically determined by dividing the original wall-to-wall dimension by three.

Code "32" (Middle) is defined as the center sector of the Third Row.

Code "33" (Right) is defined as the right sector of the Third Row.

Code "41" (Left) is defined as the left sector of the Fourth Row. The lateral dimension of this sector is mathematically determined by dividing the original wall-to-wall dimension by three.

Code "42" (Middle) is defined as the center sector of the Fourth Row.

Code "43" (Right) is defined as the right sector of the Fourth Row.

Code "97" (Catastrophic) is coded when the intrusion damage to the occupant compartment is so devastating that the researcher is not able to discern any of the following: specific occupant locations, intruding components, magnitude of intrusions, and dominant crush.

Code "98" (Other enclosed area) is an area where no defined row exists. This would include an area where the entire seat row was folded down prior to the accident. Occasionally, the mid seat row in a passenger van will be removed leaving only the front and rearmost seat rows. If intrusion occurs within this area, the location should be identified here and specified.

Code "99" (Unknown) is used for the following situations.

- o The researcher cannot determine if there was any intrusion.
- o The vehicle was under repair at the time of inspection.

Variable Name: Intruding Components
(1st through 10th)

Element Values:

Interior Components

- 01 Steering assembly
- 02 Instrument panel left
- 03 Instrument panel center
- 04 Instrument panel right
- 05 Toe pan
- 06 A-pillar
- 07 B-pillar
- 08 C-pillar
- 09 D-pillar
- 10 Door panel (side)
- 12 Roof (or convertible top)
- 13 Roof side rail
- 14 Windshield
- 15 Windshield header
- 16 Window frame
- 17 Floor pan (includes sill)
- 18 Backlight header
- 19 Front seat back
- 20 Second seat back
- 21 Third seat back
- 22 Fourth seat back
- 23 Fifth seat back
- 24 Seat cushion
- 25 Back door/panel (e.g., tailgate)
- 26 Other interior component (specify):
- 27 Side panel - forward of the A-pillar
- 28 Side panel - rear of the A-pillar

Exterior Components

- 30 Hood
- 31 Outside surface of vehicle (specify):
- 32 Other exterior object in the environment (specify):
- 33 Unknown exterior object

- 97 Catastrophic
- 98 Intrusion of unlisted component(s)
- 99 Unknown

Source: Vehicle inspection

Remarks:

Code "01" (Steering assembly) consists of the entire steering column which includes the steering rim, hub, and spokes.

Code "02" (Instrument panel left) refers to the left side of the panel. This

Variable Name: Intruding Components (cont'd.)
(1st through 10th)

should correlate with the same lateral dimension generated for the sector space "11" (Front Seat - Left) in variables IV47 et al., Location of Intrusion.

Code "03" (Instrument panel center) refers to the center third area of the instrument panel. This should correlate with the same lateral dimension generated for the sector space "12" (Front Seat - Middle) in variables IV47 et al., Location of Intrusion.

Code "04" (Instrument panel right) refers to the right side of the instrument panel. This should correlate with the same lateral dimension generated for the sector space "13" (Front Seat - Right) in variables IV47 et al., Location of Intrusion.

Code "05" (Toe pan) refers to the front portion of the floor that angles up to meet the dash panel.

Code "06" (A-pillar) refers to the upper and lower portion of the forward most structural post of the passenger compartment on both side planes.

Code "07" (B-pillar) refers to the upper and lower portion of the structural post located at the rear edge of the front doors on both side planes. It should be noted, some vehicles do not have upper B-pillars.

Code "08" (C-pillar) refers to the upper and lower portion of the structural side post located at the rearmost edge of the rear door of a four door vehicle or the upper portion of the structural side post located between the backlight and side window glass on two door vehicles.

Code "09" (D-pillar) refers to the upper and lower portion of the rearward most structural post, usually available on station wagons, vans, or utility vehicles. The D-pillar is not to be confused with the C-pillar which is the rearmost pillar of the passenger compartment on most two and four door vehicles.

Code "10" [Door panel (side)] refers to the side interior surface and related components of a door.

Code "12" (Roof or convertible top) refers to the top structural member of the greenhouse supported by the side pillars, windshield header and backlight header.

Code "13" (Roof side rail) refers to the longitudinal horizontal stiffeners located along the edge of the roof.

Variable Name: Intruding Components (cont'd.)
(1st through 10th)

Code "14" (Windshield) refers to the lateral glazing located at the forward most surface of the greenhouse.

Code "15" (Windshield header) refers to the front forward lateral edge of the roof directly above the windshield.

Code "16" (Window frame) refers to the longitudinal frame that encloses the side window glazings and composes that portion of the door above the window sill.

Code "17" [Floor pan (includes sill)] refers to the floor of the vehicle. This includes the lower portion of the passenger compartment (e.g., door sills).

Code "18" (Backlight header) refers to the rear most lateral edge of the roof directly above the backlight.

Code "19" (Front seat back) refers to the back support of the front seat.

Code "20" (Second seat back) refers to the back support of the second seat

Code "21" (Third seat back) refers to the back support of the third seat.

Code "22" (Fourth seat back) refers to the back support of the fourth seat

Code "23" (Fifth seat back) refers to the back support of the fifth seat.

Code "24" (Seat cushion) refers to the horizontal portion of the seat assembly that was designed for seating.

Code "25" [Back door/panel (e.g., tailgate)] refers to the interior surface and related components of the back door or if no door exists, the interior surface of the back wall.

Code "26" (Other interior component) refers to any interior component that may intrude into an occupant seating position.

Code "27" (Side panel - forward of the A-pillar) refers to the interior panel located on the side of the vehicle and forward of the front doors. This includes areas directly below the instrument panel sometimes referred to as a "kickpanel".

Code "28" (Side panel - rear of the A-pillar) refers to any side surface area excluding doors, window frames, and associated glazing rearward of the A-pillar, below the roof rail, above the sill, and in front of any back door or wall.

Variable Name: Intruding Components (cont'd.)
(1st through 10th)

Code "30" (Hood) refers to the horizontal structure covering the front compartment of the vehicle located forward of the windshield.

Code "31" (Outside surface of this vehicle) is used when any outside surface of this vehicle not mentioned above has violated the internal boundary surface of the passenger compartment (e.g., spare tire, jack, outside mirror, etc.).

Code "32" (Other exterior object in the environment) refers to an object external to the vehicle (trees, poles, other vehicle, etc.) which penetrates the internal boundary of this vehicle.

Code "33" (Unknown exterior object) is used if there is evidence that an object intruded but it's unknown what that object was.

Code "97" (Catastrophic) is coded when the intrusion damage to the occupant compartment is so devastating that the researcher is not able to discern any of the following: specific occupant locations, intruding components, magnitude of intrusions, and dominant crush.

Code "98" [Intrusion of unlisted component(s)] is used if there is intrusion of any component not listed above.

Code "99" (Unknown) is used for the following situations.

- o The researcher cannot determine if there was any intrusion.
- o The vehicle was under repair at the time of inspection.

Variable Name: Magnitude of Intrusion

Element Values:

- 1 \geq 1 inch but < 3 inches
- 2 \geq 3 inches but < 6 inches
- 3 \geq 6 inches but < 12 inches
- 4 \geq 12 inches but < 18 inches
- 5 \geq 18 inches but < 24 inches
- 6 \geq 24 inches
- 7 Catastrophic
- 9 Unknown

Source: Vehicle inspection

The extent of component intrusion into a row sector is identified by ranges listed in codes "1"- "6". It should be noted the beginning value of a range should not exceed the pre-impact dimension of that sector. For example, the left front door intruded laterally through sector 11 and continued ten inches into sector 12 [see IV47 et al., code "11" (Front Seat - Left) and code "12" (Front Seat - Middle)]. If each sector had a pre-impact dimension of twenty inches, then for sector 11 code "5" (\geq 18 inches but < 24 inches) and for sector 12 code "3" (\geq 6 inches but < 12 inches).

As described in the intrusion overview, intrusions are listed in order of severity (i.e., code "6" takes priority over code "5", etc.) with only the ten highest intrusions encoded. Although sector 12 was encoded as the second highest intrusion in the simplistic example listed above, there may be situations where sector 12 would not be captured due to higher intrusion magnitudes in other sectors.

If the magnitude cannot be measured, but can be visibly seen, estimate the magnitude of the intrusion. If the estimated measurement is in the gray area between ranges, then default to the lower range. For example, if a measurement looks like it might be about five or six inches, then select the lower code, code "2" (\geq 3 inches but < 6 inches).

To determine sector dimensions, refer to the measurement techniques outlined in the intrusion overview and variables IV47 et al., Location of Intrusion.

Code "6" (\geq 24 inches) is used when an intrusion in a sector equals or exceeds twenty-four inches.

Code "7" (Catastrophic) is coded when the intrusion damage to the occupant compartment is so devastating that the researcher is not able to discern any of the following: specific occupant locations, intruding components, magnitude of intrusions, and dominant crush.

Variable Name: Magnitude of Intrusion (cont'd.)

Code "9" (Unknown) is used in the following situations.

- o The researcher cannot determine if there was any intrusion.
- o The vehicle was under repair at the time of inspection.
- o The researcher was not able to measure the intrusion.

Variable Name: Dominant Crush Direction

Element Values:

- 1 Vertical
- 2 Longitudinal
- 3 Lateral
- 7 Catastrophic
- 9 Unknown

Source: Vehicle inspection

Remarks:

This variable assesses the direction of displacement for the component identified in variables IV47 et al. The direction of movement is determined independently from the PDOF applied to the vehicle.

Code "1" (Vertical) refers to components which intrude into the passenger compartment from either an upward or downward direction.

Code "2" (Longitudinal) refers to components which move forward or rearward into the passenger compartment.

Code "3" (Lateral) refers to components which are displaced either left or right within the passenger compartment.

Code "7" (Catastrophic) is coded when the intrusion damage to the occupant compartment is so devastating that the researcher is not able to discern any of the following: specific occupant locations, intruding components, magnitude of intrusions, and dominant crush.

Code "9" (Unknown) is used for the following situations.

- o The researcher cannot determine if there was any intrusion.
- o The vehicle was under repair at the time of inspection.

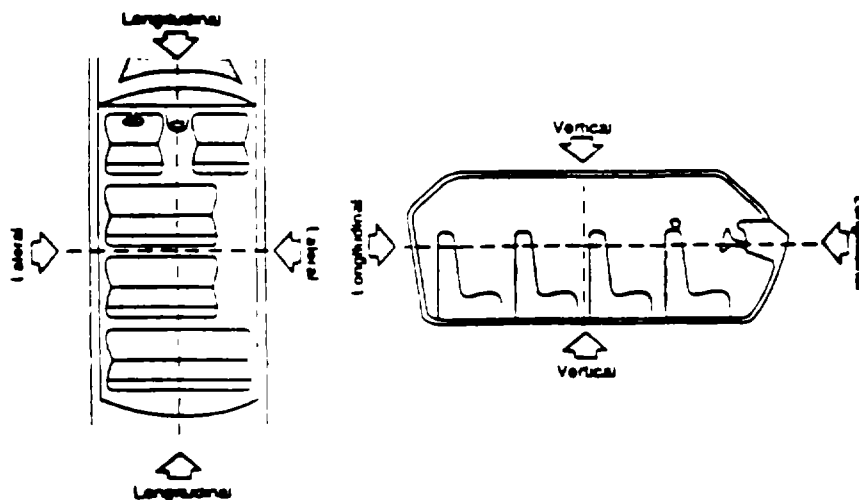

STEERING COLUMN OVERVIEW

Variables IV87 and IV92-IV93 identify specific areas of interest involving the steering column and steering rim/spokes. Information obtained from these components is crucial to the understanding of injury causation.

The researcher is required to identify steering column types and analyze steering rim/spokes (treated as one group) for steering column deformation.

Variable Name: Steering Column Type

Element Values:

- 1 Fixed column
- 2 Tilt column
- 3 Telescoping column
- 4 Tilt and telescoping column
- 8 Other column type (specify):
- 9 Unknown

Source: Vehicle inspection

Code "1" (Fixed column) refers to a standard nonadjustable steering column.

Code "2" (Tilt column) refers to a steering column designed to allow the steering wheel or column to be tilted at an angle selected by the operator to improve driving comfort. The presence of these types can generally be verified by the existence of an extra control stalk on the column. This stalk is separate from the turn signal, headlight, or wiper controls and is usually mounted near the bend point of the tilt wheel, or near the lower part of the instrument panel for the tilt column. Characteristically, the control stalk is unmarked and may be located on the left or right side of the column in relative proximity to the steering wheel end.

Code "3" (Telescoping column) refers to a steering column that has an adjustable length. The column can be shortened or lengthened to suit operator comfort. The telescoping feature can generally be identified by the presence of a knurled ring around the column. Rotating this ring allows the column to be lengthened or shortened, while retightening the ring locks the column at the desired adjustment.

Code "4" (Tilt and telescoping column) refers to a column that has both the tilt wheel and adjustable length features.

Code "8" (Other column type) includes steering columns which cannot be described by elements "1"- "4". This would include swing away columns, etc.

IV88
IV89
IV90
IV91

Variable Name: Blank

VARIABLES IV88 - IV91 ARE LEFT BLANK SO THAT NUMBERING CONSISTENCY CAN BE MAINTAINED WITH THE AUTOMATED FILES OF THE 1988 THROUGH 1990 NASS CRASHWORTHINESS DATA SYSTEM. PREVIOUS NAMES OF VARIABLES ARE AS FOLLOW:

- IV88 Steering Column Collapse Due to Occupant Loading
- IV89 Direction And Magnitude of Steering Column Vertical Movement
- IV90 Direction And Magnitude of Steering Column Lateral Movement
- IV91 Direction And Magnitude of Steering Column Longitudinal Movement

Variable Name: Steering Rim/Spoke Deformation

Element Values:

- 0 No steering rim deformation
- Code actual measured deformation to the nearest inch.
- 1-5 Actual measured value
- 6 6 inches or more
- 8 Observed deformation cannot be measured
- 9 Unknown

Source: Vehicle inspection.

Remarks:

The intent is to capture deformation caused by occupant contact rather than induced damage.

The center of the steering wheel hub is the reference plane for determining magnitude of deformation. A measurement is taken from this reference plane to that area of the rim which has the greatest deformation. This measurement should be referenced to an undisplaced area of the rim or compared to the rim of a similar undamaged vehicle.

The following diagram illustrates this measurement procedure.

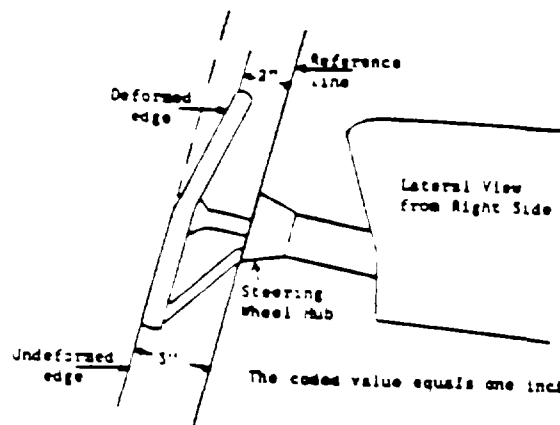

Code "0" (No steering rim deformation) is used when there was no deformation of the rim or spokes. Check your observation by placing a flat object (i.e., clipboard) across the plane of the steering rim prior to selecting this code.

Code "1" is used when the deformation is greater than zero but less than 1.5 inches.

Code "6" (6 inches or more) is used when deformation equals or exceeds 5.5 inches.

Variable Name: Steering Rim/Spoke Deformation (cont'd.)

Code "8" (Observed deformation cannot be measured) is used when the situation does not permit the direct measurement of a deformed rim.

Code "9" (Unknown) is used in the following situations.

- o It is not known if the rim was deformed by occupant contact.
- o An assessment of rim damage cannot be made because the vehicle is repaired.

Variable Name: Location of Steering Rim/Spoke Deformation

Element Values:

00 No steering rim deformation

Quarter Sections

01 Section A

02 Section B

03 Section C

04 Section D

Half Sections

05 Upper half of rim/spoke

06 Lower half of rim/spoke

07 Left half of rim/spoke

08 Right half of rim/spoke

09 Complete steering wheel collapse

10 Undetermined location

99 Unknown

Source: Vehicle inspection

Remarks:

The steering wheel rim is divided into four quarter sections (A through D) and four half sections (upper half, lower half, left half, right half). Note, the half designation should not be considered as a grouping of quarter sections. The accompanying diagrams identify the location of the quarter and half sections.

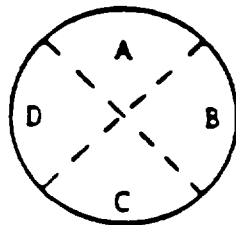

Quarter Sections

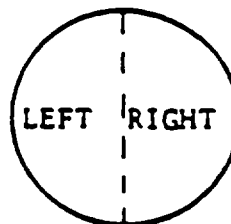
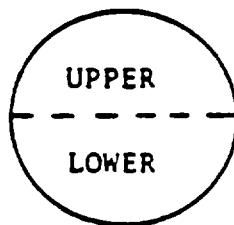

Half Sections

Variable Name: Location of Steering Rim/Spoke Deformation (cont'd.)

Evaluate the deformation of the rim with respect to the wheel design and not the wheel position observed during the vehicle inspection. For example, if the designed top section was deformed and rotated to the bottom position, then the correct response for this variable is "01" (Section A); see below.

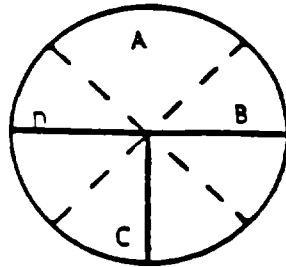

Straight Ahead
Position

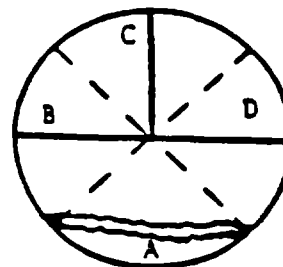

Post-impact
Position

When evaluating which quarter or half to encode, place primary emphasis upon downward deflection since the coding captures occupant caused deformation. When two half sections are deformed, select the half with the greatest deformation.

Code "09" (Complete steering wheel collapse) is used in the event two half sections are deformed axially downward, beyond the hub.

Code "10" (Undetermined location) is used when it is known the rim was deformed, but as the result of extrication or other post-impact activity the original deformed section could not be determined.

Code "99" (Unknown) is used in the following situations.

- It is not known if the rim was deformed by occupant contact.
- An assessment of rim damage could not be made as the vehicle was repaired.

Variable Name: Odometer Reading

Element Values:

Range: 000, 001 through 300, 999

Miles - Code mileage to the nearest 1,000 miles

000 No odometer
 001 Less than 1,500 miles
 300 299,500 miles or more
 999 Unknown

Source: Primary source is the vehicle inspection.

Remarks:

This variable measures the vehicle's mileage as indicated on the odometer. However, in cases where it is known that the odometer was working but had turned over (i.e., recycled) the coded value represents the total mileage on the vehicle rather than the reading on the odometer. Annotate the source of information when it is determined that the odometer had turned over.

Code to the nearest 1,000 miles as in the examples below.

Mileage: 7,498
 Code: "007"

Mileage: 18,342
 Code: "018"

Mileage: 7,502
 Code: "008"

Mileage: 147,687
 Code: "148"

Code "000" (No odometer) is used for vehicles manufactured without an odometer.

Code "001" (Less than 1,500 miles) if the mileage is less than 1,500 miles.

Code "999" (Unknown) is used when:

- o it is known that the odometer was disconnected or broken before the collision;
- o the vehicle is equipped with an electronic instrument cluster and an analog "back-up" odometer is not present; or
- o the mileage is unknown.

Variable Name: Instrument Panel Damage from Occupant Contact?

Element Values:

- 0 No
- 1 Yes
- 9 Unknown

Source: Vehicle inspection only.

Remarks:

Instrument panel damage is defined as damage caused by occupant contact during the impact sequence. This damage includes: breakage, dents, scratches, and abrasions. Deformities resulting from impact forces such as lateral shift or buckling are excluded.

The instrument panel is defined as that panel extending horizontally from A-pillar to A-pillar (Figure 1) and vertically from the lower part of the windshield to the lowest vertical edge of the panel (Figure 2). This excludes the steering assembly and all center mounted consoles.

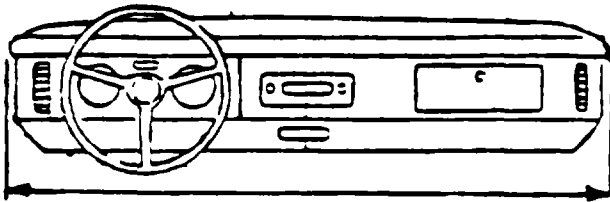

Figure 1

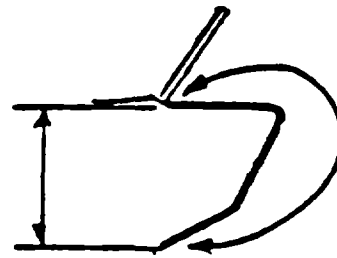

Figure 2

Code "0" (No) is used when the instrument panel was not damaged by occupant contact.

Code "1" (Yes) is used when the instrument panel was damaged by occupant contact.

Code "9" (Unknown) is used when the instrument panel is under repair or replaced.

Variable Name: Knee Bolsters Deformed from Occupant Contact?

Element Values:

- 0 No
- 1 Yes
- 8 Not present
- 9 Unknown

Source: Vehicle inspection.

Remarks:

Knee bolsters are defined as energy absorbing panels fitted to the lower portion of the instrument panel to help restrict forward movement of the front seat occupant's lower body during an accident. Knee bolsters may or may not extend from A-pillar to A-pillar depending on the vehicle make and model. Vehicles equipped with a passive restraint system using only an upper torso (shoulder) belt or an airbag are generally equipped with a knee bolster. This padded attachment is designed to prevent the occupant from submarining under the shoulder belt and instrument panel during an impact. The diagram below illustrates the location of the knee bolster in relation to the vehicle occupant.

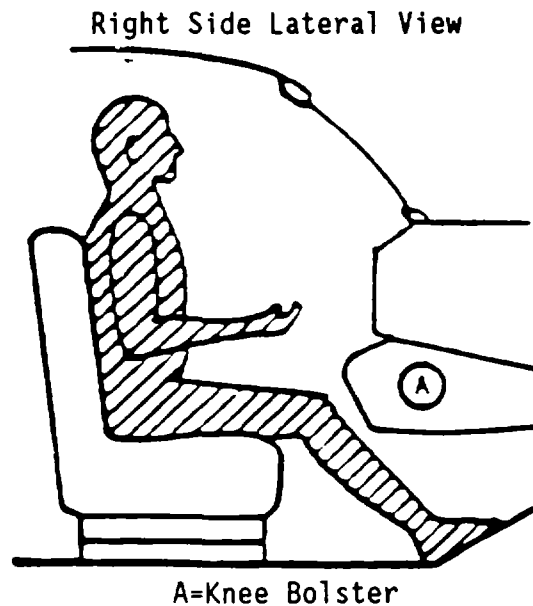

This variable reports deformation (indentation) of the knee bolster as a result of occupant contact and not as a result of impact related damage.

Code "0" (No) is used when there is no occupant caused deformation of the knee bolster. Minor scuffing and transfers are not considered deformation.

Variable Name: Knee Bolsters Deformed from Occupant Contact? (cont'd.)

Code "1" (Yes) is used when occupant caused deformation is present on the knee bolster. Minor dents are considered deformation; however, scuffing and transfers are not deformation. Occupant contact evidence is included on the Vehicle Interior Sketches page, Points of Occupant Contact page, and highlighted in the photographs.

Code "8" (Not present) is used when no knee bolster is present.

Code "9" (Unknown) is used when knee bolster deformation is present but it is unknown if it was occupant caused.

Variable Name: Did Glove Compartment Door Open During Collision(s)?

Element Values:

- 0 No
- 1 Yes
- 8 Not present
- 9 Unknown

Source: Researcher determined; inputs include the vehicle inspection and interview.

Remarks:

This variable reports the status of the glove compartment door (if present) during an accident. The primary objective is to determine whether the door latch mechanism released during a collision(s).

Code "0" (No) is used when the door did not open or the door opened but the latch mechanism did not fail (e.g., body of door separates from the latch mechanism which is intact and engaged).

Code "1" (Yes) is used when the door opened because the latch mechanism released. Reasons may include: occupant contact, shifting or buckling of vehicle components, or impact forces.

Code "8" (Not present) is used when no glove compartment door is available (i.e., vans).

Code "9" (Unknown) is used when:

- o that portion of the instrument panel is under repair, or
- o the glove box door is known to be open but it is unknown whether the door opened as a result of the accident [i.e., door could have been open prior to the accident, or it could have been opened after the accident (e.g., to remove driver registration information)].

**INSTRUCTIONS FOR COMPLETION OF VEHICLE INTERIOR SKETCHES
AND POINTS OF OCCUPANT CONTACT PAGES**

The VEHICLE INTERIOR SKETCHES page and corresponding POINTS OF OCCUPANT CONTACT page provide a valuable link between vehicle interior documentation and occupant injury data. Properly completed, these records identify evidence of occupant contact points and relate the contact points to the part of the occupant's body that produced the evidence.

In completing the Vehicle Interior Sketches, assess the occupant trajectory in conjunction with the impact configuration, direction of force, and use of restraints. As contact points are identified, they should be documented as follows.

- o Sketch the damaged area on the instrument panel outline (e.g., radio, glove compartment, damage to instrument panel structure).
- o Annotate the contacted area with a letter (begin with A) and list on the Points of Occupant Contact page.
- o In the column adjacent to the respective letter, identify the interior component contacted. Specify the number of the contacting occupant if it can be determined.
- o Identify the type of evidence present (i.e., scuff, tissue transfer, tooth, etc.) in the "Supporting Physical Evidence" column.
- o Specify the level of confidence which you feel best represents your conclusion using the scale of: 1 (Certain), 2 (Probable), 3 (Possible), or 4 (Unknown).
- o Within the vehicle, highlight the contact with yellow (or similar) tape for photographic purposes.
- o Annotate the area through which the occupant was ejected or the area in which the occupant was entrapped.

An example of a completed Vehicle Interior Sketches (Page 4) and Points of Occupant Contact (Page 5) page follow. If sufficient space is not available to identify all contacts, use the back of the Page 4.

INSTRUCTIONS FOR COMPLETION OF VEHICLE INTERIOR SKETCHES
AND POINTS OF OCCUPANT CONTACT PAGES

(2)

VEHICLE INTERIOR SKETCHES

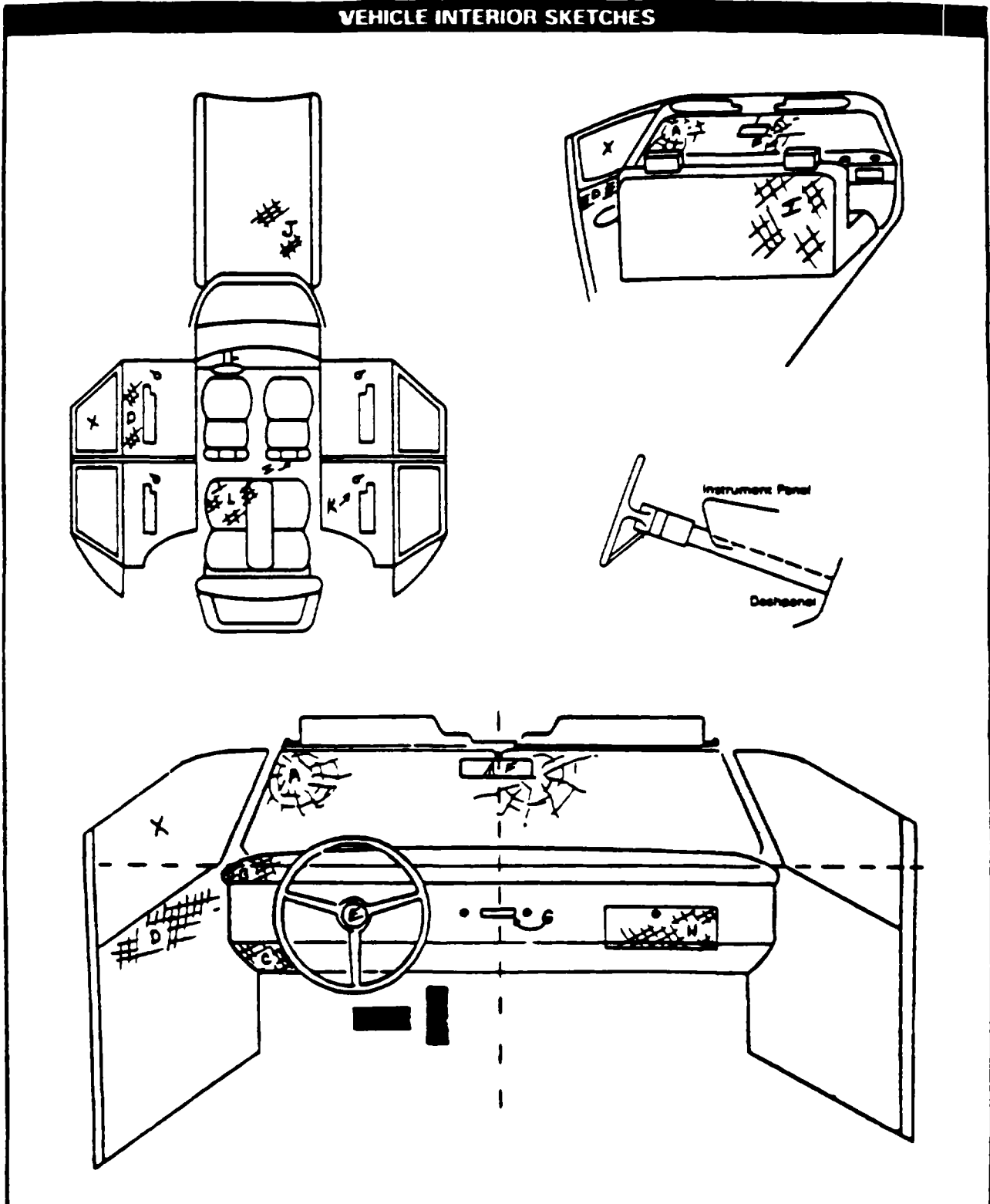

INSTRUCTIONS FOR COMPLETION OF VEHICLE INTERIOR SKETCHES AND POINTS OF OCCUPANT CONTACT PAGES

(3)

POINTS OF OCCUPANT CONTACT					
Contact	Interior Component Contacted	Occupant No. if Known	Body Region if Known	Supporting Physical Evidence	Confidence Level of Contact Point
A	01	1	head	dark hair, windshield contact	1
B	09	1	hand?	deformation, tissue transfer	1
C	09	1	h. knee	plastic cracked, debris on CF	1
D	20	1	shoulder?	deformed outward	1
E	06	1	chest	vin deformed, hub on floor	1
F	15	2	head	mirror cracked, contact windshield	1
G	10	2	UNK.	control knob missing	2
H	12	2	knees?	plastic door shattered	1
I	40	3	Torso	deformed forward, cracked, torn	1
J	54	3	head	hair lodged in coarse fabric	1
K	30	3	UNK.	door handle missing	3
L	40	3	-	blood deposit, probable V&P's	2
M					
N					
O					

CODES FOR INTERIOR COMPONENTS

FRONT

- 01: Windshield
- 02: Mirror
- 03: Sunvisor
- 04: Steering wheel rim
- 05: Steering wheel hub spoke
- 06: Steering wheel (combination of codes 04 and 05)
- 07: Steering column, transmission selector lever, other attachment
- 08: Add on equipment (e.g. CB, tape deck, air conditioner)
- 09: Left instrument panel and below
- 10: Center instrument panel and below
- 11: Right instrument panel and below
- 12: Glove compartment door
- 13: Knee bolster
- 14: Windshield including one or more of the following: front header, A-pillar, instrument panel, mirror, steering assembly
- 15: Windshield including one or more of the following: front header, A-pillar, instrument panel, mirror
- 16: Other front object (specify): _____

LEFT SIDE

- 20: Left side interior surface, excluding hardware or armrests
- 21: Left side hardware or armrest
- 22: Left A pillar
- 23: Left B pillar
- 24: Other left pillar (specify): _____
- 25: Left side window glass or frame

RIGHT SIDE

- 26: Left side window glass including one or more of the following: frame, window sill, A-pillar, B-pillar, roof side rails
- 27: Other left side object (specify): _____
- 30: Right side interior surface excluding hardware or armrests
- 31: Right side hardware or armrest
- 32: Right A pillar
- 33: Right B pillar
- 34: Other right pillar (specify): _____
- 35: Right side window glass or frame
- 36: Right side window glass including one or more of the following: frame, window sill, A-pillar, B-pillar, roof side rails
- 37: Other right side object (specify): _____

INTERIOR

- 40: Seat back support
- 41: Belt restraint webbing/buckle
- 42: Belt restraint B-pillar attachment point
- 43: Other restraint system component (specify): _____
- 44: Head restraint system
- 45: Air cushion
- 46: Other occupants (specify): _____
- 47: Interior loose objects

ROOF

- 50: Front header
- 51: Rear header
- 52: Roof left side rails
- 53: Roof right side rails
- 54: Roof or convertible top

FLOOR

- 60: Floor including toe pan
- 61: Floor or console mounted transmission lever including console
- 62: Parking brake handle
- 63: Foot controls including parking brake

REAR

- 64: Backlight (rear window)
- 65: Backlight storage rack, door etc.
- 66: Other rear object (specify): _____

CONFIDENCE LEVEL OF CONTACT POINT

- (1) Certain
- (2) Probable
- (3) Possible
- (4) Unknown

(48) Child/infant restraint (specify): _____

(49) Other interior object (specify): _____

MANUAL RESTRAINTS

Restraint usage data, recorded on the noncoded section of the Interior Vehicle Form under the title "MANUAL RESTRAINTS", is based solely on the evidence obtained during the vehicle inspection.

An indication of restraint usage is determined for every seating position in the vehicle, regardless of whether the seating position is occupied. The "indication of usage" represents "**recent usage**" rather than "usage ever", whenever possible. The following evidence is sought when assessing restraint usage:

- o **belts/fittings damaged by occupant loading:** deformed anchor components, stretched webbing, latch metal peening (loading impression on metal);
- o **placement of belts:** on, behind, or under seatbacks or cushions; and,
- o **condition of belts:** dirty, dust covered, mechanically unusable, knotted, size adjustment on fixed length belts, cut for convenience or comfort (out of the way, near housings), or cut for occupant extraction by emergency personnel (usually at an easily accessible position).

Restraint "usage in this accident" is not generally determined on the Interior Vehicle Form. Vehicle evidence along with police report information, interviews, relationship of contact points to seat position given the FDOF applied to the vehicle, presence of belt-caused occupant injuries, and presence or absence of ejection are considered before encoding restraint usage on the Occupant Assessment Form.

CHILD SAFETY SEAT FIELD ASSESSMENT

For each child safety seat present in the vehicle, assign (unless you have knowledge regarding what the occupant's number is) the seat a temporary occupant number. Determine the correct answer for each of the six row variables present on the reverse side of **Page 6**. Due to the transient nature of child safety seats, annotate questions regarding its position for use during the interview. From this data, the actual position of the child safety seat at the time of the accident and the occupant's correct number can be determined for the inclusion on the Occupant Assessment Form.



OCCUPANT ASSESSMENT FORM

<p>1. Primary Sampling Unit Number _____</p> <p>2. Case Number – Stratum _____</p> <p>3. Vehicle Number _____</p> <p>4. Occupant Number _____</p>	<p>11. Occupant's Posture _____</p> <p>(0) Normal posture</p> <p>(1) Abnormal posture (specify): _____</p> <p>(9) Unknown</p>
EJECTION/ENTRAPMENT	
OCCUPANT'S CHARACTERISTICS	
<p>5. Occupant's Age _____</p> <p>Code actual age at time of accident.</p> <p>(00) Less than one year old (specify by month): _____</p> <p>(97) 97 years and older</p> <p>(99) Unknown</p> <p>6. Occupant's Sex _____</p> <p>(1) Male</p> <p>(2) Female</p> <p>(9) Unknown</p> <p>7. Occupant's Height _____</p> <p>Code actual height to the nearest inch.</p> <p>(99) Unknown</p> <p>8. Occupant's Weight _____</p> <p>Code actual weight to the nearest pound.</p> <p>(999) Unknown</p> <p>9. Occupant's Role _____</p> <p>(1) Driver</p> <p>(2) Passenger</p> <p>(9) Unknown</p> <p>10. Occupant's Seat Position _____</p> <p>Front Seat</p> <p>(11) Left side</p> <p>(12) Middle</p> <p>(13) Right side</p> <p>(14) Other (specify): _____</p> <p>(15) On or in the lap of another occupant</p> <p>Second Seat</p> <p>(21) Left side</p> <p>(22) Middle</p> <p>(23) Right side</p> <p>(24) Other (specify): _____</p> <p>(25) On or in the lap of another occupant</p> <p>Third Seat</p> <p>(31) Left side</p> <p>(32) Middle</p> <p>(33) Right side</p> <p>(34) Other (specify): _____</p> <p>(35) On or in the lap of another occupant</p> <p>Fourth Seat</p> <p>(41) Left side</p> <p>(42) Middle</p> <p>(43) Right side</p> <p>(44) Other (specify): _____</p> <p>(45) On or in the lap of another occupant</p> <p>(97) In or on unenclosed area</p> <p>(98) Other seat (specify): _____</p> <p>(99) Unknown</p>	<p>12. Ejection _____</p> <p>(0) No ejection</p> <p>(1) Complete ejection</p> <p>(2) Partial ejection</p> <p>(3) Ejection, unknown degree</p> <p>(9) Unknown</p> <p>13. Ejection Area _____</p> <p>(0) No ejection</p> <p>(1) Windshield</p> <p>(2) Left front</p> <p>(3) Right front</p> <p>(4) Left rear</p> <p>(5) Right rear</p> <p>(6) Rear</p> <p>(7) Roof</p> <p>(8) Other area (e.g., back of pickup, etc.)</p> <p>(specify): _____</p> <p>(9) Unknown</p> <p>14. Ejection Medium _____</p> <p>(0) No ejection</p> <p>(1) Door/hatch/tailgate</p> <p>(2) Nonfixed roof structure</p> <p>(3) Fixed glazing</p> <p>(4) Nonfixed glazing (specify): _____</p> <p>(5) Integral structure</p> <p>(8) Other medium (specify): _____</p> <p>(9) Unknown</p> <p>15. Medium Status (Immediately Prior to Impact) _____</p> <p>(0) No ejection</p> <p>(1) Open</p> <p>(2) Closed</p> <p>(3) Integral structure</p> <p>(9) Unknown</p> <p>16. Entrapment _____</p> <p>(NOTE: Entrapped means that part of the person was in the vehicle and mechanically restrained; jammed doors and immobilizing injuries by themselves are not sufficient to constitute entrapment.)</p> <p>(0) Not entrapped</p> <p>(1) Entrapped</p> <p>(9) Unknown</p>

RESTRAINT SYSTEM AND SEAT EVALUATION**17. Manual (Active) Belt System Availability** _____

- (0) Not available
- (1) Belt removed/destroyed
- (2) Shoulder belt
- (3) Lap belt
- (4) Lap and shoulder belt
- (5) Belt available – type unknown
- (8) Other belt (specify): _____

(9) Unknown

18. Manual (Active) Belt System Use _____

- (00) None used, not available, or belt removed/destroyed
- (01) Inoperative (specify): _____

- (02) Shoulder belt
- (03) Lap belt
- (04) Lap and shoulder belt
- (05) Belt used – type unknown
- (08) Other belt used (specify): _____

- (12) Shoulder belt used with child safety seat
- (13) Lap belt used with child safety seat
- (14) Lap and shoulder belt used with child safety seat
- (15) Belt used with child safety seat – type unknown
- (18) Other belt used with child safety seat

(specify): _____

(99) Unknown if belt used

19. Proper Use of Manual (Active) Belts _____

- (0) None used or not available
- (1) Belt used properly
- (2) Belt used properly with child safety seat

Belt Used Improperly

- (3) Shoulder belt worn under arm
- (4) Shoulder belt worn behind back or seat
- (5) Belt worn around more than one person
- (6) Lap belt worn on abdomen
- (7) Lap belt or lap and shoulder belt used improperly with child safety seat (specify): _____

(8) Other improper use of manual belt system (specify): _____

(9) Unknown

20. Manual (Active) Belt Failure Modes During Accident _____

- (0) No manual belt used or not available
- (1) No manual belt failure(s)
- (2) Torn webbing (stretched webbing not included)
- (3) Broken buckle or latchplate
- (4) Upper anchorage separated
- (5) Other anchorage separated (specify): _____

- (6) Broken retractor
- (7) Combination of above (specify): _____

(8) Other manual belt failure (specify): _____

(9) Unknown

21. Air Bag System Availability/Function _____

- (0) Not equipped/not available
- (1) Air bag

Non-functional

(2) Air bag disconnected (specify): _____

- (3) Air bag not reinstalled
- (9) Unknown

22. Air Bag System Deployment _____

- (0) Not equipped/not available
- (1) Air bag deployed during accident
- (2) Air bag deployed inadvertently just prior to accident
- (3) Air bag deployed, accident sequence undetermined
- (4) Nondeployed
- (5) Unknown if deployed
- (9) Unknown

23. Did Air Bag System Fail? _____

- (0) Not equipped/not available
- (1) No
- (2) Yes (specify): _____

(9) Unknown

Note: See Variables 44 through 48 (Page 5) for Information on Automatic Belts

24. Police Reported Restraint Use _____

- (0) None used
- (1) Police did not indicate restraint use
- (2) Shoulder belt
- (3) Lap belt
- (4) Lap and shoulder belt
- (5) Belt used, type not specified
- (6) Child safety seat
- (7) Other or automatic restraint (specify): _____

- (8) Restrained, type unknown
- (9) Police indicated "unknown"

25. Head Restraint Type/Damage by Occupant at This Occupant Position _____

- (0) No head restraints
- (1) Integral – no damage
- (2) Integral – damaged during accident
- (3) Adjustable – no damage
- (4) Adjustable – damaged during accident
- (5) Add-on – no damage
- (6) Add-on – damaged during accident
- (8) Other (specify): _____

(9) Unknown

26. Seat Type (This Occupant Position) _____

(00) Occupant not seated or no seat
 (01) Bucket
 (02) Bucket with folding back
 (03) Bench
 (04) Bench with separate back cushions
 (05) Bench with folding back(s)
 (06) Split bench with separate back cushions
 (07) Split bench with folding back(s)
 (08) Pedestal (i.e., van type)
 (09) Other seat type (specify):

(99) Unknown

27. Seat Performance (This Occupant Position) _____

(0) Occupant not seated or no seat
 (1) No seat performance failure(s)
 (2) Seat adjusters failed
 (3) Seat back folding locks failed
 (4) Seat track/anchors failed
 (5) Deformed by impact of occupant
 (6) Deformed by passenger compartment intrusion (specify):

(7) Combination of above (specify):

(8) Other (specify):

(9) Unknown

30. Child Safety Seat Orientation _____

(00) No child safety seat

Designed for Rear Facing for This Age/Weight
 (01) Rear facing
 (02) Forward facing
 (08) Other orientation (specify):

(09) Unknown orientation

Designed for Forward Facing for This Age/Weight
 (11) Rear facing
 (12) Forward facing
 (18) Other orientation (specify):

(19) Unknown orientation

Unknown Design or Orientation for This Age/Weight, or Unknown Age/Weight
 (21) Rear facing
 (22) Forward facing
 (28) Other orientation (specify):

(29) Unknown orientation

(99) Unknown if child safety seat used

31. Child Safety Seat Harness Usage _____

32. Child Safety Seat Shield Usage _____

33. Child Safety Seat Tether Usage _____

Note: Options below applicable to Variables OA31-OA33.
 (00) No child safety seat

Not Designed with Harness/Shield/Tether
 (01) After market harness/shield/tether added, not used
 (02) After market harness/shield/tether used
 (03) Child safety seat used, but no after market harness/shield/tether added
 (09) Unknown if harness/shield/tether added or used

Designed with Harness/Shield/Tether
 (11) Harness/shield/tether not used
 (12) Harness/shield/tether used
 (19) Unknown if harness/shield/tether used

Unknown If Designed with Harness/Shield/Tether
 (21) Harness/shield/tether not used
 (22) Harness/shield/tether used
 (29) Unknown if harness/shield/tether used

(99) Unknown if child safety seat used

CHILD SAFETY SEAT

28. Child Safety Seat Make/Model _____

(000) No child safety seat
 Applicable codes are found in your NASS CDS Data Collection, Coding, and Editing Manual
 (997) Other make/model (specify):

(998) Unknown make/model
 (999) Unknown if child safety seat used

29. Type of Child Safety Seat _____

(0) No child safety seat
 (1) Infant seat
 (2) Toddler seat
 (3) Convertible seat
 (4) Booster seat
 (7) Other type child safety seat (specify):

(8) Unknown child safety seat type
 (9) Unknown if child safety seat used

INJURY CONSEQUENCES

- 34. Injury Severity (Police Rating)** _____
- (0) O—No injury
 - (1) C—Possible injury
 - (2) B—Nonincapacitating injury
 - (3) A—Incapacitating injury
 - (4) K—Killed
 - (5) U—Injury, severity unknown
 - (6) Died prior to accident
 - (9) Unknown
- 35. Treatment—Mortality** _____
- (0) No treatment
 - (1) Fatal
 - (2) Fatal—ruled disease
- Nonfatal
- (3) Hospitalized
 - (4) Transported and released
 - (5) Treatment at scene—nontransported
 - (6) Treatment later
 - (8) Treatment—other (specify):

 - (9) Unknown
- 36. Type of Medical Facility (for Initial Treatment)** _____
- (0) Not treated at a medical facility
 - (1) Trauma center
 - (2) Hospital
 - (3) Medical clinic
 - (4) Physician's office
 - (5) Treatment later at medical facility
 - (8) Other (specify):

 - (9) Unknown
- 37. Hospital stay** _____
- _____ Code number of days (up through 60) that the occupant stayed in the hospital
- (00) Not hospitalized
 - (61) 61 days or more
 - (99) Unknown

- 38. Working Days Lost** _____
- _____ Code the number of days (up through 60) that the occupant lost from work due to the accident
- (00) No working days lost
 - (61) 61 days or more
 - (62) Fatally injured
 - (97) Not working prior to accident
 - (99) Unknown
- 39. Time to Death** _____
- _____ Code number of hours from time of accident to time of death up through 24 hours. If time of death is greater than 24 hours, code number of days. (Note: 1 day = 24 hours, 2 days = 48, ... n days = 24 + n up through 30 days = 60)
- (00) Not fatal
 - (96) Fatal—ruled disease
 - (99) Unknown
- 40. 1st Medically Reported Cause of Death** _____
- 41. 2nd Medically Reported Cause of Death** _____
- 42. 3rd Medically Reported Cause of Death** _____
- _____ Code the Occupant Injury from line number(s) for the medically reported injury(s) which reportedly contributed to this occupant's death
- (00) Not fatal or no additional causes
 - (97) Other result (specify):

 - (99) Unknown
- 43. Number of Recorded Injuries for This Occupant** _____
- _____ Code the actual number of injuries recorded for this occupant.
- (00) No recorded injuries
 - (97) Injured, details unknown
 - (99) Unknown if injured

<p>44. Automatic (Passive) Belt System Availability/ Function _____</p> <ul style="list-style-type: none"> (0) Not equipped/not available (1) 2 point automatic belts (2) 3 point automatic belts (3) Automatic belts - type unknown <p>Non-functional</p> <ul style="list-style-type: none"> (4) Automatic belts destroyed or rendered inoperative (9) Unknown <p>45. Automatic (Passive) Belt System Use _____</p> <ul style="list-style-type: none"> (0) Not equipped/not available/destroyed or rendered inoperative (1) Automatic belt in use (2) Automatic belt not in use (manually disconnected, motorized track inoperative) (specify): _____ (3) Automatic belt use unknown (9) Unknown <p>46. Automatic (Passive) Belt System Type _____</p> <ul style="list-style-type: none"> (0) Not equipped/not available (1) Non-motorized system (2) Motorized system (9) Unknown 	<p>47. Proper Use of Automatic (Passive) Belt System _____</p> <ul style="list-style-type: none"> (0) Not equipped/not available/not used (1) Automatic belt used properly (2) Automatic belt used properly with child safety seat <p>Automatic Belt Used Improperly</p> <ul style="list-style-type: none"> (3) Automatic shoulder belt worn under arm (4) Automatic shoulder belt worn behind back (5) Automatic belt worn around more than one person (6) Lap portion of automatic belt worn on abdomen (7) Automatic lap and shoulder belt or automatic shoulder belt used improperly with child safety seat (specify): _____ (8) Other improper use of automatic belt system (specify): _____ (9) Unknown <p>48. Automatic (Passive) Belt Failure Modes During Accident _____</p> <ul style="list-style-type: none"> (0) Not equipped/not available/not in use (1) No automatic belt failure(s) (2) Torn webbing (stretched webbing not included) (3) Broken buckle or latchplate (4) Upper anchorage separated (5) Other anchorage separated (specify): _____ (6) Broken retractor (7) Combination of above (specify): _____ (8) Other automatic belt failure (specify): _____ (9) Unknown
--	---

UPDATE CANDIDATE? NO [] YES []

OCCUPANT INJURY FORM INCLUDED WITH INITIAL SUBMISSION? NO [] YES []

***** STOP HERE *****
IF THERE ARE NO RECORDED INJURIES
(I.E., OA43 = 00,97,99)

OCCUPANT ASSESSMENT LOG

Performance Assessment

TO BE COMPLETED BY TEAM		13. Injury Information												
1. PSU Number ___		<u>Official</u>												
2. Case Number - Stratum _____		a. Autopsy (invasive examination) ___												
3. Researcher Completing Form ___		b. Post-ER medical record which includes information about death based on non-invasive examination ___												
4. Vehicle Number ___		c. Admission record/summary of admission/discharge face sheet ___												
5. Occupant Number ___		d. Discharge summary ___												
6. Interviewer Number ___		e. Radiographic record(s) post ER visit ___												
7. Date Interview Completed ___/___/___		f. History and physical examination and/or consultation records ___												
8. Occupant's Role ___		g. Emergency room records ___												
(1) Driver		h. Radiographic record(s) associated with ER visit ___												
(2) Passenger		i. Private physician ___												
(3) Unknown		<u>Unofficial</u>												
9. Interviewee For This Occupant ___		j. Lay coroner ___												
(0) No interview		k. EMS record ___												
(1) Same person		l. Interviewee ___												
<u>Surrogate</u>		m. Other source (specify): _____ ___												
(2) Other occupant		n. Police report ___												
(3) Relative or friend														
(4) Multiple interviewees from above categories (specify): _____														
10. Manner Of Interview ___		(See reverse side of this page for codes for variable 13)												
(0) No attempt														
(1) Telephone														
(2) In-person														
(3) Questionnaire														
(9) Unknown (for Zone Center use only)														
11. Result Of Interview Attempt ___														
(01) Unable to contact or locate														
(02) Hit and run														
(03) Fatal - surrogate not available														
(04) In intensive care - surrogate not available														
(05) Out-of-state resident														
(06) Refused interview														
(07) Insurance company refusal														
(08) Attorney refusal or litigation														
(09) No return of questionnaire														
(10) Other (specify): _____														
(11) Return of completed questionnaire														
(12) Partial interview														
(13) Complete interview														
12. Injury Treatment Status ___														
(0) No treatment														
(1) Fatal - died before hospitalization														
(2) Fatal - died after hospitalization														
(3) Hospitalization														
(4) Emergency room treatment only														
(5) Treatment at physician's office														
(6) Treatment at scene or self treatment														
(9) Unknown														
		14. Medical Facility Code ___												
		TO BE COMPLETED BY ZONE CENTER												
		15. Documentation of Occupant Interview (Excludes Injury Data) ___												
		(0) Not applicable												
		(1) Substandard												
		(2) Standard												
		(3) Above Standard												
		DATA STATUS OF VARIABLE NUMBERS 4-48												
		4 5 6 7 8 9 10 11 12 13 14												
		<table border="1" style="width: 100%; border-collapse: collapse;"> <tr> <td style="width: 25px; height: 20px;"></td> <td style="width: 25px; height: 20px;"></td> <td style="width: 25px; height: 20px;"></td> <td style="width: 25px; height: 20px;"></td> <td style="width: 25px; height: 20px;"></td> <td style="width: 25px; height: 20px;"></td> <td style="width: 25px; height: 20px;"></td> <td style="width: 25px; height: 20px;"></td> <td style="width: 25px; height: 20px;"></td> <td style="width: 25px; height: 20px;"></td> <td style="width: 25px; height: 20px;"></td> </tr> </table>												
		15 16 17 18 19 20 21 22 23 24 25												
		<table border="1" style="width: 100%; border-collapse: collapse;"> <tr> <td style="width: 25px; height: 20px;"></td> <td style="width: 25px; height: 20px;"></td> <td style="width: 25px; height: 20px;"></td> <td style="width: 25px; height: 20px;"></td> <td style="width: 25px; height: 20px;"></td> <td style="width: 25px; height: 20px;"></td> <td style="width: 25px; height: 20px;"></td> <td style="width: 25px; height: 20px;"></td> <td style="width: 25px; height: 20px;"></td> <td style="width: 25px; height: 20px;"></td> <td style="width: 25px; height: 20px;"></td> </tr> </table>												
		26 27 28 29 30 31 32 33 34 35 36												
		<table border="1" style="width: 100%; border-collapse: collapse;"> <tr> <td style="width: 25px; height: 20px;"></td> <td style="width: 25px; height: 20px;"></td> <td style="width: 25px; height: 20px;"></td> <td style="width: 25px; height: 20px;"></td> <td style="width: 25px; height: 20px;"></td> <td style="width: 25px; height: 20px;"></td> <td style="width: 25px; height: 20px;"></td> <td style="width: 25px; height: 20px;"></td> <td style="width: 25px; height: 20px;"></td> <td style="width: 25px; height: 20px;"></td> <td style="width: 25px; height: 20px;"></td> </tr> </table>												
		37 38 39 40 41 42 43 44 45 46 47												
		<table border="1" style="width: 100%; border-collapse: collapse;"> <tr> <td style="width: 25px; height: 20px;"></td> <td style="width: 25px; height: 20px;"></td> <td style="width: 25px; height: 20px;"></td> <td style="width: 25px; height: 20px;"></td> <td style="width: 25px; height: 20px;"></td> <td style="width: 25px; height: 20px;"></td> <td style="width: 25px; height: 20px;"></td> <td style="width: 25px; height: 20px;"></td> <td style="width: 25px; height: 20px;"></td> <td style="width: 25px; height: 20px;"></td> <td style="width: 25px; height: 20px;"></td> </tr> </table>												
		48												
		<table border="1" style="width: 20px; height: 20px; border-collapse: collapse;"> <tr> <td style="width: 20px; height: 20px;"></td> </tr> </table>												
		Data Status Codes:												
		(Blank) Correct	(4) Change--no error											
		(1) Derived error	(5) Sequencing error											
		(2) Non-correctable error	(8) MDE error											
		(3) Correctable error	(9) Unknown coded											

National Accident Sampling System-Crashworthiness Data System: Occupant Assessment Log

C DES F R OCCUPANT ASSESSMENT LOG VARIABLE 13 (INJURY INFORMATION)

(Blank) Not medically treated/record not required

(01) No record of treatment at medical facility

(02) Medical release required - not obtained

(03) Injury not related to accident

(04) Noncooperative hospital

(05) Hospital out-of-study area

(06) Private physician would not release data

(07) Unknown if medically treated

(08) To be updated

(09) Record not received before file closeout

(10) Record not obtained

(11) Record obtained

(12) Partial record obtained - not to be updated

(13) Partial record obtained - to be updated

Variable Name: Vehicle Number

Element Values:

Range: 01 through 30

Source: Researcher assigned.

Remarks:

Code the Vehicle Number for the vehicle, in or on which, this occupant was riding (i.e., as a driver or as a passenger--in or on the vehicle). See GV03, Vehicle Number.

Assume that only one occupant is in a hit-and-run vehicle (unless reliable evidence to the contrary exists), and assume this person is the driver.

This variable is a file structuring variable.

Variable Name: Occupant Number

Element Values:

Range: 01 through 30

Source: Researcher assigned.

Remarks:

Occupant numbers must be assigned sequentially, beginning in the enclosed area with "01". No numbers may be skipped. Assign numbers left to right and front to back among occupants.

Assign numbers last to persons on the vehicle or in an unenclosed area. Persons appended to vehicle for motion (e.g., bicyclist holding onto vehicle) are either pedestrians or other nonmotorists and not occupants; therefore, no form is completed, and no number is assigned.

Drivers do not have to be coded "01" (e.g., right hand drive vehicles containing left front occupant). However, code the assumed driver of a hit-and-run vehicle as "01".

An occupant on or in the lap of another person should be assigned a number one higher than the person whose lap they were on or in.

Occupants sharing a seating position should be assigned numbers using the guidelines stated in the first paragraph above.

This variable is a file structuring variable.

OCCUPANT'S CHARACTERISTICS OVERVIEW

The Occupant's characteristics section of the Occupant Assessment Form consists of two areas, physical characteristics, and role/position. These two areas provide a coded sketch of the occupant. Physical characteristics are noted in the variables OA06 (Occupant's Sex), OA07 (Occupant's Height), and OA08 (Occupant's Weight). The demographics of the occupant are completed by the variable OA05 (Occupant's Age). Position and function of the occupant are also critical bits of information in the overall picture of the accident. These are provided by the variables OA10 (Occupant's Seating Position), OA09 (Occupant's Role), and OA11 (Occupant's Posture).

This section provides a base of information that is vital to the analytical process. Ergonomic engineers design the interior of vehicles to be most comfortable for a range of occupants. The height and weight for a particular age bracket are considered in establishing the leg room, head room, and other interior dimensions for a vehicle. Restraint design relies heavily on this type of information. Initial designs of active belts were determined to be very uncomfortable and difficult to wear. The use of a wider range of heights and weights, which also has a bearing on seat adjustments, resulted in belts which were much more comfortable to wear and therefore encouraged use.

Occupant demographics and position play an important role in the injury mechanism, restraint system effectiveness, and vehicle design analysis. For example, the vehicle design, which includes the restraint system, must take into consideration the differences between a five foot four inch, 100 pound driver and a six foot six inch, 300 pound passenger. Both of these occupants must be provided with the same amount of protection by the vehicle in an accident.

Societal costs are also derived from these variables and the related injury assessment variables in this and the Occupant Injury Form.

In many cases the only source for this information is the interview. For this reason the researcher should ask probing questions to elicit complete and accurate responses to these, and all other, variables.

Federal Motor Vehicle Safety Standards--FMVSS 202 (Head Restraints), FMVSS 206 (Door Locks and Door Retention Components), FMVSS 207 (Seating Systems), FMVSS 208 (Occupant Protection), FMVSS 212 (Windshield Mountings), FMVSS 213 (Child Restraint System), and FMVSS 214 (Side Door Strength), are all assessed relative to their potential for reduction of injury to occupants. For this reason it is necessary to have the occupant's characteristics as complete as possible for correct and accurate assessment of the various vehicle components and FMVSS's which apply.

Variable Name: Occupant's Age

Element Values:

Range: 00-97, 99
00 Less than one year old
97 97 years and older
99 Unknown

Source: Primary source is interviewee; secondary sources include police reports and other official records (i.e., medical records).

Remarks:

The occupant's age at the time of the accident is recorded with respect to the occupant's last birthday.

If you are unable to obtain the age of a driver, request a driver's license record. This action must be discussed and a policy determined with your zone center and COTR. Licensing file data takes precedence over police or interview data.

Variable Name: Occupant's Sex

Element Values:

- 1 Male
- 2 Female
- 9 Unknown

Source: Primary source is interviewee; secondary sources include police report and official records (e.g., medical).

Remarks:

Code "1" (Male) consists of men and boys; of the masculine gender.

Code "2" (Female) consists of women and girls; of the feminine gender.

Variable name: Occupant's Height

Element Values:

Range: 12 through 85 inches
99 Unknown

Source: Researcher determined--inputs include interviewee or official records (e.g., medical).

Remarks:

Code actual height to nearest inch.

Code "85" (85 inches) is used for any occupant whose height equals or exceeds seven feet one-half inch.

The PAR may be used as a source if it contains this data, but it is superseded if other data exists.

Autopsies often include this information; use it when present.

Variable Name: Occupant's Weight

Element Values:

Range: 005 through 300 pounds
999 Unknown

Source: Researcher determined--inputs include interviewee or official records
(e.g., medical)

Remarks:

Code actual weight to nearest pound.

Code "300" (300 pounds) is used for any occupant whose weight equals or exceeds
300 pounds.

The PAR may be used as a source if it contains this data, but it is superseded
if other data exists.

Autopsies often include this information; use it when present.

Variable Name: Occupant's Role

Element Values:

- 1 Driver
- 2 Passenger
- 9 Unknown

Source: Primary source is interviewee; secondary source is police report.

Remarks:

Hit-and-run vehicles are assumed to have only one occupant (unless reliable evidence to the contrary exists), and that person is assumed to be the driver. All other persons riding in or on the vehicle are considered to be passengers.

Variable Name: Occupant's Seat Position**Element Values:****Front Seat**

11 Left side
 12 Middle
 13 Right side
 14 Other (specify)
 15 On or in the lap of
 another occupant

Third Seat

31 Left side
 32 Middle
 33 Right side
 34 Other (specify)
 35 On or in the lap of
 another occupant

Second Seat

21 Left side
 22 Middle
 23 Right side
 24 Other (specify)
 25 On or in the lap of
 another occupant

Fourth Seat

41 Left side
 42 Middle
 43 Right side
 44 Other (specify)
 45 On or in the lap of
 another occupant

97 In or on unenclosed area
 98 Other seat (specify)
 99 Unknown

Source: Primary source is interviewee; secondary source is police report.

Remarks:

Seat position is coded by the location of the occupant in relation to the seat row and the forward longitudinal axis of the vehicle.

Only one person may be assigned seating positions "11" through "13", "21" through "23", "31" through "33", and "41" through "43". When two or more persons are occupying the same seating location (e.g., sitting side-by-side), assign the seat position as follows:

- first, to the occupant who is using the manual and/or automatic belt;
 if more than one occupant is using the manual and/or automatic belt or if no occupant is using a manual and/or automatic belt, then
- second, to the oldest occupant.

In seat rows designed for only two passengers, use codes "11", "13", "21", "23", "31", "33", "41", "43", or "98".

Code "11" (Front Seat - Left side) should be assigned to the assumed driver of a hit-and-run vehicle unless evidence indicates a different position for the person or persons.

Codes "14", "24", "34", "44", (... - Other) and "98" (Other seat) can be used in a variety of occupant seating situations. Some example situations are:

Variable Name: Occupant's Seat Position (cont'd.)

- occupant on the floor [i.e., in front of a designated seat (e.g., sitting, standing, etc.)];
- occupant lying across one or more seating positions; and
- occupant sitting side-by-side of another occupant in the same; seating position--only one can be assigned the seating position;

If an occupant is standing or kneeling in a designated seating position, the occupant is assigned that seating position with exceptions as noted above. That the occupant is not correctly seated is captured in variable OA11 (Occupant's Posture).

If the only seat in the front seating area is a driver's seat (e.g., bucket, pedestal, etc.) and the occupant was in the area but not in the seat, code "14" (Front Seat - Other) is used. This situation could occur because of vehicle design or seat removal. The same logic applies to other seat areas. A person in the fourth seat row but not in a seat is coded "44" (Fourth Seat - Other), and the actual position described.

Codes "15", "25", "35", "45" (... - On or in the lap of another occupant) and "98" (Other seat) are used whenever an occupant(s) is sitting, standing, etc. in or in the lap of another occupant.

Code "97" (In or on unenclosed area) includes those occupants riding on a fender, the boot of a convertible, the open cargo box on a light truck, etc.

Code "98" (Other seat) is used for anyone in the fifth or higher numbered seat area. In addition, use this code when an occupant(s) is in an enclosed area where no defined seating exists. Further, if an occupant(s) is using a fold-down type seat in its folded down position, then use this code.

If seating in the vehicle is longitudinal rather than lateral, use the basic idea of a vehicle interior being divided laterally into roughly equal thirds and visualize lateral rows of seats to determine what seat position is the best descriptor. The diagram below illustrates the intended seat positions for areas of a vehicle.

For rearward facing seats use the basic idea described above in the previous paragraph to describe the occupant's seat position. The fact that the seat does not face forward is addressed in OA11, Occupant's Posture.

Using the diagram below, coding for seat positions "11", "13", "21", "22", "23", "31", "41", and "98" are self-explanatory. For someone seated in the far right third of the offset seat in row three, the proper code is "32" (Third Seat - Middle). A person in the center of that same seat (i.e., row three) is coded "34" (Third Seat - Other).

Variable Name: Occupant's Seat Position (cont'd.)

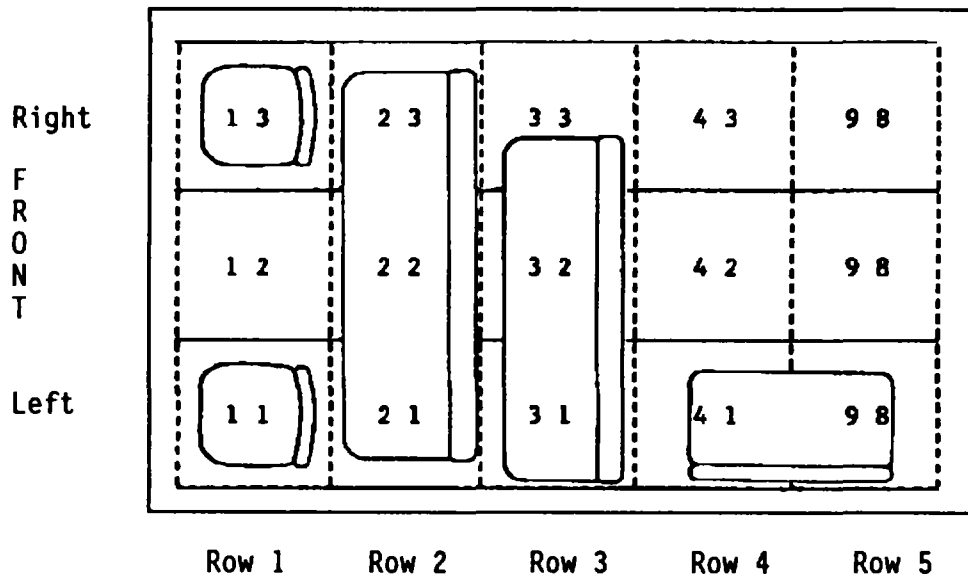

If a seat row has more than three designated seat positions, the occupants in the left and right positions have their positions assigned as usual (e.g., "31" and "33"), while the two center positions are coded as "Other" (i.e., "14", "24", "34", "44", or "98") depending upon the seat row.

Persons appended to the vehicle for motion are not considered to be occupants of the vehicle.

Variable Name: Occupant's Posture

Element Values:

- 0 Normal posture
- 1 Abnormal posture (specify)
- 9 Unknown

Source: Primary source is interviewee; secondary sources include vehicle inspection, police report, or official records (i.e., medical).

Remarks:

This variable is designed to capture those instances where an occupant was not in the usual upright, forward facing seated position.

The occupant's posture is assessed as the last known position that the occupant was in just prior to impact. If the occupant cannot recall his/her position just prior to impact, then code the last known position just prior to recognizing an impending danger.

Code "1" (Abnormal posture) includes but is not limited to:

- sitting sideways in the seat,
- sitting normally in a seat yet turned in a nonforward facing direction,
- sitting normally in a designed rearward or side-facing seat,
- bracing with feet or hands on a surface in front of the occupant,
- standing or kneeling on the floor,
- standing or kneeling on a seat,
- lying back in a reclined seat,
- lying across a seat,
- turned to talk to another occupant or to look out a rear window,
- leaning over in the seat,
- sitting on another occupant's lap
- sitting on a console
- being in a child safety seat,
- being in an unenclosed area,
- being in an enclosed area that does not have designated seating positions,
- etc.

It is extremely important in locating injuries associated with various items within the passenger compartment to know as much as possible about the occupant's trajectory or path inside the vehicle during the collision. The accuracy of this analysis depends on knowing exactly where the occupant was before the collision. Therefore, details about the occupant's posture are necessary.

As an example, if the right front passenger was sitting sideways in the seat facing the driver immediately prior to a frontal collision, it is reasonable to assume that his injuries would be confined to the right side of his body from contact with the instrument panel area. If he is reported simply as "sitting on the seat", his normal position would be with his right toward the door. For the same collision situation described above he would probably then contact the instrument panel with the front of his body rather than the side.

Code "9" (Unknown) if the occupant's posture cannot be determined.

EJECTION/ENTRAPMENT OVERVIEW

Variables in this section provide a coded assessment of the occurrence of entrapment or ejection of this occupant. There is one variable which addresses entrapment OA16, Entrapment. It is a presence or absence variable. There is no further assessment of entrapment in a coded format. Ejection has a more complete coded description regarding (a) occurrence, OA12, Ejection, (b) route of ejection, OA13, Ejection Area, (c) type of opening the occupant was ejected through, OA14, Ejection Medium, and (d) condition of the opening prior to impact OA15, Medium Status (Immediately Prior to Impact). All of the variables in this section are considered final assessments which are coded at the end of all field research and interviewing. Much of the information regarding them will come from the vehicle inspection. Verification of questionable ejection or entrapment will come from the interview.

Historically, ejection from the vehicle has been a major cause of fatalities and more serious injuries. The chances of being killed if ejected are about 1 in 5; whereas, if the occupant remains inside the vehicle, the chances of dying are reduced to about 1 in 200 for all fatal accidents. Unfortunately ejection from the vehicle is not that uncommon and has become a significant part of the fatality (30%) and severe (15%) injury accidents. Further contributing to the ejection problem is the increase in window surface area and more hatchback models. Despite the current emphasis on restraint use through legal requirements for occupants to be buckled up, a significant portion of the population continues to be unrestrained and at risk to ejection. All evidence indicates that this trend will continue into the foreseeable future.

A problem not often addressed is that of partial ejection. This refers to those instances where some part but not all of an occupant's body is, at some time during the accident sequence, outside the occupant compartment. Although it would not seem to be a problem it can be, and often is, fatal if the part outside is the occupant's head. Because of the dynamics of the vehicle and the kinematics of the occupants during an ejection sequence, it is often the occupant's own vehicle which causes the injury as it rolls onto the occupant.

Entrapment poses a different problem area. Recent years have brought about a vast improvement in the delivery of emergency medical attention to motor vehicle accident victims. This improvement has been achieved through the establishment of regional trauma centers, well equipped Mobile Intensive Care Units manned by trained paramedics even in rural areas, and a general increase in the knowledge of how to treat acute trauma. This improvement has not helped those victims who are restrained within the vehicle by deformed components. The improved care cannot be delivered because the personnel are unable to get to the victim, remove the victim from the vehicle, and deliver the victim to a treatment facility in a reasonable amount of time. Also, previous extrication tools used by rescue personnel were crude and sometimes injury causing themselves, an example of which is the large metal cutting saws. Within the last few years a device known as the "Jaws of Life" was developed and widely distributed. It is a hydraulically driven mechanism which can be used to increase the size of openings, extricate entrapped occupant's limbs and force open doors which are jammed. This development came about because of the perceived need for an extrication tool which operated quickly yet did not further injure the occupant.

EJECTION/ENTRAPMENT OVERVIEW

Federal Motor Vehicle Safety Standards (FMVSS) which were developed in response to the problems seen in these areas are FMVSS 201 (Occupant Protection in Interior Impact), FMVSS 205 (Glazing Materials), FMVSS 206 (Door Locks and Door Retention Components), FMVSS 212 (Windshield Mounting), and FMVSS 214 (Roof Crush Resistance Passenger Cars).

Analytically this group of variables is a stand alone package most of the time. It can form the basis of an analysis without the use or comparison to any other variables. This would be used mostly in exploring the number and types of ejections and entrapments. Expanding the scope somewhat to include injury severity allows a determination of the increase or decrease in the ejection problem. Inclusion of injury source would provide an idea of the severity of all occurrences of entrapment and ejection. Injury source also provides an idea of the kinematics of the occupant during the sequence. The addition of a cross-tabulation for AIS level would show the relative severity between the injuries incurred inside the vehicle and those outside the vehicle.

Other areas of interest to the analyst are the ejection route and performance of integral structures. The integral structure performance is directly governed by the FMVSS 206 and 212. These areas are of increasing interest to NHTSA since the real world performance can help support the findings from the staged collisions and will help determine the effectiveness of the standards.

Lastly, new glazing techniques are being introduced in windshields and some side windows. These new types of window have a plastic layer on the interior surface of the window. Tests have shown a reduction in lacerative injuries which was the primary objective but also an increased resistance to ejection through the window. Further study of real world performance is needed to provide an accurate evaluation of this secondary benefit.

Gathering the data, which will allow the researcher to accurately code the variables, is a multistage process. It will begin with the PAR which may give an indication of either ejection or entrapment. Inspection of the vehicle will provide the evidence needed to substantiate either occurrence. Further, documentation should be obtained through the scene inspection, interview, and injury data. Only at the end of the data gathering process should these variables be coded. Particular attention should be paid to the vehicle inspection since most evidence of ejection will be less apparent and not easily discerned.

In summary, this group of variables assesses the level of a very significant problem in today's accident picture. Correct accurate assessment is a result of a multistage research process which will be individualized by case. Attention to detail will result in a correct assessment. This is one area which is directly tied to the FMVSS, and all gathered data results in a direct evaluation of the applicable standards.

EJECTION/ENTRAPMENT OVERVIEW

Coding OA12-OA16 Special Conditions

Ejection and Entrapment

Using the guidelines given below, OA12-OA16 may be coded for towed CDS applicable vehicles based on PAR and accident severity when there is no vehicle inspection, no interview, and the answer is obvious. If there is any doubt, annotate accordingly and code "9" (Unknown).

1. For occupants of hit-and-run towed CDS applicable vehicles, in general, OA12-OA16 may be coded "0" (Not entrapped/No ejection).
2. For other towed CDS applicable vehicles: (Strata A to H)
 - (a) OA12-OA15 (ejection variables) may be coded "0" (No ejection) if the PAR specifically so states for a given occupant. For all other occupants about whom the PAR is silent, code "9" (Unknown).

If the PAR indicates that an occupant is ejected, this is sufficient to code OA12 "1" (Complete ejection) or "2" (Partial ejection) if the PAR so states. If complete versus partial ejection is not stated on the PAR, then code OA12 equal "3" (Ejection, unknown degree) may be used.

Note, however, that OA13-OA15 can be coded only if the PAR provides sufficient detail.

- (b) OA16 (Entrapment) may be coded "0" (Not entrapped) if the PAR specifically so states for a given occupant. For all other occupants about whom the PAR is silent, code "9" (Unknown).

Recall, however, that if the PAR states that an occupant is entrapped, this is not sufficient to code Entrapment (because PAR definition of entrapment is different from NASS definition). Unless Entrapment is verified through other sources, OA16 must be coded "9" (Unknown).

Variable Name: Ejection

Element Value:

- 0 No ejection
- 1 Complete ejection
- 2 Partial ejection
- 3 Ejection, unknown degree
- 9 Unknown

Source: Researcher determined--inputs include the vehicle inspection, interviewee, and the police report.

Remarks:

Ejection refers to persons being completely or partially thrown from the vehicle as a result of an impact or rollover. If a person already has a body part protruding from the vehicle (e.g., an elbow, arm, etc.) and the PDOF acting on the vehicle would likely cause further protrusions of the body part, then at least partial ejection is encoded.

Code "0" (No ejection) for any persons riding on the exterior of a vehicle, such as the fenders (this does not include pickup beds, boot of a convertible, and persons riding on open tailgates).

Code "1" (Complete ejection) refers to a situation where the occupant's body is entirely outside the vehicle but may be in contact with the vehicle.

Code "2" (Partial ejection) refers to a situation where part of the occupant's body remains in the vehicle. This does not apply to occupants who are not initially in the seating compartment of the vehicle [e.g., pickup beds, boot of a convertible, and persons riding on open tailgates, since any ejection for them is coded as "1" (Complete ejection)].

Police reported ejections may be coded if there is no vehicle inspection or occupant interview, provided that the ejectee was in the seating compartment of the vehicle, and there is no evidence which contradicts the reported ejection.

Variable Name: Ejection Area

Element Values:

- 0 No ejection
- 1 Windshield
- 2 Left front
- 3 Right front
- 4 Left rear
- 5 Right rear
- 6 Rear
- 7 Roof
- 8 Other area (e.g., back of pickup, etc.) (specify)
- 9 Unknown

Source Researcher determined--inputs include the vehicle inspection, interviewee, and the police report.

Remarks:

Code "0" (No ejection) applies to persons who are not ejected, or to persons riding on fenders.

Code "6" (Rear) is restricted to persons riding in a passenger compartment, who are ejected through the rear window, tailgate (e.g., station wagon), hatchback, etc.

Code "7" (Roof) applies to all hardtops, convertibles, sun roofs, t-bar roofs, and detachable hardtops (such as fiberglass tops) that are used to cover areas designed for passenger protection.

Examples follow for how variables OA14, Ejection Medium, and OA15, Medium Status (Immediately Prior to Impact), should be coded when OA13 equals 7 (Roof).

OA12	Roof Type	OA13	OA14	OA15
Ejection 1-3	Hardtop, ripped open during crash	7	5	3
Ejection 1-3	Removable hardtop, detached prior to crash	7	2	1
Ejection 1-3	Convertible, in down or open position	7	2	1
Ejection 1-3	Convertible, in closed position	7	2	2
Ejection 1-3	Sun or t-bar, ripped open during crash	7	2	2
Ejection 1-3	Sun or t-bar, open/removed prior to crash	7	2	1
Ejection 1-3	Sun or t-bar, closed prior to crash	7	2	2

Variable Name: Ejection Area (cont'd.)

Codes "1" through "7" are designated for use with areas designed for passenger protection (e.g., passenger cars, vans, light truck cabs, self-contained mini- RVs and mini-motor homes). Trailers, add-on campers, etc., are to be assigned code "8" (Other area).

Code "8" (Other area) also applies to persons riding on open tailgates.

Code "9" (Unknown) if the sole source for the ejection is the police report, unless the PAR provides a clear, distinguishable avenue of occupant ejection.

Variable Name: Ejection Medium

Element Values:

- 0 No ejection
- 1 Door/hatch/tailgate
- 2 Nonfixed roof structure
- 3 Fixed glazing
- 4 Nonfixed glazing (specify)
- 5 Integral structure
- 8 Other medium (specify)
- 9 Unknown

Source: Researcher determined--inputs include the vehicle inspection, interviewee, and the police report.

Remarks:

- Code "0" (No ejection) applies to persons who are not ejected, or to persons riding on fenders.
- Code "1" (Door/hatch/tailgate) includes any door, hatch, or tailgate that is opened during the course of the impact sequence.
- Code "2" (Nonfixed roof structure) applies only to convertible, sun roofs, t-bar roofs, and removable hardtops when detached.
- Codes "3" (Fixed glazing) and "4" (Nonfixed glazing) refer to any glazing in the vehicle.
- Code "5" (Integral structure) includes removable hardtops when attached to the vehicle.
- Code "8" (Other medium) applies to persons riding in pickup beds, on open tailgates, and for other situations which cannot be classified in codes "1" through "5". In addition, use this code when someone is ejected from a trailer, add-on camper, etc.
- Code "9" (Unknown) if the sole source for the ejection is the police report, unless the PAR provides a clear, distinguishable avenue of occupant ejection.

Variable Name: Medium Status (Immediately Prior to Impact)

Element Values:

- 0 No ejection
- 1 Open
- 2 Closed
- 3 Integral structure
- 9 Unknown

Source: Researcher determined--inputs include the vehicle inspection, interviewee, and the police report.

Remarks:

This variable is a description of the status of the area through which an occupant was ejected.

Code "0" (No ejection) applies to persons who are not ejected, or to persons riding on fenders.

Code "1" (Open) applies to convertible roofs, sun roofs, t-bar roofs, windows, doors or tailgates that are completely or partially open immediately prior to impact, or to other open areas of vehicles such as pickup beds, etc.

Codes "1" (Open) and "2" (Closed) refer to the status of the medium immediately prior to the impact.

Code "2" (Closed) refers to a window that is completely closed when damaged, or to a convertible, sun, or t-bar roof that is closed when damaged. Sun and t-bar roofs are coded here if the ejection occurred through the designed opening in the sun or t-bar roof. However, if the roof was of a sun or t-bar type but the ejection occurred because a sizeable opening was torn in the roof structure, then code "3" (Integral structure) should be used. This code is also used for fixed glazings such as windshields and backlights which are in place prior to the collision.

Code "2" (Closed) also refers to a door that is closed, but when damaged, experiences latch and/or hinge failure causing the door to open.

Code "3" (Integral structure) should be used when any vehicle structure, not designed to be opened (e.g., standard roof), is torn open during the accident such as to permit ejection.

Code "9" (Unknown) if the sole source for the ejection is the police report, unless there is a clear indication on the PAR of the medium status.

OA16

Variable Name: Entrapment

Element Values:

- 0 Not entrapped
- 1 Entrapped
- 9 Unknown

Source: Researcher determined--inputs include the vehicle inspection, interviewee, and the police report.

Remarks:

Code "1" (Entrapped) means that part of the occupant was in the vehicle and mechanically restrained by a damaged vehicle component; jammed doors and immobilizing injuries, by themselves, are not sufficient to constitute entrapment. Entrapment by cargo shift is also not sufficient.

Persons who are completely or partially ejected and subsequently become pinned by their own vehicle and any surface other than their own vehicle are not considered entrapped.

If the vehicle is not inspected and/or the occupant is not interviewed but the police report states that the person was "trapped", the researcher must verify through the officer, emergency personnel, or other witnesses that the person was, in fact, in the vehicle and mechanically restrained. This is because the above definition is more restrictive than common usage of the term. Code "9" (Unknown) if unable to obtain verification in the above situation.

An occupant is not considered entrapped (OA16 = 1) when their seat belt buckle release mechanism is jammed as a result of their accident. If this occurs, then OA20 [Manual (Active) Belt Failure Modes During Impact] must be coded "8" (Other manual belt failure), and a Potential Safety Problem Bulletin should be submitted.

RESTRAINT SYSTEM AND SEATS OVERVIEW

Variables in this section are designed to describe the availability, function, and use of restraint systems, seats, and head restraints. The variables are grouped by area assessed. Variables OA17 through OA20 are concerned with the active belts; OA21 through OA23 describe air bags; OA44 through OA48 report about automatic belts; OA24 refers to police reported restraint use; and OA25 through OA27 assess head restraint, seat type, and seat performance.

Active belts are the keystone to occupant protection during collisions. Restraint presence has been mandated by law since the 1968 model year. Manual (Active) Belt System Availability (OA17) describes the type of restraint that this occupant had the opportunity to use. The use of the restraint is then coded in OA18, Manual (Active) Belt System Use. Correct use has become a very large issue since many of the torso restraints are reportedly uncomfortable to wear especially for shorter persons. This information is captured in OA19, Proper Use of Manual (Active) Belts. Failure of the system, while rare, occurs often enough to be of interest to the rule making section of the NHTSA. Failures are coded in OA20, Manual (Active) Failure Modes During Accident.

Passive restraint systems are being installed in an increasing range of vehicles. Beginning in 1991 the description of the passive restraint system is split into "air bag" variables (OA21-OA23) and "automatic belt" variables (OA44-OA48). For air bag passive restraint systems, their availability and function is coded in variable OA21, Air Bag System Availability/Function. How well the air bags worked is described in OA22, Air Bag System Deployment, and OA23, Did Air Bag System Fail?. For automatic belt type passive restraint systems, their availability and function is coded in variable OA44, Automatic (Passive) Belt System Availability/Function. The use of the passive belts is then coded in OA45, Automatic (Passive) Belt System Use. The type of passive belt system (i.e., motorized versus nonmotorized) is described in OA46, Automatic (Passive) Belt System Type, and the properness of the passive belt use is described in OA47, Proper Use of Automatic (Passive) Belt System. Finally, OA48, Automatic (Passive) Belt Failure Modes During Accident, describes any failures associated with the automatic belt.

The accuracy of "restraint use", when the PAR is the only source of data, has long been a concern. Since the PAR has been used in the past as a source of data, the police assessment is now coded as a separate variable OA24, Police Reported Restraint Use.

Head restraint type and performance are coded in a single variable OA25, Head Restraint Type/Damage by Occupant at This Occupant Position. Protection of the occupant from neck and back injuries has long been a concern, especially in rear-end impacts. FMVSS 202 (Head Restraints) specifies the requirements for head restraints.

Seat type and performance, which are delineated by FMVSS 207 (Seating Systems), have received increased attention in recent years because of the potential for significantly more severe injuries when the seat fails. This information is captured in variables OA26, Seat Type (This Occupant Position), and OA27, Seat Performance (This Occupant Position).

RESTRAINT SYSTEM AND SEATS OVERVIEW

From a historical standpoint, these variables (OA17 through OA27 and OA44 through OA48) have received more attention from the NHTSA, automakers, and the general public than any other injury reduction area. Much controversy has resulted over the introduction and mandating of passive restraint systems, laws requiring use of active restraints, and what is seen as government interference in the private lives of persons. Despite all the uproar and protests, the facts remain that if any form of restraint is used properly, the number of injuries and their severity will be reduced. Passive restraints, which have an increasing presence in the accident picture today, are some of the most effective occupant protection devices available. Evaluation of the effectiveness of both active and passive systems has long been a priority of the accident research effort of the NHTSA. Problems with systems and failures many times receive an inordinate amount of attention compared to the success rate. It becomes important to all concerned that the performance be evaluated in an objective manner and problems which deter use, such as active torso restraints being uncomfortable, be thoroughly documented.

Less attention is paid to the head restraint and seat performance issue, but it is no less important in the overall injury picture. Neck and back injuries are some of the most common and most debilitating that occur in motor vehicle accidents. No accurate assessment of the societal loss due to reduced or poor productivity of occupants related to neck and back injuries has been made. Many times a person with this type of injury does not miss any days of work but is at a reduced level of productivity and has to undergo therapy or treatment for a long period of time. Head restraint design and performance is critical to reduction of trauma to the neck and back.

Seat performance, especially the seat back, is critical to injury reduction in the more severe collisions. Deformation limits of the seat back are covered by specifications in FMVSS 207. These limits are responsible for injury reduction in that the seat back must contain the occupant, either from the front or the back, while absorbing energy from the impact. It is also critical that the adjusters and seat tracks not fail since failure can cause more severe injuries than would otherwise be expected. Increased injury severity has been reported with seat failure even when the occupant is belted.

Analysts consider these variables to be key areas of interest. Correlations between these variables and the injury coding variables are of particular interest. The most common comparisons are, of course, restraint usage versus injury severity, restraint availability versus use, and passive versus active availability. The more detailed analyses involve three-way comparisons (e.g. restraint use versus injury severity versus delta V). Injury severity is less when the occupant is restrained as delta V increases until the delta V reaches a certain level. At this juncture the injury severity for belted occupants becomes the same as for unrestrained ones.

The uses for the data from these variables are too numerous to list, but they are varied and relate to all other forms and areas of data in the case. The researcher should remember that these variables are not coded only from one source of data. The primary source is the vehicle inspection; it is supported by interviewee and injury data. Inspection of the vehicle should be very

RESTRAINT SYSTEM AND SEATS OVERVIEW

detailed, and the researcher should examine closely for all possible clues and evidence. Obvious belt use indicated by stretched or frayed webbing is the easiest to find. Also, a deformed seat back or headrest would indicate damage by one of the occupants. Less obvious are signs of regular use such as a lack of dust around the buckle area or slightly frayed areas on the belt, close to the tongue, indicating frequent adjustment.

Indicators which support the assumption of belt use are a low number of minor injuries and no knee contusions or facial lacerations. Probing questions in the interview will aid the researcher in assessing use. Proper use can be elicited by asking questions about the comfort of the belt and location on the body (e.g., "Where was lap portion of belt, low on the hips, waistline, etc.?").

Seat type/performance and head restraint type/performance should be assessed primarily from the vehicle inspection. At times it is possible to get this information from other sources such as the interviewee, but anything beyond the interviewee is almost impossible. Many times deformation of the seat back can be visually observed. The obvious time to expect that type of damage is when the vehicle has sustained a rear impact. Seat back deformation also occurs with frontal impacts and unrestrained rear occupants. It is important to remember that many seat backs are now adjustable, especially bucket seats, and just because a seat appears to be out of correct vertical alignment does not indicate seat back damage.

Head restraint damage is fairly obvious since the restraint should follow the line of the seat back. If it deviates significantly from that line then there is a presumption of damage, and a careful examination should be conducted.

All of the above mentioned variables require expertise and concern with detail. Researchers should realize that the most obvious choice is sometimes not the best assessment. Careful thought and weighing of numerous factors are required in this area to obtain the best possible assessment.

Variable Name: Manual (Active) Belt System Availability
(for This Occupant's Seating Position)

Element Values:

- 0 Not available
- 1 Belt removed/destroyed
- 2 Shoulder belt
- 3 Lap belt
- 4 Lap belt and shoulder belt
- 5 Belt available - type unknown
- 8 Other belt (specify)
- 9 Unknown

Source: Researcher determined--Primary source is the vehicle inspection; secondary sources include the interview, police report, and medical records. NOTE: The use of the police report is limited. If there is no vehicle inspection and the only secondary source is the PAR, then the PAR "narrative" must clearly state that the manual belt system was used or available. An indication of usage or availability in a "restraint system" block is, by itself, not usable.

Remarks:

Some belt restraint systems are a combination of manual (active) and automatic (passive) occupant protection devices. For this variable, consider only the manual portion of the system.

Availability is assessed based on the occupant's seating position. Select the manual belt system which was available for use, if so desired, by the occupant relative to the occupant's seating position in the vehicle. Availability is also determined by presence, functional status, and use of the manual belt system. Any occupant who is using a belt restraint system, or portion thereof, must by default have that system available to them. The correctness and/or appropriateness of the use is considered in OA19, Proper Use of Manual (Active) Belts.

Certain occupant seating situations are problematic. Some problematic example situations are:

- occupant on the floor [i.e., in front of a designated seat (e.g., sitting, standing, etc.) or standing in the door entrance area];
- occupant lying across one or more seating positions;
- occupant sitting side-by-side of another occupant in the same seating position, since only one can be assigned to the seating position--see OA10, Occupant's Seat Position;
- occupant standing or kneeling in a designated seating position; and
- occupant in or on the lap of another occupant (e.g., sitting, standing, kneeling, etc.).

Occupant on the floor: Code "0" (Not available). These occupants are not in a designated seating position and do not have a manual belt available.

Variable Name: Manual (Active) Belt System Availability [cont'd.]

Occupant lying across one or more seating positions: For an occupant lying across multiple seating positions, OA10 (Occupant's Seat Position) must equal code "14", "24", "34", or "44". These occupants can be using a manual belt. Availability is assessed for any of the seating position(s) that the occupant is lying across. If there are more than one type of manual belt, or if some manual belts are damaged, choose the manual belt that is most functional and which provides the greater occupant protection (i.e., choose a manual lap and shoulder belt over a manual lap belt). Do not confuse this situation with occupants lying against a door or side panel or against another occupant. Persons in this latter category are still considered to be occupying a single occupant seating position.

Occupant sitting side-by-side of another occupant in the same seating position: These occupants (i.e., OA10 equal "14", "24", "34", "44") do not have a manual belt available unless such a person is sharing the use of a manual belt (i.e., two or more persons sitting side-by-side using the same manual belt should have the same restraint available for each occupant).

Occupant standing or kneeling in a designated seating position: These occupants can have manual belts available to them for use. Availability is assessed for these occupants based on the occupant's assigned seating position.

Occupant in or on the lap of another occupant: These occupants do not have a manual belt available unless such a person is sharing the use of a manual belt (i.e., two or more persons sitting in front of one another or on top of one another using the same manual belt).

Code "0" (Not available) indicates: (1) that at the time of the accident the designated seating position that the occupant was in, was not equipped with a manufacture installed or post manufacture installed manual belt (lap, shoulder, or lap and shoulder); (2) the occupant was not in a designated seating position (e.g., on the floor); (3) the occupant was not the person assigned the designated seating position and was not using a manual belt (e.g., sitting side-by-side); or (4) the seat position that the occupant was in was equipped only with an automatic (passive) belt system.

Nonintegral Manual Belt System:

Nonintegral manual belt systems are lap and shoulder belt combinations where the shoulder belt has to be integrated (e.g., by buckling) with the existing lap belt. Either the shoulder belt portion or the lap belt portion of a nonintegral manual belt system can be removed or destroyed. If a portion of a belt has been removed or destroyed, then the remaining portion is available. For example, some older vehicles (1968-1975) have had the separate shoulder belt removed leaving only the lap belt in the vehicle. In this situation, only the lap belt is available. The fact that the separate shoulder belt was removed or destroyed cannot be captured in this variable. If a portion of a nonintegral system has been rendered inoperative, then both portions are to be considered as available. For example, if the separate shoulder belt is tied so that it can no longer be integrated with the lap belt which was in use, then code lap and shoulder belt available (code "4") on this variable and lap belt (code "03") on OA18, Manual (Active) Belt System Use.

Variable Name: Manual (Active) Belt System Availability [cont'd.]

Integral Manual Belt System:

Integral manual belt systems are lap and shoulder belt combinations that have the shoulder belt permanently attached to the lap belt. Continuous loop integral manual belt systems are one continuous belt, with a sliding buckle, that functions as both a shoulder belt and a lap belt. If the manual belt system is integral and of the continuous loop design, and if any portion of the belt is removed or destroyed, then the entire system must be considered as removed or destroyed. Use code "1" (Belt removed/destroyed) in this situation. However, if the system is integral, but uses a noncontinuous loop design, then, depending upon the design, consideration must be given as to what portion was removed or destroyed. For example, if the shoulder belt has been cut leaving only a functional lap belt portion, then use code "3" (Lap belt).

Code "1" (Belt removed/destroyed) indicates that the manual belt, initially installed at this occupant's seating position, was subsequently removed or destroyed (e.g., unbolted, cutout, etc.). If the belt is present but nonfunctional, then code the type of manual belt available on this variable and use code "01" (Inoperative) for OA18, Manual (Active) Belt System Use.

Belts which are knotted, buckled at the rear of the seat (bench or bucket), stored below the seat, etc., are available if they were otherwise operative.

Code "2" (Shoulder belt) is used when this occupant's seat position was equipped with a manual upper torso restraint and no lap belt. The population of vehicles equipped with only manual shoulder belts is very small, therefore, care must be taken that a two-point passive belt is not identified as a manual belt (e.g., Volkswagen Rabbits 1981-1984).

Code "3" (Lap belt) is used when this occupant's seat position is equipped with a manual belt that secures the pelvic area of the occupant in the seat and there is no manual upper torso belt.

Code "4" (Lap belt and shoulder belt) is used when both a manual upper torso belt and a manual lap (pelvic area) belt are present at this occupant's seat position.

Code "5" (Belt available - type unknown) is used when there is no vehicle inspection and there is disagreement regarding the type of manual belt system among the secondary sources. When the specific manual belt system cannot be determined, but it is known some type of belt is present, then use this code.

Code "8" (Other belt) is used when the belt system is nonstandard or cannot be described with other codes. Specify (write out) the type of manual belt (e.g., 5 point competition harness, 4 inch wide webbing, altered integral 3 point system, etc.). Child restraints are not recorded here, use variables OA28 through OA33.

Code "9" (Unknown) is used when it cannot be determined whether or not manual belts were available for this occupant's seat position.

Variable Name: Manual (Active) Belt System Use

Element Values:

- 00 None used, not available, or belt removed/destroyed
- 01 Inoperative (specify)
- 02 Shoulder belt
- 03 Lap belt
- 04 Lap and shoulder belt
- 05 Belt used - type unknown
- 08 Other belt used (specify)
- 12 Shoulder belt used with child safety seat
- 13 Lap belt used with child safety seat
- 14 Lap and shoulder belt used with child safety seat
- 15 Belt used with child safety seat - type unknown
- 18 Other belt used with child safety seat (specify)
- 99 Unknown if belt used

Source: Researcher determined--Primary source is the vehicle inspection; secondary sources include the interview and medical records. NOTE: Do not use the police accident report as a source for coding this variable.

Remarks:

Select the manual belt system or portion of the system which was in use at the time of the accident by the occupant. The correctness of the use is not assessed on this variable [see variable 0A19, Proper Use of Manual (Active) Belts]. This variable only identifies manual belt usage; do not consider the presence and use of a passive belt system.

Code "00" (None used, not available, or belt removed/destroyed) is used when: (1) 0A17, Manual (Active) Belt System Availability, is coded "0" (Not available); (2) 0A17 is coded "1" (Belt removed/destroyed); or (3) a manual belt was available (i.e., 0A17=2-8) but not worn.

Code "01" (Inoperative) includes belts which are knotted, jammed, tucked behind the seat, or in any other fashion rendered unusable. In addition, use this code for belts which are inoperative because of extreme deteriorated from aging. A belt system that was completely removed from or cutout of a vehicle is coded "00".

Code "02" (Shoulder belt) if a manual shoulder belt alone was in use. If the lap belt portion of a "lap and shoulder belt" has been cutout leaving only a functional shoulder belt portion that was in use, then use this code. This code should be used very infrequently.

Code "03" (Lap belt) if a manual lap belt alone was in use. If the shoulder belt portion of a "lap and shoulder belt" has been cutout leaving only a functional lap belt portion that was in use, then use this code. Note, it is possible to have a manual lap belt used in conjunction with a two-point automatic belt system [see 0A44, Automatic (Passive) Belt System Availability/Function, and 0A45, Automatic (Passive) Belt System Use]. For manual and automatic belt combinations, use this

Variable Name: Proper Use of Manual (Active) Belts

Element Values:

- 0 None used or not available
- 1 Belt used properly
- 2 Belt used properly with child seat

Belt Used Improperly

- 3 Shoulder belt worn under arm
- 4 Shoulder belt worn behind back or seat
- 5 Belt worn around more than one person
- 6 Lap belt worn on abdomen
- 7 Lap belt or lap and shoulder belt used improperly with child safety seat (specify)
- 8 Other improper use of manual belt system (specify)
- 9 Unknown

Source: Researcher determined--Primary source is the vehicle inspection; secondary sources include the interview, police report, and medical records. NOTE: The use of the police report is limited. If there is no vehicle inspection and the only secondary source is the PAR, then the PAR "narrative" must clearly state that the manual belt system was used properly or improperly.

Remarks:

This variable must be assessed by the researcher using all available data. An improperly used manual belt can cause a large variety of injuries by itself or, depending upon the way it is improperly used, it can allow other injuries to occur which might not have happened if the restraint was properly used. In severe cases an improperly worn belt can be the cause of death. An improperly used belt can also lead to belt failure which is addressed in variable OA20, Manual (Active) Belt Failure Modes During Accident. If there is an improperly used belt and/or a belt system failure, they should be noted on the Case Summary Form.

Code "2" (Belt used properly with child seat) is to be indicated only when the safety seat is installed so as to comply with the manufacturer's directions (i.e., seat must be integrated with the vehicle via the manual seat belts) and is occupied by a child.

Code "4" (Shoulder belt worn behind back or seat) is used when an occupant has an integral lap and shoulder belt but is only "encompassed" by the lap portion (e.g., having the manual shoulder belt behind his or her back).

Code "5" (Belt worn around more than one person) is used when more than one occupant is sharing the same manual belt. Occupants may be sitting side-by-side, in front of one another, or on top of one another

Code "6" (Lap belt worn on abdomen) is used when the manual lap belt, or lap belt portion of a manual system, is worn above the occupant's pelvic bones.

Variable Name: Proper Use of Manual (Active) Belts (cont'd.)

Code "7" (Lap belt or lap and shoulder belt used improperly with child safety seat) is used when a child safety seat is not installed according to the manufacturer's directions and is occupied by a child. Specify how the manual belt was used improperly.

Code "8" (Other improper use of manual belt system) is used when a manual shoulder belt is worn on the outside of an occupant's arm (i.e., humeral area) as opposed to under the arm (code "3") or on top of the shoulder/clavicle (code "1").

Code "9" (Unknown) is used:

- when it is not known whether the manual belts used were used properly or improperly (i.e., no interview was conducted and no other information is present that identifies proper or improper use of the manual belts), and
- when a child safety seat is occupied by a child, but it is unknown if the seat was installed (using either the manufacturer's or the vehicle's manual belts) according to the manufacturer's directions.

Variable Name: Manual (Active) Belt Failure Modes During Accident

Element Values:

- 0 No manual belt used or not available
- 1 No manual belt failure(s)
- 2 Torn webbing (stretched webbing not included)
- 3 Broken buckle or latchplate
- 4 Upper anchorage separated
- 5 Other anchorage separated (specify)
- 6 Broken retractor
- 7 Combination of above (specify)
- 8 Other manual belt failure (specify)
- 9 Unknown

Source: Researcher determined--primary input is vehicle inspection only; additional inputs may include interviewee and police report if a vehicle inspection is obtained.

Remarks:

If any component of the manual belt system fails during the impact as a result of occupant loading, the failure is encoded on this variable. The failure is also recorded on the Case Summary Form and documented with photographs and diagrams as needed.

Code "0" (No manual belt used or not available) is used when OA18, Manual (Active) Belt System Use, equals "00" (None used, not available, or belt removed/destroyed), or "01" (Inoperative).

Code "1" [No manual belt failure(s)] is used when there is no physical evidence from the vehicle inspection to indicate that a failure occurred.

Codes "2" through "6" are used to indicate the specific failure of the restraint system. Select the code which corresponds to the appropriate manual belt failure mode that describes the component of the restraint system which failed (i.e., torn webbing, broken buckle or latchplate, anchorage separation, broken retractor). If a failure occurs, a complete and documented description of the failed component and the way it failed must accompany the case. Include photographs of the failed component(s).

Code "7" (Combination of above) includes any combination of codes "2"- "6" which describes multiple manual belt failure modes.

Code "8" (Other manual belt failure) includes any manual belt failure which is not described in codes "2"- "6" above.

Code "9" (Unknown) is used when OA18, Manual (Active) Belt System Use, equals "99" (Unknown if belt used) or when there is no vehicle inspection.

Variable Name: Air Bag System Availability/Function

Element Values:

- 0 Not equipped/not available
- 1 Air bag

Non-functional

- 2 Air bag disconnected (specify):
- 3 Air bag not reinstalled
- 9 Unknown

Source: Researcher determined--Primary source is the vehicle inspection; secondary sources include the interview, police report, and medical records. NOTE: The use of the police report is limited. If there is no vehicle inspection and the only secondary source is the PAR, then the PAR (1) must clearly indicate that an air bag deployed ("narrative" or "restraint system" block) or (2) the "narrative" must clearly state that the car was air bag equipped. For air bag systems, an indication of availability in a "restraint system" block is, by itself, not usable.

Remarks:

The following illustrations show a General Motors air bag system (used in the late 1970's), a typical Ford air bag system, and a driver air bag equipped steering wheel. The air bag wheel is the most easily identified part of an air bag system. All presently available air bag systems have a very similar steering wheel which is similar to the illustration.

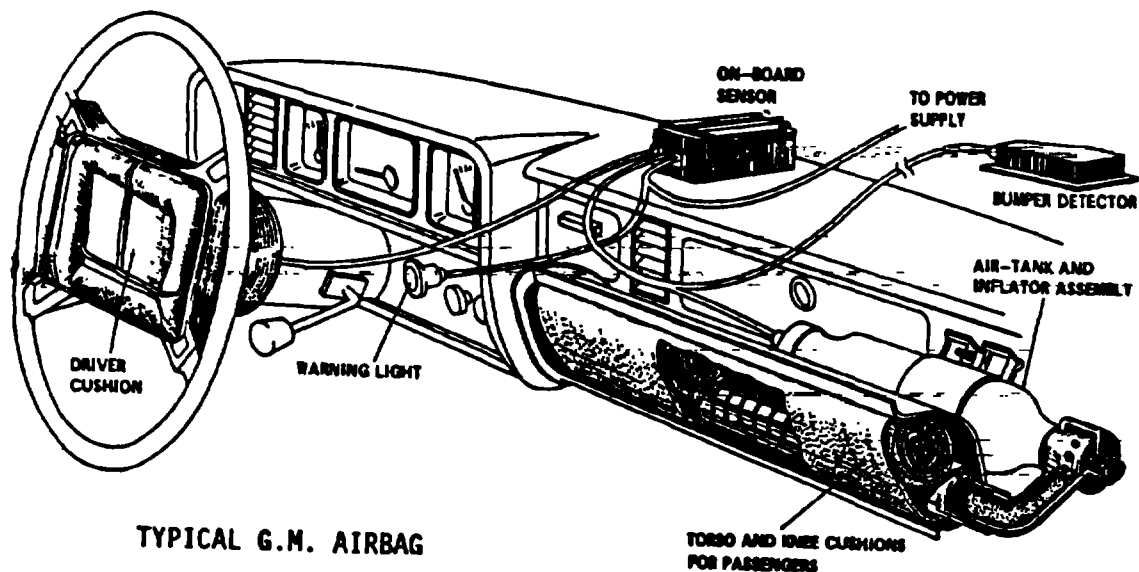

Variable Name: Air Bag System Availability/Function (cont'd.)

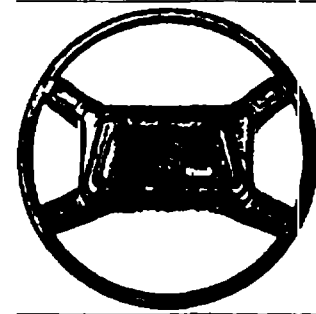
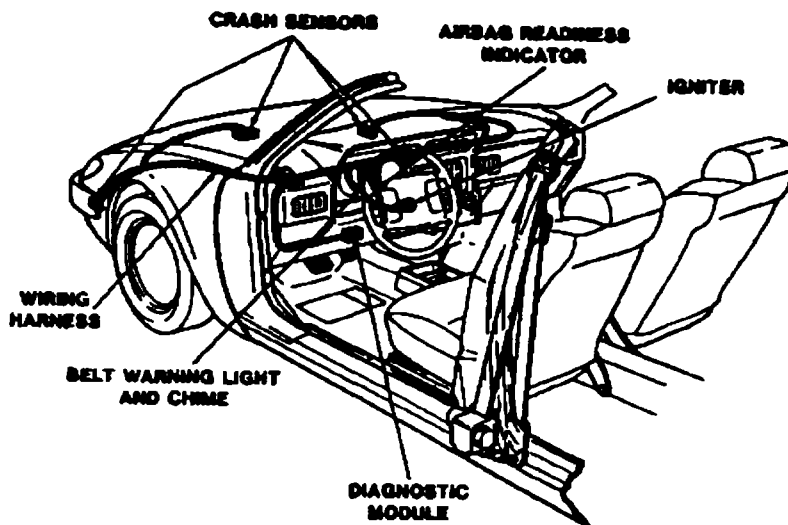

AIRBAG STEERING WHEEL

TYPICAL FORD AIRBAG

Code "0" (Not equipped/not available) is used when the vehicle is not equipped with an air bag for the occupant's seating position. Because some 1972 and newer passenger vehicles (GV07="01"- "09" and "12") are equipped with front seat air bags, information must be obtained from a valid source prior to using this code. Use this code for all rear seat occupants, for all occupants of 1971 or older vehicles, and for nonpassenger-type vehicles (GV07="10", "11", and "13"- "49") irrespective of the model year.

Code "1" (Air bag) is used when the vehicle is equipped with an air bag for the occupant's seating position. The air bag may be original manufacturer installed equipment, retrofitted equipment, or post-manufacturer installed equipment. Use caution when determining whether the air bag system is a "driver-only" or a "driver and passenger" design. Deployment of the air bag system has no bearing on the coding of this variable; refer to OA22, Air Bag System Deployment. If the occupant's passenger vehicle is not inspected and is a 1972 model year or newer and information indicates that the vehicle was equipped with an air bag, but its function is unknown, then use this code (i.e., the default assumption is that the air bag is functional).

Vehicles equipped with air bags can be identified through their Vehicle Identification Number (VIN; i.e., GV08). To assist in this identification a table appears at the end of the Occupant Assessment Form section and is entitled: Automatic (Passive) Restraint System Availability. This table attempts to provide comprehensive identification of vehicular passive restraint type by specific vehicle year, make, model, and VIN character identification.

Variable Name: Air Bag System Availability/Function (cont'd.)

- Code "2" (Air bag disconnected) is used when any component of the air bag system is rendered inoperative prior to the collision (e.g., fuse removed).
- Code "3" (Air bag not reinstalled) is used when the air bag is not replaced, or the system was not reactivated subsequent to a deployment prior to the accident being researched.
- Code "9" (Unknown) is used for front seat occupants of uninspected 1972 or newer passenger vehicles (GV07="01"- "09", "12") where data from another valid source cannot be obtained to ascertain the presence or absence of an air bag system.

Certain occupant seating situations are problematic. Some problematic example situations are:

- occupant on the floor [i.e., in front of a designated seat (e.g., sitting, standing, etc.)];
- occupant lying across one or more seating positions;
- occupant sitting side-by-side of another occupant in the same seating position, since only one can be assigned to the seating position--see OA10, Occupant's Seat Position;
- occupant standing or kneeling in a designated seating position; and
- occupant in or on the lap of another occupant (e.g., sitting, standing, kneeling, etc.).

Unlike belts (i.e., manual or automatic), air bags are less adaptable to occupants who are not sitting in the designated occupant seating positions. Whereas a belt can be extended (within certain limits) to accommodate multiple occupants, a fully deployed air bag is engineered for a specific area. A belt will provide some protection even for multiple occupants (assuming the lap portion is across the pelvic bones and/or the shoulder portion is across the clavicle). However, an air bag could be extremely dangerous for some occupants in problematic seating situations (e.g., occupant standing in front of the right-front seating position, occupant in or on the lap). Therefore, air bags are only available to the occupants sitting in the front outboard seating positions (i.e., OA10 equals "11" and/or "13"). Thus, use code "0" (Not equipped/not available) when an occupant's seating position (OA10) is "14" (... - Other) or "15" (... - On or in the lap of another occupant).

Some vehicles come equipped with a right-front passenger air bag and a front bench seat. In some vehicles the right-front air bag is big enough to cover the center front person [OA10="12" (Front Seat - Middle)]; however, the air bag was not engineered to provide protection to this occupant seating position. Therefore, occupants in the center front position, do not have an air bag available to them.

Variable Name: Air Bag System Deployment

Element Values:

- 0 Not equipped/not available
- 1 Air bag deployed during accident
- 2 Air bag deployed inadvertently just prior to accident
- 3 Air bag deployed, accident sequence undetermined
- 4 Nondeployed
- 5 Unknown if deployed
- 9 Unknown

Source: Researcher determined--Primary source is the vehicle inspection; secondary sources include the interview, police report, and medical records. NOTE: The use of the police report is limited. If there is no vehicle inspection and the only secondary source is the PAR, then the PAR must clearly indicate that an air bag deployed either in the "narrative" or in a "restraint system" block.

Remarks:

Air bags are for occupants seated in the front outboard positions in post-1971 passenger cars. Thus, if the vehicle is not a post-1971 passenger car or the occupant is not in a front outboard seating position (OA10, Occupant's Seat Position, equals "11" or "13"), then use code "0" (Not equipped/not available).

Code "0" (Not equipped/not available) is also used when the occupant is seated in a front outboard seating position in a post-1971 passenger car but the vehicle was not equipped with an air bag [i.e., OA21, Air Bag System Availability/Function, equals "0" (Not equipped/not available)].

Code"1" (Air bag deployed during accident) is used when the vehicle is equipped with an air bag [OA21 equals "1" (Air bag)] and the air bag deployed as a result of an impact. Note, an air bag is not designed to deploy in every collision.

Code "2" (Air bag deployed inadvertently just prior to accident) is used when an air bag deploys without an impact having caused its deployment, and the vehicle is subsequently involved in an accident. In addition, use this code if the air bag deploys during an accident but not as a result of an impact (e.g., vehicular fire).

Code"3" (Air bag deployed, accident sequence undetermined) is used when the researcher cannot determine if the air bag deployed before or during the accident.

Code "4" (Nondeployed) is used when an air bag equipped vehicle has one or more impacts, and the air bag did not inflate during the accident.

Variable Name: Air Bag System Deployment (cont'd.)

Code "5" (Unknown if deployed) is used when it is known that the vehicle was equipped with an air bag but the researcher is unable to determine if the air bag deployed (for whatever reason).

If the vehicle was not inspected and no interview was obtained and no mention of deployment is on the PAR or medical records and:

- it is unknown whether the vehicle was air bag equipped, then code "9" (Unknown) for front outboard seat occupants of post-1971 passenger cars and code "0" (Not equipped/not available) for non-front outboard seat occupants and occupants of all other CDS applicable vehicles.
- it is known (e.g., from the VIN--GV08) that the vehicle was air bag equipped, then code "5" (Unknown if deployed) for the applicable front outboard seat occupants of post-1971 passenger cars and code "0" (Not equipped/not available) for all other occupants.

Code "9" (Unknown) is used when it is unknown if an air bag was available.

Variable Name: Did Air Bag System Fail?

Element Values:

- 0 Not equipped/not available
- 1 No
- 2 Yes (specify):
- 9 Unknown

Source: Researcher determined--Primary source is the vehicle inspection; secondary sources include the interview, police report, and medical records. NOTE: The use of all secondary sources is limited. If there is no vehicle inspection, then the secondary sources are limited to the reporting of "no failure". If the only secondary source is the PAR and no failure is alleged, then the PAR must clearly indicate that an air bag deployed either in the "narrative" or in a "restraint system" block.

Remarks:

Code "0" (Not equipped/not available) is used whenever OA21, Air Bag System Availability/Function, equals "0" (Not equipped/not available), "2" (Air bag disconnected), or "3" (Air bag not reinstalled) because this variable only focuses upon failures in a functioning air bag system.

This variable flags "failures". Failure means that something abnormal has occurred to the air bag system. It may not necessarily mean that the air bag system was defective. An air bag failure could be a cut in or blowout of the fabric, a rupture along a fabric seam, a cover which does not open properly causing a misaligned deployment, partial inflation, or any number of other problems. If a failure is suspected, then document the condition with slides and notes, then call your zone center for assistance.

A vehicle inspection is required in order to report a failure because the vehicle's delta V (GV31, Longitudinal Component of Delta V) may have been below the threshold for the air bag's deployment.

Code "1" (No) is used whenever the vehicle is known to be air bag equipped [i.e., OA21 equals "1" (Air bag)] and no failure is suspected. Use this code when an air bag did not deploy [i.e., OA22, Air Bag System Deployment, equals "4" (Nondeployed)] and no failure is suspected and the vehicle inspection indicates that the delta V sustained by the vehicle (i.e. GV31) was near or below the deployment threshold. In addition, use this code when the vehicle is not inspected but is known to be air bag equipped (e.g., VIN--GV08) and secondary sources make no allegation of "failure" (e.g., interviewee does not say "the bag did not work").

Code "2" (Yes) is used whenever a failure is suspected.

Code "9" (Unknown) is used whenever OA22 equals "5" (Unknown if deployed) or "9" (Unknown).

Variable Name: Police Reported Restraint Use

Element Values:

- 0 None used
- 1 Police did not indicate restraint use
- 2 Shoulder belt
- 3 Lap belt
- 4 Lap and shoulder belt
- 5 Belt used, type not specified
- 6 Child safety seat
- 7 Other or automatic restraint (specify)
- 8 Restrained, type unknown
- 9 Police indicated "unknown"

Source: Police report

Remarks:

This variable encodes what was documented on the PAR regarding occupant use of available vehicle restraints (i.e., manual belts, child safety seat, or automatic restraints). Code the first attribute which applies.

Code "1" (Police did not indicate restraint use) is used in two instances. The first is when the PAR has a space, box, line, etc. to indicate restraint use but there is no response present. The second is when there is no area of the PAR for the officer to report restraint use.

Code "5" (Belt used, type not specified) is used when the PAR indicates that available belts were used, but it is unclear what type of belts were actually in use.

Code "8" (Restrained, type unknown) is used when the PAR indicates that some type of restraint was in use, but the type of restraint is not clear.

Variable Name: Head Restraint Type/Damage by Occupant at This Occupant Position

Element Values:

- 0 No head restraints
- 1 Integral - no damage
- 2 Integral - damaged during accident
- 3 Adjustable - no damage
- 4 Adjustable - damaged during accident
- 5 Add-on - no damage
- 6 Add-on - damaged during accident
- 8 Other (specify)
- 9 Unknown

Source: Researcher determined--primary input is vehicle inspection; additional inputs are interviewee and police report.

Remarks:

Many passenger cars have head restraints for the front outboard seat positions. The head restraints can be of any design but must meet the requirements of FMVSS 202 (Head Restraints). Some examples of head restraint styles are shown below.

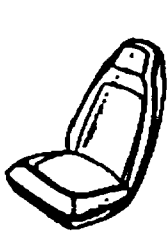

INTEGRAL

(Codes 1 or 2)

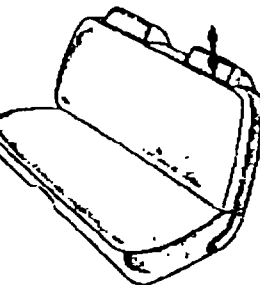
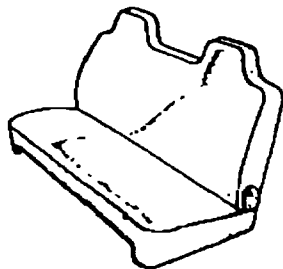

ADJUSTABLE

(Codes 3 or 4)

Any damage to a head restraint caused by the occupant in the seat position having the head restraint should have codes "2", "4", or "6" (... - damaged during accident) assigned.

Code "0" (No head restraints) if no head restraint is available for this occupant's seating position. In addition, use this code when there had been a head restraint but it had been removed prior to the accident.

Code "1" (Integral - no damage) and code "2" (Integral - damaged during accident) refer to head restraints which are a continuous part of the seat back structure or those which are a separate structure but are not vertically adjustable.

Code "3" (Adjustable - no damage) and code "4" (Adjustable - damaged during accident) apply to:

Variable Name: Head Restraint Type/Damage By Occupant At This Occupant Position (cont'd.)

- head restraints which can be moved vertically to accommodate occupants of varying heights, and
- head restraints which have a fixed outer framework and a separate center section which is adjustable vertically.

Code "5" (Add-on - no damage) and code "6" (Add-on - damaged during accident) refer to clamp-on, strap-on, or even bolt-on head restraints on a vehicle not originally equipped with head restraints. These two codes should be infrequently used.

Code "9" (Unknown) is used when: (1) there is no vehicle inspection, (2) the type of head restraint cannot be determined, or (3) it is unknown if damage to the restraint was caused by an occupant in the appropriate seat position.

Note: Some manufacturers are providing head restraints for rear seat occupants. These head restraints may be the same or similar to those used in the front seats, or they may be a slight rise in the rear seat back. Any damage to a rear seat head restraint by the occupant in the seat position must be coded regardless of the height of the restraint.

Certain occupant seating situations are problematic. Some problematic example situations are:

- occupant on the floor [i.e., in front of a designated seat (e.g., sitting, standing, etc.)];
- occupant lying across one or more seating positions;
- occupant sitting side-by-side of another occupant in the same seating position, since only one can be assigned to the seating position--see OA10, Occupant's Seat Position;
- occupant standing or kneeling in a designated seating position;
- occupant in or on the lap of another occupant (e.g., sitting, standing, kneeling, etc.).

The table below expresses the relationship between variables OA10, OA25, OA26, and OA27 for the problematic situations listed above. For the seating variables OA25 through OA27, the guiding principle is that if an occupant is floor associated, lap related, or lying across more than one seating position, then that occupant is not "seated" and the zero codes (i.e., OA25="0", OA26="00", and OA27="0") apply. Otherwise, the occupant is considered "seated" and the best descriptors are used.

Variable Name: Head Restraint Type/Damage By Occupant At This Occupant Position (cont'd.)

Occupant's Situation				
	OA10	OA25	OA26	OA27
on the floor [i.e., in front of a designated seat (e.g., sitting, standing, etc.)]	14	0	00	0
	24	0	00	0
	34	0	00	0
	44	0	00	0
lying across one or more seating positions	14	0	00	0
	24	0	00	0
	34	0	00	0
	44	0	00	0
sitting side-by-side of another occupant in the same seating position	11-14	0-6,8-9	01-09,99	1-9
	21-24	0-6,8-9	01-09,99	1-9
	31-34	0-6,8-9	01-09,99	1-9
	41-44	0-6,8-9	01-09,99	1-9
standing or kneeling in a designated seating position	11-14	0-6,8-9	01-09,99	1-9
	21-24	0-6,8-9	01-09,99	1-9
	31-34	0-6,8-9	01-09,99	1-9
	41-44	0-6,8-9	01-09,99	1-9
in or on the lap of another occupant (e.g., sitting, standing, kneeling, etc.)	15	0	00	0
	25	0	00	0
	35	0	00	0
	45	0	00	0

- OA10 - Occupant's Seat Position
 OA25 - Head Restraint Type/Damage by Occupant at This Occupant Position
 OA26 - Seat Type (This Occupant Position)
 OA27 - Seat Performance (This Occupant Position)

Variable Name: Seat Type (This Occupant Position)

Element Values:

- 00 Occupant not seated or no seat
- 01 Bucket
- 02 Bucket with folding back
- 03 Bench
- 04 Bench with separate back cushions
- 05 Bench with folding back(s)
- 06 Split bench with separate back cushions
- 07 Split bench with folding back(s)
- 08 Pedestal (i.e., van type)
- 09 Other seat type (specify)
- 99 Unknown

Source: Researcher determined--primary input is vehicle inspection; additional input is interviewee.

Remarks:

This variable assesses the type of seat occupied by this occupant.

The type of seat in which an occupant is positioned may have an effect on the occupant kinematics. For this reason the type of seat is important to analysts.

Code "00" (Occupant not seated or no seat) refers to persons who are on the floor [i.e., in front of a designated seat (e.g., sitting, standing, etc.)], lying across one or more seating positions, in or on the lap of another occupant (e.g., sitting, standing, kneeling, etc.), or not in an area with seats (i.e., rear area of a cargo van).

Code "08" (Pedestal) includes both swivel and non-swivel type pedestal seats. A pedestal seat can be differentiated from a bucket seat by the presence of a column supporting the pedestal seat.

Below are examples of some seats and appropriate codes.



BUCKET

(Codes 01 or 02)



BENCH

(Code 03)



BENCH WITH
SEPARATE BACK
CUSHIONS

(Codes 04)

Variable Name: Seat Type (This Occupant Position) (cont'd.)

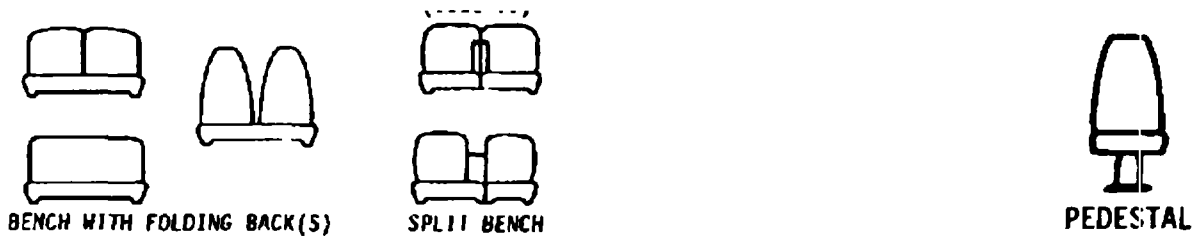

(Code 05)

(Code 06 or 07)

(Code 08)

The term "folding back(s)" as used in codes "02", "05", and "07" refers to seat backs which fold forward to allow easier access to the area behind the seat. Seats which recline rearward are not considered to be folding backs. The seat back for the occupant in that seat position is the determining factor for folding back presence. If the seat back does not fold at that position do not use codes "02", "05", and "07". Folding backs, because of the additional possibility of failure of the folding mechanism, take precedence over solid or separate back cushions. For example, a bench seat with separate back cushions which fold forward would be coded "05" [Bench with folding back(s)].

The rear seats in many late model vehicles may be of unusual design. The researcher is cautioned to view only the seat type for the occupant's position. If the seat is of a bench type and the back cushion for the position folds, then the proper code is "05" [Bench with folding back(s)]. The fact that the seat cushion may also fold is not considered.

If the occupant was in a seat position with the seat folded prior to the accident (i.e., second seat area of a station wagon, etc.), then the proper code would be "00" (Occupant not seated or no seat).

Code "99" (Unknown) if there is no vehicle inspection or if the seat type cannot be determined. However, if the occupant was not seated, then use code "00" (Occupant not seated or no seat).

Variable Name: Seat Performance (This Occupant Position)

Element Values:

- 0 Occupant not seated or no seat
- 1 No seat performance failure(s)
- 2 Seat adjusters failed
- 3 Seat back folding locks failed
- 4 Seat tracks/anchors failed
- 5 Deformed by impact of occupant
- 6 Deformed by passenger compartment intrusion (specify)
- 7 Combination of above (specify)
- 8 Other (specify)
- 9 Unknown

Source: Vehicle inspection

Remarks:

This variable assesses the performance of the seat occupied by this occupant.

Code "0" (Occupant not seated or no seat) for occupants not in a seat or in an area without seating (i.e., rear of a cargo van).

Code "1" [No seat performance failure(s)] if the seat was not deformed or no portion of the seat structure failed during the accident.

Codes "2" through "6" are used to indicate if the seat failed or was deformed in any way. Select the code which corresponds to the appropriate seat performance failure or deformation. Minor smudges, scrapes, dents, etc. are not considered deformation. If a failure or deformity occurs, then document the failure or deformation with a diagram and explanation. In addition, include photographs of the seat failure or deformity.

Code "7" (Combination of above) includes any combination of codes "2"- "6" which describes multiple seat failures or deformations.

Code "8" (Other) includes any seat failure(s) or deformation(s) which is not described in codes "2"- "6" above.

Code "9" (Unknown) if there is no vehicle inspection or if the researcher is unable to determine if the seat was deformed or failed in the accident. However, if the occupant was not seated, then use code "0" (Occupant not seated or no seat).

CHILD RESTRAINT OVERVIEW

These variables are designed to capture a description of child restraints used in all the towed CDS applicable vehicles involved in the accident. Information about the seat is of two types: characteristics and usage. Characteristics are described in OA28, Child Safety Seat Make/Model and OA29, Type of Child Safety Seat. Usage of the seat is coded in OA30, Child Safety Seat Orientation and OA31-OA33, Child Safety Seat Harness/Shield/Tether Usage.

Injury and death of young children has long been a significant part of the motor vehicle accident problem. Unrestrained children have a much greater tendency to be out of place (i.e. not in a designated seating position and generally standing or kneeling on the seat cushion). On impact this makes them very susceptible to injury or death since they are unrestrained. For a number of years, motor vehicle accidents have been the leading cause of injury and death to children under the age of five. Many states have attempted to address this problem by legislation requiring young children to be protected by some sort of child restraint. While these efforts have resulted in a reduction of injuries and death, little data on the real world performance of the child seats has been gathered. Police reports many times fail to note the use of such a restraint.

Specifications for these seats come from Federal Motor Vehicle Safety Standard (FMVSS) 213 (Child Seating Systems). Approval of design and testing is the responsibility of the NHTSA. Most states with child restraint laws require the use of a DOT approved seat.

From an analyst's point of view, presence and performance are the two key issues. Presence of a child restraint in a vehicle is established by noting its make, model and type. The ratio of presence to applicable occupants is an area that will be of great interest to the analysts. This will provide an indication of risk exposure for these children.

Performance of the seat is also an extremely critical issue. Other than staged laboratory tests, very little data exists on what happens to these seats and how well they perform in protecting the occupants. Analysts will compare use, injury severity levels, and delta V's for initial gross performance levels. Once that type of analysis is done, source of injury will be examined, along with seat type and make/model. All of these analyses will initially be used to evaluate the effectiveness of FMVSS 213 and help determine if the standard should be updated or modified. The other main use of performance analysis is to determine if any type or make/model has any significant problems.

All of the analyses are very dependent on having enough data. Researchers noting that a child younger than five years is an occupant in a CDS applicable vehicle must pursue the interview questions with the presumption that a child seat was present, especially if the jurisdiction has a child restraint law or ordinance. Probing questions should be asked during the interview, and whenever possible, an inspection of the seat should take place. Of course, if the seat

CHILD RESTRAINT OVERVIEW

is still with the vehicle it should be inspected at the same time as the vehicle. However, finding the seat with the vehicle is not a common occurrence. This is another area where the perseverance of the researcher pays off in needed information.

Child restraints are a major issue, and data collection in this area has a high priority. Much information is needed to provide a reliable evaluation of the real world performance of these restraints.

Variable Name: Child Safety Seat Make/Model

Element Values:

<u>Model Code</u>	<u>Make/Model</u>	<u>Includes</u>	<u>Manufacturer</u>
000	No child safety seat		
Infant Safety Seats			
101	GM Love Seat		Century Products
* 102	Century Infant Car Seat	560, 570 (discontinued), 580	Century Products ¹
* 103	Century Infant Love Seat		Century/Chrysler
104	Cuddle Shuttle		Collier-Keyworth
* 105	Cosco TLC		Cosco
106	Trav-L-Ette		Cosco/Peterson
107	Cosco First Ride		Cosco/Peterson
* 108	Evenflo Infant Seat		Evenflo
* 109	Dyn-O-Mite		Evenflo ²
110	Infant Carrier		Ford
111	Snug Seat		Graco
* 112	Rock n' Ride		Kolcraft
113	Swinger		Romer/KFS
114	Rockit Seat 640	639, 640	Strolee
* 115	Joy Ride		Evenflo
* 116	Cosco Dream Ride		Cosco
* 117	Travel Tandem		Evenflo
* 118	Fisher-Price Infant Seat		Fisher-Price
Convertible Safety Seats			
201	Century Safety Car Seat	100	Century Products
202	Century Safety Car Seat	200	Century Products
203	Century Safety Car Seat	300	Century Products
204	Century Safety Car Seat	400, XL	Century Products
* 205	Century S.T.E. Car Seat	1000	Century Products
* 206	Century S.T.E. Car Seat	2000	Century Products
* 207	Century S.T.E. Car Seat	3000	Century Products
208	Child Love Seat	GM Child Love Seat	Century Products
209	Safe & Sound	II	Collier-Keyworth
210	Roundtripper		Collier-Keyworth
211	Voyager		Collier-Keyworth
* 212	Cosco Soft Shield	Auto Trac, Autotrac	Cosco
213	Cosco Safe & Easy		Cosco
214	Cosco Safe & Snug		Cosco
* 215	Commuter	5-Pt	Cosco
216	Explorer		Cosco
217	Safe-T-Seat		Cosco ³
218	Safe-T-Shield		Cosco/Peterson
219	Safe-T-Mate		Cosco/Peterson
220	Peterson Safety Shield		Cosco/Peterson
* 221	Evenflo Convertible		Evenflo
* 222	Seven Year Car Seat		Evenflo

Variable Name: Child Safety Seat Make/Model (cont'd.)

<u>Model Code</u>	<u>Make/Model</u>	<u>Includes</u>	<u>Manufacturer</u>
Convertible Safety Seats (cont'd)			
223	Bobby Mac	Deluxe II, Champion Super, Lite	Evenflo ²
* 224	One-Step		Evenflo ²
* 225	Fisher-Price Car Seat		Fisher-Price
* 226	Gerry Guardian	633 (discontinued), 643 653, 655	Gerico, Inc.
227	Little Trav'ler	310, 315	Graco
228	GT 100		Graco
229	Teddy Tot Astroseat	9100/9300 Series	International
230	Hi-Rider XL	"7"	Kolcraft
231	Redi-Rider		Kolcraft
232	Quikstep		Kolcraft
233	Ultra Ride		Kolcraft
* 234	Nissan Safety Seat	Infant/Child	Nissan
235	Pride-Ride	820 & 830 series	Pride-Trimble
236	Kantwet Care Seat		Questor/Kantwet
237	Kantwet Safe Guard		Questor/Kantwet
238	Peggy		Romer/KFS
239	Tip-up		Romer/KFS
240	Wee Care	500 Series	Strolee
241	Wee Care	600 Series	Strolee
242	GT	2000, 3000	Strolee
243	Quick Click		Strolee
244	Volvo Child Seat		Volvo
245	Child Cushion		Volvo
246	Welsh Travel Tot		Welsh
247	Perfect F.I.T.T.		Kolcraft
* 248	Ultra	I, II	Evenflo
* 249	Baby Sitter		Babyhood
* 250	Century S.T.E. Car Seat	5000	Century Products
* 251	Gerry Guardian	654	Gerico, Inc.
252	Dial-A-Fit		Kolcraft
* 253	Playskool Carseat		Kolcraft
* 254	Prodigy Kiwi	Kiwi Plus	Prodigy
* 255	Prodigy Shuttle		Prodigy
* 256	Renolux GT 2000		Renolux
257	Renolux GT 4000	5000, 7000	Renolux
Booster Safety Seats			
* 301	Century Commander		Century Products
302	Safe-T-Rider	II, Deluxe	Century Products
303	Co-Pilot	II	Collier-Keyworth
* 304	Cosco Explorer	I	Cosco
305	Travel Hi-Lo	Deluxe High Back	Cosco/Peterson
* 306	Evenflo Booster		Evenflo
307	Wings	by Bobby Mac	Evenflo ²

Variable Name: Child Safety Seat Make/Model (cont'd.)

Model Code	Make/Model	Includes	Manufacturer
Booster Safety Seats (cont'd)			
* 308	Tot Guard		Ford
309	Gerry Voyager		Gerico, Inc.
310	Teddy Tot Astrorider	6000 Series	International
* 311	Quick Step Tot Rider	XL	Kolcraft
312	Flip N' Go	II	Kolcraft
313	#812		Pride-Trimble
* 314	Click-N-Go	890 Series	Pride-Trimble
315	Vario		Romer/KFS
316	Wee Care Booster Seat	600 Series	Strolee
317	Quick Click 605 Booster		Strolee
318	Cosco Auto Booster		Cosco
* 319	Sightseer		Evenflo
* 320	Century CR-3		Century Products
* 321	Gerry DoubleGuard		Gerico, Inc.
Special Needs Safety Seats			
** 401	Swinger Infant Car Bed	Carry Cot	Shinn & Assoc. ⁴
** 402	Britax		Shinn & Assoc. ⁴
** 403	E-Z-On Vest	101-TCXS, 101-TC, 102-TC (8 sizes)	E-Z On Products ⁵
** 404	Carrie Car Seat System	(3 sizes): 20-40 lbs; 30-60 lbs; & 50-100 lbs	Tumble Forms
** 405	Modified E-Z-On Vest	101M	E-Z On Products
** 406	Travel Chair		Ortho-Kinetics
** 407	Preemie Bunting		Koziatek & Assoc.
** 408	SPELCAST		Koziatek & Assoc.
** 409	Columbia Orthopedic Seat		Columbia Medical
** 410	Kidster	(3 sizes)	Gunnell
** 411	Snug Seat		Snug Seat
** 412	900 Series Transporter		Safety Rehab
Harnesses			
* 501	Little Cargo Auto Vest	(Harness only)	New Harness
997	Other make/model (specify)		
998	Unknown make/model		
999	Unknown if child safety seat used		

* All of these model are currently listed by the American Academy of Pediatrics in their publication entitled: 1990 Family Shopping Guide to Car Seats.

** All of these models are cited on page 4 of Safe Ride News, Spring 1989, published by the American Academy of Pediatrics.

Variable Name: Child Safety Seat Make/Model (cont'd)

- ¹ Gerber Furniture Group now owns Century Products.
- ² This Evenflo model was formerly produced by Questor/Kantwet.
- ³ This Cosco model was formerly produced by Cosco/Peterson.
- ⁴ These models were formerly produced by Evenflo
- ⁵ These models were formerly produced by Rupert.

Source: Researcher determined--inputs include vehicle inspection, interviewee, and police report.

Remarks:

Code "000" (No child safety seat) is used when (1) this person is not an infant or child (i.e., less than 50 pounds and less than 40 inches or less than six years old if height and weight not known), or (2) this person is an infant or child, but was not using an infant or child seat.

Codes "001" through "998" (i.e., child safety seat make/model codes) are used when this person is an infant or child and is using a child safety seat. If a qualifying infant or child was using a child safety seat, then document the make/model from the list provided above and code the make/model's number.

If height and weight information is absent, then use age to establish if this person should be classified as an infant or child. Persons six years of age and older are not classified as an infant or child; thus, use code "000" (No child safety seat).

If this person is an infant or child and was an occupant of a hit-and-run vehicle, then code this variable from available information. If age, height, or weight information is unavailable on this hit-and-run occupant, then use code "000" (No child safety seat).

Code "997" (Other make/model) is used when a qualifying infant or child is using a child safety seat but the make/model (which is known) is not listed above.

Code "998" (Unknown make/model) is used when a qualifying infant or child is using a child safety seat but the make/model is not known.

Code "999" (Unknown if child safety seat used) is used when it is unknown if the person under consideration is an infant or child, or it is unknown if this person was using a child safety seat.

Variable Name: Type of Child Safety Seat

Element Values:

- 0 No child safety seat
- 1 Infant seat
- 2 Toddler seat
- 3 Convertible seat
- 4 Booster seat
- 7 Other type child safety seat (specify)
- 8 Unknown child safety seat type
- 9 Unknown if child safety seat used

Source: Researcher determined--inputs include vehicle inspection, interviewee, and police report.

Remarks:

Code "000" (No child safety seat) is used when (1) this person is not an infant or child (i.e., less than 50 pounds and less than 40 inches or less than six years old if height and weight not known), or (2) this person is an infant or child, but was not using an infant or child seat.

Use the person's age (i.e., less than six versus six and older) to determine if this person is an infant or child when height and weight information is absent. Child carriers that are not designed as safety seats are to be classified as "No child safety seat". Examples of these child carriers are shown below.

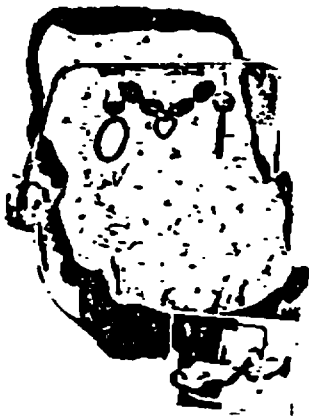

Kolcraft
"Baby's First Touch"

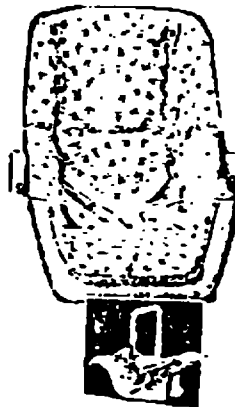

Century
"Kanga-Rocka-Roo"



Cosco
"Day Cradle/Carrier"

If this person is an infant or child and was an occupant of a hit-and-run vehicle, then code this variable from available information. If age, height, or weight information is unavailable on this hit-and-run occupant, then use code "000" (No child safety seat).

Variable Name: Type of Child Safety Seat (cont'd.)

Code "1" (Infant seat) is used when the seat is designed to only face the rear of the vehicle and the maximum capacity is 17-20 pounds (this information will usually be found on the manufacturer's label). Infant safety seats are equipped with a five-point harness (straps) to secure the infant to the safety seat and use the vehicle's safety belt system (i.e., manual or automatic) to secure the seat to the vehicle. The five-point infant seat system includes a pair of straps that go over the infant's shoulders, a crotch strap, and the vehicle's belts as lap belts to secure the seat to the vehicle. The seat is tub-shaped and cradles the baby in a generally reclined position. Examples are shown below.

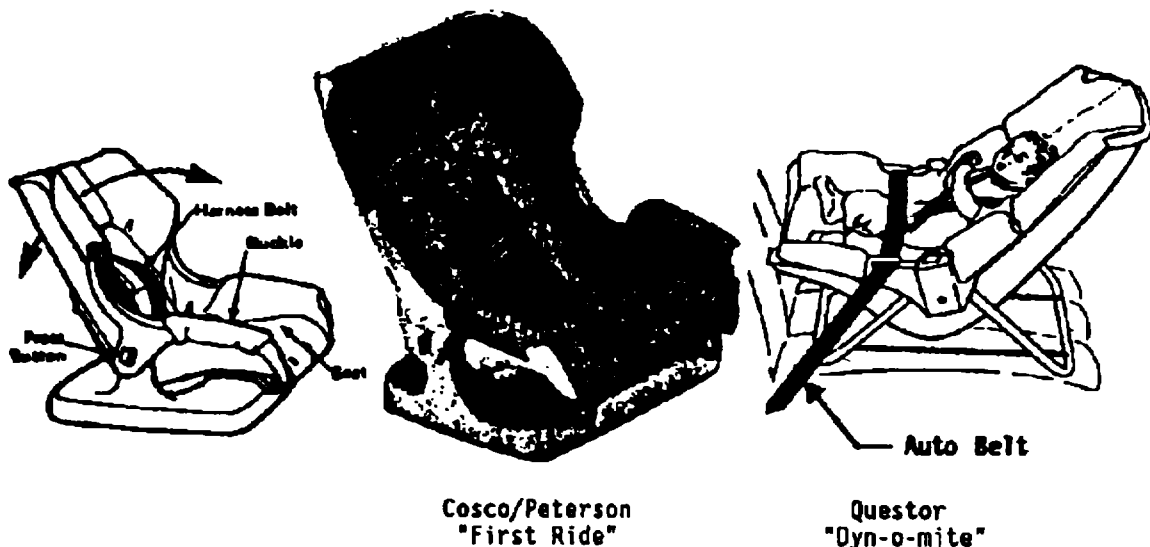

Code "2" (Toddler seat) is used when the seat is designed to only face the front of the vehicle and to carry a child weighing approximately 20-50 pounds (this information will usually be found on the manufacturer's label). The toddler seat may also be referred to as a "child seat". Most have a five-point harness system (straps) to secure the child to the seat. All models secure the safety seat to the vehicle with the vehicle's safety belts (i.e., manual or automatic) and, in addition, some models have a tether strap which must be attached to the rear manual safety belt or deck lid to prevent tipping forward. The child is restrained by a shield, a harness, or a combination of the two in a generally upright sitting position, although some seats have multiple positions. Examples are shown below.

Variable Name: Type of Child Safety Seat (cont'd.)

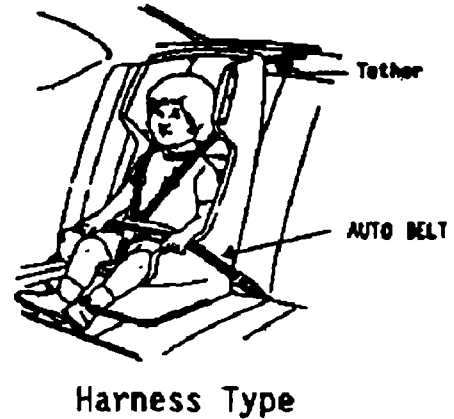
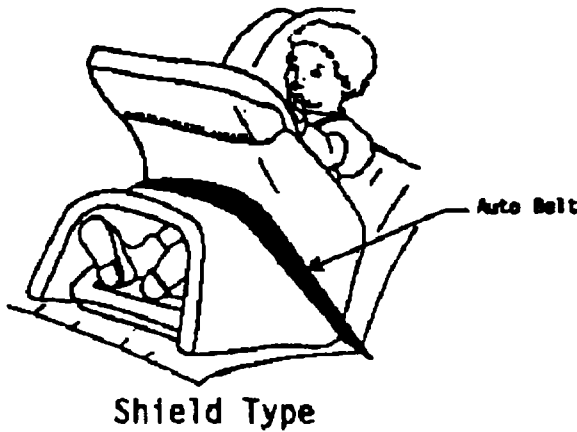

Code "3" (Convertible seat) is used when the seat is designed to face the front or rear of the vehicle and to carry a child ranging from birth to approximately 50 pounds (this information will usually be found on the manufacturer's label). Most have a harness system (straps) to secure the child to the seat. All models secure the safety seat to the vehicle with the vehicle's safety belts (i.e., manual or automatic) and, in addition, some models have a tether strap which must be attached to the rear manual safety belt or deck lid to prevent tipping forward. The child is restrained by a shield, a harness, or a combination of the two in either a generally reclined rearward facing position (for small infants--birth to 20 pounds) or a generally upright forward sitting position (for larger children--20-50 pounds). Examples are shown below:

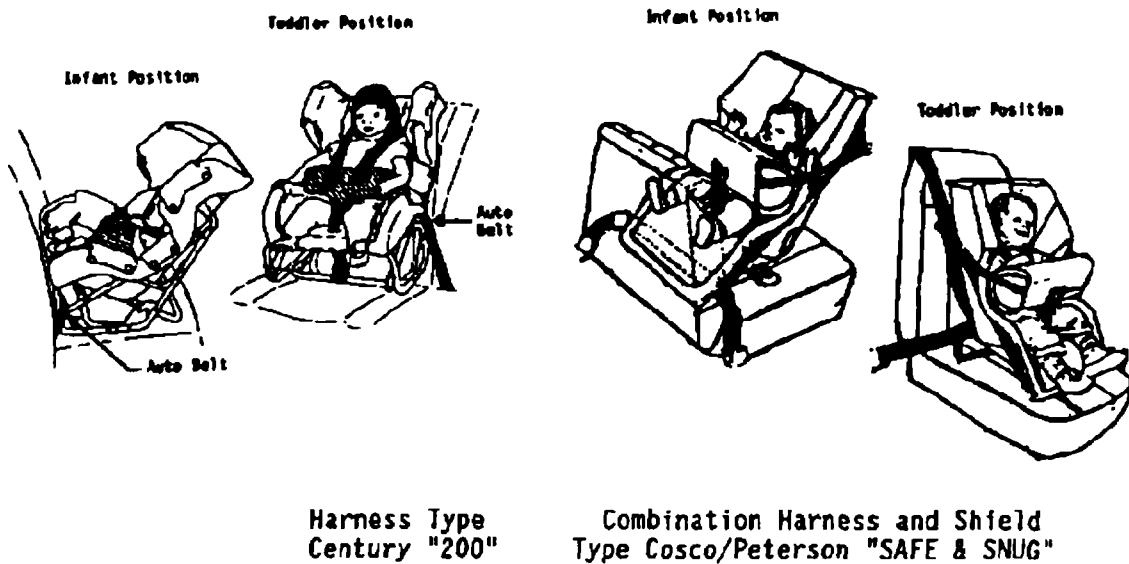

Variable Name: Type of Child Safety Seat (cont'd.)

Code "4" (Booster seat) is used when the seat is designed as a forward facing platform without a back (except for one Cosco/Peterson model which has a back) and adjusts to children up to 60 pounds. The booster seat restrains the child in a raised upright sitting position with either a harness or shield. Booster seats are designed primarily to fill the gap between when a child outgrows the standard child safety seat and when the child can use the adult belt (i.e., manual or automatic) and still see out the window. Some models can also be used for smaller children, as small as 20 pounds. Examples of booster seats are shown below.

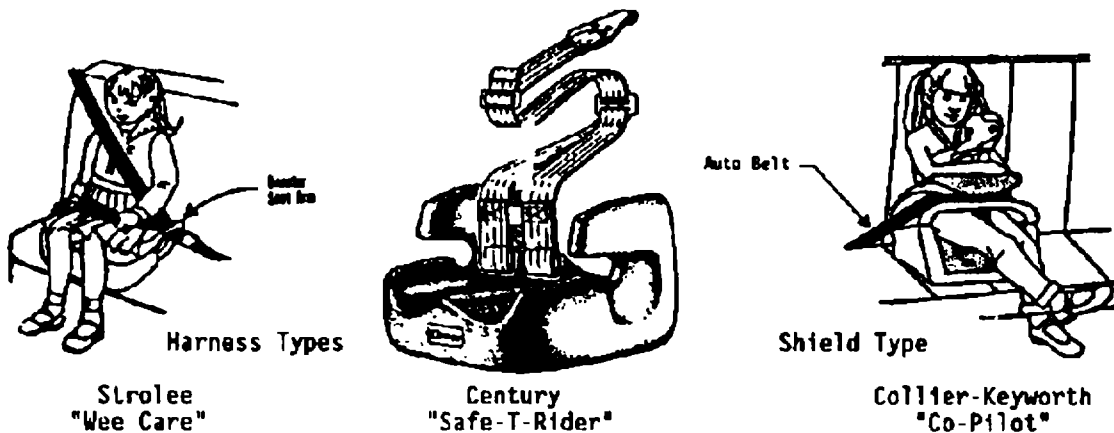

Some of the above infant, child, convertible and booster seats require a tether. When a tether-required seat is placed in the vehicle's front seat, the tether should run over the top of the seat and attach to a rear manual seat belt or possibly to one of the anchors for a front seat belt (i.e., manual or automatic). When a tether-required seat is placed in the vehicle's rear seat, the tether should run over the top of the rear seat and attach to an anchor on the rear window shelf or possibly pass through the rear window shelf and attach to one of the anchors for a rear manual seat belt.

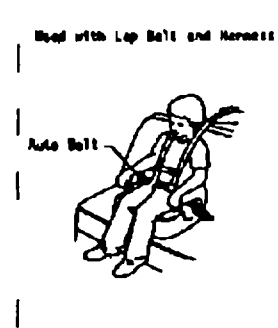

Code "7" (Other type child safety seat) is used when the infant or child safety seat cannot be described by codes "1" through "4" above. Specify the type.

Code "8" (Unknown child safety seat) is used when a child safety seat is in use but the type of child safety seat is unknown.

Code "9" (Unknown if child safety seat used) is used when it is unknown if the person under consideration is an infant or child, or it is unknown if this person was using a child safety seat.

Variable Name: Child Safety Seat Orientation

Element Values:

00 No child safety seat

Designed for Rear Facing for This Age/Weight

01 Rear facing

02 Forward facing

08 Other orientation (specify)

09 Unknown orientation

Designed for Forward Facing for This Age/Weight

11 Rear facing

12 Forward facing

18 Other orientation (specify)

19 Unknown orientation

Unknown Design or Orientation for This
Age/Weight, or Unknown Age/Weight

21 Rear facing

22 Forward facing

28 Other orientation (specify)

29 Unknown orientation

99 Unknown if child safety seat used

Source: Researcher determined--inputs include vehicle inspection, interviewee, and police report.

Remarks:

Code "000" (No child safety seat) is used when (1) this person is not an infant or child (i.e., less than 50 pounds and less than 40 inches or less than six years old if height and weight not known), or (2) this person is an infant or child, but was not using an infant or child seat.

If height and weight information is absent, then use age to establish if this person should be classified as an infant or child. Persons six years of age and older are not classified as an infant or child; thus, use code "000" (No child safety seat).

If this person is an infant or child and was an occupant of a hit-and-run vehicle, then code this variable from available information. If age, height, or weight information is unavailable on this hit-and-run occupant, then use code "000" (No child safety seat).

The researcher must determine from the seat, using the Child Safety Seat Identification Guide, the designed orientation for this person's weight or age. Next, the actual orientation of the seat at-impact must be determined to obtain the correct code.

Variable Name: Child Safety Seat Orientation (cont'd)

For example, a one and one-half year old child whose weight is 17 pounds was sitting in a forward facing Century 300 child safety seat. The correct code based upon the Child Safety Seat Identification Guide is "02" (Forward facing). At this age and weight the convertible seat should be rear facing but was forward facing.

Before using any code the researcher must carefully review the subcategories and choose the appropriate code based on designed orientation at the occupant's age and weight.

Code "01", "11", or "21" (Rear facing) or "02", "12", or "22" (Forward facing) if at the time of the accident the seat was facing the rear of the vehicle or the front of the vehicle, respectively. Do not code with respect to the vehicle's direction of travel (e.g., backing vehicle).

Code "08", "18", or "28" (Other orientation) if the seat was facing other than rear or forward at the time of the accident (e.g., on the floor, sideways, on top of or underneath something).

Code "09", "19", or "29" (Unknown orientation) is used when a child safety seat is in use but the orientation at the time of the accident is unknown (e.g., at the time of vehicle inspection the child safety seat is not present or is unattached and there is no information from an interview or the PAR).

Code "99" (Unknown if child safety seat used) is used when it is unknown if the person under consideration is an infant or child, or it is unknown if this person was using a child safety seat.

Variable Name: Child Safety Seat Harness Usage
Child Safety Seat Shield Usage
Child Safety Seat Tether Usage

Element Values:

00 No child safety seat

Not Designed with Harness/Shield/Tether

01 After market harness/shield/tether added, not used

02 After market harness/shield/tether used

03 Child safety seat used, but no after market harness/shield/tether added

09 Unknown if harness/shield/tether added or used

Designed with Harness/Shield/Tether

11 Harness/shield/tether not used

12 Harness/shield/tether used

19 Unknown if harness/shield/tether used

Unknown If Designed with Harness/Shield/Tether

21 Harness/shield/tether not used

22 Harness/shield/tether used

29 Unknown if harness/shield/tether used

99 Unknown if child safety seat used

Source: Researcher determined--inputs include vehicle inspection, interviewee, and police report.

Remarks:

Code "00" (No child safety seat) is used when (1) this person is not an infant or child (i.e., less than 50 pounds and less than 40 inches or less than six years old if height and weight not known), or (2) this person is an infant or child, but was not using an infant or child seat. If height and weight information is absent, then use age to establish if this person should be classified as an infant or child. Persons six years of age and older are not classified as an infant or child; thus, use code "000" (No child safety seat).

If this person is an infant or child and was an occupant of a hit-and-run vehicle, then code this variable from available information. If age, height, or weight information is unavailable on this hit-and-run occupant, then use code "000" (No child safety seat). The design of each child safety seat must be assessed regarding harness, shield, and tether use.

Refer to the Child Safety Seat Identification Guide to ascertain the design of the seat and the applicability of the harness, shield, and tether to each seat individually.

OCCUPANT ASSESSMENT FORM

OA31
OA32
OA33
(2)

Variable Name: Child Safety Seat Harness Usage(cont'd.)
Child Safety Seat Shield Usage (cont'd.)
Child Safety Seat Tether Usage (cont'd.)

An "after market" harness/shield/tether is one added by the user to a child safety seat not originally designed to use the device.

Code "99" (Unknown if child safety seat used) is used when it is unknown if the person under consideration is an infant or child, or it is unknown if this person was using a child safety seat.

INJURY/CONSEQUENCES OVERVIEW

These variables are grouped into two areas. First, how severely was this occupant injured, and second, what were the injury consequences for this occupant. Variables which address the first area are OA34, Injury Severity (Police Rating), OA43, Number of Recorded Injuries for This Occupant, and OA35, Treatment-Mortality. The second area is addressed by the variables OA35, Treatment-Mortality, OA36, Type of Medical Facility (for Initial Treatment), OA37, Hospital Stay, OA38, Working Days Lost, and OA39, Time to Death. Treatment - Mortality (OA35) addresses both areas because of its format.

Variables OA40 through OA42, Medically Reported Cause of Death, indicate which of the recorded injuries on the Occupant Injury Form, reported by a physician or lay coroner, were the cause of death.

Treatment and delivery of care for minor to moderately injured accident victims has improved and is being provided in areas where it was not available previously. The long term results of trauma continue to be lessened through this improved care delivery and treatment system. Availability of care has increased due to competition in the medical industry. Neighborhood clinics have become prevalent in all areas, especially in some of the smaller rural communities. This expansion of care has not been fully documented for the motor vehicle accident picture and leaves the injury assessment area with some data loss. Persons that formerly went to the emergency room of the local hospital to see their family doctor, now may go to the neighborhood minor emergency medical clinic. This change is also somewhat a result of the improved protection for occupants from injuries caused by vehicle interiors during accidents.

Another factor that is changing rapidly is the length of time spent in a hospital. The current emphasis is to get the patient out of the hospital as quickly as possible and into a home environment for convalescence. For this reason the overall days lost are changing.

All of these changes are a direct reflection of changes in societal costs, both in terms of direct cost (e.g., injury and treatment) and indirect costs (e.g., lost productivity due to days lost while the vehicle is repaired). Since this is a rapidly changing picture, more documentation needs to be provided for good analysis.

Coding these variables is based primarily on medical records. There are only two variables which do not come from an official record, and they are Working Days Lost (OA38) and Type of Medical Facility (for Initial Treatment) (OA36). Sometimes no records are available, for example, when a treatment facility will not provide records, or when there was no treatment. In the case of no records, interviewee data are the primary source for all variables except the Injury Severity (Police Rating) (OA34), Time to Death (OA39), and Medically Reported Cause of Death (OA40 - OA42).

In summary, information from these variables forms the basis for analysis of occupant injury severity and injury consequences. Most of the information comes from official records, and the rest is completed by interviewee information. Perseverance in pursuit of this information will result in a high completion rate for these variables.

Variable Name: Injury Severity (Police Rating)

Element Values:

- 0 0 - No injury
- 1 C - Possible injury
- 2 B - Nonincapacitating injury
- 3 A - Incapacitating injury
- 4 K - Killed
- 5 U - Injury, severity unknown
- 6 Died prior to accident
- 9 Unknown

Source: Police report.

Remarks:

Code the police reported injury severity for this occupant. It is possible that the police could have updated the PAR between the time it was stratified and when it was picked up. For example, a person might have been listed originally with incapacitating injuries (code "3"). Later the person dies (code "4"), and the PAR is changed accordingly. Therefore, use the latest information on the PAR at the time it was obtained from the police agency.

If the police report contains a detailed description of the injuries but does not translate the injuries into the KABCO codes, use the police method for doing so. For example, injuries which are considered to be of an incapacitating nature are classified as "A" (code "3"), nonincapacitating-evident injuries are classified as "B" (code "2"), and possible injuries are "C" (code "1"). Property damage only is classified as "0" (code "0").

Code "5" (U - Injury, severity unknown) is used when the police report indicates a "U" or in any other way communicates the idea that the person was injured but their severity is unknown.

Code "6" (Died prior to accident) is only used if the police explicitly so indicate.

As a general rule, if the PAR is "blank" where the injury severity is assessed and the person was at the scene during the police investigation, then code "0" (0 - No injury). If the PAR is "blank" and the person was not present during the police investigation, then code "9" (Unknown).

Not all states use the KABCOU scheme. Listed below, by state, are alternative schemes; a mapping to the NASS scheme is provided.

Variable Name: Injury Severity (Police Rating) [cont'd.]

<u>State</u>	<u>PAR Code/Definition</u>	<u>NASS Scheme/Code</u>
Alabama	K = Killed	K - 4
	A = Visible or carried from scene	A - 3
	B = Bruise/abrasion/swelling	B - 2
	C = No visibility - has pain/faint	C - 1
	Blank = No documentation of driver or occupant injury	Blank - 0
	= No set unknown code	- 9
Arizona	1 = No injury	O - 0
	2 = Possible injury	C - 1
	3 = Nonincapacitating injury	B - 2
	4 = Incapacitating injury	A - 3
	5 = Fatal	K - 4
	6 = Unknown	U - 9
California	1 = Fatal	K - 4
	2 = Severe wound/distorted member	A - 3
	3 = Other visible injury	B - 2
	4 = Complaint of pain	C - 1
	Blank = Occupant present	O - 0
	Blank = Occupant not present	- 9
Colorado*	5 = Fatal	K - 4
	4 = Evident - incapacitating	A - 3
	3 = Evident - nonincapacitating	B - 2
	2 = Possible injury	C - 1
	1 = No injury	O - 0
<p>* There is a box at the top of the PAR indicating number of persons injured. If this box is marked 0 and the injury code is left "blank", assume "No injury". If the box is marked 1 (or more) pertaining to the vehicle occupants in question and the injury code is "blank", assume "Injured, severity unknown". If "blanks" are present in both the persons injured box and the injury code box, assume "Unknown".</p>		
Florida	1 = No Injury	O - 0
	2 = Fatal (IN 90 Days) Injury	K - 4
	3 = Incapacitating Injury	A - 3
	4 = Nonincapacitating Injury	B - 2
	5 = Possible Injury	C - 1
	6 = Non-Traffic Fatality	U - 9
	= No set unknown code	- 9

Variable Name: Injury Severity (Police Rating) [cont'd.]

State	PAR Code/Definition			NASS Scheme/Code
Indiana	Nature of Most Severe Injury (21)	Location of Most Severe Injury (22)	Victim's Injury Status (23)	
	1-11 Any Entry	1-12 Any Entry	6 Dead	K - 4
	1-11 Any Entry	1-12 Any Entry	2 Semiconscious 3 Incoherent 4 Unconscious	A - 3
	1 Severed 2 Internal 4 Severe Burn 7 Severe Bleed (Arterial) 8 Fracture/ dislocation	1-12 Any Entry	1 Conscious 5 Shock 7 Refused Med	A - 3
	3 Minor Burn 6 Minor Bleed 10 Complaint of Pain 11 None Visible	3 Eye	1 Conscious 5 Shock 7 Refused Med	A - 3
	3 Minor Burn 6 Minor Bleed	1-2, 4-12 (Any EXCEPT Eye)	1 Conscious 5 Shock 7 Refused Med	B - 2
	5 Abrasion 9 Contusion/ Bruise	1-12 Any Entry	1 Conscious 5 Shock 7 Refused Med	B - 2
	10 Complaint of Pain 11 None Visible	1-2, 4-12 (Any EXCEPT Eye)	1 Conscious 5 Shock 7 Refused Med	C - 1
	11 None Visible	Blank or Slashed	1 Conscious	0 - 0
	Blank or Slashed	Blank or Slashed	Blank or Slashed	0 - 0
	Unknown	Unknown	Unknown	U - 9

Variable Name: Injury Severity (Police Rating) [cont'd.]

State	PAR Code/Definition	NASS Scheme/Code	
Maryland	5 = Fatal	K - 4	
	4 = Incapacitating	A - 3	
	3 = Nonincapacitating	B - 2	
	2 = Possible injury	C - 1	
	1 = No injury/Damage only	O - 0	
	Blank = No documentation of driver or occupants on front of PAR		
Nebraska	4 = Fatal	K - 4	
	3 = Incapacitating injury	A - 3	
	2 = Nonincapacitating injury	B - 2	
	1 = Possible injury	C - 1	
	0 = No injury	O - 0	
	Blank = Occupant present Blank = Occupant not present	O - 0 - 9	
New Jersey	Location of Injury Type of Injury Victim's Condition		
	Any entry Any entry Killed	K - 4	
	Any entry Any entry Incapacitated	A - 3	
	Any entry amputation, concussion, internal, fracture/dislocation	Moderate injury complaint of pain	A - 3
	Eye burn, bleeding, complaint of pain	Moderate injury Complaint of pain	A - 3
	Any entry bleeding, contusion, bruise, abrasion	Moderate injury	B - 2
	Any entry (except eye) complaint of pain	Complaint of pain	C - 1
	- - -		O - 0
	U U U		- 9

Variable Name: Injury Severity (Police Rating) [cont'd.]

State	PAR Code/Definition			NASS Scheme/Code
New York	Location of Injury {14}	Type of Injury {15}	Victim's Status {16}	
	1-12 Any entry	1-13 Any entry	1 Apparent death	K - 4
	1-12 Any entry	1-13 Any entry	2 Unconscious, 3 Semi-conscious, 4 Incoherent	A - 3
	1-12 Any entry	1 Amputation, 2 Concussion, 3 Internal, 5 Severe Bleeding, 7 Moderate Burn, 8 Severe Burn, 9 Fracture - Dislocation	5 Shock, 6 Conscious	A - 3
	3 Eye	4 Minor Bleeding, 6 Minor Burn, 12 Complaint of Pain	5 Shock, 6 Conscious	A - 3
	All but eye 1, 2, 4-12	4 Minor Bleeding, 6 Minor Burn	5 Shock, 6 Conscious	B - 2
	1-12 Any entry	10 Contusions - Bruise, 11 Abrasion	5 Shock, 6 Conscious	B - 2
	All but eye 1, 2, 4-12	12 Complaint of Pain	5 Shock, 6 Conscious	C - 1
	-	13 None Visible	6 Conscious	0 - 0
	X	X	X	- 9

Variable Name: Injury Severity (Police Rating) [cont'd.]

<u>State</u>	<u>PAR Code/Definition</u>	<u>NASS Scheme/Code</u>
Pennsylvania	0 = No injury	O - 0
	1 = Death	K - 4
	2 = Major injury	A - 3
	3 = Moderate injury [and] Type of Apparent Injury - amputation - broken bone(s)	A - 3
	3 = Moderate injury [and] Type of Apparent Injury - abrasions/contusions/bruises - burns - bleeding - concussion - other	B - 2
Tennessee	4 = Minor injury [and] Type of Apparent Injury - complaint of pain - dizziness - shock	C - 1
	4 = Dead at time of report	K - 4
	3 = Bleeding wound, distorted member	A - 3
	2 = Bruises, abrasions, swelling, limping, etc.	B - 2
	1 = Complaint of pain, no visible injury	C - 1
Blank = No documentation of driver or occupants on front of PAR or on supplement	O - C	
Washington	1 = No injury	O - C
	2 = Dead at scene	K - 4
	3 = Dead on arrival	K - 4
	4 = Died in hospital	K - 4
	5 = Disabling injury	A - 3
	6 = Nondisabling injury	B - 2
	7 = Possible injury	C - 1
Blank = Unknown	- 9	

Variable Name: Treatment - Mortality

Element Values:

- 0 No treatment
- 1 Fatal
- 2 Fatal - ruled disease

Nonfatal

- 3 Hospitalized
- 4 Transported and released
- 5 Treatment at scene - nontransported
- 6 Treatment later
- 8 Treatment - other (specify)
- 9 Unknown

Source: Researcher determined--inputs include interviewee, police report, and medical records.

Remarks:

Official sources (if they exist) take precedence over interview data.

Code "0" (No treatment) includes persons transported to a hospital but who refuse treatment. As long as there was transportation directly from the scene, a refusal of treatment will not, on its own, affect the stratification of the case.

Code "1" (Fatal) is used when death occurs within 30 days of the accident. Death must have occurred as a consequence of injuries sustained in the traffic accident. Interview information alone should not be sufficient to select this code.

Code "2" (Fatal - ruled disease) is used in two situations. The first is when the effects of a disease can be deemed as a cause of the accident. Cause means that the on-set of the disease occurred prior to the first harmful event. When determining the time of on-set (relative to the first harmful event), the researcher can use any information source available. The researcher makes his/her determination after weighing all the evidence. (NOTE: The use of all available information sources is restricted to the determination of when the on-set occurred.)

Code "2" (Fatal - ruled disease) is used additionally when a medical examiner (or other official vested by the state to verify the cause of death) or an official medical report verifies that the death resulted from either (1) a diseased condition, or (2) not from accident related injuries.

Code "3" (Hospitalized) is used when hospitalization occurs as a result of injury (need not be taken directly to a hospital). See Hospital Stay

Variable Name: Treatment - Mortality (cont'd.)

(OA37) for hospitalization criteria. Also use this code if a person is treated and released then subsequently hospitalized as a result of injuries sustained in the accident.

Code "4" (Transported and released) is used when the person went directly from the accident scene to a treatment facility (hospital, clinic, doctor's office, etc.), and the person is examined for injuries at the facility. The person need not have been injured. The means of transportation is not a consideration.

Code "5" (Treatment at scene - nontransported) includes treatment at scene such as: first aid, self-treatment, EMT treatment, doctor treatment, etc.--and the person is not transported or does not go to a treatment facility (e.g., doctor, clinic, hospital, etc.) as a result of injuries sustained in this accident.

Code "6" (Treatment later) includes only professional treatment (e.g., doctor, clinic, hospital, etc.) where the person (1) did not go directly from the scene to treatment, and (2) was treated and released. If a person is treated at the scene, is not transported from the scene, and subsequently receives later treatment (without being hospitalized), then use this code.

Code "8" (Treatment - other) includes nonprofessional treatment such as first aid, self-treatment, etc., not at the scene of the accident. If this code is used, then OA36, Type of Medical Facility (for Initial Treatment), must be coded "0" (Not treated at a medical facility).

If a person survives the injuries and receives treatment at a hospital, but is not admitted for hospitalization, that person's treatment is to be coded as either "4" (Transported and released) or "6" (Treatment later), depending upon whether the person went directly or indirectly to the hospital. It does not matter if the person is treated for one hour or twelve, only that the person is released following treatment. Nor does it matter if the treatment begins prior to midnight and spans into the following day.

Variable Name: Type of Medical Facility (for Initial Treatment)

Element Values:

- 0 Not treated at a medical facility
- 1 Trauma center
- 2 Hospital
- 3 Medical clinic
- 4 Physician's office
- 5 Treatment later at medical facility
- 8 Other (specify)
- 9 Unknown

Source: Researcher determined--inputs include police report, interviewee, official records, and the American College of Surgeons classification criteria.

Remarks:

The treatment of injuries by a physician immediately (i.e., within one hour) following an accident is of utmost importance in serious injury accidents. In order to assess the quality of immediate care available to the victims in CDS accidents, the following criteria are used to categorize the various treatment facilities. Teams must develop a listing of treatment facilities serving their PSU and categorize each into this variable's coding scheme. Teams must communicate their list to their respective zone center.

Code "0" (Not treated at a medical facility) is used when the person was not injured or receives nonprofessional treatment such as first-aid, self-treatment, etc. In addition, use this code for persons who "died" at the scene or "died in-route" to a medical facility. Treatment at the scene or in-route to a medical facility by emergency medical personnel is not considered initial treatment for the purposes of this variable. This is true even if the facility has radio communications with their EMTs. If a person arrives at a medical facility and subsequently dies or is declared dead, then use one of the following codes. For example, an occupant arrives with no vital signs, CPR in progress, and a "flat" EKG and is declared "dead on arrival" on the ER report, code the facilities classification from one of the codes below.

Code "1" (Trauma center) is used when the occupant was initially treated at a Level I or Level II Trauma Center as defined by the American College of Surgeon's Committee on Trauma report entitled: "Hospital and pre-hospital resources for optimal care of the injured patient", American College of Surgeons Bulletin, Vol. 71, No. 10, October 1986, pp. 4-12.

The fact that a medical facility calls itself a "Trauma Center" or something of the same nature does not mean that it satisfies the criteria for code "1" (Trauma center). The facility must meet the criteria as noted in the preceding paragraph. Teams should contact their "hospitals" and ask each what they

Variable Name: Type of Medical Facility (for Initial Treatment) [cont'd.]

consider themselves to be (according to criteria referenced above). Teams should also be alert for communication releases (i.e., newspapers, radio, TV, etc.) which concern the trauma capability status of their area emergency rooms.

Code "2" (Hospital) is used for all "hospitals" which do not fall into the definition of a Level I or Level II Trauma Center as defined.

Code "3" (Medical clinic) is used for treatment facilities which provide outpatient medical care with related in-house laboratory facilities (e.g, x- ray). These are usually a group practice in which several physicians work cooperatively. This code also includes school clinics, work place clinics, or similar facilities if they are staffed by a physician while open. If a doctor is not normally present at a clinic while it is open, then the appropriate code is "8" (Other).

Code "4" (Physician's office) is used when the person is initially treated in an office of a professional health care provider which does not qualify for codes "1" (Trauma center), "2" (Hospital), or "3" (Medical clinic).

Code "5" (Treatment later at medical facility) is used when a person's initial treatment by a health care professional (i.e., doctor) took place more than one hour after the accident. In addition, use this code when OA35, Treatment-Mortality, is coded "6" (Treatment later).

Code "8" (Other) is used when a health care provider's facility is used for the initial treatment, and the facility does not qualify for one of the codes "1" (Trauma center), "2" (Hospital), "3" (Medical clinic), or "4" (Physician's office) above.

Code "9" (Unknown) is used when it is unknown what type of initial treatment facility was used or when it is unknown if treatment of any kind was obtained.

Variable Name: Hospital Stay

Element Values:

Range: 00-61, 99

00 Not hospitalized

Code the number of days (up through 60) that the occupant stayed in the hospital

61 61 days or more

99 Unknown

Source: Researcher determined--inputs include interviewee and medical reports.

Remarks:

Official sources (if they exist) take precedence over interview data.

Code "00" (Not hospitalized) is used when the person was not injured or injured but not admitted to the facility (i.e., admission to the facility's emergency room is not "admission" to the facility for the purposes of the hospitalization question). In addition, use this code if fatal at scene, pronounced dead on arrival, or survival does not extend beyond the emergency room.

The basis for the number of days coded is an overnight criterion. Every time a person remains past midnight subsequent to admission, it is one day. However, there are two exceptions. One exception occurs when a person dies on the same day as the admission. In this situation, use code "01". The other exception occurs when a person is admitted in the early morning hours (between midnight and 7:00 a.m.), usually for observation, and is subsequently released later in the same day (usually late morning or early afternoon). Code "01" is used because the person was hospitalized [OA35, Treatment - Mortality, equals "3" (Hospitalized)].

If your information indicates that the person died while in a critical care unit [e.g., intensive (i.e., ICU), coronary (i.e., CCU), etc.], then at least code "01" is used even if the person expires on the same day. In other words, a person is considered admitted if they are still alive when they are transferred to a critical care unit. On the other hand, in the event that the person survives the emergency room but subsequently dies during surgery, then code "00" (Not hospitalized) is used, because a person who goes directly from the emergency room to an operating room is not considered to have been admitted.

If a person is admitted, lives four days in the hospital, and subsequently expires, then use code "04".

Variable Name: Working Days Lost

Element Values:

Range: 00-62, 97, 99

00 No working days lost

Code the number of days (up through 60) that the occupant lost from work due to the accident

61 61 days or more

62 Fatally injured

97 Not working prior to accident

99 Unknown

Source: Primary source is the interviewee; a secondary source is the person's employer.

Remarks:

Report the actual number of "work" days lost due to the accident by an employed person or a full-time college student. Children, adolescents, retirees, or unemployed persons are not included [code "97" (Not working prior to accident.)].

Employed is defined to mean that the person was scheduled to work at least four hours on each of the days lost. Each such day is counted as a full day so long as the person was scheduled to work at least four hours on the day lost. Do not accumulate the hours and convert to equivalent full-time days; however, indicate on the form if the person works less than full-time but greater than four hours per day by annotating "part-time" or "PT".

If during the interview a reasonable projection of future days lost can be made, then add those days to those already known to have been lost. If a reasonable projection cannot be made, then code "99" (Unknown).

The days lost need not be due to injury.

Days lost include Saturdays, Sundays, and afternoon and evening shifts if so scheduled. Do not count double shifts or days at time and one-half pay, etc., as more than one day.

Code "62" (Fatally injured) is used if a person is "fatal - ruled disease", fatal at scene, pronounced dead on arrival, or survival does not extend beyond the emergency room. In addition, if a person expires within thirty days following the accident, use this code regardless of whether or not the person missed any working days.

Code "97" (Not working prior to accident) is used when a person is not employed, not a full-time college student, or works less than four hours per day. This code includes all persons (except fatals) who do not qualify to lose working days.

Variable Name: Working Days Lost (cont'd.)

If the reported work days lost includes a fraction, round one-half (1/2) day or greater up to a whole day. Less than one-half day is excluded (rounded down).

If someone loses their job as a result of the accident, then count only the work days lost between the accident and the date of termination, inclusive.

Do not include days lost by persons who were not directly involved in the accident but who lost days because of it (e.g., husband who was not in accident but stayed home to take care of wife who was injured and required assistance).

If an involved person changes their work schedule as a result of an accident (e.g., to take care of someone injured in the accident), then the work time, which was given up as a result of the accident, shall not be considered as lost.

If no interview is obtained, there is a rebuttable presumption that persons over 65 or under 17 are not employed full-time; for these persons code "97" (Not working prior to accident) is used unless the person is fatally injured [codes "1" (Fatal) or "2" (Fatal - ruled disease) for OA35, Treatment - Mortality].

Variable Name: Time to Death

Element Values:

Range: 00 through 24, 31 through 60, 96, 99

00 Not fatal

96 Fatal - ruled disease

99 Unknown

Source: Police report, hospital/medical records, autopsy report, or other official records for actual time of death for fatally injured occupants.

Remarks:

Code "00" (Not fatal) identifies (from any source) all occupants who are not fatally injured (i.e., death does not occur, or death does not occur within thirty days of the accident). Occupants of hit-and-run vehicles are assumed not killed.

Record the time-of-death of all occupants who die within thirty days of the accident unless their death meets the criteria of code "96" (Fatal - ruled disease).

Code "01" identifies occupants who die within (less than) one and a half hours of the time of the accident.

Codes "02" through "24" identify occupants who die in the period of time between one and a half hours from the time of the accident to twenty-four hours after the accident. Code the time between accident and death to the nearest hour except for code "24" which is used only for the period between twenty-three and a half hours after the accident and twenty-four hours after the accident.

Codes "31" through "60" identify occupants who die in the period of time between greater than twenty-four hours after the accident and thirty days after the accident (24 hours and one minute is coded as "31" while 24 hours is coded as "24"). (NOTE: One day = "31", two days = "32", ..., twenty-nine days = "59", and thirty days = "60".) The number of days is rounded off to the nearest whole day except for code "60" which is used for the period between twenty-nine days and twelve hours and thirty days after the accident.

Code "96" (Fatal - ruled disease) is used in two situations. The first is when the effects of a disease can be deemed as a cause of the accident. Cause means that the on-set of the disease occurred prior to the first harmful event. When determining the time of on-set (relative to the first harmful event), the researcher can use any information source available. The researcher makes his/her determination after weighing all the evidence. (NOTE: The use of all available information sources is restricted to the determination of when the on-set occurred.)

Variable Name: Time to Death (cont'd.)

Code "96" (Fatal - ruled disease) is used additionally when a medical examiner (or other official vested by the state to verify the cause of death) or an official medical report verifies that the death resulted from either (1) a diseased condition, or (2) not from accident-related injuries.

Code "99" (Unknown) is used when the length of time between the time of the accident and the time the person was pronounced dead by a qualifying person (coroner, state medical examiner, etc.) is unknown. Do not code "01" unless the length of time is known to be less than one and one-half hours. Autopsy reports do not always specify time to death; thus, emergency room records must always be sought even when it is known that an autopsy report can be obtained.

The exact time period which applies to each code is shown in the table below.

Code	Time period in hours	Code	Time period in days
01	0 - < 1 1/2	31	> 1 - < 1 1/2
02	1 1/2 - < 2 1/2	32	1 1/2 - < 2 1/2
03	2 1/2 - < 3 1/2	33	2 1/2 - < 3 1/2
04	3 1/2 - < 4 1/2	34	3 1/2 - < 4 1/2
05	4 1/2 - < 5 1/2	35	4 1/2 - < 5 1/2
06	5 1/2 - < 6 1/2	36	5 1/2 - < 6 1/2
07	6 1/2 - < 7 1/2	37	6 1/2 - < 7 1/2
08	7 1/2 - < 8 1/2	38	7 1/2 - < 8 1/2
09	8 1/2 - < 9 1/2	39	8 1/2 - < 9 1/2
10	9 1/2 - < 10 1/2	40	9 1/2 - < 10 1/2
11	10 1/2 - < 11 1/2	41	10 1/2 - < 11 1/2
12	11 1/2 - < 12 1/2	42	11 1/2 - < 12 1/2
13	12 1/2 - < 13 1/2	43	12 1/2 - < 13 1/2
14	13 1/2 - < 14 1/2	44	13 1/2 - < 14 1/2
15	14 1/2 - < 15 1/2	45	14 1/2 - < 15 1/2
16	15 1/2 - < 16 1/2	46	15 1/2 - < 16 1/2
17	16 1/2 - < 17 1/2	47	16 1/2 - < 17 1/2
18	17 1/2 - < 18 1/2	48	17 1/2 - < 18 1/2
19	18 1/2 - < 19 1/2	49	18 1/2 - < 19 1/2
20	19 1/2 - < 20 1/2	50	19 1/2 - < 20 1/2
21	20 1/2 - < 21 1/2	51	20 1/2 - < 21 1/2
22	21 1/2 - < 22 1/2	52	21 1/2 - < 22 1/2
23	22 1/2 - < 23 1/2	53	22 1/2 - < 23 1/2
24	23 1/2 - 24	54	23 1/2 - < 24 1/2
		55	24 1/2 - < 25 1/2
		56	25 1/2 - < 26 1/2
		57	26 1/2 - < 27 1/2
		58	27 1/2 - < 28 1/2
		59	28 1/2 - < 29 1/2
		60	29 1/2 - 30

OCCUPANT ASSESSMENT FORM

OA40
OA41
OA42

Variable Name: 1st Medically Reported Cause of Death
2nd Medically Reported Cause of Death
3rd Medically Reported Cause of Death

Element Values:

00 Not fatal or no additional causes
Code the Occupant Injury from line number(s) for the medically reported injury(s) which reportedly contributed to this occupant's death
97 Other result (specify)
99 Unknown

Source: Official records

Remarks:

This variable records the injury(s) which was/were determined by the medical professional completing the report to be the cause of death. If the occupant was not fatally injured, then these variables must all be coded "00" (Not fatal or no additional causes). If the occupant was killed but no official medically reported cause of death is provided, then code OA40 as "99" (Unknown) and OA41 and OA42 as "00" (Not fatal or no additional causes).

Code the row number(s) of the injury(s), from the Occupant Injury Form, which caused the death. If only one injury is reported as a cause of death, code that injury row's number for OA40 and code OA41 and OA42 as "00" (Not fatal or no additional causes). The same logic applies if two injuries are reported.

Code "97" (Other result) is used when it is determined that the occupant qualifies for code "2" (Fatal-ruled disease) in variable OA35, Treatment - Mortality. This code is also used when the cause of death is reported from a source other than directly from a coded injury (i.e., as from complications or consequences of injuries).

If no cause of death is directly from an injury, then encode OA40 as "97" (Other result) and OA41 and OA42 as "00" (Not fatal or no additional causes).

Variable Name: Number of Recorded Injuries for This Occupant

Element Values:

Range: 00-96, 97, 99

00 No recorded injuries

Code the actual number of injuries recorded for this occupant

97 Injured, details unknown

99 Unknown if injured

Source: Researcher determined--inputs include official medical records and interviewee.

Remarks:

Record this occupant's total number of coded injuries that were encoded on the Occupant Injury Form. If the only injury information available is from a police accident report, then follow Injury Coding Procedure #6 (on page OI-5) found in the INJURY DATA OVERVIEW.

Code "00" (No recorded injuries) is used when the occupant is uninjured.

Code "97" (Injured, details unknown) is used when the occupant is injured but the details are unknown. This means that the source(s) of injury information cannot identify any specific (a) O.I.C. Body Region as having been injured, (b) O.I.C. Lesion suffered, and (c) O.I.C. System/Organ affected. If one or more specific O.I.C. Body Regions, Lesions, or System/Organs can be identified, then encode the number of known injuries.

Code "99" (Unknown if injured) is used when it is unknown if the occupant was injured.

If "00", "97", or "99" is coded, then the Occupant Injury Form is not used.

If an injured occupant has only one known recorded injury (i.e., "01"), then the Occupant Injury Classification (OIC) - Abbreviated Injury Scale (AIS) variables (i.e., OI06 through OI10) must not equal "U", "U", "U", "U", "7".

Variable Name: Automatic (Passive) Belt System Availability/Function

Element Values:

- 0 Not equipped/available
- 1 2 point automatic belts
- 2 3 point automatic belts
- 3 Automatic belts - type unknown

Non-functional

- 4 Automatic belts destroyed or rendered inoperative
- 9 Unknown

Source: Researcher determined--Primary source is the vehicle inspection; secondary sources include medical records, the interview, and police report. NOTE: The use of the police report is limited. If there is no vehicle inspection and the only secondary source is the PAR, then the PAR "narrative" must clearly state that the automatic belt system was used or available. An indication of usage or availability in a "restraint system" block is, by itself, not usable.

Remarks:

Some belt restraint systems are a combination of manual (active) and automatic (passive) occupant protection devices. For this variable, consider only the automatic portion of the system. Select the automatic belt system which was available at the time of the accident for this occupant.

Automatic belts are designed to restrain an occupant and allow an occupant egress (the act of going from an enclosed place) without the requirement of manually activating the belt. Some systems use only a torso belt [code "1" (2 point automatic belts)], while others are designed with a lap and torso belt [code "2" (3 point automatic belts)]. A clue for proper system identification involves the egress issue. If you are sitting in the occupant's position and all belts are attached and you open the door, then determine if you have to detach any belt in order to exit the vehicle. Belts which do not require detaching are automatic belts. Note! The ease of egress is not considered because many automatic belt systems may appear cumbersome.

Availability is assessed based on the occupant's seating position. Select the automatic belt system which was available for use, if so desired, by the occupant relative to the occupant's seating position in the vehicle. Availability is also determined by presence, functional status, and use of the automatic belt system. Any occupant who is using a belt restraint system, or portion thereof, must by default have that system available to them. The correctness and/or appropriateness of the use is considered in OA47, Proper Use of Automatic (Passive) Belt System.

Certain occupant seating situations are problematic. Some problematic example situations are:

Variable Name: Automatic (Passive) Belt System Availability/Function
[cont'd.]

- occupant on the floor [i.e., in front of a designated seat (e.g., sitting, standing, etc.)];
- occupant lying across one or more seating positions;
- occupant sitting side-by-side of another occupant in the same seating position, since only one can be assigned to the seating position--see OA10, Occupant's Seat Position;
- occupant standing or kneeling in a designated seating position); and
- occupant in or on the lap of another occupant (e.g., sitting, standing, kneeling, etc.).

Occupant on the floor: Code "0" (Not equipped/not available). These occupants are not in a designated seating position and do not have an automatic belt available.

Occupant lying across one or more seating positions: For an occupant lying across multiple seating positions, OA10 (Occupant's Seat Position) must equal code "14", "24", "34", or "44". These occupants can be using an automatic belt. Availability is assessed for any of the seating position(s) that the occupant is lying across. If there are more than one type of automatic belt, or if some automatic belts are damaged, choose the automatic belt that is most functional and which provides the greater occupant protection (i.e., choose an automatic lap and shoulder belt over an automatic lap belt). Do not confuse this situation with occupants lying against a door or side panel or against another occupant. Persons in this latter category are still considered to be occupying a single occupant seating position.

Occupant sitting side-by-side of another occupant in the same seating position: These occupants (i.e., OA10 equal "14", "24", "34", "44") do not have an automatic belt available unless such a person is sharing the use of an automatic belt (i.e., two or more persons sitting side-by-side using the same automatic belt should have the same restraint available for each occupant).

Occupant standing or kneeling in a designated seating position: These occupants can have automatic belts available to them for use. Availability is assessed for these occupants based on the occupant's assigned seating position.

Occupant in or on the lap of another occupant: These occupants do not have an automatic belt available unless such a person is sharing the use of an automatic belt (i.e., two or more persons sitting in front of one another or on top of one another using the same automatic belt).

Code "0" (Not equipped/not available) indicates: (1) that at the time of the accident the designated seating position that the occupant was in, was not equipped with a manufacture installed or post manufacture installed automatic belt (2 point or 3 point); (2) the occupant was not in a designated seat position (e.g., on the floor); (3) the occupant was not the person assigned the designated seat position and was not using an automatic belt (e.g., sitting side-by-side); or (4) the seat position that the occupant was in was equipped only with a manual (active) belt system.

Variable Name: Automatic (Passive) Belt System Availability/Function
[cont'd.]

Code "1" (2 point automatic belts) is used when a torso belt is anchored along the inboard side of the front seat and anchored either at the upper window frame of the door surface (adjacent to the upper B-pillar) or attached to a motorized track located along the upper A-pillar, roof side rail, and upper B-pillar. A two point automatic belt system requires the presence of either a manual lap belt or a knee bolster.

Code "2" (3 point automatic belts) is used for an automatic belt system consisting of a lap and torso belt. This system uses a common anchor for both belts located on the inboard side of the front seat and two anchors along the door surface (e.g., commonly used in late model General Motors cars). This system can be detected by sitting in the occupant's position with the latch plate/buckle attached and opening the door. If the belt travels with the door and allows egress without detaching the belt, then use this code--the system is automatic.

Vehicles equipped with automatic (passive) belts can be identified through their Vehicle Identification Number (VIN; i.e., GV08). To assist in this identification a table appears at the end of the Occupant Assessment Form section and is entitled: Automatic (Passive) Restraint System Availability. This table attempts to provide comprehensive identification of vehicular passive restraint type by specific vehicle year, make, model, and VIN character identification.

Code "3" (Automatic belts - type unknown) is used when (1) no vehicle inspection occurs and the occupant's seating position is known to have automatic belts (e.g., from the VIN--GV08) but the type (2 point versus 3 point) is unknown, or (2) a vehicle inspection occurs and the occupant's seating position is known to have automatic belts but the researcher is not able to determine from the vehicle inspection or any secondary sources what type of automatic belts are available.

If the type of automatic belt system is determinable, then the system's mechanization can also be determined because most manufacturers use the same type of system for a given vehicular model. In addition, if the type of automatic belt system is undeterminable, then it is assumed that the system is functional (i.e., code "3" takes precedence over code "4" below).

Code "4" (Automatic belts destroyed or rendered inoperative) is used when the automatic belt, initially installed at this occupant's seating position, was subsequently removed or destroyed (e.g., unbolted, cutout, etc.) or in any way rendered inoperative. In addition, use this code for belts which are extremely deteriorated from aging. Do not use this code for motorized belt tracks which are mechanically or electrically inoperative.

Belts which are knotted, buckled at the rear of the seat (bench or bucket), etc., are available if they were otherwise operative.

Variable Name: Automatic (Passive) Belt System Availability/Function
[cont'd.]

Code "9" (Unknown) is used for front outboard seat occupants of uninspected passenger vehicles (GV07="01"- "09", "12") where it cannot be determined from any secondary source whether or not this occupant's seating position was equipped with an automatic belt system.

Variable Name: Automatic (Passive) Belt System Use

Element Values:

- 0 Not equipped/not available/destroyed or rendered inoperative
- 1 Automatic belt in use
- 2 Automatic belt not in use (manually disconnected, motorized track inoperative) (specify)
- 3 Automatic belt use unknown
- 9 Unknown

Source: Researcher determined--Primary source is the vehicle inspection; secondary sources include the interview and medical records. NOTE: Do not use the police accident report as a source for coding this variable.

Remarks:

Code "0" (Not equipped/not available/destroyed or rendered inoperative) is used when OA44, Automatic (Passive) Belt System Availability/Function, is coded "0" (Not equipped/not available) or OA44 is coded "4" (Automatic belts destroyed or rendered inoperative).

Code "1" (Automatic belt in use) is used when OA44, Automatic (Passive) Belt System Availability/Function, equals "1" (2 point automatic belts), "2" (3 point automatic belts), or "3" (Automatic belts - type unknown) and this occupant was using the automatic belt. The correctness of the use is not assessed on this variable [see variable OA47, Proper Use of Automatic (Passive) Belt System].

Code "2" [Automatic belt not in use (manually disconnected, motorized track inoperative)] is used when the automatic belt's latch plate/buckle was detached at the time of the accident. For example, this code is used to capture disconnected 3-point, door mounted automatic belts (i.e., 1987 and newer General Motors vehicles) which can be used similar to an active lap and shoulder belt system.

This code is also used for motorized tracks which were not in the restrained position at the time of the accident. The motorized track may be inoperative because of fuse removal, electric motor failure, or track failure when the malfunction prevents the automatic belt system from moving along its track into the restrained position.

Note! This variable does not assess how this occupant uses the automatic belt when entering or exiting the seating position. For example, this occupant may routinely manually detach/attach the latch plate/buckle (i.e., uses the automatic belt system as if it were a manual belt system). This variable assumes that the nonmotorized automatic belt is available and functioning and assesses whether or not the latch plate/buckle was attached at the time of the accident. If the latch plate/buckle was attached at the time of the accident, then use code "1" (Automatic belt in use). On the other hand, if it was detached, then use code "2" [Automatic belt not in use (manually disconnected, motorized track inoperative)]. For motorized belts, this variable assumes that the motorized belt system is locked in the restrained position with the belt attached at the

Variable Name: Automatic (Passive) Belt System Use [cont'd.]

time of the accident. If the motorized belt system was locked in the restrained position and the belt was attached at the time of the accident, then use code "1" (Automatic belt in use). If the motorized belt system was not locked in the restrained position or the belt was detached, then used code "2" [Automatic belt not in use (manually disconnected, motorized track inoperative)].

Code "3" (Automatic belt use unknown) is used when OA44, Automatic (Passive) Belt System Availability/Function, equals "1" (2 point automatic belts), "2" (3 point automatic belts), or "3" (Automatic belts - type unknown) and the researcher is unable to determine if the automatic belt was in use.

Code "9" (Unknown) is used when it cannot be determined from any source whether or not this occupant's seating position was equipped with an automatic belt system [i.e., OA44 equals "9" (Unknown)]

Variable Name: Automatic (Passive) Belt System Type

Element Values:

- 0 Not equipped/not available
- 1 Non-motorized system
- 2 Motorized system
- 9 Unknown

Source: Researcher determined--Primary source is the vehicle inspection; secondary sources include the interview, police report, and medical records. NOTE: The use of the police report is limited. If there is no vehicle inspection and the only secondary source is the PAR, then the PAR "narrative" must clearly state what type of automatic belt system was used.

Remarks:

Code "0" (Not equipped/not available) is used when OA44, Automatic (Passive) Belt System Availability/Function, is coded "0" (Not equipped/not available). If the automatic belt system was not functioning [i.e., OA44 equals "4" (Automatic belts destroyed or rendered inoperative)], then indicate the mechanization of the system by using code "1" (Non-motorized system) or "2" (Motorized system) below.

Code "1" (Non-motorized system) is used when the automatic belt system available to this occupant does not require a motor for operation.

Code "2" (Motorized system) is used when the automatic belt system available to this occupant requires a motor for operation.

Vehicles equipped with automatic (passive) belts can be identified through their Vehicle Identification Number (VIN; i.e., GV08). To assist in this identification a table appears at the end of the Occupant Assessment Form section and is entitled: Automatic (Passive) Restraint System Availability. This table attempts to provide comprehensive identification of vehicular passive restraint type by specific vehicle year, make, model, and VIN character identification.

Code "9" (Unknown) is used when it cannot be determined from any source whether or not this occupant's seating position was equipped with an automatic belt system [i.e., OA44 equals "9" (Unknown)]. In addition, use this code when it is known that an automatic belt is available but the type (non-motorized or motorized) cannot be determined.

Variable Name: Proper Use of Automatic (Passive) Belt System

Element Values:

- 0 Not equipped/not available/not used
- 1 Automatic belt used properly
- 2 Automatic belt used properly with child safety seat

Automatic Belt Used Improperly

- 3 Automatic shoulder belt worn under arm
- 4 Automatic shoulder belt worn behind back
- 5 Automatic belt worn around more than one person
- 6 Lap portion of automatic belt worn on abdomen
- 7 Automatic lap and shoulder belt or automatic shoulder belt used improperly with child safety seat (specify)
- 8 Other improper use of automatic belt system (specify)
- 9 Unknown

Source: Researcher determined--Primary source is the vehicle inspection; secondary sources include the interview, police report, and medical records. NOTE: The use of the police report is limited. If there is no vehicle inspection and the only secondary source is the PAR, then the PAR "narrative" must clearly state that the automatic belt system was used properly or improperly.

Remarks:

This variable must be assessed by the researcher using all available data. An improperly used automatic belt can cause a large variety of injuries by itself or, depending upon the way it is improperly used, it can allow other injuries to occur which might not have happened if the restraint was properly used. In severe cases an improperly worn belt can be the cause of death. An improperly used belt can also lead to belt failure which is addressed in variable OA48, Automatic (Passive) Belt Failure Modes During Accident. If there is an improperly used belt and/or a belt system failure, they should be noted on the Case Summary Form.

Code "0" (Not equipped/not available/not used) is used when OA44, Automatic (Passive) Belt System Availability/Function, is coded "0" (Not equipped/not available), OA44 is coded "4" (Automatic belts destroyed or rendered inoperative), or OA45, Automatic (Passive) Belt System Use, is coded "2" [Automatic belt not in use (manually disconnected, motorized track inoperative)]. In other words, in order to assess the properness of use, the automatic belt must be available, functional, and in use [i.e., OA45 equals "1" (Automatic belt in use)].

Code "2" (Automatic belt used properly with child safety seat) is to be indicated only when the child safety seat is installed so as to comply with the manufacturer's directions (i.e., seat must be integrated with the vehicle via the automatic seat belts) and is occupied by a child.

Variable Name: Proper Use of Automatic (Passive) Belt System [cont'd.]

Code "4" (Automatic shoulder belt worn behind back) is used:

- when an occupant has a three point automatic belt but is only "encompassed" by the lap portion (i.e., having the automatic torso belt behind the occupant's back), or
- when an occupant has a two point automatic belt and is not "encompassed" by the torso portion (i.e., the automatic torso belt is attached and is behind the occupant's back).

Code "5" (Automatic belt worn around more than one person) is used when more than one occupant is sharing the same automatic belt. Occupants may be sitting side-by-side, in front of one another, or on top of one another. If the occupants are using a three point automatic belt such that the torso portion is worn behind one or more of the occupants backs while the lap portion encompasses their hips, then use this code.

Code "6" (Lap portion of automatic belt worn on abdomen) is used when the lap belt portion of a three point automatic belt system is worn above the occupant's pelvic bones.

Code "7" (Automatic lap and shoulder belt or automatic shoulder belt used improperly with child safety seat) is used when a child safety seat is not installed according to the manufacturer's directions and is occupied by a child. Specify how the automatic belt was used improperly.

Code "8" (Other improper use of automatic belt system) is used to describe any improper use of the automatic belt system which is not listed above. This includes when an automatic shoulder belt is worn on the outside of an occupant's arm as opposed to under the arm or on top of the shoulder.

Code "9" (Unknown) is used:

- when it cannot be determined from any source whether or not this occupant's seating position was equipped with an automatic belt system [i.e., OA44 equals "9" (Unknown)],
- when it is not known whether the automatic belts used were used properly or improperly (i.e., no interview was conducted and no other information is present that identifies proper or improper use of the automatic belts), and
- when a child safety seat is occupied by a child, but it is unknown if the seat was installed (using either the manufacturer's or the vehicle's automatic belts) according to the manufacturer's directions.

Variable Name: Automatic (Passive) Belt Failure Modes During Accident

Element Values:

- 0 Not equipped/not available/not in use
- 1 No automatic belt failure(s)
- 2 Torn webbing (stretched webbing not included)
- 3 Broken buckle or latchplate
- 4 Upper anchorage separated
- 5 Other anchorage separated (specify)
- 6 Broken retractor
- 7 Combination of above (specify)
- 8 Other automatic belt failure (specify)
- 9 Unknown

Source: Researcher determined--Primary source is the vehicle inspection; additional input may include the interview and police report if a vehicle inspection is obtained.

Remarks:

If any component of the automatic belt system fails during the impact as a result of occupant loading, the failure is encoded on this variable. The failure is also recorded on the Case Summary Form and documented with photographs and diagrams as needed.

Code "0" (Not equipped/not available/not in use) is used when OA47, Proper Use of Automatic (Passive) Belt System, equals "0" (Not equipped/not available/not used). In other words, in order to assess the failure modes, the automatic belt must be available, functional, and in use [i.e., OA45 equals "1" (Automatic belt in use)].

Code "1" [No automatic belt failure(s)] is used when there is no physical evidence from the vehicle inspection to indicate or support that a failure occurred.

Codes "2" through "6" are used to indicate the specific failure of the restraint system. Select the code which corresponds to the appropriate automatic belt failure mode that describes the component of the restraint system which failed (i.e., torn webbing, broken buckle or latchplate, anchorage separation, broken retractor). If a failure occurs, a complete and documented description of the failed component and the way it failed must accompany the case. Include photographs of the failed component(s).

Code "7" (Combination of above) includes any combination of codes "2"- "6" which describes multiple automatic belt failure modes.

Code "8" (Other automatic belt failure) includes any automatic belt failure which is not described in codes "2"- "6" above.

Variable Name: Automatic (Passive) Belt Failure Modes During Accident
[cont'd.]

Code "9" (unknown) is used:

- when there is no vehicle inspection,
- when it cannot be determined from any source whether or not this occupant's seating position was equipped with an automatic belt system [i.e., OA45, Automatic (Passive) Belt System Use, equals "9" (Unknown)], or
- when it is known that an automatic belt is available and functional but it cannot be determined whether or not the automatic belt was in use [i.e., OA45 equals "3" (Automatic belt use unknown)].

OCCUPANT ASSESSMENT FORM

Automatic (Passive) Restraint System Availability

Vehicle Make	Vehicle Model	Vehicle Model Year	MASS Make/Mode Code: GV05-GV06	Air Bag		Passive Belt		VIN Character Identifier			
				Driver Only	Driver & Passenger	Motorized	Non-Motorized	Model		Restraint	
								Place	Code	Place	Code
Acura (Honda)	Integra	1990	54-031			Yes		4-6	DA9,DB1	8	4-6
	Legend LS	1987 to 1988	54-032	Standard				4-6	KA3,4	8	6
	Legend	1989 to 1991	54-032	Standard				4-6	KA3,4	8	3-7
	NSX	1991	54-033	Standard				4-6	???	8	???
Alfa Romeo	Spider	1991	31-031	Standard				4	B	?	?
Audi	80/90	1990 to 1991	32-036	Standard				7-8	8A	6	1
	100/200	1990 to 1991	32-037	Standard				7-8	44	6	1
	Coupe Quattro	1990 to 1991	32-036	Standard				7-8	8B	6	1
	V8	1990 to 1991	32-037	Standard				7-8	44	6	1
BMW	735i	1987	34-037	Option				4	F	8	1
BMW	635CSi	1988 to 1989	34-036	Standard				4	E	8	1
	735i	1988 to 1989	34-037	Standard				4	G	8	1
BMW	3-series	1990 to 1991	34-034	Standard				4	A,B	8	1
	5-series	1990 to 1991	34-035	Standard				4	H	8	1
	6-series	1990 to 1991	34-036	Standard				4	E	8	1
	7-series	1990 to 1991	34-037	Standard				4	G	8	1
	850	1991	34-038	Standard				4	???	8	1
Buick	LeSabre	1974 to 1975	18-002		Option			2	N,P		
	LeSabre	1976	18-002		Option			2	P		
	Electra	1974	18-003		Option			2	T,V,X		
	Electra	1975 to 1976	18-003		Option			2	V,X		
	Riviera	1974	18-005		Option			2	Y		
	Riviera	1975 to 1976	18-005		Option			2	Z		
Buick	Century	1990	18-007				Yes	4-5	AH,AL	7	4
	Electra	1990	18-003				Yes	4-5	BV or C-	7	4
	LeSabre	1990	18-002				Yes	4-5	HP,HR,BR	7	4
	Park Avenue	1991	18-003	Standard				4-5	???	7	3
	Reatta	1990 to 1991	18-021	Standard				4-5	EC	7	3
	Regal	1990	18-020				Yes	4-5	WB,WD	7	4
	Riviera	1990 to 1991	18-005	Standard				4-5	EZ	7	3
	Roadmaster	1991	18-004	Standard				4-5	???	7	3
	Skylark	1990	18-018				Yes	4-5	N-	7	4
	Cadillac	DeVille	1974 to 1976	19-003		Option			2	D	
Eldorado		1974 to 1976	19-005		Option			2	L		
Cadillac	Allante	1990 to 1991	19-009	Standard				4-5	VR,VS	7	3
	DeVille	1990 to 1991	19-003	Standard				4-5	CD	7	3
	Eldorado	1990 to 1991	19-005	Standard				4-5	EL	7	3
	DeV Fleetwood	1990 to 1991	19-003	Standard				4-5	CB,CS	7	3
	DeV Fleetwood										
	Brougham-RWD	1990	19-003				Yes	4-5	DW	7	4
Seville	1990 to 1991	19-014	Standard				4-5	KS,KY	7	3	
Chevrolet	Impala	1973	20-002		Option			2	L		

10th Character = Year: A=1980, B=1981, C=1982, D=1983, E=1984, F=1985, G=1986, H=1987, J=1988, K=1989, L=1990, M=1991, N=1992

Automatic (Passive) Restraint System Availability [cont'd.]

Vehicle Make GV05	Vehicle Model GV06	Vehicle Model Year GV04	NASS Make/Model Code: GV05- GV06	Air Bag		Passive Belt		VIN Character Identifier			
				Driver Only	Driver & Passenger	Motorized	Non-Motorized	Model		Restraint	
								Place	Code	Place	Code
Chevrolet	Camaro	1990 to 1991	20-009	Standard			Yes	4-5	FP	7	3
	Caprice	1990	20-002					4-5	BL,BN,BU	7	4
	Cavalier	1990	20-016					4-5	JC,JF	7	4
	Celebrity	1990	20-017					4-5	AW	7	4
	Corsica/ Beretta	1990	20-019					4-5	L-	7	4
	Corvette	1990 to 1991	20-004	Standard			Yes	4-5	YY,YZ	7	3
	Geo Metro Hdtop	1990	20-034					4-5	MR,MS,MT	7	4
	Geo Metro Conv	1990 to 1991	20-034	Standard		Yes		4-5	MR,MS	7	3
	Geo Prizm	1990	20-032					4-5	SK,SL	7	4
	Geo Storm	1990 to 1991	20-035	Standard				4-5	RF,RT	7	3
Chevrolet	Caprice	1991	20-002	Standard			Yes	4-5	BL,BN,BU	7	3
	Corsica/ Beretta	1991	20-019	Standard				4-5	L-	7	3
		1991									
Chrysler	New Yorker-RWD	1988	06-010	Option*				5	F	4	X,Y
	Lebaron	1988	06-017	Option*				5	J	4	X,Y
	Lebaron GTS	1988	06-017	Option*				5	H	4	X,Y
Chrysler	New Yorker-RWD	1989	06-010	Standard				5	M	4	X,Y
	Lebaron	1989	06-017	Standard				5	J	4	X,Y
	Lebaron GTS	1989	06-017	Standard				5	H	4	X,Y
Chrysler	Lebaron	1990 to 1991	06-017	Standard				5	A,J	4	X,Y
	New Yorker-FWD	1990 to 1991	06-010	Standard				5	Y	4	X,Y
	Imperial	1990 to 1991	06-010	Standard				5	Y	4	X,Y
	New Yorker-FWD	1990 to 1991	06-010	Standard				5	Y	4	X,Y
	New Yorker-FWD Salon, Landau TC	1990 to 1991	06-014	Standard				5	C	4	X,Y
		1990 to 1991	06-031	Standard				6	1	7	4
Daihatsu	Charade-hatchbk	1990	60-031			Yes		?	?	?	?
	Charade-sedan	1990	60-031				Yes	?	?	?	?
Dodge	Diplomat	1988	07-007	Option*				5	G	4	X,Y
	Daytona	1988	07-015	Option*				5	A	4	X,Y
Dodge	Diplomat	1989	07-007	Standard				5	M	4	X,Y
	Daytona	1989	07-015	Standard				5	G	4	X,Y
Dodge	Colt	1990	07-034			Yes		5	U	4	C
	Daytona	1990 to 1991	07-015	Standard				5	G	4	X,Y
	Dynasty	1990 to 1991	07-018	Standard				5	C	4	X,Y
	Monaco	1990	07-040			Yes		5	B	4	C
	Omni	1990	07-008	Standard				5	L	4	X,Y
	Shadow	1990 to 1991	07-017	Standard				5	P	4	X,Y
	Spirit	1990 to 1991	07-019	Standard				5	A	4	X,Y
	Stealth	1991	07-039	Standard				5	???	4	X,Y
Eagle	Premier	1990	10-040			Yes		5	B	4	C
	Summit	1990	10-034			Yes		5	U	4	C
	Talon	1990	10-037			Yes		5	S	4	C

* Air bag became standard equipment in mid-year.

10th Character = Year: A=1980, B=1981, C=1982, D=1983, E=1984, F=1985, G=1986, H=1987, J=1988, K=1989, L=1990, M=1991, N=1992

Automatic (Passive) Restraint System Availability [cont'd.]

Vehicle Make	Vehicle Model	Vehicle Model Year	NASS Make/Model Code: GV05- GV06	Air Bag		Passive Belt		VIN Character Identifier			
				Driver Only	Driver & Passenger	Motorized	Non-Motorized	Model		Restraint	
								Place	Code	Place	Code
GV05	GV06	GV04									
Ford	Escort	1988	12-013			Yes		6-7	88-98	4	P
		1989	12-013			Yes		6-7	90-98	4	P
	Festiva	1988	12-033			Yes		6-7	06-13	4	P
		1989	12-033			Yes		6-7	06,07	4	P
	Tempo	1985 to 1986	12-015	Option				6-7	18-23	4	C
		1987 to 1989	12-015	Option				6-7	30-39	4	C
Ford	LTD/Crown Victoria	1990 to 1991	12-016	Standard				6-7	72-79	4	C
	Escort	1990	12-013			Yes		6-7	10-15, & 90-98	4	P
	Festiva	1990	12-033			Yes		6-7	05-07	4	P
	Mustang	1990 to 1991	12-003	Standard				6-7	40-45	4	C
	Probe	1990	12-018			Yes		6-7	20-22	4	P
	Taurus	1990 to 1991	12-017	Standard				6-7	50-58	4	C
	Tempo	1990 to 1991	12-015	Option			Yes		6-7	30-39	4
	Thunderbird	1990	12-004			Yes		6-7	60-64	4	P
Honda	Accord	1987-1988	37-032			Yes		4-6	CA5	8	8
	Accord	1989	37-032			Yes		4-6	CA5,CA6	8	8
	Accord	1990	37-032			Yes		4-6	CA6,CB7	8	4,5,6
	Accord wagon	1991	37-032	Standard				4-6	???	8	???
	Civic sedan	1990	37-031			Yes		4-6	ED3,ED4	8	4,5,6
	Civic wagon	1990	37-031			Yes		4-6	EE2,4,EY3	8	5
	Civic hatchback	1990	37-031				Yes	4-6	ED6,ED7	8	4,5
	CRX	1989-1990	37-031				Yes	4-6	ED8,ED9	8	5,6
	Prelude	1988-1989	37-033				Yes	4-6	BA4	8	2,3,4
	Prelude	1990	37-033				Yes	4-6	BA4	8	1,2,3
Hyundai	Excel	1987-1989	55-032			Yes		4	L	7	2
	Excel	1990	55-032			Yes		4	V	7	2
	Sonata	1989-1990	55-033			Yes		4	B	7	2
	Scoupe	1991	55-034			Yes		4	???	7	2
Infiniti (Nissan)	Q30	1990 to 1991	58-031	Standard				5	F	8	C
	Q45	1990 to 1991	58-032	Standard				5	G	8	C
	G20	1991	58-033			??Yes??	??Yes??	5	???	8	???
Isuzu	Impulse	1988-1989	38-032			Yes		4-5	BR	4	B
	Impulse	1988-1989	38-032	Option				4-5	CR	4	C
	I-Mark	1989	38-031			Yes		4-5	RT	7	4
	Impulse	1990 to 1991	38-032	Standard				4-5	RT	7	3
	Stylus	1990 to 1991	38-033	Standard				4-5	RT	7	3
Jaguar	XJ6	1990	39-032			Yes		4	F	5	Y
	XJ-S	1990 to 1991	39-031	Standard				4	N,T	5	W
Lexus (Toyota)	ES-250	1990 to 1991	59-031	Standard				4-5	V2	8	E,T
	LS-400	1990 to 1991	59-032	Standard				4-5	F1	8	E,T

10th Character = Year: A=1980, B=1981, C=1982, D=1983, E=1984, F=1985, G=1986, H=1987, J=1988, K=1989, L=1990, M=1991, N=1992

OCCUPANT ASSESSMENT FORM

Automatic (Passive) Restraint System Availability [cont'd.]

Vehicle Make	Vehicle Model	Vehicle Model Year	NASS Make/Mode Code: GV05-GV06	Air Bag		Passive Belt		VIN Character Identifier			
				Driver Only	Driver & Passenger	Motorized	Non-Motorized	Model		Restraint	
								Place	Code	Place	Code
Lincoln	Continental Continental Continental Mark VII Town Car	1988	13-005		Standard			6-7	97,98	4	C
		1989	13-005		Standard			6-7	97,98	4	L
		1990	13-005		Standard			6-7	97,98	4	C,L
		1990	13-002	Standard	Standard ⁺			6-7	92,93	4	C
		1990	13-001		Standard ⁺			6-7	81-83	4	C,L
Lincoln	Continental Mark VII Town Car	1991	13-005	Standard	Option ⁺			6-7	97,98	4	C,L
		1991	13-002	Standard				6-7	92,93	4	C
		1991	13-001	Standard	Option ⁺			6-7	81-83	4	C,L
Maserati	228,430, Spyder	1990	69-040			Yes		4	A-H	7	2
Mazda	323	1990	41-035			Yes		4-5	BG,22	8	No
	626	1990	41-037			Yes		4-5	GD	8	
	929	1990	41-043			Yes		4-5	HC	8	Discernible
	Miata	1990 to 1991	41-045	Standard				4-5	NA	8	
	MX-6	1990	41-044			Yes		4-5	GD	8	
	RX-7 hardtop RX-7 convertible	1990 to 1991	41-034 41-034	Standard		Yes		4-5 4-5	FC FC	8 8	Pattern
Mercedes Benz	500 SEC	1984	42-036	Option				4-7	CA44	8	B
	500 SEL	1984	42-036	Option				4-7	CA37	8	B
	300 SD	1984	42-037	Option				4-7	CB20	8	B
	380 SE	1984	42-037	Option				4-7	CA32	8	B
	190E	1984	42-039	Option				4-7	DA24	8	B
	190D	1984	42-039	Option				4-7	DB22	8	E
Mercedes Benz	500 SEC	1985	42-036	Option				4-7	CA44	8	B,D
	500 SEL	1985	42-036	Option				4-7	CA37	8	B,D
	300 SD	1985	42-037	Option				4-7	CB20	8	B,D
	380 SE	1985	42-037	Option				4-7	CA32	8	B,D
	190E	1985	42-039	Option				4-7	DA24	8	B,D
	190D	1985	42-039	Option				4-7	DB22	8	B,D
Mercedes Benz	190E - 2.3	1986 to 1988	42-039	Standard				4-7	DA28	8	D
	190E - 2.3-16	1986 to 1987	42-039	Standard				4-7	DA34	8	D
	190E - 2.6	1986 to 1989	42-039	Standard				4-7	DA29	8	D
	190D - 2.5	1986 to 1989	42-039	Standard				4-7	DB26	8	D
	190D - 2.5 T	1987	42-039	Standard				4-7	DB28	8	D
	260E	1987 to 1989	42-031	Standard				4-7	EA26	8	D
	300CE	1988 to 1989	42-031	Standard				4-7	EA50	8	D
	300DT	1987	42-035	Standard				4-7	EB33	8	D
	300E	1986 to 1989	42-031	Standard				4-7	EA30	8	D
	300SDL	1987	42-037	Standard				4-7	CB25	8	D
	300SE	1989	42-037	Standard				4-7	CA24	8	D
	300SEL	1988 to 1989	42-035	Standard				4-7	CA25	8	D
	300TDT	1987	42-035	Standard				4-7	EB93	8	D
	300TE	1988 to 1989	42-031	Standard				4-7	EA90	8	D
	420SEL	1986 to 1988	42-036	Standard				4-7	CA35	8	D
	560SEC	1986 to 1988	42-036	Standard				4-7	CA45	8	D
	560SEL	1986 to 1988	42-036	Standard				4-7	CA39	8	D
560SL	1986 to 1988	42-036	Standard				4-7	BA48	8	D	

* Due to a production plant fire, Lincoln right-front passenger air bags were not available for many 1990 and 1991 model year vehicles. The passenger air bag is considered an option on 1991 model year vehicles but in actuality is not available until spring of 1991.

10th Character = Year: A=1980, B=1981, C=1982, D=1983, E=1984, F=1985, G=1986, H=1987, J=1988, K=1989, L=1990, M=1991, N=1992

Automatic (Passive) Restraint System Availability [cont'd.]

Vehicle Make	Vehicle Model	Vehicle Model Year	NASS Make/Mode Code: GV05-GV06	Air Bag		Passive Belt		VIN Character Identifier			
				Driver Only	Driver & Passenger	Motorized	Non-Motorized	Model		Restraint	
								Place	Code	Place	Code
GV05	GV06	GV04									
Mercedes Benz ⁺⁺	190E - 2.3	1990 to 1991	42-039	Standard				4-7	DA28	8	D
	190E - 2.6	1990 to 1991	42-039	Standard				4-7	DA29	8	D
	300CE	1990 to 1991	42-031	Standard	Option			4-7	EA51	8	D,E
	300D - 2.5	1990 to 1991	42-031	Standard	Option			4-7	????	8	D,E
	300E	1990 to 1991	42-031	Standard	Option			4-7	EA30	8	D,E
	300E - 2.6	1990 to 1991	42-031	Standard	Option			4-7	EA26	8	D,E
	300E - 4-Matic	1990 to 1991	42-031	Standard	Option			4-7	ED30	8	D,E
	300SE	1990 to 1991	42-037	Standard	Option			4-7	CA24	8	D,E
	300SEL	1990 to 1991	42-035	Standard	Option			4-7	CA25	8	E
	300SL	1990 to 1991	42-033		Standard			4-7	FA61	8	D,E
	300TE	1990 to 1991	42-031		Standard	Option		4-7	EA90	8	D,E
	300TE - 4-Matic	1990 to 1991	42-031		Standard	Option		4-7	ED90	8	D,E
	350SD	1990 to 1991	42-031		Standard	Option		4-7	????	8	D,E
	350SDL	1990 to 1991	42-031		Standard	Option		4-7	????	8	D,E
	420SEL	1990 to 1991	42-036			Standard		4-7	CA35	8	E
	500SL	1990 to 1991	42-033			Standard		4-7	FA66	8	E
	560SEC	1990 to 1991	42-036			Standard		4-7	CA45	8	E
560SEL	1990 to 1991	42-036			Standard		4-7	CA39	8	E	
Mercury	Topaz	1985 to 1986	14-015	Option				6	71-76	4	C
		1987 to 1989	14-015	Option				6	30-38	4	C
Mercury	Capri	1991	14-031	Standard				6-7	01-03	4	C
	Cougar	1990	14-004			Yes		6-7	60,62	4	P
	Grand Marquis	1990 to 1991	14-006	Standard				6-7	74-79	4	C
	Sable	1990 to 1991	14-017	Standard				6-7	50-58	4	C
	Topaz	1990 to 1991	14-015	Option		Yes		6-7	30-38	4	C,P
	Tracer	1991	14-036			Yes		6-7	10-15	4	P
Mitsubishi	Eclipse	1990	52-037			Yes		5	S,T	4	C
	Galant	1990	52-034			Yes		5	R,X	4	C
	Mirage	1990	52-035			Yes		5	U,V	4	C
	Precis	1990	52-036				Yes	3	H	4	V
	Sigma	1990	52-038	Standard				5	B	4	X
	3000 GT	1991	52-039	Standard				5	???	4	X
Nissan	240SX	1990	35-032				Yes	5	S	8	A
	300ZX	1990	35-034				Yes	5	Z	8	A
	Axxess	1990	35-480			Yes		5	M	8	P,J
	Maxime	1990	35-039			Yes		5	J	8	P
	Pulsar	1990	35-044	Option			Yes	5	N	8	A,C
	Sentra	1990	35-043				Yes	5	B	8	A
	Stanza	1990	35-042			Yes		5	U	8	P
Nissan	300ZX	1991	35-034	Option			Yes	5	Z	8	A,C
	NX Coupe	1991	35-044	Standard				5	???	8	C
Oldsmobile	Delta 88	1974 to 1976	21-002		Option			2	L,N		
	Ninety-Eight	1974	21-003		Option			2	T,V,X		
	Ninety-Eight	1975 to 1976	21-003		Option			2	V,X		
	Toronado	1974	21-005		Option			2	U,W,Y		
	Toronado	1975 to 1976	21-005		Option			2	U,W,Y,Z		
Oldsmobile	Delta 88 Royale	1988 to 1989	21-002	Option				4-5	HN,HY	7	3

⁺⁺ Mercedes Benz offers: (1) only a standard driver side air bag in the 190 class vehicles, (2) standard driver and passenger air bags for their models equipped with a V8 or a roadster (i.e., SL), and (3) standard driver and optional passenger air bags for models equipped with 6-cylinder engines (excluding the roadsters).

10th Character = Year: A=1980, B=1981, C=1982, D=1983, E=1984, F=1985, G=1986, H=1987, J=1988, K=1989, L=1990, M=1991, N=1992

Automatic (Passive) Restraint System Availability [cont'd.]

Vehicle Make	Vehicle Model	Vehicle Model Year	NASS Make/Mode Code: GV05-GV06	Air Bag		Passive Belt		VIN Character Identifier			
				Driver Only	Driver & Passenger	Motorized	Non-Motorized	Model		Restraint	
								Place	Code	Place	Code
Oldsmobile	Custom Cruiser	1990	21-002				Yes	4-5	BP	7	4
	Cutlass Calais	1990	21-018				Yes	4-5	W-	7	4
	Cutlass Ciera	1990	21-017				Yes	4-5	AJ,AM,AS	7	4
	Cutlass Supreme	1990	21-020				Yes	4-5	W-	7	4
	Delta 88 Royale	1990 to 1991	21-002	Option			Yes	4-5	HN, HY	7	3,4
	98 Regency	1990	21-003	Option			Yes	4-5	CJ, CX	7	3,4
	98 Touring sedn	1990	21-003				Yes	4-5	CV	7	4
	Toronado	1990	21-005				Yes	4-5	EV, EZ	7	4
Oldsmobile	Custom Cruiser	1991	21-002	Standard				4-5	BP	7	3
	98 Regency	1991	21-003	Standard				4-5	CJ, CX	7	3
	98 Touring sedn	1991	21-003	Standard				4-5	CV	7	3
	Toronado	1991	21-005	Standard				4-5	EV, EZ	7	3
Peugeot	405	1990	44-036			Yes		4	D, E	7	3
	505	1990	44-034				Yes	4	B, C	7	2
Plymouth	Gran Fury	1988	09-004	Option*				5	B	4	X, Y
Plymouth	Gran Fury	1989	09-004	Standard				5	B	4	X, Y
Plymouth	Acclaim	1990 to 1991	09-019	Standard				5	A	4	X, Y
	Colt	1990	09-034			Yes		5	U	4	C
	Horizon	1990	09-008	Standard		Yes		5	L	4	X, Y
	Laser	1990	09-037			Yes		5	S	4	C
	Sundance	1990 to 1991	09-017	Standard				5	P	4	X, Y
Pontiac	6000	1990	22-017				Yes	4-5	AF, AJ	7	4
	Bonneville	1990	22-002				Yes	4-5	H-, B-	7	4
	Firebird	1990 to 1991	22-009	Standard				4-5	FS, FW	7	3
	Grand Am	1990	22-018				Yes	4-5	NE, NW	7	4
	Grand Prix	1990	22-020			Yes	Yes	4-5	WJ, WP, WT	7	4
	LeMans	1990	22-031			Yes		4-5	T-	7	4
	Sunbird	1990	22-016				Yes	4-5	JB, JD, JU	7	4
Porsche	944	1987	45-037		Option			7-8	94	6	2
	944 S	1987	45-037		Option			7-8	94	6	2
	944 Turbo	1987	45-037		Standard			7-8	95	6	2
Porsche	944	1988 to 1989	45-037		Option			7-8	94	6	2
	944 S	1988 to 1989	45-037		Standard			7-8	94	6	2
	944 Turbo	1988 to 1989	45-037		Standard			7-8	95	6	2
Porsche	911 series	1990 to 1991	45-031		Standard			7-8	91, 93	6	2
	928	1990 to 1991	45-035		Standard			7-8	92	6	2
	944 series	1990 to 1991	45-037		Standard			7-8	94, 95	6	2
Saab	900 Turbo	1988 to 1989	47-034	Option				4	C	5	L
	900 series	1990 to 1991	47-031	Standard				4	A	5	J, K, L
	9000 series	1990 to 1991	47-034	Standard				4	C	5	J, K, L
Saturn	SL	1991	24-001			Yes		4-5	???	7	4
	SC	1991	24-002			Yes		4-5	???	7	4
Sterling	825/827	1990	69-055			Yes		6	4, 8	7	3

* Air bag became standard equipment in mid-year.

10th Character = Year: A=1980, B=1981, C=1982, D=1983, E=1984, F=1985, G=1986, H=1987, J=1988, K=1989, L=1990, M=1991, N=1992

Automatic (Passive) Restraint System Availability [cont'd.]

Vehicle Make	Vehicle Model	Vehicle Model Year	NASS Make/Model Code: GV05- GV06	Air Bag		Passive Belt		VIN Character Identifier			
				Driver Only	Driver & Passenger	Motorized	Non-Motorized	Model		Restraint	
								Place	Code	Place	Code
Subaru	Justy Legacy Loyale XT, XT6	1990 1990 1990 1990	48-036 48-034 48-031 48-035				Yes	4-5 4-5 4-5 4-5	KA, KD, KG BC, BF, BJ AC, AK, AN AX	8 8 8 8	2 2 2 2
Subaru	Legacy	1991	48-034	Option**		Yes		4-5	BC, BF, BJ	8	2,3
Suzuki	Swift	1990	53-034				Yes	4	A	5	C, D
Toyota	Cressida	1981-1986	49-035			Yes		5	X	8	E
Toyota	Camry Cressida	1987 1987	49-040 49-035			Yes Yes		5 5	V X	8 8	E, H, W E, W
Toyota	Camry Cressida	1988-1989 1988-1989	49-040 49-035			Yes Yes		5 5	V X	8 8	E, J, W E
Toyota	Camry Celica Corolla Cressida MR2 Supra Tercel	1990 1990 to 1991 1990 1990 1991 1990 to 1991 1990	49-040 49-033 49-032 49-035 49-041 49-034 49-038	Standard Standard Standard		Yes Yes	 Yes	5 5 5 5 5 5	V T E X W A L	8 8 8 8 8 8 8	E, J, W F, K, N, P A, B, J, K, M E C, J L, N F, M
Volkswagen	Golf/GTI Rabbit	1985-1989 1981-1984	30-042 30-036				Yes Yes	7-8 7-8	17 17	6 6	9 9
Volkswagen	Cabriolet Corrado Fox Golf/GTI Jetta Passat	1990 to 1991 1990 1990 1990 1990 1990	30-042 30-045 30-044 30-042 30-040 30-046	Standard		Yes	Yes Yes Yes	7-8 7-8 7-8 7-8 7-8	15 50 30 1G 1G 31	6 6 6 6 6 6	5 4 2 1 2 4
Volvo	740 760 780	1987 1987 1987	51-039 51-038 51-038	Option Option* Option*				4 4 4	F G H	5 5 5	A A A
Volvo	740 GLE 740 Turbo 760 780	1988 to 1989 1988 to 1989 1988 to 1989 1988 to 1989	51-039 51-039 51-038 51-038	Option Standard Standard Standard				4 4 4 4	F F G H	5 5 5 5	A A A A
Volvo	240 series 740 series 760 series 780 series	1990 to 1991 1990 to 1991 1990 to 1991 1990 to 1991	51-034 51-039 51-038 51-038	Standard Standard Standard Standard				4 4 4 4	A F G H	5 5 5 5	A A A A
Yugo	GV series	1990	57-031				Yes	5	A-C, E	8	2

* Air bag became standard equipment in mid-year.

** Air bag was offered as an option in mid-year.

10th Character = Year: A=1980, B=1981, C=1982, D=1983, E=1984, F=1985, G=1986, H=1987, J=1988, K=1989, L=1990, M=1991, N=1992



OCCUPANT INJURY FORM

1. Primary Sampling Unit Number _____ 3. Vehicle Number _____
 2. Case Number – Stratum _____ 4. Occupant Number _____

INJURY DATA

Record below the actual injuries sustained by this occupant that were identified from the official and unofficial data sources. Remember not to double count an injury just because it was identified from two different sources. If greater than ten injuries have been documented, encode the balance on the Occupant Injury Supplement.

	Source of Injury Data	O I C – A I S					Injury Source	Injury Source Confidence Level	Direct/ Indirect Injury	Occupant Area Intrusion No
		Body Region	Aspect	Lesion	System Organ	A I S Severity				
1st	5. ___	6. ___	7. ___	8. ___	9. ___	10. ___	11. ___	12. ___	13. ___	14. ___
2nd	15. ___	16. ___	17. ___	18. ___	19. ___	20. ___	21. ___	22. ___	23. ___	24. ___
3rd	25. ___	26. ___	27. ___	28. ___	29. ___	30. ___	31. ___	32. ___	33. ___	34. ___
4th	35. ___	36. ___	37. ___	38. ___	39. ___	40. ___	41. ___	42. ___	43. ___	44. ___
5th	45. ___	46. ___	47. ___	48. ___	49. ___	50. ___	51. ___	52. ___	53. ___	54. ___
6th	55. ___	56. ___	57. ___	58. ___	59. ___	60. ___	61. ___	62. ___	63. ___	64. ___
7th	65. ___	66. ___	67. ___	68. ___	69. ___	70. ___	71. ___	72. ___	73. ___	74. ___
8th	75. ___	76. ___	77. ___	78. ___	79. ___	80. ___	81. ___	82. ___	83. ___	84. ___
9th	85. ___	86. ___	87. ___	88. ___	89. ___	90. ___	91. ___	92. ___	93. ___	94. ___
10th	95. ___	96. ___	97. ___	98. ___	99. ___	100. ___	101. ___	102. ___	103. ___	104. ___

OCCUPANT INJURY DATA

	Source of Injury Data	O.I.C — A.I.S.					Injury Source	Injury Source Confidence Level	Direct/ Indirect Injury	Occupant Area Intrusion No
		Body Region	Aspect	Lesion	System Organ	A I.S Severity				
11th	—	—	—	—	—	—	—	—	—	
12th	—	—	—	—	—	—	—	—	—	
13th	—	—	—	—	—	—	—	—	—	
14th	—	—	—	—	—	—	—	—	—	
15th	—	—	—	—	—	—	—	—	—	
16th	—	—	—	—	—	—	—	—	—	
17th	—	—	—	—	—	—	—	—	—	
18th	—	—	—	—	—	—	—	—	—	
19th	—	—	—	—	—	—	—	—	—	
20th	—	—	—	—	—	—	—	—	—	
21st	—	—	—	—	—	—	—	—	—	
22nd	—	—	—	—	—	—	—	—	—	
23rd	—	—	—	—	—	—	—	—	—	

OFFICIAL INJURY DATA – SOFT TISSUE INJURIES

Indicate the Location, Lesion, Detail (size, depth, fracture type, head injury clinical signs and neurological deficits), and Source of all injuries indicated by official sources (or from PAR or other unofficial sources if medical records and interviewee data are unavailable.)

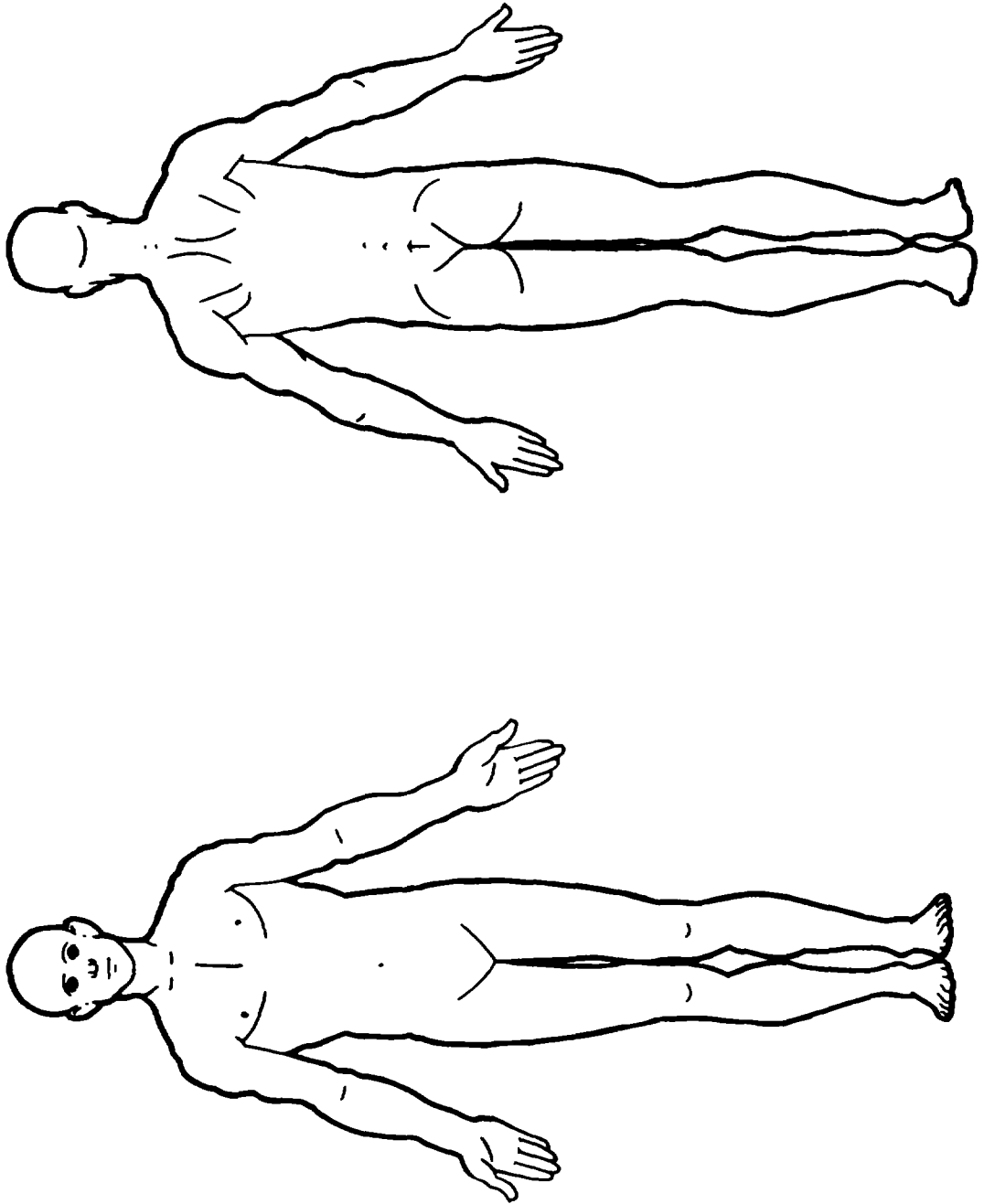

SOURCE OF INJURY DATA

OFFICIAL

- (1) Autopsy records with or without hospital medical records
- (2) Hospital medical records other than emergency room (eg. discharge summary)
- (3) Emergency room records only (including associated X-rays or other lab reports)
- (4) Private physician, walk in or emergency clinic

UNOFFICIAL

- (5) Lay coroner report
- (6) E M S personnel
- (7) Interviewee
- (8) Other source (specify)
- (9) Police

INJURY SOURCE

FRONT

- (01) Windshield
- (02) Mirror
- (03) Sunvisor
- (04) Steering wheel rim
- (05) Steering wheel hub/spoke
- (06) Steering wheel (combination of codes 04 and 05)
- (07) Steering column transmission selector lever other attachment
- (08) Add-on equipment (e.g., CB tape deck, air conditioner)
- (09) Left instrument panel and below
- (10) Center instrument panel and below
- (11) Right instrument panel and below
- (12) Glove compartment door
- (13) Knee bolster
- (14) Windshield including one or more of the following front header, A-pillar, instrument panel, mirror or steering assembly (driver side only)
- (15) Windshield including one or more of the following front header, A-pillar, instrument panel or mirror (passenger side only)
- (16) Other front object (specify)

LEFT SIDE

- (20) Left side interior surface excluding hardware or armrests
- (21) Left side hardware or armrest
- (22) Left A pillar
- (23) Left B pillar
- (24) Other left pillar (specify)
- (25) Left side window glass or frame

(26) Left side window glass including one or more of the following frame, window sill, A-pillar, B-pillar or roof side rail

(27) Other left side object (specify)

RIGHT SIDE

- (30) Right side interior surface excluding hardware or armrests
- (31) Right side hardware or armrest
- (32) Right A pillar
- (33) Right B pillar
- (34) Other right pillar (specify)
- (35) Right side window glass or frame
- (36) Right side window glass including one or more of the following frame, window sill, A-pillar, B-pillar, roof side rail
- (37) Other right side object (specify)

INTERIOR

- (40) Seat, back support
- (41) Belt restraint webbing buckle
- (42) Belt restraint B pillar attachment point
- (43) Other restraint system component (specify)
- (44) Head restraint system
- (45) Air bag
- (46) Other occupants (specify)
- (47) Interior loose objects
- (48) Child safety seat (specify)
- (49) Other interior object (specify)

ROOF

- (50) Front header
- (51) Rear header
- (52) Roof left side rail
- (53) Roof right side rail
- (54) Roof or convertible top

FLOOR

- (56) Floor including toe pan
- (57) Floor or console mounted transmission lever including console
- (58) Parking brake handle
- (59) Foot controls including parking brake

REAR

- (60) Backlight (rear window)
- (61) Backlight storage rack, door, etc
- (62) Other rear object (specify)

EXTERIOR OF OCCUPANT'S VEHICLE

- (65) Hood
- (66) Outside hardware (e.g., outside mirror, antenna)
- (67) Other exterior surface or tires (specify)
- (68) Unknown exterior objects

EXTERIOR OF OTHER MOTOR VEHICLE

- (70) Front bumper
- (71) Hood edge
- (72) Other front of vehicle (specify)
- (73) Hood
- (74) Hood ornament
- (75) Windshield roof rail, A-pillar
- (76) Side surface
- (77) Side mirrors
- (78) Other side protrusions (specify)
- (79) Rear surface
- (80) Undercarriage
- (81) Tires and wheels
- (82) Other exterior of other motor vehicle (specify)

(83) Unknown exterior of other motor vehicle

OTHER VEHICLE OR OBJECT IN THE ENVIRONMENT

- (84) Ground
- (85) Other vehicle or object (specify)
- (86) Unknown vehicle or object

NONCONTACT INJURY

- (90) Fire in vehicle
- (91) Flying glass
- (92) Other noncontact injury source (specify)
- (97) Injured unknown source

INJURY SOURCE CONFIDENCE LEVEL

- (1) Certain
- (2) Probable
- (3) Possible
- (9) Unknown

DIRECT/INDIRECT INJURY

- (1) Direct contact injury
- (2) Indirect contact injury
- (3) Noncontact injury
- (7) Injured unknown source

OCCUPANT INJURY CLASSIFICATION

O I C Body Region

- (M) Abdomen
- (Q) Ankle-foot
- (A) Arm (upper)
- (B) Back-thoracolumbar spine
- (C) Chest
- (E) Elbow
- (F) Face
- (R) Forearm
- (H) Head-skull
- (U) Injured unknown region
- (K) Knee
- (L) Leg (lower)
- (Y) Lower limb(s) (whole or unknown part)
- (N) Neck-cervical spine
- (P) Pelvic-hip
- (S) Shoulder
- (T) Thigh
- (X) Upper limb(s) (whole or unknown part)
- (O) Whole body

(W) Wrist-hand

Aspect of Injury

- (A) Anterior-front
- (B) Bilateral (rib fracture only)
- (C) Central
- (I) Inferior-lower
- (U) Injured, unknown aspect
- (L) Left
- (P) Posterior-back
- (R) Right
- (S) Superior-upper
- (W) Whole region

Lesion

- (A) Abrasion
- (M) Amputation
- (V) Avulsion
- (B) Burn
- (K) Concussion
- (C) Contusion
- (N) Crush

(G) Detachment separation

- (D) Dislocation
- (F) Fracture
- (Z) Fracture and dislocation
- (U) Injured unknown lesion
- (L) Laceration
- (O) Other
- (P) Perforation puncture
- (R) Rupture
- (S) Sprain
- (T) Strain
- (E) Total severance transection

System/Organ

- (W) All systems in region
- (A) Arteries-veins
- (B) Brain
- (D) Digestive
- (E) Ears
- (O) Eye
- (H) Heart
- (U) Injured unknown system

(I) Integumentary

- (J) Joints
- (K) Kidneys
- (L) Liver
- (M) Muscles
- (N) Nervous system
- (P) Pulmonary-lungs
- (R) Respiratory
- (S) Skeletal
- (C) Spinal cord
- (Q) Spleen
- (T) Thyroid other endocrine gland
- (G) Urogenital
- (V) Vertebrae

Abbreviated Injury Scale

- (1) Minor injury
- (2) Moderate injury
- (3) Serious injury
- (4) Severe injury
- (5) Critical injury
- (6) Maximum (untreatable)
- (7) Injured unknown severity

OFFICIAL INJURY DATA – SKELETAL INJURIES

Indicate the Location, Lesion, Detail (size, depth, fracture type, head injury clinical signs and neurological deficits), and Source of all injuries indicated by official sources (or from PAR or other unofficial sources if medical records and interviewee data are unavailable.)

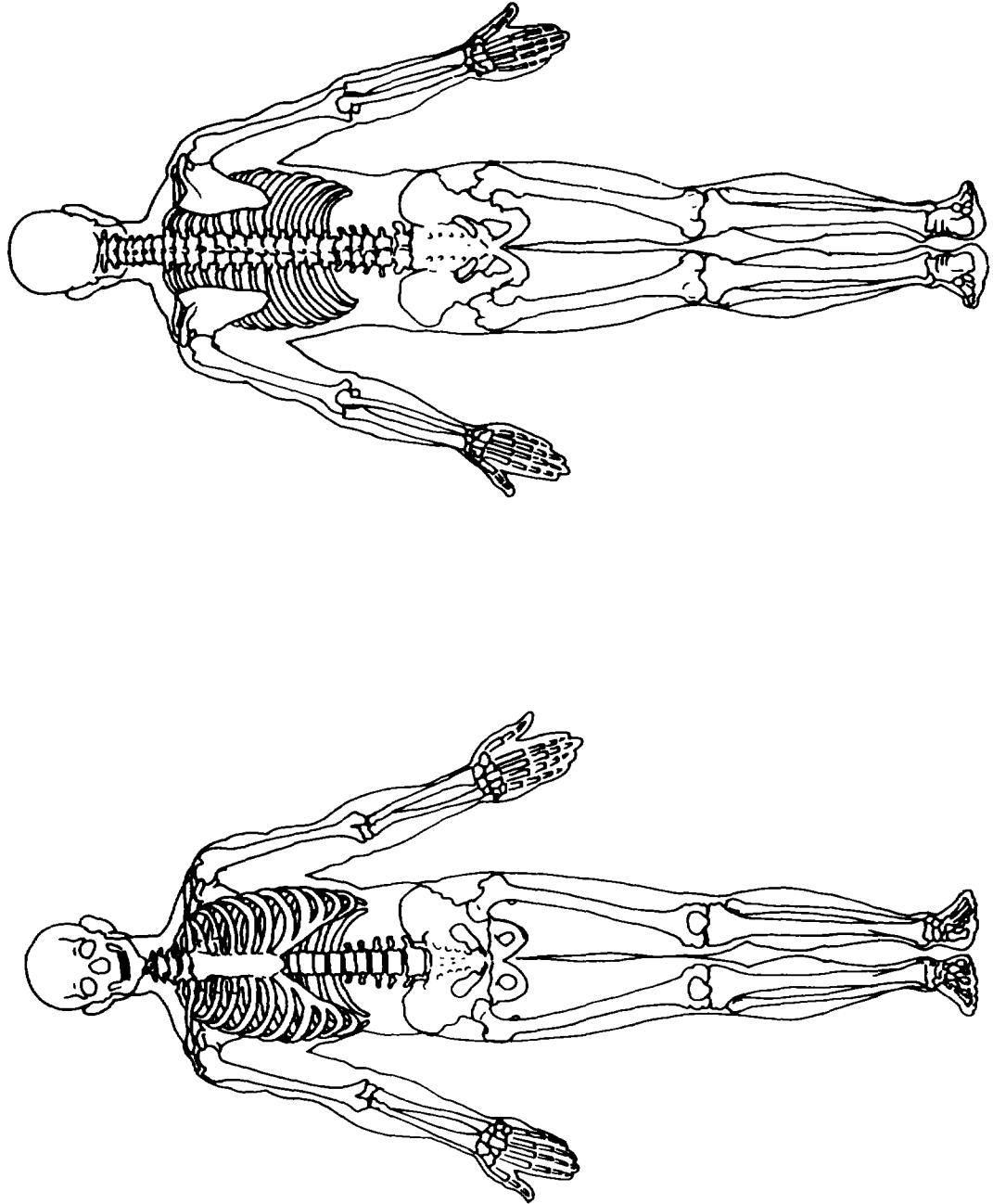

OFFICIAL INJURY DATA – INTERNAL INJURIES

Indicate the *Location, Lesion, Detail* (size, depth, fracture type, head injury clinical signs and neurological deficits), and *Source* of all injuries indicated by official sources (or from PAR or other unofficial sources if medical records and interviewee data are unavailable.)

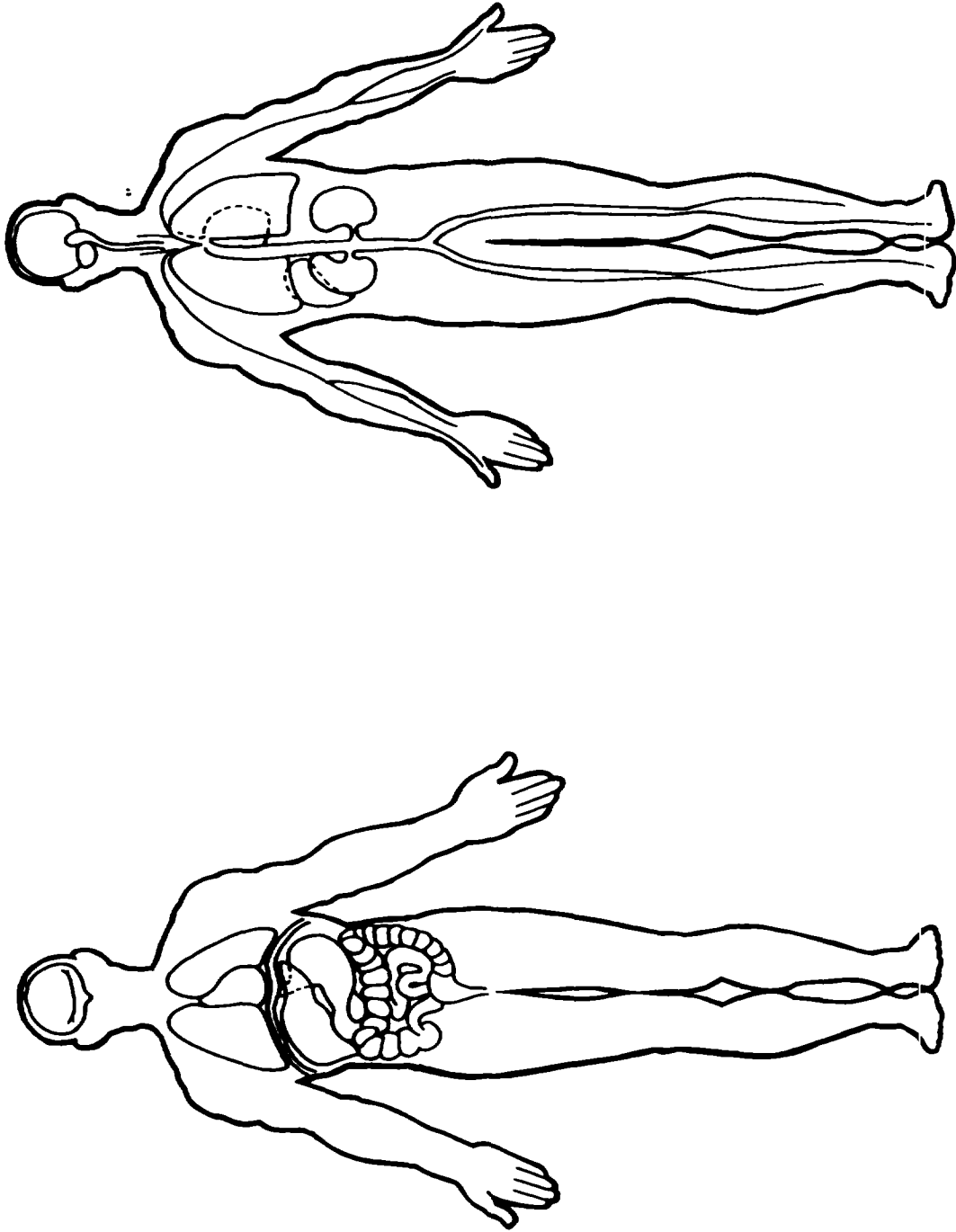

OCCUPANT INJURY LOG

Performance Assessment

TO BE COMPLETED BY TEAM		AIS 1-7	AIS 3-6							
1. PSU Number _____		_____	_____							
2. Case Number - Stratum _____		_____	_____							
3. Researcher Completing Form _____		_____	_____							
4. Vehicle Number _____		_____	_____							
5. Occupant Number _____		_____	_____							
6. Interviewer Number _____		_____	_____							
TO BE COMPLETED BY ZONE CENTER		DATA STATUS FOR INJURY VARIABLES								
7. Assessment Of Complexity Of Medical Data - Interview (1) No data obtained (2) Routine (3) Difficult _____	Coding Errors (total number in each column)									
	5	6	7	8	9	10	11	12	13	14
	<input type="text"/>	<input type="text"/>	<input type="text"/>	<input type="text"/>	<input type="text"/>	<input type="text"/>	<input type="text"/>	<input type="text"/>	<input type="text"/>	<input type="text"/>
8. Documentation Of Unofficial Data On Manikin/Listing (0) Not applicable (1) Substandard (2) Standard (3) Above standard _____	MDE Errors (total number in each column)									
	5	6	7	8	9	10	11	12	13	14
	<input type="text"/>	<input type="text"/>	<input type="text"/>	<input type="text"/>	<input type="text"/>	<input type="text"/>	<input type="text"/>	<input type="text"/>	<input type="text"/>	<input type="text"/>
9. Assessment Of Complexity Of Medical Data - Official Sources (1) No data obtained (2) Routine (3) Difficult _____	Unknowns (total number in each column)									
	5	6	7	8	9	10	11	12	13	14
	<input type="text"/>	<input type="text"/>	<input type="text"/>	<input type="text"/>	<input type="text"/>	<input type="text"/>	<input type="text"/>	<input type="text"/>	<input type="text"/>	<input type="text"/>
10. Documentation Of Official Data On Manikin (0) Not applicable (1) Substandard (2) Standard (3) Above standard _____										
	5	6	7	8	9	10	11	12	13	14
	<input type="text"/>	<input type="text"/>	<input type="text"/>	<input type="text"/>	<input type="text"/>	<input type="text"/>	<input type="text"/>	<input type="text"/>	<input type="text"/>	<input type="text"/>
11. Primary OIC Error Area (0) No errors (1) Head or neck (2) Face (3) Chest (4) Abdominal or pelvic contents (5) Extremities or pelvic girdle (6) General (external) _____										
	5	6	7	8	9	10	11	12	13	14
	<input type="text"/>	<input type="text"/>	<input type="text"/>	<input type="text"/>	<input type="text"/>	<input type="text"/>	<input type="text"/>	<input type="text"/>	<input type="text"/>	<input type="text"/>
16. Date Update Received _____ / _____ / _____										
17. Date Update Reviewed _____ / _____ / _____										
18. Reviewed By (Initials) _____										
19. Date MDE'ed _____ / _____ / _____										
20. MDE'ed By (Initials) _____										

INJURY DATA OVERVIEW

The Occupant Injury Form is a complete coded reduction of all injuries sustained by each injured occupant of a CDS applicable vehicle. The injuries are reported using a series of codes for a description of the injury, its severity, and associated information. The associated information includes the source of the injury data, the source of the injury, the confidence the researcher has in assigning that particular injury source, the directness of the injury as a result of a remotely applied force, and the relatedness of the injury to a vehicle intrusion. These data are grouped by columns and titles as seen on the form. The variable numbers are consecutive, and there is no theoretical upper limit to the number of injuries that can be coded.

Historically, injury information has provided a measure of the severity of the accident from the occupant's frame of reference. The CDS has adopted a combination of the Occupant Injury Classification, which describes the injury location and type with a four place alphabetic code, and the Abbreviated Injury Scale severity, which indicates the severity of the injury by a single digit numeric code. The AIS is assigned based on a number of factors such as survivability of the injury, long term disability, and complications from the injury. This provides a complete coded description of the injury in an analyzable format that is widely accepted and can be compared against other injury assessment studies. In the past, injury information by itself was often used as a measurement scale but still was incomplete in that the mechanism causing the injury was unknown. To rectify this situation, variables were added to report the object which caused the injury and whether or not the injury was caused by direct contact with the object. Since the codes for these variables are based at times on less than concrete evidence, it was necessary to evaluate the reliability of the data by adding a variable for confidence level.

Accuracy of injury data has long been a concern. In many of the prior accident research studies, injury data were accepted only from a medically qualified source such as a hospital or a physician. Problems in acquiring these data have led to allowing the researcher to obtain injury descriptions from the occupant or selected surrogates. In allowing interviewee medical data, it was necessary to segregate the data by source since interviewee data are known to be less than totally reliable at times. Source of Injury Data (OI05) answers this need.

The addition of these associated variables to the coded injuries (O.I.C. and A.I.S.) has created a data base which can be analyzed for direct evaluation of some of the Federal Motor Vehicle Safety Standards (FMVSS). These standards came into being because of concerns about the injuries sustained in accidents in the early 1960's. Areas such as driver education and training and driver licensing criteria were found to be an inefficient means of reducing accidents on the highways. Accident causation was evaluated for a time but no effective means of reducing the "driver decision" problem was ever uncovered. This left occupant protection and injury reduction as the areas to focus upon. Attention was focused on the vehicle. Hard, unforgiving interior surfaces were removed; steering columns were designed to collapse into the engine compartment rather than impale the driver, and many of the projecting knobs and other surfaces were

INJURY DATA OVERVIEW

rounded, moved, or softened. Vehicles were designed to absorb the impact forces rather than transfer the force to the occupants. Many other improvements in overall vehicle design have taken place to satisfy the requirements specified by the FMVSS. These improvements were implemented by the automakers and are monitored and tested by NHTSA. Much of the monitoring now comes from analyzing data provided by real world experience. All the standards can be evaluated to some extent using data from these variables.

Analysts may use these data to identify the injury severity levels of accidents, search for particular injury sources, determine direct versus indirect injury mechanism ratios, relate percentage of injuries by OIC Body Region, OIC Lesion, and AIS severity level, and compare many other data combinations. These relationships can be determined by using the data from these variables. Comparisons with other variable groups can also be used to explore additional relationships. For example, comparisons of restraint use versus type of injuries (lesions, AIS level) should show a direct correlation between restraint use and injury reduction. If such a correlation is not demonstrated, further exploration into the data and possibly additional detailed analyses are needed. Addition of delta V (GV30) levels to the comparison might show that at some speeds (e.g. very low and very high), the injury levels are the same regardless of restraint use. To continue the analyses, type of injury would be examined in the areas where AIS levels are the same. Also, the number of injuries (OA43) would be a relevant data item for inclusion in the comparison.

All of the above mentioned comparisons and analyses are just a few examples of the uses for the data that are encoded here. For the researcher, these variables, for the most part, represent a distillation of several data sources. The injuries will be coded from information found on the medical records, supplemented by the interviewee descriptions. The Injury Source (OI11 et al.) and Occupant Area Intrusion Number (OI14 et al.) will be obtained from the inspection of the vehicle interior. Injury Source Confidence Level (OI12 et al.) and Direct/Indirect Injury (OI13 et al.) are assessments that are based on the researcher's efforts. A complete, well documented set of injuries is the goal for every case. Much thought and effort will be put into these variables. The researcher must remember that thorough documentation in the vehicle inspection, probing questions in the interview, and an understanding of the occupant's movements during the accident sequence will make the task of completing the Occupant Injury Form much more complete and, in fact, easier.

INJURY DATA OVERVIEW**Official Injury Data
Specific Medical Record Data Used in Coding OIC/AIS**

The injury data from official medical records should be indicated on the appropriate diagram. There are three Official Injury Data diagrams. The first, for soft tissue injuries, is on Page 2 of the Occupant Injury Form. The second, on Page 3, is for skeletal injuries; the third, on the reverse of Page 3, is for injuries to internal organs. Injuries should be clearly and precisely located on the diagrams, and the medical record classification of the injury and its extent should be completely annotated. All data used to code the OIC/AIS of injuries [e.g., size of lacerations, the first observed level of consciousness by a medical authority, loss of consciousness, size of hematoma or hemothorax (in "cc"s of blood), etc.] should be written with the diagram.

INJURY DATA OVERVIEW

NASS Injury Coding Procedures

1. An AIS-6 should be used only for injuries specifically coded AIS-6 in the Abbreviated Injury Scale and not because the victim died. Watch your "5"s
2. Use the following procedure in order to associate contact points and "same type" integumentary lesions/injuries (abrasions, avulsions, contusions, lacerations) for a particular OIC body region. Associate injury source with integumentary lesion
 - a. Code one OIC for "same type" lesions, choosing the highest AIS per type if they are produced by the same or unknown components.
 - b. "Same type" lesions to a body region due to different contact points will be coded as separate injuries. For instance, two facial lacerations caused by two distinct components (e.g., steering wheel and windshield) will have two lines of code.
 - c. When the same lesion occurs to >_ 2 OIC body regions of the upper (A,E,R, or W) or lower (T,K,L, or Q) extremity, code one OIC and AIS (use OIC body region X or Y) if the criterion in "a." is satisfied. For example, contusions of the left upper arm and forearm caused by contact with the side panel will be coded XLCI-1.

NOTE: Code right and left side separately.
3. The researcher should take care not to code the same injury twice simply because information concerning it is available from two different sources. For example, if the interview is used in gathering data, only the injuries not already coded based upon medical records should be coded. Don't double count
4. Definitions and procedures for NASS for coding Injury Source for direct, induced, and noncontact injuries are: Injury Sources

direct injury - an injury to a particular OIC body region caused by the traumatic contact of that OIC body region with a vehicle component or other object. The vehicle component or other object is coded as the injury source for that injury. Brain injuries, anatomic or diffuse, and skull injuries may be caused by the face or head striking a component or object. For these cases, consider the brain or skull injury as a direct injury.

indirect or induced injury - an injury to a particular OIC body region caused by a blow or a traumatic contact in some other OIC body region (e.g., knee/acetabulum). The injury source for an induced injury would be the vehicle component contacted by the other OIC body region (i.e., the occupant contact that initiates the injury mechanism).

Injury source is, therefore, defined as the vehicle component or object that initiated the injury mechanism (induced injury) or directly caused the injury (direct injury).
5. The noncontact injury source codes ("90", "91", and "92") are to be used only for the following specific types of injuries: Noncontact Injury Sources -- "90", "91", and "92"
 - a. head or neck injuries in which the torso is supported (e.g., by seat back or belt) and head or neck experiences traumatic forces due to inertial motion - "92";
 - b. flying glass injuries - "91",
 - c. burns due to chemicals or gaseous inhalation - "92"; and
 - d. burns due to flame - "90".

INJURY DATA OVERVIEW

The following examples should be helpful in illustrating the above definitions.

Injury	Injury Mechanism Determined from Crash Evidence	Injury Source
<u>Example 1</u> Neck strain NPTM-1	a. head strikes windshield b. forehead hits roof or convertible top c. head strikes steering wheel rim d. back hits seatback, no head restraint, head rolls back over seat e. neck forced into lateral flexion by impact forces f. torso restrained by belt, head and neck inertia causes neck injury g. back hits seat back, head hits head restraint, neck is injured	a. (01) windshield b. (54) roof or convertible top c. (04) steering wheel rim d. (92) noncontact injury source e. (92) noncontact injury source f. (92) noncontact injury source g. (44) head restraint
<u>Example 2</u> Hip Dislocation P.DJ-3	Knee strikes knee bolster forces transmitted along femur forcing femoral head out of the acetabulum	(13) knee bolster
<u>Example 3</u> Shoulder-elbow-wrist fracture/dislocation _.ZJ-2	Occupant braced hands on instrument panel, transmitting forces to wrist, elbow, and shoulder	(11) instrument panel
<u>Example 4</u> Acute lumbar strain BITM-1	Jackknife over seat belt, rotation about seat belt stretches back muscles	(41) belt restraint

6. When no other injury information is available, data from the PAR are to be coded if specific injuries are detailed.

Coding PAR injury data

If the PAR provides enough information for a specific injury to code at least one of the OIC row variables, then code Number of Recorded Injuries for This Occupant (OA43>01) and complete the Occupant Injury Form (OI05 et al.).
Example: Minor bleeding, head--HUUU-7.

If the PAR indicates "complaint of pain", then code OA43 as "97" (Injured, details unknown). The Occupant Injury Form is not submitted.

If a PAR indicates "not injured", "unknown if injured", or if a "K", "A", "B", or "C" severity rating is the only information available, an OIC is not coded. The Occupant Injury Form is not submitted.

7. If the PAR is "blank" where the injury severity is accessed and the person was at the scene during the police investigation, then code: No recorded injuries (OA43=00). However, if the person was not present during the police investigation, then code: Unknown if injured (OA43=99).
8. MASS does not code unsubstantiated injuries. If the words "possible" or "probable" are used, then do not code the injury.

Presumption of "No injury" or "Unknown if injured" from Par

Unsubstantiated injuries

INJURY DATA OVERVIEW

NASS Injury Coding Conventions

1. If an AIS is determined to be one of two consecutive numbers, but a clear indication cannot be made after reviewing all the information provided, assign the lower AIS. Uncertainty Rule #1--code lower AIS

2. When there is uncertainty about the location of minor multiple abrasions, contusions, and lacerations, etc. to the body surface, follow the guidelines below: Uncertainty Rule #2--whole body integumentary injuries
 - a. If any of the words multiple, numerous, several, or the plural of a lesion is used to describe the injuries, enter one line of code (e.g., multiple chest contusions--code CWCI-).
 - b. Multiple integumentary injuries with uncertainty of body region location; aggregate, regardless of location(s), into OW_I-1.
 - c. If multiple contusions, abrasions, or lacerations occur to a single body region, code the body region and aspect W (e.g. multiple facial abrasions -- code FWAI-).
 - d. Multiple integumentary injuries located on one side of body; aggregate into OL_I-1 or OR_I-1.
 - e. Single integumentary injury with uncertainty of location; code UU_I-1.
 - f. OW_I-1 is the default if unknown which of the above situations (b-d) exists.

3. If the medical or interview information indicates a contused knee, elbow, wrist, ankle, etc., and does not specifically state whether the contusion is to the bone or joint, code the injury as integumentary, _CI-1. If the contusion is known to be to the bone, use _CS- ; if to the joint, use _CJ- . Example: contused knee, K.CI-1. Uncertainty Rule #3--most superficial system if unknown system/organ

4. Cervical spine strain may, in some cases, still be referred to as "whiplash". "Whiplash" is not a medical term and is not used in AIS-85. If an injury is described as "whiplash", it should be coded as cervical spine strain (no fracture or dislocation) NPTM-1, provided the guidelines below are followed: "Whiplash" NPTM-1
 - a. Interviewee reports: "Whiplash".
ER reports: "Pain", "stiffness", or "limited ROM" in neck but does not diagnose strain.
Code: Do not code whiplash since ER, in essence, ruled it out.
 - b. Interviewee reports: "Whiplash".
ER reports: "Neck supple" and does not diagnose strain.
Code: Do not code whiplash since ER, in essence, ruled it out.
 - c. Interviewee reports: "Whiplash".
ER reports: (No medical attention sought.)
Code: Code whiplash, data source "7" (since it is the only data available).
 - d. Interviewee reports: "Whiplash".
ER reports: (No indication that neck was specifically examined.)
Code: Code whiplash, data source "7" (since ER did not rule out its possibility).

5. All internal structures of the mouth, with the exception of the teeth, are coded as part of the digestive system (D). Teeth are coded as skeletal (S). Mouth (except teeth) = D,
Teeth = S

INJURY DATA OVERVIEW

6. Body region code 0 (whole body) should be used only if 50% or more of the whole body surface (0) is affected. An exception is made for burns affecting more than one body region (see below). Aspect code W (whole region) is used only if 50% or more of the body region is affected. 50% rule
7. If a lesion involves more than one aspect of a body region: Aspect Whole (W) Code
- a. Try to determine if one of the aspects is predominant. If so, code that aspect.
- b. If not, use the aspect code W (whole).
8. Burn injuries should be coded using the Rule of Nines to assign the AIS severity level for (a), (b), (c), and (d) below; see the Rules of Nines diagram: Burn injuries and the rule of nines
- a. If only one body region is burned, use that body region code (e.g., ARBI-1, burned right upper arm 1°).
- b. If more than one body region is burned, but a single injury code will adequately describe the regions affected, use the single injury code (e.g., XRBI-2, burned right whole arm 2°).
- c. If more than one body region is burned and one injury code cannot be used to specify the body regions involved, the injury is coded OWBI-_. This will be the most likely case coding burns.
- d. If both arms or legs are burned, use the code OWBI-_-.
9. The following definitions have been used traditionally to differentiate "sprain" and "strain" injuries: Strain versus sprain
- sprain - a joint injury which causes pain and disability depending on the degree of injury to ligaments and muscle tendons near the joint.
- strain - an injury to a muscle or musculotendinous unit that results from overstretching and may be associated with a sprain or fracture.
- In common medical practice, however, physicians often do not adhere strictly to these definitions, and may use the terms interchangeably. AIS-85 distinguishes sprains from strains. Care should be exercised in selection of the proper code, use _ _SJ for sprains (joint injuries) and _ _TM-1 for strains (muscle injuries).
- Neck injuries may sometimes be described as "strains" and sometimes as "sprains". For NASS purposes, neck injuries should be coded as "strains" (see above definitions). No sprains to neck
10. Coding of substantiated anatomic lesions to the brain: Coding anatomic/diffuse brain lesions
- a. If substantiated anatomic lesions to the brain and the level of consciousness are known, the OIC and AIS for each substantiated anatomic lesion to the brain will be coded as it is specified in the "Anatomic Lesions" section (see HEAD, Part B, Anatomic Lesions). In addition, one OIC and AIS will be coded for the level of consciousness data as they appear in Part C, Diffuse Lesions.
- b. If there are no substantiated anatomic lesions to the brain, the OIC and AIS will be coded as they appear in the Diffuse Lesions section (see HEAD, Part C, Diffuse Lesions).
11. When an injury is described as a " type of laceration" (e.g., avulsion type laceration, flap laceration) use the "V" (avulsion) lesion code. For all ambiguous situations, use "laceration" over puncture or avulsion. Laceration type injuries
12. The AIS codes individual injuries only. Injuries to body parts which are present on both sides of the body (bilateral) are coded as two separate injuries. It should be remembered that within the OIC, "Aspect" measures the location of the injury being reported. Bilateral not used - except ribs

INJURY DATA OVERVIEW

Exception - Aspect "B" (Bilateral) is added for the purpose of coding bilateral rib fractures only. Adjacent and/or nonadjacent bilateral rib fractures are assigned one OIC and AIS code. For example, a fracture to right 6-7 and left 4-6 ribs, ≥ 4 ribs fractured, is coded CBFS-3.

13. The distinction in coding individual skull fractures versus subsuming them under the crush classification lies in the displacement of brain tissue. If it can be determined that brain matter is forcibly extracted from or massively injured within the cranium in conjunction with extensive fracturing, then the term "crushed skull" is applicable. Crushed skull
- Lack of specificity regarding the displacement of brain tissue tells the researcher not to use the crush code and to code the fracturing as individual injuries. An HUUB-7 may be added if brain injuries are present but not specifically described.
14. If the injury description states only "tear", then: Tears
- a. If involving internal organs, use lesion "laceration".
- b. If involving the external integumentary system, use lesion "laceration" or "avulsion" as appropriate. If unknown which to choose, code "laceration".
15. For multiple fractures to the same bone: > 1 fracture in a bone
- a. If multiple fractures to the same bone are determined, code each separately.
- b. If the fractures cannot be differentiated, or if the fracture is nonspecific, then it should be considered as one comminuted fracture. Assign one OIC code with an upgraded AIS (where appropriate).
- c. Exception:
- o ribs - multiple fractures to the same rib are assigned one OIC code and the AIS is upgraded.
 - o pubis - multiple fractures to the pubis (right, left, inferior, and/or superior) are assigned one OIC code; upgrade AIS if appropriate.
16. For "seat belt bruises" due to a three-point system, Seat belt contusions
- S_CI-1 (_ = R,L)
C_CI-1 (_ = R,L,C,W)
M_CI-1 (_ = R,L,C,S,I,W)
- Code S_CI-1, CCCI-1, and MCCI-1 if unspecified.
[Note: Code only those injuries that are consistent with the type of restraint worn (e.g., do not code S_CI-1 or C_CI-1 if only a lap belt was used).]
17. For open (compound) fractures, do not code any accompanying laceration unless the laceration was not caused by the fracture. This is because, by definition, an open fracture penetrates the external skin. Simply raise the AIS for the open fracture, where permitted by a footnote. Open fractures
- Exception: open fracture of skull lacerating brain matter (code as two codes).
18. If a deep laceration or puncture penetrates the soft tissue and it can be determined that it is associated with a similar lesion to a related internal structure, only the injury with the higher AIS (the internal injury) should be coded. Lesions involving skin and internal structures
- If in doubt that the external and internal lesion are related, code both.
19. The following terms may be used as a guide in differentiating between superficial, major, or complex lacerations or punctures to internal organs of the throat, thorax, and abdomen. Internal lacerations/punctures

INJURY DATA OVERVIEW

Superficial = minor, partial thickness, small
Major = deep, full thickness, large (massive)
Complex = tissue loss, segmental loss, stellate (abdominal)

NOTE: When organs are lacerated/punctured and the medical report indicates massive, extensive, or significant blood loss, code the higher AIS.

However, the final choice of whether or not to use the "superficial" or "major" AIS levels depends on the term within the context of the entire injury description.

20. AIS codes for joint injuries (i.e., fracture, dislocation, or fracture and dislocation) occurring to the extremities incorporate associated ligament/tendon lesions. Thus, do not code ligament/tendon injuries separately. Joint-ligament injuries
- However, if the injury is described as an avulsion/chip fracture, treat this injury as a ligament injury and code the lesion as a rupture.
21. For multiple internal injuries to an organ of the thorax or abdomen, code one OIC per lesion type, choosing the highest AIS for each particular lesion. Multiple internal lesions
- Example: contusion liver, one extensive laceration liver, one superficial laceration liver. Code contusion (MRCL-2) and laceration (MRLL-4).
- For multiple injuries to an artery/vein or nerve located in the same OIC body region or the same region of the spinal cord (example: cervical), code only one OIC code, choosing the lesion with the highest AIS among all the lesions present.
- Example: laceration aorta, severance aorta. Code only one code, severance (CCEA-6).
22. If the medical indicates "soft tissue injury" and a specific lesion cannot be determined from the medical or some other source (e.g., interview), code the injury as a contusion. Soft tissue injury
23. A single linear skull fracture that crosses several bones should be given a representative single line of code. Linear skull fracture involving > 1 bone
- a. One fracture through several bones receives one line of code with the best aspect assigned.
 - b. Multiple (i.e., an unspecified number) fractures receive one line of code.
 - c. A known number of fractures are coded with an equal number of coded lines.
 - d. If both base and vault are involved in a single line situation, use the higher AIS fracture.

Variable Name: Source of Injury Data
(1st through 10th or higher)

Element Values:

Official	Unofficial
1 Autopsy records with or without hospital/medical records	5 Lay coroner report
2 Hospital/medical records other than emergency room (e.g., discharge summary)	6 E.M.S. personnel
3 Emergency room records only (including associated x-rays or other lab reports)	7 Interviewee
4 Private physician, walk-in or emergency clinic	8 Other source (specify)
	9 Police

Source: Element chosen

Remarks:

Code "1" (Autopsy records with or without hospital/medical records) excludes records from lay, nonmedical personnel; they must be the result of an autopsy by a physician or other similarly qualified life scientist. A non-invasive external examination by a physician, though, should be coded either "2" (Hospital medical records other than emergency room) or "4" (Private physician, walk-in or emergency clinic) since it is generally a superficial listing of external injuries and possible internal injuries; therefore, injuries from a non-invasive exam should not be grouped with those from a thorough autopsy report.

Code "2" [Hospital/medical records other than emergency room (e.g., discharge summary)] is used whenever the injury is listed on the official post-emergency room records of a hospital or medical facility. If the injury was also listed on a facility's associated emergency room records, then the "2" code takes precedence. If the injury is also contained in an autopsy record--where the autopsy was performed by a physician or similarly qualified life scientist--then, code "1" (Autopsy records with or without hospital/medical records) takes precedence. However, this code includes non-invasive (external) examinations conducted by a physician on a deceased victim and documented as a hospital or medical examiner's record.

Code "3" [Emergency room records only (including associated x-rays or other lab reports)] is used when the injury only appears on a facility's emergency room record or on records that were completed in support of the person's examination in an emergency room. For example, an x-ray report that was completed because the emergency room physician requested it as a part of his/her examination would be included under

Variable Name: Source of Injury Data
(1st through 10th or higher)

this code. This code should not be used if the injury is subsequently listed on a post-emergency room record in a medical autopsy.

If both types of records (emergency room and post-emergency room) refer to the same injury, code "2" [Hospital/medical records other than emergency room (e.g., discharge summary)] is used as the code even if the detail provided on the emergency room records exceeds the detail provided on the post-emergency room records.

Code "4" (Private physician, walk-in or emergency clinic) refers to any physician (in private practice) who saw the injured person and who has records of that treatment (i.e., other than hospital or autopsy records). Also included in this code are non-invasive (external) examinations conducted by a private physician or similarly qualified life scientist on a deceased victim and documented as other than a hospital record (e.g., coroner's report).

In summary, examinations of deceased persons are distinguished first by qualifications of examiner [official (codes "1", "2", and "4") versus unofficial (code "5")], second by the type of examination [autopsy (code "1") versus non-invasive (codes "2" or "4")], and third by type of examination record [hospital (code "2") versus other than hospital (code "4")].

Code "5" (Lay coroner report) is used if the injury data is contained in a report where a non-invasive examination of the deceased was performed a non-physician, or lay coroner.

Code "6" (E.M.S. personnel) refers to a person certified by the state as trained in emergency medical service techniques. This code should not be used for ambulance attendants, police, or other personnel not trained in E.M.S. techniques.

Code "7" (Interviewee) refers to the person who was interviewed to get the information on this form (not necessarily the person described on this form). The interviewee is defined in a log variable.

Code "8" (Other source) is used when data are obtained from an unofficial source different from those explicitly listed above (e.g., chiropractors).

Code "9" (Police) can be used, but only when no other source of injury information is available.

Variable Name: O.I.C. - Body Region
(1st through 10th or higher)

Element Values:

M	Abdomen	K	Knee
Q	Ankle - foot	L	Leg (lower)
A	Arm (upper)	Y	Lower limb(s) (whole or unknown part)
B	Back - thoracolumbar spine	N	Neck - cervical spine
C	Chest	P	Pelvic - hip
E	Elbow	S	Shoulder
F	Face	T	Thigh
R	Forearm	X	Upper limb(s) (whole or unknown part)
H	Head - skull	O	Whole body
U	Injured unknown region,	W	Wrist - hand

Source: Variables OI05 et al., respectively

Remarks:

The 1988 NASS Injury Coding Manual contains a listing of most injuries. Use the manual to code, for each injury, its O.I.C. body region and record it on the form.

Variable Name: O.I.C. - Aspect of Injury
(1st through 10th or higher)

Element Values:

A	Anterior - front	L	Left
B	Bilateral (bilateral rib fractures only)	P	Posterior - back
C	Central	R	Right
I	Inferior - lower	S	Superior - upper
U	Injured, unknown aspect	W	Whole region

Source: Variables 0I05 et al., respectively

Remarks:

The 1988 NASS Injury Coding Manual contains a listing of most injuries. Use the manual to code, for each injury, its O.I.C. aspect and record it on the form.

Variable Name: O.I.C. - Lesion
(1st through 10th or higher)

Element Values:

A Abrasion	Z Fracture and dislocation
M Amputation	U Injured, unknown lesion
V Avulsion	L Laceration
B Burn	O Other
K Concussion	P Perforation, puncture
C Contusion	R Rupture
N Crush	S Sprain
G Detachment, separation	T Strain
D Dislocation	E Total severence, transection
F Fracture	

Source: Variables OI05 et al., respectively

Remarks:

The 1988 NASS Injury Coding Manual contains a listing of most injuries. Use the manual to code, for each injury, its O.I.C. lesion and record it on the form.

Variable Name: O.I.C. - System/Organ
(1st through 10th or higher)

Element Values:

W All systems in region	L Liver
A Arteries - veins	M Muscles
B Brain	N Nervous system
D Digestive	P Pulmonary - lungs
E Ears	R Respiratory
O Eye	S Skeletal
H Heart	C Spinal Cord
U Injured, unknown system	Q Spleen
I Integumentary	T Thyroid, other endocrine gland
J Joints	G Urogenital
K Kidneys	V Vertebrae

Source: Variables OI05 et al., respectively

Remarks:

The 1988 NASS Injury Coding Manual contains a listing of most injuries. Use the manual to code, for each injury, its O.I.C. system/organ and record it on the form.

Variable Name: Abbreviated Injury Scale
(1st through 10th or higher)

Element Values:

- 1 Minor injury
- 2 Moderate injury
- 3 Serious injury
- 4 Severe injury
- 5 Critical injury
- 6 Maximum (untreatable)
- 7 Injured, unknown severity

Source: Variables OI05 et al., respectively

Remarks:

The 1988 NASS Injury Coding Manual contains a listing of most injuries. Use the manual to code, for each injury, its A.I.S. value and record it on the form.

Variable Name: Injury Source
(1st through 10th or higher)

Element Values:

Front

- 01 Windshield
- 02 Mirror
- 03 Sunvisor
- 04 Steering wheel rim
- 05 Steering wheel hub/spoke
- 06 Steering wheel (combination of codes 04 and 05)
- 07 Steering column, transmission, selector lever, other attachment
- 08 Add on equipment (e.g., CB, tape deck, air conditioner)
- 09 Left instrument panel and below
- 10 Center instrument panel and below
- 11 Right instrument panel and below
- 12 Glove compartment door
- 13 Knee bolster
- 14 Windshield including one or more of the following: front header, A-pillar, instrument panel, mirror, or steering assembly (driver side only)
- 15 Windshield including one or more of the following: front header, A-pillar, instrument panel, or mirror (passenger side only)
- *16 Other front object (specify)

Left Side

- 20 Left side interior surface, excluding hardware or armrest
- 21 Left side hardware or armrest
- 22 Left A pillar
- 23 Left B pillar
- *24 Other left pillar (specify)
- 25 Left side window glass or frame
- 26 Left side window glass including one or more of the following: frame, window sill, A-pillar, B-pillar, or roof side rail
- *27 Other left side object (specify)

Right Side

- 30 Right side interior surface, excluding hardware or armrest
- 31 Right side hardware or armrest
- 32 Right A pillar
- 33 Right B pillar
- *34 Other right pillar (specify)
- 35 Right side window glass or frame
- 36 Right side window glass including one or more of the following: frame, window sill, A-pillar, B-pillar, or roof side rail
- *37 Other right side object (specify)

Variable Name: Injury Source (cont'd.)
(1st through 10th or higher)

Interior

- 40 Seat, back support
- 41 Belt restraint webbing/buckle
- 42 Belt restraint B pillar attachment point
- *43 Other restraint system component (specify)
- 44 Head restraint system
- 45 Air bag
- *46 Other occupants (specify)
- 47 Interior loose objects
- *48 Child safety seat (specify)
- *49 Other interior object specify)

Roof

- 50 Front header
- 51 Rear header
- 52 Roof left side rail
- 53 Roof right side rail
- 54 Roof or convertible top

Floor

- 56 Floor including toe pan
- 57 Floor or console mounted transmission lever, including console
- 58 Parking brake handle
- 59 Foot controls including parking brake

Rear

- 60 Backlight (rear window)
- 61 Backlight storage rack, door, etc.
- *62 Other rear object (specify)

Exterior of Occupant's Vehicle

- 65 Hood
- 66 Outside hardware (e.g., outside mirror, antenna)
- *67 Other exterior surface or tires (specify)
- 68 Unknown exterior objects

Exterior of Other Motor Vehicle

- 70 Front bumper
- 71 Hood edge
- *72 Other front of vehicle (specify)
- 73 Hood
- 74 Hood ornament
- 75 Windshield, roof rail, A-pillar
- 76 Side surface

Variable Name: Injury Source (cont'd.)
(1st through 10th or higher)

- 77 Side mirrors
- *78 Other side protrusions (specify)
- 79 Rear surface
- 80 Undercarriage
- 81 Tires and wheels
- *82 Other exterior of other motor vehicle (specify)
- 83 Unknown exterior of other motor vehicle

Other Vehicle or Object in the Environment

- 84 Ground
- *85 Other vehicle or object (specify)
- 86 Unknown vehicle or object

Noncontact Injury

- 90 Fire in vehicle
- 91 Flying glass
- *92 Other noncontact injury source (specify)

- 97 Injured, unknown source

Source: Researcher determined--inputs include vehicle inspection, interviewee, and medical records.

Remarks:

Code "06" (Combination of rim and hub/spokes) when there is an unspecified steering wheel injury source.

Code "14" [Windshield including one or more of the following: front header, A-pillar, instrument panel, mirror, or steering assembly (driver side only)] should be used for contacts on the left (driver) side of the vehicle interior. This code applies only when there is a continuous or simultaneous contact to the windshield and one of the listed components by a single OIC body region of the occupant.

Code "15" [Windshield including one or more of the following: front header, A-pillar, instrument panel, or mirror (passenger side only)] should be used for contacts on the right (passenger) side of the vehicle interior. This code applies only when there is a continuous or simultaneous contact to the windshield and one of the listed components by a single OIC body region of the occupant.

Codes "26" and "36" [Left (Right) side window glass including one or more of the following: frame, window sill, A-pillar, B-pillar, or roof side rail] apply when there is a simultaneous or continuous contact by a single OIC body region of an occupant to the appropriate side window glass and at least one of the listed components. The window sill

Variable Name: Injury Source (cont'd.)
(1st through 10th or higher)

consists, for this attribute, of the upper portion of the side interior surface immediately adjacent to the bottom of the side window opening.

Child restraining devices have caused confusion when they are the source of the injury. The child restraint (i.e., infant/child seat, booster seat, etc.) is considered to be an integral restraint (e.g., the whole seat is the restraint). When the restraint is used by an infant or child it should be coded as one unit. In the CDS the analyst is concerned with the complete seat and its performance.

Code "48" (Child safety seat) if contact with a child safety seat occurs from either (a) an infant or child restrained by the child safety seat or (b) any passenger including an infant or child who contacts child safety seat but is not restrained by that seat.

When any body member of an infant or child restrained by child safety seat contacts an interior object other than the child safety seat, then code the appropriate interior object (i.e., Seat, back support - code "40"; Head restraint system - code "44" etc.)

Code "85" (Other vehicle or object) if an occupant of a vehicle in-transport impacts a parked (not in-transport) vehicle.

Code "90" (Fire in vehicle) is used for injuries which resulted from heat or flame from fire. The origin of the fire unimportant.

Code "91" (Flying glass) is used for injuries which resulted from interior flying glass. Interior flying glass refers to the occupant being injured by glass which has already fractured due to an impact to the vehicle containing the glazing before the occupant's kinematics allowed the person to physically come into contact with the glazing. The flying glass may or may not be airborne when it injures the occupant. This does not refer to an occupant injury caused by glazing which shattered upon being impacted by the occupant.

Code "92" (Other noncontact injury source) is used for injuries which resulted from impact force (no contact), battery acid, etc. For a more detailed discussion see NASS Injury Coding Procedure number 5.

Use Page 3 (or its reverse side) of the Interview Form to record the interviewee reported injury source evidence and pages four and five of the Vehicle Interior Form to record the physical injury source evidence. The researcher should record only those contact mechanisms which can be documented by some physical evidence (e.g., scuffs, hair, smudges, dents, cracks, etc.).

Variable Name: Injury Source (cont'd.)
(1st through 10th or higher)

The element values encoded can be based on physical evidence, occupant kinematics, and interviewee information. Although physical evidence is preferred, it does not have to be present to support a contact mechanism.

- * Note: Whenever an "other" code (i.e., "16", "24", "27", "34", "37", "43", "46", "48", "49", "62", "67", "72", "78", "82", "85", or "92") is encoded as injury source, clearly identify, in the space provided next to each code on the reverse side of Page 2 of the Occupant Injury Form, a description of the "other" source.

Variable Name: Injury Source Confidence Level
(1st through 10th or higher)

Element Values:

- 1 Certain
- 2 Probable
- 3 Possible
- 9 Unknown

Source: Researcher determined--inputs include vehicle inspection, interviewee, and medical records.

Remarks:

The intent of this variable is to give analysts an assessment of the researcher's confidence in the injury source coded for a specific injury.

Code "1" (Certain) if there is no reasonable doubt in the mind of the researcher, based on occupant location, accident dynamics, contact points, and injury mechanism.

Code "2" (Probable) in those situations where there is not a certainty based on the factors noted above for code "1" (Certain).

Code "3" (Possible) if there is no supporting physical evidence but all factors point to an area of the vehicle or an object as the injury source.

Code "9" (Unknown) if the injury source is "97" (Injured, unknown source).

Variable Name: Direct/Indirect Injury
(1st through 10th or higher)

Element Value:

- 1 Direct contact injury
- 2 Indirect contact injury
- 3 Noncontact injury
- 7 Injured, unknown source

Source: Researcher determined--inputs include vehicle inspection, interviewee, and medical records.

Remarks:

The distinction between direct and indirect is covered in greater detail in NASS Injury Coding Procedure number 4.

Code "1" (Direct contact injury) if the coded injury results from a force impacted directly on the injured body region by the component/object coded as the Injury Source (OI11 et al.).

Code "2" (Indirect contact injury) if the coded injury results from a force transmitted from the component/object coded as the injury source (OI11 et al.) through another body region to the injured body region (e.g., knee contacts dash, force transmitted through knee and femur causing a fractured pelvis).

If an occupant's O.I.C. Body Region (OI06 et al.) impacts an object producing an injury to the same O.I.C. Body Region, but the force was transmitted through the occupant's eyeglass, objects in the person's pocket, etc., code the injury as a direct contact ("1").

Code "3" (Noncontact injury) is used when the respective OI11 et al. equals "90" (Fire in vehicle), "91" (Flying glass), or "92" (Other noncontact injury source).

Code "7" (Injured, unknown source) is used whenever the Injury Source is coded "97" (Injured, unknown source).

Variable Name: Occupant Area Intrusion Number
(1st through 10th or higher)

Element Values:

Range: 00-10, 97, 99

00 No intrusion or injury not associated with a documented intrusion

97 Injury associated with a noncoded intrusion

99 Unknown

Source: Researcher determined--inputs include vehicle inspection, interviewee, and medical records.

Remarks:

Code "00" (No intrusion or injury not associated with a documented intrusion) when the O.I.C. Injury Source (OI11 et al.) is not caused by an intruding component or when there are no intrusions coded on the Vehicle Interior Form (VI47-VI86). For example, use this code if the injury source is unknown but no intrusions were coded.

Code "97" (Injury associated with a noncoded intrusion) applies when the injury source is an intruding component but this intrusion was not coded on the Interior Vehicle Form because it was not one of the ten most severe.

Code "99" (Unknown) when the injury source, OI11 et al., is coded unknown and at least one intrusion is present (i.e., IV47 et al is not coded "Blank"). If the rare situation exists where a researcher cannot say what the injury source is, but can say definitely that none of the intruding components could possibly have produced the injury, then code "00" (No intrusion or injury not associated with an intrusion). In addition, use this code when the vehicle is not inspected or when the vehicle had been repaired prior to inspection.

For all other situations, code the row number of the intruding component which caused the injury. The Intruding Component (VI48 et al.) should be the same or a part of the injury source (OI11 et al.) coded for this injury row (i.e., 1st through 10th or higher).

UPDATE FORM

<p>1. Primary Sampling Unit Number _____</p> <p>2. Case Number - Stratum _____</p> <p>3. Vehicle Number _____</p> <p>4. Occupant Number _____</p>	<p>Driver or Occupant Name: _____</p> <p>Address: _____</p> <p>_____</p> <p>Other Information: _____</p> <p>_____</p> <p style="text-align: center;"><i>(Sanitize this section prior to Update submission.)</i></p>
---	---

STATUS OF LOG INJURY INFORMATION

<p>Injury Information _____</p> <p>(00) Not medically treated/record not required</p> <p>(01) No record of treatment at medical facility</p> <p>(02) Medical release required - not obtained</p> <p>(03) Injury not related to accident</p> <p>(04) Noncooperative hospital</p> <p>(05) Hospital out-of-study area</p> <p>(06) Private physician would not release data</p>	<p>(07) Unknown if medically treated</p> <p>(08) To be updated</p> <p>(09) Record not received before file closeout</p> <p>(10) Record not obtained</p> <p>(11) Record obtained</p> <p>(12) Partial record obtained - not to be updated</p> <p>(13) Partial record obtained - to be updated</p>
---	---

UPDATED CASE INFORMATION

	INITIAL SUBMISSION	UPDATED INFORMATION		INITIAL SUBMISSION	UPDATED INFORMATION
GV12. Alcohol Test Result Result for Driver	___	___	OA18. Manual (Active) Belt System Use	___	___
GV39. Other Drug Specimen Test Type for Driver	___	___	OA21. Air Bag System Availability/Function	___	___
GV40.-GV41. Narcotic Drug	___	___	OA22. Air Bag System Deployment	___	___
GV42.-GV43. Depressant Drug	___	___	OA35. Treatment - Mortality	___	___
GV44.-GV45. Stimulant Drug	___	___	OA36. Type of Medical Facility (for Initial Treatment)	___	___
GV46.-GV47. Hallucinogen Drug	___	___	OA37. Hospital Stay	___	___
GV48.-GV49. Cannabinoid Drug	___	___	OA38. Working Days Lost	___	___
GV50.-GV51. Phencyclidine (PCP)	___	___	OA39. Time to Death	___	___
GV52.-GV53. Inhalant Drug	___	___	OA40. 1st Medically Reported Cause of Death	___	___
GV54.-GV55. Other Drug (Excluding Nicotine, Aspirin, Alcohol, Drugs Administered Post-Crash)	___	___	OA41. 2nd Medically Reported Cause of Death	___	___
OA05. Occupant's Age	___	___	OA42. 3rd Medically Reported Cause of Death	___	___
OA06. Occupant's Sex	___	___	OA43. Number of Recorded Injuries for This Occupant	___	___
OA07. Occupant's Height	___	___	OA44. Automatic (Passive) Belt System Availability/Function	___	___
OA08. Occupant's Weight	___	___	OA45. Automatic (Passive) Belt System Use	___	___
OA17. Manual (Active) Belt System Availability	___	___			

INJURY DATA CODED ON INITIAL SUBMISSION

	Source of Injury Data	O.I.C.-A.I.S				Injury Source	Injury Source Confidence Level	Direct/Indirect Injury	Occupant Area Intrusion No.	
		Body Region	Aspect	Lesion	System Organ					A.I.S. Severity
1st	5. ___	6. ___	7. ___	8. ___	9. ___	10. ___	11. ___	12. ___	13. ___	14. ___
2nd	15. ___	16. ___	17. ___	18. ___	19. ___	20. ___	21. ___	22. ___	23. ___	24. ___
3rd	25. ___	26. ___	27. ___	28. ___	29. ___	30. ___	31. ___	32. ___	33. ___	34. ___
4th	35. ___	36. ___	37. ___	38. ___	39. ___	40. ___	41. ___	42. ___	43. ___	44. ___
5th	45. ___	46. ___	47. ___	48. ___	49. ___	50. ___	51. ___	52. ___	53. ___	54. ___
6th	55. ___	56. ___	57. ___	58. ___	59. ___	60. ___	61. ___	62. ___	63. ___	64. ___
7th	65. ___	66. ___	67. ___	68. ___	69. ___	70. ___	71. ___	72. ___	73. ___	74. ___
8th	75. ___	76. ___	77. ___	78. ___	79. ___	80. ___	81. ___	82. ___	83. ___	84. ___
9th	85. ___	86. ___	87. ___	88. ___	89. ___	90. ___	91. ___	92. ___	93. ___	94. ___
10th	95. ___	96. ___	97. ___	98. ___	99. ___	100. ___	101. ___	102. ___	103. ___	104. ___
11th	105. ___	106. ___	107. ___	108. ___	109. ___	110. ___	111. ___	112. ___	113. ___	114. ___
12th	115. ___	116. ___	117. ___	118. ___	119. ___	120. ___	121. ___	122. ___	123. ___	124. ___
13th	125. ___	126. ___	127. ___	128. ___	129. ___	130. ___	131. ___	132. ___	133. ___	134. ___
14th	135. ___	136. ___	137. ___	138. ___	139. ___	140. ___	141. ___	142. ___	143. ___	144. ___
15th	145. ___	146. ___	147. ___	148. ___	149. ___	150. ___	151. ___	152. ___	153. ___	154. ___
16th	155. ___	156. ___	157. ___	158. ___	159. ___	160. ___	161. ___	162. ___	163. ___	164. ___
17th	165. ___	166. ___	167. ___	168. ___	169. ___	170. ___	171. ___	172. ___	173. ___	174. ___
18th	175. ___	176. ___	177. ___	178. ___	179. ___	180. ___	181. ___	182. ___	183. ___	184. ___
19th	185. ___	186. ___	187. ___	188. ___	189. ___	190. ___	191. ___	192. ___	193. ___	194. ___
20th	195. ___	196. ___	197. ___	198. ___	199. ___	200. ___	201. ___	202. ___	203. ___	204. ___

NOTE: Keep a photocopy of the following original submitted pages when applicable: Exterior Vehicle Form pages 2, 3, 4; Interior Vehicle Form pages 1-reverse, 2, 4, 5; Occupant Injury Form pages 2, 3, 3-reverse; Interview Form pages 3, 4, 5.

INJURY DATA

Record below the actual injuries sustained by this occupant that were identified from the unofficial and official prior to initial case submission and from subsequently acquired medical data. Remember not to double count an injury just because it was identified from two different sources.

	Source of Injury Data	O.I.C.—A.I.S					Injury Source	Injury Source Confidence Level	Direct/Indirect Injury	Occupant Area Intrusion No.
		Body Region	Aspect	Lesion	System Organ	A.I.S. Severity				
1st	5. ___	6. ___	7. ___	8. ___	9. ___	10. ___	11. ___	12. ___	13. ___	14. ___
2nd	15. ___	16. ___	17. ___	18. ___	19. ___	20. ___	21. ___	22. ___	23. ___	24. ___
3rd	25. ___	26. ___	27. ___	28. ___	29. ___	30. ___	31. ___	32. ___	33. ___	34. ___
4th	35. ___	36. ___	37. ___	38. ___	39. ___	40. ___	41. ___	42. ___	43. ___	44. ___
5th	45. ___	46. ___	47. ___	48. ___	49. ___	50. ___	51. ___	52. ___	53. ___	54. ___
6th	55. ___	56. ___	57. ___	58. ___	59. ___	60. ___	61. ___	62. ___	63. ___	64. ___
7th	65. ___	66. ___	67. ___	68. ___	69. ___	70. ___	71. ___	72. ___	73. ___	74. ___
8th	75. ___	76. ___	77. ___	78. ___	79. ___	80. ___	81. ___	82. ___	83. ___	84. ___
9th	85. ___	86. ___	87. ___	88. ___	89. ___	90. ___	91. ___	92. ___	93. ___	94. ___
10th	95. ___	96. ___	97. ___	98. ___	99. ___	100. ___	101. ___	102. ___	103. ___	104. ___

If greater than 10 injuries, record additional on Occupant Injury Data Supplement.

OCCUPANT INJURY DATA

	O.I.C.—A.I.S.						Injury Source	Injury Source Confidence Level	Direct/Indirect Injury	Occupant Area Intrusion No.
	Source of Injury Data	Body Region	Aspect	Lesion	System Organ	A.I.S. Severity				
11th	—	—	—	—	—	—	---	—	—	---
12th	—	—	—	—	—	—	---	—	—	---
13th	—	—	—	—	—	—	---	—	—	---
14th	—	—	—	—	—	—	---	—	—	---
15th	—	—	—	—	—	—	---	—	—	---
16th	—	—	—	—	—	—	---	—	—	---
17th	—	—	—	—	—	—	---	—	—	---
18th	—	—	—	—	—	—	---	—	—	---
19th	—	—	—	—	—	—	---	—	—	---
20th	—	—	—	—	—	—	---	—	—	---
21st	—	—	—	—	—	—	---	—	—	---
22nd	—	—	—	—	—	—	---	—	—	---
23rd	—	—	—	—	—	—	---	—	—	---

OFFICIAL INJURY DATA – SOFT TISSUE INJURIES

Indicate the Location, Lesion, Detail (size, depth, fracture type, head injury clinical signs and neurological deficits), and Source of all injuries indicated by official sources (or from PAR or other unofficial sources if medical records and interviewee data are unavailable.)

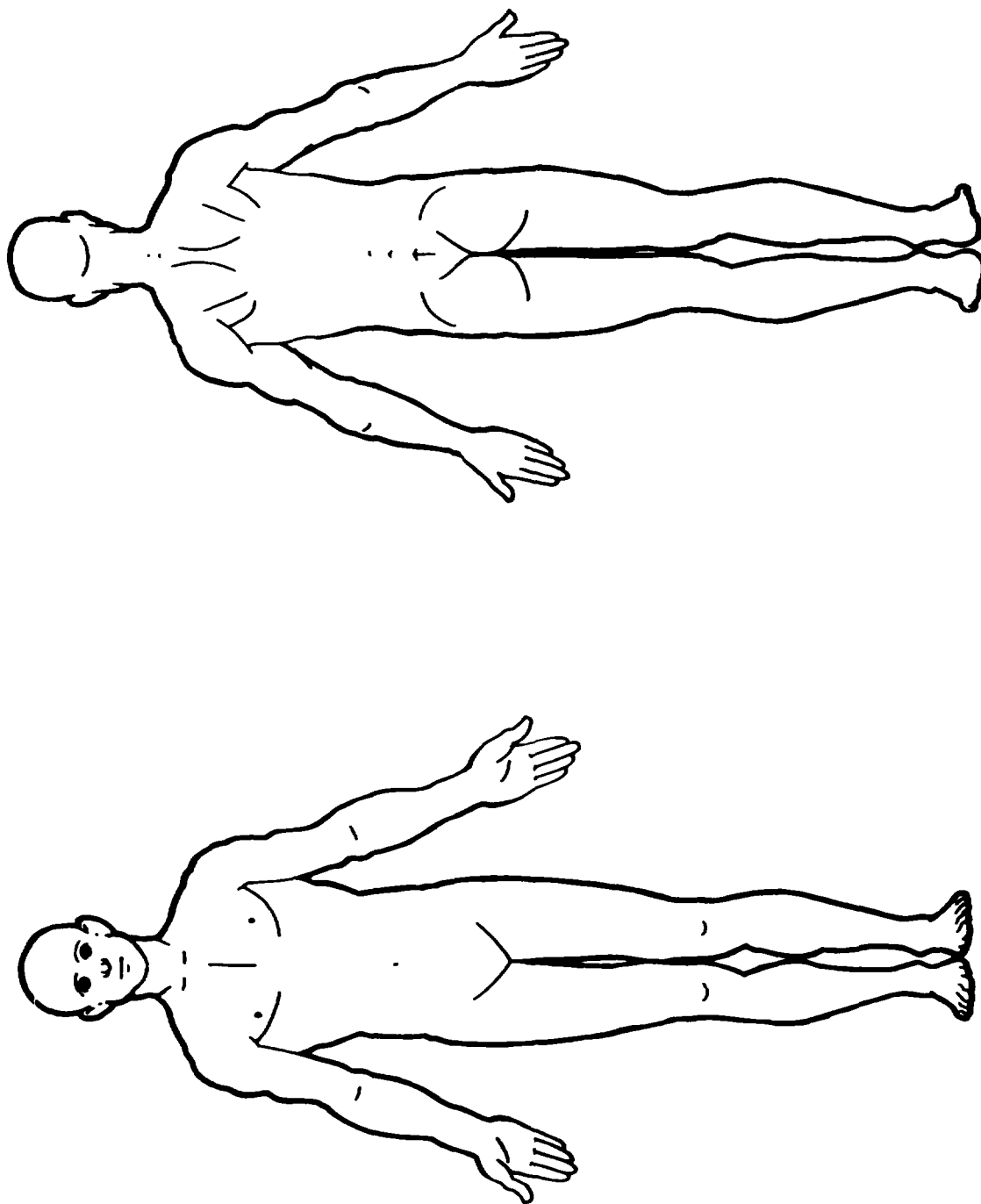

SOURCE OF INJURY DATA

OFFICIAL

- (1) Autopsy records with or without hospital medical records
- (2) Hospital medical records other than emergency room (eg discharge summary)
- (3) Emergency room records only (including associated X rays or other lab reports)
- (4) Private physician walk in or emergency clinic

UNOFFICIAL

- (5) Lay coroner report
- (6) E M S personnel
- (7) Interviewee
- (8) Other source (specify)
- (9) Police

(26) Left side window glass including one or more of the following frame window sill A-pillar B-pillar or roof side rail

(27) Other left side object (specify)

RIGHT SIDE

(30) Right side interior surface excluding hardware or armrests

(31) Right side hardware or armrest

(32) Right A pillar

(33) Right B pillar

(34) Other right pillar (specify)

(35) Right side window glass or frame

(36) Right side window glass including one or more of the following frame window sill A pillar B pillar roof side rail

(37) Other right side object (specify)

EXTERIOR OF OCCUPANT'S VEHICLE

(65) Hood

(66) Outside hardware (e.g. outside mirror antenna)

(67) Other exterior surface or tires (specify)

(68) Unknown exterior objects

EXTERIOR OF OTHER MOTOR VEHICLE

(70) Front bumper

(71) Hood edge

(72) Other front of vehicle (specify)

(73) Hood

(74) Hood ornament

(75) Windshield roof rail A pillar

(76) Side surface

(77) Side mirrors

(78) Other side protrusions (specify)

(79) Rear surface

(80) Undercarriage

(81) Tires and wheels

(82) Other exterior of other motor vehicle (specify)

(83) Unknown exterior of other motor vehicle

OTHER VEHICLE OR OBJECT IN THE ENVIRONMENT

(84) Ground

(85) Other vehicle or object (specify)

(86) Unknown vehicle or object

NONCONTACT INJURY

(90) Fire in vehicle

(91) Flying glass

(92) Other noncontact injury source (specify)

(97) Injured, unknown source

INJURY SOURCE

FRONT

(01) Windshield

(02) Mirror

(03) Sunvisor

(04) Steering wheel rim

(05) Steering wheel hub/spoke

(06) Steering wheel (combination of codes 04 and 05)

(07) Steering column transmission selector lever other attachment

(08) Add-on equipment (e.g. CB tape deck, air conditioner)

(09) Left instrument panel and below

(10) Center instrument panel and below

(11) Right instrument panel and below

(12) Glove compartment door

(13) Knee bolster

(14) Windshield including one or more of the following front header A pillar instrument panel mirror or steering assembly (driver side only)

(15) Windshield including one or more of the following front header A-pillar instrument panel or mirror (passenger side only)

(16) Other front object (specify)

LEFT SIDE

(20) Left side interior surface excluding hardware or armrests

(21) Left side hardware or armrest

(22) Left A pillar

(23) Left B pillar

(24) Other left pillar (specify)

(25) Left side window glass or frame

INTERIOR

(40) Seat back support

(41) Belt restraint webbing/buckle

(42) Belt restraint B-pillar attachment point

(43) Other restraint system component (specify)

(44) Head restraint system

(45) Air bag

(46) Other occupants (specify)

(47) Interior loose objects

(48) Child safety seat (specify)

(49) Other interior object (specify)

ROOF

(50) Front header

(51) Rear header

(52) Roof left side rail

(53) Roof right side rail

(54) Roof or convertible top

FLOOR

(56) Floor including toe pan

(57) Floor or console mounted transmission lever including console

(58) Parking brake handle

(59) Foot controls including parking brake

REAR

(60) Backlight (rear window)

(61) Backlight storage rack door etc

(62) Other rear object (specify)

INJURY SOURCE CONFIDENCE LEVEL

(1) Certain

(2) Probable

(3) Possible

(9) Unknown

DIRECT/INDIRECT INJURY

(1) Direct contact injury

(2) Indirect contact injury

(3) Noncontact injury

(7) Injured unknown source

OCCUPANT INJURY CLASSIFICATION

O I C Body Region

- (M) Abdomen
- (Q) Ankle-foot
- (A) Arm (upper)
- (B) Back-thoracolumbar spine
- (C) Chest
- (E) Elbow
- (F) Face
- (R) Forearm
- (H) Head-skull
- (U) Uninjured/unknown region
- (K) Knee
- (L) Leg (lower)
- (Y) Lower limb(s) (whole or unknown part)
- (N) Neck-cervical spine
- (P) Pelvic-hip
- (S) Shoulder
- (T) Thigh
- (X) Upper limb(s) (whole or unknown part)
- (O) Whole body

(W) Wrist-hand

Aspect of Injury

- (A) Anterior-front
- (B) Bilateral (rib fracture only)
- (C) Central
- (I) Inferior-lower
- (U) Injured unknown aspect
- (L) Left
- (P) Posterior-back
- (R) Right
- (S) Superior-upper
- (W) Whole region

Lesion

- (A) Abrasion
- (M) Amputation
- (V) Avulsion
- (B) Burn
- (K) Concussion
- (C) Contusion
- (N) Crush

(G) Detachment separation

(D) Dislocation

(F) Fracture

(Z) Fracture and dislocation

(U) Injured unknown lesion

(L) Laceration

(O) Other

(P) Perforation puncture

(R) Rupture

(S) Sprain

(T) Strain

(E) Total severance transection

System/Organ

- (W) All systems in region
- (A) Arteries-veins
- (B) Brain
- (D) Digestive
- (E) Ears
- (O) Eye
- (H) Heart
- (U) Injured unknown system

(I) Integumentary

(J) Joints

(K) Kidneys

(L) Liver

(M) Muscles

(N) Nervous system

(P) Pulmonary-lungs

(R) Respiratory

(S) Skeletal

(C) Spinal cord

(Q) Spleen

(T) Thyroid other endocrine gland

(G) Urogenital

(V) Vertebrae

Abbreviated Injury Scale

- (1) Minor injury
- (2) Moderate injury
- (3) Serious injury
- (4) Severe injury
- (5) Critical injury
- (6) Maximum (untreatable)
- (7) Injured unknown severity

OFFICIAL INJURY DATA – SKELETAL INJURIES

Indicate the Location, Lesion, Detail (size, depth, fracture type, head injury clinical signs and neurological deficits), and Source of all injuries indicated by official sources (or from PAR or other unofficial sources if medical records and interviewee data are unavailable.)

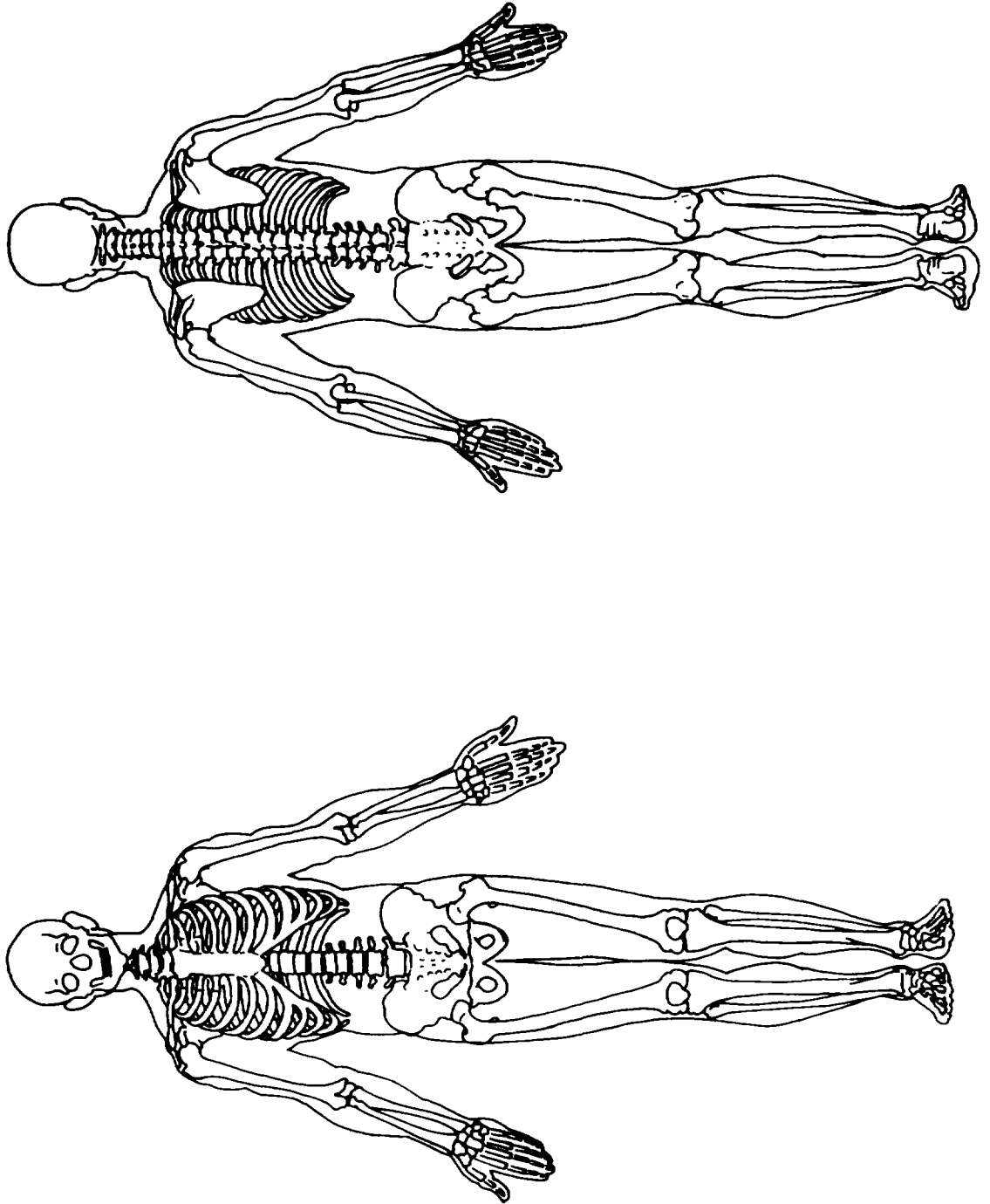

OFFICIAL INJURY DATA – INTERNAL INJURIES

Indicate the *Location*, *Lesion*, *Detail* (size, depth, fracture type, head injury clinical signs and neurological deficits), and *Source* of all injuries indicated by official sources (or from PAR or other unofficial sources if medical records and interviewee data are unavailable.)

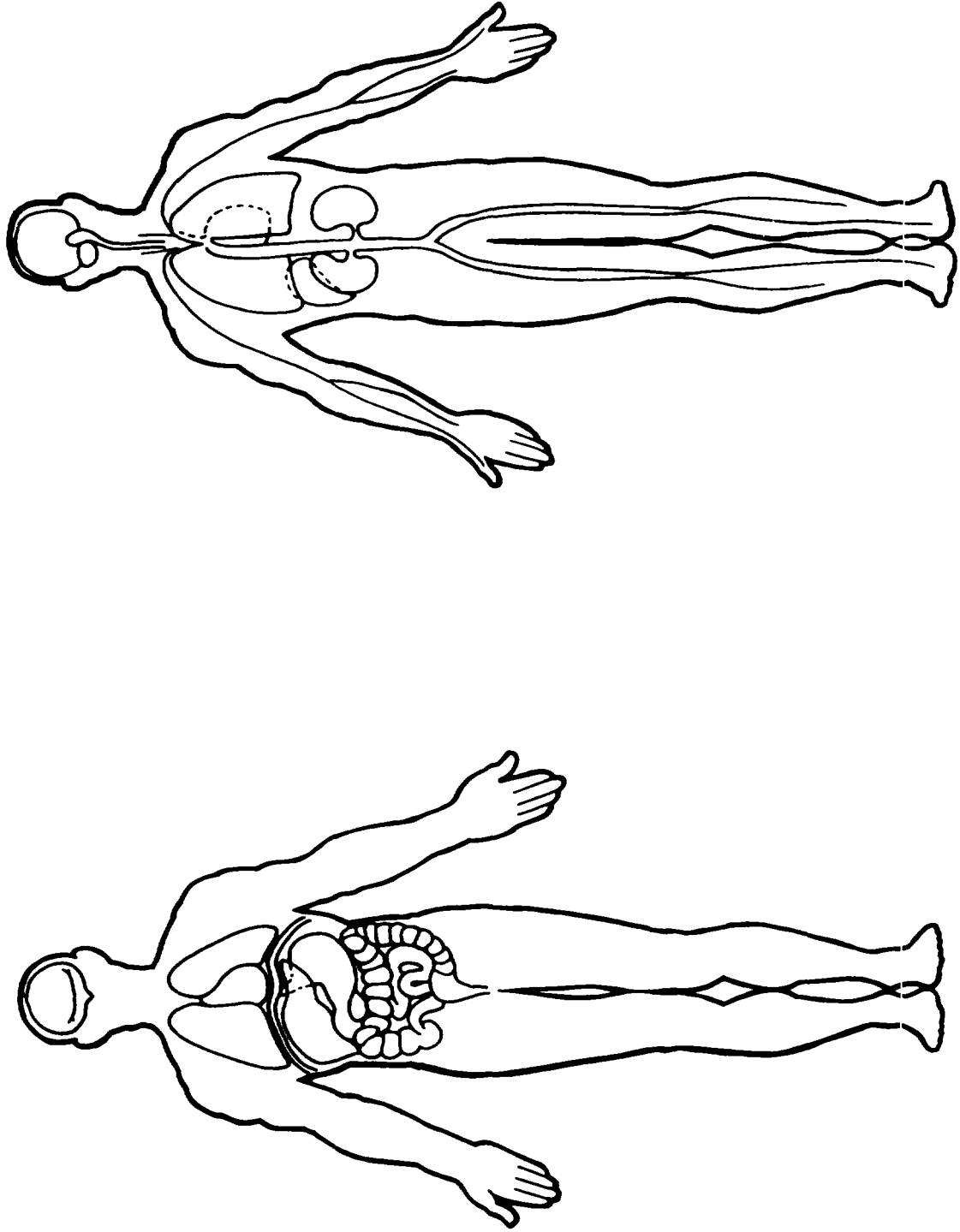

UPDATE FORM

An Update Form shall be placed in a notebook or file for all occupants whose drug information and/or medical(s) cannot be obtained prior to initial submission. Accompanying and attached to each Update Form shall be the following photocopied forms, when applicable.

- o Exterior Vehicle Form -- pages 2, 3, and 4
- o Interior Vehicle Form -- pages 1-reverse, 2, 4, and 5
- o Interview Form -- pages 3, 4, and 5
- o Occupant Injury Form -- pages 2, 3, and 3-reverse

The photocopied case material need not be submitted with the form because the Zone Center will have the original material.

The Update Forms may be filed by case number and occupant number or by the occupant's name (i.e., last name, first name, middle initial); in either case, a cross reference shall be maintained.

The driver/occupant's name and address or other pertinent information must be legibly written in the upper right-hand corner of the form. Sanitize this information prior to submitting the Update Form. Normally, only one Update Form will be submitted per occupant. However, on those occasions when more than one Update Form will be submitted for a given occupant, insert a new Update Form in the notebook or file being careful to record on the new form the most recent updated information about the occupant.

In the space below the OCCUPANT NUMBER, write the Medical Facility Code (i.e., question #14 on the Occupant Assessment Log, OAL14). Provide the code on all Update Forms.

Status of Log Injury Information

This section records the most current log status information pertaining to this occupant. The element values are identical to those found on question #13 on the Occupant Assessment Log, OAL13, where the status of the occupant's injury information was initially indicated [e.g., "08" (To be updated)]. Complete this section each time an Update Form is submitted for an occupant.

Updated Case Information

Two columns are provided. The column entitled "Initial Submission" contains the data submitted either (1) initially on the case forms or (2) subsequently on a previous update for this occupant. Data in the column entitled "Updated Information" reports the most current correct information for this occupant. For each updatable variable, record its current value under the column entitled "Initial Submission". Leave the "Updated Information" column "Blank" for any variable whose element value remains the same. This procedure will help to highlight data changes that must be made by the Zone Center.

For example, suppose that a driver was hospitalized and subsequently died. Although you learned about the occupant's death, you were not able to acquire any of his medical records in time for initial submission. Subsequently, you acquire and submit the driver's Emergency Room records believing these to be the only records that you were going to acquire. Later, you are able to obtain his autopsy. Assuming the following "initial data", your first and second "UPDATED CASE INFORMATION" sections of your submitted Update Forms could appear as follows.

First Update Form Submission

UPDATED CASE INFORMATION					
	Initial Submission	Updated Information		Initial Submission	Updated Information
GV12. Alcohol Test Result for Driver	<u>9</u> <u>6</u>	<u>9</u> <u>7</u>	OA18. Manual (Active) Belt System Use	<u>0</u> <u>3</u>	<u>0</u> <u>0</u>
GV39. Other Drug Specimen Test Type for Driver	<u> </u> <u>0</u>	<u> </u> <u>9</u>	OA21. Air Bag System Availabilty/Function	<u> </u> <u>0</u>	<u> </u> <u> </u>
GV40.-GV41. Narcotic Drug	<u>0</u> <u>0</u>	<u> </u> <u>9</u>	OA22. Air Bag System Deployment	<u> </u> <u>0</u>	<u> </u> <u> </u>
GV42.-GV43. Depressant Drug	<u>0</u> <u>0</u>	<u> </u> <u>9</u>	OA35. Treatment - Mortality	<u> </u> <u>1</u>	<u> </u> <u> </u>
GV44.-GV45. Stimulant Drug	<u>0</u> <u>0</u>	<u> </u> <u>9</u>	OA36. Type of Medical Facility (for Initial Treatment)	<u> </u> <u>1</u>	<u> </u> <u> </u>
GV46.-GV47. Hallucinogen Drug	<u>0</u> <u>0</u>	<u> </u> <u>9</u>	OA37. Hospital Stay	<u>9</u> <u>9</u>	<u> </u> <u> </u>
GV48.-GV49. Cannabinoid Drug	<u>0</u> <u>0</u>	<u> </u> <u>9</u>	OA38. Working Days Lost	<u>6</u> <u>2</u>	<u> </u> <u> </u>
GV50.-GV51. Phencyclidine (PCP)	<u>0</u> <u>0</u>	<u> </u> <u>9</u>	OA39. Time to Death	<u>9</u> <u>9</u>	<u> </u> <u> </u>
GV52.-GV53. Inhalant Drug	<u>0</u> <u>0</u>	<u> </u> <u>9</u>	OA40. 1st Medically Reported Cause of Death	<u>9</u> <u>9</u>	<u> </u> <u> </u>
GV54.-GV55. Other Drug (Excluding Nicotine, Aspirin, Alcohol, Drugs Administered Post-Crash)	<u>0</u> <u>0</u>	<u> </u> <u>9</u>	OA41. 2nd Medically Reported Cause of Death	<u>0</u> <u>0</u>	<u> </u> <u> </u>
OA05. Occupant's Age	<u>3</u> <u>1</u>	<u> </u> <u> </u>	OA42. 3rd Medically Reported Cause of Death	<u>0</u> <u>0</u>	<u> </u> <u> </u>
OA06. Occupant's Sex	<u> </u> <u>1</u>	<u> </u> <u> </u>	OA43. Number of Recorded Injuries for This Occupant	<u>0</u> <u>3</u>	<u>0</u> <u>6</u>
OA07. Occupant's Height	<u>9</u> <u>9</u>	<u> </u> <u> </u>	OA44. Automatic (Passive) Belt System Availability/Function	<u> </u> <u>2</u>	<u> </u> <u> </u>
OA08. Occupant's Weight	<u>9</u> <u>9</u> <u>9</u>	<u> </u> <u> </u> <u> </u>	OA45. Automatic (Passive) Belt System Use	<u> </u> <u>1</u>	<u> </u> <u> </u>
OA17. Manual (Active) Belt System Availability	<u> </u> <u>3</u>	<u> </u> <u> </u>			

Second Update Form Submission

UPDATED CASE INFORMATION									
	Initial Submission		Updated Information			Initial Submission		Updated Information	
GV12. Alcohol Test Result for Driver	9	7	0	8	OA18. Manual (Active) Belt System Use	0	0		
GV39. Other Drug Specimen Test Type for Driver		9		2	OA21. Air Bag System Availability/Function		0		
GV40.-GV41. Narcotic Drug	0	9		1	OA22. Air Bag System Deployment		0		
GV42.-GV43. Depressant Drug	0	9		2	OA35. Treatment - Mortality		1		
GV44.-GV45. Stimulant Drug	0	9		1	OA36. Type of Medical Facility (for Initial Treatment)		1		
GV46.-GV47. Hallucinogen Drug	0	9			OA37. Hospital Stay	9	9	1	2
GV48.-GV49. Cannabinoid Drug	0	9		2	OA38. Working Days Lost	6	2		
GV50.-GV51. Phencyclidine (PCP)	0	9			OA39. Time to Death	9	9	4	2
GV52.-GV53. Inhalant Drug	0	9			OA40. 1st Medically Reported Cause of Death	9	9	0	4
GV54.-GV55. Other Drug (Excluding Nicotine, Aspirin, Alcohol, Drugs Administered Post-Crash)	0	9			OA41. 2nd Medically Reported Cause of Death	0	0	0	5
OA05. Occupant's Age	3	1			OA42. 3rd Medically Reported Cause of Death	0	0		
OA06. Occupant's Sex		1			OA43. Number of Recorded Injuries for This Occupant	0	6	0	9
OA07. Occupant's Height	9	9	7	0	OA44. Automatic (Passive) Belt System Availability/Function		2		
OA08. Occupant's Weight	9	9	9	1	8	5			
OA17. Manual (Active) Belt System Availability		3			OA45. Automatic (Passive) Belt System Use		1		

Updated Case Information -- Continued

In this example the Emergency Room medical records indicate that the driver was given an alcohol test and may have been given a specimen test for drugs but the results are unknown. Because it is unclear, you changed your initial coding. The medical records also confirmed your suspicion that the driver had not been wearing his manual lap belt at the time of the accident. Finally, you correct the driver's total number of injuries.

On the second update, the driver's autopsy pinpoints his blood alcohol level and confirms that a urine test for drugs was used. The laboratory report indicates that a depressant and cannabinoid drug were detected while also indicating that no narcotic or stimulant drugs were detected. The laboratory report is "silent" regarding whether any hallucinogen, phencyclidine, inhalant, or other drugs were tested for. Thus, your coding remains unchanged for these variables. From the autopsy, the driver's height and weight are obtained as well as his specific injuries--see below.

If new information is learned which would cause you to change a variable not specifically listed on the Update Form, then write on the Update Form (e.g., at the bottom of the left-hand or right-hand column) the variable's number and name, the element value used on initial submission, and the element value which is correct. If you do not remember the initially submitted element values, then contact your zone center to obtain the information.

As another example, suppose in our illustration above the driver's medical records indicated that the driver was ejected (e.g., medical personnel arrive at the scene before the police and find the driver laying outside the vehicle). Since police sometimes arrive on the scene after medical personnel, it is not uncommon for occupants to be outside of their vehicles when the police arrive. Because the police may not be able to talk with occupants because of the seriousness of their injuries, medical personnel because they are busy or have left the scene with the victims, or key witnesses because they have departed, the police may fail to record the fact that someone was ejected. If this situation occurs, simply add the ejection variables: OA12 through OA15, to the Update Form writing down the initially submitted element values and the new, corrected element values.

Injury Data: Initial and Final Submission

Continuing with the example begun above, there follows below the INJURY DATA CODED ON INITIAL SUBMISSION page (reverse side of page 1 of the Update Form) and the INJURY DATA page (page 2 of the Update Form) for both the first and second Update Form submissions. On initial submission, only interviewee data were available. From the Emergency Room records, you further refine--to the extent possible, the injuries reported by the interviewee and add additional injuries paying careful attention to the "Injury Source" (i.e., O111 et al.) and "Occupant Area Intrusion Number" (i.e., O114 et al.). When you submit your second Update Form, the INJURY DATA CODED ON INITIAL SUBMISSION portion now contains what was the INJURY DATA on your first submission. The final INJURY DATA reflects the totality of your medical records as well as your final decisions regarding Injury Source identification.

First Update Form Submission

INJURY DATA CODED ON INITIAL SUBMISSION													
Source of Injury Data	O.I.C.-A.I.S.						Injury Source	Injury Source Confidence Level	Direct/Indirect Injury	Occupant Area Intrusion No.			
	Body Region	Aspect	Lesion	System Organ	A.I.S. Severity								
1st	5. <u>7</u>	6. <u>C</u>	7. <u>L</u>	8. <u>P</u>	9. <u>P</u>	10. <u>3</u>	11. <u>2</u> <u>0</u>	12. <u>1</u>	13. <u>1</u>	14. <u>0</u> <u>1</u>			
2nd	15. <u>7</u>	16. <u>C</u>	17. <u>U</u>	18. <u>F</u>	19. <u>S</u>	20. <u>2</u>	21. <u>2</u> <u>0</u>	22. <u>1</u>	23. <u>1</u>	24. <u>0</u> <u>1</u>			
3rd	25. <u>7</u>	26. <u>M</u>	27. <u>U</u>	28. <u>U</u>	29. <u>U</u>	30. <u>7</u>	31. <u>9</u> <u>7</u>	32. <u>9</u>	33. <u>7</u>	34. <u>9</u> <u>9</u>			
4th	35. <u> </u>	36. <u> </u>	37. <u> </u>	38. <u> </u>	39. <u> </u>	40. <u> </u>	41. <u> </u> <u> </u>	42. <u> </u>	43. <u> </u>	44. <u> </u> <u> </u>			
5th	45. <u> </u>	46. <u> </u>	47. <u> </u>	48. <u> </u>	49. <u> </u>	50. <u> </u>	51. <u> </u> <u> </u>	52. <u> </u>	53. <u> </u>	54. <u> </u> <u> </u>			
6th	55. <u> </u>	56. <u> </u>	57. <u> </u>	58. <u> </u>	59. <u> </u>	60. <u> </u>	61. <u> </u> <u> </u>	62. <u> </u>	63. <u> </u>	64. <u> </u> <u> </u>			
7th	65. <u> </u>	66. <u> </u>	67. <u> </u>	68. <u> </u>	69. <u> </u>	70. <u> </u>	71. <u> </u> <u> </u>	72. <u> </u>	73. <u> </u>	74. <u> </u> <u> </u>			
8th	75. <u> </u>	76. <u> </u>	77. <u> </u>	78. <u> </u>	79. <u> </u>	80. <u> </u>	81. <u> </u> <u> </u>	82. <u> </u>	83. <u> </u>	84. <u> </u> <u> </u>			
9th	85. <u> </u>	86. <u> </u>	87. <u> </u>	88. <u> </u>	89. <u> </u>	90. <u> </u>	91. <u> </u> <u> </u>	92. <u> </u>	93. <u> </u>	94. <u> </u> <u> </u>			
10th	95. <u> </u>	96. <u> </u>	97. <u> </u>	98. <u> </u>	99. <u> </u>	100. <u> </u>	101. <u> </u> <u> </u>	102. <u> </u>	103. <u> </u>	104. <u> </u> <u> </u>			
11th	105. <u> </u>	106. <u> </u>	107. <u> </u>	108. <u> </u>	109. <u> </u>	110. <u> </u>	111. <u> </u> <u> </u>	112. <u> </u>	113. <u> </u>	114. <u> </u> <u> </u>			
12th	115. <u> </u>	116. <u> </u>	117. <u> </u>	118. <u> </u>	119. <u> </u>	120. <u> </u>	121. <u> </u> <u> </u>	122. <u> </u>	123. <u> </u>	124. <u> </u> <u> </u>			
13th	125. <u> </u>	126. <u> </u>	127. <u> </u>	128. <u> </u>	129. <u> </u>	130. <u> </u>	131. <u> </u> <u> </u>	132. <u> </u>	133. <u> </u>	134. <u> </u> <u> </u>			
14th	135. <u> </u>	136. <u> </u>	137. <u> </u>	138. <u> </u>	139. <u> </u>	140. <u> </u>	141. <u> </u> <u> </u>	142. <u> </u>	143. <u> </u>	144. <u> </u> <u> </u>			
15th	145. <u> </u>	146. <u> </u>	147. <u> </u>	148. <u> </u>	149. <u> </u>	150. <u> </u>	151. <u> </u> <u> </u>	152. <u> </u>	153. <u> </u>	154. <u> </u> <u> </u>			
16th	155. <u> </u>	156. <u> </u>	157. <u> </u>	158. <u> </u>	159. <u> </u>	160. <u> </u>	161. <u> </u> <u> </u>	162. <u> </u>	163. <u> </u>	164. <u> </u> <u> </u>			
17th	165. <u> </u>	166. <u> </u>	167. <u> </u>	168. <u> </u>	169. <u> </u>	170. <u> </u>	171. <u> </u> <u> </u>	172. <u> </u>	173. <u> </u>	174. <u> </u> <u> </u>			
18th	175. <u> </u>	176. <u> </u>	177. <u> </u>	178. <u> </u>	179. <u> </u>	180. <u> </u>	181. <u> </u> <u> </u>	182. <u> </u>	183. <u> </u>	184. <u> </u> <u> </u>			
19th	185. <u> </u>	186. <u> </u>	187. <u> </u>	188. <u> </u>	189. <u> </u>	190. <u> </u>	191. <u> </u> <u> </u>	192. <u> </u>	193. <u> </u>	194. <u> </u> <u> </u>			
20th	195. <u> </u>	196. <u> </u>	197. <u> </u>	198. <u> </u>	199. <u> </u>	200. <u> </u>	201. <u> </u> <u> </u>	202. <u> </u>	203. <u> </u>	204. <u> </u> <u> </u>			

First Update Form Submission

INJURY DATA

Record below the actual injuries sustained by this occupant that were identified from the unofficial and official prior to initial case submission and from subsequently acquired medical data. Remember not to double count an injury just because it was identified from two different sources.

Source of Injury Data	O.I.C.-A.I.S.						Injury Source	Injury Confidence Level	Direct/Indirect Injury	Occupant Area Intrusion	Area No.
	Body Region	Aspect	Lesion	System Organ	A.I.S. Severity						
1st	5. <u>3</u>	6. <u>C</u>	7. <u>L</u>	8. <u>F</u>	9. <u>S</u>	10. <u>4</u>	11. <u>2</u> <u>0</u>	12. <u>1</u>	13. <u>1</u>	14. <u>0</u> <u>1</u>	
2nd	15. <u>3</u>	16. <u>C</u>	17. <u>L</u>	18. <u>L</u>	19. <u>P</u>	20. <u>3</u>	21. <u>2</u> <u>0</u>	22. <u>1</u>	23. <u>1</u>	24. <u>0</u> <u>1</u>	
3rd	25. <u>3</u>	26. <u>H</u>	27. <u>W</u>	28. <u>K</u>	29. <u>B</u>	30. <u>2</u>	31. <u>2</u> <u>6</u>	32. <u>3</u>	33. <u>1</u>	34. <u>0</u> <u>4</u>	
4th	35. <u>3</u>	36. <u>Q</u>	37. <u>L</u>	38. <u>Z</u>	39. <u>J</u>	40. <u>3</u>	41. <u>5</u> <u>6</u>	42. <u>2</u>	43. <u>1</u>	44. <u>0</u> <u>3</u>	
5th	45. <u>3</u>	46. <u>A</u>	47. <u>L</u>	48. <u>F</u>	49. <u>S</u>	50. <u>2</u>	51. <u>2</u> <u>0</u>	52. <u>1</u>	53. <u>1</u>	54. <u>0</u> <u>1</u>	
6th	55. <u>3</u>	56. <u>M</u>	57. <u>U</u>	58. <u>U</u>	59. <u>U</u>	60. <u>7</u>	61. <u>9</u> <u>7</u>	62. <u>9</u>	63. <u>7</u>	64. <u>9</u> <u>9</u>	
7th	65. <u> </u>	66. <u> </u>	67. <u> </u>	68. <u> </u>	69. <u> </u>	70. <u> </u>	71. <u> </u> <u> </u>	72. <u> </u>	73. <u> </u>	74. <u> </u> <u> </u>	
8th	75. <u> </u>	76. <u> </u>	77. <u> </u>	78. <u> </u>	79. <u> </u>	80. <u> </u>	81. <u> </u> <u> </u>	82. <u> </u>	83. <u> </u>	84. <u> </u> <u> </u>	
9th	85. <u> </u>	86. <u> </u>	87. <u> </u>	88. <u> </u>	89. <u> </u>	90. <u> </u>	91. <u> </u> <u> </u>	92. <u> </u>	93. <u> </u>	94. <u> </u> <u> </u>	
10th	95. <u> </u>	96. <u> </u>	97. <u> </u>	98. <u> </u>	99. <u> </u>	100. <u> </u>	101. <u> </u> <u> </u>	102. <u> </u>	103. <u> </u>	104. <u> </u> <u> </u>	

Second Update Form Submission

INJURY DATA CODED ON INITIAL SUBMISSION												
Source of Injury Data	O.I.C.-A.I.S.						Injury Source	Injury Source Confidence Level	Direct/Indirect Injury	Occupant Area Intrusion No.		
	Body Region	Aspect	Lesion	System Organ	A.I.S. Severity							
1st	5. <u>3</u>	6. <u>C</u>	7. <u>L</u>	8. <u>F</u>	9. <u>S</u>	10. <u>4</u>	11. <u>2</u> <u>0</u>	12. <u>1</u>	13. <u>1</u>	14. <u>0</u> <u>1</u>		
2nd	15. <u>3</u>	16. <u>C</u>	17. <u>L</u>	18. <u>L</u>	19. <u>P</u>	20. <u>3</u>	21. <u>2</u> <u>0</u>	22. <u>1</u>	23. <u>1</u>	24. <u>0</u> <u>1</u>		
3rd	25. <u>3</u>	26. <u>H</u>	27. <u>W</u>	28. <u>K</u>	29. <u>B</u>	30. <u>2</u>	31. <u>2</u> <u>6</u>	32. <u>3</u>	33. <u>1</u>	34. <u>0</u> <u>4</u>		
4th	35. <u>3</u>	36. <u>Q</u>	37. <u>L</u>	38. <u>Z</u>	39. <u>J</u>	40. <u>3</u>	41. <u>5</u> <u>6</u>	42. <u>2</u>	43. <u>1</u>	44. <u>0</u> <u>3</u>		
5th	45. <u>3</u>	46. <u>A</u>	47. <u>L</u>	48. <u>F</u>	49. <u>S</u>	50. <u>2</u>	51. <u>2</u> <u>0</u>	52. <u>1</u>	53. <u>1</u>	54. <u>0</u> <u>1</u>		
6th	55. <u>3</u>	56. <u>M</u>	57. <u>U</u>	58. <u>U</u>	59. <u>U</u>	60. <u>7</u>	61. <u>9</u> <u>7</u>	62. <u>9</u>	63. <u>7</u>	64. <u>9</u> <u>9</u>		
7th	65. <u> </u>	66. <u> </u>	67. <u> </u>	68. <u> </u>	69. <u> </u>	70. <u> </u>	71. <u> </u> <u> </u>	72. <u> </u>	73. <u> </u>	74. <u> </u> <u> </u>		
8th	75. <u> </u>	76. <u> </u>	77. <u> </u>	78. <u> </u>	79. <u> </u>	80. <u> </u>	81. <u> </u> <u> </u>	82. <u> </u>	83. <u> </u>	84. <u> </u> <u> </u>		
9th	85. <u> </u>	86. <u> </u>	87. <u> </u>	88. <u> </u>	89. <u> </u>	90. <u> </u>	91. <u> </u> <u> </u>	92. <u> </u>	93. <u> </u>	94. <u> </u> <u> </u>		
10th	95. <u> </u>	96. <u> </u>	97. <u> </u>	98. <u> </u>	99. <u> </u>	100. <u> </u>	101. <u> </u> <u> </u>	102. <u> </u>	103. <u> </u>	104. <u> </u> <u> </u>		
11th	105. <u> </u>	106. <u> </u>	107. <u> </u>	108. <u> </u>	109. <u> </u>	110. <u> </u>	111. <u> </u> <u> </u>	112. <u> </u>	113. <u> </u>	114. <u> </u> <u> </u>		
12th	115. <u> </u>	116. <u> </u>	117. <u> </u>	118. <u> </u>	119. <u> </u>	120. <u> </u>	121. <u> </u> <u> </u>	122. <u> </u>	123. <u> </u>	124. <u> </u> <u> </u>		
13th	125. <u> </u>	126. <u> </u>	127. <u> </u>	128. <u> </u>	129. <u> </u>	130. <u> </u>	131. <u> </u> <u> </u>	132. <u> </u>	133. <u> </u>	134. <u> </u> <u> </u>		
14th	135. <u> </u>	136. <u> </u>	137. <u> </u>	138. <u> </u>	139. <u> </u>	140. <u> </u>	141. <u> </u> <u> </u>	142. <u> </u>	143. <u> </u>	144. <u> </u> <u> </u>		
15th	145. <u> </u>	146. <u> </u>	147. <u> </u>	148. <u> </u>	149. <u> </u>	150. <u> </u>	151. <u> </u> <u> </u>	152. <u> </u>	153. <u> </u>	154. <u> </u> <u> </u>		
16th	155. <u> </u>	156. <u> </u>	157. <u> </u>	158. <u> </u>	159. <u> </u>	160. <u> </u>	161. <u> </u> <u> </u>	162. <u> </u>	163. <u> </u>	164. <u> </u> <u> </u>		
17th	165. <u> </u>	166. <u> </u>	167. <u> </u>	168. <u> </u>	169. <u> </u>	170. <u> </u>	171. <u> </u> <u> </u>	172. <u> </u>	173. <u> </u>	174. <u> </u> <u> </u>		
18th	175. <u> </u>	176. <u> </u>	177. <u> </u>	178. <u> </u>	179. <u> </u>	180. <u> </u>	181. <u> </u> <u> </u>	182. <u> </u>	183. <u> </u>	184. <u> </u> <u> </u>		
19th	185. <u> </u>	186. <u> </u>	187. <u> </u>	188. <u> </u>	189. <u> </u>	190. <u> </u>	191. <u> </u> <u> </u>	192. <u> </u>	193. <u> </u>	194. <u> </u> <u> </u>		
20th	195. <u> </u>	196. <u> </u>	197. <u> </u>	198. <u> </u>	199. <u> </u>	200. <u> </u>	201. <u> </u> <u> </u>	202. <u> </u>	203. <u> </u>	204. <u> </u> <u> </u>		

Second Update Form Submission

INJURY DATA

Record below the actual injuries sustained by this occupant that were identified from the unofficial and official prior to initial case submission and from subsequently acquired medical data. Remember not to double count an injury just because it was identified from two different sources.

	Source of Injury Data	O.I.C.-A.I.S.					Injury Source	Injury Confidence Level	Direct/ Indirect Injury	Occupant Intrusion	Area No.
		Body Region	Aspect	Lesion	System Organ	A.I.S. Severity					
1st	5. <u>1</u>	6. <u>C</u>	7. <u>L</u>	8. <u>L</u>	9. <u>P</u>	10. <u>4</u>	11. <u>2</u> <u>0</u>	12. <u>1</u>	13. <u>1</u>	14. <u>0</u> <u>1</u>	
2nd	15. <u>1</u>	16. <u>H</u>	17. <u>W</u>	18. <u>K</u>	19. <u>B</u>	20. <u>4</u>	21. <u>7</u> <u>1</u>	22. <u>2</u>	23. <u>1</u>	24. <u>9</u> <u>7</u>	
3rd	25. <u>1</u>	26. <u>H</u>	27. <u>L</u>	28. <u>U</u>	29. <u>B</u>	30. <u>4</u>	31. <u>7</u> <u>1</u>	32. <u>2</u>	33. <u>1</u>	34. <u>9</u> <u>7</u>	
4th	35. <u>1</u>	36. <u>M</u>	37. <u>L</u>	38. <u>R</u>	39. <u>Q</u>	40. <u>5</u>	41. <u>2</u> <u>1</u>	42. <u>2</u>	43. <u>1</u>	44. <u>0</u> <u>1</u>	
5th	45. <u>1</u>	46. <u>C</u>	47. <u>B</u>	48. <u>F</u>	49. <u>S</u>	50. <u>4</u>	51. <u>2</u> <u>0</u>	52. <u>1</u>	53. <u>1</u>	54. <u>0</u> <u>1</u>	
6th	55. <u>1</u>	56. <u>H</u>	57. <u>I</u>	58. <u>F</u>	59. <u>S</u>	60. <u>3</u>	61. <u>7</u> <u>1</u>	62. <u>2</u>	63. <u>1</u>	64. <u>9</u> <u>7</u>	
7th	65. <u>1</u>	66. <u>A</u>	67. <u>L</u>	68. <u>F</u>	69. <u>S</u>	70. <u>3</u>	71. <u>2</u> <u>0</u>	72. <u>1</u>	73. <u>1</u>	74. <u>0</u> <u>1</u>	
8th	75. <u>2</u>	76. <u>Q</u>	77. <u>L</u>	78. <u>Z</u>	79. <u>J</u>	80. <u>3</u>	81. <u>5</u> <u>6</u>	82. <u>2</u>	83. <u>1</u>	84. <u>0</u> <u>3</u>	
9th	85. <u>1</u>	86. <u>O</u>	87. <u>A</u>	88. <u>L</u>	89. <u>I</u>	90. <u>1</u>	91. <u>8</u> <u>4</u>	92. <u>2</u>	93. <u>1</u>	94. <u>0</u> <u>0</u>	
10th	95. <u> </u>	96. <u> </u>	97. <u> </u>	98. <u> </u>	99. <u> </u>	100. <u> </u>	101. <u> </u> <u> </u>	102. <u> </u>	103. <u> </u>	104. <u> </u> <u> </u>	



INTERVIEW FORM

Primary Sampling Unit Number _____ Interviewee(s) Role(s) or Name(s) _____

Case Number – Stratum _____

Vehicle Number _____

Review the Interview Cue Sheet prior to conducting interview(s) to ensure the acquisition of all pertinent data.

GENERAL DESCRIPTION OF ACCIDENT SEQUENCE

SPECIFIC QUESTIONS

Key to Researcher: Have you obtained the following through the interviewee(s) description and specific questions?

- | | | |
|--|--|--|
| <input type="checkbox"/> PRE-CRASH, AT IMPACT
vehicle travel/driver intention | <input type="checkbox"/> Speed estimates (precrash/at
impact) | <input type="checkbox"/> Previous vehicle damage |
| <input type="checkbox"/> Direction of travel | <input type="checkbox"/> Post-impact trajectory | <input type="checkbox"/> Glazing type |
| <input type="checkbox"/> Avoidance maneuvers | <input type="checkbox"/> Door status (precrash/postcrash) | <input type="checkbox"/> Vehicle glazing status |
| <input type="checkbox"/> Impact description/orientation | <input type="checkbox"/> Final rest position | <input type="checkbox"/> PAR clarifications |
| | | <input type="checkbox"/> Glove box status |

Cargo? No Yes Interviewee's Estimated Cargo Weight _____

Description of Cargo _____

Present Location of Vehicle (if not yet inspected)?: _____

ACCIDENT DIAGRAM

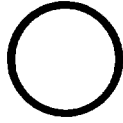

NORTH

The use of this diagram is *optional*. It may serve to aid in relating interviewee accident trajectory data (i.e. pre-impact to FRP orientations) to identifiable objects in the environment.

OCCUPANT DATA

Enter the occupant's seat position in the first row and complete the column below it using the information from the interviewee(s).

SEAT POSITION				
AGE/SEX				
HEIGHT (IN)				
WEIGHT (LBS.)				
POSTURE				
EJECTED? [] No [] Yes				
DESCRIBE THE EJECTION				
ENTRAPPED? [] No [] Yes				
DESCRIBE ENTRAPMENT				
DESCRIBE TYPE OF RESTRAINT				
WERE BELTS WORN? [] No [] Yes				
HOW WHERE THE BELTS WORN?				
DESCRIBE ANY RESTRAINT FAILURES				
TYPE OF TREATMENT				
NAME OF TREATMENT FACILITY				
DAYS IN HOSPITAL?				
NO. OF LOST WORK DAYS?				
WOULD YOU SIGN A MEDICAL RELEASE?				

OCCUPANT DATA

SEAT POSITION				
AGE/SEX				
HEIGHT (IN)				
WEIGHT (LBS.)				
POSTURE				
EJECTED? [] No [] Yes				
DESCRIBE THE EJECTION				
ENTRAPPED? [] No [] Yes				
DESCRIBE ENTRAPMENT				
DESCRIBE TYPE OF RESTRAINT				
WERE BELTS WORN? [] No [] Yes				
HOW WHERE THE BELTS WORN?				
DESCRIBE ANY RESTRAINT FAILURES				
TYPE OF TREATMENT				
NAME OF TREATMENT FACILITY				
DAYS IN HOSPITAL?				
NO. OF LOST WORK DAYS?				
WOULD YOU SIGN A MEDICAL RELEASE?				

PSU Number _____ Case Number—Stratum _____ Vehicle Number _____ Occupant Number _____

INJURY DATA FROM INTERVIEWEE(S)

Indicate the *Location, Lesion, Detail, and Source* of all injuries. Specify interviewee(s): _____

SOFT TISSUE/INTERNAL INJURIES

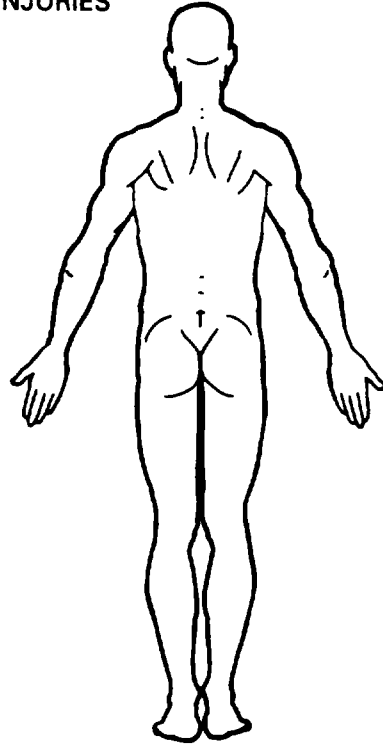
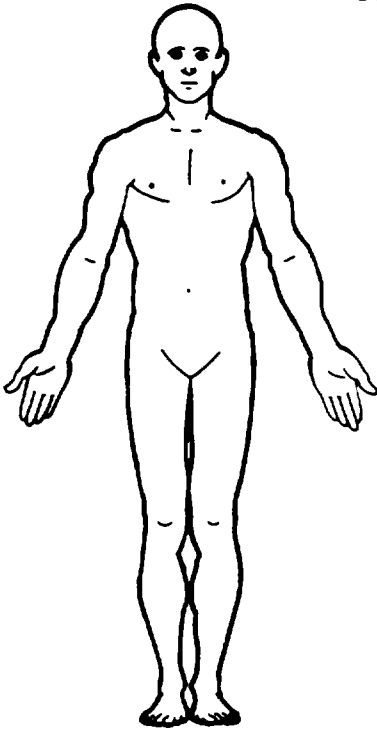

SKELETAL INJURIES

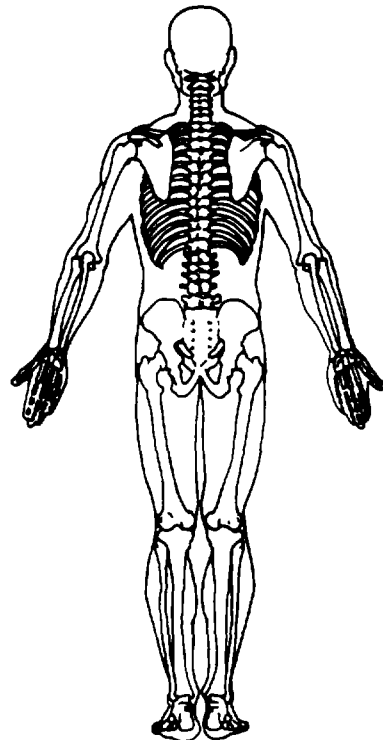
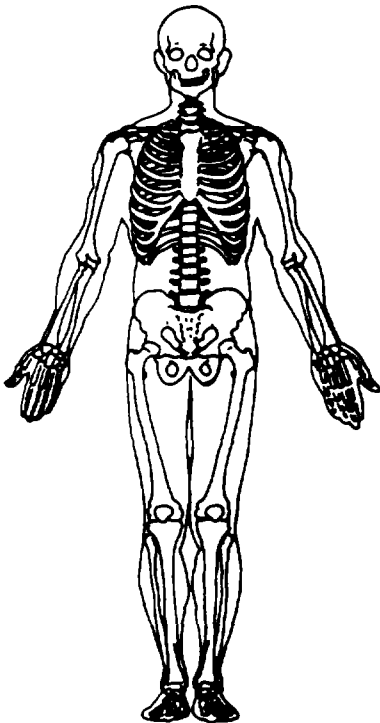

The space provided on the back of this page may be used to document injuries noted by the interviewee(s).

PSU Number _____ Case Number - Stratum _____ Vehicle Number _____ Occupant Number _____

INJURY DATA FROM INTERVIEWEE(S)

Indicate the *Location, Lesion, Detail, and Source* of all injuries. Specify interviewee(s): _____

SOFT TISSUE/INTERNAL INJURIES

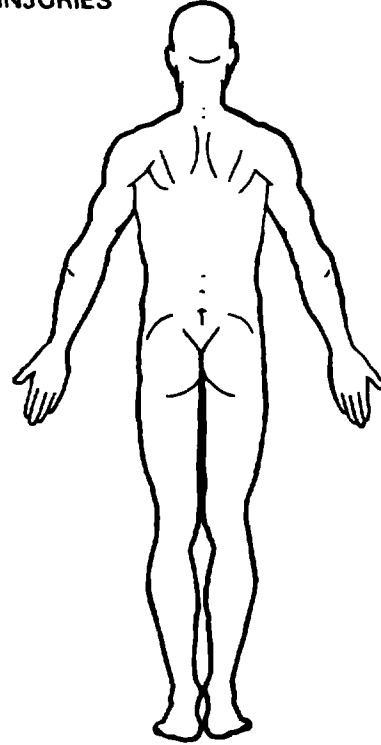
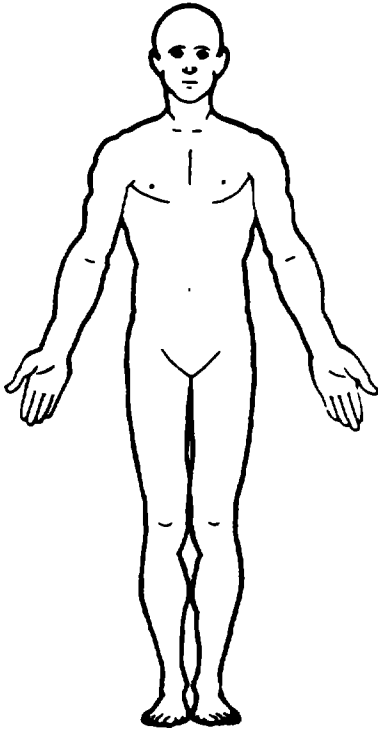

SKELETAL INJURIES

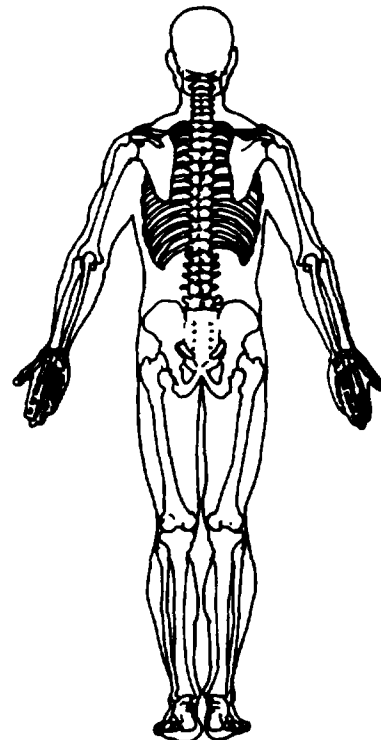
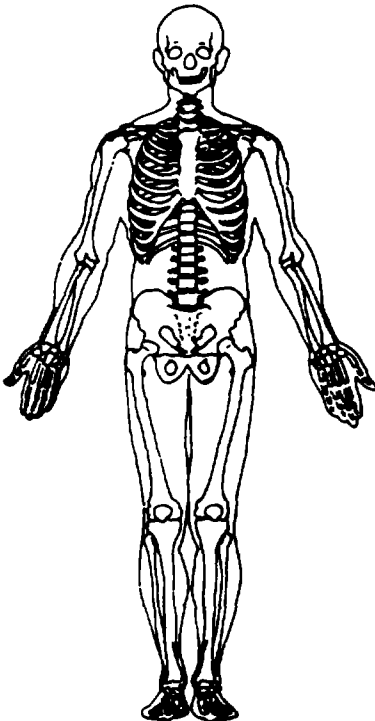

The space provided on the back of this page may be used to document injuries noted by the interviewee(s).

OCCUPANT INJURY DATA

Indicate the *Location, Lesion, Detail, and Source* of all injuries indicated by the interviewee(s).

	LOCATION (Body Region/Aspect/ System Organ)	LESION	DETAIL CONCERNING LESION	INJURY SOURCE
HEAD/ NECK				
CHEST/ BACK				
ABDOMEN PELVIS				
EXTREMITIES				
ADDITIONAL INJURIES				

PSU Number _____ Case Number—Stratum _____ Vehicle Number _____ Occupant Number _____

INJURY DATA FROM INTERVIEWEE(S)

Indicate the *Location, Lesion, Detail, and Source* of all injuries. Specify interviewee(s): _____

SOFT TISSUE/INTERNAL INJURIES

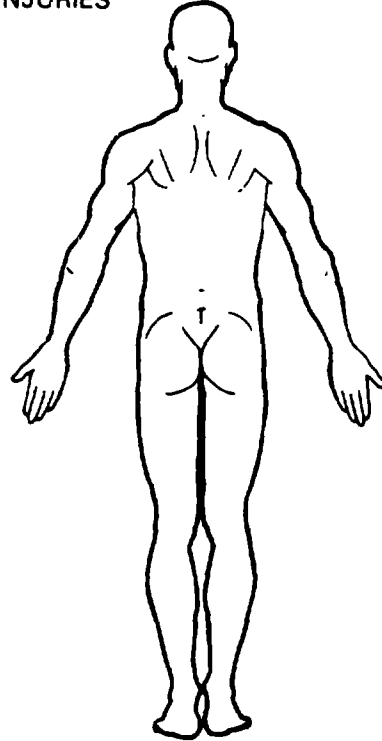
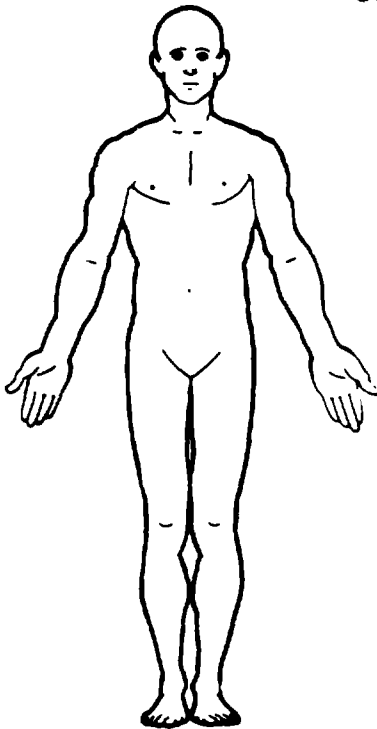

SKELETAL INJURIES

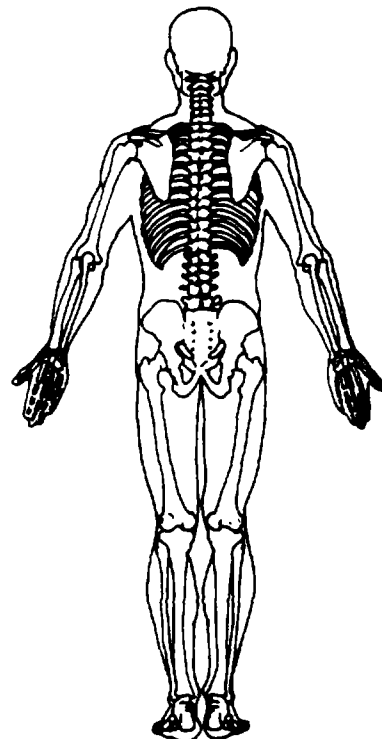
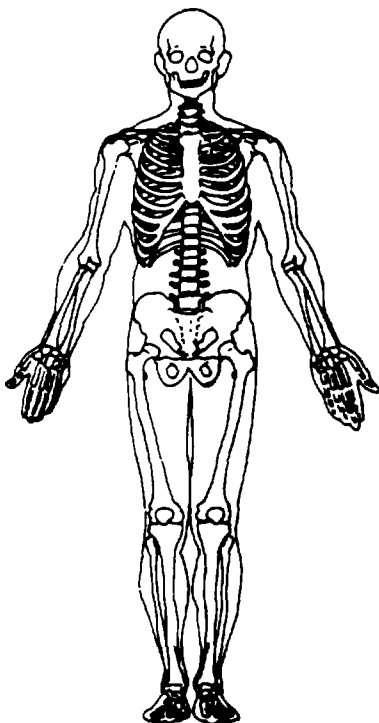

The space provided on the back of this page may be used to document injuries noted by the interviewee(s).

OCCUPANT INJURY DATA

Indicate the *Location, Lesion, Detail, and Source* of all injuries indicated by the interviewee(s).

	LOCATION (Body Region/Aspect/ System Organ)	LESION	DETAIL CONCERNING LESION	INJURY SOURCE
HEAD/ NECK				
CHEST/ BACK				
ABDOMEN PELVIS				
EXTREMITIES				
ADDITIONAL INJURIES				



CONTACT LOG

Performance Assessment

PSU Number _____	Vehicle Number _____																																																																																																																																																																																																																																																																																																																																																																																																																																																																	
Case Number-Stratum _____	Assigned Researcher Number _____																																																																																																																																																																																																																																																																																																																																																																																																																																																																	
VEHICLE INSPECTION	INTERVIEW																																																																																																																																																																																																																																																																																																																																																																																																																																																																	
<table border="1" style="width: 100%; border-collapse: collapse;"> <thead> <tr> <th style="width: 15%;">Date</th> <th style="width: 15%;">Time</th> <th style="width: 10%;">ID#</th> <th style="width: 10%;">Contact</th> <th style="width: 10%;">Manner</th> <th style="width: 10%;">Result</th> </tr> </thead> <tbody> <tr><td>___/___/___</td><td>__:__</td><td>---</td><td>---</td><td>---</td><td>---</td></tr> <tr><td>___/___/___</td><td>__:__</td><td>---</td><td>---</td><td>---</td><td>---</td></tr> <tr><td>___/___/___</td><td>__:__</td><td>---</td><td>---</td><td>---</td><td>---</td></tr> <tr><td>___/___/___</td><td>__:__</td><td>---</td><td>---</td><td>---</td><td>---</td></tr> <tr><td>___/___/___</td><td>__:__</td><td>---</td><td>---</td><td>---</td><td>---</td></tr> <tr><td>___/___/___</td><td>__:__</td><td>---</td><td>---</td><td>---</td><td>---</td></tr> <tr><td>___/___/___</td><td>__:__</td><td>---</td><td>---</td><td>---</td><td>---</td></tr> <tr><td>___/___/___</td><td>__:__</td><td>---</td><td>---</td><td>---</td><td>---</td></tr> <tr><td>___/___/___</td><td>__:__</td><td>---</td><td>---</td><td>---</td><td>---</td></tr> <tr><td>___/___/___</td><td>__:__</td><td>---</td><td>---</td><td>---</td><td>---</td></tr> <tr><td>___/___/___</td><td>__:__</td><td>---</td><td>---</td><td>---</td><td>---</td></tr> <tr><td>___/___/___</td><td>__:__</td><td>---</td><td>---</td><td>---</td><td>---</td></tr> <tr><td>___/___/___</td><td>__:__</td><td>---</td><td>---</td><td>---</td><td>---</td></tr> <tr><td>___/___/___</td><td>__:__</td><td>---</td><td>---</td><td>---</td><td>---</td></tr> <tr><td>___/___/___</td><td>__:__</td><td>---</td><td>---</td><td>---</td><td>---</td></tr> <tr><td>___/___/___</td><td>__:__</td><td>---</td><td>---</td><td>---</td><td>---</td></tr> <tr><td>___/___/___</td><td>__:__</td><td>---</td><td>---</td><td>---</td><td>---</td></tr> <tr><td>___/___/___</td><td>__:__</td><td>---</td><td>---</td><td>---</td><td>---</td></tr> <tr><td>___/___/___</td><td>__:__</td><td>---</td><td>---</td><td>---</td><td>---</td></tr> <tr><td>___/___/___</td><td>__:__</td><td>---</td><td>---</td><td>---</td><td>---</td></tr> <tr><td>___/___/___</td><td>__:__</td><td>---</td><td>---</td><td>---</td><td>---</td></tr> <tr><td>___/___/___</td><td>__:__</td><td>---</td><td>---</td><td>---</td><td>---</td></tr> </tbody> </table>	Date	Time	ID#	Contact	Manner	Result	___/___/___	__:__	---	---	---	---	___/___/___	__:__	---	---	---	---	___/___/___	__:__	---	---	---	---	___/___/___	__:__	---	---	---	---	___/___/___	__:__	---	---	---	---	___/___/___	__:__	---	---	---	---	___/___/___	__:__	---	---	---	---	___/___/___	__:__	---	---	---	---	___/___/___	__:__	---	---	---	---	___/___/___	__:__	---	---	---	---	___/___/___	__:__	---	---	---	---	___/___/___	__:__	---	---	---	---	___/___/___	__:__	---	---	---	---	___/___/___	__:__	---	---	---	---	___/___/___	__:__	---	---	---	---	___/___/___	__:__	---	---	---	---	___/___/___	__:__	---	---	---	---	___/___/___	__:__	---	---	---	---	___/___/___	__:__	---	---	---	---	___/___/___	__:__	---	---	---	---	___/___/___	__:__	---	---	---	---	___/___/___	__:__	---	---	---	---	<table border="1" style="width: 100%; border-collapse: collapse;"> <thead> <tr> <th colspan="6" style="text-align: center; padding: 5px;">DRIVER INTERVIEW</th> </tr> <tr> <th style="width: 15%;">Date</th> <th style="width: 15%;">Time</th> <th style="width: 10%;">ID#</th> <th style="width: 10%;">Contact</th> <th style="width: 10%;">Manner</th> <th style="width: 10%;">Result</th> </tr> </thead> <tbody> <tr><td>___/___/___</td><td>__:__</td><td>---</td><td>---</td><td>---</td><td>---</td></tr> <tr><td>___/___/___</td><td>__:__</td><td>---</td><td>---</td><td>---</td><td>---</td></tr> <tr><td>___/___/___</td><td>__:__</td><td>---</td><td>---</td><td>---</td><td>---</td></tr> <tr><td>___/___/___</td><td>__:__</td><td>---</td><td>---</td><td>---</td><td>---</td></tr> <tr><td>___/___/___</td><td>__:__</td><td>---</td><td>---</td><td>---</td><td>---</td></tr> <tr><td>___/___/___</td><td>__:__</td><td>---</td><td>---</td><td>---</td><td>---</td></tr> <tr><td>___/___/___</td><td>__:__</td><td>---</td><td>---</td><td>---</td><td>---</td></tr> <tr><td>___/___/___</td><td>__:__</td><td>---</td><td>---</td><td>---</td><td>---</td></tr> <tr><td>___/___/___</td><td>__:__</td><td>---</td><td>---</td><td>---</td><td>---</td></tr> <tr><td>___/___/___</td><td>__:__</td><td>---</td><td>---</td><td>---</td><td>---</td></tr> <tr><td>___/___/___</td><td>__:__</td><td>---</td><td>---</td><td>---</td><td>---</td></tr> <tr><td>___/___/___</td><td>__:__</td><td>---</td><td>---</td><td>---</td><td>---</td></tr> <tr><td>___/___/___</td><td>__:__</td><td>---</td><td>---</td><td>---</td><td>---</td></tr> <tr><td>___/___/___</td><td>__:__</td><td>---</td><td>---</td><td>---</td><td>---</td></tr> <tr><td>___/___/___</td><td>__:__</td><td>---</td><td>---</td><td>---</td><td>---</td></tr> <tr><td>___/___/___</td><td>__:__</td><td>---</td><td>---</td><td>---</td><td>---</td></tr> <tr><td>___/___/___</td><td>__:__</td><td>---</td><td>---</td><td>---</td><td>---</td></tr> <tr><td>___/___/___</td><td>__:__</td><td>---</td><td>---</td><td>---</td><td>---</td></tr> <tr><td>___/___/___</td><td>__:__</td><td>---</td><td>---</td><td>---</td><td>---</td></tr> <tr><td>___/___/___</td><td>__:__</td><td>---</td><td>---</td><td>---</td><td>---</td></tr> <tr><td>___/___/___</td><td>__:__</td><td>---</td><td>---</td><td>---</td><td>---</td></tr> <tr><td>___/___/___</td><td>__:__</td><td>---</td><td>---</td><td>---</td><td>---</td></tr> </tbody> </table> <table border="1" style="width: 100%; border-collapse: collapse;"> <thead> <tr> <th colspan="6" style="text-align: center; padding: 5px;">OCCUPANT INTERVIEW</th> </tr> <tr> <th style="width: 5%;">Occ No</th> <th style="width: 15%;">Date</th> <th style="width: 15%;">Time</th> <th style="width: 10%;">ID#</th> <th style="width: 10%;">Contact</th> <th style="width: 10%;">Manner</th> <th style="width: 10%;">Result</th> </tr> </thead> <tbody> <tr><td>---</td><td>___/___/___</td><td>__:__</td><td>---</td><td>---</td><td>---</td><td>---</td></tr> <tr><td>---</td><td>___/___/___</td><td>__:__</td><td>---</td><td>---</td><td>---</td><td>---</td></tr> <tr><td>---</td><td>___/___/___</td><td>__:__</td><td>---</td><td>---</td><td>---</td><td>---</td></tr> <tr><td>---</td><td>___/___/___</td><td>__:__</td><td>---</td><td>---</td><td>---</td><td>---</td></tr> <tr><td>---</td><td>___/___/___</td><td>__:__</td><td>---</td><td>---</td><td>---</td><td>---</td></tr> <tr><td>---</td><td>___/___/___</td><td>__:__</td><td>---</td><td>---</td><td>---</td><td>---</td></tr> <tr><td>---</td><td>___/___/___</td><td>__:__</td><td>---</td><td>---</td><td>---</td><td>---</td></tr> <tr><td>---</td><td>___/___/___</td><td>__:__</td><td>---</td><td>---</td><td>---</td><td>---</td></tr> <tr><td>---</td><td>___/___/___</td><td>__:__</td><td>---</td><td>---</td><td>---</td><td>---</td></tr> <tr><td>---</td><td>___/___/___</td><td>__:__</td><td>---</td><td>---</td><td>---</td><td>---</td></tr> <tr><td>---</td><td>___/___/___</td><td>__:__</td><td>---</td><td>---</td><td>---</td><td>---</td></tr> <tr><td>---</td><td>___/___/___</td><td>__:__</td><td>---</td><td>---</td><td>---</td><td>---</td></tr> <tr><td>---</td><td>___/___/___</td><td>__:__</td><td>---</td><td>---</td><td>---</td><td>---</td></tr> <tr><td>---</td><td>___/___/___</td><td>__:__</td><td>---</td><td>---</td><td>---</td><td>---</td></tr> <tr><td>---</td><td>___/___/___</td><td>__:__</td><td>---</td><td>---</td><td>---</td><td>---</td></tr> <tr><td>---</td><td>___/___/___</td><td>__:__</td><td>---</td><td>---</td><td>---</td><td>---</td></tr> <tr><td>---</td><td>___/___/___</td><td>__:__</td><td>---</td><td>---</td><td>---</td><td>---</td></tr> <tr><td>---</td><td>___/___/___</td><td>__:__</td><td>---</td><td>---</td><td>---</td><td>---</td></tr> <tr><td>---</td><td>___/___/___</td><td>__:__</td><td>---</td><td>---</td><td>---</td><td>---</td></tr> <tr><td>---</td><td>___/___/___</td><td>__:__</td><td>---</td><td>---</td><td>---</td><td>---</td></tr> <tr><td>---</td><td>___/___/___</td><td>__:__</td><td>---</td><td>---</td><td>---</td><td>---</td></tr> <tr><td>---</td><td>___/___/___</td><td>__:__</td><td>---</td><td>---</td><td>---</td><td>---</td></tr> </tbody> </table>	DRIVER INTERVIEW						Date	Time	ID#	Contact	Manner	Result	___/___/___	__:__	---	---	---	---	___/___/___	__:__	---	---	---	---	___/___/___	__:__	---	---	---	---	___/___/___	__:__	---	---	---	---	___/___/___	__:__	---	---	---	---	___/___/___	__:__	---	---	---	---	___/___/___	__:__	---	---	---	---	___/___/___	__:__	---	---	---	---	___/___/___	__:__	---	---	---	---	___/___/___	__:__	---	---	---	---	___/___/___	__:__	---	---	---	---	___/___/___	__:__	---	---	---	---	___/___/___	__:__	---	---	---	---	___/___/___	__:__	---	---	---	---	___/___/___	__:__	---	---	---	---	___/___/___	__:__	---	---	---	---	___/___/___	__:__	---	---	---	---	___/___/___	__:__	---	---	---	---	___/___/___	__:__	---	---	---	---	___/___/___	__:__	---	---	---	---	___/___/___	__:__	---	---	---	---	___/___/___	__:__	---	---	---	---	OCCUPANT INTERVIEW						Occ No	Date	Time	ID#	Contact	Manner	Result	---	___/___/___	__:__	---	---	---	---	---	___/___/___	__:__	---	---	---	---	---	___/___/___	__:__	---	---	---	---	---	___/___/___	__:__	---	---	---	---	---	___/___/___	__:__	---	---	---	---	---	___/___/___	__:__	---	---	---	---	---	___/___/___	__:__	---	---	---	---	---	___/___/___	__:__	---	---	---	---	---	___/___/___	__:__	---	---	---	---	---	___/___/___	__:__	---	---	---	---	---	___/___/___	__:__	---	---	---	---	---	___/___/___	__:__	---	---	---	---	---	___/___/___	__:__	---	---	---	---	---	___/___/___	__:__	---	---	---	---	---	___/___/___	__:__	---	---	---	---	---	___/___/___	__:__	---	---	---	---	---	___/___/___	__:__	---	---	---	---	---	___/___/___	__:__	---	---	---	---	---	___/___/___	__:__	---	---	---	---	---	___/___/___	__:__	---	---	---	---	---	___/___/___	__:__	---	---	---	---	---	___/___/___	__:__	---	---	---	---
Date	Time	ID#	Contact	Manner	Result																																																																																																																																																																																																																																																																																																																																																																																																																																																													
___/___/___	__:__	---	---	---	---																																																																																																																																																																																																																																																																																																																																																																																																																																																													
___/___/___	__:__	---	---	---	---																																																																																																																																																																																																																																																																																																																																																																																																																																																													
___/___/___	__:__	---	---	---	---																																																																																																																																																																																																																																																																																																																																																																																																																																																													
___/___/___	__:__	---	---	---	---																																																																																																																																																																																																																																																																																																																																																																																																																																																													
___/___/___	__:__	---	---	---	---																																																																																																																																																																																																																																																																																																																																																																																																																																																													
___/___/___	__:__	---	---	---	---																																																																																																																																																																																																																																																																																																																																																																																																																																																													
___/___/___	__:__	---	---	---	---																																																																																																																																																																																																																																																																																																																																																																																																																																																													
___/___/___	__:__	---	---	---	---																																																																																																																																																																																																																																																																																																																																																																																																																																																													
___/___/___	__:__	---	---	---	---																																																																																																																																																																																																																																																																																																																																																																																																																																																													
___/___/___	__:__	---	---	---	---																																																																																																																																																																																																																																																																																																																																																																																																																																																													
___/___/___	__:__	---	---	---	---																																																																																																																																																																																																																																																																																																																																																																																																																																																													
___/___/___	__:__	---	---	---	---																																																																																																																																																																																																																																																																																																																																																																																																																																																													
___/___/___	__:__	---	---	---	---																																																																																																																																																																																																																																																																																																																																																																																																																																																													
___/___/___	__:__	---	---	---	---																																																																																																																																																																																																																																																																																																																																																																																																																																																													
___/___/___	__:__	---	---	---	---																																																																																																																																																																																																																																																																																																																																																																																																																																																													
___/___/___	__:__	---	---	---	---																																																																																																																																																																																																																																																																																																																																																																																																																																																													
___/___/___	__:__	---	---	---	---																																																																																																																																																																																																																																																																																																																																																																																																																																																													
___/___/___	__:__	---	---	---	---																																																																																																																																																																																																																																																																																																																																																																																																																																																													
___/___/___	__:__	---	---	---	---																																																																																																																																																																																																																																																																																																																																																																																																																																																													
___/___/___	__:__	---	---	---	---																																																																																																																																																																																																																																																																																																																																																																																																																																																													
___/___/___	__:__	---	---	---	---																																																																																																																																																																																																																																																																																																																																																																																																																																																													
___/___/___	__:__	---	---	---	---																																																																																																																																																																																																																																																																																																																																																																																																																																																													
DRIVER INTERVIEW																																																																																																																																																																																																																																																																																																																																																																																																																																																																		
Date	Time	ID#	Contact	Manner	Result																																																																																																																																																																																																																																																																																																																																																																																																																																																													
___/___/___	__:__	---	---	---	---																																																																																																																																																																																																																																																																																																																																																																																																																																																													
___/___/___	__:__	---	---	---	---																																																																																																																																																																																																																																																																																																																																																																																																																																																													
___/___/___	__:__	---	---	---	---																																																																																																																																																																																																																																																																																																																																																																																																																																																													
___/___/___	__:__	---	---	---	---																																																																																																																																																																																																																																																																																																																																																																																																																																																													
___/___/___	__:__	---	---	---	---																																																																																																																																																																																																																																																																																																																																																																																																																																																													
___/___/___	__:__	---	---	---	---																																																																																																																																																																																																																																																																																																																																																																																																																																																													
___/___/___	__:__	---	---	---	---																																																																																																																																																																																																																																																																																																																																																																																																																																																													
___/___/___	__:__	---	---	---	---																																																																																																																																																																																																																																																																																																																																																																																																																																																													
___/___/___	__:__	---	---	---	---																																																																																																																																																																																																																																																																																																																																																																																																																																																													
___/___/___	__:__	---	---	---	---																																																																																																																																																																																																																																																																																																																																																																																																																																																													
___/___/___	__:__	---	---	---	---																																																																																																																																																																																																																																																																																																																																																																																																																																																													
___/___/___	__:__	---	---	---	---																																																																																																																																																																																																																																																																																																																																																																																																																																																													
___/___/___	__:__	---	---	---	---																																																																																																																																																																																																																																																																																																																																																																																																																																																													
___/___/___	__:__	---	---	---	---																																																																																																																																																																																																																																																																																																																																																																																																																																																													
___/___/___	__:__	---	---	---	---																																																																																																																																																																																																																																																																																																																																																																																																																																																													
___/___/___	__:__	---	---	---	---																																																																																																																																																																																																																																																																																																																																																																																																																																																													
___/___/___	__:__	---	---	---	---																																																																																																																																																																																																																																																																																																																																																																																																																																																													
___/___/___	__:__	---	---	---	---																																																																																																																																																																																																																																																																																																																																																																																																																																																													
___/___/___	__:__	---	---	---	---																																																																																																																																																																																																																																																																																																																																																																																																																																																													
___/___/___	__:__	---	---	---	---																																																																																																																																																																																																																																																																																																																																																																																																																																																													
___/___/___	__:__	---	---	---	---																																																																																																																																																																																																																																																																																																																																																																																																																																																													
___/___/___	__:__	---	---	---	---																																																																																																																																																																																																																																																																																																																																																																																																																																																													
OCCUPANT INTERVIEW																																																																																																																																																																																																																																																																																																																																																																																																																																																																		
Occ No	Date	Time	ID#	Contact	Manner	Result																																																																																																																																																																																																																																																																																																																																																																																																																																																												
---	___/___/___	__:__	---	---	---	---																																																																																																																																																																																																																																																																																																																																																																																																																																																												
---	___/___/___	__:__	---	---	---	---																																																																																																																																																																																																																																																																																																																																																																																																																																																												
---	___/___/___	__:__	---	---	---	---																																																																																																																																																																																																																																																																																																																																																																																																																																																												
---	___/___/___	__:__	---	---	---	---																																																																																																																																																																																																																																																																																																																																																																																																																																																												
---	___/___/___	__:__	---	---	---	---																																																																																																																																																																																																																																																																																																																																																																																																																																																												
---	___/___/___	__:__	---	---	---	---																																																																																																																																																																																																																																																																																																																																																																																																																																																												
---	___/___/___	__:__	---	---	---	---																																																																																																																																																																																																																																																																																																																																																																																																																																																												
---	___/___/___	__:__	---	---	---	---																																																																																																																																																																																																																																																																																																																																																																																																																																																												
---	___/___/___	__:__	---	---	---	---																																																																																																																																																																																																																																																																																																																																																																																																																																																												
---	___/___/___	__:__	---	---	---	---																																																																																																																																																																																																																																																																																																																																																																																																																																																												
---	___/___/___	__:__	---	---	---	---																																																																																																																																																																																																																																																																																																																																																																																																																																																												
---	___/___/___	__:__	---	---	---	---																																																																																																																																																																																																																																																																																																																																																																																																																																																												
---	___/___/___	__:__	---	---	---	---																																																																																																																																																																																																																																																																																																																																																																																																																																																												
---	___/___/___	__:__	---	---	---	---																																																																																																																																																																																																																																																																																																																																																																																																																																																												
---	___/___/___	__:__	---	---	---	---																																																																																																																																																																																																																																																																																																																																																																																																																																																												
---	___/___/___	__:__	---	---	---	---																																																																																																																																																																																																																																																																																																																																																																																																																																																												
---	___/___/___	__:__	---	---	---	---																																																																																																																																																																																																																																																																																																																																																																																																																																																												
---	___/___/___	__:__	---	---	---	---																																																																																																																																																																																																																																																																																																																																																																																																																																																												
---	___/___/___	__:__	---	---	---	---																																																																																																																																																																																																																																																																																																																																																																																																																																																												
---	___/___/___	__:__	---	---	---	---																																																																																																																																																																																																																																																																																																																																																																																																																																																												
---	___/___/___	__:__	---	---	---	---																																																																																																																																																																																																																																																																																																																																																																																																																																																												
---	___/___/___	__:__	---	---	---	---																																																																																																																																																																																																																																																																																																																																																																																																																																																												
<p>CONTACT</p> <ul style="list-style-type: none"> (1) Owner / driver (2) Towyard (3) Repair facility (4) Salvage yard (5) Police (6) Insurance company (7) Attorney (8) Other (specify) _____ 	<p>CONTACT</p> <ul style="list-style-type: none"> (0) No interview (1) Driver (2) Other occupant (3) Relative or friend (4) Multiple interviewees from above categories (specify): _____ 																																																																																																																																																																																																																																																																																																																																																																																																																																																																	
<p>MANNER</p> <ul style="list-style-type: none"> (1) Telephone (2) In-person (3) Questionnaire (4) Other (specify) _____ 	<p>MANNER</p> <ul style="list-style-type: none"> (0) Vehicle not occupied (1) Telephone (2) In-person (3) Questionnaire 																																																																																																																																																																																																																																																																																																																																																																																																																																																																	
<p>RESULT</p> <ul style="list-style-type: none"> (1) Complete inspection (2) Partial inspection (3) Refusal (4) Vehicle moved to known location (5) Vehicle moved to unknown location (6) Vehicle located, no permission to inspect (7) Vehicle repaired (8) No answer / not home (9) Other (specify) _____ 	<p>RESULT</p> <ul style="list-style-type: none"> (01) Unable to contact or locate (02) Hit and run (03) Fatal—surrogate not available (04) In intensive care—surrogate not available (05) Out-of-state resident (06) Refused interview (07) Insurance company refusal (08) Attorney refusal or litigation (09) No return or questionnaire (10) Other (specify): _____ (11) Return of completed questionnaire (12) Partial interview (13) Complete interview 																																																																																																																																																																																																																																																																																																																																																																																																																																																																	

INTERVIEW FORM

Before completing the Interview Form make sure that the interviewee(s) have been clearly identified, including their relationship to the vehicle's driver. For example, "driver" is sufficient. On the other hand, "other occupant" needs further clarification if three or more persons were present in the vehicle. In general, if a surrogate is used, then both name and relationship must be indicated.

Review the Interview Cue Sheet (see material at the end of this section) prior to conducting your interview to ensure the acquisition of all pertinent data.

General Description of Accident Sequence

Let the interviewee tell you what happened. Refrain from interrupting the interviewee's train-of-thought. Let the interviewee finish, then returned with follow-up questions to areas of the accident sequence that are unclear.

Write legibly. Record faithfully the interviewee's response even when it disagrees with information and/or evidence that you have already acquired (e.g., from the vehicle and/or scene inspection).

Query the interviewee on all crashworthiness issues. See the SPECIFIC QUESTIONS section below for a checklist of topics which require attention. If this interviewee's vehicle was involved in the accident sequence in a manner which makes it applicable to the trajectory algorithm of the CRASHPC program, then interview so that particular attention is paid to accident details which would help you identify both its impact and final rest locations. Although it is desirable to locate both impact and final rest exactly, it is not necessary. The reasonable approximation of these locations based on accident dynamics and scene evidence enables you to run the trajectory algorithm and compare the results with those obtained through the damage algorithm of the CRASHPC program. Interviewee(s) many times know their pre-impact location, intended movements, and pre-crash avoidance behavior and can sometimes locate their vehicle at final rest relative to fixed objects in the environment (e.g., curb, tree, pole, etc.). Police measurements can also be used to approximate the vehicle's final rest position.

As a researcher, your job is to pull together the fragments of information [i.e., scene, vehicle, medical, interviewee(s)] and to test them against one another before constructing a coherent, plausible explanation for their occurrence.

Specific Questions

Researchers have the opportunity to write down prior to conducting their interview specific questions which the interviewee should be asked. For example, during the vehicle inspection, you may have discovered areas of damage that you do not think are related to this accident. Inquiring of the interviewee concerning their preexistence is a straightforward task. This area also serves to remind the researcher of specific crashworthiness related concerns that need to be clarified. As a subject is covered, place a checkmark in the brackets which precede the key phrase and briefly annotate what the interviewee tells you.

Specific Questions -- Continued

When discussing vehicular cargo, it is important to remember that the objective is to discern the additional weight in the vehicle that must be added to the vehicle's curb and passenger weights prior to using a vehicle weight value in an appropriate reconstruction program. The description of the cargo is only necessary to the extent that the interviewee does not know the weight of the cargo. In the absence of a known weight, use the description to try to ascertain the approximate cargo weight. Do not forget to use weight ranges when trying to learn the approximate cargo weight. By suggesting to the interviewee weight brackets (e.g., 100 to 500 pounds, 150 to 400 pounds, etc.), you may be able to narrow the focus to a reasonable approximation that can subsequently be used.

Accident Diagram

Although the use of this diagram is optional, it can be of particular help during an in-person interview. Oftentimes the researcher has visited the scene prior to conducting the interview. Using your knowledge of the scene, you can pre-sketch the scene on this page. During the interview, you may confirm with the interviewee the accuracy of your sketch while simultaneously refreshing the interviewee's recollection of the scene by means of your visual aid. In addition, you may also assist the interviewee in recalling and reporting the accident sequence by using miniature vehicles (e.g., Matchbox) on the sketch. Have the interviewee describe or show you how the vehicle(s) moved during the accident. This technique may sometimes reveal new insights into the accident dynamics. In addition, you may be able to obtain a good locational fix regarding the vehicle's final rest position. The ability to visualize the process may stimulate recollection.

Occupant Data

Complete and accurate information in this section is essential in order to correctly complete the Occupant Assessment Form. Information must be obtained for each occupant in the vehicle.

Seat Position: In most instances writing down the position number is sufficient; however, if an occupant is assigned seating positions "14", "15", "24", "25", etc., then write in the space available exactly how the occupant was positioned in the vehicle (e.g., sitting on the lap of the front-right passenger, sitting side-by-side with Occupant Number ## in the rear-left seating area, kneeling on the seat in the rear-center seating position, etc.).

Posture: Abnormal posture will most likely go undetected unless properly queried during the interview. Researchers must be familiar with the coding manual list (see variable OAll, Occupant Posture) of abnormal postures.

Ejected?: It is important to remember that partial ejection is just as much of interest as complete ejection. It is much easier to detect complete ejection than it is partial ejection because the body part that was ejected from the vehicle during a partial ejection may have originally been completely inside the vehicle prior to the accident and at final rest. Only with proper interviewing can researchers inquire and ascertain whether or not a body component was ejected from the vehicle sometime during the collision sequence.

Occupant Data -- Continued

Entrapped?: The NASS CDS concept of entrapment goes beyond the ordinary meaning of the term in everyday usage. To be entrapped, a person must be directly mechanically restrained by a damaged vehicle component. Clearly in order to correctly assess this concept no key word will be sufficient (i.e., trapped, pinned, etc.). Be sure to adequately explain to the interviewee what NASS is trying to measure and clearly describe the entrapment in the appropriate space on the form.

Describe Type of Restraint: With both automatic and manual belts available and some occupant positions equipped with one of each (i.e., manual lap and automatic shoulder), determining the type of restraint is not always straightforward. When no vehicle inspection occurs, the researcher's ability to probe for the subtle differences between the two different types can make the difference.

How Were the Belts Worn?: Occasionally a medical record will suggest that the occupant was not wearing a belt properly, but more often than not, making this determination will depend upon good interviewing. Researchers must be aware of the potential ways that belts can be misused (e.g., under the arm, around the arm, on the abdomen, behind the back, multiple occupants).

Type of Treatment: The issue in this question involves, first, whether or not the occupant died as a result of the accident--see OA35, Treatment - Mortality, and second, if the occupant survived, whether or not the occupant was given any medical treatment. If the surviving occupant was treated, then determine where the treatment occurred, how promptly it occurred, and whether or not the occupant required admission to a hospital. If the occupant died within thirty (30) days of the accident as a result of injuries sustained in the accident, then write "Fatal". If the occupant died as a result of a disease condition (e.g., stroke, heart attack) that the interviewee tells you occurred prior to the accident, then write "Fatal - ruled disease". When the occupant lives more than thirty days, then consider the occupant as a survivor and obtain the "treatment" information described above.

No treatment could have resulted because the occupant was not injured. If this occurs, then write "not injured". If the occupant refuses medical treatment at the scene or at a medical facility, then write "no treatment". If, subsequently, the occupant self-administers treatment or is treated by a relative or friend (nonphysician), then write "self-treatment".

The location of the treatment could have been at one or more sites. If the treatment only occurred at the scene, then write "at scene". If the treatment included a visit to a private physician's office or medical clinic but did not include any treatment at a hospital emergency room, then write either "private physician" or "medical clinic". If the occupant went somewhere from the scene and subsequently decided to be checked over at a medical facility, then write "treatment later". Finally, if the occupant was taken from the scene (the means of transportation is not a consideration, only the directness) directly to a hospital or trauma center, then determine whether or not admission occurred.

Occupant Data: Type of Treatment -- Continued

When the treatment occurred in a hospital emergency room, the occupant was subsequently either released and sent home or admitted. The admission may have been for an observation period or may have occurred when the decision was made to take the occupant to surgery. Once admitted, the occupant may have been sent to an intensive care unit or to a hospital room. If the occupant was sent home, then write "transported and released". If the occupant was admitted (regardless of the reason and regardless of the directness of the transportation), then write "hospitalized".

Name of Treatment Facility: When the occupant was treated at a medical facility determine the facility's name. Some police accident reports list the name of medical facilities to which persons are transported; however, in many instances, the named facilities are wrong or did not receive a specific occupant under consideration. Determining the facility's name during the interview can save subsequent backtracking.

No. of Lost Work Days?: The interviewee is almost the sole source for this information. Instead of giving-up when the interviewee says "unknown", attempt to give the interviewee a broad range (e.g., "1 to 5 weeks"). When a positive response is obtained, narrow the range as much as possible. If the range can be narrowed to a week, then use the average (e.g., "2 to 3 weeks" = 13 days).

Would You Sign A Medical Release?: This question concerns the obtaining of authorization to acquire a patient's medical records. Before asking this question, make sure the interviewee is 18 years old (i.e. the applicable legal age in your state), a parent or guardian, or an agent of the injured occupant (e.g., lawyer). If the interviewee is a surrogate for the occupant under consideration, then, unless the surrogate is a parent, guardian, or agent, determine when you can speak to the occupant. If the interviewee has the authority to release his/her medical records, then this question must be asked any time the occupant is taken to a medical facility which: (1) requires a signed medical release in order to obtain medical records or (2) where the current cooperative relationship does not allow post-ER medical records to be obtained. In addition, ask this question whenever the medical records obtained from your current cooperative relationship (i.e., with the medical facility), for all practical purposes, provide little or no information.

Note: Instead of asking "Will you sign a medical release?", use the following (or similar) introduction and question.

"We record your injuries and what parts of the car's interior you hit. This information is used by safety engineers and vehicle manufacturers to redesign vehicle interiors so they are more safe and less injury producing. May I get your signed authorization to obtain a copy of your medical records so I may see how the hospital described your injuries using precise medical terms?"

Injury Data From Interviewee(s)

Probing is the key to completing page 3 of the Interview Form. Lacerations, contusions, abrasions, and avulsions require the length/area of the lesion in order to accurately code the injury. Lacerations and avulsions also require a depth criterion. Muscle and tendon injuries are recorded on the top diagrams while joint and ligament injuries are located on the bottom diagrams. No injury description is complete unless the O.I.C. Body Region, Aspect, Lesion, and System/Organ and A.I.S. can be correctly coded based upon the description. Arrows drawn to body parts are not clearly indicative of what system/organ and sometimes body region was injured. The injury annotation must indicate precisely the four O.I.C. variables. Also, determining the source of the injury is important. Ask the interviewee, "What did you strike that caused the injury"? Draw a line under the injury description and annotate the source of the injury as described by the interviewee. If the interviewee does not know the source of the injury, then annotate "unknown" under the injury.

INTERVIEW CUE SHEET

ACCIDENT SEQUENCE RELATED DATA

- o What direction were you travelling?
- o Could you estimate your travel speed?
- o Did your vehicle rotate prior to the impact? If yes, was it clockwise (CW) or counterclockwise (CCW)?
- o Were you intending to turn or go straight ahead (i.e., change lanes, stop, etc.)?
- o Were you able to take any action to avoid the accident? [List what actions.]
- o Could you estimate your speed at the time of the impact?
- o What was the location and position of your vehicle at the time of the impact (i.e., which lane, headed which direction, etc.)?
- o Where on your vehicle was the first impact (or any subsequent impacts) located?
- o Please describe the movement of your vehicle from the first impact to the point at which it stopped.
- o Where did your vehicle come to a stop? [Get heading direction, and position relative to fixed object in environment.]
- o How many people were in the vehicle?
- o Was there any previous damage to the vehicle?
- o Do you recall hitting any of the windows? If so, list which ones.
- o Did any of the doors, hatch, or tailgate open during the impact? If so, list which ones.
- o Did the glove compartment door come open as a result of impact?
- o Was there anything in the vehicle that would have added 50 pounds or more to its weight (e.g., such as groceries, tools, etc.)? If so, describe cargo.

OCCUPANT DATA

General Information

- o Describe where and how you were sitting in the vehicle (i.e., lying, standing, reclining, out of position).
- o What gender is occupant? (Use with surrogate source.)
- o What was your age at the time of the accident?
- o What is your height?
- o What was your weight at the time of the accident?

Ejection/Entrapment Data

- o Was a part or all of your body thrown out of the vehicle?
 - Through what part of the vehicle were you thrown out?
 - Was it open or closed at the time?
- o Was the vehicle damaged such that you could not move a part or all of your body? [Ask for explanation.]

Restraint Data

- o Was there an air bag or automatic (passive) type of seatbelt available to you in your seat position?
 - What type was it?
 - Was it working properly before the collision (i.e., disconnected, not reinstalled, cut out)?
 - Did the device operate properly? [If not, ask for explanation.]
- o Was there a lap or shoulder belt available to you in your seat position?
 - Describe how you were wearing the belt (i.e., up on abdomen, under arm, behind back, two or more persons).
 - Was it working properly before the collision (i.e., removed, cut out, destroyed)?
 - Did the belt fail? [Provide examples of failure to the interviewee.]
 - If belt did fail, have the interviewee describe the failure.
- o If no belt, was the belt removed or destroyed?
- o Was a child safety seat used?
 - What was the make/model and type of seat (i.e., infant, toddler, convertible, booster)?
 - What direction was it facing?
 - Was a harness, a shield, or a tether used with the seat? [List which ones.]
 - Were they an addition to (i.e., add-on) the original seat?
 - Were they used?

Seat Data

- o What type of seat were you sitting in (i.e., bucket, bench, pedestal, split bench)?
 - Did the seat back fold down?
 - Was the bench split or solid?
 - Did the bench have separate cushions?
- o Did the seat fail or deform? [Define for interviewee.] If yes, have interviewee describe.
- o Was there a head restraint on your seat?
 - What type was it (i.e., integral, adjustable, add-on)?
 - Was it damaged by the person in that seat only?

Injury Data

- o Were you injured in any way due to the accident? [List even minor cuts, abrasions, or bruises.]
- o Did you receive any medical treatment?
 - Did you go directly from the scene (i.e., no stops between scene and facility)?
 - Where did you receive treatment?
 - Was there more than one facility or private physician involved?
 - If yes, get details (i.e., names, dates, and access to records).
 - Were you admitted to a hospital? If yes, were you transferred to any other facility?
 - If hospitalized, on what day were you released to go home?
- o Did you lose any time from work for any reason related to the accident? If yes, how many days?

APPENDICES

- **Uniform Symbols for Scene Markings**
- **Uniform Symbols for Accident Diagramming**
- **Variable Computer Formats**

UNIFORM SYMBOLS FOR ACCIDENT DIAGRAMMING

Vehicle and Pedestrian Symbols

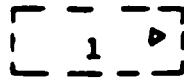

Automobile (pre-impact or at-impact position) Exception: draw solid outline if stopped at-impact.



Automobile (final rest position)--showing damaged area



Automobile (final position on its top)



Automobile (final position on its left side) (reverse for right side)



Automobile involved in the accident as a temporary environmental factor, but not physically involved in the collision. (Noncontact Unit)



Parked automobile not struck (give it a number if it was struck)



Vehicle in which a witness was an occupant

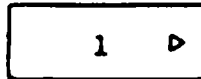

Truck (Panel, Van, Dump, etc.)



Truck tractor and semi-trailer



Utility trailer

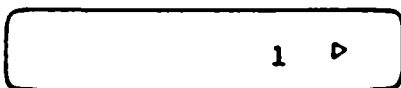





Bus or streetcar



Motorcyclist: bicyclist (handlebars are curved opposite the direction of travel)

UNIFORM SYMBOLS FOR ACCIDENT DIAGRAMMING -- Continued

-   Pedestrian [pointer oriented to show direction of movement and dot spacing to show rate of movement (i.e., 3' apart walking and 6' apart running)]
-  Final position of body
-  Pedestrian who witnessed accident

All symbols referring to colliding vehicles (plus Noncontact, Witness and Parked vehicles) are to have a broken outline if they are moving at the point in which they are depicted; the outline should be solid if the vehicle is stopped where depicted, or at final rest. Be careful to insure proper placement (location) or orientation on the diagram.

UNIFORM SYMBOLS FOR ACCIDENT DIAGRAMMING -- Continued

Scene Road Marking



Point of impact



Skidmarks

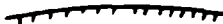

Centripetal curve scuffs



Tire scuff marks



Rotating tire print



Gouges



Scratches



Liquids (puddle and run-off)













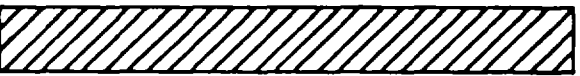

Debris (funnel out away from point of impact to show direction of force)

Any other accident-induced markings, components from vehicles, etc. should be shown in their approximate location and a reasonable likeness sketched on the diagram. However, do not clutter diagram; make an additional diagram, if necessary.











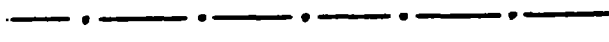

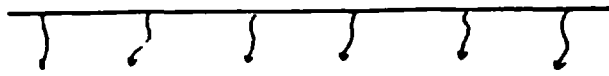



UNIFORM SYMBOLS FOR ACCIDENT DIAGRAMMING -- Continued

Topographical Highway & Environment Symbols

	Pavement edge
	Shoulder edge line (non-formal)
	Shoulder edge line (formal)
	Broken center or lane lines (15' long - 25' apart)
	Broken center line with No-Passing line
	Double yellow center lines
	Raised island and Grass median
	Painted median
	Curb
	Paved shoulders with diagonal lines
	Turn arrows
	Wall
	Bridge abutment and railing
	Guardrail

UNIFORM SYMBOLS FOR ACCIDENT DIAGRAMMING -- Continued.

Topographical Highway & Environmental Symbols (Cont'd.)

	Fence
	Railroad tracks
	Embankment (arrows show "DOWN")
	Shrubbery - hedges
	Trees (draw trunk and perimeter of foliage to approximate size)
	Traffic signal
	Flashing light
	Traffic signs back to back
	Sign (indicate words or symbols)
	Street light and pole (arm length may change with scene)
	Street light without arm
	Public utility pole
	Building
	Fire Hydrant
	Street Sign
	Delineator post

All crosswalks, road surface symbols and other relevant markings should be depicted and drawn to approximate scale on the diagram as much as possible.

NASS CDS VARIABLE COMPUTER FORMATS

Accident Form

Name	Variable Identifier	SAS Variable Number	Variable Type	Variable Column Length	Beginning Column Number
Primary Sampling Unit Number	AC01		Numeric	2	1
Case Number - Stratum	AC02		Alphanumeric	4	3
Number of Vehicle Forms Submitted	AC03		Numeric	2	7
Date of Accident	AC04		Numeric	6	9
Time of Accident	AC05		Numeric	4	15
SS12 Not Active	AC06		Numeric	1	19
SS13 Not Active	AC07		Numeric	1	20
SS14 Not used	AC08		Numeric	1	21
SS15 Not used	AC09		Numeric	1	22
SS16 Not used	AC10		Numeric	1	23
Number of Recorded Events in This Accident	AC11		Numeric	2	24
1st Accident Event Sequence Number	AC12		Numeric	2	26
1st Vehicle Number	AC13		Numeric	2	28
1st Class of Vehicle--1st	AC14		Numeric	2	30
1st General Area of Damage--1st	AC15		Alphanumeric	1	32
1st Vehicle Number or Object Contacted	AC16		Numeric	2	33
1st Class of Vehicle--2nd	AC17		Numeric	2	35
1st General Area of Damage--2nd	AC18		Alphanumeric	1	37
2nd Accident Event Sequence Number	AC19		Numeric	2	38
2nd Vehicle Number	AC20		Numeric	2	40
2nd Class of Vehicle--1st	AC21		Numeric	2	42
2nd General Area of Damage--1st	AC22		Alphanumeric	1	44
2nd Vehicle Number or Object Contacted	AC23		Numeric	2	45
2nd Class of Vehicle--2nd	AC24		Numeric	2	47
2nd General Area of Damage--2nd	AC25		Alphanumeric	1	49
3rd Accident Event Sequence Number	AC26		Numeric	2	50
3rd Vehicle Number	AC27		Numeric	2	52
3rd Class of Vehicle--1st	AC28		Numeric	2	54
3rd General Area of Damage--1st	AC29		Alphanumeric	1	56
3rd Vehicle Number or Object Contacted	AC30		Numeric	2	57
3rd Class of Vehicle--2nd	AC31		Numeric	2	59
3rd General Area of Damage--2nd	AC32		Alphanumeric	1	61
4th Accident Event Sequence Number	AC33		Numeric	2	62
4th Vehicle Number	AC34		Numeric	2	64
4th Class of Vehicle--1st	AC35		Numeric	2	66
4th General Area of Damage--1st	AC36		Alphanumeric	1	68
4th Vehicle Number or Object Contacted	AC37		Numeric	2	69
4th Class of Vehicle--2nd	AC38		Numeric	2	71
4th General Area of Damage--2nd	AC39		Alphanumeric	1	73
5th Accident Event Sequence Number	AC40		Numeric	2	74
5th Vehicle Number	AC41		Numeric	2	76
5th Class of Vehicle--1st	AC42		Numeric	2	78
5th General Area of Damage--1st	AC43		Alphanumeric	1	80
5th Vehicle Number or Object Contacted	AC44		Numeric	2	81
5th Class of Vehicle--2nd	AC45		Numeric	2	83
5th General Area of Damage--2nd	AC46		Alphanumeric	1	85

NASS CDS VARIABLE COMPUTER FORMATS - Continued

Accident Form (Continued)
(Accident Events Supplement)

Name	SAS Variable Identifier	SAS Variable Number	Variable Type	Variable Column Length	Beginning Column Number
6th Accident Event Sequence Number	AC47		Numeric	2	86
6th Vehicle Number	AC48		Numeric	2	88
6th Class of Vehicle--1st	AC49		Numeric	2	90
6th General Area of Damage--1st	AC50		Alphanumeric	1	92
6th Vehicle Number or Object Contacted	AC51		Numeric	2	93
6th Class of Vehicle--2nd	AC52		Numeric	2	95
6th General Area of Damage--2nd	AC53		Alphanumeric	1	97
7th Accident Event Sequence Number	AC54		Numeric	2	98
7th Vehicle Number	AC55		Numeric	2	100
7th Class of Vehicle--1st	AC56		Numeric	2	102
7th General Area of Damage--1st	AC57		Alphanumeric	1	104
7th Vehicle Number or Object Contacted	AC58		Numeric	2	105
7th Class of Vehicle--2nd	AC59		Numeric	2	107
7th General Area of Damage--2nd	AC60		Alphanumeric	1	109
8th Accident Event Sequence Number	AC61		Numeric	2	110
8th Vehicle Number	AC62		Numeric	2	112
8th Class of Vehicle--1st	AC63		Numeric	2	114
8th General Area of Damage--1st	AC64		Alphanumeric	1	116
8th Vehicle Number or Object Contacted	AC65		Numeric	2	117
8th Class of Vehicle--2nd	AC66		Numeric	2	119
8th General Area of Damage--2nd	AC67		Alphanumeric	1	121
9th Accident Event Sequence Number	AC68		Numeric	2	122
9th Vehicle Number	AC69		Numeric	2	124
9th Class of Vehicle--1st	AC70		Numeric	2	126
9th General Area of Damage--1st	AC71		Alphanumeric	1	128
9th Vehicle Number or Object Contacted	AC72		Numeric	2	129
9th Class of Vehicle--2nd	AC73		Numeric	2	131
9th General Area of Damage--2nd	AC74		Alphanumeric	1	133
10th Accident Event Sequence Number	AC75		Numeric	2	134
10th Vehicle Number	AC76		Numeric	2	136
10th Class of Vehicle--1st	AC77		Numeric	2	138
10th General Area of Damage--1st	AC78		Alphanumeric	1	140
10th Vehicle Number or Object Contacted	AC79		Numeric	2	141
10th Class of Vehicle--2nd	AC80		Numeric	2	143
10th General Area of Damage--2nd	AC81		Alphanumeric	1	145

NASS CDS VARIABLE COMPUTER FORMATS - Continued

General Vehicle Form

Name	Variable Identifier	SAS Variable Number	Variable Type	Variable Column Length	Beginning Column Number
Primary Sampling Unit Number	GV01		Numeric	2	1
Case Number - Stratum	GV02		Alphanumeric	4	3
Vehicle Number	GV03		Numeric	2	7
Vehicle Model Year	GV04		Numeric	2	9
Vehicle Make	GV05		Numeric	2	11
Vehicle Model	GV06		Numeric	3	13
Body Type	GV07		Numeric	2	16
Vehicle Identification Number	GV08		Alphanumeric	17	18
Police Reported Vehicle Disposition	GV09		Numeric	1	35
Police Reported Travel Speed	GV10		Numeric	2	36
Police Reported Alcohol Presence	GV11		Numeric	1	38
Alcohol Test Result For Driver	GV12		Numeric	2	39
Speed Limit	GV13		Numeric	2	41
Attempted Avoidance Maneuver	GV14		Numeric	2	43
Accident Type	GV15		Numeric	2	45
Driver Presence in Vehicle	GV16		Numeric	1	47
Number of Occupants This Vehicle	GV17		Numeric	2	48
Number of Occupant Forms Submitted	GV18		Numeric	2	50
Vehicle Curb Weight	GV19		Numeric	3	52
Vehicle Cargo Weight	GV20		Numeric	2	55
Towed Trailing Unit	GV21		Numeric	1	57
Documentation of Trajectory Data for This Vehicle	GV22		Numeric	1	58
Post Collision Condition of Tree or Pole (for Highest Delta V)	GV23		Numeric	1	59
Rollover	GV24		Numeric	1	60
Front Override/Underride (this vehicle)	GV25		Numeric	1	61
Rear Override/Underride (this vehicle)	GV26		Numeric	1	62
Heading Angle for This Vehicle	GV27		Numeric	3	63
Heading Angle for Other Vehicle	GV28		Numeric	3	66
Basis for Total Delta V (Highest)	GV29		Numeric	1	69
Total Delta V	GV30		Numeric	2	70
Longitudinal Component of Delta V	GV31		Numeric	3	72
Lateral Component of Delta V	GV32		Numeric	3	75
Energy Absorption	GV33		Numeric	4	78
Confidence In Reconstruction Program Results(for Highest Delta V)	GV34		Numeric	1	82
Type of Vehicle Inspection	GV35		Numeric	1	83
Is This an AOPS Vehicle?	GV36		Numeric	1	84
Police Reported Other Drug Presence	GV37		Numeric	1	85
Police Reported Observation/Perception Test Type for Driver	GV38		Numeric	1	86
Other Drug Specimen Test Type for Driver	GV39		Numeric	1	87
Narcotic Drug Observation/Perception Test Type	GV40		Numeric	1	88
Narcotic Drug Specimen Test Results	GV41		Numeric	1	89
Depressant Drug Observation/Perception Test Type	GV42		Numeric	1	90
Depressant Drug Specimen Test Results	GV43		Numeric	1	91
Stimulant Drug Observation/Perception Test Type	GV44		Numeric	1	92
Stimulant Drug Specimen Test Results	GV45		Numeric	1	93
Hallucinogen Drug Observation/Perception Test Type	GV46		Numeric	1	94
Hallucinogen Drug Specimen Test Results	GV47		Numeric	1	95
Cannabinoid Drug Observation/Perception Test Type	GV48		Numeric	1	96
Cannabinoid Drug Specimen Test Results	GV49		Numeric	1	97
Phencyclidine (PCP) Drug Observation/Perception Test Type	GV50		Numeric	1	98
Phencyclidine (PCP) Drug Specimen Test Results	GV51		Numeric	1	99
Inhalant Drug Observation/Perception Test Type	GV52		Numeric	1	100
Inhalant Drug Specimen Test Results	GV53		Numeric	1	101
Other Drug Observation/Perception Test Type	GV54		Numeric	1	102
Other Drug Specimen Test Results	GV55		Numeric	1	103

NASS CDS VARIABLE COMPUTER FORMATS - Continued

Exterior Vehicle Form

Name	Variable Identifier	SAS Variable Number	Variable Type	Variable Column Length	Beginning Column Number
Primary Sampling Unit Number	EV01		Numeric	2	1
Case Number - Stratum	EV02		Alphanumeric	4	3
Vehicle Number	EV03		Numeric	2	7
1st C.D.C. - Accident Event Sequence Number	EV04		Numeric	2	9
1st C.D.C. - Object Contacted	EV05		Numeric	2	11
1st C.D.C. - Direction of Force	EV06		Numeric	2	13
1st C.D.C. - Deformation Location	EV07		Alphanumeric	1	15
1st C.D.C. - Specific Longitudinal or Lateral Location	EV08		Alphanumeric	1	16
1st C.D.C. - Specific Vertical or Lateral Location	EV09		Alphanumeric	1	17
1st C.D.C. - Type of Damage Distribution	EV10		Alphanumeric	1	18
1st C.D.C. - Deformation Extent	EV11		Numeric	2	19
2nd C.D.C. - Accident Event Sequence Number	EV12		Numeric	2	21
2nd C.D.C. - Object Contacted	EV13		Numeric	2	23
2nd C.D.C. - Direction of Force	EV14		Numeric	2	25
2nd C.D.C. - Deformation Location	EV15		Alphanumeric	1	27
2nd C.D.C. - Specific Longitudinal or Lateral Location	EV16		Alphanumeric	1	28
2nd C.D.C. - Specific Vertical or Lateral Location	EV17		Alphanumeric	1	29
2nd C.D.C. - Type of Damage Distribution	EV18		Alphanumeric	1	30
2nd C.D.C. - Deformation Extent	EV19		Numeric	2	31
1st Crush Profile - L	EV20		Numeric	3	33
1st Crush Profile - C1-C6	EV21		Numeric	12	36
1st Crush Profile - D	EV22		Numeric	4	48
2nd Crush Profile - L	EV23		Numeric	3	52
2nd Crush Profile - C1-C6	EV24		Numeric	12	55
2nd Crush Profile - D	EV25		Numeric	4	67
Are CDCs Documented but Not Coded on The Automated File?	EV26		Numeric	1	71
Researcher's Assessment of Vehicle Disposition	EV27		Numeric	1	72
Original Wheelbase	EV28		Numeric	4	73
Is This A Multi-Stage Manufactured Vehicle And/Or A Certified Altered Vehicle?	EV29		Numeric	1	74
Fire Occurrence	EV30		Numeric	1	75
Origin of Fire	EV31		Numeric	1	76
Type of Fuel Tank	EV32		Numeric	1	77

Interior Vehicle Form

Name	Variable Identifier	SAS Variable Number	Variable Type	Variable Column Length	Beginning Column Number
Primary Sampling Unit Number	IV01		Numeric	2	1
Case Number - Stratum	IV02		Alphanumeric	4	3
Vehicle Number	IV03		Numeric	2	7
Passenger Compartment Integrity	IV04		Numeric	2	9
Door, Tailgate or Hatch Opening - LF	IV05		Numeric	1	11
Door, Tailgate or Hatch Opening - RF	IV06		Numeric	1	12
Door, Tailgate or Hatch Opening - LR	IV07		Numeric	1	13
Door, Tailgate or Hatch Opening - RR	IV08		Numeric	1	14
Door, Tailgate or Hatch Opening - TG/H	IV09		Numeric	1	15
Damage/Failure Associated With D/TG/H Opening In Collision - LF	IV10		Numeric	1	16
Damage/Failure Associated With D/TG/H Opening In Collision - RF	IV11		Numeric	1	17
Damage/Failure Associated With D/TG/H Opening In Collision - LR	IV12		Numeric	1	18
Damage/Failure Associated With D/TG/H Opening In Collision - RR	IV13		Numeric	1	19
Damage/Failure Associated With D/TG/H Opening In Collision - TG/H	IV14		Numeric	1	20
Glazing Damage from Impact Forces - WS	IV15		Numeric	1	21
Glazing Damage from Impact Forces - LF	IV16		Numeric	1	22
Glazing Damage from Impact Forces - RF	IV17		Numeric	1	23
Glazing Damage from Impact Forces - LR	IV18		Numeric	1	24
Glazing Damage from Impact Forces - RR	IV19		Numeric	1	25
Glazing Damage from Impact Forces - BL	IV20		Numeric	1	26
Glazing Damage from Impact Forces - Roof	IV21		Numeric	1	27
Glazing Damage from Impact Forces - Other	IV22		Numeric	1	28
Glazing Damage from Occupant Contact - WS	IV23		Numeric	1	29
Glazing Damage from Occupant Contact - LF	IV24		Numeric	1	30
Glazing Damage from Occupant Contact - RF	IV25		Numeric	1	31
Glazing Damage from Occupant Contact - LR	IV26		Numeric	1	32
Glazing Damage from Occupant Contact - RR	IV27		Numeric	1	33
Glazing Damage from Occupant Contact - BL	IV28		Numeric	1	34
Glazing Damage from Occupant Contact - Roof	IV29		Numeric	1	35
Glazing Damage from Occupant Contact - Other	IV30		Numeric	1	36
Type of Window/Windshield Glazing - WS	IV31		Numeric	1	37
Type of Window/Windshield Glazing - LF	IV32		Numeric	1	38
Type of Window/Windshield Glazing - RF	IV33		Numeric	1	39
Type of Window/Windshield Glazing - LR	IV34		Numeric	1	40
Type of Window/Windshield Glazing - RR	IV35		Numeric	1	41
Type of Window/Windshield Glazing - BL	IV36		Numeric	1	42
Type of Window/Windshield Glazing - Roof	IV37		Numeric	1	43
Type of Window/Windshield Glazing - Other	IV38		Numeric	1	44
Window Precrash Glazing Status - WS	IV39		Numeric	1	45
Window Precrash Glazing Status - LF	IV40		Numeric	1	46
Window Precrash Glazing Status - RF	IV41		Numeric	1	47
Window Precrash Glazing Status - LR	IV42		Numeric	1	48
Window Precrash Glazing Status - RR	IV43		Numeric	1	49
Window Precrash Glazing Status - BL	IV44		Numeric	1	50
Window Precrash Glazing Status - Roof	IV45		Numeric	1	51
Window Precrash Glazing Status - Other	IV46		Numeric	1	52
1st Location of Intrusion	IV47		Numeric	2	53
1st Intruding Component	IV48		Numeric	2	55
1st Magnitude of Intrusion	IV49		Numeric	1	57
1st Dominant Crush Direction	IV50		Numeric	1	58
2nd Location of Intrusion	IV51		Numeric	2	59
2nd Intruding Component	IV52		Numeric	2	61
2nd Magnitude of Intrusion	IV53		Numeric	1	63
2nd Dominant Crush Direction	IV54		Numeric	1	64
3rd Location of Intrusion	IV55		Numeric	2	65
3rd Intruding Component	IV56		Numeric	2	67
3rd Magnitude of Intrusion	IV57		Numeric	1	69
3rd Dominant Crush Direction	IV58		Numeric	1	70
4th Location of Intrusion	IV59		Numeric	2	71
4th Intruding Component	IV60		Numeric	2	73
4th Magnitude of Intrusion	IV61		Numeric	1	75
4th Dominant Crush Direction	IV62		Numeric	1	76
5th Location of Intrusion	IV63		Numeric	2	77
5th Intruding Component	IV64		Numeric	2	79
5th Magnitude of Intrusion	IV65		Numeric	1	81
5th Dominant Crush Direction	IV66		Numeric	1	82

NASS CDS VARIABLE COMPUTER FORMATS - Continued

Interior Vehicle Form (Continued)

Name	Variable Identifier	SAS Variable Number	Variable Type	Variable Column Length	Beginning Column Number
6th Location of Intrusion	IV67		Numeric	2	83
6th Intruding Component	IV68		Numeric	2	85
6th Magnitude of Intrusion	IV69		Numeric	1	87
6th Dominant Crush Direction	IV70		Numeric	1	88
7th Location of Intrusion	IV71		Numeric	2	89
7th Intruding Component	IV72		Numeric	2	91
7th Magnitude of Intrusion	IV73		Numeric	1	93
7th Dominant Crush Direction	IV74		Numeric	1	94
8th Location of Intrusion	IV75		Numeric	2	95
8th Intruding Component	IV76		Numeric	2	97
8th Magnitude of Intrusion	IV77		Numeric	1	99
8th Dominant Crush Direction	IV78		Numeric	1	100
9th Location of Intrusion	IV79		Numeric	2	101
9th Intruding Component	IV80		Numeric	2	103
9th Magnitude of Intrusion	IV81		Numeric	1	105
9th Dominant Crush Direction	IV82		Numeric	1	106
10th Location of Intrusion	IV83		Numeric	2	107
10th Intruding Component	IV84		Numeric	2	109
10th Magnitude of Intrusion	IV85		Numeric	1	111
10th Dominant Crush Direction	IV86		Numeric	1	112
Steering Column Type	IV87		Numeric	1	113
BLANK	IV88		Numeric	2	114
BLANK	IV89		Numeric	3	116
BLANK	IV90		Numeric	3	119
BLANK	IV91		Numeric	3	122
Steering Rim/Spoke Deformation	IV92		Numeric	1	125
Location of Steering Rim/Spoke Deformation	IV93		Numeric	2	126
Odometer Reading	IV94		Numeric	3	128
Instrument Panel Damage from Occupant Contact?	IV95		Numeric	1	131
Knee Bolsters Deformed from Occupant Contact?	IV96		Numeric	1	132
Did Glove Compartment Door Opened During Collision(s)?	IV97		Numeric	1	133

NASS CDS VARIABLE COMPUTER FORMATS - Continued

Occupant Assessment Form

Name	Variable Identifier	SAS Variable Number	Variable Type	Variable Column Length	Beginning Column Number
Primary Sampling Unit Number	OA01		Numeric	2	1
Case Number - Stratum	OA02		Alphanumeric	4	3
Vehicle Number	OA03		Numeric	2	7
Occupant Number	OA04		Numeric	2	9
Occupant's Age	OA05		Numeric	2	11
Occupant's Sex	OA06		Numeric	1	13
Occupant's Height	OA07		Numeric	2	14
Occupant's Weight	OA08		Numeric	3	16
Occupant's Role	OA09		Numeric	1	19
Occupant's Seat Position	OA10		Numeric	2	20
Occupant's Posture	OA11		Numeric	1	22
Ejection	OA12		Numeric	1	23
Ejection Area	OA13		Numeric	1	24
Ejection Medium	OA14		Numeric	1	25
Medium Status (Immediately Prior to Impact)	OA15		Numeric	1	26
Entrapment	OA16		Numeric	1	27
Manual (Active) Belt System Availability	OA17		Numeric	1	28
Manual (Active) Belt System Use	OA18		Numeric	2	29
Proper Use of Manual (Active) Belts	OA19		Numeric	1	31
Manual (Active) Belt Failure Modes During Impact	OA20		Numeric	1	32
Air Bag System Availability/Function	OA21		Numeric	1	33
Air Bag System Deployment	OA22		Numeric	1	34
Did Air Bag Fail?	OA23		Numeric	1	35
Police Reported Restraint Use	OA24		Numeric	1	36
Head Restraint Type/Damage by Occupant at This Occupant Position	OA25		Numeric	1	37
Seat Type (This Occupant Position)	OA26		Numeric	2	38
Seat Performance (This Occupant Position)	OA27		Numeric	1	40
Child Safety Seat Make/Model	OA28		Numeric	3	41
Type of Child Safety Seat	OA29		Numeric	1	44
Child Safety Seat Orientation	OA30		Numeric	2	45
Child Safety Seat Harness Usage	OA31		Numeric	2	47
Child Safety Seat Shield Usage	OA32		Numeric	2	49
Child Safety Seat Tether Usage	OA33		Numeric	2	51
Injury Severity (Police Rating)	OA34		Numeric	1	53
Treatment - Mortality	OA35		Numeric	1	54
Type Of Medical Facility (for Initial Treatment)	OA36		Numeric	1	55
Hospital Stay	OA37		Numeric	2	56
Working Days Lost	OA38		Numeric	2	58
Time to Death	OA39		Numeric	2	60
1st Medically Reported Cause of Death	OA40		Numeric	2	62
2nd Medically Reported Cause of Death	OA41		Numeric	2	64
3rd Medically Reported Cause of Death	OA42		Numeric	2	66
Number of Recorded Injuries for This Occupant	OA43		Numeric	2	68
Automatic (Passive) Belt System Availability/Function	OA44		Numeric	1	69
Automatic (Passive) Belt System Use	OA45		Numeric	1	70
Automatic (Passive) Belt System Type	OA46		Numeric	1	71
Proper Use of Automatic (Passive) Belt System	OA47		Numeric	1	72
Automatic (Passive) Belt Failure Modes During Accident	OA48		Numeric	1	73

NASS CDS VARIABLE COMPUTER FORMATS - Continued

Occupant Injury Form

Name	Variable Identifier	SAS Variable Number	Variable Type	Variable Column Length	Beginning Column Number
Primary Sampling Unit Number	0101		Numeric	2	1
Case Number - Stratum	0102		Alphanumeric	4	3
Vehicle Number	0103		Numeric	2	7
Occupant Number	0104		Numeric	2	9
1st Source of Injury Data	0105		Numeric	1	11
1st O.I.C. - Body Region	0106		Alphanumeric	1	12
1st O.I.C. - Aspect	0107		Alphanumeric	1	13
1st O.I.C. - Lesion	0108		Alphanumeric	1	14
1st O.I.C. - System/Organ	0109		Alphanumeric	1	15
1st Abbreviated Injury Scale Severity	0110		Numeric	1	16
1st Injury Source	0111		Numeric	2	17
1st Injury Source Confidence Level	0112		Numeric	1	19
1st Direct/Indirect Injury	0113		Numeric	1	20
1st Occupant Area Intrusion Number	0114		Numeric	2	21
2nd Source of Injury Data	0115		Numeric	1	23
2nd O.I.C. - Body Region	0116		Alphanumeric	1	24
2nd O.I.C. - Aspect	0117		Alphanumeric	1	25
2nd O.I.C. - Lesion	0118		Alphanumeric	1	26
2nd O.I.C. - System/Organ	0119		Alphanumeric	1	27
2nd Abbreviated Injury Scale Severity	0120		Numeric	1	28
2nd Injury Source	0121		Numeric	2	29
2nd Injury Source Confidence Level	0122		Numeric	1	31
2nd Direct/Indirect Injury	0123		Numeric	1	32
2nd Occupant Area Intrusion Number	0124		Numeric	2	33
3rd Source of Injury Data	0125		Numeric	1	35
3rd O.I.C. - Body Region	0126		Alphanumeric	1	36
3rd O.I.C. - Aspect	0127		Alphanumeric	1	37
3rd O.I.C. - Lesion	0128		Alphanumeric	1	38
3rd O.I.C. - System/Organ	0129		Alphanumeric	1	39
3rd Abbreviated Injury Scale Severity	0130		Numeric	1	40
3rd Injury Source	0131		Numeric	2	41
3rd Injury Source Confidence Level	0132		Numeric	1	43
3rd Direct/Indirect Injury	0133		Numeric	1	44
3rd Occupant Area Intrusion Number	0134		Numeric	2	45
4th Source of Injury Data	0135		Numeric	1	47
4th O.I.C. - Body Region	0136		Alphanumeric	1	48
4th O.I.C. - Aspect	0137		Alphanumeric	1	49
4th O.I.C. - Lesion	0138		Alphanumeric	1	50
4th O.I.C. - System/Organ	0139		Alphanumeric	1	51
4th Abbreviated Injury Scale Severity	0140		Numeric	1	52
4th Injury Source	0141		Numeric	2	53
4th Injury Source Confidence Level	0142		Numeric	1	55
4th Direct/Indirect Injury	0143		Numeric	1	56
4th Occupant Area Intrusion Number	0144		Numeric	2	57
5th Source of Injury Data	0145		Numeric	1	59
5th O.I.C. - Body Region	0146		Alphanumeric	1	60
5th O.I.C. - Aspect	0147		Alphanumeric	1	61
5th O.I.C. - Lesion	0148		Alphanumeric	1	62
5th O.I.C. - System/Organ	0149		Alphanumeric	1	63
5th Abbreviated Injury Scale Severity	0150		Numeric	1	64
5th Injury Source	0151		Numeric	2	65
5th Injury Source Confidence Level	0152		Numeric	1	67
5th Direct/Indirect Injury	0153		Numeric	1	68
5th Occupant Area Intrusion Number	0154		Numeric	2	69
6th Source of Injury Data	0155		Numeric	1	71
6th O.I.C. - Body Region	0156		Alphanumeric	1	72
6th O.I.C. - Aspect	0157		Alphanumeric	1	73
6th O.I.C. - Lesion	0158		Alphanumeric	1	74
6th O.I.C. - System/Organ	0159		Alphanumeric	1	75
6th Abbreviated Injury Scale Severity	0160		Numeric	1	76
6th Injury Source	0161		Numeric	2	77
6th Injury Source Confidence Level	0162		Numeric	1	79
6th Direct/Indirect Injury	0163		Numeric	1	80
6th Occupant Area Intrusion Number	0164		Numeric	2	81

NASS CDS VARIABLE COMPUTER FORMATS - Continued

Occupant Injury Form (Continued)

Name	Variable Identifier	SAS Variable Number	Variable Type	Variable Column Length	Beginning Column Number
7th Source of Injury Data	0165		Numeric	1	83
7th O.I.C. - Body Region	0166		Alphanumeric	1	84
7th O.I.C. - Aspect	0167		Alphanumeric	1	85
7th O.I.C. - Lesion	0168		Alphanumeric	1	86
7th O.I.C. - System/Organ	0169		Alphanumeric	1	87
7th Abbreviated Injury Scale Severity	0170		Numeric	1	88
7th Injury Source	0171		Numeric	2	89
7th Injury Source Confidence Level	0172		Numeric	1	91
7th Direct/Indirect Injury	0173		Numeric	1	92
7th Occupant Area Intrusion Number	0174		Numeric	2	93
8th Source of Injury Data	0175		Numeric	1	95
8th O.I.C. - Body Region	0176		Alphanumeric	1	96
8th O.I.C. - Aspect	0177		Alphanumeric	1	97
8th O.I.C. - Lesion	0178		Alphanumeric	1	98
8th O.I.C. - System/Organ	0179		Alphanumeric	1	99
8th Abbreviated Injury Scale Severity	0180		Numeric	1	100
8th Injury Source	0181		Numeric	2	101
8th Injury Source Confidence Level	0182		Numeric	1	103
8th Direct/Indirect Injury	0183		Numeric	1	104
8th Occupant Area Intrusion Number	0184		Numeric	2	105
9th Source of Injury Data	0185		Numeric	1	107
9th O.I.C. - Body Region	0186		Alphanumeric	1	108
9th O.I.C. - Aspect	0187		Alphanumeric	1	109
9th O.I.C. - Lesion	0188		Alphanumeric	1	110
9th O.I.C. - System/Organ	0189		Alphanumeric	1	111
9th Abbreviated Injury Scale Severity	0190		Numeric	1	112
9th Injury Source	0191		Numeric	2	113
9th Injury Source Confidence Level	0192		Numeric	1	115
9th Direct/Indirect Injury	0193		Numeric	1	116
9th Occupant Area Intrusion Number	0194		Numeric	2	117
10th Source of Injury Data	0195		Numeric	1	119
10th O.I.C. - Body Region	0196		Alphanumeric	1	120
10th O.I.C. - Aspect	0197		Alphanumeric	1	121
10th O.I.C. - Lesion	0198		Alphanumeric	1	122
10th O.I.C. - System/Organ	0199		Alphanumeric	1	123
10th Abbreviated Injury Scale Severity	01100		Numeric	1	124
10th Injury Source	01101		Numeric	2	125
10th Injury Source Confidence Level	01102		Numeric	1	127
10th Direct/Indirect Injury	01103		Numeric	1	128
10th Occupant Area Intrusion Number	01104		Numeric	2	129

NASS CDS VARIABLE COMPUTER FORMATS - Continued

Occupant Injury Form (Continued)
(Occupant Injury Data Supplement)

Name	Variable Identifier	SAS Variable Number	Variable Type	Variable Column Length	Beginning Column Number
11th Source of Injury Data	01105		Numeric	1	131
11th O.I.C. - Body Region	01106		Alphanumeric	1	132
11th O.I.C. - Aspect	01107		Alphanumeric	1	133
11th O.I.C. - Lesion	01108		Alphanumeric	1	134
11th O.I.C. - System/Organ	01109		Alphanumeric	1	135
11th Abbreviated Injury Scale Severity	01110		Numeric	1	136
11th Injury Source	01111		Numeric	2	137
11th Injury Source Confidence Level	01112		Numeric	1	139
11th Direct/Indirect Injury	01113		Numeric	1	140
11th Occupant Area Intrusion Number	01114		Numeric	2	141
12th Source of Injury Data	01115		Numeric	1	143
12th O.I.C. - Body Region	01116		Alphanumeric	1	144
12th O.I.C. - Aspect	01117		Alphanumeric	1	145
12th O.I.C. - Lesion	01118		Alphanumeric	1	146
12th O.I.C. - System/Organ	01119		Alphanumeric	1	147
12th Abbreviated Injury Scale Severity	01120		Numeric	1	148
12th Injury Source	01121		Numeric	2	149
12th Injury Source Confidence Level	01122		Numeric	1	151
12th Direct/Indirect Injury	01123		Numeric	1	152
12th Occupant Area Intrusion Number	01124		Numeric	2	153
13th Source of Injury Data	01125		Numeric	1	155
13th O.I.C. - Body Region	01126		Alphanumeric	1	156
13th O.I.C. - Aspect	01127		Alphanumeric	1	157
13th O.I.C. - Lesion	01128		Alphanumeric	1	158
13th O.I.C. - System/Organ	01129		Alphanumeric	1	159
13th Abbreviated Injury Scale Severity	01130		Numeric	1	160
13th Injury Source	01131		Numeric	2	161
13th Injury Source Confidence Level	01132		Numeric	1	163
13th Direct/Indirect Injury	01133		Numeric	1	164
13th Occupant Area Intrusion Number	01134		Numeric	2	165
14th Source of Injury Data	01135		Numeric	1	167
14th O.I.C. - Body Region	01136		Alphanumeric	1	168
14th O.I.C. - Aspect	01137		Alphanumeric	1	169
14th O.I.C. - Lesion	01138		Alphanumeric	1	170
14th O.I.C. - System/Organ	01139		Alphanumeric	1	171
14th Abbreviated Injury Scale Severity	01140		Numeric	1	172
14th Injury Source	01141		Numeric	2	173
14th Injury Source Confidence Level	01142		Numeric	1	175
14th Direct/Indirect Injury	01143		Numeric	1	176
14th Occupant Area Intrusion Number	01144		Numeric	2	177
15th Source of Injury Data	01145		Numeric	1	179
15th O.I.C. - Body Region	01146		Alphanumeric	1	180
15th O.I.C. - Aspect	01147		Alphanumeric	1	181
15th O.I.C. - Lesion	01148		Alphanumeric	1	182
15th O.I.C. - System/Organ	01149		Alphanumeric	1	183
15th Abbreviated Injury Scale Severity	01150		Numeric	1	184
15th Injury Source	01151		Numeric	2	185
15th Injury Source Confidence Level	01152		Numeric	1	187
15th Direct/Indirect Injury	01153		Numeric	1	188
15th Occupant Area Intrusion Number	01154		Numeric	2	189
16th Source of Injury Data	01155		Numeric	1	191
16th O.I.C. - Body Region	01156		Alphanumeric	1	192
16th O.I.C. - Aspect	01157		Alphanumeric	1	193
16th O.I.C. - Lesion	01158		Alphanumeric	1	194
16th O.I.C. - System/Organ	01159		Alphanumeric	1	195
16th Abbreviated Injury Scale Severity	01160		Numeric	1	196
16th Injury Source	01161		Numeric	2	197
16th Injury Source Confidence Level	01162		Numeric	1	199
16th Direct/Indirect Injury	01163		Numeric	1	200
16th Occupant Area Intrusion Number	01164		Numeric	2	201

NASS CDS VARIABLE COMPUTER FORMATS - Continued

Occupant Injury Form (Continued)
 (Occupant Injury Data Supplement)

Name	Variable Identifier	SAS Variable Number	Variable Type	Variable Column Length	Beginning Column Number
17th Source of Injury Data	O1165		Numeric	1	203
17th O.I.C. - Body Region	O1166		Alphanumeric	1	204
17th O.I.C. - Aspect	O1167		Alphanumeric	1	205
17th O.I.C. - Lesion	O1168		Alphanumeric	1	206
17th O.I.C. - System/Organ	O1169		Alphanumeric	1	207
17th Abbreviated Injury Scale Severity	O1170		Numeric	1	208
17th Injury Source	O1171		Numeric	2	209
17th Injury Source Confidence Level	O1172		Numeric	1	211
17th Direct/Indirect Injury	O1173		Numeric	1	212
17th Occupant Area Intrusion Number	O1174		Numeric	2	213
18th Source of Injury Data	O1175		Numeric	1	215
18th O.I.C. - Body Region	O1176		Alphanumeric	1	216
18th O.I.C. - Aspect	O1177		Alphanumeric	1	217
18th O.I.C. - Lesion	O1178		Alphanumeric	1	218
18th O.I.C. - System/Organ	O1179		Alphanumeric	1	219
18th Abbreviated Injury Scale Severity	O1180		Numeric	1	220
18th Injury Source	O1181		Numeric	2	221
18th Injury Source Confidence Level	O1182		Numeric	1	223
18th Direct/Indirect Injury	O1183		Numeric	1	224
18th Occupant Area Intrusion Number	O1184		Numeric	2	225
19th Source of Injury Data	O1185		Numeric	1	227
19th O.I.C. - Body Region	O1186		Alphanumeric	1	228
19th O.I.C. - Aspect	O1187		Alphanumeric	1	229
19th O.I.C. - Lesion	O1188		Alphanumeric	1	230
19th O.I.C. - System/Organ	O1189		Alphanumeric	1	231
19th Abbreviated Injury Scale Severity	O1190		Numeric	1	232
19th Injury Source	O1191		Numeric	2	233
19th Injury Source Confidence Level	O1192		Numeric	1	235
19th Direct/Indirect Injury	O1193		Numeric	1	236
19th Occupant Area Intrusion Number	O1194		Numeric	2	237
20th Source of Injury Data	O1195		Numeric	1	239
20th O.I.C. - Body Region	O1196		Alphanumeric	1	240
20th O.I.C. - Aspect	O1197		Alphanumeric	1	241
20th O.I.C. - Lesion	O1198		Alphanumeric	1	242
20th O.I.C. - System/Organ	O1199		Alphanumeric	1	243
20th Abbreviated Injury Scale Severity	O1200		Numeric	1	244
20th Injury Source	O1201		Numeric	2	245
20th Injury Source Confidence Level	O1202		Numeric	1	247
20th Direct/Indirect Injury	O1203		Numeric	1	248
20th Occupant Area Intrusion Number	O1204		Numeric	2	249

NATIONAL ACCIDENT SAMPLING SYSTEM
1991 CRASHWORTHINESS DATA SYSTEM
DATA COLLECTION, CODING, AND EDITING MANUAL

January 26, 1991

