

NATIONAL ACCIDENT SAMPLING SYSTEM
1994 CRASHWORTHINESS DATA SYSTEM
DATA COLLECTION, CODING, AND EDITING MANUAL

**U.S. DEPARTMENT OF TRANSPORTATION
NATIONAL HIGHWAY TRAFFIC SAFETY ADMINISTRATION
NATIONAL CENTER FOR STATISTICS AND ANALYSIS
WASHINGTON, D.C. 20590**

January 1994

ACKNOWLEDGEMENT

NASS CDS DATA COLLECTION, CODING, AND EDITING MANUAL

The first edition (Pilot Study-1978) of this manual was originally developed by Indiana University under a contract sponsored by the National Highway Traffic Safety Administration. The work was performed under the direction of staff at the National Center for Statistics and Analysis (NCSA).

The second and third editions (1979 and 1980 calendar year versions) of this manual were developed by Indiana University and Calspan Corporation in consultation with NASS staff at the NCSA. Final illustrations, editing, and production of camera ready copies were performed at Indiana University.

The fourth through eleventh editions (the 1981-1988 calendar year versions) were collaborated productions by the NASS Zone Centers: Transportation Research Center at Indiana University, Calspan Corporation, Southwest Research Institute, and Dynamic Science, Inc. The twelfth edition (the 1989 calendar year version) was also a collaborative effort of the NASS Zone Centers: Transportation Research Center at Indiana University and Franklin Research Division of ARVIN/CALSPAN. The work was performed under the direction of NASS staff at the NCSA. Final illustrations, editing, and production of camera ready copies were performed at the Transportation Research Center.

The 13th edition of this manual (the 1990 calendar year version) was produced by staff at the National Center for Statistics and Analysis. A collaborated and comprehensive review was performed by the NASS Zone Centers: Transportation Research Center at Indiana University and Franklin Research Division of ARVIN/CALSPAN.

The 14th edition (the 1991 calendar year version), 15th edition (the 1992 calendar year version), 16th edition (the 1993 calendar year version), and 17th edition (the 1994 calendar year version) are collaborated efforts of the NASS Zone Centers: Transportation Research Center at Indiana University and Franklin Research Division of ARVIN/CALSPAN, and staff at the National Center for Statistics and Analysis. The work was performed under the direction of NASS staff at NCSA. Final editing, illustrations, and production of camera ready copies were performed at the National Center for Statistics and Analysis.

The production of this and previous editions of the NASS CDS Data Collection, Coding, and Editing Manual could not have been made possible without contributions from many unidentified sources within the U.S. Department of Transportation, the NASS Zone Centers, PSU teams, and the transportation community.

TABLE OF CONTENTS

	Page

1.0 INTRODUCTION	1
1.1 Purpose of the Manual	1
1.2 Overview	1
1.3 How to Use This Manual	2
2.0 DESCRIPTION OF THE SAMPLING FRAME	5
2.1 Accidents Which Qualify for NASS	5
Figure 2-1--Incident to NASS Accident Flow Chart	6
Figure 2-2--Rural Trafficway	10
Figure 2-3--Urban Trafficway	11
Figure 2-4--Divided Trafficway	12
Figure 2-5--Parking Lot Situations	14
Figure 2-6--ANSI Flow Chart & Definitions	17
Figure 2-7--NASS Accident Overview	26
2.1.1 Questions and Answers About Which Incidents Qualify for NASS	28
2.2 NASS PAR Sampling	30
2.2.1 Sampling Variables	30
2.2.2 Sampling Strata	33
Table 2-1--1994 NASS CDS Strata	34
Table 2-2--1994 NASS GES Strata	34
Figure 2-8--NASS Stratification	40
2.2.3 Questions and Answers Regarding First Stratification Figure 2-9--Parking and In-Transport Situations	41
2.2.4 Questions and Answers Regarding Second Stratification Table 2-3 --First Versus Second Stratum	45
3.0 OVERVIEW OF SAMPLING ACTIVITIES	47
3.1 Listing and Sampling Forms	47
3.1.1 Contact Day Assignment Sheet (CDAS)	47
3.1.2 PAR Stratification Record (SR)	47
3.1.3 Hospital Work Sheet	47
3.2 Listing and Sampling Instructions	47
3.2.1 Contacting Police Jurisdictions	47
Table 3-1--Contact Day Assignment Sheet	48
Table 3-2--PAR Stratification Record	49
Table 3-3--Hospital Work Sheet	50
3.2.2 Completing the PAR Stratification Record	51
3.2.3 Completing the Hospital Work Sheet	55
3.2.4 The NASS CDS Automated Case Selection System (ACSS)	57
3.2.5 Special Instructions for Automated Sampling Procedures Table 3-4--NASS CDS Automated Case Selection System Report (ACSSR)	57
3.3 CDS Sampling Problems: How to Handle Them	59
Table 3-5--PAR Disposition Versus Team Research	61
3.4 CDS Hospitalization Determination Examples	62
3.5 Beginning of Year Sampling Instructions	64
4.0 OVERVIEW OF COLLECTED INFORMATION ON SAMPLED CDS ACCIDENTS	65
4.1 Required Forms for CDS Cases	65
4.2 Sequencing of Case Materials	65
Table 4-1--Required Forms for NASS CDS Cases	66
Figure 4-1--Sequence of Case Materials	67
4.3 Information Required on Field Forms (File Structuring Variables)	69
4.4 Update Procedures for Hard Copy Field Forms	70

TABLE OF CONTENTS (Continued)

	Page
4.5 Potential Safety Problem Bulletin	72
4.6 CDS Criteria for Acceptable Data Completion	72
Figure 4-2--Potential Safety Problem Bulletin	73
Table 4-2--Specific Areas Of Interest To NHTSA Rulemaking	74
5.0 CDS SUBMISSION INSTRUCTIONS	77
5.1 Quality Control Checks for PSU Teams	77
5.1.1 Quality Control Checks Prior to Microcomputer Data Entry	77
5.1.2 Quality Control Checks Resulting from Microcomputer Data Entry	77
Table 5-1--MDE Checks: Format, Designations, and Tables	78
5.1.3 Check to Make Sure Administrative Procedures Are Being Followed	80
5.1.4 Check Sampling Procedures	80
5.1.5 Check Data Collection Procedures	80
5.1.6 Check to Make Sure Updates Are Being Processed Properly	80
5.1.7 Check Individual Effort and Accuracy in Collecting Evidence and Skill in Interpretation	80
5.2 Case Submission	80
Table 5-2--1994 CDS Case Submissions Schedule	82
Table 5-3--1994 CDS File Closeout Schedule	84
Table 5-4--Administrative Log - A	86
5.3 Case Deletion Procedures	87
6.0 GES QUALITY CONTROL AND SUBMISSION INSTRUCTIONS	91
6.1 Quality Control Checklist for GES Sampling and Mailing	91
6.2 GES Submission Instructions	91
Table 6-1--Quality Control Checklist	93
6.3 Sampled PAR Inventory	94
6.4 Submission Schedule	94
Table 6-2--General Estimates System Sampled PAR Inventory	95
Table 6-3--GES PAR Submission Schedule	96
7.0 CODING INSTRUCTIONS	99

	Page(s)
Case Summary Form (Noncoded Information, NCI)	CS-1 - CS-3
Accident Form (Variables AC01-AC46)	
Accident Collision Measurement Table	
Accident Collision Diagram	
Slide Index	
o AC01-AC11	AC-1 - AC-8
o Accident Events Overview	AC-9 - AC-10
o AC12-AC46	AC-11 - AC-21
General Vehicle Form (Variables GV01-GV67)	
CRASHPC Program Summary	
OLDMISS Program Summary	
o GV03-GV05	GV-1 - GV-4
o GV06	GV-5 - GV-54
o GV07-GV08	GV-55 - GV-67
o GV09-GV12	GV-68 - GV-73

TABLE OF CONTENTS (Continued)

	Page(s)

General Vehicle Form (Variables GV01-GV67) (Continued)	
o GV13-GV15	GV-74 - GV-83
o GV16-GV18	GV-84 - GV-86
o GV19-GV20	GV-87 - GV-89
o GV21-GV24	GV-90 - GV-94
o GV25-GV28	GV-95 - GV-99
o Reconstruction Programs Overview	GV-100 - GV-107
o GV29-GV36	GV-108 - GV-117
o Other Drug Overview	GV-118 - GV-124
o GV37-GV39	GV-125 - GV-129
o GV40-GV55	GV-130 - GV-152
o GV56-GV58	GV-153 - GV-159
o Rollover Data Overview	GV-160
o GV59-GV63	GV-161 - GV-175
o Precrash Data Overview	GV-176 - GV-189
o GV64-GV67	GV-190 - GV-203
o Precrash General Rules	GV-204
Exterior Vehicle Form (Variables EV01-EV44)	
o Instructions for Completion of CDS Applicable Field Measurements Page	EV-1 - EV-4
o Instructions for Completion of Vehicle Damage Sketch	EV-5 - EV-7
o EV04/EV12, EV05/EV13	EV-8 - EV-21
o CDC Related Remarks	EV-22 - EV-23
o EV06/EV14-EV11/EV19	EV-24 - EV-30
o Crush Profile Overview	EV-31 - EV-32
o End Damage Measurement Protocol	EV-31
o Side Plane Damage Measurement Protocol	EV-32
o EV20-EV28	EV-33 - EV-39
o EV29-EV33	EV-40 - EV-51
o EV34-EV44	EV-52 - EV-62
Interior Vehicle Form (Variables IV01-IV97)	
o IV04	IV-1 - IV-3
o Door, Tailgate, or Hatch Opening Overview	IV-4
o IV05-IV14	IV-5 - IV-9
o Glazing Damage Overview	IV-10 - IV-11
o IV15-IV46	IV-12 - IV-22
o Occupant Area Intrusion Overview	IV-23 - IV-26
o IV47-IV86	IV-27 - IV-36
o Steering Column Overview	IV-37
o IV87	IV-38
o IV88-IV91 (Blank)	IV-39
o IV92-IV97	IV-40 - IV-48
o Instructions for Completion of Vehicle Interior Sketches And Points of Occupant Contact Pages	IV-49 - IV-51
o Manual Restraints	IV-52
o Child Safety Seat Field Assessment	IV-52
Occupant Assessment Form (Variables OA01-OA53)	
o OA03-OA04	OA-1 - OA-2
o Occupant's Characteristics Overview	OA-3
o OA05-OA11	OA-4 - OA-13
o Ejection/Entrapment Overview	OA-14 - OA-16

TABLE OF CONTENTS (Continued)

	Page(s)

Occupant Assessment Form (Variables OA01-OA53) (Continued)	
o OA12-OA16	OA-17 - OA-22
o Restraint System and Seats Overview	OA-23 - OA-25
o OA17-OA27	OA-26 - OA-49
o Child Restraint Overview	OA-50 - OA-51
o OA28-OA33	OA-52 - OA-64
o Injury/Consequences Overview	OA-65
o OA34-OA48	OA-66 - OA-93
o Table of Vehicles with Automatic Restraint Systems . .	OA- 94 - OA-104
o OA49-OA53	OA-105 - OA-114
Occupant Injury Form (Variables OI01-OI114)	
o Injury Data Overview	OI-1 - OI-11
Figure 1--Medical Envelope Injury Label	OI-6
o OI05-OI15	OI-12 - OI-27
Update Form	UD-1
Interview Form (Noncoded Information, NCI)	IN-1 - IN-2
o Interview Form (A)	IN-1 - IN-2
o Interview Form (B)	IN-3 - IN-5
APPENDICES	
o Uniform Symbols for Scene Marking	AP-1
o Uniform Symbols for Accident Diagramming	AP-2 - AP-6
o Variable Computer Formats	AP-7 - AP-15
o NASS CDS Value Tables	AP-16 - AP-25
o 1994 NASS CDS Data Collection, Coding and Editing Manual Modifications and Additions	
o 1994 NASS CDS Form Changes	

NASS CDS DATA COLLECTION, CODING, AND EDITING MANUAL

1.0 INTRODUCTION

1.1 Purpose of the Manual

In order to produce a national traffic accident data base for the evaluation of old and the development of new highway and vehicle safety standards and to identify highway safety needs, the National Accident Sampling System was created. The system consists of twenty-four teams of accident researchers situated throughout the country. At each Primary Sampling Unit (PSU) site the accident research team investigates a probability sample of police reported accidents involving passenger cars, light trucks, and vans which were towed, according to the police report, from the scene due to damage. This system has been termed the **Crashworthiness Data System (CDS)**.

Zone centers have been established to provide for the quality control of the CDS data collected and the technical management of the teams within their zone. Quality control is carried out through zone center site visits to the PSUs and through the review of accident case report materials received at the zone center. The zone centers provide quality control in the areas of sampling, completeness of data, reliability, and validity of data. In addition, the zone centers provide annual team evaluations, training, extra PSU staff (when needed), and act as a communication link between the PSU teams and the staff of the National Center for Statistics and Analysis.

The purpose of this manual is to provide PSU team members, zone centers, the Transportation Safety Institute (TSI) NASS Training Program Coordinator, and the National Center for Statistics and Analysis with a consistent, standardized set of instructions for sampling accidents and collecting, coding, and editing the data.

1.2 Overview

The manual includes seven substantive sections; each is summarized below.

Section 2.0 Description of the Sampling Frame describes, first, the procedure for determining whether or not the incident reported on a police accident report (PAR) qualifies for inclusion in the NASS, second, the variables used to classify the NASS qualifying sampled PARs, and third, which data collection forms are required to be submitted with a NASS CDS case. The PAR sampling strata for the CDS are defined in terms of the values of the these variables. In addition, the **General Estimates System (GES)** and its relationship to CDS is discussed.

Section 3.0 Overview of Sampling Activities describes the procedures for compiling the sampling frame list and selecting the accidents to be researched for the CDS and obtained for the GES. Detailed instructions for use of the automated system are found in the MDE User's Manual.

Section 4.0 Overview of Information to be Collected on Sampled CDS Accidents describes the forms which are to be filled out on each accident, the different records (e.g., injury records), photographs, and other information (e.g., CRASH runs) which make up a completed case report. Also discussed are the file structuring data items and forms which must be encoded before a case can qualify for submission. In addition, the NASS CDS criteria for acceptable data completion are presented.

Section 5.0 CDS Submission Instructions describes when, where, and how to submit case reports. It also describes the quality control procedures to be used at the PSU sites. In addition, MDE consistency checks and the procedures for deleting a case are discussed.

Section 6.0 GES Quality Control and Submission Instructions presents the quality control checklist and the instructions for submission of GES sampling materials.

Section 7.0 Coding Instructions provides the general instructions for collecting and coding the data called for in the Case Summary Form and the field forms. Documentation for each data element includes variable name, element values (attributes), definitions (where needed), data sources, collection method, reference materials (if needed), and remarks.

The Appendices contain some of the necessary references, including: (1) the Uniform Symbols for Scene Marking, (2) the Uniform Symbols for Accident Diagramming, and (3) the listing of Variable Computer Formats.

Other references to be used in NASS CDS not contained in this manual include: (1) the Fifth Edition of ANSI D16.1-1989; (2) the CRASH3 Technical Manual (July 1986); (3) SAE J224 MAR80; (4) the 1993 NASS Injury Coding Manual (based on AIS-90); (5) NATB books (see variable GV08); (6) Passenger Car and Truck Investigators Manual (see variable GV08); (7) the Branham Automobile Reference Book; (8) Diesel and Gasoline Truck Indices; (9) the MVMA - Passenger Car Specifications (see variable GV19); (10) Microcomputer Data Entry User's Manual for the NASS; and (11) the NASS Accident Investigation Procedures Manual.

1.3 How to Use This Manual

This manual is designed to be updated periodically without the need for replacing the entire document. This will be accomplished by adding, deleting, and changing pages. Additions will be inserted in their proper location and will be identified by a different month and year. Pages which are changed will have the same month and year identifier.

When potential data encoding problems are detected in the NASS CDS Data Collection, Coding, and Editing Manual or interpretations of specific circumstances (including NASS CDS definitions) are required, the following procedures, outlined by NCSA, will be followed:

- (a) Potential problems that are identified at the team level will be sent to the cognizant zone center via the NASS CDS message system.
- (b) The zone center will review the potential problem.
 - (1) If it is a misinterpretation of the manual, a clarification will be provided by the cognizant zone center via the NASS CDS message system (with a telephone follow-up, if necessary).

- (2) If the potential problem is determined to be valid, the cognizant zone center will broadcast the potential problem with a recommended solution to the other zone center for review and concurrence. The final recommended solution will be sent to NCSA by the cognizant zone center for review and approval. This includes all additions, deletions, modifications or substantive interpretations that redefine, broaden, or narrow the established definition of NASS CDS variables or attributes.
- (c) Changes or interpretations which affect field data encoding and are approved by the NCSA will be given an effective implementation date and included in the NASS CDS Coding Manual.

The above procedures were not established to restrict team or zone center operations but to ensure that program objectives and goals are not inadvertently changed (i.e., a variable is redefined beyond its intended purpose). When defining variables, NCSA must consider their operational use within the restrictions of the data collection time frame and their intended purpose. Any diversions from these established procedures may destroy the data validity and/or result in serious analysis problems.

2.0 DESCRIPTION OF THE SAMPLING FRAME

2.1 Accidents Which Qualify for NASS

The procedures for properly developing the list of motor vehicle accidents within the study area which qualify for research are shown in Figure 2-1 and described below.

Start with a Police Reported Incident--All incidents which meet the criteria of a motor vehicle traffic accident, as defined in ANSI D16.1-1989, Section 2.4.20 (see figure 2-6, page 21), and are (a) reported on the state accident form, or on local accident forms, (b) signed by a police officer, and (c) available through the police agency files, are to be considered for study. Other accident report forms, such as special driver report forms, that do not meet the requirements above are excluded from consideration.

Must Be Reported to the State--For an incident to qualify as a NASS accident, the police jurisdiction must send a copy of the Police Accident Report (PAR) to the state for inclusion in the state accident statistics. If a report will not be included in the state file, then the incident is not to be included in the list. If the researcher cannot determine whether or not an incident will be reported to the state, then he/she should include it in the list.

Must Involve a Harmful Event--If the incident does not involve property damage and/or personal injury, do not include it in the list. The presence of a Police Accident Report (PAR) creates a rebuttable presumption that a harmful event has occurred. It is the duty of the researcher to scrutinize any PAR which alleges the absence of a harmful event.

The Harmful Event Must Have Occurred as a Result of an Accident--An accident involves at least one harmful event (ANSI D16.1-1989, section 2.4.1; see figure 2-6 page 20) produced by an unstabilized situation (ANSI D16.1-1989, section 2.4.4; see figure 2-6 pages 24-25). There are four (4) ways in which a harmful event occurs that are not a result of an accident. They are: (a) the harmful event results from a diseased condition, (b) the unstabilized situation was the result of deliberate intent, (c) the unstabilized situation was the result of legal intervention, or (d) the harmful event results from a cataclysm (ANSI D16.1-1989, section 2.4.5, see figure 2-6, page 18). To clarify the meaning of each of these "intervening circumstances", consider the examples below.

Disease: Even if the unstabilized situation is initiated by a disease such as cerebral hemorrhage, heart attack, diabetic coma, or epileptic seizure, which affects the driver of a motor vehicle in-transport, any subsequent harmful event which occurs is considered an accident. This includes any nonvehicular damage that this vehicle causes. The disease itself is not a harmful event for our classification as a traffic accident.

Deliberate Intent: A harmful event which has been intentionally produced does not fall within the definition of an unstabilized situation and, thus, is not an accident.

A driver kills himself/herself (suicide) or self-inflicts injury by driving a motor vehicle: (1) against a fixed object, (2) into a body of water, or (3) otherwise misuses a motor vehicle in transport, and this intent is

FIGURE 2-1

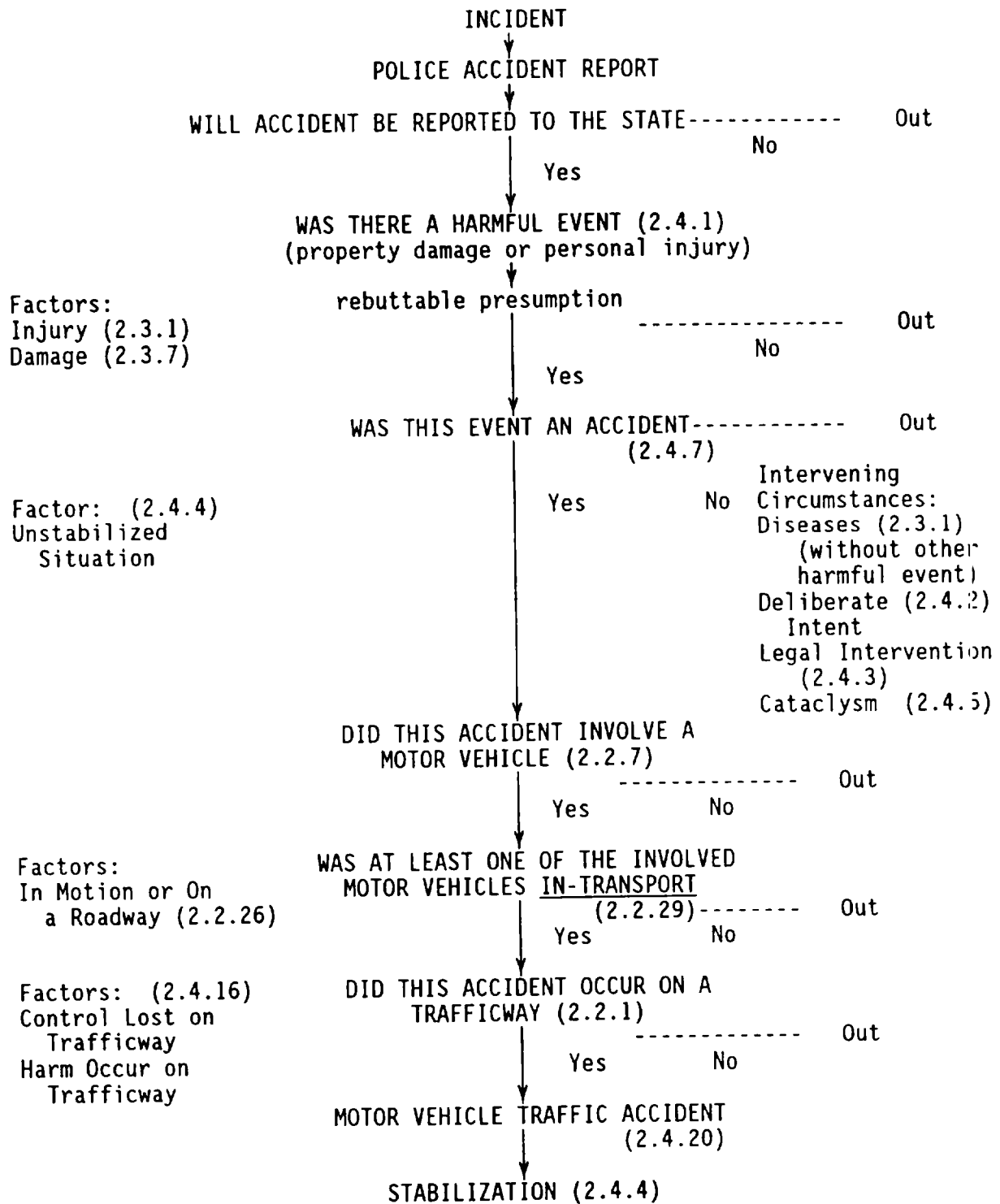

A motor vehicle traffic accident (MVTA) originates on a police accident report (PAR) filed with the state. It involves (a) a harmful event not directly resulting from a cataclysm, (b) produced by an unstabilized situation, (c) involving at least one motor vehicle, (d) in-transport [in motion or on a roadway] such that (e) the harmful event occurred on a trafficway or the unstabilized situation originated on a trafficway.

DESCRIPTION OF THE SAMPLING FRAME

verified in some manner. Such intentional events are not motor vehicle accidents. If during such intentional acts other injury or damage occurs that goes beyond the original intent, then these events are accidental and meet the specifications of a motor vehicle accident, unless the contrary can be clearly established.

Example 1: A driver who intends to commit suicide by driving head-on into another vehicle is involved in an accident, since any harmful event which results to the other vehicle or occupants goes beyond the original intent of the driver.

A person, having announced intent in some manner, causes death, injury, or damage by driving a motor vehicle against persons, motor or other road vehicles, or other property, with homicidal, injury, or damage inflicting intent; such intended acts are not motor vehicle accidents. If, in doing such intended acts, other injury or damage occurs that goes beyond the original intent (i.e., unintended consequences), these events are accidental and meet the specifications of a motor vehicle accident, unless the contrary can be clearly established.

Example 2: A driver (not connected with a law enforcement agency) who intentionally rams another vehicle, intending to inflict harm upon the vehicle or its occupants, is not involved in an accident. In Example 1 above, if the driver intended to inflict harm upon the other vehicle or its occupants, as well as inflict harm upon himself/herself, then this also would not be an accident.

However, malicious mischief, such as throwing a rock toward a motor vehicle, dropping an object from an overpass, or rolling an object upon a trafficway, is not considered to be deliberate intent unless it is clearly established that the act was directed toward a specified person or motor vehicle. This is defined in ANSI D16.1-1989, section 2.4.2 (see figure 2-6, page 19).

For the purposes of NASS PAR listing (given limited information on a PAR), a first harmful event resulting from deliberate intent should not be classified as a NASS accident, except where a subsequent harm occurs to a different vehicle or person such that the harm was an unintended consequence of the original event.

When in doubt, follow the instructions for listing the accident contained in Section 3.0 of this manual and call your zone center for guidance.

Legal Intervention: Legal intervention is a type of deliberate intent involving intentional acts by a law enforcement agent, officer, or other official. If in doing such intended acts, injury or damage occurs that goes beyond the original intent, then the other events are accidental and meet the specifications of a motor vehicle accident, unless the contrary can be clearly established. The following are examples of legal intervention and should not be classified as accidents:

- (a) A road block is set up to stop a lawbreaker, and the lawbreaker crashes into it, either intentionally or unintentionally.
- (b) A police unit cuts in front of another vehicle to force it to the curb or shoulder and, as a result, the two vehicles collide.

DESCRIPTION OF THE SAMPLING FRAME

- (c) A vehicle loses control as a result of bullets fired into it from a police officer's gun, and crashes.

The following are examples of an accident:

- (d) A driver, other than a lawbreaker, crashes unintentionally into a roadblock.
- (e) A lawbreaker, while eluding the police, loses control of his vehicle and crashes into another vehicle.
- (f) A police car skids and crashes while chasing a law violator.

If in (c) above, the vehicle had created a harmful event with another vehicle or person, then the presumed unintended consequences of the action would qualify this situation as an accident.

One example which has previously been encountered is as follows: A prisoner jumps out of a police car and is injured. An officer in another car who observes this event, writes a report. Is this an accident? Yes. Although the prisoner exited the car intentionally, the subsequent injury harmful event) occurred as an unintended consequence of the prisoner's escape attempt, thus constituting this event as an accident. It should be assumed that the injury was an unintended consequence of the prisoner's action unless the contrary can be clearly established.

For the purposes of NASS PAR listing, the same guidance as given above applies.

Cataclysm: ANSI D16.1-1989 lists the following events as catastrophic: a cloudburst, cyclone, earthquake, flood, hurricane, lightning, tidal wave, torrential rain, tornado, or volcanic eruption. If any one of these events was on-going at the time of the accident and produced the unstabilized situation which led to the harm, then the event(s) is (are) not considered an accident. One key phrase is "on-going". Consider the following example. A motor vehicle in-transport was overwhelmed by a landslide or an avalanche which was a direct result of a cataclysm, such as an earthquake, torrential rain, etc. This circumstance would not be considered an accident. However, this exclusion would not apply if a cataclysm were not in existence at the time of the event; nor would this exclusion apply if the motor vehicle was unintentionally driven against any fallen materials covering a trafficway as a result of any landslide or avalanche. As this example points out, the catastrophic event "exclusion" should occur very rarely.

Another key phrase is "produced the unstabilized situation". The situation in which a vehicle hydroplanes in a torrential rain and exits the roadway, striking another motor vehicle or object, would fit the criteria for a NASS accident, but the situation in which a cloudburst/torrential rain washes a roadway out from under a vehicle travelling on a roadway would be excluded from consideration as a NASS accident. (Remember, the cataclysm must be on-going at the time of the accident.)

DESCRIPTION OF THE SAMPLING FRAME

For the purposes of NASS PAR listing, list any accidents which you believe should be excluded under the cataclysm exception. Confirm their exclusion by relating the events to your zone center before drawing the NASS CDS sample.

After a NASS CDS accident has been selected the accident can be dropped if either subsequent research or an official ruling (e.g., by the police, by a medical examiner, etc.) reveals that one of the exceptions (i.e., disease, deliberate intent, legal intervention, or cataclysm) applies. When dropping the accident, notify your zone center and follow the procedures outlined in Section 5.3.

Must Involve A Motor Vehicle as Defined by ANSI--If a police report does not involve at least one motor vehicle as defined by ANSI D16.1-1989, section 2.2.7 (see figure 2-6, page 21), then it should be returned to the file and not included in the list which qualifies for inclusion.

Example: A bicycle which runs off the road and hits a tree is not a motor vehicle accident and should not be listed.

Must Involve a Motor Vehicle in-Transport--Use the ANSI D16.1-1989, section 2.2.29 (see figure 2-6, page 20) definition to determine if the motor vehicles in the accident are in-transport. There must be at least one motor vehicle in the accident in-transport for the accident to qualify. (NOTE: Any driverless vehicle of which any portion is located on the roadway is considered as a vehicle in-transport)

Example 1: A bicyclist running into a car which is parked off the roadway does not constitute a motor vehicle accident for this study and would be excluded. If a police report has been filled out on such an incident, return the police report to the file because it does not qualify.

Example 2: Vehicles parked on roads of reduced width, such as result from snow accumulation and incomplete snow removal, are to be considered in-transport if any portion is on the roadway.

Must Involve a Motor Vehicle In-Transport on a Trafficway--Exclude accidents which occur in places other than a trafficway. Examples of places which are not on the trafficway include private driveways and parking lots (except entrances and roadways within parking lots which are customarily used to get from the entrance to a parking aisle). Review carefully the diagrams depicting rural, urban, and divided trafficways in Figures 2-2, 2-3, and 2-4.

Example: An abandoned vehicle, a portion of which is on the roadway, is struck by a bicyclist, causing injury to the bicyclist. A police report is filled out by an investigating officer. Is this a motor vehicle accident? Yes it is, because there is a police reported incident involving a motor vehicle in-transport on a trafficway.

In each of these figures (2-2, 2-3, and 2-4) any harmful event: (1) resulting from an unstabilized situation, (2) involving an in-transport motor vehicle, and (3) which occurs between the two right-of-way lines, occurred on a trafficway. This means that "the harmful event" need not necessarily be the first harmful event; see the discussion of stabilization which follows. It is only necessary that "a harmful event" occur between the right-of-way lines. Further, any harmful event satisfying the conditions above which occurs on the "roadside" (Figures 2-2 and 2-4), in the "median" (Figure 2-4), or at or beyond the curbed area (Figure 2-3), qualifies as a NASS accident.

FIGURE 2-2

Example of a Rural Trafficway

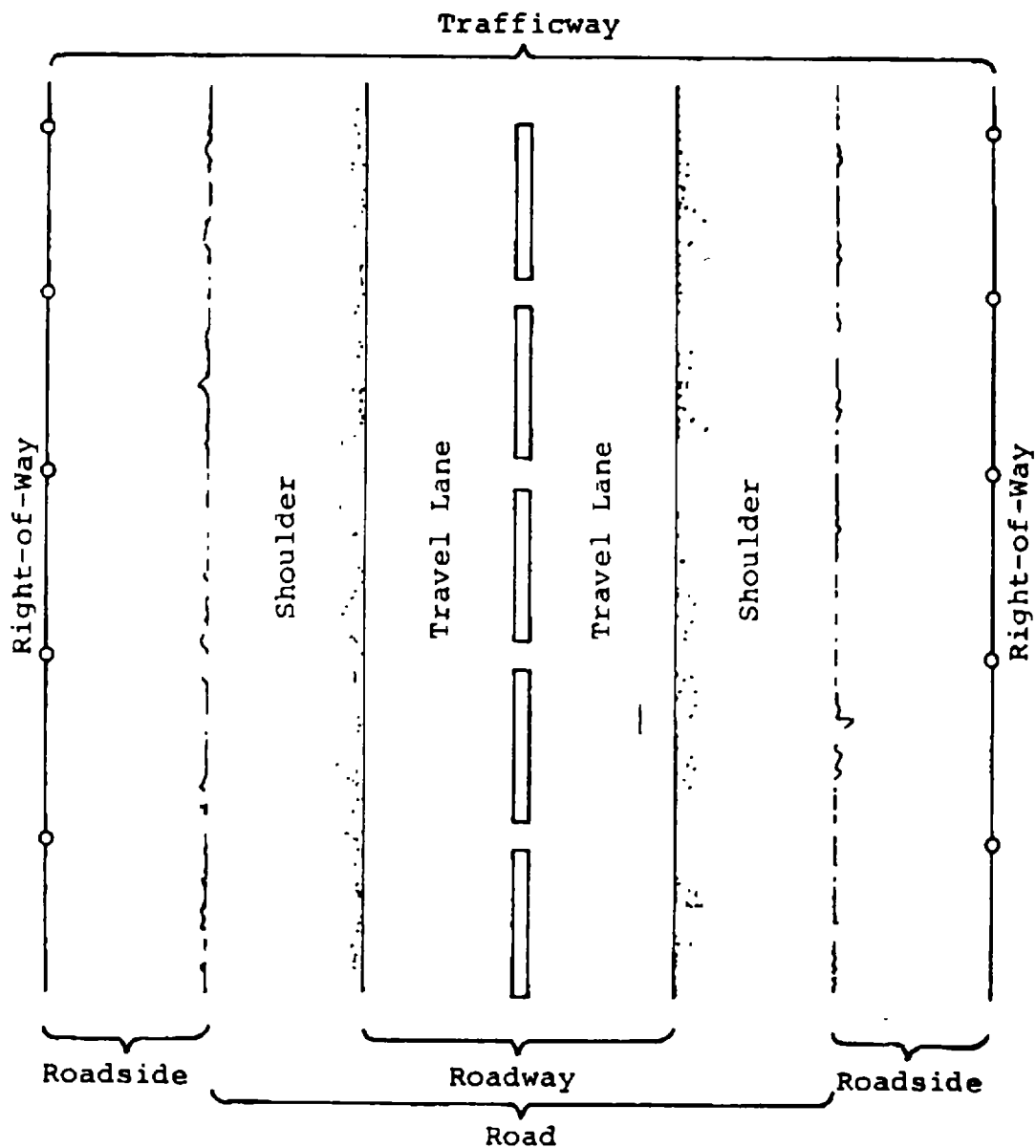
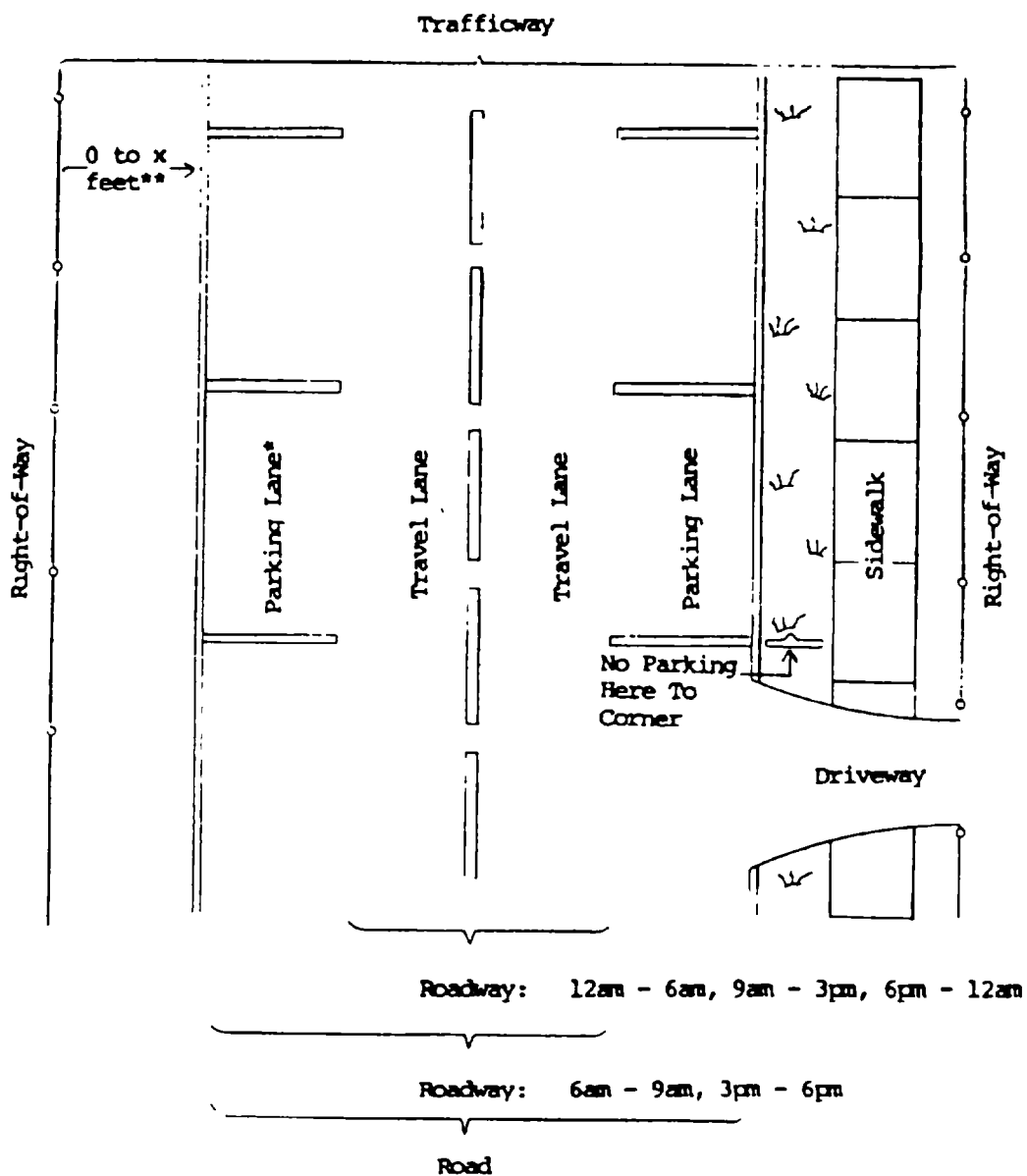

FIGURE 2-3

Example of an Urban Trafficway



* No parking allowed 6 to 9 a.m. or 3 to 6 p.m.

** The actual right-of-way in many cases will not be known. But it is clear that the trafficway always goes from curb to curb or from shoulder to shoulder.

FIGURE 2-4

Example of a Divided Trafficway

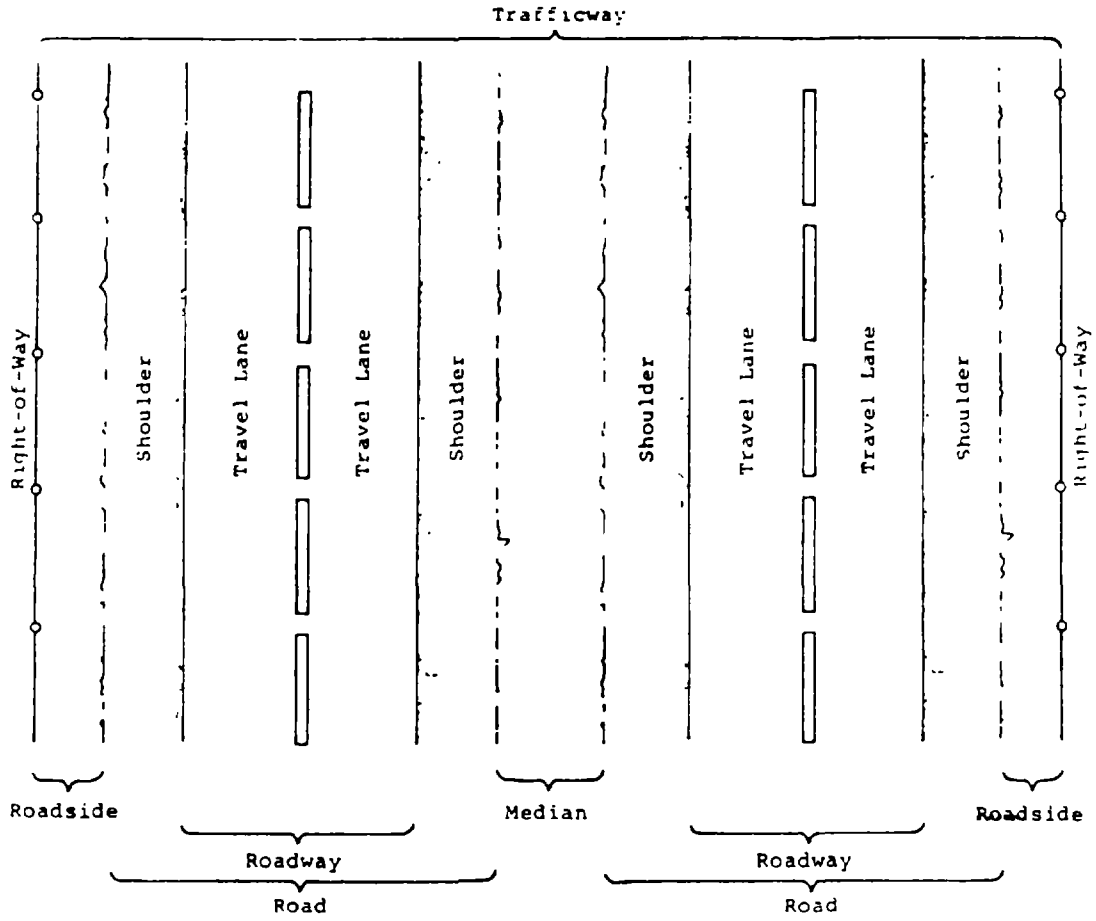

DESCRIPTION OF THE SAMPLING FRAME

Example: An in-transport motor vehicle entering or exiting the driveway (Figure 2-3) is involved in a harmful event between the right-of-way line and the beginning of the "road". Because the harmful event occurred on a trafficway, this police reported incident is a NASS accident.

A driveway is usually a private way providing access to property adjacent to a trafficway. An alley is an unnamed private way providing access, in general, to the rear of houses or buildings, some of which may be further served by a driveway.

Most driveways (but not all) and alleys are not trafficways in NASS. Examples of non-NASS trafficways are driveways to: (1) service stations, (2) residential dwellings, and (3) most apartment complexes, hotels, motels, and other commercial establishments.

As a general rule, assume sidewalks adjacent to roads are part of the public domain and thus are located within the right-of-way. This assumption also applies to utility poles located along a road.

Certain driveways within parking or shopping lots qualify as trafficways in NASS if they satisfy the three criteria discussed below.

The phrase "open to the public as a matter of right or custom" (ANSI D16.1-1989, section 2.2.1; see figure 2-6, page 23) causes problems when the property is privately owned. One problem area centers around shopping centers. Private ownership does not automatically disqualify a PAR for consideration as a NASS accident. The nature and extent of "land ways" (ANSI D16.1-1989, section 2.1.11, see figure 2-6, page 20) on private property, and the differences in accident reporting criteria by police, have brought about the narrowing of the definition of a trafficway (ANSI D16.1-1989, section 2.2.1; see figure 2-6, page 23) to that which can be operationally defined. In parking or shopping lots three criteria must be met:

- * There must exist two or more contiguous lanes of travel, usually these are clearly marked;
- * The land way must intersect another land way inside the lot or center; and
- * The junction of the internal land ways must have traffic controls (i.e., STOP or YIELD signs or markings).

The intent is to select those land ways which serve the purpose of getting traffic to and from the parking area; however, the fact that parking is allowed immediately adjacent to the land way does not disqualify it from consideration. Figure 2-5 (containing four schematics) does not attempt to cover the entire spectrum of possibilities but only illustrates some common examples. For situations A, B, and C none of the land ways should be considered as trafficways, since the criteria are not met. However, a NASS accident could occur at each of these locations if a harmful event occurred on the existing trafficway (i.e., Main Street), or an unstabilized situation originated on the trafficway which resulted in a harmful event on the private way or to the commercial property itself. In situation D the screened-in areas are roadways since they meet the criteria.

FIGURE 2-5

Situation A

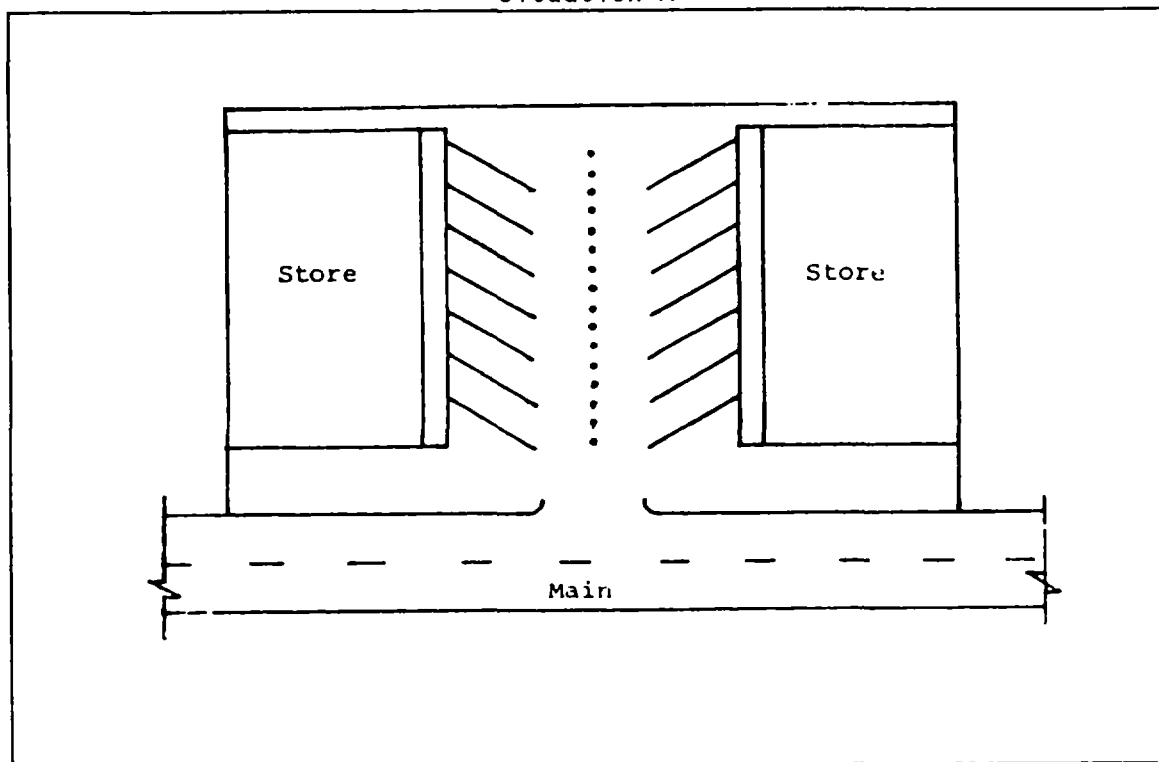

Situation B

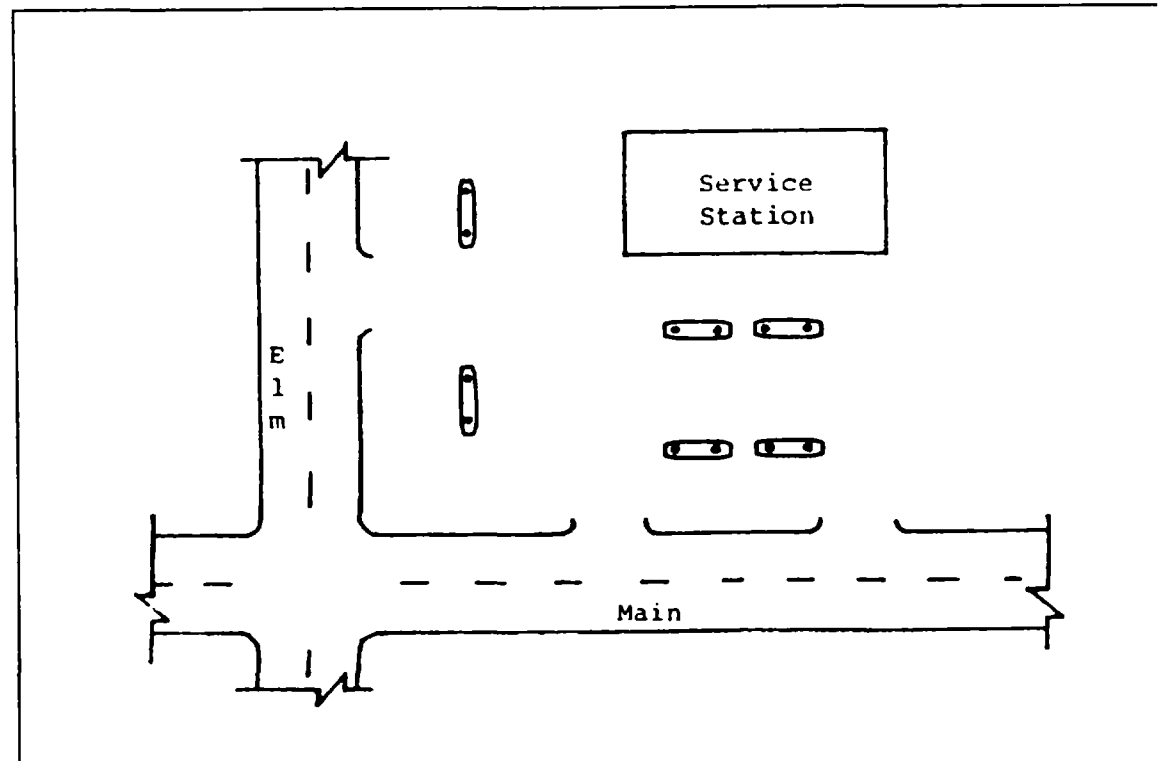
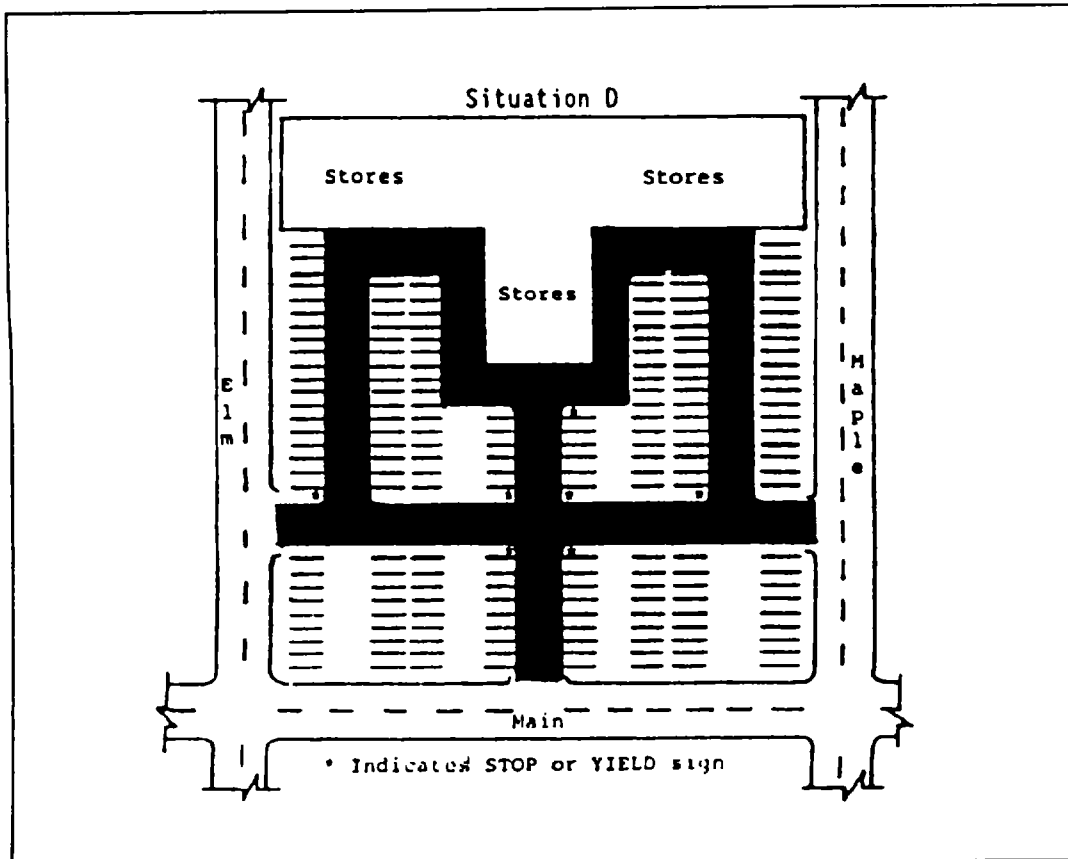
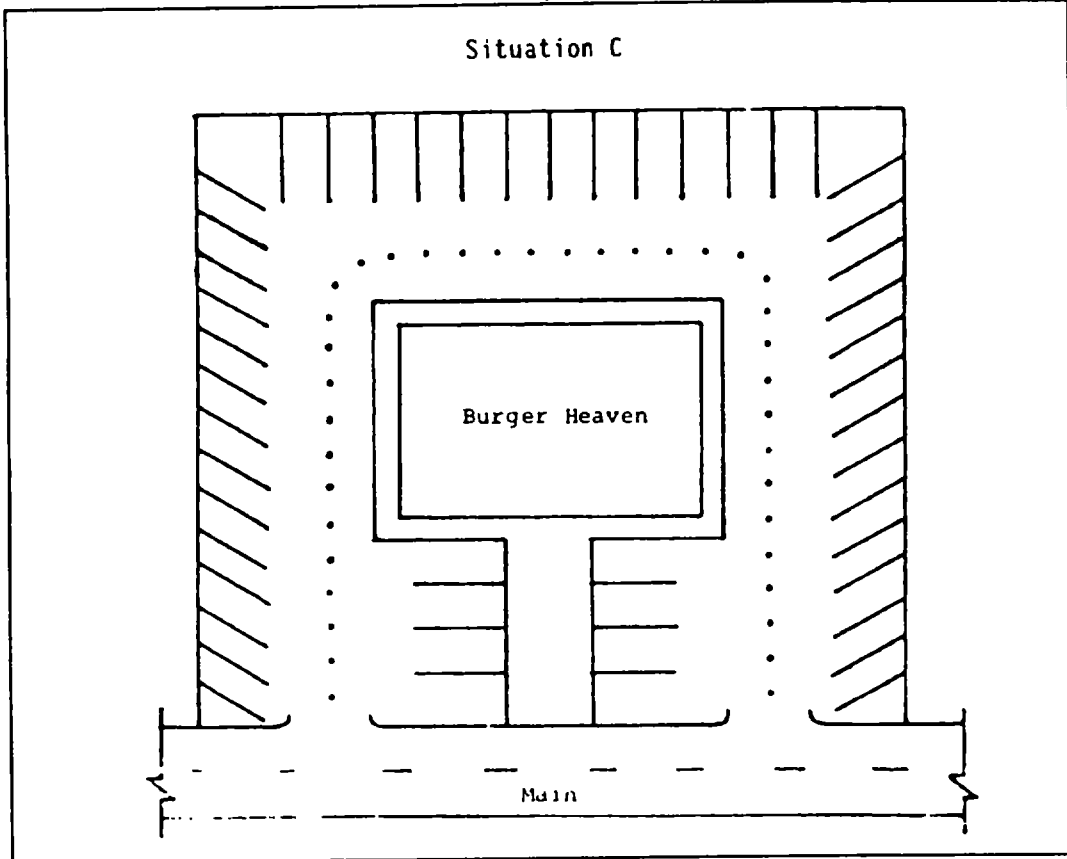

FIGURE 2-5 (Continued)



DESCRIPTION OF THE SAMPLING FRAME

In summary, each of the preceding qualifiers are designed to focus your attention to the specific subset of transportation-related incidents characterized as "motor vehicle traffic accidents" (see Figure 2-1). In NASS, you research Motor Vehicle Traffic Accidents. To put this subset of accidents which qualify for NASS in perspective, see Figure 2-6. This figure outlines the major definitional sections of ANSI D16.1-1989 into meaningful groups and shows how the phenomenon of motor vehicle traffic accidents fits into the overall transportation accident picture. Accompanying Figure 2-6 are the primary ANSI definitions of interest to NASS. Figure 2-6 refers to these definitions. These definitions are provided here as both a reference source to you, the NASS researcher, as well as enabling you to understand the larger transportation accident picture to which ANSI refers. Be sure to remember the location in this manual of Figures 2-1 and 2-6; together, they can serve as a handy reference source to remind you of what constitutes a "NASS accident".

Figure 2-7 depicts the relationship between the ANSI definitions and NASS. Shown in this figure are the four types of transport accidents (ANSI D16.1-1989, section 2.4.7, see figure 2-6, page 23): aircraft accidents, watercraft accidents, railway accidents, and road vehicle accidents. A priority scheme exists when a transport accident involves more than one type of transport vehicle. Any unstabilized situation that results from an aircraft is considered an aircraft accident. This means that if a plane crashes, impacting an in-transport motor vehicle, any damage or injury in the motor vehicle is considered part of the aircraft accident and is not a road vehicle accident; thus, if the associated motor vehicle is listed on a PAR, that PAR cannot be sampled in NASS. Similarly, if the unstabilized situation is caused by a watercraft, then all resulting damage is considered part of the watercraft accident. Aircraft accidents take precedence over watercraft accidents. Aircraft and watercraft accidents take precedence over railway and road vehicle accidents. If a road vehicle and a railway vehicle impact, the accident is classified according to which transport vehicle type produced the unstabilized situation. An example of an unstabilized situation produced by a railway vehicle is a derailment. If after a derailment a railway vehicle impacts a road vehicle, then the accident is classified as a railway accident. The vast majority of motor vehicle-train impacts are the result of an unstabilized situation created by the motor vehicle. Specifically, any time a train is on its tracks and is impacted by a motor vehicle, then the accident should be considered a road vehicle accident.

Figure 2-7 expands upon the four cell road vehicle accident matrix presented in Figure 2-6. Three of the cells contain examples of accidents that are not motor vehicle traffic accidents--Motor Vehicle Nontraffic Accident, Other Road Vehicle Traffic Accident, and Other Road Vehicle Nontraffic Accident. As this figure depicts, motor vehicle traffic accidents represent the vast majority of road vehicle accidents. NASS researches motor vehicle traffic accidents--except for those not reported to the State. All reported MVTAs are part of the General Estimates System (GES). MVTAs qualifying for the Crashworthiness Data System (CDS) are but a part of all MVTAs. The shaded area of the MTA cell represents the three types of GES accidents that do not qualify for the CDS. The definition of NASS sampling and the respective CDS and GES strata are covered in Section 2.2.

Ideally a police report should report only one accident. Unfortunately, this is not always true. There are practical and understandable reasons why this occurs. This manual would be remiss if it failed to discuss the issue of stabilization.

FIGURE 2-6

Manual on Classification of Motor Vehicle Traffic Accidents -- 5th Edition ANSI
D16.1-1989

	Section
Person	2.1.1
Property	2.1.2
Transport device	2.1.3
Animal	--
Transport vehicle	2.1.4
Aircraft	2.1.5
Watercraft	2.1.6
Land vehicle	2.1.7
Railway vehicle	2.2.4
Road vehicle	2.2.6
Motor vehicle	2.2.7
Other road vehicle	2.2.8
In-transport	2.2.29
Transport way	2.1.8
Airway	2.1.9
Waterway	2.1.10
Land way	2.1.11
Railway	2.2.3
Private way	2.2.2
Trafficway	2.2.1
Road	2.2.28
Shoulder	2.2.27
Roadway	2.2.26
Roadside	--
Median	--
Accidents	2.4
Harmful event	2.4.1
Injury	2.3.1
Damage	2.3.7
Unstabilized situation	2.4.4
Deliberate intent	2.4.2
Legal intervention	2.4.3
Cataclysm	2.4.5
Accident	2.4.6
Transport accident	2.4.7
Aircraft accident	2.4.8
Watercraft accident	2.4.9
Railway accident	2.4.11
Road vehicle accident	2.4.15
Motor vehicle accident	2.4.10
Other road vehicle accident	2.4.12
or	
Traffic Accident	2.4.16
Nontraffic accident	2.4.18
	2.4.17
	2.4.19

Motor Vehicle Traffic Accident

	Traffic Accident	Nontraffic Accident
Motor Vehicle	2.4.20	2.4.21
Other Road Vehicle	2.4.22	2.4.23

DESCRIPTION OF THE SAMPLING FRAME

FIGURE 2-6 (Definitions)

ACCIDENT: (2.4.6)

An accident is an unstabilized situation which includes at least one harmful event.

AIRCRAFT: (2.1.5)

An aircraft is a transport vehicle designed primarily for, or in use for, moving persons or property through the air from one place to another. Inclusions: airplane, balloon, dirigible, glider, parachute, spacecraft, and others.

AIRCRAFT ACCIDENT: (2.4.8)

An aircraft accident is a transport accident that involves an aircraft in-transport.

AIRWAY: (2.1.9)

An airway is a transport way reserved primarily for use by aircraft taking off, in flight, or landing.

AT-GRADE INTERSECTION: (2.5.12)

An at-grade intersection is an intersection where all roadways cross or join at the same level.

AUTOMOBILE: (2.2.10)

An automobile is a motor vehicle other than a motorcycle consisting primarily of a transport device designed for carrying ten or fewer persons. Automobiles may be classified by size or weight, or both. Size classification is based on wheelbase. Weight classification is based on curb weight, the weight of an automobile with standard equipment and a full complement of fuel and other fluids, but with no load of persons or property. Before classification, wheelbase should be rounded to the nearest inch and curb weight should be rounded to the nearest 100 pounds.

Primary automobile size categories are: [THREE-CATEGORY SET: (3.10.2.1)]

Small	-----	wheelbase 99 inches (2.51 meters) or less
Midsize	-----	wheelbase 100 to 109 inches (2.54 to 2.77 meters)
Large	-----	wheelbase 110 inches (2.79 meters) or more

Secondary automobile size categories are: [SEVEN-CATEGORY SET: (3.10.2.2)]

Ultrasmall	-----	wheelbase 89 inches (2.26 meters) or less
Minicompact	-----	wheelbase 90 to 94 inches (2.29 to 2.39 meters)
Subcompact	-----	wheelbase 95 to 99 inches (2.41 to 2.51 meters)
Compact	-----	wheelbase 100 to 104 inches (2.54 to 2.64 meters)
Intermediate	-----	wheelbase 105 to 109 inches (2.67 to 2.77 meters)
Full-size	-----	wheelbase 110 to 114 inches (2.79 to 2.90 meters)
Largest	-----	wheelbase 115 inches (2.92 meters) or more

Primary automobile weight categories are: [THREE-CATEGORY SET: (3.11.2.1)]

Light	-----	curb weight 2400 pounds (1089 kilograms) or less
Midweight	-----	curb weight 2500 to 3400 pounds (1134 to 1542 kilograms)
Heavy	-----	curb weight 3500 pounds (1588 kilograms) or more

Secondary automobile weight categories are: [SEVEN-CATEGORY SET: (3.11.2.2)]

A	-----	curb weight 1400 pounds (635 kilograms) or less
B	-----	curb weight 1500 to 1900 pounds (680 to 862 kilograms)
C	-----	curb weight 2000 to 2400 pounds (907 to 1089 kilograms)
D	-----	curb weight 2500 to 2900 pounds (1134 to 1315 kilograms)
E	-----	curb weight 3000 to 3400 pounds (1361 to 1542 kilograms)
F	-----	curb weight 3500 to 3900 pounds (1588 to 1769 kilograms)
G	-----	curb weight 4000 pounds (1814 kilograms) or more

BUS: (2.2.11):

A bus is a motor vehicle consisting primarily of a transport device designed for carrying more than ten persons.

CATAclysm: (2.4.5)

A cataclysm is an avalanche, cloudburst, cyclone, earthquake, flood, hurricane, landslide, lightning, tidal wave, tornado, torrential rain, or volcanic eruption.

CLASSIFICATION OF ROAD VEHICLES BY DAMAGE SEVERITY -- MOTOR VEHICLES: (3.2.2.1)

In order of precedence, motor vehicle categories by severity of damage are:

- Disabling damage to motor vehicle
- Functional damage to motor vehicle
- Other motor vehicle damage
- No damage to motor vehicle

COLLISION ACCIDENT: (2.6.2)

A collision accident is a road vehicle accident other than an overturning accident in which the first harmful event is a collision of a road vehicle in-transport with another road vehicle, other property or pedestrians (pedestrians or nonmotorists).

FIGURE 2-6 (Definitions - continued)

DAMAGE: (2.3.7)

Damage is harm to property that reduces the monetary value of that property. Inclusions: harm to wild animals, or birds, which have monetary value, and others. Exclusions: harm to wild animals, or birds, which have no monetary value. Harm to a snowbank unless, for example, additional snow-removal costs are incurred because of the harm. Mechanical failure during normal operation, such as tire blowout, broken fan belt, or broken axle, and others.

DELIBERATE INTENT: (2.4.2)

Deliberate intent is the classification given to the cause of an event which occurs when a person acts deliberately to cause the event or deliberately refrains from prudent acts which would prevent the occurrence of the event. Inclusions: suicide, self-inflicted injury, homicide, injury or damage purposely inflicted, and others. Exclusions: injury or damage beyond that which was intended, and others.

Examples:

1. When a driver intentionally kills or injures himself with a motor vehicle, by driving it against a fixed object or into a body of water, for example, the driver's death or injury is a result of deliberate intent.
2. When a driver intentionally kills or injures another person with a motor vehicle, by running into a pedestrian, for example, the death or injury is a result of deliberate intent.
3. When a driver intentionally causes damage with a motor vehicle, by ramming another vehicle, for example, the damage is a result of deliberate intent.

DISABLING DAMAGE: (2.3.11)

Disabling damage is road vehicle damage which precludes departure of the vehicle from the scene of the accident in its usual operating manner by daylight after simple repairs. Inclusions: vehicles which could be driven but would be further damaged thereby, and others.

Exclusions:

Damage which can be remedied temporarily at the scene without special tools or parts other than tires;
Tire disablement without other damage even if no spare tire is available;
Headlamp or taillight damage, which would make night driving hazardous but would not affect daytime driving;
Damage to turn signals, horn, or windshield wipers which makes them inoperative; and
Others.

DRIVER: (2.2.32)

A driver is an occupant who is in actual physical control of a transport vehicle or, for an out-of-control vehicle, an occupant who was in control until control was lost.

DRIVEWAY ACCESS: (2.5.9)

A driveway access is a roadway providing access to property adjacent to a trafficway. Inclusions: entrances to gas stations and others. Exclusions: any area not within a trafficway.

FULL TRAILER: (2.2.16)

A full trailer is a trailer, other than a pole trailer, designed for carrying property and so constructed that no part of its weight rests upon or is carried by the towing road vehicle. An auxiliary undercarriage assembly, commonly known as a converter dolly and consisting of a chassis, fifth wheel and one or more towbars, is sometimes used to convert a semitrailer to a full trailer.

FUNCTIONAL DAMAGE: (2.3.12)

Functional damage is any road vehicle damage, other than disabling damage, which affects operation of the road vehicle or its parts.

Inclusions:

Doors, windows, hood, and trunk lids which will not operate properly;
Broken glass which obscures vision;
Any damage which would prevent the motor vehicle from passing an official motor vehicle inspection;
Tire damage even though the tire may be changed at the scene;
Bumpers which are loose; and
Others.

Exclusions:

Dented or bent fenders, bumpers, grills, body panels, destroyed hubcaps, and others.

GRADE SEPARATION: (2.5.14)

A grade separation is a crossing at different levels of two trafficways, or a trafficway and a railway.

GROSS WEIGHT: (2.2.20)

Gross weight is the weight of a road vehicle including the weight of the road vehicle, its load of persons and property, and all added equipment.

GROSS VEHICLE WEIGHT RATING: (2.2.21)

A gross vehicle weight rating is (1) a value specified by the manufacturer for a single-unit truck, truck tractor or trailer, or (2) the sum of such values for the units which make up a truck combination. In the absence of a gross vehicle weight rating, an estimate of the gross weight of a fully loaded unit may be substituted for such a rating.

FIGURE 2-6 (Definitions - continued)

HARMFUL EVENT: (2.4.1)

A harmful event is an occurrence of injury or damage.

Inclusions:

Injury or damage resulting when a driver dies or loses consciousness because of a disease condition such as a stroke, heart attack, diabetic coma, or epileptic seizure. In such a case the immediate effect of the disease, such as the driver's death or loss of consciousness, is not itself considered to be a harmful event.

HEAVY TRUCK: (2.2.24)

A heavy truck is a truck which has a gross vehicle weight rating of more than 26,000 pounds (11,793 kilograms).

INJURY: (2.3.1)

An injury is bodily harm to a person. Exclusions: effects of diseases, such as stroke, heart attack, diabetic coma, epileptic seizure, and others.

INTERSECTION: (2.5.10)

An intersection is an area which (1) contains a crossing or connection of two or more roadways not classified as driveway access and (2) is embraced within the prolongation of the lateral curb lines or, if none, the lateral boundary lines of the roadways. Where the distance along a roadway between two areas meeting these criteria is less than 10 meters (33 feet), the two areas and the roadway connecting them are considered to be parts of a single intersection.

IN-TRANSPORT: (2.2.29)

The term "in-transport" denotes the state or condition of a transport vehicle which is in-motion or within the portion of a transport way ordinarily used for travel by similar transport vehicles.

When applied to motor vehicles, "in-transport" means in-motion or on a roadway. Inclusions: motor vehicle in traffic on a highway, driverless motor vehicle in-motion, motionless motor vehicle abandoned on a roadway, disabled motor vehicle on a roadway, and others.

In roadway lanes used for travel during rush hours and parking during off-peak periods, a parked motor vehicle is in-transport during periods when parking is forbidden.

JACKKNIFE ACCIDENT: (2.6.4)

A jackknife accident is a noncollision accident in which the first harmful event results from unintended contact between any two units of a multiunit road vehicle such as a truck combination.

JUNCTION: (2.5.11)

A junction is either an intersection or the connection between a driveway access and a roadway other than a driveway access.

LAND VEHICLE: (2.1.7)

A land vehicle is a transport vehicle which is neither an aircraft nor a watercraft.

LAND WAY: (2.1.11)

A land way is the space within property lines or other boundary lines of any transport way that is neither an airway nor a waterway.

LARGE MOTORCYCLE: (2.2.9.2)

A large motorcycle is any motorcycle other than a motor-driven cycle.

LEGAL INTERVENTION: (2.4.3)

Legal intervention is a category of deliberate intent in which the person who acts or refrains from acting is a law-enforcing agent or other official.

Examples:

1. If a lawbreaker crashes either intentionally or unintentionally into a road block set up by police to stop him, the crash is considered a result of legal intervention. If a driver other than the lawbreaker crashes into the road block, the crash is not considered to be a result of legal intervention.
2. If a police car is intentionally driven into another vehicle, the crash is considered to result from legal intervention. If a lawbreaker being pursued by the police loses control of his vehicle and crashes, the crash is not considered to result from legal intervention unless the police intended that the lawbreaker crash.

LIGHT TRUCK: (2.2.22)

A light truck is a truck which has a gross vehicle weight rating of less than 10,000 pounds (4,536 kilograms).

MEDIUM TRUCK: (2.2.23)

A medium truck is a truck which has a gross vehicle weight rating of from 10,000 to 26,000 pounds (4,536 to 11,793 kilograms).

FIGURE 2-6 (Definitions - continued)

MOPED: (2.2.9.4)

A moped is a speed-limited motor-driven cycle which may be propelled by pedalling. Exclusions: motor scooters, motorized or motor-assisted bicycles, and others.

MOTORCYCLE: (2.2.9)

A motorcycle is any motor vehicle having a seat or saddle for the use of its operator and designed to travel on not more than three wheels in contact with the ground. Exclusions: construction, farm, or industrial machinery. Inclusions: large motorcycle, motor-driven cycle, speed-limited motor-driven cycle, moped, motor scooter, motorized or motor-assisted bicycle, and others.

MOTOR-DRIVEN CYCLE: (2.2.9.1)

A motor-driven cycle is any motorcycle having an engine with less than 150 cubic centimeters displacement or with five brake horsepower or less.

MOTOR VEHICLE: (2.2.7)

A motor vehicle is any motorized (mechanically or electrically powered) road vehicle not operated on rails.

MOTOR VEHICLE ACCIDENT: (2.4.10)

A motor vehicle accident is a transport accident that (1) involves a motor vehicle in-transport, (2) is not an aircraft accident or watercraft accident, and (3) does not include any harmful event involving a railway train in-transport prior to involvement of a motor vehicle in-transport.

MOTOR VEHICLE NONTRAFFIC ACCIDENT: (2.4.21)

A motor vehicle nontraffic accident is a motor vehicle accident which is a nontraffic accident.

MOTOR VEHICLE TRAFFIC ACCIDENT: (2.4.20)

A motor vehicle traffic accident is a motor vehicle accident which is a traffic accident.

NONCOLLISION ACCIDENT: (2.6.3)

A noncollision accident is any road vehicle accident other than a collision accident.

Inclusions:

- overturning accident;
- jackknife accident;
- accidental poisoning from carbon monoxide generated by a road vehicle in-transport;
- breakage of any part of a road vehicle in-transport, resulting in injury or in further property damage;
- explosion of any part of a road vehicle in-transport;
- fire starting in a road vehicle in-transport;
- fall or jump from a road vehicle in-transport;
- occupant hit by an object in, or thrown against some part of a road vehicle in-transport;
- injury or damage from moving part of a road vehicle in-transport;
- object falling from, or in, a road vehicle in-transport;
- object falling on a road vehicle in-transport;
- toxic or corrosive chemicals leaking out of a road vehicle in-transport;
- injury or damage involving only the road vehicle that is of a noncollision nature, such as a bridge giving way under the weight of a road vehicle, striking holes or bumps on the surface of the trafficway, or driving into water, without overturning or collision;
- and others.

NONCONTACT ROAD VEHICLES: (3.6.3)

A "phantom" or "noncontact" road vehicle, such as one which forces another off the road but is itself not damaged, is not counted as one of the road vehicles involved in an accident.

NONTRAFFIC ACCIDENT: (2.4.17)

A nontraffic accident is a road vehicle accident which is not a traffic accident.

OCCUPANT: (2.2.30)

An occupant is any person who is part of a transport vehicle.

OTHER ROAD VEHICLE: (2.2.8)

An other road vehicle is any road vehicle other than a motor vehicle. Inclusions: animal-drawn vehicle (any type), animal harnessed to a conveyance, animal carrying a person, street car, pedalcycle, and others.

OTHER-ROAD-VEHICLE ACCIDENT: (2.4.12)

An other-road-vehicle accident is a transport accident that (1) involves an other road vehicle in-transport and (2) is not an aircraft accident, watercraft accident, motor vehicle accident, or railway accident.

OTHER-ROAD-VEHICLE NONTRAFFIC ACCIDENT: (2.4.23)

An other-road-vehicle nontraffic accident is an other-road-vehicle accident which is a nontraffic accident.

OTHER-ROAD-VEHICLE TRAFFIC ACCIDENT: (2.4.22)

An other-road-vehicle traffic accident is an other-road-vehicle accident which is a traffic accident.

FIGURE 2-6 (Definitions - continued)

OVERTURNING ACCIDENT: (2.6.1)

An overturning accident is a road vehicle accident in which the first harmful event is the overturning of a road vehicle.

PARKING LOT: (2.5.22)

A parking lot is an area used primarily for parking road vehicles. When paved and marked it commonly includes the following areas:

- (1) Parking stalls--areas reserved primarily for parked road vehicles
- (2) Parking lot aisles--areas used primarily for vehicular access to parking stalls. Parking lot aisles are not trafficways.
- (3) Parking lot ways--land ways which are used primarily for vehicular circulation within parking lots and for vehicular access to parking lot aisles. Parking lot ways in parking lots open to the public are trafficways.

PASSENGER: (2.2.33)

A passenger is any occupant of a road vehicle other than its driver.

PEDALCYCLE: (2.2.25)

A pedalcycle is a nonmotorized other road vehicle propelled by pedalling. Inclusions: bicycle, tricycle, unicycle, pedalcars, and others.

PERSON: (2.1.1)

A person is any living human. Within the context of this manual, a fetus is considered to be part of a pregnant woman rather than a separate individual. After death, a human body is not considered to be a person.

POLE TRAILER: (2.2.14)

A pole trailer is a trailer designed to be attached to the towing road vehicle by means of a reach or pole, or by being boomed or otherwise secured to the towing road vehicle, and ordinarily used for carrying property of a long or irregular shape such as poles, pipes, or structural members that are generally capable of sustaining themselves as beams between the supporting connections.

PRIVATE WAY: (2.2.2)

A private way is any land way other than a trafficway. The space within a crossing of a private way and a trafficway shall be considered to be (a) trafficway.

PROPERTY: (2.1.2)

Property is any physical object other than a person. Inclusions: real property, personal property, animals-- wild or domestic, signs, guardrails, impact attenuators, and others.

RAILWAY: (2.2.3)

A railway is any private way reserved primarily for land vehicles moving persons or property from one place to another on rails.

RAILWAY ACCIDENT: (2.4.11)

A railway accident is a transport accident that (1) involves a railway train in-transport and (2) is not an aircraft accident, watercraft accident or motor vehicle accident.

RAILWAY VEHICLE: (2.2.4)

A railway vehicle is any land vehicle that is (1) designed primarily for, or in use for, moving persons or property from one place to another on rails and (2) not in use on a land way other than a railway. Inclusions: street car on private way, and others. Exclusions: street car operating on trafficway and others.

ROAD: (2.2.28)

Road is that part of a trafficway which includes both the roadway and any shoulder alongside the roadway.

ROADWAY: (2.2.26)

A roadway is that part of a trafficway designed, improved, and ordinarily used for motor vehicle travel or, where various classes of motor vehicles travel or motor vehicles are segregated, that part of a trafficway used by a particular class. Separate roadways may be provided for northbound and southbound traffic or for trucks and automobiles. Exclusions: bridle paths, bicycle paths, and others.

ROAD VEHICLE: (2.2.6)

A road vehicle is any land vehicle other than a railway vehicle.

ROAD VEHICLE ACCIDENT: (2.4.15)

A road vehicle accident is a transport accident that is either a motor vehicle accident or an other-road-vehicle accident.

ROAD VEHICLE DAMAGE: (2.3.8)

Road vehicle damage is damage to a road vehicle. Inclusions: damage to any part of a road vehicle. Exclusions: injury to any person, whether or not the person is part of the road vehicle.

FIGURE 2-6 (Definitions - continued)

ROAD VEHICLE NONTRAFFIC ACCIDENT: (2.4.19)

A road vehicle nontraffic accident is a nontraffic accident.

ROAD VEHICLE TRAFFIC ACCIDENT: (2.4.18)

A road vehicle traffic accident is a traffic accident.

RURAL AREA: (2.5.2)

A rural area is any area which is not within urban areas.

SEMITRAILER: (2.2.15)

A semitrailer is a trailer, other than a pole trailer, designed for carrying property and so constructed that part of its weight rests upon or is carried by the towing road vehicle.

SHOULDER: (2.2.27)

A shoulder is that part of a trafficway contiguous with the roadway for emergency use, for accommodation of stopped road vehicles, and for lateral support of the roadway structure.

SINGLE-UNIT TRUCK: (2.2.17)

A single-unit truck is a truck consisting primarily of a single motorized transport device. When connected to a trailer, such a device may be part of a truck combination.

SPEED-LIMITED MOTOR-DRIVEN CYCLE: (2.2.9.3)

A speed-limited motor-driven cycle is any motor-driven cycle which:

- (1) will not attain a speed of more than 30 miles per hour (48 kilometers per hour) in one mile (1.609 kilometers) from a standing start,
- (2) has an engine with not more than 50 cubic centimeters displacement or with two brake horsepower or less, and
- (3) has a power drive system which does not require its operator to shift gears.

TRAFFICWAY: (2.2.1)

A trafficway is any land way open to the public as a matter of right or custom for moving persons or property from one place to another.

Inclusions:

Within areas with guarded entrances, such as military posts or private residential developments, land ways are trafficways if the guards customarily admit public traffic.

Exclusions:

A land way under construction is not a trafficway if traffic is prohibited from entering by signing or barriers which are in conformance with applicable standards. However, if any part of the land way is open to travel while the remainder is closed, that part which is open for traffic is a trafficway. Likewise, any temporary bypass of a construction site is a trafficway.

A land way temporarily closed to travel and marked by signing or barriers which are in conformance with applicable standards is not a trafficway even though used by authorized vehicles, such as maintenance vehicles, or when intentionally or inadvertently used by unauthorized vehicles. A land way open only to local traffic is not considered closed.

TRAFFIC ACCIDENT: (2.4.16)

A traffic accident is a road vehicle accident in which (1) the unstabilized situation originates on a trafficway or (2) a harmful event occurs on a trafficway.

TRAILER: (2.2.13)

A trailer is a road vehicle designed to be drawn by another road vehicle. Inclusions: pole trailer, semitrailer, full trailer.

TRANSPORT ACCIDENT: (2.4.7)

A transport accident is an accident (1) that involves a transport vehicle in-transport, (2) in which the first harmful event is not produced by the discharge of a firearm or explosive device, and (3) that does not directly result from a cataclysm. Inclusions: motor vehicle driven into water after a bridge was washed out during a hurricane or flood (cataclysm), motor vehicle driven into fall materials covering a roadway after a landslide or avalanche (cataclysm), and others.

TRANSPORT DEVICE: (2.1.3)

A transport device is any device designed primarily for moving persons or property along with the device itself from one place to another, except (1) a weapon, (2) a device used primarily within the confines of a building and its premises, or (3) a human-powered nonmotorized device not propelled by pedalling.

Inclusions:

Airplane, helicopter, hovercraft, ship, submarine, train, boxcar, caboose, snowmobile, automobile, bus, truck, trailer, semitrailer, motorcycle, bicycle, moped, and others.

Exclusions:

Devices not designed primarily for moving persons or property, such as construction machinery, farm or industrial machinery, snow plows, army tanks, etc.

FIGURE 2-6 (Definitions - continued)

Devices which do not move from one place to another, such as pipelines, elevators, escalators, ski lifts, conveyor belt systems, etc.

Weapons, such as guns, torpedoes, etc.

Devices used primarily within buildings and their premises, such as fork lifts in factories or lumber yards, motorized baggage trucks in railroad stations, etc.

Human-powered nonmotorized devices not propelled by pedalling, such as skis, scooters, roller skates, baby carriages, etc.

TRANSPORT VEHICLE: (2.1.4)

A transport vehicle consists of one or more devices or animals and their load. Such devices or animals must include at least one of the following:

- (1) a transport device, or a unit made up of connected transport devices, while idle or in use for moving persons or property from one place to another,
- (2) an animal or team of animals while in use for moving persons or property other than the animal or team itself from one place to another, or
- (3) a movable device such as construction, farm, or industrial machinery outside the confines of a building and its premises while in use for moving persons, the device itself, or other property from one place to another.

If such a device or animal has a load, the load is part of the transport vehicle. Loads include:

Persons or property upon, or set in motion by, the device or animal;

Persons boarding or alighting from the device or animal;

Persons or property attached to and in position to move with the device or animal.

If the load upon a transport device includes another transport device, the entire unit including the load is considered to be a single transport vehicle.

Inclusions:

- (1) Transport Devices--airplane towing a sailplane, tugboat pushing a barge, boxcar coupled to a caboose, truck tractor towing a semitrailer and a trailer, snowmobile towing a skier, automobile towing another automobile, and others;
- (2) Animals--horse and rider, dog team drawing a sled, team of horses drawing a sled, burro carrying a load of firewood, mule towing a boat on a canal, and others; and
- (3) Other Movable Devices--road grader while traveling under its own power from a maintenance depot to a working place, lawn mower while being ridden down a street under its own power, farm tractor while pulling a wagon loaded with corn from a field to a storage place, army tank while moving under its own power from a firing range to a motor pool, and others.

Exclusions:

- (1) Transport Devices--pickup truck while being used to power a saw, dump truck while spreading its load, tow truck while using its winch, jeep while pulling a device picking up golf balls, transit-mix concrete truck while discharging its load, dump truck while plowing snow, and others.

TRANSPORT WAY: (2.1.8)

A transport way is any way or place reserved or commonly used for the operation of transport vehicles. Exclusions: hiking trail, sidewalk, footpath, and others.

TRUCK: (2.2.12)

A truck is a motor vehicle designed primarily for carrying property. Inclusions: single-unit truck, truck combination. Exclusions: truck tractor.

TRUCK COMBINATION: (2.2.19)

A truck combination is a truck consisting primarily of a transport device which is a single-unit truck or truck tractor together with one or more attached trailers. Inclusions: truck tractor with semitrailer, truck tractor with semitrailer and one or more full trailers, single-unit truck with one or more full trailers, and others.

TRUCK TRACTOR: (2.2.18)

A truck tractor is a motor vehicle consisting of a single motorized transport device designed primarily for drawing trailers.

UNSTABILIZED SITUATION: (2.4.4)

An unstabilized situation is a set of events not under human control. It originates when control is lost and terminates when control is regained or, in the absence of persons who are able to regain control, when all persons and property are at rest.

Exclusions: Sets of events which are the result of deliberate intent or legal intervention.

Examples:

1. If intentional acts cause injury or damage beyond that reasonably to be expected from the acts, the unexpected injury or damage is not the result of deliberate intent. There is, therefore, an unstabilized situation unless the contrary can be clearly established.
2. In a motor vehicle crash live electric wires fall on a motor vehicle, but there is no injury from the electric current while the occupants remain in the motor vehicle. The unstabilized situation ends with the occupants in a temporary position of safety. Any subsequent injury resulting from attempts by the occupants to leave the motor vehicle, or attempts by others to rescue the occupants, is a part of a new unstabilized situation.

DESCRIPTION OF THE SAMPLING FRAME

FIGURE 2-6 (Definitions - continued)

3. In a motor vehicle crash the occupants of the motor vehicle are carried or thrown into water, but there is no injury from the submersion and the occupants reach a temporary position of safety. At this point the unstabilized situation has ended. Any subsequent injury from attempts by the occupants to reach shore, or from attempts by others to rescue the occupants is part of a new unstabilized situation.
4. In a motor vehicle crash objects are loosened but remain in place until all persons are removed from danger from objects that might fall or roll. No property damage would result if the objects fell or rolled. This ends the unstabilized situation. Any subsequent injury attributable to the fall or roll of the loosened objects is not part of the original unstabilized situation.
5. In a motor vehicle crash the motor vehicle catches on fire and is burning, but all occupants have been rescued and the fire is under control. No additional property damage is expected. This is the end of the unstabilized situation. If the heat of the fire ignites nearby combustible materials, any subsequent injury or damage from the induced ignition is not part of the original unstabilized situation.
6. In a motor vehicle crash an involved motor vehicle carrying explosive materials is stopped and occupants and bystanders are removed from the scene. At this point the unstabilized situation is ended. If the explosive materials detonate during later attempts to remove or salvage them, any injury or damage resulting from the explosion is not part of the original unstabilized situation.

URBAN AREA: (2.5.1)

An urban area is an area whose boundaries shall be those fixed by responsible state and local officials in cooperation with each other and approved by the Federal Highway Administration, U.S. Department of Transportation. Such boundaries are established in accordance with the provisions of Title 23 of the United States Code. Urban area boundary information is available from State highway or transportation departments. In the event that boundaries have not been fixed as above for any urban place designated by the Bureau of the Census having a population of 5,000 or more, the area within boundaries fixed by the Bureau of the Census shall be an urban area.

WATERCRAFT: (2.1.6)

A watercraft is a transport vehicle designed primarily for, or in use for, moving persons or property on or through, and supported by, water from one place to another.

WATERCRAFT ACCIDENT: (2.4.9)

A watercraft accident is a transport accident if (1) it involves a watercraft in-transport and (2) is not an aircraft accident.

WATERWAY: (2.1.10)

A waterway is a transport way reserved primarily for use by watercraft.

Figure 2-7

NASS ACCIDENT OVERVIEW

Aircraft Accidents
 Watercraft Accidents
 Railway Accidents
 Road Vehicle Accidents

	TRAFFIC ACCIDENT	NONTRAFFIC ACCIDENT																																																								
MOTOR VEHICLE	<p>General Estimate System</p> <p style="text-align: center;"><u>X, Y & Z Strata</u></p> <p style="text-align: center;">Crashworthiness Data System</p> <table border="1"> <thead> <tr> <th rowspan="4">Late Model Year (LMY) Vehicle Involvement</th> <th colspan="8">Most Severe Police Reported Injury</th> </tr> <tr> <th rowspan="3">FATAL INJURY "K"</th> <th colspan="4">Transported</th> <th colspan="3">Not Transported</th> </tr> <tr> <th colspan="4">Serious Injury "A"</th> <th rowspan="2">Injured or Unknown If Injured "B", "C", or "U"</th> <th colspan="2">Injured, Not Injured or Unknown If Injured "A", "B", "C", "O", or "U"</th> </tr> <tr> <th colspan="2">Single CDS Applicable Vehicle</th> <th colspan="2">Multiple CDS Applicable Vehicles</th> <th rowspan="2">At least One CDS Applicable Vehicle Was Towed</th> <th rowspan="2">No CDS Applicable Vehicles Were Towed</th> </tr> <tr> <th colspan="2">Towed</th> <th colspan="2">At least Two Towed</th> <th rowspan="2">Only One Towed</th> </tr> <tr> <th>Hos-pital-ized</th> <th>Not Hos-pital-ized</th> <th>Hos-pital-ized</th> <th>Not Hos-pital-ized</th> </tr> </thead> <tbody> <tr> <td>Injury in Towed, LMY, CDS Applicable Vehicle</td> <td>A</td> <td>J</td> <td>C</td> <td>J</td> <td>C</td> <td>E</td> <td>G</td> <td rowspan="2">NOT IN SCOPE SEE Table 2-2</td> </tr> <tr> <td>Injury not in Towed, LMY, CDS Applicable Vehicle</td> <td>B</td> <td>K</td> <td>D</td> <td>K</td> <td>D</td> <td>F</td> <td>H</td> </tr> </tbody> </table>	Late Model Year (LMY) Vehicle Involvement	Most Severe Police Reported Injury								FATAL INJURY "K"	Transported				Not Transported			Serious Injury "A"				Injured or Unknown If Injured "B", "C", or "U"	Injured, Not Injured or Unknown If Injured "A", "B", "C", "O", or "U"		Single CDS Applicable Vehicle		Multiple CDS Applicable Vehicles		At least One CDS Applicable Vehicle Was Towed	No CDS Applicable Vehicles Were Towed	Towed		At least Two Towed		Only One Towed	Hos-pital-ized	Not Hos-pital-ized	Hos-pital-ized	Not Hos-pital-ized	Injury in Towed, LMY, CDS Applicable Vehicle	A	J	C	J	C	E	G	NOT IN SCOPE SEE Table 2-2	Injury not in Towed, LMY, CDS Applicable Vehicle	B	K	D	K	D	F	H	<p>For example:</p> <ol style="list-style-type: none"> (1) snowmobile hits tree in woods, (2) Two cars impact in a service station, (3) on-farm vehicular accident, or (4) golfer overturns golf cart near 13th green.
	Late Model Year (LMY) Vehicle Involvement		Most Severe Police Reported Injury																																																							
FATAL INJURY "K"			Transported				Not Transported																																																			
			Serious Injury "A"				Injured or Unknown If Injured "B", "C", or "U"	Injured, Not Injured or Unknown If Injured "A", "B", "C", "O", or "U"																																																		
		Single CDS Applicable Vehicle		Multiple CDS Applicable Vehicles		At least One CDS Applicable Vehicle Was Towed		No CDS Applicable Vehicles Were Towed																																																		
Towed		At least Two Towed		Only One Towed																																																						
Hos-pital-ized	Not Hos-pital-ized	Hos-pital-ized	Not Hos-pital-ized																																																							
Injury in Towed, LMY, CDS Applicable Vehicle	A	J	C	J	C	E	G	NOT IN SCOPE SEE Table 2-2																																																		
Injury not in Towed, LMY, CDS Applicable Vehicle	B	K	D	K	D	F	H																																																			
OTHER ROAD VEHICLE	<p>For example: (1) pedalcycle impacts parked (not in-transport) motor vehicle on road, (2) horse-drawn hay wagon loses a wheel ejecting and injuring wagon occupants, or (3) animal carrying a person bolts ejecting and injuring occupant.</p>	<p>For example: pedalcycle impacts vehicle parked in parking stall in a parking lot.</p>																																																								

DESCRIPTION OF THE SAMPLING FRAME

Stabilization--At times, one police report will contain more than one accident. This will happen when events constituting an accident have stabilized (as defined in ANSI D16.1-1989, section 2.4.4, see figure 2-6, page 24-25) and units involved in the first sequence are subsequently involved in another accident sequence which is recorded on the same police report. If more than one accident is recorded on a police report, based on the ANSI definition of stabilized, then use the following protocol to determine which of the accidents is to be listed and stratified.

First, identify all NASS accidents and exclude from consideration those that are not NASS accidents.

Second, three situations exist (identified below as A, B, and C). Identify the situation that is applicable to the PAR under consideration and follow the protocol provided.

Situation A:

If only one accident qualifies for the CDS (Strata A-K--see section 2.2 below) and one or more GES (General Estimates System) accidents not applicable to the CDS (X Stratum, Y Stratum, or Z Stratum--see section 2.2 below) exist on the same PAR, choose the CDS accident.

Situation B:

If more than one accident qualifying for the CDS exists on the same PAR, follow steps (1) through (4) below to select the CDS accident to stratify. Ignore any GES accidents not applicable to the CDS which may also be on the PAR.

- (1) If injury is involved and you can determine the relative degree of injury between accidents and one accident is of higher severity, then choose that accident.
- (2) If injury is involved and you determine that the relative injury between accidents is approximately equal, then choose the first of the highest equal injury accidents.
- (3) If injury is involved but you cannot determine the relative injury between accidents, then choose the first accident.
- (4) If no injuries, then choose the first accident.

Situation C:

If no accident qualifying for the CDS exists on a PAR but more than one GES accident not applicable to the CDS exists on the PAR, then choose the X Stratum, Y Stratum, or Z Stratum by following the criteria in (1) through (4) above to select the GES accident to stratify.

In those cases where an accident, by NASS criteria, other than the one reported on the PAR, is alluded to (e.g., in the narrative), there is a rebuttable presumption that this PAR is the only PAR that will be submitted to report both accidents. This presumption may be overridden if the researcher has knowledge of: (1) another PAR on file, (2) a statement in the narrative indicating that there is, or will be, another PAR, or (3) the dispatcher or other police personnel having knowledge of the accidents, indicates that there is, or will be, another report filed.

Example: The PAR narrative states: "Vehicle #1 had been struck by an unidentified vehicle that did not stop. As driver of Vehicle #1 opened door

DESCRIPTION OF THE SAMPLING FRAME

to get out, door caught rear wheels of trailer of Vehicle #2." There is no other mention of the unidentified vehicle which failed to stop anywhere else on the PAR. The PAR contains two separate accidents. The injury severity for both is "no injury"; therefore, the first is used for NASS CDS stratification purposes, independent of the police emphasis on the second.

However, caution must be exercised when separating accidents on a PAR. At times, it will appear that two distinct events of an accident sequence should be considered separately. According to ANSI D16.1-1989, section 2.4.4 (see figure 2-6, page 24), an unstabilization terminates "...when all persons and property are at rest..." "Property" can refer to the damaged vehicles, separated components of the vehicles, or cargo. Often the interviews will be the only source for determining whether or not stabilization occurred before the second event.

Example: Two vehicles collide in the eastbound lanes of a divided trafficway. Cargo from one vehicle spills into the westbound lanes and another vehicle is damaged. If it can be determined that stabilization never occurred (i.e., the cargo struck the vehicle, or the vehicle struck the moving cargo), the two harmful events would be considered one accident, and all three vehicles considered applicable to the NASS accident. If it should be discovered during the research that the cargo came to rest for a period of time prior to being struck by the third vehicle, then the events would be considered as two separate accidents.

2.1.1 Questions and Answers About Which Incidents Qualify for NASS

Please find below a list of questions aimed at helping researchers determine if an accident report qualifies for the NASS.

Question: If a motor vehicle in-transport hits a pothole, causing damage to a tire and wheel or to the exhaust system, is this incident eligible for NASS?

Answer: Yes, it is eligible for NASS. To be eligible, recall that, first, a police report must be filed and, second, that the criteria set forth in ANSI D16.1-1989, section 2.3, have been met. In essence, these criteria mandate that the following occurs: (a) a harmful event (damage or injury), (b) involving a motor vehicle, (c) in-transport, and (d) that the unstabilized situation originated (i.e., control was lost) on a trafficway or the harmful event occurred on a trafficway. If the parties involved suffered damage to the wheels, suspension, exhaust system, or undercarriage of their vehicles, then you have a valid accident for NASS; however, ANSI D16.1-1989, section 2.3.7 (see figure 2-6, page 19) specifically excludes damage from **mechanical failure** during normal operation. The intent is to exclude a "blow-out" incident where the driver brings the vehicle safely to the side of the road without incurring other damage. This exclusion was not meant to exclude an incident where a "blow-out" led to other vehicle damage (e.g., ran into a tree) while the driver was attempting to regain control.

Question: A man driving a motor home slams on his brakes to avoid another vehicle in his lane; he succeeds. However, his young daughter is thrown against the instrument panel and suffers injury. Is this a motor vehicle accident?

Answer: It is a motor vehicle traffic accident involving one vehicle. The other vehicle is not involved.

Question: A car loses control on a trafficway, leaves the trafficway, and does

DESCRIPTION OF THE SAMPLING FRAME

damage to a private lawn. There is no damage to the car and the driver is not hurt. Is this a traffic accident?

Answer: Yes! It would also be a traffic accident if the motor vehicle left the scene before the police arrived (i.e., a hit-and-run vehicle). In these situations, the determining factor is whether the police filed an accident report that was eventually reported to the state.

Question: A pulp wood truck is travelling down a public road with an insecure load; the load shifts and all of the wood falls off the truck. The wood bounces and rolls, and then strikes a fence on the side of the road, doing approximately \$500 worth of damage to the fence. There is no damage to anything except the fence and no other vehicles are involved; however, there is a police report made out on the incident, which is eventually included in the state file. Does this incident qualify for NASS?

Answer: Yes this situation does qualify for NASS. The harmful event is the damage to the fence.

Question: A power line falls onto a motor vehicle in-transport, causing personal damage. Is this incident applicable for NASS? A tree falls onto a motor vehicle as it was driving down the road. Is this incident applicable for NASS.

Answer: Both of the above situations, plus many similar ones (e.g., rocks fell onto the vehicle), fall into the category of near cataclysmic events. ANSI D16.1-1989, section 2.4.7 (see figure 2-6, page 23) excludes, from the definition of a transport accident, harmful events resulting from a cataclysm. To further define this exclusion, the cataclysm must have been on-going at the time the accident happened. Cataclysms are defined in ANSI D16.1-1989, section 2.4.5, (see figure 2-6, page 18). Therefore, to exclude the situation of an object (power line, rock, etc.) falling on a motor vehicle in-transport, the cataclysm which caused the object to fall must have been on-going at the time of the incident. In terms of the specific questions, they are NASS accidents.

Question: We have a rare situation where a bystander dropped his gun; it struck the ground and discharged. A bullet struck the windshield of a vehicle in-transport. Should this incident be listed as a motor vehicle accident?

Answer: No, this is a firearms accident. However, it is entirely possible that a firearms accident could trigger a traffic accident.

Question: A convertible is traveling with its top down, and occupants are riding on its boot. The vehicle swerves to avoid another vehicle; one of the occupants falls from the vehicle and is injured. Is this incident a NASS accident?

Answer: Yes, it is a noncollision (as defined in ANSI D16.1-1989, section 2.6.3) type NASS accident.

Question: A tow truck is towing a pickup. The towed pickup truck loses an axle, which subsequently strikes a vehicle parked in a parking lot. Is this a NASS accident?

Answer: Yes it is. A motor vehicle in-transport loses part of its cargo (axle of pickup), which strikes (harmful event) a vehicle not in-transport.

DESCRIPTION OF THE SAMPLING FRAME

Question: A motor vehicle, parked in a driveway, slipped out of gear, rolled down the drive, crossed the street, and struck a tree on the other side. Is this an applicable accident?

Answer: It depends on the location of the vehicle when control was lost and the location when the harm occurred. To be an applicable NASS accident, the control must have been lost on a trafficway or the harmful event must have occurred on a trafficway. If the vehicle was up in its driveway (i.e., outside of the trafficway--it must be clearly beyond the curb, utility poles, or any sidewalk boarding the curb), then control was lost (i.e., control is assumed lost when the gears slipped) off a trafficway. If the tree that was struck was off the trafficway (same as above), then it is not an applicable NASS accident and whether the vehicle is on or off the roadway at impact is irrelevant. Given that you have to make a decision at the police station (must have a police report to start with), scrutinize the police report for any information which would help you in determining the locations of the key elements. If the police report is uninformative concerning these key elements, include the accident for listing purposes. If selected in the NASS CDS sample, a review of the scene should determine whether or not the accident remains.

2.2 NASS PAR Sampling

Before a NASS accident, represented by a PAR, can be selected for research in either the CDS or the GES (**GENERAL ESTIMATES SYSTEM**) it must first be listed with all other qualifying PARs (the process of listing PARs is described in Section 3.2). From the listed PARs a CDS and a GES sample will be chosen.

To increase the efficiency of the samples, qualifying PARs are grouped into sampling Strata based on accident outcome, and the samples are selected. The selection of the PARs for investigation is done in two phases. The first phase uses information from the police accident report to first stratify the PARs and includes the five sampling variables listed in Section 2.2.1. The second phase uses hospital information to determine the second stratification for the PARs and is also explained in Section 2.2.1.

2.2.1 Sampling Variables

Type of Vehicle is the indication on the police report of the types of vehicles involved in the NASS accident. Vehicles are classified as either "CDS applicable vehicles", "Medium/heavy trucks", or as "other vehicles". CDS applicable vehicles include the vehicle types: automobiles, automobile derivatives, utility vehicles, van based light trucks, and light conventional trucks where the qualifying trucks must have a gross vehicle weight rating (GVWR) of less than or equal to 4,500 kilograms. The exact distinction among a CDS applicable vehicle, a medium/heavy truck, and an other vehicle is defined in terms of the variable Body Type (GV07). **CDS applicable vehicles** are in-transport vehicles whose Body Type (GV07) equals: "01" through "49". **Medium/heavy trucks** are in-transport vehicles whose Body Type (GV07) equals : "60" through "79". **Other vehicles** are in-transport vehicles whose Body Type (GV07) equals: "50" through "59" and "80" through "99". If there is no indication by the police officer of the type of vehicles involved in the NASS accident (e.g., a hit-and-run accident), then classify the vehicle as an unknown body type (GV07="99").

Where Body Type (GV07) is known but not distinguishable on the PAR for CDS applicable vehicle identification purposes (e.g., "passenger car", "truck", "van"), refer to your VIN reference materials to decode the VIN if the VIN is

DESCRIPTION OF THE SAMPLING FRAME

present, or refer to other sections (i.e., diagram, narrative, etc.) of the PAR that may provide identifying information. If the VIN is not present and GV07 is still unknown, then consider, for sampling purposes, the GV07 code to be: "09" if the PAR only indicates that a passenger car was involved; "29" if the PAR only indicates that a van was involved; "39" if the PAR only indicates that a pickup was involved; "48" if the PAR indicates truck without reference to pickup or van and the GVWR is known to be less than 4,500 kilograms or "49" if the vehicle's Body Type (automobile, utility, van or light truck) is unknown but the GVWR is known to be less than 4,500 kilograms. Consider the vehicle in question to be a CDS applicable vehicle. If the PAR indicates that the vehicle's Body Type is a truck but does not reference the GVWR, then consider the GV07 code to be "79", and consider the vehicle in question to be a non-CDS applicable vehicle (medium/heavy truck).

Most severe police reported injury is the indication on the police report of injury severity, if any, to any person involved in the NASS accident. Each person's severity should be translated into the KABCO codes, if necessary (see explanation of variable OA34 of this manual).

For purposes of stratification, the CDS is only concerned with the most severely injured occupant of any towed CDS applicable vehicle. The injury severity to persons not in a towed CDS applicable vehicle is not considered. On the other hand, the GES is concerned with the most severely injured person in the NASS accident.

Disposition of the injured is the indication on the police report that at least one occupant not sustaining a "K" injury of a towed CDS applicable vehicle went directly from the accident scene to a treatment facility (hospital, clinic, doctor's office, etc.) for treatment (e.g., not transported solely to have a blood alcohol test conducted). The means of transportation is not a consideration nor is the length of stay at the facility.

For purposes of stratification, the CDS is only concerned with the transportation of occupants of towed CDS applicable vehicles who did not sustain a "K" injury. The transportation of any one occupant of a towed CDS applicable vehicle, not sustaining a "K" injury, qualifies the NASS CDS accident as "transported". The transportation or nontransportation of any person who: (1) sustained a "K" injury or (2) was not in a towed CDS applicable vehicle, is not considered. On the other hand, the GES does not consider the disposition of the injured for sampling purposes.

If the PAR does not indicate the disposition of the injured occupant(s) of the towed CDS applicable vehicle(s), then consider the NASS accident as having no transported occupants. However, if the PAR does state that an occupant was transported but does not specify which occupant, then assume that the occupant with the highest injury coded in the accident was transported.

Tow status of the vehicles is the indication on the police report that an in-transport vehicle involved in the NASS accident was towed due to damage from the accident scene. Any item on the PAR may be used to help determine tow status (e.g., damage severity, narrative). If no CDS applicable vehicle is indicated on the police report as towed due to damage from the accident scene, then the NASS accident is not of interest to the CDS, but is classified in the GES as either a X Stratum, Y Stratum or Z Stratum accident. However, there is an exception. Even if the police report indicates that an in-transport CDS applicable vehicle was towed from the scene due to damage and the only harmful event occurring to this vehicle is a noncollision which resulted from a fire,

DESCRIPTION OF THE SAMPLING FRAME

explosion, an intraunit damage (other than a jackknife), or a noncollision injury, then do not consider this vehicle as "towed due to damage" for CDS stratification purposes.

Unfortunately, PARs do not identify with one-hundred percent certainty which towed vehicles were towed as a result of damage. Therefore, when a vehicle is listed on the police accident report as towed, the default assumption is that the vehicle was towed due to damage. In addition, the PAR may be blank or unclear as to whether the vehicle was towed at all. If so, use the default assumption that the vehicle was not towed.

Model Year of Vehicle is the indication on the police report of each accident involved vehicle's production (model) year. The production year is not necessarily the same as the actual calendar year in which the vehicle was produced. For purposes of CDS stratification, all in-transport vehicles are separated into either "late model year vehicles" or "nonlate model year vehicles". In calendar year 1994 a late model year vehicle is one whose production year is 1990 through 1995. Any vehicle whose production year is 1989 or before is considered a nonlate model year vehicle. GES does not consider the model year of the vehicles.

If the police report indicates the production year for only one of multiple vehicles involved in the accident, then classify the accident based on that vehicle's information.

If there is no indication on the police report of the production year of the vehicle, then check: (1) for make/model information; and/or (2) for passive restraint availability information. If the police report indicates the make and model of the vehicle is that of a vehicle only produced between 1990 and 1995, then classify the vehicle as a late model year vehicle for stratification purposes. If the police report indicates passive restraints are available in the vehicle, then classify the vehicle as a late model year vehicle for stratification purposes. Only one of these criteria need to be met for classifying as a late model year vehicle.

If there is no indication on the police report specifying model year for any vehicle involved in the accident, then consider the model year as unknown and stratify the accident as not late model year.

Hospitalized Status is the determination that an occupant of a towed CDS applicable vehicle with a police reported injury of "A" (incapacitating injury) was transported to a treatment facility for treatment and was admitted overnight in a hospital. See OA37 (Hospital Stay) for definition of hospitalized. If the primary source, hospital, indicates the transported "A" injury occupant was admitted overnight, this will be accepted as hospitalized. Secondary sources of hospitalized status include the driver, other occupant, relative or close friend. PAR information can be used if the police officer indicates in the narrative that the transported "A" injury occupant was hospitalized overnight. Determination of hospitalization will be completed after PARs are stratified at the police agency. For CDS stratification, overnight hospitalized criteria needs to be met for only one transported "A" injury occupant in the towed CDS applicable vehicle. GES does not consider hospitalized status.

DESCRIPTION OF THE SAMPLING FRAME

2.2.2 Sampling Strata

The ten PAR sampling Strata used by the CDS are listed below and shown in Table 2-1.

Stratum A-NASS accidents in which at least one occupant of a towed CDS applicable late model year vehicle had a police reported injury of "K" (fatal injury).

Stratum B-NASS accidents not qualifying for Stratum A in which at least one occupant of a towed CDS applicable nonlate model year vehicle had a police reported injury of "K" (fatal injury).

Stratum J-NASS accidents not qualifying for Strata A or B in which at least one occupant of a towed CDS applicable late model year vehicle had a police reported injury of "A" (incapacitating injury) AND was transported to a treatment facility for treatment AND was admitted overnight to the hospital. If the accident involved more than one CDS applicable vehicle, at least two CDS applicable vehicles must be towed.

Stratum K-NASS accidents not qualifying for Strata A, B or J in which at least one occupant of a towed CDS applicable nonlate model year vehicle had a police reported injury of "A" (incapacitating injury) AND was transported to a treatment facility for treatment AND was admitted overnight to the hospital. If the accident involved more than one CDS applicable vehicle, at least two CDS applicable vehicles must be towed.

Stratum C-NASS accidents not qualifying for Strata A, B, J or K in which at least one occupant of a towed CDS applicable late model year vehicle had a police reported injury of "A" (incapacitating injury) AND was transported to a treatment facility for treatment. If the accident involved more than one CDS applicable vehicle, then at least two CDS applicable vehicles must be towed.

Stratum D-NASS accidents not qualifying for Strata A, B, J, K, or C in which at least one occupant of a towed CDS applicable nonlate model year vehicle had a police reported injury of "A" (incapacitating injury) AND was transported to a treatment facility for treatment. If the accident involved more than one CDS applicable vehicle, then at least two CDS applicable vehicles must be towed.

Stratum E-NASS accidents not qualifying for Strata A, B, J, K, C or D in which at least one occupant of a towed CDS applicable late model year vehicle was transported to a treatment facility for treatment.

Stratum F-NASS accidents not qualifying for Strata A, B, J, K, C, D or E in which at least one occupant of a towed CDS applicable nonlate model year vehicle was transported to a treatment facility for treatment.

Stratum G-NASS accidents not qualifying for Strata A, B, J, K, C, D, E or F which involve at least one CDS applicable late model year vehicle that was towed from the scene.

DESCRIPTION OF THE SAMPLING FRAME

TABLE 2-1

1994 NASS CDS Strata

Late Model Year (LMY) Vehicle Involvement	Most Severe Police Reported Injury							
	F A T A L INJURY "K"	Transported					Not Transported	
		Serious Injury "A"				Injured or Unknown If Injured "B", "C", or "U"	Injured, Not Injured or Unknown If Injured "A", "B", "C", "O", or "U"	
		Single CDS Applicable Vehicle	Multiple CDS Applicable Vehicle		At Least One CDS Applicable Vehicle Was Towed		No CDS Applicable Vehicles Were Towed	
	Towed	At Least Two Towed		Only One Towed				
	Not Hospitalized	Hospitalized	Hospitalized	Hospitalized				
Injury in Towed, LMY, CDS Applicable Vehicle	A	J	C	J	C	E	G	NOT IN SCOPE
Injury not in Towed, LMY, CDS Applicable Vehicle	B	K	D	K	D	F	H	See Table 2-2

Note: Late Model Year refers to 1990 through 1995 model years.

TABLE 2-2

1994 NASS GES Strata/Non-CDS Accidents

No Towed CDS Applicable Vehicles in this Accident		
Most Severe Police Reported Injury to Any Occupant, Pedestrian, or Nonmotorist		
Medium/Heavy Truck	No Trucks	Other
Towed Non-CDS Vehicle "OR" PAR Code of: "K", "A", "B", or "C"	PAR Code of: "K", "A", or "B"	PAR Code of: "C", "U", or "O"
X	Y	Z

DESCRIPTION OF THE SAMPLING FRAME

Stratum H-NASS accidents not qualifying for Strata A, B, J, K, C, D, E, F or G which involve at least one CDS applicable nonlate model year vehicle was towed from the scene.

All other NASS accidents that do not qualify for Strata A, B, J, K, C, D, E, F, G or H are further separated for the purposes of the General Estimates System (GES) into either the X Stratum, Y Stratum, or the Z Stratum. See Table 2-2 below. The GES includes all NASS accidents. The four main columns of the Stratification Record are: No Trucks (Strata A-K); Medium/Heavy Trucks (Strata A-K, X); Other Injury (Stratum Y) and; Other (Stratum Z).

Be aware that all CDS applicable accidents are also GES applicable accidents while the converse is not true (i.e., the majority of GES applicable accidents are not CDS applicable). Non-CDS accidents are classified as follows:

X Stratum-NASS accidents not qualifying for the CDS Strata, involving at least one medium or heavy truck in which a non-CDS vehicle was towed due to damage, or at least one involved person had a police reported injury of "K" (fatal injury), "A" (incapacitating injury), "B" (nonincapacitating injury), or "C" (possible injury). Transported status is not a consideration.

Y Stratum-NASS accidents not qualifying for the CDS Strata or X Stratum in which none of the vehicles involved in the accident was a medium or heavy truck and at least one person involved in the accident had a police reported injury of "K" (fatal injury), "A" (incapacitating injury), or "B" (nonincapacitating evident injury). Transported status is not a consideration.

Z Stratum-NASS accidents not qualifying for the CDS Strata, X Stratum, or Y Stratum.

Notice that the ten CDS PAR sampling Strata are hierarchical. PARs included in Stratum A are not considered for Strata B, J, K, C, D, E, F, G, or H and so forth. Therefore, in reviewing PARs for stratification, proceed as follows:

First, identify all in-transport CDS applicable vehicles in the NASS accident. If no in-transport CDS applicable vehicles were present, then classify this NASS accident for GES purposes into either the X Stratum, Y Stratum, or the Z Stratum.

Second, from among the CDS applicable vehicles present in the NASS accident, identify those the police accident report indicates were "towed" as a result of damage received in this NASS accident; however, exclude towed CDS applicable vehicles whose only event is a nonqualifying noncollision event. If no in-transport "towed" CDS applicable vehicles were present in this NASS accident, then classify this NASS accident for GES purposes into either the X Stratum, Y Stratum, or the Z Stratum.

Third, if at least one in-transport towed CDS applicable vehicle was present, then determine the most severe police reported injury to the occupant(s) of all towed CDS applicable vehicles present. If one or more occupants of a towed CDS applicable vehicle was killed ("K" injury), then classify this NASS accident in:

- o Stratum A if at least one of the killed persons was an occupant of a late model year vehicle; or
- o Stratum B if no killed person was an occupant of a late model year vehicle.

DESCRIPTION OF THE SAMPLING FRAME

Fourth, if no occupant of a towed CDS applicable vehicle was killed, but at least one occupant of a towed CDS applicable vehicle received an "A" injury and was transported to a medical facility for treatment purposes, then determine if that transported "A" injured occupant was admitted overnight to a hospital.

If only one CDS applicable vehicle was present and it was towed due to damage and an occupant received an "A" injury and was transported and admitted overnight to a hospital, then classify this NASS accident in:

- o Stratum J if at least one of the hospitalized and transported "A" injured persons was an occupant of a late model year vehicle; or
- o Stratum K if no hospitalized and transported "A" injured person was an occupant of a late model year vehicle.

If two or more CDS applicable vehicles were present, then at least two must be towed due to damage. Therefore, if at least two CDS applicable vehicles were present and at least two were towed due to damage and one of the towed CDS applicable vehicles had an occupant who received an "A" injury and was transported and admitted overnight to a hospital, then classify the NASS accident in:

- o Stratum J if at least one of the hospitalized and transported "A" injured persons as an occupant of a late model year vehicle; or
- o Stratum K if no hospitalized and transported "A" injured person was an occupant of a late model year vehicle.

However, if two or more CDS applicable vehicles were present, but only one was towed due to damage and an occupant received an "A" injury and was transported and admitted overnight to a hospital, then classify this NASS accident in:

- o Stratum E if at least one of the hospitalized and transported "A" injured persons was an occupant of a late model year vehicle; or
- o Stratum F if no hospitalized and transported "A" injured person was an occupant of a late model year vehicle.

On the other hand, if no transported "A" injured occupant was admitted overnight to a hospital, then classify this NASS accident in:

- o Stratum C if at least one of the transported "A" injured persons was an occupant of a late model year vehicle; or
- o Stratum D if no transported "A" injured persons was an occupant of a late model year vehicle.

Fifth, if no transported "A" injured occupant of a towed CDS applicable vehicle was hospitalized, but at least one occupant of a towed CDS applicable vehicle received an "A" injury, then determine if one or more of those receiving an "A" injury was transported to a medical facility for treatment purposes. If only one CDS applicable vehicle was present and it was towed due to damage and an occupant received an "A" injury and was transported, then classify this NASS accident in:

- o Stratum C if at least one of the transported, "A" injured persons was an occupant of a late model year vehicle; or
- o Stratum D if no transported, "A" injured person was an occupant of a late model year vehicle.

If two or more CDS applicable vehicles were present, then at least two must be towed due to damage. Therefore, if at least two CDS applicable vehicles were present and at least two were towed due to damage and one of the towed CDS applicable vehicles had an occupant who received an "A" injury and was transported, then classify this NASS accident in:

- o Stratum C if at least one of the transported, "A" injured persons was an

DESCRIPTION OF THE SAMPLING FRAME

- o occupant of a late model year vehicle; or
- o Stratum D if no transported, "A" injured person was an occupant of a late model year vehicle.

However, if two or more CDS applicable vehicles were present, but only one was towed due to damage and an occupant received an "A" injury and was transported, then classify this NASS accident in:

- o Stratum E if at least one of the transported, "A" injured persons was an occupant of a late model year vehicle; or
- o Stratum F if no transported, "A" injured person was an occupant of a late model year vehicle.

On the other hand, if no "A" injured occupant was transported to a medical facility for treatment purposes, then classify this NASS accident in:

- o Stratum G if at least one of the "A" injured persons was an occupant of a late model year vehicle; or
- o Stratum H if no "A" injured person was an occupant of a late model year vehicle.

Sixth, if the most severe police reported injury to any occupant(s) of the towed CDS applicable vehicle(s) present was a "B", "C", or "U" injury, then determine if one or more of those receiving "B", "C", or "U" injuries was transported from the scene to a medical facility for treatment purposes. If at least one "B", "C", or "U" injured occupant was transported to a medical facility for treatment purposes, then classify this NASS accident in:

- o Stratum E if at least one of the transported, "B", "C", or "U" injured persons was an occupant of a late model year vehicle; or
- o Stratum F if no transported, "B", "C", or "U" injured person was an occupant of a late model year vehicle.

Seventh, if no "B", "C", or "U" injured occupant of a towed CDS applicable vehicle was transported to a medical facility for treatment purposes, then classify this NASS accident in:

- o Stratum G if at least one of the "B", "C", or "U" injured persons was an occupant of a late model year vehicle; or
- o Stratum H if no "B", "C", or "U" injured person was an occupant of a late model year vehicle.

Eighth, if the PAR indicates that no occupant of a towed CDS applicable vehicle was injured (PAR "O" classification), then classify this NASS accident in:

- o Stratum G if there was at least one person who was an occupant of a late model year vehicle; or
- o Stratum H if no person was an occupant of a late model year vehicle.

The three non-CDS PAR sampling Strata (X Stratum, Y Stratum and Z Stratum) used by the GES are distinguished as follows.

- o Given that no in-transport towed CDS applicable vehicles are present in the NASS accident, determine if at least one medium or heavy truck was involved in the accident in which a non-CDS vehicle was towed or if any person in the accident received a "K" (fatal injury), "A" (incapacitating injury), or "B" (nonincapacitating evident injury), or "C" (possible injury) injury. If so, then classify this NASS accident in the X Stratum.
- o If no medium or heavy truck was involved in the accident but at least one person received a "K", "A", or "B" injury, then classify this NASS accident in the Y Stratum.

DESCRIPTION OF THE SAMPLING FRAME

- o If no person received a "K", "A", or "B" injury, then classify this accident in the Z Stratum.

It does not matter for the purpose of distinguishing between the X Stratum, Y Stratum, and the Z Stratum whether any person was transported or the vehicles involved are either late model or non-late model year. Also, the tow status is not considered when distinguishing between the Y Stratum and the Z Stratum.

Figure 2-8 presents a flow chart of the NASS stratification.

Examples:

1. NASS Accident: A heavy truck (other vehicle: GV07=60-79) and a motorcycle (other vehicle: GV07=80-89) crash. The driver of the motorcycle is killed.

Stratification: This is a "X Stratum" accident because it does not involve a towed CDS applicable vehicle (i.e., GV07 must be "01" through "49"), and one of the non-CDS vehicles is a medium/heavy truck, and a PAR reported "K" injury occurred.

2. NASS Accident: A late model year CDS applicable vehicle and a motorcycle (other vehicle) crash. The CDS applicable vehicle is towed, the driver has an "A" injury, and was transported to a medical facility for treatment but not admitted. The motorcyclist is killed ("K" injury).

Stratification: This is a Stratum "C" accident. It has one CDS applicable vehicle, and the CDS applicable vehicle was towed. The most severe injury to an occupant of a towed CDS applicable vehicle is an "A" injury and the "A" injured occupant was transported but not hospitalized. The injured person was an occupant of a late model year CDS applicable vehicle. The injury to the motorcyclist is not considered.

3. NASS Accident: A CDS applicable vehicle rolls over ejecting and causing a "K" injury to one of the occupants; the nonlate model year vehicle is towed.

Stratification: This is a Stratum "B" accident because it does have a towed CDS applicable vehicle, the most severely injured occupant of the vehicle receives a "K" injury, and the fatally injured person is not an occupant of a late model year CDS applicable vehicle.

4. NASS Accident: A CDS applicable vehicle and a bicycle crash. The bicyclist ejects shattering the vehicle's windshield. The nonlate model year CDS applicable vehicle is towed, but only minor injuries ("C" injuries) occur to the occupants. None of the occupants are transported. The bicyclist receives an incapacitating injury ("A" injury).

Stratification: This is a Stratum "H" accident. There is one towed CDS applicable vehicle, but no one in a towed CDS applicable vehicle receives a "K" injury or is transported. The most severely injured person in the towed CDS applicable vehicle is not an occupant of a late model year vehicle. The incapacitating injury to the bicyclist does not affect the stratification. The only injuries that affect stratification are those suffered by occupants of towed CDS applicable vehicles.

5. NASS Accident: Two CDS applicable vehicles crash. Vehicle 1, which is a late model year vehicle, is towed, but none of the occupants are injured.

DESCRIPTION OF THE SAMPLING FRAME

Vehicle 2, which is not a late model year vehicle, is not towed; however, an unbelted infant hits the instrument panel and receives an "A" (incapacitating) injury.

Stratification: This is a Stratum "G" accident. Stratification is determined first by the most severe injury to an occupant in a towed CDS applicable vehicle and second by the model year of the most severely injured occupant's vehicle. Vehicle model year and most severe police reported injury are not independent variables for stratification purposes.

6. NASS Accident: A heavy truck and two CDS applicable vehicles crash. The heavy truck catches on fire and its occupant subsequently dies of burn injuries. Both CDS applicable vehicles are towed. One CDS applicable vehicle is a late model year vehicle, and its occupant receives a "C" injury. The other CDS applicable vehicle is not a late model year vehicle, and its occupant receives a "B" injury. All occupants are transported for treatment.

Stratification: This is a Stratum "E" accident involving a medium or heavy truck. The most severe injury to the occupant of the towed CDS applicable late model year vehicle determines the Stratum.

FIGURE 2-8

NASS Stratification

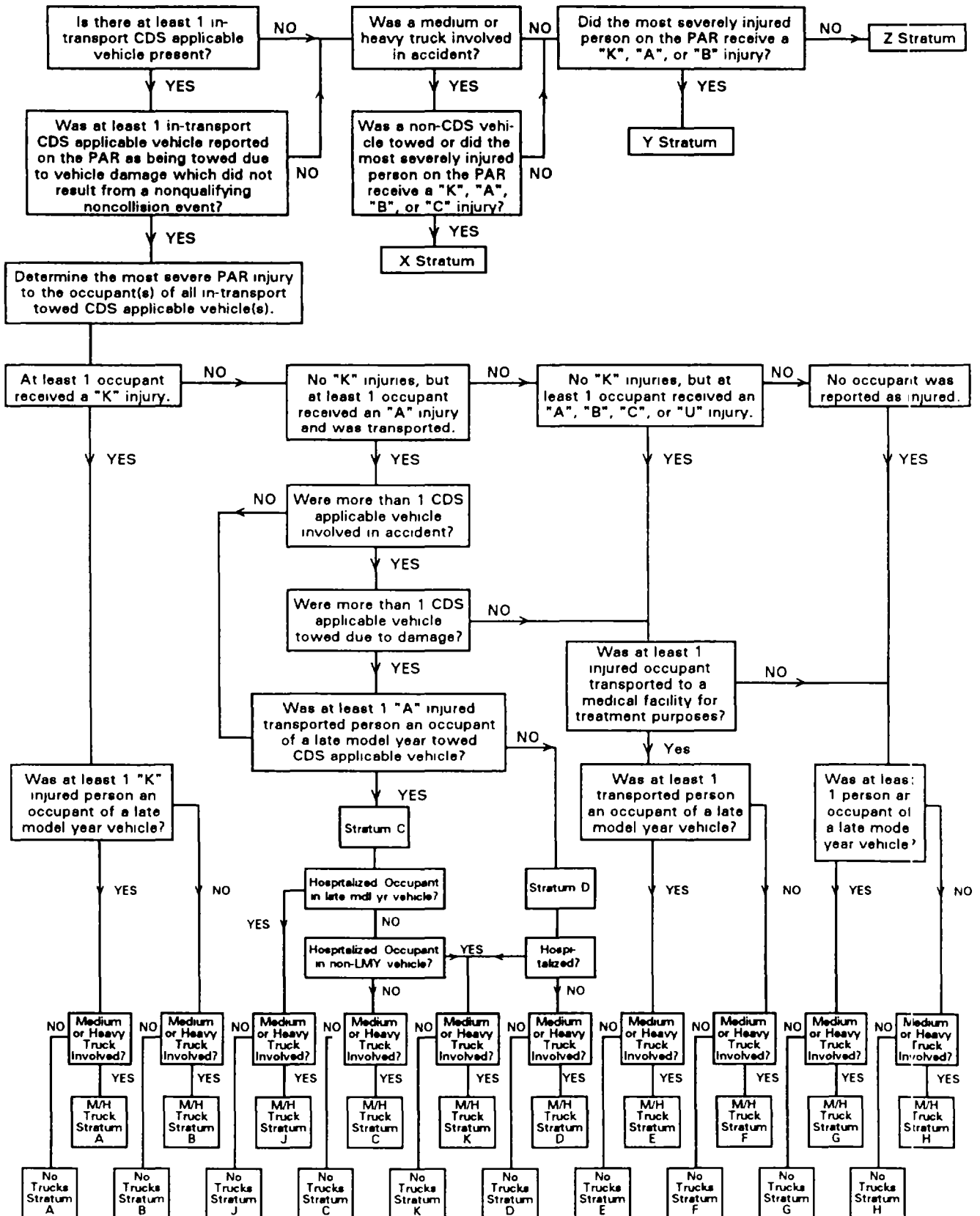

DESCRIPTION OF THE SAMPLING FRAME

7. NASS Accident: The PAR lists a 1979 Dodge Van which was towed from the scene. The injury level box was coded as a "B" injury.

Stratification: The correct strata should be "H". The PAR indicates a "Van" for which the current default coding is GV07 = "29", Unknown Van Type. The PAR did not indicate whether this vehicle was "towed due to damage" therefore the default assumption is to assume "towed due to damage".

8. NASS Accident: The PAR indicates a 1991 "Truck" which impacts a motorcycle. The driver receives a "C" injury, is not transported. Both vehicles were towed due to vehicle damage.

Stratification: This case would be assigned an "X" stratum. The rule for a "truck", with no other details, is to default to "Medium/Heavy". Transport as a result of an injury is not considered in the "X" or "Y" stratum.

2.2.3 Questions and Answers Regarding First Stratification

The following questions are aimed at helping researchers to initially classify CDS accidents.

Question 1: A vehicle ran off the road, struck a small tree, and continued on, eventually striking a pedalcyclist. Would this be considered a motor vehicle accident, since ANSI requires that in a pedalcycle accident (section 2.4.14, page 16), the first harmful event must involve a collision with a pedalcyclist?

Answer: In CDS we are concerned with the definition of a motor vehicle traffic accident (MVTA) as defined in ANSI D16.1-1989, section 2.4.20 (see figure 2-6, page 21). The components of a MVTA are: (a) a police report, (b) a harmful event, (c) from an unstabilized situation, (d) involving at least one motor vehicle, (e) in-transport [in motion or on a roadway], such that (f) the harmful event occurred on a trafficway or the unstabilized situation originated on a trafficway. Beyond this, we are not concerned with subdividing accidents according to ANSI. For this accident to be stratified during the first stratification in Strata A, B, C, D, E, F, G, or H, the vehicle must have been a "CDS applicable vehicle", and it must have been towed, according to the police report, as a result of the damage it sustained in the accident. In addition, consider the most severe police reported injury to an occupant of a towed CDS applicable vehicle, the transported status of the occupant(s) of only the towed CDS applicable vehicle(s), and the vehicle model year of the vehicle in which the most severely injured person was an occupant. If the accident does not involve a towed CDS applicable vehicle, classify it as "all other NASS accidents" (X Stratum, Y Stratum, or Z Stratum).

Question 2: When a hit-and-run accident occurs which involves a single in-transport vehicle, and no information is available about the hit-and-run vehicle or its occupant(s), how do you classify the accident on the stratification record?

Answer: Stratify the PAR as a Z Stratum accident since no information about the vehicle is equivalent to GV07, Body Type, equalling "99" (Unknown body type), and no information about the occupant(s) does not equate to a known "K", "A", or "B" injury which is required in order to classify the accident in the Y Stratum.

DESCRIPTION OF THE SAMPLING FRAME

Question 3: How do you stratify a vehicle not in-transport? The vehicle is unoccupied.

Answer: Vehicles not in-transport are not considered when determining the PAR sampling Stratum.

Question 4: It is, at times, difficult to determine whether or not a parked vehicle was on the roadway from simply reviewing a police accident report. Usually, the PAR merely states that the vehicle was parked. Unless one is familiar with the roadway, how do you determine if the vehicle was in-transport or not?

Answer: Vehicles which are legally parked are not in-transport. In certain situations illegally parked vehicles are in-transport; however, the fact that a vehicle was illegally parked when struck does not automatically make that vehicle in-transport.

Originally, this issue was resolved for bus zones. Figure 2-9 presents six bus stop parking area situations. For situations I through V any vehicle in the bus zone was considered in-transport. In situation VI a non-bus in the bus zone was considered in-transport. The mid-block bus zone concept was extended as well to fire hydrants located mid-block.

The question of vehicles illegally parked beyond the end of legal parking (either implicit or explicit) near an intersection was considered. The resolution is that if a vehicle is illegally parked because of time, then the vehicle is not in-transport. If a vehicle is illegally parked because of location, then the vehicle is in-transport. One major exception is when time changes the character of the parking location. See Figure 2-3. If any part of a struck vehicle is beyond the end of legal parking, then this vehicle is in-transport. This means that any vehicle not authorized to be in a bus zone, fire hydrant zone, loading/unloading zone, NO PARKING area, or yellow curbed area is in-transport regardless of where that area is located (i.e., end of block or mid-block).

For CDS sampling purposes, the PAR scene sketch should be used in conjunction with the violations issued section to determine if a vehicle was illegally parked because of location.

Illegal parking includes any occupied vehicle which is stopped in an illegal location. Any vehicle entering or exiting one of the above mentioned areas (i.e., bus zone, fire hydrant zone, loading/unloading zone, NO PARKING zone, or yellow curbed area) is, of course, in-motion and thus in-transport.

Question 5: A vehicle had several persons riding on top of it. The police spotted the vehicle and started to give chase. The persons jumped off. In the process, one was injured. Is this person an occupant or a nonmotorist? What about the vehicle and its occupants?

Answer: The persons riding on the roof do not fit the appended-to-the-vehicle-for-motion exclusion (e.g., person on a bicycle or skateboard who is holding onto the back of a vehicle for added motion) cited under variables OA04, Occupant Number, and OA10, Occupant's Seat Position; therefore, these persons are occupants of the in-transport vehicle. Regarding the injured

MANUAL RESTRAINTS

Restraint usage data, recorded on the noncoded section of the Interior Vehicle Form under the title "MANUAL RESTRAINTS", is based solely on the evidence obtained during the vehicle inspection.

An indication of restraint usage is determined for every seating position in the vehicle, regardless of whether the seating position is occupied. The "indication of usage" represents "recent usage" rather than "usage ever", whenever possible. The following evidence is sought when assessing restraint usage:

- o **belts/fittings damaged by occupant loading:** deformed anchor components, stretched webbing, latch metal peening (loading impression on metal);
- o **placement of belts:** on, behind, or under seatbacks or cushions; and,
- o **condition of belts:** dirty, dust covered, mechanically unusable, knotted, size adjustment on fixed length belts, cut for convenience or comfort (out of the way, near housings), or cut for occupant extraction by emergency personnel (usually at an easily accessible position).

Restraint "usage in this accident" is not generally determined on the Interior Vehicle Form. Vehicle evidence along with police report information, interviews, relationship of contact points to seat position given the PDOF applied to the vehicle, presence of belt-caused occupant injuries, and presence or absence of ejection are considered before encoding restraint usage on the Occupant Assessment Form.

CHILD SAFETY SEAT FIELD ASSESSMENT

For each child safety seat present in the vehicle, assign (unless you have knowledge regarding what the occupant's number is) the seat a temporary occupant number. Determine the correct answer for each of the six row variables present on the reverse side of Page 6. Due to the transient nature of child safety seats, annotate questions regarding its position for use during the interview. From this data, the actual position of the child safety seat at the time of the accident and the occupant's correct number can be determined for the inclusion on the Occupant Assessment Form.

DESCRIPTION OF THE SAMPLING FRAME

person, if that injury (harmful event) occurred as a result of exiting from the vehicle, then stabilization did not occur for that person. Therefore, in addition to those in the vehicle, consider the person who was injured while jumping from the vehicle as an occupant also. Since the police would not report the vehicle as towed due to damage, it makes no difference whether the vehicle was a CDS applicable vehicle or not. The Y Stratum or the Z Stratum would be assigned to this PAR depending upon the police report injury severity.

Question 6: A pickup truck was towing (pulling) a friend's passenger car to a service station. The car broke loose and impacted a tree. No damage occurred to the pickup. How would you stratify for CDS purposes this NASS accident?

Answer: Any motor vehicle on a roadway is in-transport. An exception occurs where the vehicle is attached to another vehicle by means of fixed linkage. The critical issue is whether or not the vehicle being towed has any control over its movement. In this instance, the answer depends on how the car and truck were attached. If the car was attached by a tow bar or any other form of fixed linkage, then the car is considered a trailing unit and the tow status of that vehicle is not considered when stratifying. On the other hand, if the linkage was nonfixed (e.g., rope, chain, etc.), then the car was in-transport, and its police reported tow status is considered. A fixed linkage is defined as one which has the property of keeping the towed unit separated from the power unit by a distance which is essentially constant. Included within this definition are cradle linkages where the towed unit has two or more wheels off the ground. If the linkage was fixed this is a Y Stratum or a Z Stratum accident since the pickup would not be reported by the police as towed due to damage. If the linkage was nonfixed and if the car was reported by the police as towed due to damage, then the accident, during the first stratification, qualifies for CDS Strata A, B, C, D, E, F, G, or H.

Question 7: How do you stratify fatal occupants of CDS applicable vehicles for which the PAR includes the annotations "heart attack", "gunshot wound", or other disease or nonaccident injury?

Answer: There must be medically supported or other positive information on the PAR which indicates that an occupant of a CDS applicable vehicle died of a disease or nonaccident inflicted injury. If such information is present on the PAR, then consider this person's injury as Unknown ("U") for stratification purposes. Otherwise, consider that the occupant died due to accident inflicted injuries.

Question 8: The PAR states that two passenger cars collided and both were towed due to damage. Only one occupant of a towed late model year vehicle was injured with an "A" injury and only one occupant of a towed nonlate model year vehicle was injured with a "B" injury. The PAR states that one injured occupant was taken to a medical facility for treatment but does not identify which occupant was transported. How is the accident classified on the stratification record and are the injured occupants considered as not transported?

Answer: If the PAR states that an occupant was transported but does not specify which occupant, then assume that the occupant with the highest injury coded in the accident was transported. This accident involved two CDS applicable vehicles and both were towed due to damage. The default assumption is that the "A" injury occupant, who happened to be in the late

DESCRIPTION OF THE SAMPLING FRAME

model year vehicle, was transported from the scene. Therefore, the accident is stratified as a "C" stratum case.

2.2.4 Questions and Answers Regarding Second Stratification

The following questions are aimed at accidents initially stratified as strata "C" and "D" accidents and which may be reclassified by researchers as strata "J" and "K" accidents if the qualifications are met.

Question 1: The PAR reports a transported "A" injury occupant of a towed, late model year CDS vehicle. When you contact the hospital they inform you that they have "No Record" of this occupant. Should you pursue more information about this occupant?

Answer: Yes, if the hospital has no information on file, then the occupant, driver, another occupant or relative/friend should be contacted to verify the level of treatment.

Question 2: Based on the PAR information the first stratification of the accident was "C". The hospital reported that no occupant was admitted overnight, but other sources of data indicate an occupant was admitted overnight. What source of information takes precedence?

Answer The hospital information is the primary source. The secondary sources such as occupants of the vehicle, relatives or friends, should only be contacted and utilized if the "admitted overnight" information from a treatment facility cannot be determined in time for sampling.

Question 3: The PAR information has the transported, "A" injury occupant in a towed nonlate model year vehicle. However, during a nonhospital contact to determine the hospital treatment status you determined this occupant is in the other towed vehicle, a late model year vehicle. Should the Stratum be corrected for model year?

Answer No, in this case a "D" stratum case would NOT be corrected to a "J" stratum case. The restratification is based on hospital or interviewee reported treatment status and not newly discovered vehicle information. In addition, a "D" stratum case cannot be corrected to a "C" stratum case and a "C" stratum case cannot be corrected to a "D" stratum case based on hospital information. See table 2-3 below.

Question 4: The PAR lists a towed late model year vehicle, with a transported occupant with an "A" injury. The hospital reports that this occupant was treated and released but was subsequently hospitalized overnight when an accident related injury was discovered two days after their release from the ER. Is this occupant considered as hospitalized for "J" stratum?

Answer Yes, the definition for the hospitalized status is the same as the Occupant Assessment form variable OA37 (Hospital Stay).

DESCRIPTION OF THE SAMPLING FRAME

TABLE 2-3
First Versus Second Stratum

Second Stratum	First Stratum C (Late model year CDS vehicle towed)
C	No one hospitalized
D	Not possible ¹
J	Late model year occupant hospitalized
K	Hospitalized occupant in nonlate model year vehicle only ²
	First Stratum D (Nonlate model year CDS vehicle (only) towed)
C	Not possible ¹
D	No one hospitalized
J	Not possible ¹
K	Hospitalized occupant in nonlate model year vehicle only

¹ This situation could not occur due to hospitalization information alone. A PAR cannot be changed from a "C" stratum to a "D" stratum or from a "D" stratum to a "C" stratum unless the PAR information is changed by the police

² This situation occurs when the accident involved a towed late model year CDS vehicle and a towed nonlate model year CDS vehicle and only the nonlate model year vehicle had a hospitalized occupant.

3.0 OVERVIEW OF SAMPLING ACTIVITIES

The procedure for selecting the NASS CDS accident sample consists of four tasks:

- Task 1: Contact sampled police jurisdictions on specified days to review the police accident reports (PARs).
- Task 2: At each jurisdiction, list and stratify, using the NASS Stratification Record (SR), all PARs which qualify for NASS (CDS and GES). First, classify each into one of the four main columns on the NASS SR. Second, if the NASS accident is CDS applicable, then classify it into one of the eight CDS Sampling Strata (A through H). Strata J and K are determined in task 3 below.
- Task 3: Telephone hospitals or occupants to determine if transported "A" injury occupants of a CDS applicable vehicle in the C and D strata PARs were admitted overnight to the hospital, and restratify into strata J or K as necessary. This process should be completed by noon of the day following your designated contact date.
- Task 4: Using the Microcomputer Data Entry (MDE) system, enter the listed PARs (CDS and GES) into the NASS CDS Automated Case Selection System. The automated system will specify the sample of CDS accidents to be researched.

All teams will perform these tasks on one day each week. Section 3.2 below discusses these procedures.

3.1 Listing and Sampling Forms

The Contact Day Assignment Sheet (CDAS), and the PAR Stratification Record (SR), and the Hospital Work Sheet (HWS) are included as examples.

3.1.1 Contact Day Assignment Sheet (CDAS)

The Contact Day Assignment Sheet (Table 3-1) provided to your PSU is unique to your PSU. It specifies the dates on which the contacts are to be made and indicates the caseload for each contact day. The CDAS must be initialed by a COTR and by Sample Design staff from the Mathematical Analysis Division.

3.1.2 PAR Stratification Record (SR)

All teams will use the same PAR Stratification Record form (Table 3-2). Make photocopies as needed of the form provided. Instructions for completing the form are given in Section 3.2.2.

3.1.3 Hospital Work Sheet (HWS)

All teams will use the same Hospital Work Sheet (Table 3-3). For each PAR that was first stratified as a C or D stratum, a Hospital Work Sheet will be completed. Make photocopies as needed of the form provided. Instructions for completing the form are given in Section 3.2.3.

OVERVIEW OF SAMPLING ACTIVITIES

TABLE 3-1

1 9 9 4 N A S S

C O N T A C T D A Y A S S I G N M E N T S H E E T

PSU	Period
13 - Muskegon, MI	01-Jan-94 to 30-Jun-94
Contact Dates	Contact Dates
03-Jan-94	04-Apr-94
10-Jan-94	11-Apr-94
17-Jan-94	18-Apr-94
24-Jan-94	25-Apr-94
31-Jan-94	02-May-94
07-Feb-94	09-May-94
14-Feb-94	16-May-94
21-Feb-94	23-May-94
28-Feb-94	30-May-94
07-Mar-94	06-Jun-94
14-Mar-94	13-Jun-94
21-Mar-94	20-Jun-94
28-Mar-94	27-Jun-94

Caseload: 6 Cases per Week

Approved--MAD:

Approved--COTR:

Date: 26-Oct-93

TABLE 3-2

NASS CRASHWORTHINESS DATA SYSTEM and GENERAL ESTIMATE SYSTEM

PAR STRATIFICATION RECORD

Page _____ of _____

PSU:			JURISDICTION:			LISTED BY:			CONTACT DATE: / /		
PAR INFORMATION			(1)		(2)		(3)		(4)		
			NO TRUCKS		MEDIUM OR HEAVY TRUCKS		OTHER INJURY		OTHER		
			CDS Stratum Interval:		CDS and X Strate Interval:		Y Stratum Interval:		Z Stratum Interval:		
			Carryover:		Carryover:		Carryover		Carryover		
Date	Time	PAR Number	Line No.	Stratum CDS	Line No.	Stratum CDS or X	Line Number	Line Number			
-94											
-94											
-94											
-94											
-94											
-94											
-94											
-94											
-94											
-94											
-94											
-94											
-94											
-94											
-94											
-94											
-94											
-94											
-94											
-94											
-94											
-94											

NASS Form SR, 1/84

	CDS (No Medium or Heavy Trucks)	CDS (Medium or Heavy Trucks)	(No Medium or Heavy Trucks)	(No Medium or Heavy Trucks)
	Strata A, ... K	Strata A, ... K X	Y	Z
Page Totals:				
Day Totals:				

Page Totals:																	
Day Totals:	A	B	C	D	E	F	G	H	I	J	K	X	Y	Z			

TABLE 3-3

HOSPITAL WORK SHEET

HOSPITAL WORK SHEET - 1994									
PSU: _____				JURISDICTION: _____		CONTACT DATE: _____ / _____ / 1994			
PAR Information									
Number: _____		Date: _____		Time: _____		A: _____		Number of Qualified Occupant(s): _____	
B: _____		C: _____		D: _____		E: _____		F: _____	
With Hospitalization Status Determined:		Whose Hospitalization Status Still Needed to be Determined:							
(1) Qualified Occupant Name		(2) Phone Number		(3) Vehicle Number		(4) Occupant Number		(5) Medical Facility Code	
(6) Date of Attempt		(7) Time of Attempt		(8) Contact Admitted ?					
(9)									
Contact: Column (8)					Admitted?: Column (9)				
(1) Hospital/Trauma Center (2) This Occupant (3) Other Occupant (4) Relative or Friend (5) Police (PAR or Officer)					(1) Yes (2) No (3) Died before admittance (9) Unknown				

NASS Form (12.3.92)

3.2 Listing and Sampling Instructions3.2.1 Contacting Police Jurisdictions

Contact each of the jurisdictions on the day of the week specified. If a team wishes to change the contact day, it must notify both its respective zone center and COTR for approval to implement the change.

3.2.2 Completing the PAR Stratification Record

At each police jurisdiction, follow the guidelines in Section 2 (2.0-2.2) to identify the PARs which qualify as NASS accidents and are to be listed. Complete the PAR Stratification Record as follows:

- A. At the top of the SR enter the contact date and the name or initials of the team member making the visit.

- B. GES Carryover:

On or before the first 1994 contact day, four random numbers, one for each main column, will be provided by NCSA. Enter the random numbers on the GES Carryover line for the appropriate main column. The random numbers constitute this jurisdiction's initial GES Carryover values and serve to ensure that all PARs have an equal chance of selection. On each subsequent 1994 contact day, the GES Carryover entered at the top of the SR will be equal to the last Line Number listed for that main column on the previous contact day.

- C. GES Interval:

On or before the first 1994 contact day, a supply of Stratification Records will be provided. These Stratification Records will have the following information: (1) PSU Number, (2) PJ Number and Name, and (3) four GES Interval values, one for each main column. The GES Interval is used to indicate which PARs are sampled. When the Line Number matches the GES Interval for that stratum, "highlight" that accident with a yellow marker and make the next line number, number 1. Line numbers will never exceed the GES Interval for that main column. The highlighted lines represent the sampled PARs for the GES.

Example: If the GES Interval for the "No Trucks" column is 4, then enter the line numbers: 1, 2, 3, 4*, 1, 2, 3, 4*, etc. Every time the line number 4 is recorded, that PAR is highlighted (*). If the GES Interval is 1, meaning every PAR in that column is sampled, highlight only the line numbers.

- D. Line Number:

For each contact day the first line number entered for a main column will be one more than the GES Carryover for that main column unless the GES Carryover is equal to the GES Interval in which case the first line number is: number 1. Except for the first 1994 contact day, the GES Carryover is equal to the last line number listed for that main column on the previous day or page.

Example: If the last line number used for the "No Trucks" column on the previous contact day is 3, the GES Carryover for the CDS column

OVERVIEW OF SAMPLING ACTIVITIES

on this day will be 3. The first NASS CDS accident listed for the CDS column this day will have a line number 4.

Similarly, within a single contact day, the GES Carryover is used from page to page and must be entered for all main columns when a new PAR SR is started. Verify the carryover by checking the last line number on the previous page for that main column; these numbers must be the same.

In addition, record the GES Carryover number at the top of each main column on the page to be used for the next visit to that jurisdiction.

E. For each qualifying PAR:

First, identify all in-transport CDS applicable vehicles in the NASS accident. If no in-transport CDS applicable vehicles were present, then follow the procedures below in subsection "E. 2." and classify this NASS accident for GES purposes into either the X Stratum, Y Stratum, or the Z Stratum.

Second, from among the CDS applicable vehicles present in the NASS accident, identify those the police accident report indicates were "towed" as a result of damage received in this NASS accident; however, exclude towed CDS applicable vehicles whose only event is a nonqualifying noncollision event. If no in-transport "towed" CDS applicable vehicles were present in this NASS accident, then follow the procedures below in subsection "E. 2." and classify this NASS accident for GES purposes into either the X Stratum, Y Stratum, or the Z Stratum.

Third, if at least one in-transport, towed CDS applicable vehicle was present and a medium or heavy truck was not involved, then follow the procedures below in subsection "E. 1." and classify this NASS accident for CDS purposes into one of the A through K CDS Strata under "No Trucks" column. If at least one in-transport, towed CDS applicable vehicle was present and a medium heavy truck was involved, then follow the procedures below in subsection "E.1." and classify this NASS accident for CDS purposes into one of the A through K CDS Strata under the "Medium or Heavy Truck" column.

1. Determine the CDS sampling Stratum:

- a. Determine if at least one occupant of a towed CDS applicable late model year vehicle involved in the accident was killed ("K" injury),
 - (1) If so, it belongs in Stratum A.
 - (2) If not,
- b. Determine if at least one occupant of a towed CDS applicable nonlate model year vehicle involved in the accident was killed ("K" injury),
 - (1) If so, it belongs in Stratum B.
 - (2) If not,

OVERVIEW OF SAMPLING ACTIVITIES

- c. Determine if at least one occupant of a towed CDS applicable late model year vehicle involved in the accident had an "A" injury,
 - (1) If so, then determine if any "A" injured occupant was transported to a medical facility for treatment purposes [go to (a) below],
 - (2) If not, then proceed to E. 1. d. below,
 - (a) If so, recall, first, how many CDS applicable vehicles were present in the accident and, second, how many towed CDS applicable vehicles were present.
 - (b) If only one CDS applicable vehicle was present and it was towed, then it belongs in Stratum C.
 - (c) If more than one CDS applicable vehicle was present and two or more CDS applicable vehicles were towed, then it belongs in Stratum C.
 - (d) If more than one CDS applicable vehicle was present but only the late model year CDS applicable vehicle which contained the transported "A" injured occupant was towed, then it belongs in Stratum E.
- d. Determine if at least one occupant of a towed CDS applicable nonlate model year vehicle involved in the accident had an "A" injury,
 - (1) If so, then determine if any "A" injured occupant was transported to a medical facility for treatment purposes [go to (a) below],
 - (2) If not, then proceed to E. 1. e. below,
 - (a) If so, recall, first, how many CDS applicable vehicles were present in the accident and, second, how many towed CDS applicable vehicles were present.
 - (b) If only one CDS applicable vehicle was present and it was towed, then it belongs in Stratum D.
 - (c) If more than one CDS applicable vehicle was present and two or more CDS applicable vehicles were towed, then it belongs in Stratum D.
 - (d) If more than one CDS applicable vehicle was present but only the nonlate model year CDS applicable vehicle which contained the transported "A" injured occupant was towed, then it belongs in Stratum F.
- e. Determine if at least one injured ("B", "C", or "U") occupant of a towed CDS applicable late model year vehicle involved in the accident was transported directly from the accident scene to a medical facility for treatment purposes,
 - (1) If so, it belongs in Stratum E.
 - (2) If not,
- f. Determine if at least one injured ("B", "C", or "U") occupant of a towed CDS applicable nonlate model year vehicle involved in the accident was transported directly from the accident scene to a medical facility for treatment purposes,
 - (1) If so, it belongs in Stratum F.

OVERVIEW OF SAMPLING ACTIVITIES

- (2) If not,
 - g. Determine if at least one towed CDS applicable late model year vehicle was involved in the accident,
 - (1) If so, it belongs in Stratum G.
 - (2) If not,
 - h. Determine if at least one towed CDS applicable nonlate model year vehicle was involved in the accident,
 - (1) If so, it belongs in Stratum H.
 - (2) If not, it belongs either in the X Stratum, Y Stratum (Non-CDS Injury Accidents), or the Z Stratum (Other Non-CDS Accidents).
2. Determine the non-CDS/GES sampling Stratum:
- a. Determine if at least one medium or heavy truck was involved in the accident, AND either a non-CDS vehicle was towed OR at least one involved person received a "K", "A", "B", or "C" injury.
 - (1) If so, it belongs in the X Stratum.
 - (2) If not,
 - b. Determine if at least one involved person received a "K" (fatal injury), "A" (incapacitating injury), or "B" (nonincapacitating evident injury) injury.
 - (1) If so, it belongs in the Y Stratum.
 - (2) If not,
 - c. It belongs in the Z Stratum.
3. Enter the accident date, accident time, and PAR number in the "PAR Information" column for all qualifying NASS accidents that have accumulated since the last visit to the police jurisdiction.
- a. If the PAR has been classified into stratum A through Stratum K, and a medium or heavy truck is NOT involved, then enter the stratum (A through K) on the line corresponding to the PAR information in column 1 (No Trucks/Strata A-K).
 - b. If the PAR has been classified into stratum A through Stratum K, and a medium or heavy truck is involved, then enter the stratum (A through K) on the line corresponding to the PAR information in column 2 (Medium or Heavy Truck/Strata A-K,X).
 - c. If the PAR has been classified into stratum X, then enter the stratum X on the line corresponding to the PAR information in column 2 (Medium or Heavy Truck/Strata A-K,X).
 - d. If the PAR has been classified into stratum Y, then enter the stratum Y on the line corresponding to the PAR information in column 3 (Other Injury/Stratum Y).
 - e. For PARs classified into stratum Z, enter the stratum Z on the

OVERVIEW OF SAMPLING ACTIVITIES

line corresponding to the PAR information in column 4 (Other/Stratum Z).

When entering PARs on successive pages, be sure to enter the page number in the "Page ___ of ___" field to keep pages in their proper sequence.

4. After all PARs for that day have been listed, enter the "line numbers" for each of the four main columns, based on that main column's GES Carryover and GES Interval. Be sure to enter line numbers in a column only for lines which have entries in that column.
5. Enter the "page" totals at the bottom of the page to indicate the total number of PARs listed for each stratum and for each main column on that page. After listing all the PARs for that day, sum the page totals to ensure that all PARs have been listed. Enter the "day" totals for each stratum and for each main column at the bottom of the last PAR SR used for that jurisdiction for that contact day.

F. Completing the GES Sample:

All GES sampling is done manually. Obtain a copy of all sampled GES PARs before leaving the police jurisdiction. The sampled GES PARs are the highlighted lines identified as a part of the NASS PAR listing process described above. Thus, NASS CDS applicable accidents can be sampled independently in either the CDS or GES and may occasionally be selected in both systems.

3.2.3 Completing the Hospital Work Sheet

After completing the NASS CDS and GES PAR Stratification Record, the first stratification, at each police jurisdiction, return to the office and complete the Hospital Work Sheet (Table 3-3) as follows:

- A. Complete a separate "Hospital Work Sheet" (see Table 3-3) for each C stratum and D stratum PAR. Each "Hospital Work Sheet" contains information about only one accident, and each row of the form represents an attempt to determine hospitalization status. Each form can record nine attempts.

For a simple accident where you can easily determine hospitalization, only one form may be necessary. The upper right hand corner would then be filled out as "Page 1 of 1". Complicated accidents with multiple attempts to determine hospitalization may require more than one form. Number pages accordingly in the upper right hand corner.

- C. Fill in the header and PAR information sections of the Hospital Work Sheet.
 1. Fill in the PSU number, the jurisdiction from which the PAR was obtained, and the contact date.
 2. Fill in the information from the PAR (e.g., PAR number, accident date and time).
 3. Fill in the First Stratum (Box A) with the original stratum of the

OVERVIEW OF SAMPLING ACTIVITIES

PAR, stratum C or stratum D.

4. The Second Stratum (Box B) records the outcome of your attempt to determine hospitalization. If no qualified occupant was hospitalized, the PAR's stratum does not change. If at least one qualified occupant is hospitalized, the PAR is restratified as stratum J if the occupant is in a late model year vehicle, or as stratum K if the occupant is in a nonlate model year vehicle. For those PARs that have been upgraded to a Final Stratum of "J" or "K", write the new stratum next to the original stratum on the "PAR Stratification Record".

Please note that a stratum "C" PAR can be restratified as a stratum "J" or "K" PAR, whereas a stratum "D" PAR can only be restratified as a stratum "K" PAR. There are no other options.

5. The Case Number (Box C) is completed only if the Automated Case Selection System selects this PAR for investigation.
6. Box D, Number of Qualified Occupant(s), is the total number of persons from the PAR that are transported, "A" injured occupants of towed CDS applicable vehicles.

D. Fill in the information on the qualified occupants to be contacted and record the contact attempts.

1. Box E (Number of Qualified Occupants with Hospitalization Status Determined) is a count of the people from Box D (Number of Qualified Occupants) for whom you were able to determine hospitalization, either "yes" or "no". See Section 3.4, Example 6 below for additional information affecting Box E.
2. Box F (Number of Qualified Occupants Whose Hospital Status Still Needed to be Determined) is the number of occupants from Box D (Number of Qualified Occupants) whose hospitalization status has not been determined, and whose hospitalized status could affect the Second Stratum. If you have all the hospitalization information necessary for the Second Stratum, Box F will be coded "0". Boxes E and F do not have to add up to Box D.
3. In column 1 (Qualified Occupant Name), record from the PAR the names of all transported, "A" injured occupants of towed CDS applicable vehicles. In addition, record each occupant's telephone number in column 2, the occupant's vehicle number in column 3, the person's occupant number in column 4 and, the code of the medical facility to which the occupant was transported in column 5. Each time you make or attempt to make a contact for an occupant, start a new line.

The phone number is the phone number used on that contact. Suppose you called the hospital about Joe Smith, were unable to determine hospitalization, then tried to call Joe Smith at home. You will use two lines with the appropriate telephone number on each line.

4. Fill in column 6 (Date of attempt), column 7 (Time of Attempt), column 8 (Contact), and column 9 (Admitted?) as the contact attempts are made and the information is obtained.

OVERVIEW OF SAMPLING ACTIVITIES

Section 2.2 contains definitions of the ten PAR sampling strata used by the NASS CDS. The definitions, Figure 2-8, and Table 3-3 above are used to determine the Second Stratum (Box B).

If, after you have made all reasonable efforts to determine hospitalization with certainty and conflicting evidence on hospitalization status remains, code the information from available sources in the following order: (1) Hospital, (2) this occupant, (3) other occupant, (4) relative or friend, (5) Police (PAR or Officer), or (6) Other (e.g., EMS, newspapers).

Periodically, you will be required by your Zone Center to send all PARs whose first stratum was "C" or "D", regardless of the second stratum, along with each PAR's Hospital Work Sheet to the Zone Center with your normal sampling materials.

3.2.4 The NASS CDS Automated Case Selection System (ACSS)

The NASS CDS Automated Case Selection System will be executed for each contact date listed on the Contact Day Assignment Sheet. The Microcomputer Data Entry User's Manual for NASS (1/94) includes instructions for using the ACSS. Any problems or difficulties that are not identified in the manual should be referred to your zone center.

The ACSS reports the selected CDS PARs on the NASS CDS Automated Case Selection System Report (ACSSR). See Table 3-4 for an example of the ACSSR.

3.2.5 Special Instructions for Automated Sampling Procedures

Occasionally emergency conditions require special sampling procedures. Hardware or software problems may prevent sampling for a short or even an extended period. Case load assignments can possibly generate problems too. The information below is intended to provide some guidance on how to cope with some of these situations. Remember, the basic sources for help are:

- o Hotline - for hardware or software problems, and
- o NASS CDS Sampling Coordinator - for case load or selection problems.

Condition A: Your micro-computer working and you have successfully closed your PAR file, but

Problem 1: The mainframe doesn't answer when you try to connect:

Action: Try two or three times to make a mainframe connection. Wait a short while (wait 15-20 minutes between calls) to allow temporary trouble to clear. If you are still unsuccessful, then call **Hotline**.

Problem 2: You have connected okay initially, but the connection is broken in the middle of the process:

Action: Call **Hotline** immediately.

TABLE 3-4

```

=====
                N   A   S   S                               VER 7.00
      * *   A U T O M A T E D   C A S E   * *
      S E L E C T I O N   S Y S T E M   R E P O R T
      * * * * *
PSU: 02      CONTACT DATE: 03/21/94      LAST CASE NUMBER: 069

THE SAMPLE SELECTION PROGRAM EXECUTED SUCCESSFULLY.

THE FOLLOWING PARS WERE SELECTED:

Case      Police      PAR      Accident      PAR
Number  Jurisdiction  Stratum  Date      Time      Number
-----+-----+-----+-----+-----
070J      04              J    03/19/94  01:00      5546
    
```

OVERVIEW OF SAMPLING ACTIVITIES

- Problem 3: The connection has apparently completed, but there is something missing or garbled in the output:
- Action: Call Hotline immediately.
- Condition B: Your micro-computer is not working.
- Action: Call Hotline to get help for a local fix or to arrange for replacement. If the prognosis is for more than a day's delay, follow the mail-in procedure for Condition C.
- Condition C: The prospect of an extended outage for either of the above conditions exists.
- Action: Express mail a copy (keep your originals) of your Stratification Records to headquarters.
- Action: Notify headquarters ("HDQ" - attention COTR) that an extended outage is in progress.
- Action: Headquarters will do the sampling and tell the team by phone which PARs were selected.
- Action: When your micro-computer is running again, send a message to headquarters ("HDQ" and "DBB") announcing that your team is back on line.

3.3 CDS Sampling Problems: How To Handle Them

The following section describes problems that sometimes arise in sampling and outlines ways to address them. A critical element in each case is time; that is, the longer the period between the occurrence of the problem and the implementation of some corrective action, the less likely are the Mathematical Analysis Division's (MAD) chances of resolving it. If a problem occurs which is not listed below, the researcher should inform his/her COTR or the MAD sampling design staff at once.

- Problem 1: A team lists and stratifies accidents correctly, but the PAR for the selected case is missing when the researcher returns to the police jurisdiction after sampling.
- Action: After all attempts to locate the PAR have been exhausted unsuccessfully, call your zone center to have the case dropped. Follow the case deletion procedures in Section 5.3.
- Problem 2: A team does not find any CDS accidents to list.
- Action: No CDS cases will be selected this day. However, the MDE must be entered to close the Listed Cases File, even though it will be empty, and a Mainframe connect must be made to receive the next contact date.

OVERVIEW OF SAMPLING ACTIVITIES

- Problem 3:** A team cannot list and select on the designated contact date due to extreme weather conditions (in particular, snow hazards) or holiday.
- Action:** When circumstances are foreseen, make arrangements with MAD to visit the jurisdiction(s) either the day before or the day after. When circumstances are unforeseen and the jurisdictions can be visited prior to the next contact date, list and select on the first practical day. In either situation list only PARs with accident dates prior to or equal to the missed contact day. If the jurisdiction(s) cannot be visited before the next contact day, notify the MAD sample design staff immediately.
- Problem 4:** Upon visiting the accident scene it is determined that the selected accident occurred outside of the PSU.
- Action:** First, determine the jurisdiction of the police agency that worked the accident. If the agency's jurisdiction includes territory outside the PSU (e.g., State Police posts often are assigned to cover multiple counties some of which are outside the PSU boundary), then drop the case and follow the Case Deletion Procedures (Section 5.3). If the agency's jurisdiction resides within the PSU and the PAR is for a CDS accident which occurred outside of the PSU (i.e., police agencies often help out other police agencies by handling accidents for them when the responsible agency is overcommitted or otherwise unavailable), then the research is to be completed as long as it meets all other requirements for a NASS accident (i.e., Section 2.1 of the NASS CDS Data Collection, Coding, and Editing Manual).
- Problem 5:** A team lists and properly selects an accident according to the information on the PAR. However, during the research it is determined that the case does not meet the criteria (i.e., Section 2.1 above) for accidents which qualify for NASS.
- Action:** If the incident is not a NASS accident, then follow the case deletion procedures (see Section 5.3).
- Problem 6:** A team improperly lists and selects an accident according to the information on the PAR. During the research it is determined that the case does not meet the criteria for selection in the CDS.
- Action:** Using Table 3-5 below, if cell i, iv, v, or vi applies, then drop the case and follow the case deletion procedures (see Section 5.3). If cell ii or iii applies, then code GV09, Police Reported Vehicle Disposition, equal to "1" (Towed due to vehicle damage) and EV27, Researcher's Assessment of Vehicle Disposition, equal to "0" (Not towed due to vehicle damage) or "9" (Unknown).

TABLE 3-5

CDS Sampling Problems: How To Handle Them			
PAR DISPOSITION VERSUS TEAM RESEARCH			
Basis for Team's Stratification	EV27--Research by the Team Indicates:		
	No CDS applicable vehicle in accident (GV07 ≥ 50)	At least one CDS applicable vehicle present	
		No CDS applicable vehicle involved in accident was towed	At least one towed CDS applicable vehicle involved, but none were towed due to damage
Correctly read PAR (GV07 < 50 and GV09=1)	D R O P i	D O N O T D R O P ii	D O N O T D R O P iii
Incorrectly read PAR (i.e., missed informa- tion present which would have changed their stratification)	D R O P iv	D R O P v	D R O P vi

OVERVIEW OF SAMPLING ACTIVITIES

It is extremely important, when problems 1 and 5 arise, that the zone center and Headquarters (COTR and MAD sample design staff) are notified immediately. Dropped cases are to be reported to headquarters at the end of each month, along with the reasons why they were dropped.

3.4 CDS Hospitalization Determination Examples

Below is a list of examples aimed at helping researchers determine if a C or D stratum PAR qualifies for restratifying as a J or K stratum PAR.

Example 1 There is one nonlate model year automobile and three qualified occupants. The Initial Stratum is "D". On your first telephone call about one of the occupants, you find she was hospitalized.

Codes Box D = 3; Box E = 1; Box F = 0; Box A = 0; Box B = K

You were able to get the Final Stratum of "K", just by discovering one qualified occupant was hospitalized. Stop determining hospitalization for this PAR. Code "0" for Box F.

Example 2 There is one late model year car and three qualified occupants. The Initial Stratum is "C". You are able to determine that two qualified occupants were not hospitalized, but you could not get data on the third.

Codes Box D = 3; Box E = 2; Box F = 1; Box A = C; Box B = C

From the data you have been able to collect, the case must remain in Stratum "C". If you are unable to determine the third occupant's hospitalization status, then code "1" for Box F.

Example 3 There is one late model year automobile with two qualified occupants, and one nonlate model year automobile with three qualified occupants. The Initial Stratum is "C". You are able to find that one occupant of each vehicle was not hospitalized. One qualified occupant from the late model year automobile was hospitalized. You have determined the hospitalization status of three occupants.

Codes Box D = 5; Box E = 3; Box F = 0; Box A = C; Box B = J

Once you find one qualified occupant of a late model year vehicle was hospitalized, you have all the information you need to make the Final Stratum "J". Stop determining hospitalization for this PAR. Code "0" for Box F.

Example 4 There is a late model year light van with two qualified occupants, and a nonlate model year pick-up truck with three qualified occupants. The Initial Stratum is "C". You verify that neither of the occupants of the van was hospitalized. You determine one occupant of the pickup was not hospitalized and one was.

Codes Box D = 5; Box E = 4; Box F = 0; Box A = C; Box B = K

You have determined that at least one qualified occupant was hospitalized and the PAR gets a Final Stratum of "K". Therefore,

OVERVIEW OF SAMPLING ACTIVITIES

code "0" for Box F.

Example 5

There is a late model year light van with two qualified occupants, and a nonlate model year pickup truck with three qualified occupants. The Initial Stratum is "C". Nobody from the van was hospitalized, but you are unable to get hospitalization data about anybody from the pickup.

Codes

Box D = 5; Box E = 2; Box F = 3; Box A = C; Box B = C

Since you were unable to determine if any of the qualified occupants of the pick-up were hospitalized, the Final Stratum remains a "C". Unknown information on the occupants of the pick-up hospitalization status cannot be used as input to restratify the PAR. Therefore, code "3" for Box F. See table 2-3.

Example 6

A nonlate model year automobile with two qualified occupants crashes into a tree. The Initial Stratum is "D". You discover one occupant was not hospitalized, but the other occupant died on the way to the hospital or in the emergency room. For some unknown reason, the police did not note the death on the PAR, which would have made the PAR a "B" stratum.

Codes

Box D = 2; Box E = 2; Box F = 0; Box A = D; Box B = K

We count the fatality as hospitalized on the assumption that he is more seriously injured than a truly hospitalized patient. Therefore, the Final Stratum is "K". Code "0" for Box F.

You do not upgrade the Final Stratum to a "B". You begin the hospitalization search only for accidents classified as "C" or "D" from the information on the PAR. All these accidents have an Initial Stratum of "C" or "D", and a Final Stratum of "C", "D", "J", or "K".

Example 7

One late model year automobile with two qualified occupants collides with a nonlate model year automobile with two qualified occupants. The Initial Stratum is "C". You cannot determine hospitalization for either of the occupants in the late model year vehicle. You determine one occupant in the nonlate model year automobile was hospitalized and one was not.

Codes

Box D = 4; Box E = 2; Box F = 2; Box A = C; Box B = K

Since you were able to discover one of the occupants from the nonlate model year vehicle was hospitalized, you encode the Final Stratum as "K".

Example 8

One late model year automobile with two qualified occupants collides with a nonlate model year automobile with two qualified occupants. The Initial Stratum is "C". You determine one occupant in the late model year vehicle was not hospitalized. You can not determine hospitalization for the other late model year automobile occupant. One occupant in the nonlate model year vehicle was hospitalized and one was not hospitalized.

OVERVIEW OF SAMPLING ACTIVITIES

Codes Box D = 4; Box E = 3; Box F = 1; Box A = C; Box B = K

Since you were unable to determine if the second occupant from the late model year vehicle was hospitalized, the Final Stratum is "K". Therefore, code "1" for Box F.

Example 9

A late model year automobile with a qualified occupant (driver only, no passengers) runs into a tree. The Initial Stratum is "C". You call the hospital for hospitalization data and you are told they are busy now, but will call you later. You call the occupant at home, and he tells you he was not hospitalized. Later, the hospital returns your call and says the occupant was hospitalized. It is now noon of the day after your assigned contact date and you must stop hospitalization determination.

Codes Box D = 1; Box E = 1; Box F = 0; Box A = C; Box B = J

We restratify the PAR as a "J". The rule is: If, after you have made all reasonable efforts to determine hospitalization for an occupant with certainty and conflicting evidence on hospitalization status remains, code the information from available sources in the following order: (1) Hospital, (2) this occupant, (3) other occupant, (4) relative or friend, (5) Police (PAR or Officer), or (6) Other (e.g., EMS, newspapers).

In summary, Box D will always be the total of all qualified occupants in the CDS vehicles. Box E is the number of qualified occupants whose hospitalization status has been determined. Whereas, Box F is the number of qualified occupants whose hospitalization status cannot be determined and whose outcome could change the Final Stratum of the PAR from a "C" or "D" to a "J" or "K".

Ask this question, "If I knew this occupant was hospitalized, would it change the stratum of the PAR?" If the answer is yes, this occupant should be counted in Box F.

3.5 Beginning of Year Sampling Instructions

At the beginning of a new calendar year, some accidents that occurred in the previous year will be listed at your police jurisdictions. It is important that the accidents in each calendar year be kept separate for sampling purposes. Special instructions will be issued in December of each calendar year detailing how the separate sampling will be accomplished.

4.0 OVERVIEW OF COLLECTED INFORMATION ON SAMPLED CDS ACCIDENTS

For each case sampled, include in the case report a copy of the police report, Case Summary Form, newspaper photos and articles, correspondence, collision diagram, collision measurement table, slides (including index), the applicable crashworthiness data system data collection forms with field logs and Case Review Form, medical injury records, reconstruction algorithm results, and MDE output.

4.1 Required Forms for CDS Cases

It is very important to remember that only the injuries to the occupants of towed CDS applicable vehicles and the model year of those occupants' vehicle(s) determine the Stratum. Also, once a NASS accident is selected for research as a CDS case all the CDS applicable vehicles, towed or nontowed, are candidates for a vehicle inspection. **Towed CDS applicable vehicles require both an exterior and an interior inspection.** In addition, all drivers and occupants of towed CDS applicable vehicles are candidates for an interview. The other vehicles in these accidents are not inspected nor are their occupants interviewed. Table 4-1 is aimed at assisting researchers in form selection.

4.2 Sequencing of Case Materials

Case report forms and miscellaneous materials are to be sequenced in conformity with the guidelines depicted in Figure 4-1. There are eight distinct groupings which may exist with each case, and while the number of groupings may vary with each accident, it is important for the case reviewer (team or zone center) that the composition of the eight groups be maintained.

The first document is the police accident report (PAR). Do not attach any other material to the PAR.

The second group contains the CDS Case Summary Form, newspaper photographs, articles, and other miscellaneous, non-CDS generated materials. This group will give the zone center reviewer a general appreciation of the accident from non-CDS sources and facilitates review of sampling. The documents in this group should be bound with a paper clip. The group will appear in every case, although it will often be composed only of the CDS Case Summary Form.

The third group contains the Accident Collision Diagram, Accident Collision Measurement Table, slides, and the slide index; thus, it provides the reviewer with a general overview of the case based upon the CDS research. Differences between the two versions (Non-CDS and CDS) are to be expected periodically, and preliminary review of this and the preceding group will alert the reviewer to those differences and their eventual resolution in the final CDS version. This group should appear in every case.

Fourth, the Accident Form will appear in every case.

The fifth group contains: [1] a General Vehicle (all vehicles) Form, [2] an Exterior Vehicle (inspected CDS applicable vehicles) Form, [3] an Interior Vehicle (inspected towed CDS applicable vehicles) Form, [4] an Interview Form, [5] the Occupant Assessment Forms--for only those occupants of in-transport towed

OVERVIEW OF COLLECTED INFORMATION ON SAMPLED CDS ACCIDENTS

TABLE 4-1

REQUIRED FORMS FOR NASS CDS CASES

Each NASS CDS accident requires one Case Summary Form, one collision diagram, and one Accident Form. The remaining forms depend upon: (1) the type of vehicles involved in the accident, (2) their police reported tow status, and (3) the level of vehicle inspection. For each vehicle involved in the accident, select the table below which corresponds to the vehicle's tow and "CDS Applicable" status and determine the appropriate forms to submit.

In-transport Towed CDS Applicable Vehicle

	General Vehicle	Exterior Vehicle	Interior Vehicle	Interview	Occupant Assessment	Occupant Injury
Inspected	Yes	Yes	Yes	Yes ¹	Yes	Yes ²
Not Inspected	Yes	No	No	Yes ¹	Yes	Yes ²

In-transport Nontowed CDS Applicable Vehicle

	General Vehicle	Exterior Vehicle	Interior Vehicle	Interview	Occupant Assessment	Occupant Injury
Inspected	Yes	Yes ³	No	No	No	No
Not Inspected	Yes	No	No	No	No	No

In-transport Non-CDS Applicable Vehicle

	General Vehicle	Exterior Vehicle	Interior Vehicle	Interview	Occupant Assessment	Occupant Injury
No Inspection Required	Partial ⁴	No	No	No	No	No

CDS Applicable Vehicle is defined by variable GV07, Body Type. GV07 must equal codes "01"- "49" (i.e., Automobiles, Automobile Derivatives, Utility Vehicles, Van Based Light Trucks, Light Conventional Trucks, and Other Light Trucks).

Non-CDS Applicable Vehicle is defined as GV07 not equal to codes "01"- "49" (i.e., GV07 greater than or equal to "50").

=====
¹ Submit only when an interview is obtained.

² If applicable.

³ Complete pages 1-3 of the Exterior Vehicle Form for CDS Applicable vehicles not in-transport (i.e., for speed reconstruction purposes).

⁴ Complete variables GV01 through GV15 (i.e., page 1) and GV37 through GV58 and GV64 through GV67.

OVERVIEW OF COLLECTED INFORMATION ON SAMPLED CDS ACCIDENTS

FIGURE 4-1

SEQUENCE OF CASE MATERIALS

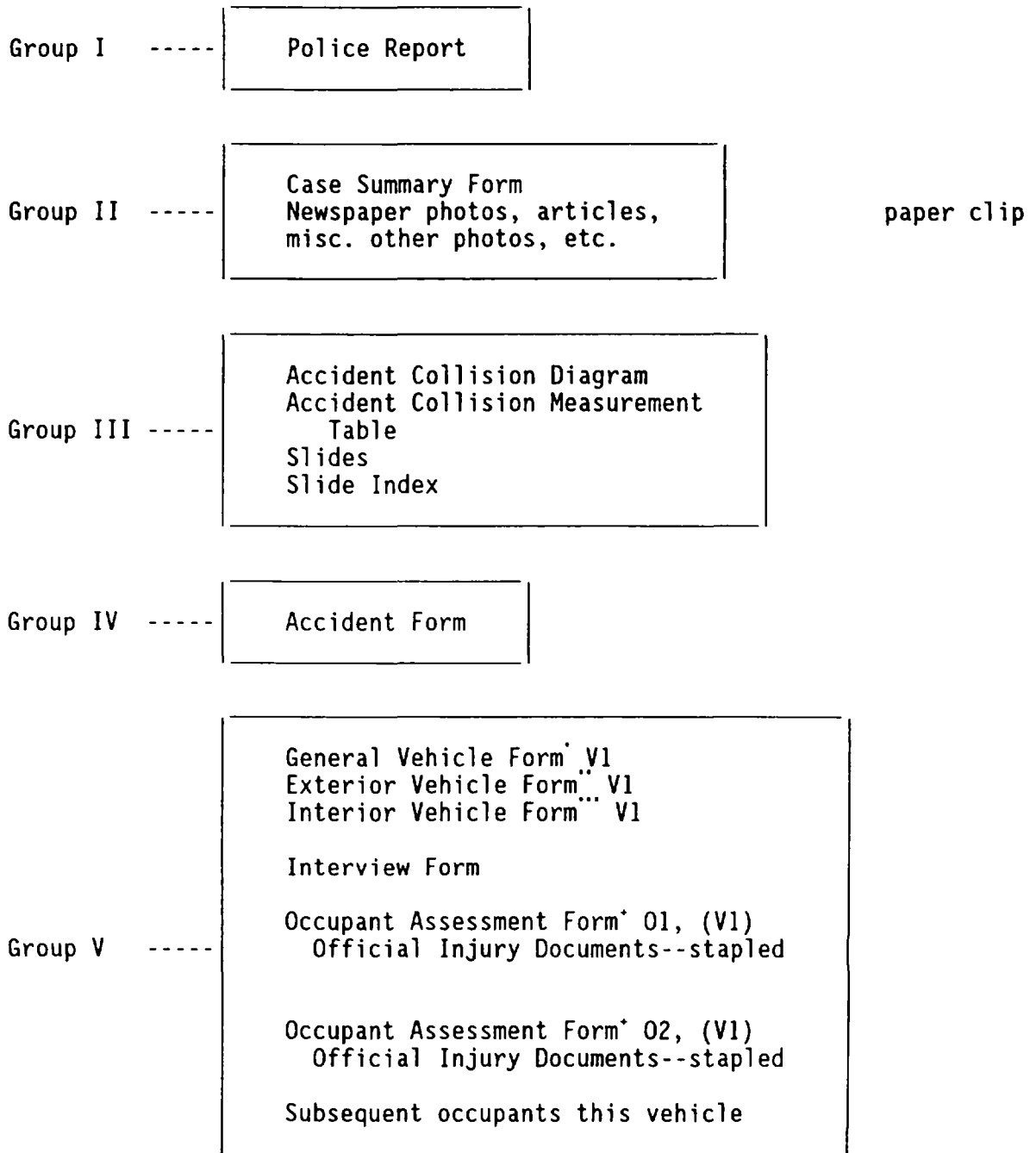

- * All in-transport motor vehicles
- ** All inspected in-transport CDS applicable vehicles
- *** All inspected in-transport towed CDS applicable vehicles
- * Submitted only for all occupants of in-transport towed CDS applicable vehicles
- ** Submitted for all injured occupants of in-transport towed CDS applicable vehicles--exception: exclude if "Injured, unknown severity" or "Unknown if injured"

OVERVIEW OF COLLECTED INFORMATION ON SAMPLED CDS ACCIDENTS

FIGURE 4-1 (Continued)

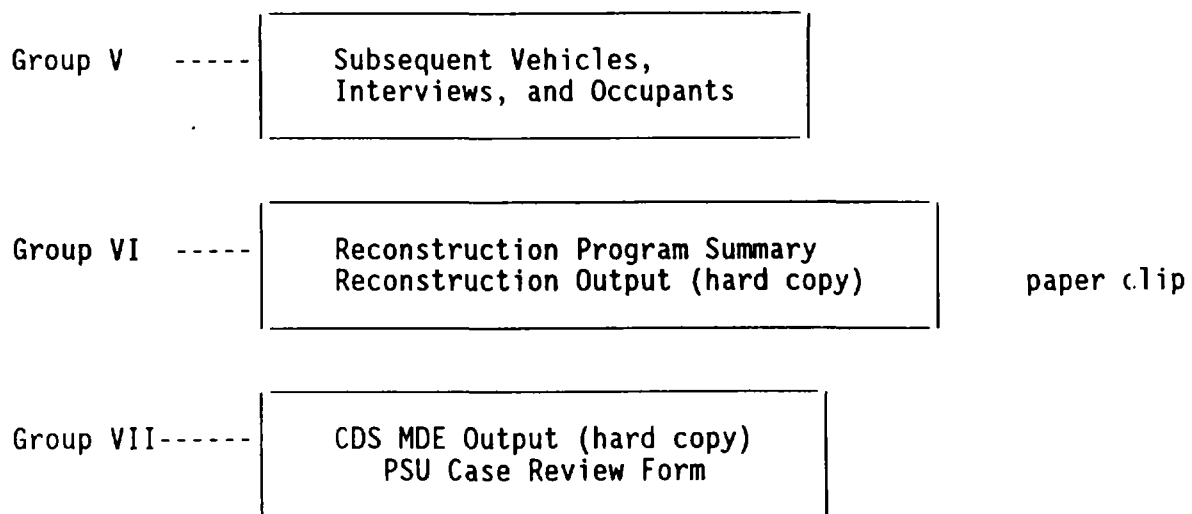

OVERVIEW OF COLLECTED INFORMATION ON SAMPLED CDS ACCIDENTS

CDS applicable vehicles, [6] the Occupant Injury Forms (inserted by the Zone Center)--for all the "injured" occupants of in-transport towed CDS applicable vehicles, and [7] any official injury documents for those injured occupants.

The first form in this vehicle group is the General Vehicle Form; this form must always be present in this group. For "non-CDS applicable vehicles" this form will be the only form present in this group. The Vehicle Exterior Form appears next, if applicable. This will be followed by the Vehicle Interior Form, if applicable. The Interview Form follows the vehicle form(s). This form contains the interview(s) obtained with the occupant(s) of all in-transport towed CDS applicable vehicles.

The final forms in this fifth group are the occupant forms, if applicable. The occupant forms are only submitted for occupants of in-transport towed CDS applicable vehicles. The first form is the Occupant Assessment Form. Next comes the Occupant Injury Form (inserted by the Zone Center) which has any official injury documents identified, sequenced in order and stapled to the back of it. All additional occupant forms will follow in numerical order [Occupant 02 (V1), Occupant 03 (V1), etc.]. The Occupant Injury Form is not submitted when any one of the following three injury conditions occurs. First, the occupant sustained "No injury"; second, the occupant was injured but the severity is unknown (i.e., "Injured, unknown severity"). Third, the information source(s) does not know if the person was injured (i.e., "Unknown if injured"). The second condition means that the source(s) of injury information cannot identify any specific injury code from those listed in the 1993 NASS Injury Coding Manual.

At least one group of this type will appear in every CDS case. Additional vehicles, interviews, and occupants--including their official injury documents, should be grouped in a similar manner. Thus, each group may be thought to represent a vehicle and its occupant(s); and, each such group physically distinguishes one vehicle and its occupant(s) from any other.

The sixth group is composed of the reconstruction (CRASHPC or OLDMISS) Program Summary and the Output (hard copy), assuming a reconstruction program has been exercised for the collision. Upon reviewing the above forms and having become familiar with the accident, the reviewer is then prepared to evaluate both the appropriateness of using the program and the viability of the various inputs on the program summary. These two items, the summary and any output (always include the input data), should be bound together with a paper clip.

The seventh group is composed of the Microcomputer Data Entry (MDE) output and the PSU Case Review Form.

4.3 Information Required on Field Forms (File Structuring Variables)

Case Identification Variables--When using the microcomputer data entry system to enter the field data, certain information is required on each field form (log data are not entered) before it will be accepted. Every field form submitted must have a Primary Sampling Unit Number and a Case Number - Stratum. Team members fill out the Primary Sampling Unit Number and Case Number - Stratum.

Accident Form--For each accident researched, one Accident Form must be filled out. The additional file structuring information needed on this form is the Number of General Vehicle Forms Submitted, Date of Accident, and Number of Recorded Events in This Accident.

OVERVIEW OF COLLECTED INFORMATION ON SAMPLED CDS ACCIDENTS

General Vehicle Form--For each accident researched, at least one General Vehicle Form must be submitted. The additional file structuring information to be included on this form consists of the assigned **Vehicle Number**, **Body Type**, **Police Reported Vehicle Disposition**, **Number of Occupant Forms Submitted**, and **Type of Vehicle Inspection**.

Exterior Vehicle Form--When Exterior Vehicle Forms are filled out, **Vehicle Number** is required for file structuring purposes.

Interior Vehicle Form--When Interior Vehicle Forms are filled out, **Vehicle Number** is required for file structuring purposes.

Occupant Assessment Form--When Occupant Assessment Forms are filled out, **Vehicle Number**, **Occupant Number**, and **Number of Recorded Injuries For This Occupant** are required for file structuring purposes.

Occupant Injury Form--When Occupant Injury Forms are filled out, **Vehicle Number** and **Occupant Number** are required for file structuring purposes.

Treatment of Missing Data--The file (i.e., the computerized database file) structure used in the CDS minimizes the handling of missing data. For example, neither the Exterior Vehicle Form nor the Interior Vehicle Form are present for non-CDS applicable vehicles. The Interior Vehicle Form is absent for police reported nontowed CDS applicable vehicles. Further, neither form is present for uninspected towed CDS applicable vehicles. In addition, no occupant forms are required for occupants of other vehicles and nontowed CDS applicable vehicles. Finally, Occupant Injury Forms are inserted by the Zone Center when required--see the discussion above in Section 4.2, fifth group. However, when accident-involved vehicles or occupants cannot be fully inspected or interviewed and data items are missing, the appropriate form must be filled out with missing data codes and submitted with the case.

4.4 Update Procedures for Hard Copy Field Forms

Data elements which may be updated in the hard copy case report are restricted to certain variables which appear on either vehicle or occupant forms. Other data will not be updated if it is acquired after the initial submission of the case. Note, most variables may be updated before the case is forwarded to the zone center. An Update Form has been developed to keep the Zone Center informed of the status of medical records acquisitions. The Update Form is not included with the initial submission of the case; instead, it is retained at the PSU and partially filled out upon initial case submission. Subsequently, it is completed when the updated medical information arrives.

On the original case form, all data variables which the researcher intends to update should be coded with any available appropriate information or the code designating "Unknown". In addition, the variable number should be circled. This will "signal" that an attempt will be made to update that data variable. In the case of injury updates, the "Update Candidate" brackets, on page 7 of the Occupant Assessment Form, should be marked in the affirmative. The type of injury information obtained should be entered on the front of the Update Form and any supporting documents attached to the back.

Zone Center Work Sheet--A Zone Center Work Sheet has been developed for those variables which are allowable hard copy update candidates. The Zone Center is to complete the required sections of the Work Sheet prior to completion of case quality review so that the subsequently acquired information may be associated

OVERVIEW OF COLLECTED INFORMATION ON SAMPLED CDS ACCIDENTS

with the right case and vehicle or occupant number.

Update Form--This form should be used when the researcher expects to receive medical data after the initial submission. The information in the Initial Submission column on this form is copied from the the Occupant Assessment Log, prior to initial case submission, and allows the researcher to update variables OAL08, OAL09, OAL16, OIL17, OIL18, GV12, and GV39 based on subsequent receipt of official data (e.g., medical record). These data would be difficult to update without recorded knowledge regarding the initial coding.

Update Filing and Submission Instructions--The researcher must complete the Initial Submission column of the Status of Log Injury Information section on the Update Form, as required, prior to the initial submission. This allows the new information to be associated with the corresponding field form in the initial submission, and this also allows the new information to be combined with the existing information (e.g., using the NASS injury coding rules).

All Update Forms may then be stored in a three-ring binder. Each new addition of an Update Form may then be indexed by Case Number - Stratum, Vehicle Number, and Occupant Number. They may also be partially cross-indexed alphabetically based on the name of the driver or occupant. This will facilitate the processing of inquiries from Zone Centers as well as the submission of the Update Form when the official medical data are received.

The name of the individual, and any other descriptive information unique to the team which may identify the individual, should be sanitized from the Update Form and/or the attached medical reports after the information from the latter has been included on the Update Form.

Update Forms should be accumulated, packaged in an individual zone center approved size manila envelope (but not one envelope for each update) which identifies the PSU and is boldly marked: **UPDATES**, and sent to the zone center on a periodic basis according to the schedule in Section 5.2. If the updates are not obtainable by the due date, the reasons the updates could not be obtained are to be indicated on the Update Form and sent to the Zone Center. All updates or reasons the updates were not obtainable must be submitted to the zone center within 84 days of the date the case was sampled.

This eighty-four day time-frame is a guideline established in order to keep the processing of update records proceeding at an orderly pace. Sometimes medical records are not available within 84 days. A team can extend, with Zone Center permission, the length of time available to obtain a medical update. The exact length of the extension will depend upon the time of year the case was selected. Medicals from cases selected in January can be held open much longer than medicals from cases selected in December. At issue from the Zone Center perspective is the total number of medical updates outstanding (i.e., effort required of Zone Center to finish processing the updates) and the likelihood of the medicals being eventually obtained.

The Update Form, described above, will be attached by the Zone Center to the corresponding forms included in the initial submission to the zone center.

OVERVIEW OF COLLECTED INFORMATION ON SAMPLED CDS ACCIDENTS

4.5 Potential Safety Problem Bulletin

All teams will be provided with bulletins (forms)--Figure 4-2, to report any potential vehicle safety problems which they encounter. Submit bulletins to your Zone Center immediately after identification of a potential vehicle safety problem. Each team has been placed on the mailing list for reports of active defect investigations. Teams should become familiar with current investigations and be on the lookout for accidents which are relevant to these investigations; although, other defects or vehicle problems encountered are also of interest and should be reported. Attach a copy of the bulletin submitted to NHTSA to either the Exterior Vehicle Form or Interior Vehicle Form before submitting the case to your zone center. A list of potential safety problems of current interest to NHTSA is contained in Table 4-2. This list is provided for guidance and is not intended to be inclusive.

4.6 CDS Criteria for Acceptable Data Completion

The data completion criteria are used as a standard among all PSUs when determining the minimum acceptable data for completion of a case.

Scene Inspection: The Accident Collision Diagram and slides are required. No excuse is acceptable. If the photo slides did not turn out, a return visit to the scene is required.

Where no evidence of the accident is present, provide a sketch (not scaled) which includes:

1. Approximate vehicle orientation at impact and final rest;
2. Applicable road/roadway delineation (e.g., curbs/edge lines, lane markings, median markings, pavement markings, etc.);
3. Applicable traffic controls (e.g., speed limit); and
4. North arrow placed on diagram.

Where physical evidence of the accident is present, in addition to points two through four above, the following detail must be incorporated in the scene diagram:

1. Documented reference point and reference line relative to physical features present at the scene;
2. Scaled documentation of all accident induced physical evidence;
3. Scaled documentation of all roadside objects contacted;
4. Roadway Surface Type and Surface Condition for all applicable roadways;
5. Grade measurements for all applicable roadways; and
6. Scaled representations of the vehicle(s) at pre-impact, impact, and final rest based upon either:
 - (a) physical evidence, or
 - (b) reconstructed accident dynamics.

OVERVIEW OF COLLECTED INFORMATION ON SAMPLED CDS ACCIDENTS

FIGURE 4-2

POTENTIAL SAFETY PROBLEM BULLETIN

Reporting Date: _____

SEND TO: Jackie Scott or Paula Pitzer
Calspan Corporation KLD Associates, Inc.
Post Office Box 400 8632 Frederickburg Road Suite, 126
Buffalo, New York 14225 San Antonio, Texas 78240

SUBJECT: _____

IDENTIFICATION:

PSU: _____ CASE NO.: _____ ACCIDENT DATE: _____

ACCIDENT LOCATION: _____

INVESTIGATING POLICE AGENCY: _____

VEHICLE MODEL YEAR: _____ MAKE/MODEL: _____

VIN: _____ ODOMETER READING: _____

ACCIDENT DESCRIPTION (include police report)

(continue on back)

ITEM DESCRIPTION (include photograph if possible)

This information is confidential, address all inquiries in writing to the Director, National Center for Statistics and Analysis, U.S. Department of Transportation, National Highway Traffic Safety Administration, Washington, D.C. 20590

OVERVIEW OF COLLECTED INFORMATION ON SAMPLED CDS ACCIDENTS

TABLE 4-2

SPECIFIC AREAS OF INTEREST TO NHTSA RULEMAKING

CRASH AVOIDANCE

1. Accidents involving vehicles driven by handicapped drivers.
2. Accidents involving vehicles equipped with adaptive aids.
3. Accidents in which failure of a multipiece rim (not a tire failure) caused or contributed to the severity of the accident.
4. Accidents involving malfunction of a speed governor or speed control unit.
5. Accidents where the driver reported confusion about the location of display or control elements of the vehicle.
6. Accidents where underinflation of tires caused or contributed to the severity of accident.
7. Accidents involving pedestrian and/or cyclist injured by impact with outside mirrors
8. Accidents involving injury to motorcycle drivers due to impact with the motorcycle mirrors.
9. Accidents where driver reported that distortion of image in convex mirror confused him (especially late model GM cars).
10. Accidents where commercial vehicle drivers reported that they could not see car, pedestrian, or cycle in a specific blind spot (such as in the right front area of large truck-tractors).
11. Accidents where driver or a passenger car or light truck reported that they could not see because of an obstruction of view by some part of the vehicle (such as inside mirror or roof support pillar)
12. Accidents where the vehicle's defrost/defog system or wiper system could not provide an adequate view of the traffic scene through the windshield.
13. Accidents involving pickup trucks pulling fifth-wheel type trailer

CRASHWORTHINESS

1. Seat and/or seat back failures in crashes and their contributions to occupant injury.
2. Identify external vehicle components (i.e., hood, grill, windshield wiper, etc.) that penetrate the windshield and the degree of such penetration in crashes involving vans and light trucks
3. Ejections through the hatchback or station wagon rear doors in rear impacts. Identify whether ejection was through window opening or through door or hatchback opening because of latch failure
4. Cars involving child restraints that break or involve injury. Identify the restraint by make and model, how and which position used.

CORROSION

1. Structural rust of uni-body undercarriage, vehicle chassis frames, floor boards in areas of seat belt attachment points, seat or seat track anchorages.
2. Rust which develops in areas where the owner can observe the rust and therefore be forewarned, but which might have safety implications such as cowl area and wipers, around windshield or backlight.
3. Rust on weight bearing or vehicle guidance components, the failure of which could affect vehicle safety and do not normally wear out in service, such as tie rods, control arms, strut rods
4. Rust of areas where the owners report exhaust intrusion such as wheel wells, wagon tire wells and rear floor pans

OVERVIEW OF COLLECTED INFORMATION ON SAMPLED CDS ACCIDENTS

Vehicle Exterior Inspections: To be credited as "inspected", at a minimum, slides of the exterior of the damaged vehicle must be submitted along with the completed form. If the vehicle has been repaired prior to the inspection, then photo slides of the repaired vehicle and damaged exterior components (where circumstances permit) along with a completed form are required. Crush dimensions and a CDC must be provided when data permit. If there is no measurable damage, then slides of the vehicle and a completed Exterior Vehicle Form will suffice. Other vehicles are not inspected.

Vehicle Interior Inspections: To be credited as "inspected", at a minimum, slides of the interior of the damaged vehicle must be submitted along with the completed form. If the vehicle has been repaired prior to the inspection, then photo slides of the repaired interior and damaged interior components (where circumstances permit) along with a completed form are required. Documentation of Integrity, Glazing, Intrusions, Steering Column, Restraint Systems, Seat Types, Instrument Panel, and Occupant Contacts must be provided when data permit. If there is no visible or discernible interior damage or contact, slides of the vehicle and a completed Interior Vehicle Form will suffice.

Accident Circumstance Interviews: If the driver was contacted and the Accident Data Questions section of the Interview Form completed (i.e., the information provided is sufficient enough to support that a partial or complete interview was obtained) and submitted, then it is recorded as an interview. An interview with the driver is desired; however, if an interview cannot be obtained because the driver is fatally injured or incapacitated, the Accident Data Questions must be provided by another occupant of the same vehicle or an eyewitness (including occupants of uninvolved vehicles).

Occupant Interviews: If an occupant was contacted and the Occupant Data Questions section of the Interview Form completed (i.e., the information provided is sufficient enough to support that a partial or complete interview was obtained) and submitted, then it is recorded as an interview. An interview with either a driver, occupant, relative, or friend is acceptable as a surrogate interview for other occupants. Police officers, occupants of other involved vehicles, and witnesses, who know the occupant under consideration only because of the accident, cannot be considered as surrogates and, therefore, no partial or complete interview credit can be assigned to researchers.

Official Medical Data: A copy of a hospital records department or other clinical institute final discharge medical summary is required. Copies of an emergency room or other abbreviated and advanced medical reports are acceptable with prior zone center approval only if established relations dictate (i.e., hospital will not or does not provide a more comprehensive medical report). Copies of physician reports are acceptable when appropriate (i.e., PAR reports victim as injured but driven to private physician). Substitute procedures, including handwritten or transcribed information, are acceptable only with the prior approval of the zone center with COTR concurrence. Only official copies of autopsy reports are acceptable. Reports from lay coroners and certificates of death are not considered official medical records.

Finally, before alternative methods for acquiring official records (i.e., handwritten copies or telephone transcripts of medical data) are authorized, all avenues for obtaining the hard copy must be exhausted. Therefore, establishment of PSU relations will be closely monitored by each zone center to ensure that teams do not default to alternative methods because they are easier to establish.

5.0 CDS SUBMISSION INSTRUCTIONS

5.1 Quality Control Checks for PSU Teams

Please find below a list of quality control checks to be made by PSU teams.

5.1.1 Quality Control Checks Prior to Microcomputer Data Entry

Each case should be reviewed by a person other than the originating researcher using the PSU Case Review Form prior to entering the case via MDE. This effort tends to minimize encoding errors resulting from values which are either illegal or legal but incorrect. The noncoded items in the case should also be checked. The primary researcher is to be informed (preferably in writing) of any problems detected during this review and that researcher is to assume the responsibility for their resolution. Some suggested areas where problems may occur are as follows:

- o Has the case passed in-house review?
- o Are all official records and slides present?
- o Check slides and official records to make sure they correspond to the case submitted (slides and police report shouldn't be placed next to each other because the photocopied police report tends to "bleed" on the slide folders).
- o Have portions of Update Forms been filled out where needed?
- o Do the control charts properly reflect how much of the case report has been completed?
- o Make sure medical reports are properly sanitized.
- o Are all data collection forms present?
- o Are the logs properly completed on the forms?
- o Make sure case materials are sequenced properly and the case report envelope is stamped and properly identified.
- o Check noncoded data for correctness and its interface with coded data.
- o Check to make sure that the coded data are properly and legibly entered on the data collection forms.
- o Have "+"s or "-"s been circled for GV31 and GV32 on the General Vehicle Form, for EV22 and EV25 on the Exterior Vehicle Form?

5.1.2 Quality Control Checks Resulting from Microcomputer Data Entry

Inconsistencies, out-of-range values, and other error diagnostics encountered during the MDE are explained in CDS MDE error checks and tables. All errors detected by the computer edits are corrected by the PSU before the case is forwarded to the zone center--unless the zone center is notified and suggests shipment of an incompletely entered case. MDE intraform and interform checks appear on the computer screen when they are tripped. MDE checks consist of two letters followed by four numbers. The fourth number is actually the line number

TABLE 5-1

MDE Checks: Format, Designations, and Tables

Digit Location:	1st	2nd	3rd	4th	5th	6th
MDE Check Format:	Letter	Letter	Number	Number	Number	Number

L E T T E R S

Definition	IntraForm Designators
A = Accident Form	AA = Accident intraform edit checks
G = General Vehicle Form	GG = General Vehicle intraform edit checks
E = Exterior Vehicle Form	EE = Exterior Vehicle intraform edit checks
C = Interior Vehicle Form	CC = Interior Vehicle intraform edit checks
H = Occupant Assessment Form	HH = Occupant Assessment intraform edit checks
T = Occupant Injury Form	TT = Occupant Injury intraform edit checks

InterForm Designators

- AG = Accident--General Vehicle interform edit checks**
- AE = Accident--Exterior Vehicle interform edit checks**
- GE = General Vehicle--Exterior Vehicle interform edit checks**
- GC = General Vehicle--Interior Vehicle interform edit checks**
- EC = Exterior Vehicle--Interior Vehicle interform edit checks**
- AH = Accident--Occupant Assessment Interform edit checks**
- GH = General Vehicle--Occupant Assessment interform edit checks**
- EH = Exterior Vehicle--Occupant Assessment interform edit checks**
- CH = Interior Vehicle--Occupant Assessment interform edit checks**
- AT = Accident--Occupant Injury interform edit checks**
- GT = General Vehicle--Occupant Injury interform edit checks**
- ET = Exterior Vehicle--Occupant Injury interform edit checks**
- CT = Interior Vehicle--Occupant Injury interform edit checks**
- HT = Occupant Assessment--Occupant Injury interform edit checks**
- MM = Multiple Forms (more than 2) interform edit checks**

The above two letter designations denote that the interform consistency check is written solely or primarily between the two indicated forms.

TABLE 5-1 (Continued)

T A B L E S

Table	Variables Involved	MDE Check(s)
A1	OA05, Occupant's Age OA06, Occupant's Sex OA07, Occupant's Height	HH002
A2	OA06, Occupant's Sex OA07, Occupant's Height OA08, Occupant's Weight	HH007
A4	GV07, Body Type GV19, Vehicle Curb Weight	GG008
A5	OI06 et al., Body Region OI07 et al., Type of Anatomic Structure OI08 et al., Specific Anatomic Structure OI09 et al., Level of Injury OI10 et al., AIS Severity OI11 et al., Aspect	TT002
A6	GV31, Longitudinal Component of Delta V GV32, Lateral Component of Delta V EV06, 1st C.D.C. - Direction of Force	GE017, GE018
A7	GV05, Vehicle Make GV07, Body Type	GG005
A11	GV15, Accident Type (pair check)	GG032
A12	GV04, Vehicle Model Year GV08, Vehicle Identification Number (check digit algorithm)	GG092
A14	AC14 Class of Vehicle AC17 Contacted Class of Vehicle GV07 Body Type	AG027 AG028
A15	IV48, Intruding Component OI11, Injury Source OI14 Occupant Area Intrusion No.	CT009
A16	AC15, General Area of Damage AC18, General Area of Damage GV15, Accident Type	AG047 AG048

within the check. When contacting your zone center regarding an MDE check, please reference the check according to its two letters and first three numbers. Table 5-1 above explains the reference system used in the MDE checks. Eleven tables accompany the MDE checks. These tables are: A-1, A-2, A-4 through A-7, A-11, A-12, and A-14 through A-16. These tables are also discussed above.

5.1.3 Check to Make Sure Administrative Procedures Are Being Followed

- o Are control charts and activity logs (when used) updated weekly?
- o Are monthly reports and sampling materials sent to the zone center?
- o Are manuals up-to-date and properly displayed?
- o Are needed supplies in stock (e.g., film, etc.)?

5.1.4 Check Sampling Procedures

- o Periodically review sampling procedures in team meetings.
- o Document any problems in the monthly report.

5.1.5 Check Data Collection Procedures

- o Periodically review procedures. Document when meetings are held and any problems discovered with the data collection procedures or forms. Indicate problems in the monthly report or over the Message System to your zone center. Keep a file of problems encountered and go over them with a zone center representative during the next zone center site visit.

5.1.6 Check to Make Sure Updates Are Being Processed Properly

- o Are the medical update records filed by case number?
- o Do zone center and PSU records agree (see zone center list of outstanding updates)?

5.1.7 Check Individual Effort and Accuracy in Collecting Evidence and Skill in Interpretation

- o Discuss data collection procedures and efficient ways to execute them in team meetings. Discuss how much follow-up effort is needed for obtaining interviews and think about methods other than the phone and personal contact for obtaining more interviews (e.g., letters).

5.2 Case Submission

The final date for the remaining submission of **December 1993** cases (exclusive of updates) is **February 11, 1994**. All remaining updates for 1993 cases are to be received at the zone center by **April 8, 1994**.

Cases acquired in 1994 shall be submitted to the zone centers on a weekly basis. The materials for each case are to be ordered in the recommended format discussed in Section 4.2; each case is to be packaged in a separate envelope with the appropriate identification and account of contents on the Administrative log. These procedures will provide uniformity across teams and, in turn, reduce the

CDS SUBMISSION INSTRUCTIONS

variation encountered by the zone center upon receipt of the cases. Furthermore, the weekly submission will minimize the peaks and valleys in the zone center case review workload.

Submission Schedule--Cases shall be submitted on a weekly basis beginning **February 4, 1994**, according to the schedule (Table 5-2). Essentially, there will be at least one month to make the initial submission of any case. All cases are to be submitted within four weeks following the date on which they were sampled. This means that the maximum time available to submit a case will be twenty-eight days from the date of sample. Interviews, vehicle inspections, and scenes not completed in the allowed time period will not be updated. Table 5-3 contains the 1993 and 1994 quarterly and annual file closeout schedules.

Those variables which are allowed updates, but have not been completed within the time available for the initial case submission, should be documented on the appropriate record and submitted as updates in accordance with the schedule. The update time schedule may be extended with prior approval of the zone center. See Section 4.4 (Update Procedures for Hard Copy Field Forms).

Cases which are completed (i.e., no updates needed) prior to elapsing of the available time period should be submitted on the next, earliest case submission.

Case Envelope--The standardized case envelope shall be 10 X 13 inches fiber paper (i.e., Tyvek). The case envelope belongs inside the shipping envelope. The Administrative log, Table 5-4, belongs on the case envelope. The PSU number, case number, accounting of case materials, and the status of the case at the time of submission, as shown in Table 5-4, are to be entered on the log. The log is to be positioned on the right-hand side of the envelope when the envelope is positioned with its flap on the underside and to the right.

This information helps the Zone Center effectively sort the case at the inception of the quality control process; the standardized envelopes will facilitate storage and retrieval.

All medical records for each case shall be submitted in a 9 X 12 manilla envelope. A pre-printed Injury Information label, provided by NHTSA, shall be attached to the front of each envelope. The medical information will be used by the Zone Center to complete the injury coding for each occupant. After completion of injury coding, the Zone Center will keep the medical record envelopes in a separate file.

Case update records, submitted after initial case submission, shall be submitted in a 10 X 13 inch fiber paper envelope. Identify the PSU, and boldly mark the front of the envelope: **UPDATES**. The updates will be removed from the envelope and collated with the original forms in their respective cases by the zone center.

Case Slide Holders -- The slide holders shall be of sufficient quality to securely retain the slides when the holder is inverted or rotated for viewing.

Shipment of Cases--The envelopes containing the individual cases which are eligible for shipment, according to the schedule shown in Table 5-2, should be packaged in a box or other suitable container and mailed to the Zone Center. Do not use overnight or Express Mail services without prior approval of the COTR. The PSU should provide an acknowledgement of delivery card, return receipt, or similar confirmation to ensure the shipment was received by the Zone Center.

TABLE 5-2

CDS Case Submission Schedule

CASES SAMPLED ON OR BEFORE	MUST BE SUBMITTED ON OR BEFORE (+ 4 weeks)	MUST BE RECEIVED ON OR BEFORE (+ 5 weeks)	MUST BE REVIEWED ON OR BEFORE (+ 7 weeks)	MUST RECEIVE UPDATES ON OR BEFORE (+ 12 weeks)
--	---	--	--	---

1993

08-Oct-93	05-Nov-93	12-Nov-93	26-Nov-93	31-Dec-93
22-Oct-93	19-Nov-93	26-Nov-93	10-Dec-93	14-Jan-94
05-Nov-93	03-Dec-93	10-Dec-93	24-Dec-93	28-Jan-94
19-Nov-93	17-Dec-93	24-Dec-93	07-Jan-94	11-Feb-94
03-Dec-93	31-Dec-93	07-Jan-94	21-Jan-94	25-Feb-94
17-Dec-93	14-Jan-94	21-Jan-94	04-Feb-94	11-Mar-94
31-Dec-93	28-Jan-94	04-Feb-94	18-Feb-94	25-Mar-94
14-Jan-94	11-Feb-94	18-Feb-94	04-Mar-94	08-Apr-94

1994

07-Jan-94	04-Feb-94	11-Feb-94	25-Feb-94	01-Apr-94
14-Jan-94	11-Feb-94	18-Feb-94	04-Mar-94	08-Apr-94
21-Jan-94	18-Feb-94	25-Feb-94	11-Mar-94	15-Apr-94
28-Jan-94	25-Feb-94	04-Mar-94	18-Mar-94	22-Apr-94
04-Feb-94	04-Mar-94	11-Mar-94	25-Mar-94	29-Apr-94
11-Feb-94	11-Mar-94	18-Mar-94	01-Apr-94	06-May-94
18-Feb-94	18-Mar-94	25-Mar-94	08-Apr-94	13-May-94
25-Feb-94	25-Mar-94	01-Apr-94	15-Apr-94	20-May-94
04-Mar-94	01-Apr-94	08-Apr-94	22-Apr-94	27-May-94
11-Mar-94	08-Apr-94	15-Apr-94	29-Apr-94	03-Jun-94
18-Mar-94	15-Apr-94	22-Apr-94	06-May-94	10-Jun-94
25-Mar-94	22-Apr-94	29-Apr-94	13-May-94	17-Jun-94
01-Apr-94	29-Apr-94	06-May-94	20-May-94	24-Jun-94
08-Apr-94	06-May-94	13-May-94	27-May-94	01-Jul-94
15-Apr-94	13-May-94	20-May-94	03-Jun-94	08-Jul-94
22-Apr-94	20-May-94	27-May-94	10-Jun-94	15-Jul-94
29-Apr-94	27-May-94	03-Jun-94	17-Jun-94	22-Jul-94
06-May-94	03-Jun-94	10-Jun-94	24-Jun-94	29-Jul-94
13-May-94	10-Jun-94	17-Jun-94	01-Jul-94	05-Aug-94
20-May-94	17-Jun-94	24-Jun-94	08-Jul-94	12-Aug-94
27-May-94	24-Jun-94	01-Jul-94	15-Jul-94	19-Aug-94
03-Jun-94	01-Jul-94	08-Jul-94	22-Jul-94	26-Aug-94
10-Jun-94	08-Jul-94	15-Jul-94	29-Jul-94	02-Sep-94
17-Jun-94	15-Jul-94	22-Jul-94	05-Aug-94	09-Sep-94
24-Jun-94	22-Jul-94	29-Jul-94	12-Aug-94	16-Sep-94

TABLE 5-2 (Cont'd)

CDS Case Submission Schedule

CASES SAMPLED ON OR BEFORE	MUST BE SUBMITTED ON OR BEFORE (+ 4 weeks)	MUST BE RECEIVED ON OR BEFORE (+ 5 weeks)	MUST BE REVIEWED ON OR BEFORE (+ 7 weeks)	MUST RECEIVE UPDATES ON OR BEFORE (+ 12 weeks)
--	---	--	--	---

1994

01-Jul-94	29-Jul-94	05-Aug-94	19-Aug-94	23-Sep-94
08-Jul-94	05-Aug-94	12-Aug-94	26-Aug-94	30-Sep-94
15-Jul-94	12-Aug-94	19-Aug-94	02-Sep-94	07-Oct-94
22-Jul-94	19-Aug-94	26-Aug-94	09-Sep-94	14-Oct-94
29-Jul-94	26-Aug-94	02-Sep-94	16-Sep-94	21-Oct-94
05-Aug-94	02-Sep-94	09-Sep-94	23-Sep-94	28-Oct-94
12-Aug-94	09-Sep-94	16-Sep-94	30-Sep-94	04-Nov-94
19-Aug-94	16-Sep-94	23-Sep-94	07-Oct-94	11-Nov-94
26-Aug-94	23-Sep-94	30-Sep-94	14-Oct-94	18-Nov-94
02-Sep-94	30-Sep-94	07-Oct-94	21-Oct-94	25-Nov-94
09-Sep-94	07-Oct-94	14-Oct-94	28-Oct-94	02-Dec-94
16-Sep-94	14-Oct-94	21-Oct-94	04-Nov-94	09-Dec-94
23-Sep-94	21-Oct-94	28-Oct-94	11-Nov-94	16-Dec-94
30-Sep-94	28-Oct-94	04-Nov-94	18-Nov-94	23-Dec-94
07-Oct-94	04-Nov-94	11-Nov-94	25-Nov-94	30-Dec-94
14-Oct-94	11-Nov-94	18-Nov-94	02-Dec-94	06-Jan-95
21-Oct-94	18-Nov-94	25-Nov-94	09-Dec-94	13-Jan-95
28-Oct-94	25-Nov-94	02-Dec-94	16-Dec-94	20-Jan-95
04-Nov-94	02-Dec-94	09-Dec-94	23-Dec-94	27-Jan-95
11-Nov-94	09-Dec-94	16-Dec-94	30-Dec-94	03-Feb-95
18-Nov-94	16-Dec-94	23-Dec-94	06-Jan-95	10-Feb-95
25-Nov-94	23-Dec-94	30-Dec-94	13-Jan-95	17-Feb-95
02-Dec-94	30-Dec-94	06-Jan-95	20-Jan-95	24-Feb-95
09-Dec-94	06-Jan-95	13-Jan-95	27-Jan-95	03-Mar-95
16-Dec-94	13-Jan-95	20-Jan-95	03-Feb-95	10-Mar-95
23-Dec-94	20-Jan-95	27-Jan-95	10-Feb-95	17-Mar-95
30-Dec-94	27-Jan-95	03-Feb-95	17-Feb-95	24-Mar-95
06-Jan-95	03-Feb-95	10-Feb-95	24-Feb-95	31-Mar-95
13-Jan-95	10-Feb-95	17-Feb-95	03-Mar-95	07-Apr-95
20-Jan-95	17-Feb-95	24-Feb-95	10-Mar-95	14-Apr-95

TABLE 5-3

CDS File Closeout Schedule

CASES SAMPLED ON OR BEFORE	MUST BE APPROVED ON OR BEFORE (+ 13 weeks)	MUST BE CLOSED OUT ON OR BEFORE (+ 13 weeks)	QUARTERLY REPORT DUE ON OR BEFORE (+ 14 weeks)	SHIP CASES TO STORAGE CONTRACTOR (+ 25 weeks)
---	---	---	---	--

1993

01-Oct-93	31-Dec-93	31-Dec-93	07-Jan-94	25-Mar-94
08-Oct-93	07-Jan-94	THIRD QTR	THIRD QTR	THIRD QTR
15-Oct-93	14-Jan-94			
22-Oct-93	21-Jan-94			
29-Oct-93	28-Jan-94			
05-Nov-93	04-Feb-94			
12-Nov-93	11-Feb-94			
19-Nov-93	18-Feb-94			
26-Nov-93	25-Feb-94			
03-Dec-93	04-Mar-94			
10-Dec-93	11-Mar-94			
17-Dec-93	18-Mar-94			
24-Dec-93	25-Mar-94			
31-Dec-93	01-Apr-94			
07-Jan-94	08-Apr-94			
14-Jan-94	15-Apr-94			
21-Jan-94	22-Apr-94	22-Apr-94	29-Apr-94	15-Jul-94
		FOURTH QTR	FOURTH QTR	FOURTH QTR
		1993 ANNUAL REPORT DUE		27-May-94

1994

07-Jan-94	08-Apr-94			
14-Jan-94	15-Apr-94			
21-Jan-94	22-Apr-94			
28-Jan-94	29-Apr-94			
04-Feb-94	06-May-94			
11-Feb-94	13-May-94			
18-Feb-94	20-May-94			
25-Feb-94	27-May-94			
04-Mar-94	03-Jun-94			
11-Mar-94	10-Jun-94			
18-Mar-94	17-Jun-94			
25-Mar-94	24-Jun-94			
01-Apr-94	01-Jul-94	01-Jul-94	08-Jul-94	23-Sep-94
08-Apr-94	08-Jul-94	FIRST QTR	FIRST QTR	FIRST QTR
15-Apr-94	15-Jul-94			
22-Apr-94	22-Jul-94			
29-Apr-94	29-Jul-94			

TABLE 5-3 (Cont'd)

CDS File Closeout Schedule

CASES SAMPLED ON OR BEFORE	MUST BE APPROVED ON OR BEFORE (+ 13 weeks)	MUST BE CLOSED OUT ON OR BEFORE (+ 13 weeks)	QUARTERLY REPORT DUE ON OR BEFORE (+ 14 weeks)	SHIP CASES TO STORAGE CONTRACTOR (+ 25 weeks)
----------------------------------	---	---	---	--

1994

06-May-94	05-Aug-94			
13-May-94	12-Aug-94			
20-May-94	19-Aug-94			
27-May-94	26-Aug-94			
03-Jun-94	02-Sep-94			
10-Jun-94	09-Sep-94			
17-Jun-94	16-Sep-94			
24-Jun-94	23-Sep-94			
01-Jul-94	30-Sep-94	30-Sep-94	07-Oct-94	23-Dec-94
08-Jul-94	07-Oct-94	SECOND QTR	SECOND QTR	SECOND QTR
15-Jul-94	14-Oct-94			
22-Jul-94	21-Oct-94			
29-Jul-94	28-Oct-94			
05-Aug-94	04-Nov-94			
12-Aug-94	11-Nov-94			
19-Aug-94	18-Nov-94			
26-Aug-94	25-Nov-94			
02-Sep-94	02-Dec-94			
09-Sep-94	09-Dec-94			
16-Sep-94	16-Dec-94			
23-Sep-94	23-Dec-94			
30-Sep-94	30-Dec-94			
07-Oct-94	06-Jan-95	06-Jan-95	13-Jan-95	31-Mar-95
14-Oct-94	13-Jan-95	THIRD QTR	THIRD QTR	THIRD QTR
21-Oct-94	20-Jan-95			
28-Oct-94	27-Jan-95			
04-Nov-94	03-Feb-95			
11-Nov-94	10-Feb-95			
18-Nov-94	17-Feb-95			
25-Nov-94	24-Feb-95			
02-Dec-94	03-Mar-95			
09-Dec-94	10-Mar-95			
16-Dec-94	17-Mar-95			
23-Dec-94	24-Mar-95			
30-Dec-94	31-Mar-95			
06-Jan-95	07-Apr-95			
13-Jan-95	14-Apr-95			
20-Jan-95	21-Apr-95	21-Apr-95	28-Apr-95	14-Jul-95
		FOURTH QTR	FOURTH QTR	FOURTH QTR
1994 ANNUAL REPORT DUE				26-May-95

TABLE 5-4

U.S. DOT/NHTSA

NASS/CDS

ADMINISTRATIVE LOG-A

TO BE COMPLETED BY TEAM

1. PSU Number _____
2. Case Number—Stratum _____
3. Assigned Researcher Number _____
4. Status of Assigned Researcher _____
 (1) Researcher (4) Former researcher
 (2) Novice (9) Researcher assistant
 (3) Probation
5. Accident Date _____/_____/_____
6. Sample Date _____/_____/_____
7. Date Due at Zone Center _____/_____/_____
8. Special Studies Case _____
 SS15 SS16 SS17 SS18 SS19
9. Jurisdiction _____
10. Number of Non-Towed CDS Applicable Vehicles _____
11. Number of Towed CDS Applicable Vehicles _____
12. Number of General Vehicle Forms Submitted _____
13. Number of Exterior Vehicle Forms Submitted _____
14. Number of Interior Vehicle Forms Submitted _____
15. Number of Occupant Assessment Forms Submitted _____
16. Injury Coding Required? _____
 (0) No
 (1) Yes
17. Number of Occupants With Official Medical Records Submitted _____
18. Reconstruction in Case _____
 (0) None
 (1) CRASH
 (2) OLDMISS
 (3) CRASH and OLDMISS
19. Potential Safety Problem Bulletin _____
 (0) No
 (1) Submitted by PSU

For Zone Center Use Only

- (2) Submitted by PSU and sent to NHTSA by ZC
- (3) Identified by ZC and sent to NHTSA
- (4) Submitted by PSU and not sent to NHTSA by ZC

The addresses for the zone centers are as follows:

Zone Center #1	Jackie Scott Calspan Corporation Post Office Box 400 Buffalo, New York 14225	(716)-631-6991 {U.S. mail}
	4455 Genesee Street Cheektowaga, New York 14225	{UPS, Federal Express, etc.}
Zone Center #2	Paula Pitzer KLD Associates, Inc. 8632 Frederickburg Road Suite 126 San Antonio, Texas 78240	(210)-699-9065 {U.S. mail, UPS, Federal Express, etc.}

5.3 Case Deletion Procedures

PSUs

The following procedure for deleting cases should be adhered to for all CDS cases:

1. Call your zone center for approval. Request that the case be dropped and give the reason.
2. Send a follow-up message informing the zone center and NCSA (HDQ) of the case to be dropped. Include the following information in the message.
 - a. Case Number
 - b. Sample Date
 - c. Accident Date
 - d. Accident Time
 - e. PAR Number
 - f. Jurisdiction
 - g. Dropped Date (date Zone Center/HDQ gave approval)
 - h. Reason Dropped (list provided by COTR)
 - i. Team Stratification Error (Y=yes, N=no)
 - j. Dropped By (person who authorized dropping the case)
3. The case must be MDE'ed by the PSU and subsequently released to the zone center. To MDE the case, complete the **Accident Form** and one **General Vehicle Form**. This may differ from the actual structure of the case, but it is desired to minimize the number of forms required for the case to be released. To MDE the case, proceed as follows:
 - a. Case and Form Selection
 - (1) On Main Menu: **Press F3-Add or Change Case Data**
 - (2) On Case Selection Menu: **Select Case Number - Press Enter**
 - (3) On MDE Menu: **Press F1-MDE Add**

- b. Accident Form
 (1) Complete data fields as follows:

<u>Variable Number</u>	<u>Valid Codes</u>
AC03	01
AC06	0
AC11	01
AC13-AC18	\$ in first position of each variable with spaces in additional positions

- (2) **Press Enter**
 (3) **Press F3**
 (4) **Intra Errors - Press Enter**
 (5) **Redisplay Accident Form(N)? - Press Enter**
 (6) **Display Next Form(Y)? - Press Enter**

- c. General Vehicle Form
 (1) Complete data fields as follows:

<u>Variable Number</u>	<u>Valid Codes</u>
GV04-GV06	\$ in first character position of each variable
GV07	99
GV08	\$ in first character position
GV09	0
GV10-GV15 GV37-GV58 GV64-GV67	--- \$ in first character position of each variable with spaces in additional positions

- (2) **Press Enter**
 (3) **Intra Errors - Press Enter**
 (4) **Redisplay General Vehicle Form(N)? - Press Enter**
 (5) **Inter Errors - Press Enter**
 (6) **The Case Is Now Complete - Press Enter**
 (7) **On MDE Menu: Press Esc**
 (8) **On Case Selection Menu - Press ESC**

- d. Release Case
 (1) **On Main Menu: Press F4-Release Case**
 (2) **On Case Selection Menu: Select Case Number - Press Enter**
 (3) **On Error Summary Screen: Press Enter**
 (NOTE: You will get some errors on your Error Summary Screen;
 ignore these and continue with procedure.)
 (4) **Do you want to release case with errors?-Enter Y - Press Enter**
 (5) **Are you sure?-Enter Y - Press Enter**
 (6) **Make sure printer is on so that printout of case can be made**

4. Send the dropped hard copy case report to the zone center. Each dropped case is to be sent to the zone center in a separate standard envelope.

- a. Label the outside of the envelope as follows:
 (1) Place the Administrative log and write in the PSU number and case number
 (2) Write in large letters: **DROPPED** (under the Administrative log)

CDS SUBMISSION INSTRUCTIONS

- (3) Write the date the zone center approved to drop the case
- (4) Write the person(s) who gave zone center approval to drop the case

b. Place inside the envelope:

- (1) PAR
- (2) Accident Form
- (3) General Vehicle Form
- (4) MDE printout
- (5) Any additional case related materials

Zone Centers

The case will be deleted from the zone center's active case file at a later date--after the zone center reviews the hard copy case report and agrees that the case should be dropped. Zone centers will list the case number and reason why the case was dropped in their monthly, quarterly, and annual reports.

NCSA - COTR

The COTR will:

1. Use the monthly report as a record for advising Accident Investigation Division (AID) of cases to be deleted from the file.
2. Determine the disposition of the dropped case report (e.g., shipped to NHTSA for review or destroyed at the zone center).

6.0 GES QUALITY CONTROL AND SUBMISSION INSTRUCTIONS

6.1 Quality Control Checklist for GES Sampling and Mailing

Complete the checklist shown in Table 6-1 for each submission of GES PARs.

6.2 GES Submission Instructions

The following guidelines should be carefully reviewed and adhered to.

1. The contents of each envelope should include the following:
 - (a) GES Sampled PAR Inventory (SPI) sheet(s);
 - (b) Stratification Record(s) (SR) for each jurisdiction visited; and
 - (c) Copy of each PAR highlighted on the Stratification Record.
 - (d) One Quality Control Checklist (QCC)

The SR has not changed for 1994. The QCC has been revised slightly, and the Package Inventory has been replaced by the SPI.

2. Use only 10 x 13 inch Manila envelopes and write GES and your PSU number in the lower right-hand corner. Do not put submissions from more than one PSU in an envelope.

3. Address the envelope to your respective Zone Center:

Zone Center #1	Jackie Scott Calspan Corporation Post Office Box 400 Buffalo, New York 14225	(716)-631-6991
----------------	---	----------------

Zone Center #2	Paula Pitzer KLD Associates, Inc. 8632 Frederickburg Road, Suite 126 San Antonio, Texas 78240	(210)-699-9065
----------------	--	----------------

4. Arrange the contents in the following manner.
 - o First should be the Sampled PAR Inventory sheets. The Sampled PAR Inventory sheet(s) should be ordered by PJ and column numbers;
 - o Next should be the Stratification Records for each jurisdiction followed by the PARs for that jurisdiction. Paper clip (**Do Not Staple**) the SRs and PARs;
 - o Sequence the PARs for each PJ by column number in the order they were selected.

GES QUALITY CONTROL AND SUBMISSION INSTRUCTIONS

NOTE: If a jurisdiction was visited more than once you will have more than one set of Stratification Records for that jurisdiction. In this case group all the SRs for that jurisdiction together in order. Then place all the PARs for that jurisdiction together in order beneath them and paper clip them together.

GES Submission Contents

- SPI(s)
- SR(s) Jurisdiction 1
- PAR(s) Jurisdiction 1
(sequence PARs by column number)
- SR(s) Jurisdiction 2
- PAR(s) Jurisdiction 2
(sequence PARs by column number)
-
-
-
- QCC

5. The Sampled PAR Inventory should reflect the contents of the envelope. The entries for each jurisdiction must match the PARs contained in the envelope for that jurisdiction.

Use the jurisdiction names used by NCSA rather than personal abbreviations which can be difficult to recognize.

6. Have a second person look over the Stratification Record and Sampled PAR Inventory sheet to verify its accuracy. Fill out the Quality Control Checklist. It is important that these records leave your office completed correctly.
7. Be sure that the PAR copies are legible. If you cannot read them, then the Zone Center and GES Data Entry and Quality Control Contractor cannot read them.
8. Be sure to label each PAR with the PSU number, slash, PJ number, slash, and column number from the Stratification Record, for example: PSU6/PJ3/C2.

Do's and Don'ts for GES Submissions

1. Do not include anything other than the Sampled PAR Inventory(s), the Stratification Records, the PAR copies, and the Quality Control Checklist.
2. Do not hold packages because one or two PARs are missing. If a PAR is not available at mailing, then you should notify the Zone Center and include a note in the submission.

TABLE 6-1

QUALITY CONTROL CHECKLIST

1. Verify that the sampling procedures were completed correctly.
 - () The line #'s are in sequence.
 - () The correct interval numbers have been used.
 - () The line #'s matching the interval numbers have been highlighted.
2. Verify that the correct PARs have been copied.
 - () Copies of all sampled PARs are present.
 - () All the pages for each sampled PAR have been copied.
 - () There are no nonsampled PARs.
 - () Each PAR has the PSU, PJ, and Column numbers, e.g., PSU3/PJ6/C1, in the upper righthand corner.
3. Verify that the Sampled PAR Inventory is correct.
 - () All header information is complete.
 - () All sampled PARs have been listed.
4. Enclose a copy of this form with each submission to the Zone Center.

PSU # _____

PSU Name _____

Reviewer Name _____

Form QCC:1/94

GES QUALITY CONTROL AND SUBMISSION INSTRUCTIONS

3. If, during your usual collection period, no PARs were sampled, send a message to the Zone Center. Continue to list and sample according to your normal schedule until your next planned mailing date. Assuming by this time you now have at least one sampled PAR, group all relevant materials (accumulated since the last mailing) together and mail to the Zone Center. During most of the year, this would be a rare occurrence. During the first few weeks of the new year, however, listing without sampling any PARs is fairly common.
4. If any item on the quality control checklist is not correct, that item must be corrected prior to sending the submission to the Zone Center. For example, if the line numbers are out of sequence on the SR, they must be corrected and the correct PARs must be sampled.
5. If you are a PSU responsible for an adjacent site, then treat it as a separate site and use its PSU number on all forms related to that PSU. Do not use your CDS PSU number on forms related to the adjacent site.
6. Do not put data for CDS and adjacent sites in the same 10 x 13 inch envelope. If you wish to mail them together, then follow the previous instructions for each site and place the two 10 x 13 inch envelopes inside a larger envelope and mail.
7. **Never send an envelope containing only PARs, without a written explanation.** Sometimes you may realize you have made a mistake after mailing a submission, such as omitting a PAR that should have been included or mailing an incorrect PAR. Then you should mail a separate envelope to the Zone Center including a note specifically describing the contents of the envelope. Be sure to indicate submission number, PSU number, and PJ number.

6.3 Sampled PAR Inventory

The Sampled PAR Inventory (SPI) replaces the package inventory. Table 6-2 is an example of a completed SPI. In addition to the data previously recorded for each sampled PAR, the collector will record the PAR number, PAR date, and PAR time. The PSU number and PSU name are preprinted. The PAR number is usually assigned by the jurisdiction and is not preprinted. However, if only a preprinted number is available, use that as the PAR number. The submission number shall be "1" for each PSU's first submission for 1994 and shall continue in sequence until the last submission for 1994 is made in January 1995. The submission date shall be the date the submission is mailed to the Zone Center. The PAR collectors are to order the entries on the new SPI and order the sampled PARs by PJ and Column numbers.

6.4 Submission Schedule

PSUs are to follow the GES PAR Submission Schedule for submitting sampling materials to the Zone Centers for both their sites and their adjacent sites. Sampling material are to be submitted weekly beginning January 7, 1994 according to the schedule (Table 6-3). Any delays in the schedule should be immediately reported to the Zone Center.

GES QUALITY CONTROL AND SUBMISSION INSTRUCTIONS

TABLE 6-2

**GENERAL ESTIMATES SYSTEM
SAMPLED PAR INVENTORY**

PSU # 99 PSU Name The NCSA Team

Submission # 1 Submission Date 1/12/94

Submission for Collection Period: 1/1/94 To 1/11/94

Line #	Police Jurisdiction (Number and Name)	Column	PAR Number	PAR Date	PAR Time
1	1 - TOTH PD	1	12345	1/3/94	13:00
2	1 - TOTH PD	2	13339	1/12/94	00:30
3	2 - EVANS PD	1	22348	1/6/94	02:00
4	2 - EVANS PD	4	12117	1/10/94	18:00
5	3 - REED COUNTY SHF	3	22999	1/11/94	03:25
6	3 - REED COUNTY SHF	3	22985	1/2/94	13:25
7	3 - REED COUNTY SHF	4	99987	1/7/94	18:30

GES QUALITY CONTROL AND SUBMISSION INSTRUCTIONS

TABLE 6-3

GES PAR Submission Schedule

PARs SAMPLED BY PSU ON OR BEFORE	MUST BE SUBMITTED BY PSU ON OR BEFORE (+0 weeks)	MUST BE REVIEWED & FORWARDED BY ZONE CENTER ON OR BEFORE (+1 weeks)
---	--	---

1994

07-Jan-94	07-Jan-94	14-Jan-94
14-Jan-94	14-Jan-94	21-Jan-94
21-Jan-94	21-Jan-94	28-Jan-94
28-Jan-94	28-Jan-94	04-Feb-94
04-Feb-94	04-Feb-94	11-Feb-94
11-Feb-94	11-Feb-94	18-Feb-94
18-Feb-94	18-Feb-94	25-Feb-94
25-Feb-94	25-Feb-94	04-Mar-94
04-Mar-94	04-Mar-94	11-Mar-94
11-Mar-94	11-Mar-94	18-Mar-94
18-Mar-94	18-Mar-94	25-Mar-94
25-Mar-94	25-Mar-94	01-Apr-94
01-Apr-94	01-Apr-94	08-Apr-94
08-Apr-94	08-Apr-94	15-Apr-94
15-Apr-94	15-Apr-94	22-Apr-94
22-Apr-94	22-Apr-94	29-Apr-94
29-Apr-94	29-Apr-94	06-May-94
06-May-94	06-May-94	13-May-94
13-May-94	13-May-94	20-May-94
20-May-94	20-May-94	27-May-94
27-May-94	27-May-94	03-Jun-94
03-Jun-94	03-Jun-94	10-Jun-94
10-Jun-94	10-Jun-94	17-Jun-94
17-Jun-94	17-Jun-94	24-Jun-94
24-Jun-94	24-Jun-94	01-Jul-94
01-Jul-94	01-Jul-94	08-Jul-94
08-Jul-94	08-Jul-94	15-Jul-94
15-Jul-94	15-Jul-94	22-Jul-94
22-Jul-94	22-Jul-94	29-Jul-94
29-Jul-94	29-Jul-94	05-Aug-94
05-Aug-94	05-Aug-94	12-Aug-94
12-Aug-94	12-Aug-94	19-Aug-94
19-Aug-94	19-Aug-94	26-Aug-94
26-Aug-94	26-Aug-94	02-Sep-94
02-Sep-94	02-Sep-94	09-Sep-94
09-Sep-94	09-Sep-94	16-Sep-94
16-Sep-94	16-Sep-94	23-Sep-94
23-Sep-94	23-Sep-94	30-Sep-94
30-Sep-94	30-Sep-94	07-Oct-94

GES QUALITY CONTROL AND SUBMISSION INSTRUCTIONS

TABLE 6-3 (Cont'd)

GES PAR Submission Schedule

PARs SAMPLED BY PSU ON OR BEFORE	MUST BE SUBMITTED BY PSU ON OR BEFORE (+ 0 weeks)	MUST BE REVIEWED & FORWARDED BY ZONE CENTER ON OR BEFORE (+ 1 weeks)
---	---	--

1994

07-Oct-94	07-Oct-94	14-Oct-94
14-Oct-94	14-Oct-94	21-Oct-94
21-Oct-94	21-Oct-94	28-Oct-94
28-Oct-94	28-Oct-94	04-Nov-94
04-Nov-94	04-Nov-94	11-Nov-94
11-Nov-94	11-Nov-94	18-Nov-94
18-Nov-94	18-Nov-94	25-Nov-94
25-Nov-94	25-Nov-94	02-Dec-94
02-Dec-94	02-Dec-94	09-Dec-94
09-Dec-94	09-Dec-94	16-Dec-94
16-Dec-94	16-Dec-94	23-Dec-94
23-Dec-94	23-Dec-94	30-Dec-94
30-Dec-94	30-Dec-94	06-Jan-95
06-Jan-95	06-Jan-95	13-Jan-95
13-Jan-95	13-Jan-95	20-Jan-95
20-Jan-95	20-Jan-95	27-Jan-95

7.0 CODING INSTRUCTIONS

This section provides the general instructions for collecting and coding the data called for in the field forms. Documentation for each data element includes variable name, element values (attributes), definitions where needed, data sources, collection methodology, reference materials (if needed), and remarks.



CASE SUMMARY

PSU _____ CASE NO. _____ TYPE OF ACCIDENT _____

A. DESCRIPTION OF THE ACCIDENT SEQUENCE AND ACCIDENT PECULIARITIES

(Provide a summary of the accident sequence as well as any particular event of the accident that is noteworthy. Injury mechanism and vehicle crashworthiness is the focus, not driver culpability. Do not include any personal identifiers.)

B. VEHICLE PROFILE(S)

Vehicle No.	Class of Vehicle	Year/Make/Model	Most Severe Damage Based on Vehicle Inspection		Component Failure
			Damage Plane	Severity Description	

DO NOT SANITIZE THIS FORM

C. PERSON PROFILE(S)

Vehicle No.	Person Role	Seat Position	Restraint Use	Most Severe Injury (TO BE COMPLETED BY ZONE CENTER)			
				Body Region	Injury Type	AIS	Injury Source

Body Region

Abdomen
 Ankle-foot
 Arm (upper)
 Back-thoracolumbar spine
 Brain
 Chest
 Ears
 Eye
 Elbow
 Face
 Forearm
 Head-skull
 Heart
 Kidneys
 Knee
 Leg (lower)
 Liver
 Lower limbs(s) (whole or unknown part)
 Mouth
 Neck-cervical spine
 Nose

Pelvic-hip

Pulmonary-lungs
 Shoulder
 Spleen
 Thigh
 Thyroid, other endocrine gland
 Upper limb(s) (whole or unknown part)
 Vertebrae
 Whole body
 Wrist-hand

Injury Type

Abrasion
 Amputation
 Avulsion
 Burn
 Concussion
 Contusion
 Crush
 Detachment, separation
 Dislocation

Fracture

Fracture and dislocation
 Laceration
 Other
 Perforation, puncture
 Rupture
 Sprain
 Strain
 Total severance, transection
 Unknown

Abbreviated Injury Scale

- (1) Minor injury
- (2) Moderate injury
- (3) Serious injury
- (4) Severe injury
- (5) Critical injury
- (6) Maximum (untreatable)
- (7) Injured, unknown severity

DO NOT SANITIZE THIS FORM

CASE SUMMARY FORM

The Case Summary Form is a noncoded description of the vehicle(s) and person(s) involved in the accident. Further, the accident sequence and case peculiarities (vehicle or environmental) are noted. The form is divided into four sections:

Identification

- A. Description of the Accident Sequence and Accident Peculiarities
- B. Vehicle Profiles
- C. Person Profiles

Through this form, the researcher is able to provide the zone center, a clinical user, or any other person interested in the NASS CDS case a quick reference of accident particulars. The form should be typed. However, legible hand written print is acceptable. The form must be neat and legible. Subsection A, Description of the Accident Sequence and Accident Peculiarities, must be double spaced, if typed. No coded values (except where indicated below) should be used. The form provides a non-jargon account of the accident.

IDENTIFICATION:

The header items are used to identify the PSU and case number. In addition, a general description of the accident type is provided. This section contains the following variables.

PSU: Indicate the appropriate PSU number.

Case No.: Indicate the case number and stratum for which the Case Summary Form is being completed.

Type of Accident: Provide a general description of the accident configuration in terms common to the traffic safety community. The pattern to be used is as follows: **vehicle / vehicle - configuration**. Appropriate vehicle and configuration terms are listed below; however, additional terms can be used if warranted.

<u>Vehicle</u>	<u>Configuration</u>
car	ran-off-road
light truck	rollover on road
light van	rollover off road
straight truck	head-on
step van	obtuse angle
semi-tractor	right angle
tractor-trailer	acute angle
motorcycle	rear-end
bicycle	sideswipe opposing direction
train	sideswipe same direction
pedestrian	object on road
nonmotorist	non-impact
animal	
parked _____	
abandoned _____	
stalled _____	

Some examples of the Type of Accident pattern desired are as follows:

car - ran-off-road
 car/car - right angle
 car/light truck - head-on
 car/parked car - rear-end
 light van/motorcycle - obtuse angle
 car/train - right angle
 car/tractor-trailer - acute angle
 light truck - object on-road
 light truck - rollover off-road

Researchers should attempt to make the best possible fit of the existing responses. However, additional responses may be more appropriate.

A. DESCRIPTION OF THE ACCIDENT SEQUENCE AND ACCIDENT PECULIARITIES

This part of the summary should provide a brief synopsis of the accident sequence as reconstructed by the researcher. Do not identify vehicle/driver culpability. For example, suppose vehicle #1 ran a stop sign and struck vehicle #2 in its left side. This situation should be described as follows:

Vehicle #1 was traveling north and vehicle #2 was traveling east on an intersecting roadway. The front of vehicle #1 impacted the left side of vehicle #2.

Thus, the impact configuration is emphasized rather than who was at fault. Any particulars concerning vehicle crashworthiness should be highlighted. Include any abnormal accident occurrences that may be of interest to quality control or the data user. Make sure personal identifiers are not used (i.e., highway/road/street names or names of persons).

B. VEHICLE PROFILES

All vehicles involved in the NASS CDS case should be documented in this section. This section contains the following variables.

Vehicle No.: See variable GV03.

Class of Vehicle: See variable AC14. Note that the written attribute (e.g., Compact", "Pickup truck", etc.) should be used, not the code.

Year/Make/Model: See variables GV04-GV06. Provide the actual vehicle year, make, and model for each vehicle involved in the NASS CDS accident (e.g., '87/Ford/Mustang). Do not use coded values.

Most Severe Damage: Document the following for the accident impact which caused the most damage to the vehicle.

- o Damage Plane - The plane first crossed in the impact (i.e., Front, Left, Right, Back, Top, or Undercarriage).
- o Severity Description - A gross indication of the damage severity. The terms light, moderate, or severe are adequate.

Component Failure: Any vehicular component that failed during the accident sequence should be noted. The components of special interest to the user may be noted by reviewing the field form variables (e.g., steering columns, seat backs, restraints, glazing, etc.). Refer to the "Problem Safety Bulletin", section 4.5, table 4-2, for an additional listing of component failures.

C. PERSON PROFILES

All persons involved in the NASS CDS case for whom an Occupant Assessment form was submitted should be noted in this section. This section contains the following variables.

Vehicle No: See variable GV03.

Person Role: Indicate if the person was the driver or a passenger in the vehicle. Write "driver" or "passenger"; do not use their coded values.

Seat Position: See variable OA10. Note that codes should not be used; instead, write "front left", "second middle", etc.

Restraint Use: Indicate the type of restraint "used" by the person (i.e., lap, lap & shoulder, air bag, passive belt, child restraint, combination).

Most Severe Injury (To Be Completed By Zone Center): The most severe (i.e., highest AIS) injury to the person should be documented by noting the injury's **Body Region, Injury Type, AIS, and Injury Source**--see variables OI05-OI12. Use the coded value only for AIS. If more than one injury has the highest AIS, choose one with the highest order source of data (i.e., autopsy over post-ER, post-ER over ER, etc.). If the person did not sustain an injury, write "not injured".



ACCIDENT FORM

1. Primary Sampling Unit Number _____
2. Case Number - Stratum _____

IDENTIFICATION

3. Number of General Vehicle Forms Submitted _____
4. Date of Accident (Month, Day, Year) _____ / _____ / **9 4**
5. Time of Accident _____
Code reported military time of accident.
NOTE: Midnight = 2400
Unknown = 9999

SPECIAL STUDIES - INDICATORS

Check (✓) each special study (SS14-SS18 below) that has been completed; code 1 for the checked special studies and 0 for the special studies not checked.

6. ___ SS15 Administrative Use _____
7. ___ SS16 Pedestrian Crash Data Study _____
8. ___ SS17 Impact Fires _____
9. ___ SS18 _____
10. ___ SS19 _____

NUMBER OF EVENTS

11. Number of Recorded Events in This Accident _____
Code the number of events which occurred in this accident.

ACCIDENT EVENTS

For each event that occurred in the accident, code the lowest numbered vehicle in the left columns and the other involved vehicle or object on the right.

Accident Event Sequence Number	Vehicle Number	Class Of Vehicle	General Area of Damage	Vehicle Number or Object Contacted	Class Of Vehicle	General Area of Damage
12. <u>0 1</u>	13. _____	14. _____	15. _____	16. _____	17. _____	18. _____
19. <u>0 2</u>	20. _____	21. _____	22. _____	23. _____	24. _____	25. _____
26. <u>0 3</u>	27. _____	28. _____	29. _____	30. _____	31. _____	32. _____
33. <u>0 4</u>	34. _____	35. _____	36. _____	37. _____	38. _____	39. _____
40. <u>0 5</u>	41. _____	42. _____	43. _____	44. _____	45. _____	46. _____

IF GREATER THAN FIVE EVENTS, CONTINUE CODING ON THE ACCIDENT EVENT SUPPLEMENT

CODES FOR CLASS OF VEHICLE

- (00) Not a motor vehicle
- (01) Subcompact/mini (wheelbase < 254 cm)
- (02) Compact (wheelbase ≥ 254 but < 265 cm)
- (03) Intermediate (wheelbase ≥ 265 but < 278 cm)
- (04) Full size (wheelbase ≥ 278 but < 291 cm)
- (05) Largest (wheelbase ≥ 291 cm)
- (09) Unknown passenger car size
- (11) Compact utility vehicle
- (12) Large utility vehicle (≤ 4,500 kgs GVWR)
- (13) Passenger van (≤ 4,500 kgs GVWR)
- (14) Other van (≤ 4,500 kgs GVWR)
- (15) Pickup truck (≤ 4,500 kgs GVWR)
- (18) Other truck (≤ 4,500 kgs GVWR)
- (19) Unknown light truck type
- (20) School bus
- (21) Other bus
- (22) Truck (> 4,500 kgs GVWR)
- (23) Tractor without trailer
- (24) Tractor-trailer(s)
- (25) Motored cycle
- (28) Other vehicle
- (99) Unknown

CODES FOR GENERAL AREA OF DAMAGE (GAD)

CDS APPLICABLE AND OTHER VEHICLES

- (O) Not a motor vehicle
- (N) Noncollision
- (F) Front
- (R) Right side
- (L) Left side
- (B) Back
- (T) Top
- (U) Undercarriage
- (9) Unknown

TDC APPLICABLE VEHICLES

- (O) Not a motor vehicle
- (N) Noncollision
- (F) Front
- (R) Right side
- (L) Left side
- (B) Back of unit with cargo area (rear of trailer or straight truck)
- (D) Back (rear of tractor)
- (C) Rear of cab
- (V) Front of cargo area
- (T) Top
- (U) Undercarriage
- (9) Unknown

CODES FOR VEHICLE NUMBER OR OBJECT CONTACTED

(01-30) – Vehicle Number

Noncollision

- (31) Overturn – rollover
- (32) Fire or explosion
- (33) Jackknife
- (34) Other intraunit damage (specify): _____
- (35) Noncollision injury
- (38) Other noncollision (specify): _____
- (39) Noncollision – details unknown

Collision With Fixed Object

- (41) Tree (≤ 10 cm in diameter)
- (42) Tree (> 10 cm in diameter)
- (43) Shrubbery or bush
- (44) Embankment
- (45) Breakaway pole or post (any diameter)

Nonbreakaway Pole or Post

- (50) Pole or post (≤ 10 cm in diameter)
- (51) Pole or post (> 10 cm but ≤ 30 cm in diameter)
- (52) Pole or post (> 30 cm in diameter)
- (53) Pole or post (diameter unknown)
- (54) Concrete traffic barrier
- (55) Impact attenuator
- (56) Other traffic barrier (includes guardrail) (specify): _____

- (57) Fence
- (58) Wall
- (59) Building
- (60) Ditch or culvert
- (61) Ground
- (62) Fire hydrant
- (63) Curb
- (64) Bridge
- (68) Other fixed object (specify): _____
- (69) Unknown fixed object

Collision with Nonfixed Object

- (71) Motor vehicle not in-transport
- (72) Pedestrian
- (73) Cyclist or cycle
- (74) Other nonmotorist or conveyance
- (75) Vehicle occupant
- (76) Animal
- (77) Train
- (78) Trailer, disconnected in transport
- (79) Object fell from vehicle in-transport
- (88) Other nonfixed object (specify): _____
- (89) Unknown nonfixed object
- (98) Other event (specify): _____
- (99) Unknown event or object



ACCIDENT LOG

TO BE COMPLETED BY TEAM	DATA STATUS OF VARIABLE NUMBERS 1-81
1. PSU Number _____	1 2 3 4 5 6 7 8 9 10 11
2. Case Number—Stratum _____	[] [] [] [] [] [] [] [] [] [] []
3. Assigned Researcher Number _____	12 13 14 15 16 17 18
4. PSU Reviewer Number _____	[] [] [] [] [] [] [] []
5. Sample Date ____/____/____	19 20 21 22 23 24 25
6. Date Scene Field Work Completed ____/____/____	[] [] [] [] [] [] [] []
7. Number of Scene Slides _____	26 27 28 29 30 31 32
TO BE COMPLETED BY ZONE CENTER	
8. Type of Scene Inspection _____ (1) No physical evidence (2) Drive by (photos only) (3) Physical evidence present	[] [] [] [] [] [] [] []
9. Field Documentation Of Physical Plant _____ (0) Not applicable (1) Substandard - beyond researcher control (2) Substandard (3) Standard	33 34 35 36 37 38 39
10. Field Documentation Of Physical Evidence _____ (0) Not applicable (1) Substandard - beyond researcher control (2) Substandard (3) Standard	[] [] [] [] [] [] [] []
11. Quality Of Scene Diagram _____ (0) Not applicable (1) Substandard - beyond researcher control (2) Substandard (3) Standard	40 41 42 43 44 45 46
12. Scene Slides Subject Quality _____ (0) Not applicable (1) Substandard - beyond researcher control (2) Substandard (3) Standard	[] [] [] [] [] [] [] []
13. Scene Slides Quality _____ (0) Not applicable (1) Substandard - beyond researcher control (2) Substandard (3) Standard	47 48 49 50 51 52 53
14. Number Of Researcher Coded Events _____	[] [] [] [] [] [] [] []
15. Number Of Events Added By Zone Center _____	54 55 56 57 58 59 60
16. Number Of Events Deleted By Zone Center _____	[] [] [] [] [] [] [] []
17. Correct Stratum Character _____	61 62 63 64 65 66 67
18. Stratum Checked By (Initials) _____	[] [] [] [] [] [] [] []
	68 69 70 71 72 73 74
	[] [] [] [] [] [] [] []
	75 76 77 78 79 80 81
	[] [] [] [] [] [] [] []
	<p>Data Status Codes:</p> <ul style="list-style-type: none"> (Blank) Correct (1) Derived error (2) Non-correctable error (3) Correctable error (4) Change—no error (5) Sequencing error (7) Incorrect edit override (8) MDE error (9) Unknown coded

ACCIDENT EVENTS SUPPLEMENT

1. Primary Sampling Unit Number _____

2. Case Number—Stratum _____

Accident Event Sequence Number	Vehicle Number	Class Of Vehicle	General Area of Damage	Vehicle Number or Object Contacted	Class Of Vehicle	General Area of Damage
47. <u>0</u> <u>6</u>	48. _____	49. _____	50. _____	51. _____	52. _____	53. _____
54. <u>0</u> <u>7</u>	55. _____	56. _____	57. _____	58. _____	59. _____	60. _____
61. <u>0</u> <u>8</u>	62. _____	63. _____	64. _____	65. _____	66. _____	67. _____
68. <u>0</u> <u>9</u>	69. _____	70. _____	71. _____	72. _____	73. _____	74. _____
75. <u>1</u> <u>0</u>	76. _____	77. _____	78. _____	79. _____	80. _____	81. _____
82. <u>1</u> <u>1</u>	83. _____	84. _____	85. _____	86. _____	87. _____	88. _____
89. <u>1</u> <u>2</u>	90. _____	91. _____	92. _____	93. _____	94. _____	95. _____
96. <u>1</u> <u>3</u>	97. _____	98. _____	99. _____	100. _____	101. _____	102. _____
103. <u>1</u> <u>4</u>	104. _____	105. _____	106. _____	107. _____	108. _____	109. _____
110. <u>1</u> <u>5</u>	111. _____	112. _____	113. _____	114. _____	115. _____	116. _____
117. <u>1</u> <u>6</u>	118. _____	119. _____	120. _____	121. _____	122. _____	123. _____
124. <u>1</u> <u>7</u>	125. _____	126. _____	127. _____	128. _____	129. _____	130. _____
131. <u>1</u> <u>8</u>	132. _____	133. _____	134. _____	135. _____	136. _____	137. _____
138. <u>1</u> <u>9</u>	139. _____	140. _____	141. _____	142. _____	143. _____	144. _____
145. <u>2</u> <u>0</u>	146. _____	147. _____	148. _____	149. _____	150. _____	151. _____



ACCIDENT COLLISION MEASUREMENT TABLE

Primary Sampling Unit Number _____

Case Number – Stratum _____

ACCIDENT COLLISION DIAGRAM		CRASH DATA																				
<p style="text-align: center;">LEVEL I PHYSICAL EVIDENCE ABSENT</p> <p>To be accomplished when there is no physical evidence present at the scene:</p> <ul style="list-style-type: none"> • approximate vehicle orientation at impact and final rest • applicable road/roadway delineation (e.g., curbs/edge lines, lane markings, median markings, pavement markings, etc.) • applicable traffic controls (e.g., speed limit) • north arrow placed on diagram • sketch required 	<p style="text-align: center;">LEVEL II (Cont'd) physical evidence is present:</p> <ul style="list-style-type: none"> • document reference point and reference line relative to physical features present at the scene • scaled documentation of all accident induced physical evidence • scaled documentation of all roadside objects contacted • roadway surface type and condition of applicable roadways • grade measurements for all applicable roadways and at location of rollover initiation • scaled representations of the vehicle(s) at pre-impact, impact, and final rest based upon either: <ul style="list-style-type: none"> a) physical evidence, or b) reconstructed accident dynamics 																					
<p style="text-align: center;">LEVEL II PHYSICAL EVIDENCE PRESENT</p> <p>In addition to the level I tasks noted above, the following must be accomplished when</p>			<table style="width: 100%; border-collapse: collapse;"> <thead> <tr> <th style="text-align: center;">VEH. #1</th> <th style="text-align: center;">VEH #2</th> <th style="text-align: center;">VEH #3</th> </tr> </thead> <tbody> <tr> <td style="text-align: center;">Heading Angle</td> <td style="text-align: center;">_____</td> <td style="text-align: center;">_____</td> </tr> <tr> <td style="text-align: center;">Surface Type</td> <td style="text-align: center;">_____</td> <td style="text-align: center;">_____</td> </tr> <tr> <td style="text-align: center;">Surface Condition</td> <td style="text-align: center;">_____</td> <td style="text-align: center;">_____</td> </tr> <tr> <td style="text-align: center;">Grade (v/h) Measurement (between impact and final rest)</td> <td style="text-align: center;">_____</td> <td style="text-align: center;">_____</td> </tr> <tr> <td style="text-align: center;">Grade (v/h) Measurement (at location of rollover initiation)</td> <td style="text-align: center;">_____</td> <td style="text-align: center;">_____</td> </tr> </tbody> </table>	VEH. #1	VEH #2	VEH #3	Heading Angle	_____	_____	Surface Type	_____	_____	Surface Condition	_____	_____	Grade (v/h) Measurement (between impact and final rest)	_____	_____	Grade (v/h) Measurement (at location of rollover initiation)	_____	_____	
VEH. #1	VEH #2	VEH #3																				
Heading Angle	_____	_____																				
Surface Type	_____	_____																				
Surface Condition	_____	_____																				
Grade (v/h) Measurement (between impact and final rest)	_____	_____																				
Grade (v/h) Measurement (at location of rollover initiation)	_____	_____																				

Reference Point: _____

Reference line: _____

Item	Distance and Direction from Reference Point	Distance and Direction from Reference Line



U.S. Department of Transportation
National Highway Traffic Safety
Administration

ACCIDENT COLLISION DIAGRAM

NATIONAL ACCIDENT SAMPLING SYSTEM
CRASHWORTHINESS DATA SYSTEM

PSU No. _____ Case Number—Stratum _____

Indicate
North

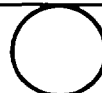



SLIDE INDEX

Primary Sampling Unit Number _____

Case Number - Stratum _____

Slide No.	Vehicle No.	Direction of Picture	Description of Slide Subject Matter

PRIMARY SAMPLING UNIT (PSU) CODES AND DESCRIPTION

<u>VALUES</u>	<u>STRATA</u>	<u>DESCRIPTION</u>
03,06,41,49, 72,74,79,82	1	Central City, one of the 60 largest SMSAs
05,08,09,12, 45,73,75,81	2	Suburban, one of the 17 - 60th SMSAs or PSU within 61st - 119th largest SMSAs either containing or not containing a central city
02,04,11,13, 43,48,76,78	3	Other PSU

Variable Name: Case Number - Stratum

Element Values:

Range: Case Number--001 through 500
CDS Sampling Stratum--A, B, C, D, E, F, G, H, J, K

Source: Assigned by Automated Case Selection System

Remarks:

The Case Number - Stratum is assigned by the Automated Case Selection System and is composed of two parts: the first three digits are a number ranging from 001 to 500; the last digit is the letter identifying from which CDS sampling stratum the case was selected (A, B, C, D, E, F, G, H, J, K).

Except as noted below, no numbers will be skipped. If a case must be dropped, the number will not be reused.

Refer to section 2.2 of this manual for CDS stratification and case selection procedures. For GES stratification (strata X, Y, and Z) refer to section 2.2.2 of this manual.

Cases sampled within the NASS CDS sampling frame are numbered 001-500. Cases selected outside of the NASS CDS sampling frame as part of a special study data collection effort are numbered 501-699.

Variable Name: Number of General Vehicle Forms Submitted

Element Values:

Range: 01 through 30

Source: Researcher determined--inputs include police report, scene inspection, and interviews.

Remarks:

Each accident must have at least one General Vehicle Form submitted. The value recorded must equal the total number of General Vehicle Forms present in the case.

This variable is a file structuring variable.

A General Vehicle Form must be submitted for each in-transport motor vehicle involved in the accident. For example, one CDS applicable vehicle is towing another by a nonfixed linkage (e.g., rope, chain, etc.). Assuming both vehicles are involved in the accident, a form is required for both vehicles. If the linkage was fixed (see GV03, Vehicle Number, for a definition of "fixed linkage"), only the power unit would be considered in-transport and only one form required.

Hit-and-run accidents occasionally cause some confusion on this variable. A General Vehicle Form is filled out for each in-transport motor vehicle involved in the accident independent of the amount of information collected on the vehicles by the police. Parked vehicles may or may not require a form depending on whether or not they were in-transport. A thorough discussion of the sampling protocol for NASS is found in section 2.0 of the Introduction (pages 5 through 45).

Variable Name: Date of Accident (Month, Day, Year)

Element Values:

Month

01	January	07	July
02	February	08	August
03	March	09	September
04	April	10	October
05	May	11	November
06	June	12	December

Day

Range: 01 through 31

Year

94 1994 (precoded value)

Source: Police Report.

Remarks:

If the PAR indicates (usually a hit-and-run) that the accident occurred between some p.m. and a.m. time (e.g., 8:00 p.m. and 6:00 a.m.) on either a preceding or following day, code the accident as occurring on the following day. If a range of days is indicated (e.g., between Sunday and Friday), code the last date of the range (e.g., Friday).

If the month and year of accident occurrence is unknown, code the contact date's month, day, and year.

Variable Name: Time of Accident

Element Values:

Code reported military time of accident.

For example: 1200 - Noon

2400 - Midnight

9999 Unknown

Source: Police report.

Remarks:

Code to the nearest minute (e.g., 10:19 p.m. = 2219 hours). The time coded is taken from the "accident time" block on the PAR (usually at the top of the first page). If this block is left blank, then "9999" (Unknown) is coded.

If the block is coded "midnight" (i.e., 12:00 a.m., 0000, or 2400) a determination must be made for sampling purposes as to whether the police consider this accident to be the first or last accident on the date indicated on the PAR. Because of variability among police jurisdictions in how they handle midnight, researchers must look at the PAR date, day-of-week, and PAR number (if available) or question police personnel and make a determination regarding whether the particular jurisdiction considers the accident being sampled to be the first or last accident on the date indicated on the PAR. Technically, midnight (i.e., 12:00 a.m.) begins a new day, but not all jurisdictions treat midnight as such. If the jurisdiction considers the accident as the last (or one of the last) on the "date" indicated, code this variable as "2400" (Midnight); however, if the jurisdiction considers the accident as the first (or one of the first) on the "date" indicated, code this variable as "0001". Code "0000" is not allowed! Thus, 12:00 a.m. (0000, 2400) can be coded either "2400" or "0001" depending on how the particular jurisdiction handles midnight.

If the PAR indicates the accident occurred during some time interval of greater than one hour (e.g., 8:00 p.m. to 6:00 a.m., or 8:00 a.m. to 5:00 p.m.), code "9999" (Unknown). However, if the interval was one hour or less, code the midpoint of the interval (e.g., 8:00 p.m. to 9:00 p.m., code "2030").

AC06
 AC07
 AC08
 AC09
 AC10

Variable Name: SS15 - Trauma Studies (Administrative Use)
 SS16 - Pedestrian Crash Data Study
 SS17 - Impact Fires
 SS18 - Not used
 SS19 - Not used

Element Values:

0 No
 1 Yes

Source: Special study procedures.

Remarks:

Code "0" (No) means there is no special study form included in the case.

Code "1" (Yes) means there is a special study form included in the case.

Definition of SS15 [Trauma Studies (Administrative Use)]

To be used by the NASS CDS Data Base Administrator in case automation functions.

Definition of SS16 (Pedestrian Crash Data Study)

- Criteria for Case Selection
 Crashes involving NASS CDS applicable late model year vehicles that contact a pedestrian(s). The vehicle must be moving in a forward direction at the time of the crash. These accidents are to be investigated on-scene and entered into the MDE system as NASS special study cases. After automated data entry, these cases are to be forwarded to the Zone Center with your regular case submission.
- Case meeting pedestrian study criteria and sampled at the following FSUs
 06 Philadelphia, Pennsylvania
 41 Ft. Lauderdale and Hollywood, Florida
 49 Dallas, Texas
 72 Chicago, Illinois
 79 Los Angeles (City), California
 82 Seattle, Washington
- Case numbers shall be from 601-699

AC06
AC07
AC08
AC09
AC10
(2)

Variable Name: Special Studies - Indicators

Definition of SS17 (Impact Fires)

- Impact Fire cases selected within the CDS case sample
NASS CDS accidents involving a vehicle fire which resulted from an impact with another vehicle or object and the accidents are selected by the automated case selection system (ACSS) as regular CDS cases. These accidents are to be investigated and entered into the MDE system as normal.
- Impact Fires selected as a special study case (outside of the CDS sample)
NASS CDS accidents involving a vehicle fire which resulted from an impact with another vehicle or object and the accidents are listed but not selected as part of the CDS case sample. These accidents are to be investigated and entered into the MDE as NASS special study cases. After automated data entry, these cases are to be forwarded to the Zone Center with your regular case submission.
- Case numbers shall be from 501-599

Variable Name: Number of Recorded Events in This Accident

Element Values:

Range: 01-98

Code the number of (qualifying) events which occurred in this accident.

Source: Researcher determined based on police report, scene investigation, and interviews

Remarks:

This variable is a file structuring variable.

Not all events are coded; code only "qualifying" events. A qualifying event is an "event" that involves at least one in-transport motor vehicle. The in-transport vehicle can be either CDS applicable or non-CDS applicable. If the in-transport vehicle is a CDS applicable vehicle, then it can be either a towed or a nontowed in-transport vehicle. Any event in the accident that does not involve an in-transport motor vehicle is to be dropped from the sequence and not reported on the NASS CDS forms. A further discussion concerning "events" and those which qualify follows in the Accident Events Overview.

Unknown is not a valid code for this variable. Researchers must determine the number of qualifying events.

ACCIDENT EVENTS OVERVIEW

An "accident" is the total set of "events" (one or more) that results from an unstabilized situation such that at least one harmful event occurs not directly resulting from a cataclysm. The "accident" is concluded in time when all events which originated from the unstabilized situation have stabilized.

An accident is considered applicable to the NASS CDS if one of its events resulted in harm (except for nonqualifying noncollision events; see Section 2.2.1, page 31--seventh paragraph) and that event involved an in-transport CDS applicable vehicle which was reported on a police report as being towed from the scene of the accident due to damage.

Harm can be either an impact or a noncollision event. An impact is defined as any vehicle to vehicle or vehicle to object (fixed or nonfixed, stationary or nonstationary) contact which may or may not result in vehicle damage. Noncollision events such as fire/explosion, occupant fell from vehicle, occupant injury without vehicle impact, etc., are also included in these variables unless this noncollision event is the only event in the accident.

The NASS CDS is only interested in those events that involve in-transport motor vehicles. The motor vehicle can be a: towed CDS applicable vehicle, nontowed CDS applicable vehicle, or a non-CDS applicable vehicle. Events that involve only not in-transport motor vehicles and/or pedestrians and/or non-motorists are not considered; they are dropped by the researcher from the accident sequence. Below are some examples of nonqualifying events.

- o Not in-transport vehicle (e.g., parked vehicle) impacts pedestrian, pedalcyclist, or other nonmotorist
- o Not in-transport vehicle impacts an object (fixed or nonfixed)
- o Not in-transport vehicle impacts another not in-transport vehicle
- o Pedestrian (pedalcyclist, other nonmotorist) impacts an object
- o Pedestrian (pedalcyclist, other nonmotorist) impacts another not in-transport vehicle
- o Pedestrian, pedalcyclist, or other nonmotorist inter-impact.

The accident events variables are designed to provide a coded description of all qualifying events which occurred in the accident sequence. Events are encoded in chronological sequence. Two groups of variables are provided for each event. The first (or left) group always describes the in-transport motor vehicle with the lowest vehicle number in the event. The second group describes either the other in-transport vehicle or the object involved in the event with the in-transport motor vehicle described by the left group.

Beginning mid-year 1993, and applied retroactively to the beginning of the 1993 data collection year, all "fire-related" events were recorded as separate accidents events. Previously, most fires that resulted after a vehicle sustained an impact and before the vehicle was removed from the scene were considered as

ACCIDENT EVENTS OVERVIEW

part of an impact event and not coded separately in the Accident Events section. Because of the potential harm that a "fire" creates, each fire event is now coded separately.

With this coded chronological sequence of qualified accident events on the CDS database, analysts can review the entire series of events involving in-transport motor vehicles. Various areas of concern to the highway safety community will be easily assessed using these variables. For instance, the injury severity in accidents can be assessed relative to the number and type of impacts involved.

Likewise, certain collision configurations may create a greater hazardous condition for the occupants. A possible area of analysis would be the mix of vehicle sizes or the types of objects the different classes of vehicles impact.

Complete these variables based upon an accurate and complete reconstruction of the vehicular dynamics involved in the accident. All of the injury or damage producing qualifying events or circumstances for the in-transport motor vehicle(s) are coded.

An example of a properly coded accident sequence follows for the accident described below.

Vehicle 1 (a compact passenger car) went out of control on a wet roadway and struck a median guardrail with its front. The vehicle was redirected by the guardrail and reentered the roadway, where it struck vehicle 2 (a pickup truck) in the left side with its front. Vehicle 1 spun to a stop in the roadway, and the driver, due to the spinning, hit his head on the door pillar breaking his neck. Vehicle 2, out-of-control, ran off the roadway and struck a pedestrian with its front.

Accident Event Sequence Number	Vehicle Number	Class of Vehicle	General Area of Damage	Vehicle Number or Object Contacted	Class of Vehicle	General Area of Damage
12. 0 1	13. 0 1	14. 0 2	15. F	16. 5 6	17. 0 0	18. 0
19. 0 2	20. 0 1	21. 0 2	22. F	23. 0 2	24. 1 5	25. L
26. 0 3	27. 0 2	28. 1 5	29. F	30. 7 2	31. 0 0	32. 0
33. _ _	34. _ _	35. _ _	36. _	37. _ _	38. _ _	39. _

Note, for the driver of vehicle 1, breaking his neck is not a separate codeable event. Rather, this injury, and almost all occupant injuries resulting from occupant interior contact, is a result of a collision event.

Variable Name: Accident Event Sequence Number
(1st through 5th or higher)

Element Values:

Range: 01-98--precoded values: 01 through 05

Source: Researcher Determined

Remarks:

This variable is precoded for events "01" through "05". If more than 5 events are involved, use the Accident Events Supplement.

The codes are for the chronological sequence of events in the accident.

Variable Name: Vehicle Number
(1st through 5th or higher)

Element Values:

Range: 01 through 30

Source: Police Accident Report

Remarks:

Code assigned number. See variable GV03, Vehicle Number, for definitions of the attributes and coding conventions.

Variable Name: Class of Vehicle--1st
(1st through 5th or higher)

Element Values:

- 01 Subcompact/mini (wheelbase < 254 cm)
- 02 Compact (wheelbase ≥ 254 but < 265 cm)
- 03 Intermediate (wheelbase ≥ 265 but < 278 cm)
- 04 Full size (wheelbase ≥ 278 but < 291 cm)
- 05 Largest (wheelbase ≥ 291 cm)
- 09 Unknown passenger car size
- 11 Compact utility vehicle
- 12 Large utility vehicle (≤ 4,500 kgs GVWR)
- 13 Passenger van (≤ 4,500 kgs GVWR)
- 14 Other van (≤ 4,500 kgs GVWR)
- 15 Pickup truck (≤ 4,500 kgs GVWR)
- 18 Other truck (≤ 4,500 kgs GVWR)
- 19 Unknown light truck type
- 20 School bus
- 21 Other bus
- 22 Truck (> 4,500 kgs GVWR)
- 23 Tractor without trailer
- 24 Tractor-trailer(s)
- 25 Motored cycle
- 28 Other vehicle
- 99 Unknown

Source: Researcher determined--inputs include police report, vehicle inspection, VIN breakdown, and interviews.

Remarks:

The Passenger Car Classification Subcommittee, A3B11(1), of the Transportation Research Board, Traffic Records and Accident Analysis Committee, A3B11, assesses size based on the vehicle wheelbase. The guidelines for this classification can be found in the report entitled Recommended Definitions for Passenger Car Size Classification by Wheelbase and Weight, August 1984 by the previously mentioned subcommittee.

Codes "01" through "05" rely on the guidelines for wheelbase alone. If one of these codes is used, then the vehicle's Body Type, GV07, must be coded as an automobile (codes "01"-"09") or automobile derivative (codes "10"-"13").

Code "09" (Unknown passenger car size) is used when it is known that a vehicle is a passenger car (codes "01" through "05"), but the wheelbase is unknown (i.e., Original Wheelbase, EV28, equals "999").

Code "11" (Compact utility vehicle) refers to vehicles defined in code "14" (Compact utility) in variable GV07, Body Type. Use this code if the size of the utility vehicle is unknown.

Variable Name: Class of Vehicle--1st (Cont'd.)
(1st through 5th or higher)

- Code "12" [Large utility vehicle ($\leq 4,500$ kgs GVWR)] refers to vehicles defined in codes "15" (Large utility) and "16" (Utility station wagon) in variable GV07, Body Type.
- Code "13" [Passenger van ($\leq 4,500$ kgs GVWR)] includes all vehicle types defined in codes "20" (Minivan) and "21" (Large van) and "29" (Unknown van type) in variable GV07, Body Type, and designed with seats installed for passengers in excess of two seat positions. Also included are codes "24" (Van based school bus) and "25" (Van based other bus). Cargo vans are recorded in code "14".
- Code "14" [Other van ($\leq 4,500$ kgs GVWR)] includes all vehicles as described in variable GV07, Body Type, codes "22" (Step van or walk-in van), "23" (Van based motorhome), and "28" (Other van type) not fitting into the definition of code "13" above. This code also includes vehicles described in variable GV07, Body Type, codes "20" (Minivan) and "21" (Large van) which are designed as cargo vans.
- Code "15" [Pickup truck ($\leq 4,500$ kgs GVWR)] is defined in variable GV07, Body Type, codes "30", "31", "32", "33" and "39".
- Code "18" [Other truck ($\leq 4,500$ kgs GVWR)] is defined in codes "40", "41", "42", and "45" in variable GV07, Body Type.
- Code "19" (Unknown light truck type) is defined in code "48" [Unknown other light truck type (not a pickup)] in variable GV07, Body Type.
- Code "20" (School bus) refers to those vehicles described by code "50" (School bus) in variable GV07, Body Type.
- Code "21" (Other bus) describes those vehicles included in codes "58" and "59" in variable GV07, Body Type.
- Code "22" [Truck ($>4,500$ kgs GVWR) is defined in variable GV07, Body Type, as codes "60" through "65", "78" and "79".
- Code "23" (Tractor without trailer) refers to code "67" (Truck-tractor with no cargo trailer) in variable GV07, Body Type.
- Code "24" (Tractor-trailer(s)) is defined in codes "68", "69", and "70" in variable GV07, Body Type.
- Code "25" (Motored cycle) refers to GV07, Body Type, codes "80" through "89".
- Code "28" (Other vehicle) refers to all vehicles described by codes "90", "91", "92", "93", or "97" in variable GV07, Body Type.

Variable Name: Class of Vehicle--1st (Cont'd.)
(1st through 5th or higher)

Code "99" (Unknown) is used when there is a lack of information regarding the type of vehicle. This lack of information prohibits the accurate classification of this vehicle using one of the preceding codes. This code is equivalent to Body Type, GV07, codes "49" [Unknown light vehicle type (automobile, utility van, or light truck)] or "99" (Unknown body type).

Variable Name: General Area of Damage--1st
(1st through 5th or higher)

Element Values:

N Noncollision
9 Unknown

CDC Applicable and Other Vehicles

F Front
R Right side
L Left side
B Back
T Top
U Undercarriage

TDC Applicable Vehicles

F Front
R Right side
L Left side
B Back of unit with cargo area
(rear of trailer or straight
truck)
D Back (rear of tractor)
C Rear of cab
V Front of cargo area
T Top
U Undercarriage

Source: Researcher determined.

Remarks:

Code "N" (Noncollision) must be used whenever the corresponding Vehicle Number or Object Contacted (AC16 et al.) is coded "32"-"39". Since AC18 et al., General Area of Damage--2nd, will also equal "N" when AC16 et al. equals "32"-"39", this variable (AC15 et al.) and AC18 et al. will be identically coded.

Code "9" (Unknown) must be coded when the General Area of Damage--1st (AC15 et al.) on a vehicle is not known from any reliable source. Note, for all vehicles the rules developed in SAE J224MAR80 and SAE J1301, for determining the plane of damage, should be used for completion of this variable.

For vehicles which are CDC applicable (e.g., pickups, light vans, and passenger cars) the guidelines from J224MAR80 must be applied, and the codes provided under the "CDC Applicable and Other Vehicles" category must be used. This includes rollovers (i.e., AC16 et al. = "31").

For vehicles which are TDC applicable (i.e., medium/heavy trucks) use the guidelines from J1301, and use the codes provided under the "TDC Applicable Vehicles" category.

Variable Name: Vehicle Number or Object Contacted
(1st through 5th or higher)

Element Values:

01-30 — Vehicle Number

Noncollision

- 31 Overturn — rollover
- 32 Fire or explosion
- 33 Jackknife
- 34 Other intraunit damage
(specify):
- 35 Noncollision injury
- 38 Other noncollision (specify):
- 39 Noncollision — details
unknown

57 Fence

- 58 Wall
- 59 Building
- 60 Ditch or culvert
- 61 Ground
- 62 Fire hydrant
- 63 Curb
- 64 Bridge
- 68 Other fixed object (specify):
- 69 Unknown fixed object

Collision With Fixed Object

- 41 Tree (\leq 10 cm in diameter)
- 42 Tree ($>$ 10 cm in diameter)
- 43 Shrubbery or bush
- 44 Embankment

45 Breakaway pole or post (any
diameter)

Nonbreakaway Pole or Post

- 50 Pole or post (\leq 10 cm in
diameter)
- 51 Pole or post ($>$ 10 cm but \leq
30 cm in diameter)
- 52 Pole or post ($>$ 30 cm in
diameter)
- 53 Pole or post (diameter
unknown)

- 54 Concrete traffic barrier
- 55 Impact attenuator
- 56 Other traffic barrier
(includes guardrail)
(specify):

Collision with Nonfixed Object

- 71 Motor vehicle not in-
transport
- 72 Pedestrian
- 73 Cyclist or cycle
- 74 Other nonmotorist or
conveyance
- 75 Vehicle occupant
- 76 Animal
- 77 Train
- 78 Trailer, disconnected in
transport
- 79 Object fell from vehicle
in-transport
- 88 Other nonfixed object
(specify):
- 89 Unknown nonfixed object
- 98 Other event (specify):
- 99 Unknown event or object

Source: Researcher determined.

Remarks:

Refer to variables GV03, Vehicle Number, and EV05, Object Contacted, for definitions of the attributes and coding conventions.

Variable Name: Class of Vehicle--2nd
(1st through 5th or higher)

Element Values:

- 00 Not a motor vehicle
- 01 Subcompact/mini (wheelbase < 254 cm)
- 02 Compact (wheelbase \geq 254 but < 265 cm)
- 03 Intermediate (wheelbase \geq 265 but < 278 cm)
- 04 Full size (wheelbase \geq 278 but < 291 cm)
- 05 Largest (wheelbase \geq 291 cm)
- 09 Unknown passenger car size
- 11 Compact utility vehicle
- 12 Large utility vehicle (\leq 4,500 kgs GVWR)
- 13 Passenger van (\leq 4,500 kgs GVWR)
- 14 Other van (\leq 4,500 kgs GVWR)
- 15 Pickup truck (\leq 4,500 kgs GVWR)
- 18 Other truck (\leq 4,500 kgs GVWR)
- 19 Unknown light truck type
- 20 School bus
- 21 Other bus
- 22 Truck (> 4,500 kgs GVWR)
- 23 Tractor without trailer
- 24 Tractor-trailer(s)
- 25 Motored cycle
- 28 Other vehicle
- 99 Unknown

Source: Researcher determined--inputs include police report, vehicle inspection, VIN breakdown, and interviews.

Remarks:

The Passenger Car Classification Subcommittee, A3B11(1), of the Transportation Research Board, Traffic Records and Accident Analysis Committee, A3B11, assesses size based on the vehicle wheelbase. The guidelines for this classification can be found in the report entitled Recommended Definitions for Passenger Car Size Classification by Wheelbase and Weight, August 1984 by the previously mentioned subcommittee.

Codes "01" through "05" rely on the guidelines for wheelbase alone. If one of these codes is used, then the vehicle's Body Type, GV07, must be coded as an automobile (codes "01"-"09") or automobile derivative (codes "10"-"13").

Code "09" (Unknown passenger car size) is used when it is known that a vehicle is a passenger car (codes "01" through "05"), but the wheelbase is unknown (i.e., Original Wheelbase, EV28, equals "999").

Code "11" (Compact utility vehicle) refers to vehicles defined in code "14" (Compact utility) in variable GV07, Body Type. Use this code if the size of the utility vehicle is unknown.

Variable Name: Class of Vehicle--2nd (Cont'd.)
(1st through 5th or higher)

Code "12" [Large utility vehicle ($\leq 4,500$ kgs GVWR)] refers to vehicles defined in codes "15" (Large utility) and "16" (Utility station wagon) in variable GV07, Body Type.

Code "13" [Passenger van ($\leq 4,500$ kgs GVWR)] includes all vehicle types defined in codes "20" (Minivan) and "21" (Large van) and "29" (Unknown van type) in variable GV07, Body Type, and designed with seats installed for passengers in excess of two seat positions. Also included are codes "24" (Van based school bus) and "25" (Van based other bus). Cargo vans are recorded in code "14".

Code "14" [Other van ($\leq 4,500$ kgs GVWR)] includes all vehicles as described in variable GV07, Body Type, codes "22" (Step van or walk-in van), "23" (Van based motorhome), and "28" (Other van type) not fitting into the definition of code "13" above. This code also includes vehicles described in variable GV07, Body Type, codes "20" (Minivan) and "21" (Large van) which are designed as cargo vans.

Code "15" [Pickup truck ($\leq 4,500$ kgs GVWR)] is defined in variable GV07, Body Type, codes "30", "31", "32", "33" and "39".

Code "18" [Other truck ($\leq 4,500$ kgs GVWR)] is defined in codes "40", "41", "42", and "45" in variable GV07, Body Type.

Code "19" (Unknown light truck type) is defined in code "48" [Unknown other light truck type (not a pickup)] in variable GV07, Body Type.

Code "20" (School bus) refers to those vehicles described by code "50" (School bus) in variable GV07, Body Type.

Code "21" (Other bus) describes those vehicles included in codes "58" and "59" in variable GV07, Body Type.

Code "22" [Truck ($>4,500$ kgs GVWR) is defined in variable GV07, Body Type, as codes "60" through "65", "78" and "79".

Code "23" (Tractor without trailer) refers to code "67" (Truck-tractor with no cargo trailer) in variable GV07, Body Type.

Code "24" (Tractor-trailer(s)) is defined in codes "68", "69", and "70" in variable GV07, Body Type.

Code "25" (Motored cycle) refers to GV07, Body Type, codes "80" through "89".

Code "28" (Other vehicle) refers to all vehicles described by codes "90", "91", "92", "93", or "97" in variable GV07, Body Type.

Variable Name: Class of Vehicle--2nd (Cont'd.)
(1st through 5th or higher)

Code "99" (Unknown) is used when there is a lack of information regarding the type of vehicle. This lack of information prohibits the accurate classification of this vehicle using one of the preceding codes. This code is equivalent to Body Type, GV07, codes "49" [Unknown light vehicle type (automobile, utility van, or light truck)] or "99" (Unknown body type).

Variable Name: General Area of Damage--2nd
(1st through 5th or higher)

Element Values:

∅ Not a motor vehicle
N Noncollision
9 Unknown

CDC Applicable and Other Vehicles

F Front
R Right side
L Left side
B Back
T Top
U Undercarriage

TDC Applicable Vehicles

F Front
R Right side
L Left side
B Back of unit with cargo area
(rear of trailer or straight
truck)
D Back (rear of tractor)
C Rear of cab
V Front of cargo area
T Top
U Undercarriage

Source: Researcher determined.

Remarks:

Code "∅" (Not a motor vehicle) for AC18 et al., when AC16 et al., Vehicle Number or Object Contacted, equals "41" through "89".

Code "N" (Noncollision) must be used whenever the corresponding Vehicle Number or Object Contacted (AC16 et al.) is coded "31"-"39". Since AC15 et al., General Area of Damage--1st, will also equal "N" when AC16 et al. equals "32"-"39", this variable (AC18 et al.) and AC15 et al. will be identically coded for the AC16 et al. values of "32"-"39". However, this code will be used on this variable when AC16 et al. equals "31" even though AC15 et al. will not take this code.

Code "9" (Unknown) must be coded when the General Area of Damage--1st (AC15 et al.) on a vehicle is not known from any reliable source. Note, for all vehicles the rules developed in SAE J224MAR80 and SAE J1301, for determining the plane of damage, should be used for completion of this variable.

For vehicles which are CDC applicable (e.g., pickups, light vans, and passenger cars) the guidelines from J224MAR80 must be applied, and the codes provided under the "CDC Applicable and Other Vehicles" category must be used.

For vehicles which are TDC applicable (i.e., medium/heavy trucks) use the guidelines from J1301, and use the codes provided under the "TDC Applicable Vehicles" category.



GENERAL VEHICLE FORM

1. Primary Sampling Unit Number _____

2. Case Number - Stratum _____

3. Vehicle Number _____

VEHICLE IDENTIFICATION

4. Vehicle Model Year _____
Code the last two digits of the model year
(99) Unknown

5. Vehicle Make (specify): _____

Applicable codes are found in your
NASS Data Collection, Coding and
Editing Manual.
(99) Unknown

6. Vehicle Model (specify): _____

Applicable codes are found in your
NASS Data Collection, Coding and
Editing Manual.
(999) Unknown

7. Body Type _____
Note: Applicable codes may be found on
the back of this page.

8. Vehicle Identification Number _____
1 2 3 4 5 6 7 8 9 10 11 12 13 14 15 16 17

Left justify; Slash zeros and letter Z (0 and Z)
No VIN - Code all zeros
Unknown - Code all nines

OFFICIAL RECORDS

9. Police Reported Vehicle Disposition _____
(0) Not towed due to vehicle damage
(1) Towed due to vehicle damage
(9) Unknown

10. Police Reported Travel Speed _____

Code to the nearest kph (NOTE: 000 means
less than 0.5 kph)
(160) 159.5 kph and above
(999) Unknown

____ mph X 1.6093 = _____ kph

11. Police Reported Alcohol Presence _____
(0) No alcohol present
(1) Yes (alcohol present)
(7) Not reported
(8) No driver present
(9) Unknown

Note: See variables 37 through 55
(Page 4) for information on Other Drugs

12. Alcohol Test Result For Driver _____
Code actual value (decimal implied
before first digit - 0.xx)
(95) Test refused
(96) None given
(97) AC test performed, results unknown
(98) No driver present
(99) Unknown

Source: _____

ACCIDENT RELATED

13. Speed Limit _____
(000) No statutory limit
Code posted or statutory speed limit
in kph
(999) Unknown

____ mph X 1.6093 = _____ kph

14. Attempted Avoidance Maneuver _____
(01) No avoidance actions
(02) Braking (no lockup)
(03) Braking (lockup)
(04) Braking (lockup unknown)
(05) Releasing brakes
(06) Steering left
(07) Steering right
(08) Braking and steering left
(09) Braking and steering right
(10) Accelerating
(11) Accelerating and steering left
(12) Accelerating and steering right
(97) No driver present
(98) Other action (specify): _____

(99) Unknown

15. Accident Type _____
Applicable codes may be found on the
back of page two of this field form
(00) No impact
Code the number of the diagram that
best describes the accident circumstance
(98) Other accident type (specify): _____

(99) Unknown

**** SKIP TO VARIABLE GV37 IF GV07 DOES NOT EQUAL 01-49 ****

CODES FOR BODY TYPE

CDS APPLICABLE VEHICLES

Automobiles

- (01) Convertible (excludes sun-roof, t-bar)
- (02) 2-door sedan, hardtop, coupe
- (03) 3-door/2-door hatchback
- (04) 4-door sedan, hardtop
- (05) 5-door/4-door hatchback
- (06) Station wagon (excluding van and truck based)
- (07) Hatchback, number of doors unknown
- (08) Other automobile type (specify): _____
- (09) Unknown automobile type

Automobile Derivatives

- (10) Auto based pickup (includes El Camino, Caballero, Ranchero, Brat, and Rabbit pickup)
- (11) Auto based panel (cargo station wagon, auto based ambulance/hearse)
- (12) Large limousine - more than four side doors or stretched chassis
- (13) Three-wheel automobile or automobile derivative

Utility Vehicles ($\leq 4,500$ kgs GVWR)

- (14) Compact utility (Jeep CJ-2 - CJ-7, Scrambler, Golden Eagle, Renegade, Laredo, Wrangler, Cherokee [84 and after], Dispatcher, Raider, Bronco II, Bronco [76 and before], Explorer, S-10 Blazer, Geo Tracker, Bravada, S-15 Jimmy, Thing, Pathfinder, Trooper, Trooper II, Rodeo, Amigo, Navajo, 4-Runner, Montero, Samurai, Sidekick, Rocky)
- (15) Large utility (includes Jeep Cherokee [83 and before], Ramcharger, Trailduster, Bronco-fullsize [78 and after], fullsize Blazer, fullsize Jimmy, Landcruiser, Rover, Scout)
- (16) Utility station wagon (Chevy Suburban, GMC Suburban, Travelall, Grand Wagoneer, includes suburban limousine)
- (19) Utility, unknown body type

Van Based Light Trucks ($\leq 4,500$ kgs GVWR)

- (20) Minivan (Chrysler Town and Country, Caravan, Grand Caravan, Voyager, Grand Voyager, Mini-Ram, Dodge/Plymouth Vista, Aerostar, Villager, Lumina APV, Trans Sport, Silhouette, Astro, Safari, Toyota Van, Toyota Minivan, Previa, Nissan Minivan, Quest, Mitsubishi Minivan, Vanagon/Camper.)
- (21) Large van (B150-B350, Sportsman, Royal, Maxiwagon, Ram, Tradesman, Voyager [83 and before], E150-E350, Econoline, Clubwagon, Chateau, G10-G30, Chevy Van, Beauville, Sport Van, G15-G35, Rally Van, Vandura.)
- (22) Step van or walk-in van ($\leq 4,500$ kgs GVWR)
- (23) Van based motorhome ($\leq 4,500$ kgs GVWR)
- (24) Van based school bus ($\leq 4,500$ kgs GVWR)
- (25) Van based other bus ($\leq 4,500$ kgs GVWR)
- (28) Other van type (Hi-Cube Van, Kary) (specify): _____
- (29) Unknown van type

Light Conventional Trucks (Pickup style cab, $\leq 4,500$ kgs GVWR)

- (30) Compact pickup (D50, Colt P/U, Ram 50, Dakota, Arrow Pickup [foreign], Ranger, Courier, S-10, T-10, LUV, S-15, T-15, Sonoma, Datsun/Nissan Pickup, P'up, Mazda Pickup, Toyota Pickup, Mitsubishi Pickup)
- (31) Large Pickup (Jeep Pickup, Comanche, Ram Pickup, D100-D350, W100-W350, F100-F350, C10-C35, K10-K35, R10-R35, V10-V35, Silverado, Sierra, R100-R500.)

- (32) Pickup with slide-in camper
- (33) Convertible pickup
- (39) Unknown pickup style light conventional truck type

Other Light Trucks ($\leq 4,500$ kgs GVWR)

- (40) Cab chassis based (includes rescue vehicles, light stake, dump, and tow truck)
- (41) Truck based panel
- (42) Light truck based motorhome (chassis mounted)
- (45) Other light conventional truck type
- (48) Unknown light truck type
- (49) Unknown light vehicle type (automobile, utility, van, or light truck)

OTHER VEHICLES

Buses (Excludes Van Based)

- (50) School bus (designed to carry students, not cross country or transit)
- (58) Other bus type (e.g., transit, intercity, bus based motorhome) (specify): _____
- (59) Unknown bus type

Medium/Heavy Trucks ($> 4,500$ kgs GVWR)

- (60) Step van ($> 4,500$ kgs GVWR)
- (61) Single unit straight truck (4,500 kgs $<$ GVWR \leq 8,850 kgs)
- (62) Single unit straight truck (8,850 kgs $<$ GVWR \leq 12,000 kgs)
- (63) Single unit straight truck ($> 12,000$ kgs GVWR)
- (64) Single unit straight truck, GVWR unknown
- (65) Medium/heavy truck based motorhome
- (67) Truck-tractor with no cargo trailer
- (68) Truck-tractor pulling one trailer
- (69) Truck-tractor pulling two or more trailers
- (70) Truck-tractor (unknown if pulling trailer)
- (78) Unknown medium/heavy truck type
- (79) Unknown truck type (light/medium/heavy)

Motored Cycles (Does Not Include All-Terrain Vehicles/Cycles)

- (80) Motorcycle
- (81) Moped (motorized bicycle)
- (82) Three-wheel motorcycle or moped
- (88) Other motored cycle (minibike, motorscooter) (specify): _____
- (89) Unknown motored cycle type

Other Vehicles

- (90) ATV (All-Terrain Vehicle) and ATC (All-Terrain Cycle)
- (91) Snowmobile
- (92) Farm equipment other than trucks
- (93) Construction equipment other than trucks
- (97) Other vehicle type
- (99) Unknown body type

OCCUPANT RELATED

16. Driver Presence in Vehicle _____
 (0) Driver not present
 (1) Driver present
 (9) Unknown

17. Number of Occupants This Vehicle _____
 (00-96) Code actual number of occupants
 for this vehicle
 (97) 97 or more
 (99) Unknown

18. Number of Occupant Forms Submitted _____

24. Rollover _____
 (0) No rollover (no overturning)

Rollover (primarily about the longitudinal axis)
 (1) Rollover, 1 quarter turn only
 (2) Rollover, 2 quarter turns
 (3) Rollover, 3 quarter turns
 (4) Rollover, 4 or more quarter turns (specify):

(5) Rollover--end-over-end (i.e., primarily about the lateral axis)
 (9) Rollover (overturn), details unknown

VEHICLE WEIGHT ITEMS

19. Vehicle Curb Weight _____ 0
 _____ Code weight to nearest
 10 kilograms.
 (045) Less than 450 kilograms
 (610) 6,100 kilograms or more
 (999) Unknown

_____ lbe X .4536 = _____ kgs

Source: _____

20. Vehicle Cargo Weight _____ 0
 _____ Code weight to nearest
 10 kilograms.
 (000) Less than 5 kilograms
 (450) 4,500 kilograms or more
 (999) Unknown

_____ lbe X .4536 = _____ kgs

OVERRIDE/UNDERRIDE (THIS VEHICLE)

25. Front Override/Underride (this Vehicle) _____

26. Rear Override/Underride (this Vehicle) _____

(0) No override/underride, or not an end-to-end impact

Override (see specific CDC)
 (1) 1st CDC
 (2) 2nd CDC
 (3) Other not automated CDC (specify):

Underride (see specific CDC)
 (4) 1st CDC
 (5) 2nd CDC
 (6) Other not automated CDC (specify):

(7) Medium/heavy truck or bus override
 (9) Unknown

RECONSTRUCTION DATA

21. Towed Trailing Unit _____
 (0) No towed unit
 (1) Yes--towed trailing unit
 (9) Unknown

22. Documentation of Trajectory Data for This Vehicle _____
 (0) No
 (1) Yes

23. Post Collision Condition of Tree or Pole (For Highest Delta V) _____
 (0) Not collision (for highest delta V) with tree or pole
 (1) Not damaged
 (2) Cracked/sheared
 (3) Tilted < 45 degrees
 (4) Tilted ≥ 45 degrees
 (5) Uprooted tree
 (6) Separated pole from base
 (7) Pole replaced
 (8) Other (specify):

 (9) Unknown

HEADING ANGLE AT IMPACT FOR HIGHEST DELTA V

Values: (000)-(359) Code actual value
 (997) Noncollision
 (998) Impact with object
 (999) Unknown

27. Heading Angle For This Vehicle _____

28. Heading Angle For Other Vehicle _____

Category	Configuration	ACCIDENT TYPES (Includes Intent)					
I Single Driver	A Right Roadside Departure	01 DRIVE OFF ROAD	02 CONTROL/TRACTION LOSS	03 AVOID COLLISION WITH VEH. PED. ANIM.	04 SPECIFICS OTHER	05 SPECIFICS UNKNOWN	
	B Left Roadside Departure	06 DRIVE OFF ROAD	07 CONTROL/TRACTION LOSS	08 AVOID COLLISION WITH VEH. PED. ANIM.	09 SPECIFICS OTHER	10 SPECIFICS UNKNOWN	
	C Forward Impact	11 PARKED VEH.	12 STA OBJECT	13 PEDESTRIAN/ANIMAL	14 END DEPARTURE	15 SPECIFICS OTHER	16 SPECIFICS UNKNOWN
II Same Trafficway Same Direction	D Rear End	20 STOPPED 21 22 23	22 SLOWER 23 24 25 26 27	28 DECEL. 29 30 31	30 AVOID COLLISION WITH VEH.	(EACH - 32) SPECIFICS OTHER	(EACH - 33) SPECIFICS UNKNOWN
	E Forward Impact	34 CONTROL/TRACTION LOSS	36 CONTROL/TRACTION LOSS	38 AVOID COLLISION WITH VEH.	40 AVOID COLLISION WITH OBJECT	(EACH - 42) SPECIFICS OTHER	(EACH - 43) SPECIFICS UNKNOWN
	F Sideswipe Angle	44 LATERAL MOVE	46 LATERAL MOVE	47 LATERAL MOVE	(EACH - 48) SPECIFICS OTHER	(EACH - 49) SPECIFICS UNKNOWN	
III Same Trafficway Opposite Direction	G Head-On	50 LATERAL MOVE	51 LATERAL MOVE	(EACH - 52) SPECIFICS OTHER	(EACH - 53) SPECIFICS UNKNOWN		
	H Forward Impact	54 CONTROL/TRACTION LOSS	56 CONTROL/TRACTION LOSS	58 AVOID COLLISION WITH VEH.	60 AVOID COLLISION WITH OBJECT	(EACH - 62) SPECIFICS OTHER	(EACH - 63) SPECIFICS UNKNOWN
	I Sideswipe Angle	64 LATERAL MOVE	65 LATERAL MOVE	(EACH - 66) SPECIFICS OTHER	(EACH - 67) SPECIFICS UNKNOWN		
IV Change Trafficway Vehicle Turning	J Turn Across Path	68 INITIAL OPPOSITE DIRECTIONS	71 INITIAL SAME DIRECTIONS	73 INITIAL SAME DIRECTIONS	72 INITIAL SAME DIRECTIONS	(EACH - 74) SPECIFICS OTHER	(EACH - 75) SPECIFICS UNKNOWN
	K Turn Into Path	77 TURN INTO SAME DIRECTION	78 TURN INTO SAME DIRECTION	80 TURN INTO OPPOSITE DIRECTIONS	81 TURN INTO OPPOSITE DIRECTIONS	(EACH - 84) SPECIFICS OTHER	(EACH - 85) SPECIFICS UNKNOWN
V Intersecting Paths (Vehicle Damage)	L Straight Paths	87 STRAIGHT PATHS	88 STRAIGHT PATHS	(EACH - 89) SPECIFICS OTHER	(EACH - 90) SPECIFICS UNKNOWN		
VI Miscellaneous	M Backing Etc	92 BACKING VEH.	93 OTHER VEH. OR OBJECT	98 Other Accident Type 99 Unknown Accident Type 00 N Impact			

<p>29. Basis for Total Delta V (highest) _____</p> <p><i>Delta V Calculated</i></p> <p>(1) CRASH program—damage only routine</p> <p>(2) CRASH program—damage and trajectory routine</p> <p>(3) Missing vehicle algorithm</p> <p><i>Delta V Not Calculated</i></p> <p>(4) At least one vehicle (which may be this vehicle) is beyond the scope of an acceptable reconstruction program, regardless of collision conditions.</p> <p>(5) All vehicles within scope (CDC applicable) of CRASH program but one of the collision conditions is beyond the scope of the CRASH program or other acceptable reconstruction technique, regardless of adequacy of damage data.</p> <p>(6) All vehicle and collision conditions are within scope of one of the acceptable reconstruction programs, but there is insufficient data available.</p>	<p style="text-align: right;">Highest</p> <p>32. Lateral Component of Delta V + - _____</p> <p>_____ Nearest kph (highest)</p> <p>_____ Nearest kph (secondary)</p> <p>(NOTE: __000 means greater than -0.5 kph and less than +0.5 kph) (±160) ±159.5 kph and above (_999) Unknown</p> <p>33. Energy Absorption _____, ____ 0 0</p> <p>_____ Nearest 100 joules (highest)</p> <p>_____ Nearest 100 joules (secondary)</p> <p>(NOTE: 0000 means less than 50 joules) (9997) 999,650 joules or more (9999) Unknown</p>
COMPUTER GENERATED DELTA V	
<p style="text-align: right;">Highest</p> <p>30. Total Delta V _____</p> <p>_____ Nearest kph (highest)</p> <p>_____ Nearest kph (secondary)</p> <p>(NOTE: 000 means less than 0.5 kph) (160) 159.5 kph and above (999) Unknown</p> <p>31. Longitudinal Component of Delta V + - _____</p> <p>_____ Nearest kph (highest)</p> <p>_____ Nearest kph (secondary)</p> <p>(NOTE: __000 means greater than -0.5 kph and less than +0.5 kph) (±160) ±159.5 kph and above (_999) Unknown</p>	<p>34. Confidence In Reconstruction Program Results (For Highest Delta V) _____</p> <p>(0) No reconstruction</p> <p>(1) Collision fits model — results appear reasonable</p> <p>(2) Collision fits model — results appear high</p> <p>(3) Collision fits model — results appear low</p> <p>(4) Borderline reconstruction — results appear reasonable</p> <p>35. Type of Vehicle Inspection _____</p> <p>(0) No inspection</p> <p>(1) Complete inspection</p> <p>(2) Partial inspection (specify): _____</p> <p>36. Is this an AOPS Vehicle? _____</p> <p>(0) No</p> <p>(1) Yes - researcher determined</p> <p>(2) VIN determined air bag system</p> <p>(3) VIN determined automatic (passive) belts</p> <p>(4) VIN determined air bag and automatic (passive) belts</p>

IS OLDMISS APPLICABLE FOR THIS VEHICLE? [] YES [] NO
 IF YES: IS A COMPLETED OLDMISS PROGRAM SUMMARY INCLUDED? [] YES [] NO

37. Police Reported Other Drug Presence _____
 (0) No other drug(s) present
 (1) Yes [other drug(s) present]
 (7) Not reported
 (8) No driver present
 (9) Unknown

38. Police Reported Drug Evaluation Classification (DEC) Test For Driver _____
 (0) No DEC process available or given
 (1) DEC process given, results known
 (2) DEC process given, results unknown
 (3) DEC process available, unknown if given
 (8) No driver present

39. Other Drug Specimen Test Type For Driver _____
 (0) No specimen test given
 (1) Blood test
 (2) Urine test
 (3) Other specimen tests (specify): _____
 (7) Unspecified specimen test
 (8) No driver present
 (9) Unknown if specimen test given

**DRUG EVALUATION CLASSIFICATION
 OTHER DRUGS TEST RESULTS FOR DRIVER**

	DEC Test Results	Specimen Test Results
Narcotic Drug	40. _____	41. _____
Depressant Drug	42. _____	43. _____
Stimulant Drug	44. _____	45. _____
Hallucinogen Drug	46. _____	47. _____
Cannabinoid Drug	48. _____	49. _____
Phencyclidine (PCP)	50. _____	51. _____
Inhalant Drug	52. _____	53. _____
Other Drug (Excluding Nicotine, Aspirin, Alcohol, Drugs Administered Post-Crash)	54. _____	55. _____

Codes For DEC Test Results

- (0) No DEC test given
- (1) Passed DEC test
- (2) Failed DEC test
- (3) DEC test given—results unknown
- (8) No driver present
- (9) Unknown if DEC test given

Codes for Specimen Test Results

- (0) No specimen test given
- (1) Drug not found in specimen
- (2) Drug found in specimen
- (7) Specimen test given, results unknown or not obtained
- (8) No driver present
- (9) Unknown if specimen test given

OTHER DATA

56. Driver's Zip Code _____

- (00000) Driver not present
- (00001) Driver not a resident of U.S. or territories
- _____ Code actual 5-digit zip code
- (99999) Unknown

57. Driver's Race/Ethnic Origin _____

- (0) Driver not present
- (1) White (non-Hispanic)
- (2) Black (non-Hispanic)
- (3) White (Hispanic)
- (4) Black (Hispanic)
- (5) American Indian, Eskimo or Aleut
- (6) Asian or Pacific Islander
- (8) Other (specify): _____
- (9) Unknown

58. Vehicle Special Use (This Trip) _____

- (0) No special use
- (1) Taxi
- (2) Vehicle used as school bus
- (3) Vehicle used as other bus
- (4) Military
- (5) Police
- (6) Ambulance
- (7) Fire truck or car
- (8) Other (specify): _____
- (9) Unknown

ROLLOVER DATA

If GV07 (Body Type) ≠ 1-49, leave GV59-GV63 blank.
 If GV24 (Rollover) = 0, then GV59-GV63 must equal 0.
 If GV24 = 9, then GV59-GV63 must equal 9.

59. Rollover Initiation Type _____

- (0) No rollover
- (1) Trip-over
- (2) Flip-over
- (3) Turn-over
- (4) Climb-over
- (5) Fall-over
- (6) Bounce-over
- (7) Collision with another vehicle
- (8) Other rollover initiation type specify): _____
- (9) Unknown rollover initiation type

60. Location of Rollover Initiation _____

- (0) No rollover
- (1) On roadway
- (2) On shoulder—paved
- (3) On shoulder—unpaved
- (4) On roadside or divided trafficway median
- (9) Unknown

61. Rollover Initiation Object Contacted _____

62. Location on Vehicle Where Initial Principal Tripping Force Is Applied _____

- (0) No rollover
- (1) Wheels/tires
- (2) Side plane
- (3) End plane
- (4) Undercarriage
- (5) Other location on vehicle (specify): _____
- (8) Non-contact rollover forces (specify): _____
- (9) Unknown

63. Direction of Initial Roll _____

- (0) No rollover
- (1) Roll right - primarily about the longitudinal axis
- (2) Roll left - primarily about the longitudinal axis
- (5) End-over-end (i.e., primarily about the lateral axis)
- (9) Unknown roll direction

PRECRASH DATA

64. Pre-Event Movement (Prior to Recognition of Critical Event) _____

- (01) Going straight
- (02) Slowing or stopping in traffic lane
- (03) Starting in traffic lane
- (04) Stopped in traffic lane
- (05) Passing or overtaking another vehicle
- (06) Disabled or parked in travel lane
- (07) Leaving a parking position
- (08) Entering a parking position
- (09) Turning right
- (10) Turning left
- (11) Making a U-turn
- (12) Backing up (other than for parking position)
- (13) Negotiating a curve
- (14) Changing lanes
- (15) Merging
- (16) Successful avoidance maneuver to a previous critical event
- (97) Other (specify): _____
- (98) No driver present
- (99) Unknown

CODES FOR ROLLOVER INITIATION OBJECT CONTACTED

(00) No rollover

(01-30) — Vehicle Number

Noncollision

(31) Turn-over — fall-over

(33) Jackknife

Collision With Fixed Object

(41) Tree (\leq 10 cm in diameter)

(42) Tree ($>$ 10 cm in diameter)

(43) Shrubbery or bush

(44) Embankment

(45) Breakaway pole or post (any diameter)

Nonbreakaway Pole or Post

(50) Pole or post (\leq 10 cm in diameter)

(51) Pole or post ($>$ 10 cm but \leq 30 cm in diameter)

(52) Pole or post ($>$ 30 cm in diameter)

(53) Pole or post (diameter unknown)

(54) Concrete traffic barrier

(55) Impact attenuator

(56) Other traffic barrier (includes guardrail)
(specify): _____

(57) Fence

(58) Wall

(59) Building

(60) Ditch or culvert

(61) Ground

(62) Fire hydrant

(63) Curb

(64) Bridge

(68) Other fixed object (specify): _____

(69) Unknown fixed object

Collision with Nonfixed Object

(71) Motor vehicle not in-transport

(76) Animal

(77) Train

(78) Trailer, disconnected in transport

(79) Object fell from vehicle in-transport

(88) Other nonfixed object (specify): _____

(89) Unknown nonfixed object

(98) Other event (specify): _____

(99) Unknown event or object

PRECRASH DATA (Continued)

65. Critical Precrash Event _____

This Vehicle Loss of Control Due To:

- (01) Blow out or flat tire
- (02) Stalled engine
- (03) Disabling vehicle failure (e.g., wheel fell off) (specify): _____
- (04) Non-disabling vehicle problem (e.g., hood flew up) (specify): _____
- (05) Poor road conditions (puddle, pot hole, ice, etc.) (specify): _____
- (06) Traveling too fast for conditions
- (08) Other cause of control loss (specify): _____
- (09) Unknown cause of control loss

This Vehicle Traveling

- (10) Over the lane line on left side of travel lane
- (11) Over the lane line on right side of travel lane
- (12) Off the edge of the road on the left side
- (13) Off the edge of the road on the right side
- (14) End departure
- (15) Turning left at intersection
- (16) Turning right at intersection
- (17) Crossing over (passing through) intersection
- (19) Unknown travel direction

Other Motor Vehicle In Lane

- (50) Stopped
- (51) Traveling in same direction with lower speed (i.e., lower steady speed or decelerating)
- (52) Traveling in same direction with higher speed
- (53) Traveling in opposite direction
- (54) In crossover
- (55) Backing
- (59) Unknown travel direction of other motor vehicle in lane

Other Motor Vehicle Encroaching Into Lane

- (60) From adjacent lane (same direction)—over left lane line
- (61) From adjacent lane (same direction)—over right lane line
- (62) From opposite direction—over left lane line
- (63) From opposite direction—over right lane line
- (64) From parking lane
- (65) From crossing street, turning into same direction
- (66) From crossing street, across path
- (67) From crossing street, turning into opposite direction
- (68) From crossing street, intended path not known
- (70) From driveway, turning into same direction
- (71) From driveway, across path
- (72) From driveway, turning into opposite direction
- (73) From driveway, intended path not known
- (74) From entrance to limited access highway
- (78) Encroachment by other vehicle—details unknown

Pedestrian or Pedalcyclist, or Other Nonmotorist

- (80) Pedestrian in roadway
- (81) Pedestrian approaching roadway
- (82) Pedestrian—unknown location
- (83) Pedalcyclist or other nonmotorist in roadway (specify): _____
- (84) Pedalcyclist or other nonmotorist approaching roadway (specify): _____
- (85) Pedalcyclist or other nonmotorist—unknown location (specify): _____

Object or Animal

- (87) Animal in roadway
- (88) Animal approaching roadway
- (89) Animal—unknown location
- (90) Object in roadway
- (91) Object approaching roadway
- (92) Object—unknown location
- (98) Other critical precrash event (specify): _____
- (99) Unknown

For Corrective Actions Attempted see variable GV14 (Attempted Avoidance Manuever)

66. Precrash Stability After Avoidance Manuever _____

- (0) No avoidance manuever
- (1) Tracking
- (2) Skidding longitudinally—rotation less than 30 degrees
- (3) Skidding laterally—clockwise rotation
- (4) Skidding laterally—counterclockwise rotation
- (7) Other vehicle loss-of-control (specify): _____
- (8) No driver present
- (9) Precrash stability unknown

67. Precrash Directional Consequences of Avoidance Manuever (Corrective Action) _____

- (0) No avoidance manuever
- (1) Vehicle stayed in travel lane where avoidance manuever was initiated
- (2) Vehicle stayed on roadway but left travel lane where avoidance manuever was initiated
- (3) Vehicle stayed on roadway, not known if left travel lane where avoidance manuever was initiated
- (4) Vehicle departed roadway
- (5) Avoidance manuever initiated off roadway
- (8) No driver present
- (9) Directional consequences unknown

*** IF THE CDS APPLICABLE VEHICLE WAS NOT INSPECTED (I.E., GV35 = 0), *** DO NOT COMPLETE THE EXTERIOR AND INTERIOR VEHICLE FORMS.

*** IF GV07 DOES NOT EQUAL 01-49, DO NOT COMPLETE *** THE EXTERIOR VEHICLE, INTERIOR VEHICLE, OCCUPANT ASSESSMENT, AND OCCUPANT INJURY FORMS.



GENERAL VEHICLE LOG

TO BE COMPLETED BY TEAM	TO BE COMPLETED BY THE ZONE CENTER																																																																																																																																																					
<p>1. PSU Number _____</p> <p>2. Case Number—Stratum _____</p> <p>3. Researcher Completing Form _____</p> <p>4. Vehicle Number _____</p> <p>5. Vehicle Disposition/Type _____ (1) Towed, CDS applicable (2) Non-towed, CDS applicable (not AOPS) (3) Non-CDS applicable (4) Non-towed AOPS—CDS applicable</p> <p>6. Reason Vehicle Inspection Not Completed _____ (00) Non-CDS applicable vehicle (01) Complete inspection (02) Partial inspection -- under repair (03) Partial inspection -- repaired (04) Partial inspection -- other (specify): _____ (05) Vehicle cannot be located (06) Vehicle destroyed (07) Vehicle outside of study area (08) Vehicle impounded (09) Vehicle sold (10) Hit and run vehicle (11) Owner could not be located (12) Owner refusal (13) Insurance company refusal (14) Attorney refusal or litigation (15) Repair or tow facility refusal (16) Stolen (17) Wrong name and address on PAR (18) Caseload / staff turnover (19) Other (specify): _____</p> <p>7. Knowledge Of Highest Delta V Results _____ <i>Known</i> (01) CRASH-PC damage only (02) CRASH-PC damage and trajectory (03) OLDMISS (completed by Zone Center) <i>Unknown</i> (04) Rollover (05) Other non-horizontal force (06) Sideswipe type damage / severe override (07) Vehicle out of scope / pedestrian (08) Yielding object (09) Overlapping damage (10) Insufficient data (11) Other (specify): _____ (12) OLDMISS form - pending review by Zone Center</p> <p>8. Presence Of Non-coded Reconstruction Program? _____ (0) No (1) Yes</p> <p>9. Data Obtained for This Vehicle's Most Severe Impact (Regardless of Usage) _____ (0) No data obtained (1) CDC data only (2) Trajectory data only (3) CDC and crush profile only (4) CDC and trajectory data only (5) CDC, crush profile, and trajectory data</p>	<p>10. Reconstruction Program (Most Severe Impact) _____ (0) Not present (1) Added (2) Dropped (3) Changed (4) Correct</p> <p>11. Reason(s) Program Results Dropped Or Changed _____ a. Algorithm choice b. Collision type c. Vehicle type d. Size / stiffness / weight e. Improved PDOF f. CDC g. Trajectory data h. Damage data i. Heading angle for Oldmiss</p> <table style="width:100%; text-align: center; border-collapse: collapse;"> <tr> <td>a</td><td>b</td><td>c</td><td>d</td><td>e</td><td>f</td><td>g</td><td>h</td><td>i</td> </tr> <tr> <td style="border: 1px solid black; width: 20px; height: 20px;"></td> <td style="border: 1px solid black; width: 20px; height: 20px;"></td> <td style="border: 1px solid black; width: 20px; height: 20px;"></td> <td style="border: 1px solid black; width: 20px; height: 20px;"></td> <td style="border: 1px solid black; width: 20px; height: 20px;"></td> <td style="border: 1px solid black; width: 20px; height: 20px;"></td> <td style="border: 1px solid black; width: 20px; height: 20px;"></td> <td style="border: 1px solid black; width: 20px; height: 20px;"></td> <td style="border: 1px solid black; width: 20px; height: 20px;"></td> </tr> </table> <p>(Blank) Correct or no reconstruction (1) Incorrect</p> <p style="text-align: center;">DATA STATUS OF VARIABLE NUMBERS 3-67</p> <table style="width:100%; text-align: center; border-collapse: collapse;"> <tr> <td>3</td><td>4</td><td>5</td><td>6</td><td>7</td><td>8</td><td>9</td><td>10</td><td>11</td><td>12</td><td>13</td> </tr> <tr> <td style="border: 1px solid black; width: 20px; height: 20px;"></td> <td style="border: 1px solid black; width: 20px; height: 20px;"></td> <td style="border: 1px solid black; width: 20px; height: 20px;"></td> <td style="border: 1px solid black; width: 20px; height: 20px;"></td> <td style="border: 1px solid black; width: 20px; height: 20px;"></td> <td style="border: 1px solid black; width: 20px; height: 20px;"></td> <td style="border: 1px solid black; width: 20px; height: 20px;"></td> <td style="border: 1px solid black; width: 20px; height: 20px;"></td> <td style="border: 1px solid black; width: 20px; height: 20px;"></td> <td style="border: 1px solid black; width: 20px; height: 20px;"></td> <td style="border: 1px solid black; width: 20px; height: 20px;"></td> </tr> <tr> <td>14</td><td>15</td><td>16</td><td>17</td><td>18</td><td>19</td><td>20</td><td>21</td><td>22</td><td>23</td><td>24</td> </tr> <tr> <td style="border: 1px solid black; width: 20px; height: 20px;"></td> <td style="border: 1px solid black; width: 20px; height: 20px;"></td> <td style="border: 1px solid black; width: 20px; height: 20px;"></td> <td style="border: 1px solid black; width: 20px; height: 20px;"></td> <td style="border: 1px solid black; width: 20px; height: 20px;"></td> <td style="border: 1px solid black; width: 20px; height: 20px;"></td> <td style="border: 1px solid black; width: 20px; height: 20px;"></td> <td style="border: 1px solid black; width: 20px; height: 20px;"></td> <td style="border: 1px solid black; width: 20px; height: 20px;"></td> <td style="border: 1px solid black; width: 20px; height: 20px;"></td> <td style="border: 1px solid black; width: 20px; height: 20px;"></td> </tr> <tr> <td>25</td><td>26</td><td>27</td><td>28</td><td>29</td><td>30</td><td>31</td><td>32</td><td>33</td><td>34</td><td>35</td> </tr> <tr> <td style="border: 1px solid black; width: 20px; height: 20px;"></td> <td style="border: 1px solid black; width: 20px; height: 20px;"></td> <td style="border: 1px solid black; width: 20px; height: 20px;"></td> <td style="border: 1px solid black; width: 20px; height: 20px;"></td> <td style="border: 1px solid black; width: 20px; height: 20px;"></td> <td style="border: 1px solid black; width: 20px; height: 20px;"></td> <td style="border: 1px solid black; width: 20px; height: 20px;"></td> <td style="border: 1px solid black; width: 20px; height: 20px;"></td> <td style="border: 1px solid black; width: 20px; height: 20px;"></td> <td style="border: 1px solid black; width: 20px; height: 20px;"></td> <td style="border: 1px solid black; width: 20px; height: 20px;"></td> </tr> <tr> <td>36</td><td>37</td><td>38</td><td>39</td><td>40</td><td>41</td><td>42</td><td>43</td><td>44</td><td>45</td><td>46</td> </tr> <tr> <td style="border: 1px solid black; width: 20px; height: 20px;"></td> <td style="border: 1px solid black; width: 20px; height: 20px;"></td> <td style="border: 1px solid black; width: 20px; height: 20px;"></td> <td style="border: 1px solid black; width: 20px; height: 20px;"></td> <td style="border: 1px solid black; width: 20px; height: 20px;"></td> <td style="border: 1px solid black; width: 20px; height: 20px;"></td> <td style="border: 1px solid black; width: 20px; height: 20px;"></td> <td style="border: 1px solid black; width: 20px; height: 20px;"></td> <td style="border: 1px solid black; width: 20px; height: 20px;"></td> <td style="border: 1px solid black; width: 20px; height: 20px;"></td> <td style="border: 1px solid black; width: 20px; height: 20px;"></td> </tr> <tr> <td>47</td><td>48</td><td>49</td><td>50</td><td>51</td><td>52</td><td>53</td><td>54</td><td>55</td><td>56</td><td>57</td> </tr> <tr> <td style="border: 1px solid black; width: 20px; height: 20px;"></td> <td style="border: 1px solid black; width: 20px; height: 20px;"></td> <td style="border: 1px solid black; width: 20px; height: 20px;"></td> <td style="border: 1px solid black; width: 20px; height: 20px;"></td> <td style="border: 1px solid black; width: 20px; height: 20px;"></td> <td style="border: 1px solid black; width: 20px; height: 20px;"></td> <td style="border: 1px solid black; width: 20px; height: 20px;"></td> <td style="border: 1px solid black; width: 20px; height: 20px;"></td> <td style="border: 1px solid black; width: 20px; height: 20px;"></td> <td style="border: 1px solid black; width: 20px; height: 20px;"></td> <td style="border: 1px solid black; width: 20px; height: 20px;"></td> </tr> <tr> <td>58</td><td>59</td><td>60</td><td>61</td><td>62</td><td>63</td><td>64</td><td>65</td><td>66</td><td>67</td> </tr> <tr> <td style="border: 1px solid black; width: 20px; height: 20px;"></td> <td style="border: 1px solid black; width: 20px; height: 20px;"></td> <td style="border: 1px solid black; width: 20px; height: 20px;"></td> <td style="border: 1px solid black; width: 20px; height: 20px;"></td> <td style="border: 1px solid black; width: 20px; height: 20px;"></td> <td style="border: 1px solid black; width: 20px; height: 20px;"></td> <td style="border: 1px solid black; width: 20px; height: 20px;"></td> <td style="border: 1px solid black; width: 20px; height: 20px;"></td> <td style="border: 1px solid black; width: 20px; height: 20px;"></td> <td style="border: 1px solid black; width: 20px; height: 20px;"></td> <td style="border: 1px solid black; width: 20px; height: 20px;"></td> </tr> </table> <p>Data Status Codes: (Blank) Correct (1) Derived error (2) Non-correctable error (3) Correctable error (4) Change—no error (7) Incorrect edit override (8) MDE error (9) Unknown coded</p>	a	b	c	d	e	f	g	h	i										3	4	5	6	7	8	9	10	11	12	13												14	15	16	17	18	19	20	21	22	23	24												25	26	27	28	29	30	31	32	33	34	35												36	37	38	39	40	41	42	43	44	45	46												47	48	49	50	51	52	53	54	55	56	57												58	59	60	61	62	63	64	65	66	67											
a	b	c	d	e	f	g	h	i																																																																																																																																														
3	4	5	6	7	8	9	10	11	12	13																																																																																																																																												
14	15	16	17	18	19	20	21	22	23	24																																																																																																																																												
25	26	27	28	29	30	31	32	33	34	35																																																																																																																																												
36	37	38	39	40	41	42	43	44	45	46																																																																																																																																												
47	48	49	50	51	52	53	54	55	56	57																																																																																																																																												
58	59	60	61	62	63	64	65	66	67																																																																																																																																													
<p>IF THIS CDS VEHICLE WAS NOT INSPECTED OR IF THIS WAS NOT A CDS VEHICLE, DO NOT COMPLETE AN EXTERIOR OR INTERIOR VEHICLE LOG</p>																																																																																																																																																						



CRASHPC PROGRAM SUMMARY

(All Measurements In Metric)

NATIONAL ACCIDENT SAMPLING SYSTEM
CRASHWORTHINESS DATA SYSTEM

Identifying Title

Primary Sampling Unit Case No.-Stratum Accident Event Sequence No. Date (Month, day, year) of Run

CRASHPC Vehicle Identification

Vehicle 1 _____

Vehicle 2 _____

Year Make Model NASS Veh. No.

GENERAL INFORMATION

VEHICLE 1		VEHICLE 2	
Size	_____	Size	_____
Weight	_____	Weight	_____
_____ + _____ + _____ = _____ kg		_____ + _____ + _____ = _____ kg	
Curb Occupant(s) Cargo		Curb Occupant(s) Cargo	
CDC	_____	CDC	_____
PDOF (-180 to +180)	± _____ °	PDOF (-180 to +180)	± _____ °
Stiffness	_____	Stiffness	_____

SCENE INFORMATION

Rest and Impact Positions No, Go To Damage Information Yes

VEHICLE 1		VEHICLE 2	
Rest Position	X _____ m	Rest Position	X _____ m
	Y _____ m		Y _____ m
	PSI _____ °		PSI _____ °
Impact Position	X _____ m	Impact Position	X _____ m
	Y _____ m		Y _____ m
	PSI _____ °		PSI _____ °
Slip Angle(-180 to +180)	_____ °	Slip Angle (-180 to +180)	_____ °

VEHICLE MOTION

Sustained Contact No Yes

VEHICLE 1		VEHICLE 2	
Vehicle Rotation	<input type="checkbox"/> No <input type="checkbox"/> Yes	Vehicle Rotation	<input type="checkbox"/> No <input type="checkbox"/> Yes
Rotation Stop Before Rest	<input type="checkbox"/> No <input type="checkbox"/> Yes	Rotation Stop Before Rest	<input type="checkbox"/> No <input type="checkbox"/> Yes
End of Rotation Position	X _____ m	End of Rotation Position	X _____ m
	Y _____ m		Y _____ m
	PSI _____ °		PSI _____ °
Curved Path	<input type="checkbox"/> No <input type="checkbox"/> Yes	Curved Path	<input type="checkbox"/> No <input type="checkbox"/> Yes
Point on Path	X _____ m Y _____ m	Point on Path	X _____ m Y _____ m
Rotation Direction	<input type="checkbox"/> None <input type="checkbox"/> CW <input type="checkbox"/> CCW	Rotation Direction	<input type="checkbox"/> None <input type="checkbox"/> CW <input type="checkbox"/> CCW
Rotation >360°	<input type="checkbox"/> No <input type="checkbox"/> Yes	Rotation >360°	<input type="checkbox"/> No <input type="checkbox"/> Yes

National Accident Sampling System-Crashworthiness Data System: CRASHPC Program Summary

FRICTION INFORMATION	TRAJECTORY INFORMATION
Coefficient of Friction _____ Rolling Resistance Option _____ Vehicle 1 Rolling Resistance LF _____ RF _____ LR _____ RR _____ Vehicle 2 Rolling Resistance LF _____ RF _____ LR _____ RR _____	Trajectory Data <input type="checkbox"/> No <input type="checkbox"/> Yes <i>If No, Go To Damage Information</i> Vehicle 1 Steer Angles LF _____ ° RF _____ ° LR _____ ° RR _____ ° Vehicle 2 Steer Angles LF _____ ° RF _____ ° LR _____ ° RR _____ ° Terrain Boundary <input type="checkbox"/> No <input type="checkbox"/> Yes First Point X _____ m Y _____ m Second Point X _____ m Y _____ m Secondary Coefficient of Friction _____

DAMAGE INFORMATION			
	VEHICLE 1		VEHICLE 2
Damage Length	L _____ cm	Damage Length	L _____ cm
Crush Depths	C ₁ _____ cm	Crush Depths	C ₁ _____ cm
	C ₂ _____ cm		C ₂ _____ cm
	C ₃ _____ cm		C ₃ _____ cm
	C ₄ _____ cm		C ₄ _____ cm
	C ₅ _____ cm		C ₅ _____ cm
	C ₆ _____ cm		C ₆ _____ cm
Damage Offset	D ± _____ cm	Damage Offset	D ± _____ cm

IF THIS COMMON IMPACT WAS WITH A MOTOR VEHICLE NOT IN TRANSPORT, FILL IN THE INFORMATION BELOW.

Model Year: _____
 Make: _____
 Model: _____
 VIN: _____

The Weight, CDC, Scene Data and Damage Information for this vehicle should be recorded above.

Complete and ATTACH the appropriate vehicle damage sketch and dimensions to the Form.



OLDMISS PROGRAM SUMMARY

(All Measurements In Metric)

Identifying Title			
_____ Primary Sampling Unit	_____ Case No.-Stratum	_____ Accident Event Sequence No.	_____ Date (Month, day, year) of Run

OLDMISS Vehicle Identification			
Vehicle 1	_____	_____	_____
Vehicle 2	_____ Year	_____ Make	_____ Model
			NASS Veh. No.

GENERAL INFORMATION

VEHICLE 1	VEHICLE 2
Size _____	Size _____
Weight _____ + _____ + _____ = _____ kg Curb Occupant(s) Cargo	Weight _____ + _____ + _____ = _____ kg Curb Occupant(s) Cargo
Damaged Area of Vehicle (F = Front, L = Left, R = Right, B = Back) _____ Vehicle 1	Damaged Area of Vehicle (F = Front, L = Left, R = Right, B = Back) _____ Vehicle 2
Vehicle Heading Angles At Impact, in Degrees + _____ ° Vehicle 1	Vehicle Heading Angles At Impact, in Degrees + _____ ° Vehicle 2
Stiffness Category for Vehicle _____ Vehicle 1	Stiffness Category for Vehicle _____ Vehicle 2

DAMAGE INFORMATION

For Which Vehicle Is The Damage Known _____	Crush Measurements Known Vehicle
PDOF for Known Vehicle in Degrees (-180 to +180) ± _____ °	C ₁ _____ cm
Damage Length (L) for Known Vehicle _____ cm	C ₂ _____ cm
	C ₃ _____ cm
	C ₄ _____ cm
	C ₅ _____ cm
	C ₆ _____ cm
	Damage Midpoint Offset for Known Vehicle D ± _____ cm
	Estimated Damage Midpoint Offset for Unknown Vehicle D ± _____ cm

Variable Name: Vehicle Number

Element Values:

Range: 01 through 30

Code the number assigned to this vehicle

Source: Police report.

Remarks:

Numbers assigned to vehicles must be consecutive starting with "01" and no numbers can be missing . Each in-transport motor vehicle must be assigned a unique number. Vehicle numbers are to be assigned consecutively according to the order NASS vehicles are listed on the PAR. If there are any NASS vehicles not listed on the PAR, then use the next consecutive number.

When one motor vehicle is towing another, the vehicle number or numbers assigned depends on the accident circumstances and the type of linkage between the vehicles. A fixed linkage is defined as one which has the property of keeping the towed unit separated from the power unit by a distance which is essentially constant. Included within this definition are cradle linkages where the towed unit has two or more wheels off the ground. A nonfixed linkage (such as a rope or a chain) requires the towed unit to be manually controlled.

If the linkage between the units is fixed, assign a vehicle number to the power (i.e., towing) unit only and consider the towed unit as cargo throughout the entire accident sequence, regardless of subsequent events/impacts sustained by the towed unit. In other words, a vehicle towed by a fixed linkage: (1) is never considered as an in-transport vehicle, (2) will not require vehicle forms, and (3) will be considered as cargo associated with the power unit.

If the linkage between the units is nonfixed, each vehicle is considered to be in-transport, and a vehicle number is assigned only to the vehicle(s) involved in the accident sequence.

Do not assign a vehicle number to any struck motor vehicle not in-transport (e.g., a vehicle parked off the roadway). Vehicle and occupant forms are not required for these vehicles. However, the vehicle is shown on the accident diagram and referred to as P-1, etc. Also, data which may be required to exercise the CRASH program are collected. The necessary data questions are located at the bottom of the second page of the CRASHPC Program Summary.

Variable Name: Vehicle Model Year

Element Values:

Range: 00 through 95

Code the last two digits of the model year
99 Unknown

Source: Primary source is the VIN during vehicle inspection; secondary sources include the police report and interviews.

Remarks:

Code the last two digits of the model year for which the vehicle was manufactured. A vehicle manufactured as a 1995 model is coded "95".

Code "99" (Unknown) if the vehicle model year cannot be determined.

Variable Name: Vehicle Make (specify):

Element Values:

Passenger Vehicles/Light Trucks (01-69)

	<u>GV06</u> <u>Subpage</u>		<u>GV06</u> <u>Subpage</u>
01 American Motors	1st	30 Volkswagen	(22)
02 Jeep (includes Kaiser-Jeep)	(2)	31 Alfa Romeo	(23)
03 AM General	(2)	32 Audi	(23)
06 Chrysler	(3)	33 Austin/Austin Healey	(24)
07 Dodge	(4)	34 BMW	(24)
08 Imperial	(6)	35 Nissan/Datsun	(25)
09 Plymouth	(7)	36 Fiat	(26)
10 Eagle	(8)	37 Honda	(27)
12 Ford	(9)	38 Isuzu	(28)
13 Lincoln	(11)	39 Jaguar	(29)
14 Mercury	(12)	40 Lancia	(29)
18 Buick	(13)	41 Mazda	(30)
19 Cadillac	(14)	42 Mercedes Benz	(31)
20 Chevrolet	(15)	43 MG	(32)
21 Oldsmobile	(17)	44 Peugeot	(32)
22 Pontiac	(18)	45 Porsche	(33)
23 GMC	(19)	46 Renault	(33)
24 Saturn	(20)	47 Saab	(34)
25 Grumman	(20)	48 Subaru	(34)
29 Other domestic: GV06 =	(21)	49 Toyota	(35)
001 - Studebaker/Avanti		50 Triumph	(36)
002 - Checker		51 Volvo	(37)
398 - Other automobile (i.e., DeSoto Hudson, Packard)		52 Mitsubishi	(38)
		53 Suzuki	(39)
		54 Acura	(40)
		55 Hyundai	(40)
		56 Merkur	(40)
		57 Yugo	(41)
		58 Infiniti	(41)
		59 Lexus	(41)
		60 Daihatsu	(42)
		61 Sterling	(42)
		69 Other foreign	(43)

Motored Cycle/ATC/ATV (70-79)

	<u>GV06</u> <u>Subpage</u>		<u>GV06</u> <u>Subpage</u>
70 BSA	(44)	78 Other make moped	(44)
71 Ducati	(44)	79 Other Motored Cycle	(44)
72 Harley-Davidson	(44)		
73 Kawasaki	(44)	Also see: [34] - BMW	(24)
74 Moto-Guzzi	(44)	[37] - Honda	(27)
75 Norton	(44)	[50] - Triumph	(36)
76 Yamaha	(44)	[53] - Suzuki	(39)

Medium/Heavy Trucks and Buses (80-89)

	<u>GV06</u> <u>Subpage</u>	Also see:	<u>GV06</u> <u>Subpage</u>
80 Brockway	(46)		
81 Diamond Reo/Reo	(46)		
82 Freightliner/White	(46)	[03] AM General	(2)
83 FWD	(46)	[07] Dodge	(5)
84 International	(45)	[12] Ford	(10)
Harvester/Navistar		[20] Chevrolet	(16)
85 Kenworth	(46)	[23] GMC	(19)
86 Mack	(46)	[25] Grumman	(20)
87 Peterbilt	(46)	[35] Nissan/Datsun	(25)
88 Iveco/Magirus	(46)	[36] Fiat	(26)
98 Other Make GV06 =	(46)	[38] Isuzu	(28)
801 - Autocar		[42] Mercedes Benz	(31)
802 - Auto-Union-DKW		[51] Volvo	(37)
803 - Divco		[52] Mitsubishi	(38)
804 - Western Star			
805 - Oshkosh			
806 - Hino			
807 - Scania			
850 - Truck based motorhome			
898 - Other truck (e.g., Ward LaFrance, Marmon)			
902 - NeoPlan (bus)			
950 - Bus based motorhome			
988 - Other bus			
998 - Other vehicle (i.e., farm vehicle, go-kart)			
99 Unknown			

Source: Vehicle inspection, police report, and interview

Remarks:

Write the Vehicle Make in the available space for ready visual reference.

Code "99" (Unknown) is used for a "hit-and-run" vehicle unless reliable evidence indicates the vehicle's make.

Variable Name: Vehicle Model (specify):

Element Values:

MAKE "01"

AMERICAN MOTORS*

CODE	MODEL	INCLUDES	YEAR	SIZE	STIFFNESS
001	Rambler/American	Rogue, Scrambler, 220, 440	all	3	3
002	Rebel/Matador	Barcelona, Classic Brougham, 550, 660, 770 Matador (-78), Marlin	all	114" WB = 4 118" WB = 5	4 5
003	Ambassador	Brougham, DPL, SST, DL, Limited, 880, 990	all	5	5
004	Pacer	Limited, DL	75-80	2	2
005	AMX	(2 seater only)	68-70	2	2
006	Javelin	SST, AMX (71-74)	all	2	2
007	Hornet/Concord	Sportabout, Limited, DL, SC-360, SST, AMX (75-78)	all	2	2
008	Spirit/Gremlin	Limited, DL, Custom, X, GT (83-on) AMX (79-on)	all	2	2
009	Eagle	Concord based	80-87	3	3
010	Eagle SX-4	Spirit/Gremlin based	81-84	2	2
398	Other automobile		-	-	-
399	Unknown automobile				
999	Unknown vehicle		-	-	-

* Alliance, Encore, Premier--See Renault - Make "46"

Variable Name: Vehicle Model (specify): [cont'd.]

MAKE "02" JEEP (Includes KAISER-JEEP)

CODE	MODEL	INCLUDES	YEAR	SIZE	STIFFNESS
401	CJ-2/CJ-3/CJ-4	Military	-66	81" WB = 1 101" WB = 2	7** 7**
402	CJ-5/CJ-6/CJ-7/CJ8	Scrambler, Golden Eagle, Renegade, Laredo, Wrangler	67-on	84" WB = 1 104" WB = 3	7**
403	YJ-series	Wrangler	86-on	1	7**
404	Cherokee	Limited, Laredo, Pioneer, Briarwood Grand	84-on 92-on	2 2	7** 7**
421	Cherokee	Wide Track, Chief, Commando, Jeepster	-83	2	7**
431	Grand Wagoneer	Custom, Brougham Limited, Wagoneer	71-91	2 3	7** 7**
481	Pickup	J-10, J-20, Honcho	all	per WB	7**
482	Comanche	Chief	86-92	111" WB = 3 119" WB = 4	7** 7**
498	Other light truck		-	-	-
499	Unknown light truck		-	-	-
999	Unknown vehicle		-	-	-

** Applies to front and rear impacts. Use size value for side impacts.

MAKE "03" AM GENERAL

CODE	MODEL	INCLUDES	YEAR	SIZE	STIFFNESS
401	Dispatcher	Post Office (Jeep)	all	1	1
421	Hummer		93-on	N/A	N/A
466	Dispatcher	DJ-series-Post Office Van	all	N/A	N/A
498	Other light truck		-	-	-
499	Unknown light truck		-	-	-
884	Medium/heavy truck	Military off-road	-	-	-
898	Other medium/heavy truck		-	-	-
899	Unknown medium/heavy truck		-	-	-
983	Bus-flat front, rear engine	Transit	all	N/A	N/A
988	Other bus		all	N/A	N/A
999	Unknown vehicle		-	-	-

Variable Name: Vehicle Model (specify): [cont'd.]

MAKE "06"

CHRYSLER

CODE	MODEL	INCLUDES	YEAR	SIZE	STIFFNESS
009	Cordoba	Crown, 300, LS	75-83	4	4
010	New Yorker/Newport/ 5th Avenue/Imperial	Custom, Royal, Brougham, Town and Country, 300 (-71) (excludes all FWD)	-78 79-81 82-89	6 5 4	6 5 4
014	New Yorker/E Class/ Imperial (90-93)/ 5th Avenue	FWD vehicles, Turbo	83-93	3	9***
015	Laser	Turbo, XE, XT	84-86	2	9***
016	LeBaron	Medallion, Salon (RWD), Landau, LX FWD except GTS or GTC Sport Coupe	77-81 82-on	4 2	4 9***
017	LeBaron GTS/GTC	GTS-Turbo GTC-Sport Coupe	85-on 87-on	3 2	9*** 9***
031	TC (Maserati Sport)	Turbo Convertible	88-91	1	1
035	Conquest	TS1, Turbo	87-89	2	2
041	Concorde		93-on	4	4
042	LHS	New Yorker (94-on)	94-on	4	9***
398	Other automobile		-	-	-
399	Unknown automobile				
441	Town and Country	Minivan	90-on	5	7**
498	Other light truck				
499	Unknown light truck				
999	Unknown vehicle		-	-	-

*** Code 9 applies only to frontal impacts. Use size code for stiffness for side or rear impacts.

Variable Name: Vehicle Model (specify): [cont'd.]

MAKE "07"

DODGE

CODE	MODEL	INCLUDES	YEAR	SIZE	STIFFNESS
001	Dart	Custom, Swinger, Sport, GT, Demon, Special, Special Edition, 170, 270, 340, 360	62-70 71-76	111" WB = 4 108" WB = 3	4 3
002	Coronet/Charger (-78)/ Magnum	Brougham, Custom, Superbee, Crestwood, Deluxe, XE, R/T, SE 440, 500, Police	-79	4	4
003	Polara/Monaco Royal Monaco	Custom, Special, Crestwood, Brougham, Police, Taxi	-76 77-78	5 4	5 4
004	Viper	RT/10	92-on	2	2
005	Challenger	R/T, T/A, Rallye	70-74	3	3
006	Aspen	Custom, Special Edition, Police, R/T, Sport	76-80	113" WB = 4 109" WB = 3	3 3
007	Diplomat	Medallion, Salon, S	77-89	4	4
008	Omni/Charger (83 on)	024, DeTomaso, Miser, GLH, GLHS Shelby, Charger 2.2, America, Expo	78-90	2	2
009	Mirada		80-83	4	4
010	St. Regis	Police, Taxi	79-81	5	5
011	Aries (K)	Custom, SE, LE	81-89	2	9***
012	400	LS	82-83	2	9***
013	Rampage (car based pickup)	2.2, GT, Sport	82-84	2	2
014	600	ES, Turbo	83-88	2	9***
015	Daytona	Turbo Z, Shelby Z, Pacifica, C/S Competition, IROC R/T	84-on	2	9***
016	Lancer	Pacifica, Turbo, ES, Shelby	85-89	3	9***
017	Shadow	ES, Turbo	87-on	2	9***
018	Dynasty		88-on	-	-
019	Spirit	ES, Shelby, R/T	89-on	3	9***
020	Neon		94-on	3	9***
033	Challenger	all imported	78-83	2	2
034	Colt (excludes Vista)	RS, Turbo, Custom, GTS, DL, E, Premier, Deluxe, Carousel, GT	74-76 77-80 80-on	2 <93" WB = 1 1	2 1 1
035	Conquest	Turbo	84-86	2	2

*** Code 9 applies only to frontal impacts. Use size code for stiffness for side or rear impacts.

Variable Name: Vehicle Model (specify): [cont'd.]

MAKE "07"

DODGE (Continued)

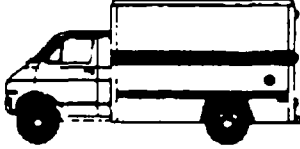
CODE	MODEL	INCLUDES	YEAR	SIZE	STIFFNESS
039	Stealth		91-on	2	2
040	Monaco		90-92	3	3
041	Intrepid		93-on	4	4
398	Other automobile		-	-	-
399	Unknown automobile				
401	Raider	Sport	86-on	1	8**
421	Ramcharger		all	3	8**
441	Vista	4 x 4	84-91	3	7**
442	Caravan	Mini-Ram, 112 and 119 WB, SE, ES	84-on	112" WB = 4 119" WB = 5	7** 7**
461	B-series vans	Sportsman, Royal, Maxiwagon, Ram B150-B350, Tradesman	all	7	7**
470	Van derivative	Kary Van	all	7	7**
					
Parcel Van					
471	D50, Colt P/U Ram 50/Ram 100		-82 83-on	per WB per WB	8** 8**
472	Dakota		87-on	112" WB = 3 124" WB = 6	8**
481	D, W-series pickup	Ram, Custom, Royal, Miser, D100-D350, W100-W350	all	per WB	8**
482	Ram 1500/2500/3500 P/U		94-on	per WB	8**
498	Other light truck		-	-	-
499	Unknown light truck				

Variable Name: Vehicle Model (specify): [cont'd.]

MAKE "07"

DODGE (Continued)

CODE	MODEL	INCLUDES	YEAR	SIZE	STIFFNESS
881	Medium/Heavy: CBE		all	N/A	N/A
882	Medium/Heavy: COE low entry		all	N/A	N/A
883	Medium/Heavy: COE high entry		all	N/A	N/A
884	Medium/Heavy: Unknown engine location		all	N/A	N/A
890	Medium/Heavy: COE entry position unknown		all	N/A	N/A
898	Other medium/heavy truck		all	N/A	N/A
899	Unknown medium/heavy truck		all	N/A	N/A
981	Medium bus	(not van based)	all	N/A	N/A
988	Other bus		all	N/A	N/A
998	Other vehicle				
999	Unknown vehicle		-	-	-

MAKE "08"

IMPERIAL

CODE	MODEL	INCLUDES	YEAR	SIZE	STIFFNESS
010	Imperial	Lebaron Mark Cross, Frank Sinatra editions	-76 81-83	6 4	6 4
398	Other automobile		-	-	-
399	Unknown automobile				
999	Unknown vehicle		-	-	-

** Applies to front and rear impacts. Use size value for side impacts.

*** Code 9 applies only to frontal impacts. Use size code for stiffness for side or rear impacts.

Variable Name: Vehicle Model (specify): [cont'd.]

MAKE "09"

PLYMOUTH

CODE	MODEL	INCLUDES	YEAR	SIZE	STIFFNESS
001	Valiant/Duster (-76)/ Scamp	100, 200, Brougham, Signet Custom, Special 340/360, 340, 360, Twister	-76	108" WB = 3 111" WB = 4	3 4
002	Satellite/Belvedere	Belvedere I/II, GTX, Roadrunner (-74), Sebring, Sebring Plus, Superbird, Brougham	-74	4	4
003	Fury	I, II, III, Roadrunner (75), Salon, VIP, Sport, Suburban	-74 75-78	5 4	5 4
004	Gran Fury	Sedan, Brougham, Custom Sport, Suburban	75-81 82-89	5 4	5 4
005	Barracuda	Formula, S, 340, AAR, 'Cuda Gran Coupe	65-73	3	3
006	Volare'	Custom, Premier, Roadrunner (76-on), Police	76-80	109" WB = 3 113" WB = 4	3 4
007	Caravelle	Turbo, SE	85-89	3	9***
008	Horizon	TC-3, Miser, Turismo 2.2, Custom, SE, Duster (85-on) America, Expo	78-90	2	2
011	Reliant (K)	SE, LE	81-89	2	9***
013	Scamp (car based pickup)	GT, 2.2	82-84	2	2
017	Sundance	Turbo	87-on	2	9***
019	Acclaim	LX, LE	89-on	3	9***
020	Neon		94-on	3	9***
031	Cricket		71-72	2	2
032	Arrow	Fire Arrow, GS, GT	76-80	1	1
033	Sapparo	all imported	78-83	2	2
034	Champ/Colt (excludes Vista)	Turbo, Custom - Station Wagon (84-on)	79-on 84-on	1 103" WB = 3	1 2
035	Conquest	TSI	84-89	2	2
036	CHANGED TO CODE 037 IN 1990				
037	Laser	RS, Turbo	89-on	2	2
398	Other automobile		-	-	-
399	Unknown automobile				

*** Code 9 applies only to frontal impacts. Use size code for stiffness for side or impacts.

Variable Name: Vehicle Model (specify): [cont'd.]

MAKE "09" PLYMOUTH (Continued)

CODE	MODEL	INCLUDES	YEAR	SIZE	STIFFNESS
421	Trailduster		all	3	8**
441	Vista	4 x 4	87-on	3	7**
442	Voyager (minivan)	SE, LX	84-on	112" WB = 4 119" WB = 5	7** 7**
461	Van-fullsize (B-series)	Voyager, Sport, Premier	all	7	7**
471	Arrow pickup (foreign)		all	per WB	8**
498	Other light truck		-	-	-
499	Unknown light truck		-	-	-
999	Unknown vehicle		-	-	-

MAKE "10" EAGLE

CODE	MODEL	INCLUDES	YEAR	SIZE	STIFFNESS
034	Summit	DL, LX, ES	89-on	3	3
037	Talon	TSI	90-on	2	2
040	Premier	LX, ES	88-92	3	3
041	Vision		93-on	4	4
044	Medallion	DL, LX	88-90	3	3
398	Other automobile		88-on	-	-
399	Unknown automobile				
441	Summit Wagon		92-on	99.2" WB = 2	7**
498	Other light truck				
499	Unknown light truck				
999	Unknown vehicle		-	-	-

** Applies to front and rear impacts. Use size for side impacts.

Variable Name: Vehicle Model (specify): [cont'd.]

MAKE "12"

FORD

CODE	MODEL	INCLUDES	YEAR	SIZE	STIFFNESS
001	Falcon	Sprint, GT, Futura	thru-70	4	3
002	Fairlane	Torino thru 1970	thru-70	4	4
003	Mustang/Mustang II	Mach, Boss, Grande, Cobra Ghia, SVO, GT, LX, Shelby	65-73 74-on	3 2	3 2
004	Thunderbird (all sizes)	Landau, Heritage, Turbo coupe, Elan, Fila SC, Sport, LX	72-76 58-71, 77-79 55-57, 80-88 89-on	5 4 3 4	6 4 3 4
005	LTD II	S, Squire, Brougham	77-79	4	4
006	LTD/Custom/Galaxie (all sizes)	XL, Landau, Ranch Wagon, Country Squire, S, 500, Brougham, XL, GT	thru-77 78-82 83-86	5 4 3	5 4 3
007	Ranchero	Falcon/Fairlane based Torino/LTD II based	thru-71 72-79	3 4	3 4
008	Maverick	Grabber	70-77	3	3
009	Pinto	Pony, MPG, ESS	71-80	1	1-Front 2-Rear
010	Torino/Gran Torino/Elite	GT, Cobra, Sport, Squire, Brougham	71-76	4	4
011	Granada	ESS, Ghia	75-82	3	3
012	Fairmont	Futura, Sport Coupe	78-83	3	3
013	Escort/EXP	L, GL, GLX, SS, GT, LX	81-on	1	9***
015	Tempo	L, GL, GLX, Sport, 4 x 4	84-on	2	9***
016	Crown Victoria		81-on	4	4
017	Taurus	MT-5, L, GL, LX, SHO	86-on	3	3
018	Probe	GL, LX, GT	88-on	2	2
031	English Ford	Cortina		per WB	per WB
032	Fiesta	Sport, Ghia	78-80	1	1
033	Festiva		88-93	1	1
034	Laser		all	per WB	per WB
035	Contour		94-on	?	?
036	Aspire		94-on	1	1
398	Other automobile		-	-	-
399	Unknown automobile		-	-	-

*** Code 9 applies only to frontal impacts. Use size code for stiffness for side or rear impacts.

Variable Name: Vehicle Model (specify): [cont'd.]

MAKE "12"

FORD (Continued)

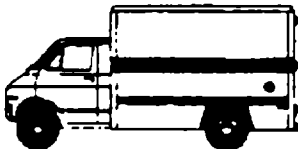
CODE	MODEL	INCLUDES	YEAR	SIZE	STIFFNESS
401	Bronco II/Bronco (-77)/ Explorer	Eddie Bauer, XL, XLT, Explorer (90-on)	83-on	1	{**
421	Bronco-fullsize	Eddie Bauer, Custom, XL, XLT	78-on	3	{**
441	Aerostar	XLT, Cargo Van	85-on	7	{**
442	Windstar		94-on	?	'
461	E-series vans	Econoline, Clubwagon, Chateau, E150-E350	all	7	{**
470	Van derivative	i.e.:	all	7	{**
					
Parcel Van					
471	Ranger	Supercab, 4 x 4, STX, Splash	82-on	108" WB = 3 114" WB = 4	{** {**
472	Courier	Imported pickup	all	7	{**
481	F-series pickup	F100-F350	all	per WB	{**
498	Other light truck		-	-	
499	Unknown light truck				
881	Medium/Heavy CBE	F-5 through F-8, L-series, FT-series	all	N/A	N/A
882	Medium/Heavy COE low entry	C/CT series	all	N/A	N/A
883	Medium/Heavy COE high entry	C/CLT series	all	N/A	N/A
884	Medium/Heavy: Unknown engine location		all	N/A	N/A
890	Medium/Heavy: COE entry position unknown		all	N/A	N/A
898	Other medium/heavy truck		-	-	
899	Unknown medium/heavy truck		-	-	
981	Medium bus	B-series (not van based)	all	N/A	N/A
988	Other bus		all	N/A	N/A
998	Other vehicle		-	-	
999	Unknown vehicle		-	-	

** Applies to front and rear impacts. Use size value for side impacts.

Variable Name: Vehicle Model (specify): [cont'd.]

MAKE "13"

LINCOLN

CODE	MODEL	INCLUDES	YEAR	SIZE	STIFFNESS
001	Continental/Town Car	Continental (-81), Town Car (82-on)	thru-79 80-on	6 4	6 5
002	Mark	I, II, III, IV, V LSC, all Signature/Designer Series VI VII VIII	-70 71-80 80-83 84-on 93-on	4 5 4 3 4	4 5 4 3 4
005	Continental (82-on)	All Signature/Designer Series	82-87 88-on	4 3	5 3
011	Versailles		77-80	3	3
398	Other automobile		-	-	-
399	Unknown automobile				
999	Unknown vehicle		-	-	-

Variable Name: Vehicle Model (specify): [cont'd.]

MAKE "14" MERCURY (MERKUR: See "56")

CODE	MODEL	INCLUDES	YEAR	SIZE	STIFFNESS
002	Cyclone	GT, CJ, Spoiler	thru-71	4	4
003	Capri-domestic	RS, Turbo, GS, Black Magic	79-86	2	2
004	Cougar/XR7	XR-7, RS, LS, GS, Eliminator, Bougham, Villager, (includes all body styles)	67-76 77-79 80-88 89-on	4 114" WB = 4 118" WB = 5 3 4	4 4 5 3 4
006	Marquis/Monterey	Marauder, X-100, Parklane, S-55, Custom, Brougham, Montclair, Grand Marquis	thru-78 79-82 82-on	121" WB = 5 124" WB = 6 4 106" WB = 3 114" WB = 4	5 6 4 3 4
008	Comet	Caliente, GT, Voyager, 202, Capri (65-67)	62-67 71-77	4 3	4 3
009	Bobcat	Runabout, Villager	75-80	1	1-Front 2-Rear
010	Montego	Comet (68-70), GT, MX, Villager, Brougham	68-73 72-76	3 114" WB = 3 118" WB = 4	3 3 4
011	Monarch	Ghia	75-80	3	3
012	Zephyr	GS, Z-7	78-83	3	3
013	Lynx/LN-7 (82-83)	L, LS, GS, RS, XR-3	81-87	1	9***
015	Topaz	L, LS, GS, 4 x 4	84-on	2	9***
017	Sable	LS, GS	86-on	3	3
031	Capri - foreign	Capri II 2 + 2	70-77 89-on	2 1	2 1
033	Pantera	deTomaso	72-74	2	2
036	Tracer	L, GL	88-on	1	1
037	Mystique		94-on	?	?
398	Other automobile		-	-	-
399	Unknown automobile				
443	Villager	LS, GS	93-on	4	7
999	Unknown vehicle		-	-	-

*** Code 9 applies only to frontal impacts. Use size code for stiffness for side or rear impacts.

Variable Name: Vehicle Model (specify): [cont'd.]

MAKE "18"

BUICK

CODE	MODEL	INCLUDES	YEAR	SIZE	STIFFNESS
001	Special/Skylark	GS, GS-350, GS-400, GS-455, GS California, Sport wagon, Custom	thru 72	4	4
002	LeSabre/Centurion/ Wildcat	Estate Wagon, Luxus, Invicta, Custom, Limited T-Type	-76 77-85 86-on	6 4 4	6 4 9***
003	Electra/Electra 225/ Park Avenue (91-on)	Limited, Park Avenue, Ultra	-76 77-84 85-on	6 5 4	6 5 9***
004	Roadmaster	Estate Wagon, Limited	91-on	4	4
005	Riviera	S-Type, T-Type	63-65 66-76 77-85 86-93 94-on	4 5 4 3 4	4 5 4 9*** 9***
007	Century	Luxus, T-Type, FWD (82-on) Custom, Regal (72-77)	thru 77 78-81 82-on	4 3 3	4 3 9***
008	Apollo/Skylark*	Skylark (75)*, S/R	73-76	4	4
010	Regal	Turbo, Luxus, Grand National, GNX, T-Type	78-88	3	3
012	Skyhawk	S-Type, Roadhawk, T-Type, GT	75-81 82-on	2 2	2 9***
015	Skylark (76-85)	(except 75), S/R, S, Limited, Sport, T-Type	76-79 80-85	4 3	4 9***
018	Somerset/Skylark**	Skylark (86-on)**, Somerset, GS Regal, Custom, Limited, T-Type	85-on	3	9***
020	Regal (FWD)	Limited	88-on	3	9***
021	Reatta		88-91	2	2
031	Opel Kadett		-75	2	2
032	Opel Manta	1900, Luxus, Rallye, Sports Coupe	-75	2	2
033	Opel GT		-75	2	2
034	Opel Isuzu	Deluxe, Sport	76-79	1	1
398	Other automobile		-	-	-
399	Unknown automobile		-	-	-
999	Unknown vehicle		-	-	-

*** Code 9 applies only to frontal impacts. Use size code for stiffness for side or rear impacts.

Variable Name: Vehicle Model (specify): [cont'd.]

MAKE "19"

CADILLAC

CODE	MODEL	INCLUDES	YEAR	SIZE	STIFFNESS
003	Deville/Fleetwood (except Limousine)	Coupe de Ville, Sedan de Ville, Fleetwood Bougham, Fleetwood 60 Special, d'Elegance	-76 RWD 77-on FWD 85-on	6 5 4	6 5 9***
	Deville	Concourse	94-on	4	9***
004	Limousine	Fleetwood 75, Formal DeVilIe-based	all	6	6
005	Eldorado	Biarritz, El-doro, Touring Coupe	-78 79-85 86-on	6 4 3	6 4 9***
006	Commercial Series	Ambulance/Hearse	all	6	6
009	Allante'		87-on	2	2
014	Seville	Elegante STS	76-85 86-on	4 3	4 9***
016	Cimarron	D'oro	82-88	2	9***
398	Other automobile		-	-	-
399	Unknown automobile				
999	Unknown vehicle		-	-	-

*** Code 9 applies only to frontal impacts. Use size code for stiffness for side or rear impacts.

Variable Name: Vehicle Model (specify): [cont'd.]

MAKE "20"

CHEVROLET

CODE	MODEL	INCLUDES	YEAR	SIZE	STIFFNESS
001	Chevell/Malibu	Classic, Concours, S-3, Laguna, Nomad, 300, Greenbriar, Estate, Deluxe, SS 396/454	64-77 78-83	4 3	4 3
002	Impala/Caprice	Biscayne, Belair, Super Sport, Classic, Classic Brougham, Townsman, Brookwood, Kingswood	-76 77-on	5 4 St. Wgn.=6	5 6 4
004	Corvette	Stingray	53-62 63-on	3 2	3 2
006	Corvair	Monza, Corsa, 500, Yenko	60-69	N/A	N/A
007	El Camino	Royal Knight, SS	59-60 64-77 78-on	5 4 3	8** 8** 8**
008	Nova (-79)	Chevy II, LN, LE, Concours SS-350/396, Rally	62-79	4	4
009	Camaro	SS, RS, LT, Berlinetta, IROC-2, Z28	67-on	3	3
010	Monte Carlo (RWD only)	LS, SS, Aerocoupe, Landau	70-77 78-88	4 3	4 3
011	Vega	GT, Cosworth	71-77	2	2
012	Monza	Spyder, 2 + 2, Towne Coupe	75-80	2	2
013	Chevette	S, Scooter, CS	76-87	2dr-1 4dr-2	1 2
015	Citation	X-11, Citation II	80-85	3	9***
016	Cavalier	CS, RS, Z24	82-on	2	9***
017	Celebrity	CS, Eurosport, VR	82-on	3	9***
019	Beretta/Corsica	GT	88-on	3	9***
020	Lumina	Z-34, Euro	90-on	3	9***
031	Spectrum		85-on	1	1
032	Nova/Geo Prizm	CL, NUMMI-built vehicle	85-on	2	9**
033	Sprint/Geo Sprint		85-on	1	1
034	Geo Metro	LSi, XFi	89-on	1	1
035	Geo Storm	GSi	85-on	1	1
036	Monte Carlo (FWD only)		95-on	3	9***
398	Other automobile		-	-	-
399	Unknown automobile				

** Applies to front and rear impacts. Use size value for side impacts.

*** Code 9 applies only to frontal impacts. Use size code for stiffness for side or rear impacts.

Variable Name: Vehicle Model (specify): [cont'd.]

MAKE "20"

CHEVROLET (Continued)

CODE	MODEL	INCLUDES	YEAR	SIZE	STIFFNESS
401	S-10 Blazer	S-10 p/u based (100.5" WB)	83-on	2	7**
402	Geo Tracker	LSi	89-on	2	8**
421	Fullsize Blazer	K-series, fullsized p/u based	69-on	3	8**
431	Suburban	All models	all	6	8**
441	Astro Van	Minivan	85-on	7	7**
442	Lumina APV		90-on	3	7*
461	G-series van	Beauville, Chevy Van, Sport Van, G10-G30	all	7	7**
466	P-series van		all	7	7**
470	Van derivative	Hi-cube, Parcel Van	all	7	7**
471	S-10/T-10	4 X 4	82-on	per WB	8**
472	LUV	Imported pickup	all	7	7**
481	C, K, R, V-series pickup	C10-C30, K10-K30, R10-R30, V10-V30, Silverado	all	per WB	8**
498	Other light truck		-	-	-
499	Unknown light truck				
881	Medium/Heavy CBE	C50/60/65; M60/65; H70/80/90; J70/80/90; Bison 90; all other CBE	all	N/A	N/A
882	Medium/Heavy COE low entry	T60/65 - all other COE low entry	all	N/A	N/A
883	Medium/Heavy COE high entry	Titan 90, all other COE high entry	all	N/A	N/A
884	Medium/Heavy: Unknown engine location		all	N/A	N/A
890	Medium/Heavy: COE entry position unknown		all	N/A	N/A
898	Other medium/heavy truck	-	all	N/A	N/A
899	Unknown medium/heavy truck				
981	Bus	S-60 series	all	N/A	N/A
988	Other bus		all	N/A	N/A
998	Other vehicle				
999	Unknown vehicle	-	-	-	-

* Applies to front impacts. Do not CRASH side or rear impacts.

** Applies to front and rear impacts. Use size value for side impacts.

Variable Name: Vehicle Model (specify): [cont'd.]

MAKE "21"

OLDSMOBILE

CODE	MODEL	INCLUDES	YEAR	SIZE	STIFFNESS
001	Cutlass (RWD-only)	Supreme, S, LS, Salon Brougham, Vista Cruiser, F85 (thru 72) Rallye 350, Hurst Olds, 442, Calais, Classic (88)	-77 78-88	4 3	4 3
002	Delta 88	Royale, Custom, Delta, Jetstar 88, Delmont 88, Starfire (thru 66), Custom Cruiser	-76 77-85 86-on	6 4 4	6 4 9***
003	Ninety-Eight	Regency, Luxury	-76 77-84 85-on	6 5 4	6 5 4
005	Toronado	XSR, Trofeo, Brougham Custom	66-78 79-85 86-92	5 4 3	5 4 3
006	Commercial Series	Ambulance/Hearse	all	6	6
012	Starfire	SX, GT	75-80	2	2
015	Omega		RWD 75-79 FWD 80-85	4 3	4 9
016	Firenza	S, LS, SX, Cruiser, GT	82-88	2	9***
017	Ciera	Cutlass Ciera, Brougham, ES	82-on	3	9***
018	Calais	GT, ES, 500	85-91	3	9***
020	Cutlass (FWD)	Supreme	88-on	3	9***
021	Achieva	SC	92-on	3	9***
022	Aurora		94-on	4	9***
398	Other automobile		-	-	-
399	Unknown automobile				
401	Bravada		91-on	2	7**
441	Silhouette		90-on	3	7*
498	Other light truck				
499	Unknown light truck				
998	Other vehicle				
999	Unknown vehicle		-	-	-

* Applies to front impacts. Do not CRASH side or rear impacts.

** Applies to front and rear impacts. Use size value for side impacts.

*** Code 9 applies only to frontal impacts. Use size code for stiffness for side or rear impacts.

Variable Name: Vehicle Model (specify): [cont'd.]

MAKE "22"

PONTIAC

CODE	MODEL	INCLUDES	YEAR	SIZE	STIFFNESS
001	Lemans/Tempest (thru 79)	Safari, T-37, Luxury, Grand Sport, GTO (-73), GT-37, Sprint, Judge Grand AM (73-75) Grand Lemans	thru 77 78-79	4 3	4 3
002	Bonneville/Catalina/ Parisienne	Brougham, Grand Safari, Safari, Grandville, 2+2 Executive, Starchief SE, SSE, SSEi	-68 69-76 77-81 82-84 87-on 83-84	5 6 4 3 4 4	5 6 4 3 4 4
005	Fiero	2M4, 2M6, GT, SE	84-88	1	1
008	Ventura	11, SJ, Sprint, GTO (74-on) Custom	71-77	4	4
009	Firebird/Trans AM	Esprit, Formula, GTA, Redbird, Yellowbird, Skybird, SE	67-81 82-on	3 2	3 2
010	Grand Prix (RWD)	J, LJ, SJ, Brougham, 2+2	63-72 73-77 78-87	5 4 3	5 4 3
011	Astre	Safari, SJ, Custom	75-77	2	2
012	Sunbird (thru 80)	Safari, Sport, Formula	76-80	2	2
013	T-1000/1000		81-87	2dr-1 4dr-2	1 2
015	Phoenix	LJ, SJ	77-79 80-84	4 3	4 9***
016	J2000/2000/Sunbird	Sunbird (84-on), LE, SE, GT, Convertible	82-on	2	9***
017	6000	STE, SE, LE	82-on	3	9***
018	Grand AM	SE, LE	80 85-on	3 3	3 9***
020	Grand Prix (FWD)	SE, McLaren Turbo, GTP	88-on	3	9***
031	Lemans (88-on)	SE, Tempest (Canadian)	88-on	2	2
398	Other automobile		-	-	-
399	Unknown automobile				
441	Trans Sport		90-on	3	7*
498	Other light truck		-	-	-
499	Unknown light truck				
999	Unknown vehicle		-	-	-

* Applies to front impacts. Do not CRASH side or rear impacts.

*** Code 9 applies only to frontal impacts. Use size code for stiffness for side or rear impacts.

Variable Name: Vehicle Model (specify): [cont'd.]

MAKE "23"

GMC

CODE	MODEL	INCLUDES	YEAR	SIZE	STIFFNESS
007	Caballero/Sprint	Sierra Madre del Sur, SP	-77 78-on	4 3	8** 8**
398	Other automobile		-	-	-
399	Unknown automobile				
401	Jimmy/Typhoon	S15 based (100.5" WB)	83-on	2	7**
421	Fullsize Jimmy/Yukon	fullsize pickup based	all	3	8**
431	Suburban	all models	all	6	8**
441	Safari (Minivan)		86-on	7	7**
461	G-series van	Rally Van, Vandura, G15-G35	all	7	7**
466	P-series van				
470	Van derivative	Hicube, parcel van, Value Van, Magna Van	all	7	7**
471	S15/T15/Sonoma	4 X 4, Syclone	82-on	per WB	8**
481	C, K, R, V-series pickup	C15-C35, K15-K35, R15-R35, V15-V35, Sierra	all	7	7**
498	Other light truck	-	-	-	-
499	Unknown light truck				
881	Medium/Heavy CBE	W5000/6000/7000 series, Brigadier/General models	all	N/A	N/A
882	Medium/Heavy COE low entry	W6000/W7000, all other COE, low entry	all	N/A	N/A
883	Medium/Heavy COE high entry	Astro 95, all other COE, high entry	all	N/A	N/A
884	Medium/Heavy: Unknown engine location		all	N/A	N/A
890	Medium/Heavy: COE entry position unknown		all	N/A	N/A
898	Other medium/heavy truck	-	all	N/A	N/A
899	Unknown medium/heavy truck				
981	Bus	B6000	all	N/A	N/A
988	Other bus		all	N/A	N/A
999	Unknown vehicle		-	-	-

** Applies to front and rear impacts. Use size value for side impacts.

Variable Name: Vehicle Model (specify): [cont'd.]

MAKE "24"

SATURN

CODE	MODEL	INCLUDES	YEAR	SIZE	STIFFNESS
001	SL	SL1, SL2, SL3	91-on	3	3
002	SC	SC1, SC2	91-on	2	2
003	SW	SW1, SW2	93-on	3	3
398	Other automobile		-	-	-
399	Other automobile				
999	Unknown		-	-	-

** Applies to front and rear impacts. Use size value for side impacts.

MAKE "25"

GRUMMAN

CODE	MODEL	INCLUDES	YEAR	SIZE	STIFFNESS
441	LLV	Postal vehicle (See NATB Chevrolet for VIN)	all	N/A	N/A
442	Step-in van	Multi-stop, step van	all	N/A	N/A
498	Other light truck		-	-	-
499	Unknown light truck		-	-	-
881	Medium/heavy truck - CBE		-	-	-
882	Medium/heavy truck - COE low entry		-	-	-
883	Medium/heavy truck - COE high entry		-	-	-
884	Medium/heavy truck unknown engine location		-	-	-
890	Medium/heavy truck entry position unknown		-	-	-
898	Other medium/heavy - other		-	-	-
899	Unknown medium/heavy truck		-	-	-
983	Bus-flat front, rear engine	Transit	all	N/A	N/A
988	Other bus		all	N/A	N/A
999	Unknown vehicle		-	-	-

Variable Name: Vehicle Model (specify): [cont'd.]

MAKE "29"

OTHER DOMESTIC MANUFACTURERS

CODE	MODEL	INCLUDES	YEAR	SIZE	STIFFNESS
001	Studebaker	Lark, Gran Turismo, Hawk, Cruiser, all associated subseries	thru-66	per WB	= size
	Avanti		all	per WB	= size
002	Checker	Marathon, Superba, Taxi, Aerobus	thru-82	per WB	= size
398	Other make	Desoto, Excaliber, Stutz, Hudson, Packard, Consulier	all	per WB	= size
399	Unknown make				

Variable Name: Vehicle Model (specify): [cont'd.]

MAKE "30"

VOLKSWAGEN

CODE	MODEL	INCLUDES	YEAR	SIZE	STIFFNESS
031	Karmann Ghia		-74	1	1
032	Beetle 1300/1500	flat windshield, 94.5" WB	-77	1	1
033	Super Beetle	distinguished by curved windshield, 95.3" WB	71-80	2	1
034	411/412	Squareback/Fastback	71-74	2	1
035	Squareback/Fastback	Type 3, 1600	-74	1	1
036	Rabbit	L, GTI, Sport, LS, Custom, DL, Deluxe	75-84	1	1
037	Dasher		74-81	2	2
038	Scirocco	16V	75-88	1	1
040	Jetta	GL, GLI	81-92	2	2
041	Quantum	Synco	82-88	2	2
042	Golf	Synco, GTI, Cabriolet, GT, GL	85-92	2	1
043	Rabbit pickup	car/based pickup	80-83	1	1
044	Fox	GL	87-on	1	1
045	Corrado		89-on	2	2
046	Passat		90-on	2	2
047	Jetta III		93-on	2	2
048	Golf III		93-on	2	2
398	Other automobile		-	-	-
399	Unknown automobile		-	-	-
401	The Thing (181)		73-75	1	1
441	Vanagon/Camper	Bus, Kombi, Van	-89	1	7**
442	Eurovan		92-on	-	-
498	Other light truck		-	-	-
499	Unknown light truck				
998	Other vehicle				
999	Unknown vehicle		-	-	-

** Applies to front and rear impacts. Use size value for side impacts.

Variable Name: Vehicle Model (specify): [cont'd.]

MAKE "31"

ALFA ROMEO

CODE	MODEL	INCLUDES	YEAR	SIZE	STIFFNESS
031	Spider	All roadsters, Veloce, 1750/2000 roadsters	all	1	1
032	Sports Sedan	All 4 door sedans; Milano (86), Giulia, Super, Berlina, Alfetta, 1750/2000 sedans	all	per WB	= size
033	Sprint Veloce	All 2-door coupes; Alfetta GT, 1750/2000 GTV, Sprint GT	all	per WB	= size
034	GTV-6		81-on	1	1
035	164		89-on	3	3
398	Other automobile		-	-	-
399	Unknown automobile				
999	Unknown vehicle		-	-	-

MAKE "32"

AUDI

CODE	MODEL	INCLUDES	YEAR	SIZE	STIFFNESS
031	Super 90		70-72	2	2
032	100	S, LS, GL Quattro (89-on)	70-77 89-on	3 3	3 3
033	Fox		74-79	2	2
034	4000	Quattro, Coupe GT, CS, S	80-	2	2
035	5000	Quattro, CS, S, Turbo	78-	3	3
036	80 90	Quattro Quattro	88-92 88-on	2 2	2 2
037	200	Quattro	89-92	3	3
038	V-8 Quattro		90-on	3	3
039	Coupe Quattro		90-on	2	2
040	S4		93-on	3	3
041	Cabriolet		94-on	2	2
398	Other automobile		-	-	-
399	Unknown automobile				
999	Unknown vehicle		-	-	-

Variable Name: Vehicle Model (specify): [cont'd.]

MAKE "33"

AUSTIN/AUSTIN HEALEY

CODE	MODEL	INCLUDES	YEAR	SIZE	STIFFNESS
031	Marina	GT	all	2	2
032	America		all	1	1
033	Healey Sprite		all	1	1
034	Healy 3000	Healy 100	all	1	1
035	Mini		all	1	1
398	Other automobile		-	-	-
399	Unknown automobile				
999	Unknown vehicle		-	-	-

MAKE "34"

BMW

CODE	MODEL	INCLUDES	YEAR	SIZE	STIFFNESS
031	1600, 2002	T11, 1800, 2000CS	-76	2	2
032	Coupe	2800CS, 3.0CS	69-76	3	3
033	Bavaria Sedan	2500, 2800	69-74	3	3
034	3-series	318i, 320i, 325e, 325es, 325i, M3	77-on	2	2
035	5-series	524i, 528i, 530i, 533i, 535i, TD 525i (wagon), M5	75-on 93-on	3 3	3 3
036	6-series	630, 633, 635, csi, M6	77-on	3	3
037	7-series	733i, 735i, L7, 740i	78-on	3	3
038	8-series	850	90-on		
398	Other automobile		-	-	-
399	Unknown automobile				
	<u>Motorcycles</u>				
701	0-50cc				
702	51-124cc				
703	125-349cc				
704	350-449cc				
705	450-749cc				
706	750cc-over				
709	Unknown cc				
799	Unknown motored cycle				
999	Unknown vehicle				

Variable Name: Vehicle Model (specify): [cont'd.]

MAKE "35"

NISSAN/DATSUN

CODE	MODEL	INCLUDES	YEAR	SIZE	STIFFNESS
031	F10		77-78	1	1
032	200/240 SX		78-83 84-on	1 2	1 2
033	1200/210/B210	Honeybee	71-82	1	1
034	Z-car, ZX	240/260/280Z, 300 ZX, Turbo 2 + 2 2 + 2	70-on 75-78 79-on	1 3 2	1 3 2
035	310		79-82	1	1
036	510	PL	68-73 78-81	2 1	2 1
037	610	PL	73-76	2	2
038	710	PL	74-77	2	2
039	810/Maxima		77-on	3	3
040	Roadster	SPL 311, SRL 311, 1600, 2000, convertible	-70	1	1
041	PL411, RL411		-67	1	1
042	Stanza	XE	82-92	2	2
043	Sentra		83-on	1	1
044	Pulsar	NX, EXA (86-on)	83-90	2	2
045	Micra		87-on	1	1
046	NX 1600/2000		92-on	2	2
047	Altima		93-on	2	2
398	Other automobile		-	-	-
399	Unknown automobile				
401	Pathfinder	MPV, 4 x 4	86-on	-	-
441	Van	XE, GXE	88-on	1	7**
442	Axxess		89-90	3	7**
443	Quest		93-on	4	7
471	Datsun/Nissan Pickup	PL620, King Cab, Hardbody	73-on	per WB	8**
498	Other light truck	Patrol (1960)	-	-	-
499	Unknown light truck				

** Applies to front and rear impacts. Use size values for side impacts.

Variable Name: Vehicle Model (specify): [cont'd.]

MAKE "35"

NISSAN/DATSUN (Continued)

CODE	MODEL	INCLUDES	YEAR	SIZE	STIFFNESS
883	Medium/Heavy COE high entry		all	N/A	N/A
898	Other medium/heavy truck		all	N/A	N/A
899	Unknown medium/heavy truck				
999	Unknown vehicle		-	-	-

MAKE "36"

FIAT

CODE	MODEL	INCLUDES	YEAR	SIZE	STIFFNESS
031	124 (Coupe/Sedan)	Sport	67-75	1	1
032	124 Spider/Racer	Spider 2000/1500	68-83	1	1
033	Brava - 131		75-82	2	2
034	850 (Coupe/Spyder)		67-73	1	1
035	128		72-79	2	2
036	X-1/9		75-83	1	1
037	Strada		79-83	2	2
398	Other automobile	600, 1100	-	-	-
399	Unknown automobile				
882	Medium/Heavy COE low entry		all	N/A	N/A
883	Medium/Heavy COE high entry		all	N/A	N/A
890	Medium/heavy COE entry position unknown		all	N/A	N/A
898	Other medium/heavy truck		all	N/A	N/A
899	Unknown medium/heavy truck				
999	Unknown vehicle		-	-	-

Variable Name: Vehicle Model (specify): [cont'd.]

MAKE "37" HONDA (ACURA: See "54")

CODE	MODEL	INCLUDES	YEAR	SIZE	STIFFNESS
031	Civic/CRX	1300, 1500, CVCC, DX, EX, VX CRX, S, Si, HF, 4WD Wagon	all	1	1
	del Sol		93-on	1	1
032	Accord	LX, CVCC, SE-i, LX-i, EX, EX wagon	-81 82-86 87-on	1 2 3	1 9*** 9***
033	Prelude	Si	80-83 84-on	1 2	1 9***
034	600	Coupe, Sedan	all	1	1
398	Other automobile	all Honda's not listed above	all	per WB	= size
399	Unknown automobile				
401	Passport		94-on	3	8**
498	Other light truck		-	-	-
499	Unknown light truck				
	<u>Motorcycle</u>				
701	0-50cc				
702	51-124cc				
703	125-349cc				
704	350-449cc				
705	450-749cc				
706	750cc or greater				
709	Unknown cc				
	<u>All Terrain Cycles/Vehicles</u>				
731	0-50cc	includes all ATCs/ATVs			
732	51-124cc	designed solely for			
733	125-249cc	off-road use.			
734	350cc or greater				
739	Unknown cc				
799	Unknown motored cycle				
999	Unknown vehicle		-	-	-

*** Code 9 applies only to frontal impacts. Use size code for stiffness for side or rear impacts.

Variable Name: Vehicle Model (specify): [cont'd.]

MAKE "38"

ISUZU

CODE	MODEL	INCLUDES	YEAR	SIZE	STIFFNESS
031	I-Mark	S, RS, Turbo	85-89	1	1
032	Impulse	Turbo, RS	84-on	2	2
033	Stylus		90-on	2	2
398	Other automobile		-	-	-
399	Unknown automobile				
401	Trooper/Trooper II	Deluxe, LS	84-on	2	7**
402	Rodeo		91-on	3	3**
403	Amigo		89-on	2	3**
471	P'up (pickup)	4 x 4	all	3	3**
498	Other light truck		-	-	-
499	Unknown light truck				
881	Medium/Heavy - CBE		all	N/A	N/A
882	Medium/Heavy COE low entry		all	N/A	N/A
883	Medium/Heavy COE high entry		all	N/A	N/A
884	Medium/Heavy unknown engine location		all	N/A	N/A
890	Medium/Heavy COE entry position unknown		all	N/A	N/A
898	Other medium/heavy truck		all	N/A	N/A
899	Unknown medium/heavy truck				
981	Conventional front engine				
982	Front engine/flat front				
983	Rear engine/flat front				
988	Other bus				
999	Unknown vehicle		-	-	-

** Applies to front and rear impacts. Use size value for side impacts.

Variable Name: Vehicle Model (specify): [cont'd.]

MAKE "39"

JAGUAR

CODE	MODEL	INCLUDES	YEAR	SIZE	STIFFNESS
031	XJ-S Coupe		76-on	3	3
032	XJ6/12 Sedan/Coupe	L, XJ, C, 340/420 Sedan	all	3	3
033	XKE	V12, Roadster, 120 2 + 2	all	2 3	3 3
398	Other automobile		-	-	-
399	Unknown automobile				
999	Unknown vehicle		-	-	-

MAKE "40"

LANCIA

CODE	MODEL	INCLUDES	YEAR	SIZE	STIFFNESS
031	Beta Sedan - HPE		-80	2	2
032	Beta Coupe - Zagato		-82	1	1
033	Scorpion		-78	1	1
398	Other automobile		-	-	-
399	Unknown automobile				
999	Unknown vehicle		-	-	-

Variable Name: Vehicle Model (specify): [cont'd.]

MAKE "41"

MAZDA

CODE	MODEL	INCLUDES	YEAR	SIZE	ST FFNESS
031	RX2		72-74	2	2
032	RX3		72-78	1	1
033	RX4		74-78	2	2
034	RX7	S, GS, GSL, SE	79-on	2	2
035	323/GLC/Protege	DX, Protege (90-on)	77-on	1	1
036	Cosmo		76-78	2	2
037	626	GT, GS, GSL, SE	79-on	2	2
038	808		72-77	1	1
039	Mizer		76	1	1
040	R-100		-72	1	1
041	616/618		-72	2	2
042	1800		-72	2	2
043	929		88-on	-	-
044	MX-6	Turbo	88-on	2	2
045	Miata		90-on	1	1
046	MX-3	GS	92-on	1	1
398	Other automobile		-	-	-
399	Unknown automobile				
401	Navajo		91-on	3	8**
441	MPV		89-on	3	7**
471	Mazda pickup	B-2000, B-2200, B-2600, SE-5, LX, Cab Plus, B-4000	all 94-on	per WB per WB	8** 8**
498	Other light truck		-	-	-
499	Unknown light truck				
999	Unknown vehicle		-	-	-

** Applies to front and rear impacts. Use size value for side impacts.

Variable Name: Vehicle Model (specify): [cont'd.]

MAKE "42"

MERCEDES BENZ

(Check "INCLUDES" comments carefully to determine proper code.)

CODE	MODEL	INCLUDES	YEAR	SIZE	STIFFNESS
031	200/220/230/240/250/260/ 280/300	Sedan and 5 passenger "C" only, SE, CD, D, SD, TD, TE, CE, E. <u>DOES NOT</u> include <u>280 SE</u> (75 on), <u>300 SD</u> - see code 037	all	3	3
032	230/280 SL	2 seater only	all	1	1
033	300/350/380/450/500 SL/ 560 SL	2 seater only, 300/500 SL (90-on)	all	2	2
034	350/380/420/450/560 SLC		all	4	4
035	280/300 SEL		all	4	4
036	380/420/450/500/560 SEL and 500/560 SEC/350 SDL/ 300 SDL		all	4	4
037	300 SE/380/450 SE	280 S, 280 SE (75 on), 300 SD Sedan/350 SD	all	4	4
038	600, 6.9 Sedan	Pullman	all	6	6
039	190	D, E, 2.3, 2.5	all	3	3
040	300	CE Cabriolet	93-on	3	3
041	400/500 E	SE	92-on	3	3
042	220/280 C		94-on	?	?
398	Other automobile		-	-	-
399	Unknown automobile				
470	Van derivative	Kurbstar	82-on	N/A	N/A
498	Other light truck		-	-	-
499	Unknown light truck				
881	Medium/Heavy - CBE		all	N/A	N/A
882	Medium/Heavy - COE low entry		all	N/A	N/A
883	Medium/Heavy - COE high entry		all	N/A	N/A
884	Medium/Heavy: Unknown engine location		all	N/A	N/A
890	Medium/Heavy: COE entry position unknown		all	N/A	N/A
898	Other medium/heavy		all	N/A	N/A
899	Unknown medium/heavy		-	-	-
981	Medium bus		all	N/A	N/A
988	Other bus		-	-	-
999	Unknown vehicle		-	-	-

Variable Name: Vehicle Model (specify): [cont'd.]

MAKE "43"

MG

CODE	MODEL	INCLUDES	YEAR	SIZE	STIFFNESS
031	Midget	MKIII, 1500	-79	1	1
032	MGB		76-79	1	1
033	MGB	GT	67-75	1	1
034	MGA		all	1	1
035	TA/TC/TD/TF		all	1	1
036	MGC	GT	-69	1	1
398	Other automobile	Sport Sedan	-	-	-
399	Unknown automobile				
999	Unknown vehicle		-	-	-

MAKE "44"

PEUGEOT

CODE	MODEL	INCLUDES	YEAR	SIZE	STIFFNESS
031	304		71-73	3	3
032	403		-67	3	3
033	404	Station Wagon	-70	3 4	3 4
034	504/505	STI, STX, Turbo, S, GL, GLS, Liberte Station Wagon	70-91	3 4	3 4
035	604	SL, D	77-84	3	3
036	405	Mi-16	89-91	3	9***
398	Other automobile		-	-	-
399	Unknown automobile				
	<u>Motorcycle</u>				
701	0-50cc				
702	51-124cc				
709	Unknown cc				
799	Unknown motored cycle				
999	Unknown vehicle		-	-	-

*** Code 9 applies only to frontal impacts. Use size code for stiffness for side or rear impact.

Variable Name: Vehicle Model (specify): [cont'd.]

MAKE "45"

PORSCHE

CODE	MODEL	INCLUDES	YEAR	SIZE	STIFFNESS
031	911	L, S, E, T, SC, Carrera, Slopenose, Speedster	all	1	1
032	912	E, T	-69	1	1
033	914	S, 1.8, 2.0, 914/6	70-76	2	2
034	924	Turbo, S	77-88	1	1
035	928	S	78-on	2	2
036	930	Turbo	79	1	1
037	944	Turbo, S	83-91	1	1
038	959		89-on	1	1
039	968		92-on	1	1
398	Other automobile	Spyder, Speedster, 356	-	-	-
399	Unknown automobile				
999	Unknown vehicle		-	-	-

MAKE "46"

RENAULT

CODE	MODEL	INCLUDES	YEAR	SIZE	STIFFNESS
031	LeCar	5	76-83	2	2
032	Dauphine/10/R-8/Caravelle	all models	thru-'71	1	1
033	12	R12L, R12TL	72-77	2	2
034	15	R15TL	73-76	2	2
035	16	R16	69-72	3	3
036	17	R17, Gordini Coupe, R17TL	73-80	2	2
037	R18i	Sportwagon	81-on	2	2
038	Fuego	TL, TS, GTL, GTS, Turbo	82-85	2	2
039	Alliance/Encore GTA, Convertible	L, DL, Limited, X-37	83-on	2	2
041	Alpine	GT	87-on	TBD	TBD
044	Medallion	DL, LX	87-only	3	3
045	Premier		87-only	3	3
398	Other automobile		-	-	-
399	Unknown automobile				
999	Unknown vehicle		-	-	-

Variable Name: Vehicle Model (specify): [cont'd.]

MAKE "47"

SAAB

CODE	MODEL	INCLUDES	YEAR	SIZE	STIFFNESS
031	99/99E/900	S, Turbo, Cabriolet	all	2	2
032	Sonnett	II, III, V-4	68-74	1	1
033	95/96/97		-73	2	2
034	9000	S, Turbo CS	85-on 93-on	3	3
398	Other automobile	Monte Carlo 850	-	-	-
399	Unknown automobile				
999	Unknown vehicle		-	-	-

MAKE "48"

SUBARU

CODE	MODEL	INCLUDES	YEAR	SIZE	STIFFNESS
031	DL/FE/G/GF/GL/GLF/STD/ Loyale	4 wheel drive, Turbo	72-89 90-on	per WB	= size
032	Star		70-71	2	2
033	360		69-70	1	1
034	Legacy		89-on	2	2
035	XT/XT6	4WD Turbo, convertible, DL	86-on	2	2
036	Justy	DL, GL	87-on	1	1
037	SVX		92-on	3	3
038	Impreza		93-on	2	2
043	Brat	DL, GL	78-on	2	2
398	Other automobile		-	-	-
399	Unknown automobile				
999	Unknown vehicle		-	-	-

GENERAL VEHICLE FORM

GV06
(35)

Variable Name: Vehicle Model (specify): [cont'd.]

MAKE "49"

TOYOTA

CODE	MODEL	INCLUDES	YEAR	SIZE	STIFFNESS
031	Corona	Mark II, Custom, 1900, 2000, Deluxe	-82	2	2
032	Corolla	1100, 1200, 1600, SR-5, LE, Deluxe, Custom, FX16	69-85 FWD 86-on	1 2	1 9***
033	Celica	1900, 2000, GT, ST, GTS	72-on	2	2
034	Supra	Celica Supra, Soarer	79-92	3	3
035	Cressida		78-92	3	3
036	Crown	2300, 2600	-71	3	3
037	Carina	2000	72-73	2	2
038	Tercel	Corolla Tercel, 4WD Wagon	80-on	2	2
039	Starlet		81-84	1	1
040	Camry	LE, Deluxe, XLE, Coupe	83-on	3	3
041	MR-2		85-on	1	1
042	Paseo		92-on	1	1
398	Other automobile	2000 GT Coupe (1960s)	-	-	-
399	Unknown automobile				
401	4-Runner		85-on	3	8**
421	Landcruiser		76-on	1	8**
441	Minivan Previa	LE, Cargo	84-90 91-on	1	7**
471	Pickup	SR-5, Extra Cab, Sport, LN44, Chinook, Wonder Wagon	74-on	per WB	8**
481	T-100		93-on	per WB	8**
498	Other light truck		-	-	-
499	Unknown light truck				
999	Unknown vehicle		-	-	-

** Applies to front and rear impacts. Use size value for side impacts.

*** Code 9 applies only to frontal impacts. Use size code for stiffness for side or rear impact.

Variable Name: Vehicle Model (specify): [cont'd.]

MAKE "50"

TRIUMPH

CODE	MODEL	INCLUDES	YEAR	SIZE	STIFFNESS
031	Spitfire	I, II, III, IV, 1500	-81	1	1
032	GT-6	MK3	67-73	1	1
033	TR4	TR2, TR3, TR4A	-68	1	1
034	TR6		69-76	1	1
035	TR7/8		75-81	1	1
036	Herald	Vitesse	-	-	-
037	Stag		71-73	2	2
398	Other automobile	2000, 1200 series	-	-	-
399	Unknown automobile				
	<u>Motorcycles</u>				
701	0-50cc				
702	51-124cc				
703	125-349cc				
704	350-449cc				
705	450-749cc				
706	750cc or greater				
709	Unknown cc				
799	Unknown motored cycle				
999	Unknown vehicle		-	-	

Variable Name: Vehicle Model (specify): [cont'd.]

MAKE "51"

VOLVO (Includes Volvo/White and Volvo/GM Heavy Trucks)

CODE	MODEL	INCLUDES	YEAR	SIZE	STIFFNESS
031	122	S	-68	3	3
032	142/144/145	S, E, GL, GLS, Deluxe	-74	3	3
033	164	S, E	69-75	3	3
034	240/242/244/245	DL, GL, GLE, GLT, Deluxe	75-on	3	3
035	262/264/265	GL	76-82	-	-
036	1800	E, S, ES	-73	2	2
038	760 780	GLE, Turbo	83-90 87-92	3 3	3 3
039	740	GLE, GT, Turbo, GL	86-92	3	3
040	940	GLE, Turbo, SE	91-on	3	3
041	960		92-on	3	3
042	850	GLT, Wagon	93-on	3	3
398	Other automobile		-	-	-
399	Unknown automobile				
881	Medium/Heavy CBE		all	N/A	N/A
882	Medium/Heavy COE low entry		all	N/A	N/A
883	Medium/Heavy COE high entry		all	N/A	N/A
884	Medium/Heavy: Unknown engine location		all	N/A	N/A
890	Medium/Heavy: COE entry position unknown		all	N/A	N/A
898	Other medium/heavy truck		all	N/A	N/A
899	Unknown medium/heavy truck		-	-	-
981	Medium bus		all	N/A	N/A
988	Other bus		all	N/A	N/A
999	Unknown vehicle		-	-	-

Variable Name: Vehicle Model (specify): [cont'd.]

MAKE "52"

MITSUBISHI

CODE	MODEL	INCLUDES	YEAR	SIZE	STIFFNESS
031	Starion	2 + 2, LE, Turbo	83-90	2	2
032	Tredia	L, LS, Turbo	83-88	2	2
033	Cordia	L, Turbo	83-88	2	2
034	Galant	ECS, Sigma (thru 88)	85-on	3	3
035	Mirage	L, Turbo	85-on	1	1
036	Precis		88-on	1	1
037	Eclipse		90-on	2	2
038	Sigma		89-90	3	3
039	3000GT		91-on	2	2
040	Diamante		92-on	3	3
398	Other automobile		-	-	-
399	Unknown automobile				
401	Montero	Sport	85-on	1	8**
441	Minivan	LS	87-on	1	7**
442	Expo Wagon	LRV, Sport	92-on	99.2" WB = 2 107.1" WB = 3	7** 7**
471	Pickup	Mighty Max, SPX, 4 x 4	all	3	8**
498	Other light truck		-	-	-
499	Unknown light truck				
882	Medium/Heavy - COE low entry	FUSD FE	all	N/A	N/A
898	Other medium/heavy truck		-	-	-
899	Unknown medium/heavy truck				
981	Conventional front engine				
982	Front engine/flat front				
983	Rear engine/flat front				
988	Other bus				
999	Unknown vehicle		-	-	-

** Applies to front and rear impacts. Use size value for side impacts.

Variable Name: Vehicle Model (specify): [cont'd.]

MAKE "53"

SUZUKI

CODE	MODEL	INCLUDES	YEAR	SIZE	STIFFNESS
031	SA310	GLX	86-on	1	1
034	Swift	GTi, GTX	89-on	1	1
398	Other automobile		-	-	-
399	Unknown automobile				
401	Samurai	Standard, Deluxe	85-on	1	8**
402	Sidekick		89-on	2	8**
498	Other light truck		-	-	-
499	Unknown light truck				
<u>Motorcycles</u>					
701	0-50cc				
702	51-124cc				
703	125-349cc				
704	350-449cc				
705	450-749cc				
706	750cc-over				
709	Unknown cc				
<u>All Terrain Cycles/Vehicles</u>					
731	0-50cc	includes all ATCs/ATVs designed solely for off-road use.			
732	51-124cc				
733	125-349cc				
734	350cc or greater				
739	Unknown cc				
799	Unknown motored cycle				
999	Unknown vehicle		-	-	-

** Applies to front and rear impacts. Use size value for side impacts.

Variable Name: Vehicle Model (specify): [cont'd.]

MAKE "54"

ACURA

CODE	MODEL	INCLUDES	YEAR	SIZE	STIFFNESS
031	Integra	RS, LS, GS	86-on	2	(***
032	Legend		86-on	3	(***
033	NSX		91-on		
034	Vigor		92-on	-	
398	Other automobile		-	-	
399	Unknown automobile				
999	Unknown vehicle		-	-	-

*** Code 9 applies only to frontal impacts. Use code for stiffness for side or rear impact.

MAKE "55"

HYUNDAI

CODE	MODEL	INCLUDES	YEAR	SIZE	STIFFNESS
031	Pony		84-88	2	2
032	Excel	GL, GLS	84-on	1	1
033	Sonata		89-on	3	3
034	Scoupe		91-on	1	1
035	Elantra		92-on	2	2
398	Other automobile		-	-	
399	Unknown automobile				
999	Unknown vehicle		-	-	-

MAKE "56"

MERKUR

CODE	MODEL	INCLUDES	YEAR	SIZE	STIFFNESS
031	XR4Ti	Turbo	85-89	3	3
032	Scorpio	Turbo	87-90	3	3
398	Other automobile		-	-	-
399	Unknown automobile				
999	Unknown vehicle		-	-	-

Variable Name: Vehicle Model (specify): [cont'd.]

MAKE "57"

YUGO

CODE	MODEL	INCLUDES	YEAR	SIZE	STIFFNESS
031	GV	GVX, Cabriolet	86-92	1	1
398	Other automobile		-	-	-
399	Unknown automobile				
999	Unknown vehicle		-	-	-

MAKE "58"

INFINITI

CODE	MODEL	INCLUDES	YEAR	SIZE	STIFFNESS
031	M30		90-92	3	3
032	Q45		90-on	4	4
033	G20		91-on	2	2
034	J30		93-on	3	3
398	Other automobile		-	-	-
399	Unknown automobile				
999	Unknown vehicle		-	-	-

MAKE "59"

LEXUS

CODE	MODEL	INCLUDES	YEAR	SIZE	STIFFNESS
031	ES-250/ES-300		90-on	3	3
032	LS-400		90-on	4	4
033	SC-300/SC-400	2-door Coupe	92-on	3	3
034	GS-300		94-on	3	3
398	Other automobile		-	-	-
399	Unknown automobile				
999	Unknown vehicle		-	-	-

Variable Name: Vehicle Model (specify): [cont'd.]

MAKE "60"

DAIHATSU

CODE	MODEL	INCLUDES	YEAR	SIZE	STIFFNESS
031	Charade		90-92	3	3
398	Other automobile		-	-	-
399	Unknown automobile				
401	Rocky		90-92		
498	Other light truck		-	-	-
499	Unknown light truck				
999	Unknown vehicle		-	-	-

MAKE "61"

STERLING

CODE	MODEL	INCLUDES	YEAR	SIZE	STIFFNESS
031	827S	Li	86-91	3	3
398	Other automobile		-	-	-
399	Unknown automobile		-	-	-
999	Unknown vehicle		-	-	-

Variable Name: Vehicle Model (specify): [cont'd.]

MAKE "69"

OTHER FOREIGN

CODE	MODEL	INCLUDES	YEAR	SIZE	STIFFNESS
031	Aston Martin	Lagonda, Vantage, Volante, Saloon	all	per WB	= size
032	Bricklin		all	per WB	= size
033	Citreon		all	per WB	= size
034	Delorean		all	per WB	= size
035	Ferrari		all	per WB	= size
036	Hillman		all	per WB	= size
037	Jensen	Healy	all	per WB	= size
038	Lamborghini	Countach 5000S, Jalpa	all	per WB	= size
039	Lotus	Europe, Esprit	all	per WB	= size
040	Maserati	Biturbo	all	per WB	= size
041	Morris	Minor	all	per WB	= size
042	Rolls Royce/Bentley	Cloud/shadow series	all	per WB	= size
043	Rover	Land Rover, Land Rover Defender 110	all	per WB	= size
044	Simca		all	per WB	= size
045	Sunbeam		all	per WB	= size
046	TVR		all	per WB	= size
048	Desta		all	per WB	= size
049	Reliant		all	per WB	= size
052	Bertone	X/19	all	per WB	= size
053	Lada		all	per WB	= size
054	KIA	Sephia	all	per WB	= size
398	Other make	Morgan, Singer	all	per WB	= size
399	Unknown make				

Variable Name: Vehicle Model (specify): [cont'd.]

Vehicle Classification: Motored Cycle/ATC/ATV

Variable GV05 Vehicle Make				Code	Variable GV06 Vehicle Model	Code
	<u>M</u>	<u>C</u>	<u>ATC</u>	<u>ATV</u>		
BMW	x				Motored Cycles 0-50cc	701
Honda	x	x	x	34	51-124cc	702
Peugeot	x			37	125-349cc	703
Triumph	x			44	350-449cc	704
Suzuki	x	x	x	50	450-749cc	705
BSA	x			53	750cc-or greater	706
Ducati	x			70	Unknown cc	709
Harley-Davidson	x			71	All Terrain Cycles/Vehicles	
Kawasaki	x	x	x	72	0-50cc	731
Moto-Guzzi	x		x	73	51-124cc	732
Norton	x			74	125-349cc	733
Yamaha	x	x	x	75	350cc or greater	734
Other make moped	x			76	Unknown cc	739
Other make motored cycle	x	x	x	78	Other motored cycle	798
Unknown make				79	Unknown motored cycle	799
				99		

Variable Name: Vehicle Model (specify): [cont'd.]

MAKE "84"

INTERNATIONAL HARVESTER/NAVISTAR

CODE	MODEL	INCLUDES	YEAR	SIZE	STIFFNESS
421	Scout	Scout II, Utility pickup, SS-2, Roadstar, 800 series, Traveler, Terra Traveltop	all	per WB	8**
431	Travelall	1010-1210, 100-200	all	per WB	8**
466	Multistop Van	Metro RM, 120-160, MS 1210, MS 1510	all	per WB	7**
481	Pickup	R-100-500, 900A-1500C/D, 1010-1510	all	per WB	8**
498	Other light truck		-	-	-
499	Unknown light truck				
850	Truck based motorhome		all	N/A	N/A
881	Medium Heavy - CBE	Loadstar/Fleetstar, Paystar, CBE Transtar, 4200, S-series Mixer	all	N/A	N/A
882	Medium/Heavy - COE low entry	CO, VCO, DCO, 190-1950, Cargostar, LFM, 5370 (Garbage)	all	N/A	N/A
883	Medium/Heavy - COE high entry	DCO, DCOI, UCO, VCOI, 405-series, COE Transtar, Unistar, Conco 707B, 9600	all	N/A	N/A
884	Medium/Heavy: Unknown engine location		all	N/A	N/A
890	Medium/Heavy: COE entry position unknown		all	N/A	N/A
898	Other medium/heavy truck	Fire truck - R140-R306, CO 8190	all	N/A	N/A
899	Unknown medium/heavy truck		-	-	-
950	Bus based motorhome		all	N/A	N/A
981	Conventional bus	R153-1853 - Loadstar, 1603-1853	all	N/A	N/A
982	Bus-flat front, front engine	173FC, 183FC	all	N/A	N/A
983	Bus-flat front, rear engine	183RE, 193RE-transit	all	N/A	N/A
988	Other bus		all	N/A	N/A
998	Other vehicle		-	-	-
999	Unknown vehicle		-	-	-

** Applies to front and rear impacts. Use size value for side impacts.

Variable Name: Vehicle Model (specify): [cont'd.]

Vehicle Classification: Medium/Heavy Trucks and Buses

Variable GV05 Vehicle Make	Code		Variable GV06 Vehicle Model	Code
	Truck	Bus		
			M/H truck based motorhome	850
AM General	x	x	Medium/Heavy - CBE	881
Dodge	x	x	Medium/Heavy - COE/low entry	882
Ford	x	x	Medium/Heavy - COE/high entry	883
Chevrolet	x	x	Medium/Heavy - Unknown engine location	884
GMC	x	x	Medium/Heavy - COE/entry position unknown	890
Grumman	x	x	Medium/Heavy - Other	898
Nissan/Datsun	x		Unknown medium/heavy truck	899
Fiat	x		Bus based motorhome	950
Isuzu	x	x	Bus - conventional front engine	981
Mercedes Benz	x	x	Bus - front engine/flat front	982
Volvo	x	x	Bus - rear engine/flat front	983
Mitsubishi	x		Other bus	988
Brockway	x		Unknown bus type	989
Diamond Reo/Reo	x		Unknown vehicle	999
Freightliner/White	x			
FWD	x			
International Harvester/Navistar	x	x		
Kenworth	x			
Mack	x			
Peterbilt	x			
Iveco/Magirus	x			
Other: (if code "98" is used for GV05, then GV06 must be 801-807, 850, 898, 902, 950, 988, or 998, irrespective of Body Type)		98	Autocar	801
			Auto-Union-DKW	802
			Divco	803
			Western Star	804
			Oshkosh	805
			Hino	806
			Scania	807
			Truck based motorhome	850
			Other truck: e.g., Marmon, Ward LaFrance, (specify)	898
			Neoplan (bus)	902
			Bus based motorhome	950
			Other bus	988
			Other vehicle	998

Variable Name: Vehicle Model (specify): [cont'd.]

Source: Vehicle inspection, police report, and interview.

Remarks:

For the purposes of the Model codes the following applies.

- 001 - 399 - Passenger vehicles
 - 398 - Other automobile
 - 399 - Unknown automobile

- 401 - 499 - Light trucks
 - 401 - 420 Compact utilities
 - 421 - 430 Large utilities
 - 431 - 440 Utility station wagons
 - 441 - 460 Minivans
 - 461 - 470 Large vans (includes step vans, van derivatives)
 - 471 - 480 Compact pickups
 - 481 - 490 Large pickups
 - 498 - Other light truck
 - 499 - Unknown light truck

- 701 - 799 - Motored Cycles/ATCs/ATVs
 - (701 - 706 motorcycles/mopeds)
 - 701 0-50cc
 - 702 51-124cc
 - 703 125-349cc
 - 704 350-449cc
 - 705 450-749cc
 - 706 750cc or greater
 - 709 Unknown cc

 - (731 - 739 ATCs/ATVs)
 - 731 0-50cc
 - 732 51-124cc
 - 733 125-349cc
 - 734 350cc or greater
 - 739 Unknown cc

 - 798 - Other motored cycle
 - 799 - Unknown motored cycle

- 801 - 899 - Medium/heavy trucks
 - 850 M/H truck based motorhome
 - 881 Medium/Heavy: CBE
 - 882 Medium/Heavy: COE low entry
 - 883 Medium/Heavy: COE high entry
 - 884 Medium/Heavy: Unknown engine location
 - 890 Medium/Heavy: COE entry position unknown
 - 898 Other medium/heavy truck
 - 899 Unknown medium/heavy truck

Variable Name: Vehicle Model (specify): [cont'd.]

Source: Vehicle inspection, police report, and interview.

Remarks:

901 - 989 - Buses

950 Bus based motorhome
981 Conventional front engine
982 Front engine/flat front
983 Rear engine/flat front
988 Other bus
989 Unknown bus type

998 - Other vehicle (i.e., farm vehicle, go-kart, etc.)

999 - Unknown vehicle

The stiffness codes assigned in GV06, Vehicle Model (specify):, are based upon either limited crash test data, wheelbase, or a correlation with vehicles currently listed in the CRASH3 manual. These assignments replace the vehicle assignments in "Table 8-2 Vehicle Stiffness Categories" in the "CRASH3 User's Guide and Technical Manual".

Variable Name: Vehicle Model (specify): [cont'd.]

MODEL CODES VERSUS CLASS OF VEHICLE AND BODY TYPE

Model Codes	Class of Vehicle Codes	Body Type Codes
AUTOMOBILES		
001-399	01-09	1 Convertible
001-399	01-09	2 2-door sedan, hardtop, coupe
001-399	01-09	3 3-door/2-door hatchback
001-399	01-09	4 4-door sedan, hardtop
001-399	01-09	5 5-door/4-door hatchback
001-399	01-09	6 Station wagon
001-399	01-09	7 Hatchback, number of doors unknown
001-399	01-09	8 Other automobile type (specify):
001-399	01-09	9 Unknown automobile type
AUTOMOBILE DERIVATIVES		
001-399	01-09	10 Auto based pickup
001-399	01-09	11 Auto based panel
001-399	01-09	12 Large limousine-more than four side doors or stretched chassis
001-399	01-09	13 Three-wheel automobile or automobile derivative
UTILITY VEHICLES (\leq 4,500 KGS GVWR)		
401-420, 498, 499	11	14 Compact utility
421-430, 498, 499	12	15 Large utility
431-440, 498, 499	12	16 Utility station wagon
401-420, 498, 499	11	19 Utility, unknown body type
VAN BASED LIGHT TRUCKS (\leq 4,500 KGS GVWR)		
441-460, 498, 499	13, 14	20 Minivan
461-470, 498, 499	13, 14	21 Large van
461-470, 498, 499	14	22 Step van or walk-in van ($<$ 4,500 kgs GVWR)
461-470, 498, 499	14	23 Van based motorhome ($<$ 4,500 kgs GVWR)
441-470, 498, 499	13	24 Van based school bus (\leq 4,500 kgs GVWR)
441-470, 498, 499	13	25 Van based other bus (\leq 4,500 kgs GVWR)
461-470, 498, 499	14	28 Other van type
499	13	29 Unknown van type
LIGHT CONVENTIONAL TRUCKS (PICKUP STYLE CAB, \leq 4,500 KGS GVWR)		
471-480, 498, 499	15	30 Compact pickup
481-490, 498, 499	15	31 Large pickup
471-490, 498, 499	15	32 Pickup with slide-in camper
471-490, 498, 499	15	33 Convertible pickup
499	15	39 Unknown pickup style light conventional truck type

Variable Name: Vehicle Model (specify): [cont'd.]

MODEL CODES VERSUS CLASS OF VEHICLE AND BODY TYPE

Model Codes	Class of Vehicle Codes	Body Type Codes
OTHER LIGHT TRUCKS (\leq 4,500 KGS GVWR)		
498	18	40 Cab chassis based
498	18	41 Truck based panel
498	18	42 Light truck based motorhome
498	18	45 Other light conventional truck type
499	19	48 Unknown light truck type
999	99	49 Unknown light vehicle type
BUSES (EXCLUDES VAN BASED)		
981-983, 988, 989	20	50 School bus
950, 981-983, 988, 989	21	58 Other bus type
981-983, 988, 989	21	59 Unknown bus type
MEDIUM/HEAVY TRUCKS (> 4,500 KGS GVWR)		
881-890, 898, 899	22	60 Step van (> 4,500 kgs GVWR)
881-890, 898, 899	22	61 Single unit straight truck (4,500 kgs < GVWR \leq 8,850 kgs)
881-890, 898, 899	22	62 Single unit straight truck (8,850 kgs < GVWR \leq 12,000 kgs)
881-890, 898, 899	22	63 Single unit straight truck (> 12,000 kgs GVWR)
881-890, 898, 899	22	64 Single unit straight truck (GVWR unknown)
850	22	65 Medium/heavy truck based motorhome
881-890, 898, 899	23	67 Truck-tractor with no cargo trailer
881-890, 898, 899	24	68 Truck-tractor pulling one trailer
881-890, 898, 899	24	69 Truck-tractor pulling two or more trailers
881-890, 898, 899	24	70 Truck-tractor (unknown if pulling trailer)
899	22	78 Unknown medium/heavy truck type
899	22	79 Unknown truck type (light/medium/heavy)
MOTORED CYCLES (DOES NOT INCLUDE ALL-TERRAIN VEHICLES/CYCLES)		
701-706, 709, 799	25	80 Motorcycle
701-706, 709, 799	25	81 Moped (motorized bicycle)
701-706, 709, 799	25	82 Three-wheel motorcycle or moped
798	25	88 Other motored cycle type (minibike, motorscooter)
799	25	89 Unknown motored cycle type
OTHER VEHICLES		
731-734, 739, 799	28	90 ATV (All-Terrain Vehicle) and ATC (All-Terrain Cycle)
998	28	91 Snowmobile
998	28	92 Farm equipment other than trucks
998	28	93 Construction equipment other than trucks
998	28	97 Other vehicle type
999	99	99 Unknown body type

Variable Name: Body Type

Element Values:

CDS APPLICABLE VEHICLES

Automobiles

- 01 Convertible (excludes sun-roof, t-bar)
- 02 2-door sedan, hardtop, coupe
- 03 3-door/2-door hatchback
- 04 4-door sedan, hardtop
- 05 5-door/4-door hatchback
- 06 Station wagon (excluding van and truck based)
- 07 Hatchback, number of doors unknown
- 08 Other automobile type (specify):
- 09 Unknown automobile type

Automobile Derivatives

- 10 Auto based pickup (includes El Camino, Caballero, Ranchero, Brat, and Rabbit pickup)
- 11 Auto based panel (cargo station wagon, auto based ambulance/hearse)
- 12 Large limousine - more than four side doors or stretched chassis
- 13 Three-wheel automobile or automobile derivative

Utility Vehicles (\leq 4,500 kgs GVWR)

- 14 Compact utility (Jeep CJ-2 - CJ-7, Scrambler, Golden Eagle, Renegade, Laredo, Wrangler, Cherokee [84 and after], Dispatcher, Raider, Bronco II, Bronco [76 and before], Explorer, S-10 Blazer, Geo Tracker, Bravada, S-15 Jimmy, Thing, Pathfinder, Trooper, Trooper II, Rodeo, Amigo, Navajo, 4-Runner, Montero, Samurai, Sidekick, Rocky)
- 15 Large utility (includes Jeep Cherokee [83 and before], Ramcharger, Trailduster, Bronco-fullsize [78 and after], fullsize Blazer, fullsize Jimmy, Landcruiser, Rover, Scout)
- 16 Utility station wagon (Chevy Suburban, GMC Suburban, Travelall, Grand Wagoneer, includes suburban limousine)
- 19 Utility, unknown body type

Van Based Light Trucks (\leq 4,500 kgs GVWR)

- 20 Minivan (Chrysler Town and Country, Caravan, Grand Caravan, Voyager, Grand Voyager, Mini-Ram, Dodge/Plymouth Vista, Aerostar, Lumina APV, Trans Sport, Silhouette, Astro, Villager, Safari, Toyota Van, Toyota Minivan, Previa, Nissan Minivan, Quest, Mitsubishi Minivan, Vanagon/Camper.)
- 21 Large van (B150-B350, Sportsman, Royal, Maxiwagon, Ram, Tradesman, Voyager [83 and before], E150-E350, Econoline, Clubwagon, Chateau, G10-G30, Chevy Van, Beauville, Sport Van, G15-G35, Rally Van, Vandura.)
- 22 Step van or walk-in van (\leq 4,500 kgs GVWR)
- 23 Van based motorhome (\leq 4,500 kgs GVWR)
- 24 Van based school bus (\leq 4,500 kgs GVWR)
- 25 Van based other bus (\leq 4,500 kgs GVWR)
- 28 Other van type (Hi-Cube Van, Kary) (specify):
- 29 Unknown van type

Variable Name: Body Type (cont'd.)

Light Conventional Trucks (Pickup style cab, \leq 4,500 kgs GVWR)

- 30 Compact pickup (D50, Colt P/U, Ram 50, Dakota, Arrow Pickup [foreign], Ranger, Courier, S-10, T-10, LUV, S-15, T-15, Sonoma, Datsun/Nissan Pickup, P'up, Mazda Pickup, Toyota Pickup, Mitsubishi Pickup)
- 31 Large Pickup (Jeep Pickup, Comanche, Ram Pickup, D100-D350, W100-W350, F100-F350, C10-C35, K10-K35, R10-R35, V10-V35, Silverado, Sierra, R100-R500,)
- 32 Pickup with slide-in camper
- 33 Convertible pickup
- 39 Unknown pickup style light conventional truck type

Other Light Trucks (\leq 4,500 kgs GVWR)

- 40 Cab chassis based (includes rescue vehicles, light stake, dump, and tow truck)
- 41 Truck based panel
- 42 Light truck based motorhome (chassis mounted)
- 45 Other light conventional truck type
- 48 Unknown light truck type
- 49 Unknown light vehicle type (automobile, utility, van, or light truck)

OTHER VEHICLESBuses (Excludes Van Based)

- 50 School bus (designed to carry students, not cross country or transit)
- 58 Other bus type (e.g., transit, intercity, bus based motorhome) (specify):
- 59 Unknown bus type

Medium/Heavy Trucks ($>$ 4,500 kgs GVWR)

- 60 Step van ($>$ 4,500 kgs GVWR)
- 61 Single unit straight truck (4,500 kgs $<$ GVWR \leq 8,850 kgs)
- 62 Single unit straight truck (8,850 kgs $<$ GVWR \leq 12,000 kgs)
- 63 Single unit straight truck ($>$ 12,000 kgs GVWR)
- 64 Single unit straight truck, GVWR unknown
- 65 Medium/heavy truck based motorhome
- 67 Truck-tractor with no cargo trailer
- 68 Truck-tractor pulling one trailer
- 69 Truck-tractor pulling two or more trailers
- 70 Truck-tractor (unknown if pulling trailer)
- 78 Unknown medium/heavy truck type
- 79 Unknown truck type (light/medium/heavy)

Motored Cycles (Does Not Include All-Terrain Vehicles/Cycles)

- 80 Motorcycle
- 81 Moped (motorized bicycle)
- 82 Three-wheel motorcycle or moped
- 88 Other motored cycle (minibike, motorscooter) (specify):
- 89 Unknown motored cycle type

Variable Name: Body Type (cont'd.)

Other Vehicles

- 90 ATV (All-Terrain Vehicle) and ATC (All-Terrain Cycle)
- 91 Snowmobile
- 92 Farm equipment other than trucks
- 93 Construction equipment other than trucks
- 97 Other vehicle type
- 99 Unknown body type

Source: Vehicle inspection, police report, and interview.

Remarks:

Automobiles

Codes "01"- "09" are used to describe different types of passenger cars. These light vehicles referred to as automobiles, are designed primarily to transport passengers.

- Code "01" [Convertible (excludes sun-roof, t-bar)] refers to a passenger car equipped with a removable or retractable roof. To qualify for this code, the entire roof must open. Convertible roofs are generally fabric; however, removable hardtops are also included. This code takes priority over 2-door (codes "02" and "03") or 4-door (codes "04" and "05") codes.
- Code "02" (2-door sedan, hardtop, coupe) refers to a passenger car equipped with two doors for ingress/egress and a separate trunk area for cargo (i.e., trunk lid hinged below the backlight). Folding rear seats do not necessarily violate the separate "trunk area" concept.
- Code "03" (3-door/2-door hatchback) refers to a passenger car equipped with two doors for ingress/egress and a rear hatch opening for cargo (i.e., hinged above the backlight). The cargo area is not permanently partitioned from the passenger compartment area.
- Code "04" (4-door sedan, hardtop) refers to a passenger car equipped with four doors for ingress/egress and a separate trunk area for cargo (i.e., trunk lid hinged below the backlight). Folding rear seats do not necessarily violate the separate "trunk area" concept.
- Code "05" (5-door/4-door hatchback) refers to a passenger car equipped with four doors for ingress/egress and a rear hatch opening for cargo (i.e., hinged above the backlight). The cargo area is not permanently partitioned from the passenger compartment area.

Variable Name: Body Type (cont'd.)

- Code "06" [Station wagon (excluding van and truck based)] refers to a passenger car with an enlarged cargo area. The entire roof covering the cargo area is generally equal in height from front to rear and full height side glass is installed between the C and D-pillars. The rearmost area is not permanently partitioned from the forward passenger compartment area (e.g., "horizontal window shades" to hide cargo do not constitute partitions).
- Code "07" (Hatchback, number of doors unknown) refers to a passenger car with an unknown number of doors for ingress/egress and a rear hatch opening for cargo (i.e., hinged above the backlight). The cargo area is not permanently partitioned from the passenger compartment area.
- Code "08" (Other automobile type) refers to any passenger car that cannot be described by elements "01" through "07" or "10" through "13".
- Code "09" (Unknown automobile type) is used when it is known that the vehicle is a passenger car, but there is insufficient data to determine the type.

Automobile Derivatives

Codes "10"- "13" are used to describe certain passenger cars that have been modified to perform cargo-related tasks.

- Code "10" [Auto based pickup (includes El Camino, Caballero, Ranchero, Brat, and Rabbit pickup)] refers to a passenger car based, pickup type vehicle. The roof area (and side glass) rearward of the front seats on a station wagon have been removed and converted into a pickup-type cargo box.
- Code "11" [Auto based panel (cargo station wagon, auto based ambulance/hearse)] refers an automotive station wagon that may have sheet metal rearward of the B-pillar rather than glass.
- Code "12" (Large limousine - more than four side doors or stretched chassis) refers to an automobile that has sections added within its wheelbase to increase length and passenger/cargo carrying capacity.
- Code "13" (Three-wheel automobile or automobile derivative) refers to three-wheel vehicles with an enclosed passenger compartment.

Utility Vehicles (\leq 4,500 kgs GVWR)

Codes "14" - "19" are used to describe multi-purpose vehicles (MPV) that are designed to have off-road capabilities. These vehicles are: generally four wheel drive (4 x 4), have increased ground clearance, and are equipped with a strong frame. Four wheel drive automobiles are not considered MPVs.

Variable Name: Body Type (cont'd.)

- Code "14" [Compact utility (Jeep CJ-2 - CJ-7, Scrambler, Golden Eagle, Renegade, Laredo, Wrangler, Cherokee [84 and after], Dispatcher, Raider, Bronco II, Bronco [76 and before], Explorer, S-10 Blazer, Geo Tracker, Bravada, S-15 Jimmy, Thing, Pathfinder, Trooper, Trooper II, Rodeo, Amigo, Navajo, 4-Runner, Montero, Samurai, Sidekick, Rocky)] refers to a short wheelbase and narrow tracked multi-purpose vehicle designed to operate in rugged terrain.
- Code "15" [Large utility (includes Jeep Cherokee [83 and before], Ramcharger, Trailduster, Bronco-fullsize [78 and after], fullsize Blazer, fullsize Jimmy, Landcruiser, Rover, Scout)] refers to fullsize multi-purpose vehicles primarily designed around a shortened pickup truck chassis. While generally a station wagon style body, some models are equipped with a removable top.
- Code "16" [Utility station wagon (Chevy Suburban, GMC Suburban, Travelall, Grand Wagoneer, includes suburban limousine)] refers primarily to a pickup truck based chassis enlarged to a station wagon.
- Code "19" (Utility, unknown body type) is used when it is known that the vehicle is a utility vehicle, but there is insufficient data to determine the specific type. Class of Vehicle (AC14) is coded "11" (Compact utility vehicle).

Van Based Light Trucks (\leq 4,500 kgs GVWR)

Codes "20"- "29" are used to describe light trucks (\leq 4,500 kgs GVWR) that are designed to maximize cargo/passenger area versus overall length. Basically a "box on wheels" these vehicles are identifiable by their enclosed cargo/passenger area and relatively short (or non-existent) hood.

- Code "20" [Minivan (Chrysler Town and Country, Caravan, Grand Caravan, Voyager, Grand Voyager, Mini-Ram, Dodge/Plymouth Vista, Aerostar, Lumina APV, Trans Sport, Silhouette, Astro, Safari, Toyota Van, Toyota Minivan, Previa, Nissan Minivan, Mitsubishi Minivan, Vanagon/Camper)] refers to down-sized cargo or passenger vans.
- Code "21" [Large van (B150-B350, Sportsman, Royal, Maxiwagon, Ram, Tradesman, Voyager [83 and before], E150-E350, Econoline, Clubwagon, Chateau, G10-G30, Chevy Van, Beauville, Sport Van, G15-G35, Rally Van, Vandura)] refers to a standard cargo or passenger van. These vans will generally have a larger capacity in both volume and GVWR.
- Code "22" [Step van or walk-in van (\leq 4,500 kgs GVWR)] refers to a multi-stop delivery vehicle with a GVWR less than or equal to 4,500 kilograms. Examples are the Grumman LLV used by the US Postal Service or the Aeromate manufactured by Utilimaster Motor Corporation.

Variable Name: Body Type (cont'd.)

Code "23" [Van based motorhome ($\leq 4,500$ kgs GVWR)] refers to a van where the chassis and cab portions from the B-pillar forward of this vehicle are the same as in codes "20" and "21", however, a frame mounted recreational unit is added behind the driver/cab area. This code takes priority over codes "20" and "21".

Code "24" [Van based school bus ($\leq 4,500$ kgs GVWR)] is a passenger van designed to carry students (passengers) to and from educational facilities and/or related functions. The vehicles are characteristically painted yellow and clearly identified as school buses. Use this code regardless of whether the vehicle is owned by a school system or a private company. Van based school buses converted for other uses (e.g., church bus) also take this code.

Code "25" [Van based other bus ($\leq 4,500$ kgs GVWR)] is a van derivative (e.g., taxi, small local transit) designed to carry passengers for low occupancy functions or purposes. Van based school buses do not use this code.

Code "28" [Other van type (Hi-Cube Van, Kary)] refers to a cargo or delivery van where that chassis and cab portions from the B-pillar forward of this vehicle are the same as in codes "20" and "21" with a frame mounted cargo area unit added behind the driver/cab area, or if the van cannot be described in codes "20", "21", "22" or "23". Annotate the van type when using this code. This code takes priority over codes "20" and "21".

Code "29" (Unknown van type) is used when it is known that this vehicle is a light van, but its specific type cannot be determined.

Light Conventional Trucks (Pickup Style Cab, $\leq 4,500$ kgs GVWR)

Codes "30"- "39" are used to describe vehicles commonly referred to as pickup trucks and some of their derivatives. These light trucks are characteristically designed: with a small cab containing a single row of seats (extended cabs with additional seats are available for some models), a large hood covering a conventional engine placement, and a separate open box area (approximately 180 to 240 centimeters long) for cargo.

Code "30" [Compact pickup (D50, Colt P/U, Ram 50, Dakota, Arrow Pickup [foreign], Ranger, Courier, S-10, T-10, LUV, S-15, T-15, Sonoma, Datsun/Nissan Pickup, P'up, Mazda Pickup, Toyota Pickup, Mitsubishi Pickup)] is used to describe a pickup truck having a width of 178 centimeters or less.

Code "31" [Large Pickup (Jeep Pickup, Comanche, Ram Pickup, D100-D350, W100-W350, F100-F350, C10-C35, K10-K35, R10-R35, V10-V35, Silverado, Sierra, R100-R500,)] is used to describe a pickup truck having a width of greater than 178 centimeters.

Variable Name: Body Type (cont'd.)

Code "32" (Pickup with slide-in camper) is used to describe any pickup truck that is equipped with a slide-in camper. A slide-in camper is a unit that mounts within a pickup bed. Pickup bed caps, tonneau covers, or frame mounted campers are not applicable for this code.

Code "33" (Convertible pickup) refers to a pickup truck equipped with a removable or retractable roof. To qualify for this code, the entire roof must open. Convertible roofs are generally fabric; however, removable hardtops are also included. This code takes priority over compact and large pickups (codes "30" and "31").

Code "39" (Unknown pickup style light conventional truck) is used when this vehicle qualifies for a code in the "30" to "33" range, but there is insufficient data to determine the specific code.

Other Light Trucks (\leq 4,500 kgs. GVWR)

Codes "40"- "49" are used to describe vehicles that are based upon a conventional light pickup frame, but a commercial or recreational body has been affixed to the frame rather than a pickup box.

Code "40" [Cab chassis based (includes rescue vehicles, light stake, dump, and tow truck)] is used to describe a light vehicle with a pickup style cab and a commercial (nonpickup) body attached to the frame. Included are pickup based ambulances and tow trucks.

Code "41" (Truck based panel) is used to describe a truck based station wagon that has sheet metal rather than glass above the beltline rearward of the B-pillars.

Code "42" [Light truck based motorhome (chassis mounted)] is used to describe a frame mounted recreational unit attached to a light van or conventional chassis.

Code "45" (Other light conventional truck type) is used for light conventional trucks that cannot be described in codes "30"- "39" or "40"- "42".

Code "48" (Unknown light truck type) is used when it is known that the vehicle is a light truck chassis based vehicle but insufficient data exist to specify between codes "19", "29", "39", or "40"- "42".

Code "49" [Unknown light vehicle type (automobile, utility, van, or light truck)] is used when it is known that the vehicle is a light vehicle, but insufficient data exists to specify between codes "09", "10"- "14", "19", "29", "39", or "40"- "48".

Variable Name: Body Type (cont'd.)

Buses (Excludes Van Based)

Codes "50", "58", and "59" are defined as any medium/heavy motor vehicle designed primarily to transport large groups of passengers.

Code "50" [School bus (designed to carry students, not cross country or transit)] is a bus designed to carry passengers to and from educational facilities and/or related functions. The vehicles are characteristically painted yellow and clearly identified as school buses. Use this code regardless of whether the vehicle is owned by a school system or a private company. School buses converted for other uses (e.g., church bus) also take this code.

Code "58" [Other bus type (e.g., transit, intercity, bus based motorhome)] is a transport device designed to carry passengers for longer periods of time. These vehicles may be classified as over-the-road, transit, intercity, bus related motorhome (other than school bus based), or other.

Code "59" (Unknown bus type) is used when it is known the transport device is a bus but there is insufficient data to choose between codes "50" and "58".

Medium/Heavy Trucks (> 4,500 kgs GVWR)

Codes "60"- "64" describe a single unit truck specifically designed for carrying cargo on the same chassis as the cab.

Codes "67"- "70" pertain to a truck-tractor designed for towing trailers or semi-trailers. Although towing is their primary purpose, some truck-tractors are equipped with cargo areas located rearward of the cab.

Code "60" [Step van (> 4,500 kgs GVWR)] defines a single unit enclosed body with a GVWR greater than 4,500 kilograms and an integral driver's compartment and cargo area. Step vans are generally equipped with a folding driver seat mounted on a pedestal and a sliding door for easy ingress/egress.

Code "61" [Single unit straight truck (4,500 kgs < GVWR ≤ 8,850 kgs)] describes a non-articulated truck designed to carry cargo. The gross vehicle weight rating of the vehicle must exceed 4,500 kilograms and be less than or equal to 8,850 kilograms.

Code "62" [Single unit straight truck (8,850 kgs < GVWR ≤ 12,000 kgs)] describes a non-articulated truck designed to carry cargo. The gross vehicle weight rating of the vehicle must exceed 8,850 kilograms and be less than or equal to 12,000 kilograms.

Variable Name: Body Type (cont'd.)

- Code "63" [Single unit straight truck (> 12,000 kgs GVWR)] describes a non-articulated truck designed to transport cargo with a gross vehicle weight rating in excess of 12,000 kilograms. Use this code if it is known that the GVWR of a single unit straight truck is greater than 4,500 kilograms but there is insufficient data to specify between codes "61" and "62".
- Code "64" (Single unit straight truck, GVWR unknown) is used when the transport vehicle is a single unit straight truck but the GVWR is unknown.
- Code "65" (Medium/heavy truck based motorhome) describes a recreational vehicle mounted on a single unit medium/heavy truck chassis.
- Code "67" (Truck-tractor with no cargo trailer) describes a fifth wheel equipped tractor/trailer power unit with no trailer attached.
- Code "68" (Truck-tractor pulling one trailer) describes a fifth wheel equipped tractor (i.e., power unit of a tractor/trailer combination) pulling one semi-trailer.
- Code "69" (Truck-tractor pulling two or more trailers) describes a fifth wheel equipped tractor (i.e., power unit of a tractor/trailer combination) pulling a semi-trailer plus one or more trailers. These additional trailers may be attached with a standard hitch or a converter dolly (for semi-trailers).
- Code "70" [Truck-tractor (unknown if pulling trailer)] is used when the vehicle is known to be a truck-tractor, but it is unknown if a trailer was being towed or if more than one trailer was being towed.
- Code "78" (Unknown medium/heavy truck type) is used when the only available information indicates a truck of medium/heavy size.
- Code "79" [Unknown truck type (light/medium/heavy)] is used when it is known that this vehicle is a truck, but there is insufficient data to classify the vehicle further.

Motored Cycles (Does Not Include All Terrain Vehicles/Cycles)

Codes "80"- "89" define types of motored cycles.

Code "80" (Motorcycle) is used when the vehicle is a two-wheeled open (i.e., no enclosed body) vehicle propelled by an internal combustion engine. Motorcycles equipped with a side car also take this code.

Code "81" [Moped (motorized bicycle)] is used when the vehicle is a motorized bicycle capable of moving either by pedaling or by an internal combustion engine.

Variable Name: Body Type (cont'd.)

Code "82" (Three-wheel motorcycle or moped) is used when the vehicle is a three-wheeled open vehicle propelled by an internal combustion engine or a three-wheeled motorized bicycle capable of moving either by pedaling or by an internal combustion engine.

Code "88" [Other motored cycle (minibike, motor scooter)] is used when the vehicle in question does not qualify for codes "80", "81", or "82" (e.g., motor scooter).

Code "89" (Unknown motored cycle type) is used when it is known that the vehicle is a motored cycle, but no further data is available.

Other Vehicles

Codes "90" - "97" describe all motored vehicles that are designed primarily for off-road use.

Code "90" [ATV (All-Terrain Vehicle) and ATC (All-Terrain Cycle)] is used for off-road recreational vehicles which cannot be licensed for use on public roadways. ATVs have 4 or more wheels and ATCs have 2 or 3 wheels. Generally, the tires have low pressure and wide profile (i.e., flotation/balloon).

Code "91" (Snowmobile) refers to a vehicle designed to be operated over snow propelled by an internal combustion engine.

Code "92" (Farm equipment other than trucks) refers to farming implements other than trucks propelled by an internal combustion engine (e.g., farm tractors, combines, etc.).

Code "93" (Construction equipment other than trucks) refers to construction equipment other than trucks propelled by an internal combustion engine (e.g., bulldozer, roadgrader, etc.).

Code "97" (Other vehicle type) is used when the motorized vehicle in question does not qualify for code "90"- "93" (e.g., go-kart, dune buggy, "kit" car, etc.).

Code "99" (Unknown body type) is used when there is no available information regarding the type of vehicle. This lack of information prohibits the accurate classification of this vehicle within one of the preceding codes.

Variable Name: Vehicle Identification Number

Element Values:

Code the entire VIN, left justify
 00000000000000000000 No VIN
 99999999999999999999 Unknown

Source: Primary source is vehicle inspection; a secondary source is the police report.

Remarks:

If a vehicle is inspected, the VIN must be obtained from the vehicle. The PAR may be used to obtain a VIN when a vehicle inspection is not required (i.e., nontow CDS applicable and CRASH is not applicable; or GV07, Body Type, equals "50"- "99").

Code and left justify the entire VIN; leave "Blank" any column which does not have a VIN character.

If part of the VIN is missing or not decipherable, leave the column any such character would ordinarily occupy "Blank".

Code "99999999999999999999" (Unknown) if the entire VIN is unknown or missing.

Code "00000000000000000000" if the vehicle is a type which has no VIN (e.g., go-kart).

If the vehicle is a motor home or school bus, the vehicle chassis VIN is coded and the secondary manufacturer's number should be annotated if indicated on the PAR.

If the vehicle is manufactured by the Ford Motor Company and the VIN begins or ends with a script, "S", the "S" is not coded. Proceed to the next character, as in the example below.

VIN: S 3 U 6 2 S 1 0 0 9 3 2 S
 CODE: 3 U 6 2 S 1 0 0 9 3 2 _ _ _ _ _

NOTE: For this variable only, slash zeros "0", so that they are not confused with the alphabet character "O", as in DOT.

In addition, if any hyphens, periods, or blank spaces are contained in the string of alphanumeric characters, ignore them as in the example below.

VIN: S M - E 3 0 7 6 4 2 1
 CODE: S M E 3 0 7 6 4 2 1 _ _ _ _ _

If the state will not allow transmittal of the complete VIN, code all characters except the sequential production numbers. Code zeros ("0") in place of the sequential numbers.

Variable Name: Vehicle Identification Number (cont'd.)

In those cases where the VIN does not match the references given below (e.g., a character is missing or an invalid character is coded in a space), the encoded VIN must follow the correct format indicated by the references below and a note is made on the form indicating the discrepancy.

The location of the VIN will vary among, and within, vehicles. Reference sources which may prove helpful in locating the VIN include, but are not limited to:

- (1) Passenger Vehicle Identification Manual
National Automobile Theft Bureau

Manuals available from

- National Insurance Crime Bureau
Operation Training & Prevention
10330 South Roberts Road
Palos, Illinois 60465-1997
- (2) Passenger Car and Truck-Accident
Investigator's Manual
American Automobile Manufacturers Association (AAMA)
300 New Center Building
Detroit, Michigan 48202
 - (3) Lee S. Cole
Lee Books
Post Office Box 906
Novato, California 94948-0906
(415) 897-3550
(Vehicle Identification 1938-1968)
(Vehicle Identification 1968-1982)
 - (4) N.A.D.A. Official Used Car Guide
National Automobile Dealers Association
8400 Westpark Drive
McLean, Virginia 22102

Vehicles manufactured after September 1980 conform to Federal Motor Vehicle Safety Standard 115. This standard requires that: (1) each VIN have 17 characters, and (2) the VIN does not contain the letters "I", "O", or "Q". There are many other requirements, one of which is that the VIN pass a mathematical test; thus, the use of the "check digit".

Each character in a VIN has a value, and each place has a weight. Each weight is multiplied by the value of the character in it; the products are summed and divided by eleven (11). The remainder (once converted from a decimal to an integer) must be the same as the value of the check digit character (the ninth one), except when the remainder is ten (10), in which case, the check digit character is "X".

Variable Name: Vehicle Identification Number (cont'd.)

<u>VIN Place</u>	<u>Value Factor</u>	<u>Character Values</u>					
1st	8	A-1	B-2	C-3	D-4	E-5	
2nd	7						
3rd	6	F-6	G-7	H-8		J-1	
4th	5						
5th	4	K-2	L-3	M-4	N-5		
6th	3						
7th	2	P-7		R-9	S-2	T-3	
8th	10						
Check Digit	0	U-4	V-5	W-6	X-7	Y-8	
10th	9						
11th	8	Z-9					
12th	7						
13th	6	0-0	1-1	2-2	3-3	4-4	
14th	5						
15th	4	5-5	6-6	7-7	8-8	9-9	
16th	3						
17th	2						

Example:

VIN Character	1	G	4	A	H	5	9	H	4	5	G	1	1	8	3	4	1	Sum	
Assigned Value	1	7	4	1	8	5	9	8	4	5	7	1	1	8	3	4	1		
Weight Factor	8	7	6	5	4	3	2	10	0	9	8	7	6	5	4	3	2		
Product		8	49	24	5	32	15	18	80	0	45	56	7	6	40	12	12	2	411

Divide sum by eleven (11): $411/11 = 37.3636\dots = 37$ and $4/11$ s.
Compare integer remainder to check digit: "4" equals "4".

Remainders of Eleven:

<u>Decimal</u>	<u>Integer</u>	<u>Decimal</u>	<u>Integer</u>	<u>Decimal</u>	<u>Integer</u>
.000000	0	.363636	4	.727272	8
.090909	1	.454545	5	.818181	9
.181818	2	.545454	6	.909090	X*
.272727	3	.636363	7		

* The character X is used instead of the integer ten (10) since the field is only one character wide.

Variable Name: Police Reported Vehicle Disposition

Element Values:

- 0 Not towed due to vehicle damage
- 1 Towed due to vehicle damage
- 9 Unknown

Source: Police report.

Remarks:

A "towed" vehicle is defined as a vehicle which is removed from the accident scene other than by means of its own power. For example, a vehicle which is reported by the police as towed out of a ditch and subsequently driven away, is not a towed vehicle. A vehicle which is driven from the scene and subsequently becomes disabled due to accident-related damage, such that towing is then required, is not a towed vehicle (even though that towing may be reported on the police report). Carefully scrutinize the PAR to determine the disposition of the vehicle directly from the scene and, if towing is indicated, the reason for the towing.

If a motorcycle is walked home [or a car pushed (by hand or by another car)] after the accident, then consider the motorcycle (and the car) as a towed vehicle. For tractor-trailer units, the disposition of the power unit (i.e., tractor) is recorded in this variable.

When a police report indicates that more than one event has occurred (i.e., stabilization is apparent), the disposition of this vehicle is based upon the event sequence selected for stratification. In other words, if the PAR indicates this vehicle was towed from the scene, and a researcher determines from the PAR that towing was not due to the damage sustained during this sequence, the correct response for this variable is "0" (Not towed due to vehicle damage).

When the PAR indicates that this vehicle was towed from the scene and it cannot be determined whether or not the towing was due to damage, the correct response for this variable is "1" (Towed due to vehicle damage).

Code "0" (Not towed due to vehicle damage) when:

- o the PAR indicates this vehicle was not towed from the scene, or
- o the PAR indicates this vehicle was towed from the scene but not due to accident-related disabling damage.

Code "1" (Towed due to vehicle damage) when:

- o the PAR indicates this vehicle was towed from the scene due to accident-related disabling damage, or

Variable Name: Police Reported Vehicle Disposition (cont'd.)

- o the PAR indicates this vehicle was towed from the scene and a researcher cannot determine (from the PAR data) if towing was due to accident-related disabling damage.

Code "9" (Unknown) is used when the investigating officer reported that the disposition of the vehicle was unknown at the time the PAR was completed. Also, use this code if the PAR indicates the vehicle was abandoned. However, if the police report specifies that the vehicle was disabled due to accident-related damage, as well as indicating either "unknown" or "abandoned" for disposition, it can be assumed that the vehicle will eventually be towed from the scene. In these instances, code "1" (Towed due to vehicle damage).

Variable Name: Police Reported Travel Speed (kph)

Element Values:

Range: 000 through 160, 999

Code to the nearest kph (Note: 000 means less than 0.5 kph)

160 159.5 kph and above

999 Unknown

Source: Police report only

Remarks:

Code the travel speed for this vehicle if indicated on the police report by the investigating officer. Do not use estimates by drivers or witnesses.

Code to the nearest kph, or if the travel speed is reported as a range, code the average. For example:

Reported Speed:	50.2 kph	50.5 kph	55-60 kph
Code:	"50"	"51"	"58"

Code "000" (000 kph) is used if this vehicle is stopped or traveling less than 0.5 Kph.

Code "160" (159.5 kph and above) is used if this vehicle's speed is reported as equal to or exceeding 159.5 kph.

Code "999" (Unknown) is used if the estimated travel speed is unknown.

Variable Name: Police Reported Alcohol Presence

Element Values:

- 0 No alcohol present
- 1 Yes (alcohol present)
- 7 Not reported
- 8 No driver present
- 9 Unknown

Source: Police report.

Remarks:

The phrase "alcohol present" means that the driver had consumed an alcoholic beverage. Presence is not an indication that alcohol was in any way a cause of the accident, even though it may have been. Finding opened or unopened alcoholic beverages in the vehicle does not by itself constitute presence.

Code "0" (No alcohol present) is used if the investigating officer's assessment (as reported on the police report) is that no alcohol was present in the driver.

Code "1" [Yes (alcohol present)] is used if the police indicate alcohol presence in the driver via: (1) a specific data element on the police report form, (2) the police charge the driver with DWIL, (3) the police mention in the narrative section of the report that the driver had been drinking (or alcohol was present or involved), or (4) the police report has a positive BAC test result (BAC > .00).

Code "7" (Not reported) is used if there is a specific location on the police report for assessment of alcohol presence but the investigating officer fails to make either a positive or negative assessment.

Code "8" (No driver present) is used when an in-transport vehicle was involved in the accident but no driver was in the vehicle at the time.

Code "9" (Unknown) is used if alcohol presence is indicated as unknown. In general, police reports have blocks to check either positive or negative alcohol presence. However, if a police report has provision for the investigating officer to respond "unknown presence", then use this code. In addition, use this code for hit-and-run drivers unless clear evidence to the contrary exists.

Some PARs have a block labeled "Alcohol/Drugs". If "presence" is indicated, and it cannot be determined which was used (e.g., narrative, arrest/charged section, etc.), then assume alcohol presence. If the police report indicates that a driver was charged with DWI (driving while intoxicated or driving while impaired) and no clarification is offered to indicate if the DWI was alcohol related or other drug related (i.e., a specific data element; mentioned in the narrative section; BAC results), then assume alcohol presence.

Variable Name: Alcohol Test Result For Driver

Element Values:

Range: 00-49; 95-99

Code actual value (decimal implied before first digit--0.xx).

- 95 Test refused
- 96 None given
- 97 AC test performed, results unknown
- 98 No driver present
- 99 Unknown

Source: Police report, medical reports, or other official sources.

Remarks:

Blood-Alcohol Concentration measures, analytically, the mass of alcohol per unit volume of blood. In common practice, the alcohol content of blood is typically stated in terms of grams of ethanol per deciliter of blood (g/dL)-- expressed as a decimal. The standard measure is expressed as the number of milligrams per deciliter (tenth of a liter) (e.g., .05 = 50 mg/100 ml; .15 = 150 mg/100 ml). A blood alcohol concentration (BAC) test could be a blood, breath, or urine test.

No psychomotor (police observation of driver actions) test results are coded here. Also, be aware of preliminary test results. These preliminary tests, including an instrumented field screening test, indicate the presence of alcohol, but not necessarily the particular content level. Preliminary tests are designed to segregate candidates for further testing from those persons where the suspected presence of alcohol is either nonexistent or too low for additional tests.

If an instrumented field screening test was given and it determined that:

- o no BAC test was required, code "96" (None given);
- o a BAC test was required, but the precise level was not obtained, code "97" (AC test performed, results unknown); or
- o a BAC test was required and the precise level was obtained, code the reported BAC from the subsequent test (codes "00"- "49").

If the BAC was given on the police report or subsequently added after the case was initiated, code the reported value. In essence, if any BAC is obtained, code the reported value. Use normal rounding rules (i.e., the number five or greater is rounded upward, less than five is rounded down). For example, a BAC of 117 mg/dl is coded "12".

For drivers of nontowed CDS applicable and non-CDS applicable vehicles, use only PAR information when coding test results.

Codes "00"- "49" report the actual number value representing the fraction of alcohol present.

Variable Name: Alcohol Test Result For Driver (cont'd.)

Code "00" is used when a test was performed, but no alcohol was detected.

Code "95" (Test refused) is used when the person refuses to voluntarily take a BAC test, and no subsequent test is given. If the person refuses, but a test is performed, code the reported BAC or "97" (AC test performed, results unknown).

Code "97" (AC test performed, results unknown) is used only after all available sources have been exhausted. Verbal BACs obtained from official sources are acceptable if written approval (or approval via the message system) has been obtained from the zone center. Obtain BAC test results whenever possible.

Code "98" (No driver present) is used when an in-transport vehicle was involved in the accident but no driver was in the vehicle at the time.

Code "99" (Unknown) is used when it is not known if a test was administered.

Variable Name: Speed Limit (kph)

Element Values:

Range: 000 through 105, 999

000 No statutory limit
Code posted or statutory speed limit in kph
999 Unknown

Source: Primary sources are scene inspection or statutory law. Do not use the police report for selecting this variable's value.

Remarks:

Convert all speed limits from miles per hour (mph) to kilometers per hour (kph). A conversion chart is provided below.

Disregard advisory or other speed signs which do not indicate the legal speed limit. Furthermore, do not confuse advisory signs on entrance/exit ramps or near intersections with the actual legal maximum speed limit.

If no speed limit sign is posted within a reasonable distance from the location of the first accident event along the approach leg of the roadway this vehicle was traveling on, then reference state statutes to obtain the applicable statutory maximum speed limit for the location (local or state).

If a state has a statute that uniformly reduces the maximum allowable speed within or near a construction zone, then code the indicated reduced limit.

Code "000" (No statutory limit) is used on roadways which are neither posted nor have a statutory limit (e.g., parking lot roadways or entrance/exits, service station entrance/exits, or driveways, etc.).

Code "999" (Unknown) is used only in situations where an accident scene cannot be located. Note, speed limit must be identified for all known accident scene locations.

Miles Per Hour To Kilometers Per Hour Conversion

<u>MPH</u>	<u>KPH</u>	<u>MPH</u>	<u>KPH</u>
05	= 08	40	= 64
10	= 16	45	= 72
15	= 24	50	= 80
20	= 32	55	= 89
25	= 40	60	= 97
30	= 48	65	= 105
35	= 56	70	= 113

Variable Name: Attempted Avoidance Maneuver

Element Values:

- 01 No avoidance actions
- 02 Braking (no lockup)
- 03 Braking (lockup)
- 04 Braking (lockup unknown)
- 05 Releasing brakes
- 06 Steering left
- 07 Steering right
- 08 Braking and steering left
- 09 Braking and steering right
- 10 Accelerating
- 11 Accelerating and steering left
- 12 Accelerating and steering right
- 97 No driver present
- 98 Other action (specify)
- 99 Unknown

Source: Researcher determined--inputs include the driver interview, police report, and the scene inspection.

Remarks:

Attempted avoidance maneuvers are movements/actions taken by the driver's vehicle, within a critical crash envelope, in response to a Critical Precrash Event, GV65. See the PRECRASH DATA OVERVIEW (precedes GV64, Pre-event Movement ...) for an expanded discussion on precrash definitions. Attempted avoidance maneuvers occur after the driver has realization of an impending danger. This variable assesses what the driver's action(s) were in response to his/her realization.

Most accidents have only one critical crash envelope and thus only one Critical Precrash Event; however, multiple critical crash envelopes with their respective Critical Precrash Events, can exist. The following chronological illustration shows the placement of this variable within the precrash data variables.

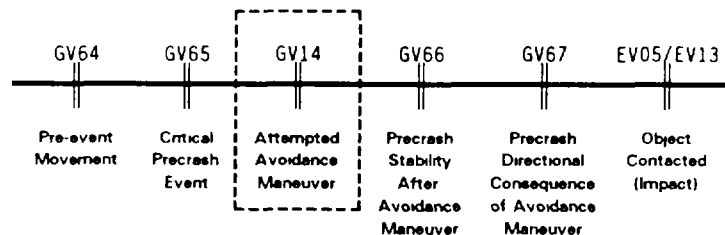

This variable retains its current location on the General Vehicle Form for consistency with the previous years of NASS CDS data collection; however, this variable's meaning changed with the 1992 data collection year and differs in some situations from the previous focus upon the driver's action just prior to the first harmful event (see PRECRASH DATA OVERVIEW). This variable may be coded independently: (1) of any maneuvers associated with this driver's Accident Type, GV15, and (2) this vehicle's first harmful event.

Variable Name: Attempted Avoidance Maneuver (Cont'd)

Code the element value which best describes the actions taken by the driver's vehicle in response to the Critical Precrash Event, GV65, within the critical crash envelope that occurred just prior to this vehicle's impact. When there was a known action (e.g., braking), but you cannot determine whether there was more than one action (e.g., braking and steering left), default to the known action (e.g., braking).

Code "01" (No avoidance action) is used whenever the driver did not attempt any evasive (pre-impact) maneuvers.

Code "97" (No driver present) is used whenever GV16, Driver Presence in Vehicle, is coded "0" (Driver not present).

Variable Name: Accident Type

Element Values:

Range: 00-16, 20-93, 98, 99

00 No impact

Code the number of the diagram that best describes the accident circumstance.

98 Other accident type (specify)

99 Unknown

Diagrams: See next page.

Source: Researcher determined - inputs include police report, scene inspection, vehicle inspection, and interview.

Remarks:

This variable is used for categorizing the collisions of drivers involved in accidents. A collision is defined here as the first harmful event in an accident between a vehicle and some object, accompanied by property damage or human injury. The object may be another vehicle, a person, an animal, a fixed object, the road surface, or the ground. If the first collision is a rollover, the impact is with the ground or road surface. The collision may also involve plowing into soft ground, if severe vehicle deceleration results in damage or injury. A road departure without damage or injury is not defined as a collision.

To determine the proper accident type (AT), refer to Figure 1 and follow the three step decision process outlined below:

Step 1 - Determine the appropriate category.

Step 2 - Determine the appropriate configuration.

Step 3 - Determine the specific accident type (two digit codes).

The categories are divided into six sections and are described as follows:

- o Category I. Single Driver - The first harmful event involves a collision between an in-transport vehicle and an object. A harmful event involving two in-transport vehicles is excluded from this category. Note, the impact location on the vehicle is not a consideration for accident types in this category.
- o Category II. Same Trafficway, Same Direction - The first harmful event occurred while both vehicles were traveling in the same direction on the same trafficway.
- o Category III. Same Trafficway, Opposite Direction - The first harmful event occurred while both vehicles were traveling in opposite directions on the same trafficway.

Variable Name: Accident Type (cont'd.)

Figure 1

Category	Configuration	ACCIDENT TYPES (Includes Intent)					
I Single Driver	A Right Roadside Departure	01 DRIVE OFF ROAD	02 CONTROL/TRACTION LOSS	03 AVOID COLLISION WITH VEH PED ANIM	04 SPECIFICS OTHER	05 SPECIFICS UNKNOWN	
	B Left Roadside Departure	06 DRIVE OFF ROAD	07 CONTROL/TRACTION LOSS	08 AVOID COLLISION WITH VEH PED ANIM	09 SPECIFICS OTHER	10 SPECIFICS UNKNOWN	
	C Forward Impact	11 PARKED VEH	12 STA OBJECT	13 PEDESTRIAN/ANIMAL	14 END DEPARTURE	15 SPECIFICS OTHER	16 SPECIFICS UNKNOWN
II Same Traffic was Same Direction	D Rear End	20 STOPPED	21 22 23 BLOWER	24 25 26 27 DECEL.	28 29 30 31	(EACH - 32) SPECIFICS OTHER	(EACH - 33) SPECIFICS UNKNOWN
	E Forward Impact	34 CONTROL/TRACTION LOSS	35 CONTROL/TRACTION LOSS	36 AVOID COLLISION WITH VEH	37 AVOID COLLISION WITH OBJECT	(EACH - 42) SPECIFICS OTHER	(EACH - 43) SPECIFICS UNKNOWN
	F Sideswipe Angle	44 45 46 47	(EACH - 48) SPECIFICS OTHER		(EACH - 49) SPECIFICS UNKNOWN		
III Same Traffic was Opposite Direction	G Head-On	50 LATERAL MOVE	(EACH - 52) SPECIFICS OTHER		(EACH - 53) SPECIFICS UNKNOWN		
	H Forward Impact	54 CONTROL/TRACTION LOSS	55 CONTROL/TRACTION LOSS	56 AVOID COLLISION WITH VEH	57 AVOID COLLISION WITH OBJECT	(EACH - 62) SPECIFICS OTHER	(EACH - 63) SPECIFICS UNKNOWN
	I Sideswipe Angle	64 LATERAL MOVE	(EACH - 66) SPECIFICS OTHER		(EACH - 67) SPECIFICS UNKNOWN		
IV Change Trafficway Vehicle Turning	J Turn Across Path	69 INITIAL OPPOSITE DIRECTIONS	70 INITIAL SAME DIRECTIONS	71 72 73	(EACH - 74) (EACH - 75) SPECIFICS OTHER SPECIFICS UNKNOWN		
	K Turn Into Path	77 78 TURN INTO SAME DIRECTION		79 80 81 82 TURN INTO OPPOSITE DIRECTIONS		(EACH - 84) (EACH - 85) SPECIFICS OTHER SPECIFICS UNKNOWN	
V Intersecting Paths (Vehicle Damage?)	L Straight Paths	86 87	88 89	(EACH - 90) SPECIFICS OTHER		(EACH - 91) SPECIFICS UNKNOWN	
VI Miscellaneous	M Backing Etc	92 BACKING VEH	93 OTHER VEH OR OBJECT		98 Other Accident Type 99 Unknown Accident Type 00 No Impact		

Variable Name: Accident Type (cont'd.)

- o Category IV. Change Trafficway, Vehicle Turning - The first harmful event occurred when the vehicle is either turning or merging while attempting to change from one trafficway to another trafficway. Trafficway for this variable is loosely defined to include driveways, alleys and parking lots when a vehicle is either entering or exiting a trafficway.
- o Category V. Intersecting Paths (Vehicle Damage) - The first harmful event involves situations where vehicle trajectories intersect. It is important to note the location of damage to each vehicle for accident typing.
- o Category VI. Miscellaneous - The first harmful event involves an accident type which cannot be described in Categories I-V and thus is included in this category.

Each category is further defined by an Accident Configuration(s). Configurations A through M are discussed below.

Category I. Single Driver

- o Configurations A and B ... Roadside Departure - The vehicle departed either the right or left side of road with the first harmful event occurring off the road. Right versus left is based on the side of the road departed immediately prior to the first harmful event.
- o Configuration C. Forward Impact - The vehicle struck an object on the road or off the end of a trafficway while moving forward.

Category II. Same Trafficway, Same Direction

- o Configuration D. Rear-End - The front of the overtaking vehicle impacted the rear of the other vehicle.

Note, even if the rear-impacted vehicle had started to make a turn, code here (not in **Category IV**).

- o Configuration E. Forward Impact - The front of the overtaking vehicle impacted the rear of the other vehicle, following a steering maneuver around a noninvolved vehicle or object.
- o Configuration F. Sideswipe/Angle - The two vehicles are involved in a shallow, glancing impact involving the side of one or both vehicles.

Note, CDC guidelines for sideswipes are not considered when assessing this configuration.

Variable Name: Accident Type (cont'd.)

Category III. Same Trafficway, Opposite Direction

- o Configuration G. Head-On - The frontal area of one vehicle impacted the frontal area of another.
- o Configuration H. Forward Impact - The frontal area of one vehicle impacted the frontal area of another following a steering maneuver around a noninvolved vehicle or an object.
- o Configuration I. Sideswipe/Angle - The two vehicles are involved in a shallow, glancing impact involving the side of one or both vehicles.

Category IV. Changing Trafficway, Vehicle Turning

- o Configuration J. Turn Across Path - The two vehicles were initially on the same trafficway when one vehicle tried to turn onto another trafficway and pulled in front of the other vehicle. Vehicles making a "U" turn are identified in **Category VI. Miscellaneous**.
- o Configuration K. Turn Into Path - The two vehicles were initially on different trafficways when one attempted to turn into the same trafficway as the other vehicle.

Note, the focus of this configuration is on the turning maneuver from one trafficway to another and not on the vehicles' plane of contact.

Category V. Intersecting Paths (Vehicle Damage)

- o Configuration L. Straight Paths - The two vehicles were proceeding (or attempting to proceed) straight ahead.

Category VI. Miscellaneous

- o Configuration M. Backing, Etc. - One of the two vehicles involved was a backing vehicle, regardless of its location on the trafficway or the damage location on the vehicles.

Any accident configuration which cannot be described in **Category I.** through **V.** is included here.

The configurations are delineated into specific accident types. These types can be identified by referring to the accident type diagram in Figure 1.

Variable Name: Accident Type (cont'd.)

The accident types in **Category I. (Single Driver)** involve an impact between a vehicle and an object. **Categories II. through VI.** identify specific collision combinations which must be coded in specified pairs (i.e., the pair code defines the Accident Type). As an example, the combination "20" (Rear-end, stopped) and "32" (Rear-end, specifics other) or "20" (Rear-end, stopped) and "25" (Slower, straight ahead) are not valid since "20" (Rear-end, stopped) only has meaning when linked to codes "21"- "23" (Stopped,).

An accident involving a vehicle impacting a "driverless in-transport vehicle" is coded "..., specifics other" in the appropriate configuration-category. For example, a vehicle which impacts the rear of a driverless in-transport vehicle is encoded "32" (Rear-end, specifics other) and "32".

In accidents involving more than two vehicles or in collision sequences involving a combination of vehicle-to-object-to-vehicle impacts, code the Accident Type for the vehicle(s) involved in the first harmful event. All other vehicles are coded "98" (Other accident type).

Keep in mind that intended actions play an important role in the coding scheme. For example, accident type "26" (Slower, turning left) is selected over type "25" (Slower, straight ahead) if the subject vehicle was traveling slower with the intention of turning left. Note, the turning action need not have occurred prior to the collision. The driver's intent to turn is the key.

The following accident types require clarification.

Code "00" (No impact) identifies noncollision events (fire, immersion, etc.). Rollovers on the road should be coded "98" (Other accident type).

Codes "01" (Right roadside departure, drive off road) and "06" (Left roadside departure, drive off road) are used when the vehicle departed the road under a controlled situation (i.e., the driver was distracted, fell asleep, intentionally departed, etc.).

Codes "02" (Right roadside departure, control/traction loss) and "07" (Left roadside departure, control/traction loss) are used if there is some evidence that the vehicle lost traction or in some other manner "got away" from the driver (i.e., the vehicle spun off the road as a result of surface conditions, oversteer phenomena, locked brakes or mechanical malfunctions). If doubt exists, code "01" (Right roadside departure, drive off road) or "06" (Left roadside departure, drive off road) respectively.

Codes "03" (Right roadside departure; avoid collision with vehicle, pedestrian, animal) and "08" (Left roadside departure; avoid collision with vehicle, pedestrian, animal) are used when the vehicle departed the road as a result of avoiding something in the road. "Phantom" situations are included here.

Variable Name: Accident Type (cont'd.)

Codes "03" (Right roadside departure; avoid collision with vehicle, pedestrian, animal), "08" (Left roadside departure; avoid collision with vehicle, pedestrian, animal) and "13" (Forward impact, pedestrian/animal) include pedestrians, bicyclists, other cyclists and other nonmotorists.

Codes "04" (Right roadside departure, specifics other) and "09" (Left roadside departure, specifics other) are used for any other stationary or nonstationary objects if the avoidance characteristics of codes "03" or "08" are present.

Codes "11" (Forward impact, parked vehicle), "12" (Forward impact, stationary object), and "13" (Forward impact, pedestrian/animal) involve an impact with an object which can be located on either side of the road.

Code "12" (Forward impact, stationary object) includes a hole in the road, an overhead object (e.g., overpass) or an object projecting over the road edge (e.g., support column of elevated railway).

Code "13" (Forward impact, pedestrian/animal) is used when a pedestrian, non-motorist, or animal is involved with the first harmful event. Vehicle plane of contact is not a consideration.

Code "15" (Forward impact, specifics other) is used for impacted (striking or struck) trains and nonstationary objects on the road.

Codes "44" (Sideswipe/Angle, straight ahead on left), "45" (Sideswipe/Angle, straight ahead on left/right), "46" (Sideswipe/Angle, changing lanes to the right), and "47" (Sideswipe/Angle, changing lanes to the left) identify relative vehicle positions (left versus right) and lane of travel intentions (straight ahead versus changing lanes).

From these four codes, four combinations are permitted. They are: (1) "44" and "45", (2) "46" and "45", (3) "45" and "47", and (4) "46" and "47". When used as a combination these codes refer to a sideswipe or angle collision which involved a vehicle to the left of a vehicle to the right where:

- o (1) neither vehicle (codes "44" and "45") intended to change its lane;
- o (2) the vehicle on the left (code "46") was changing lanes to the right, and the vehicle on the right (code "45") was not intending to change its lane;
- o (3) the vehicle on the left (code "45") was not intending to change its lane, and the vehicle on the right (code "47") was changing lanes to the left; and
- o (4) the vehicle on the left (code "46") was changing lanes to the right, and the vehicle on the right (code "47") was changing lanes to the left.

Variable Name: Accident Type (cont'd.)

In addition, when: (1) the right sides of the two vehicles impact following a 180 degree rotation of the vehicle on the right, or (2) the left sides of the two vehicles impact following a 180 degree rotation of the vehicle on the left; select the appropriate combination ("44"- "45", "46"- "45", "45"- "47", or "46"- "47") depending upon: (3) their positions (i.e., left versus right) and (4) the intended lane of travel (straight ahead versus changing lanes) of their drivers.

Code "48" (Sideswipe/Angle, specifics other) is used if one vehicle was behind the other prior to their **Category II, Configuration F** collision. For example, use this code when two vehicles are on the same trafficway and going the same direction, and one loses control and is struck in the side by the front of the other vehicle. However, if one vehicle rotates such that the impact is front to front, then use code "98" (Other accident type).

Code "64" (Sideswipe/Angle, lateral move--infringing vehicle) identifies the vehicle which infringed upon the other (code "65") in a **Category III, Configuration I** collision.

Codes "68" through "85" (Turn Across Path and Turn Into Path) are used in Configurations J and K where the vehicle's action is the controlling factor, and the plane of contact is irrelevant.

Code "82" (Left turn into opposite direction) is used when the driver's vehicle was in the act of making a left turn (e.g., from a driveway, parking lot or intersection). Do not confuse this situation with Configuration L. Straight Paths. The driver's intended path is the prime concern.

Codes "86" through "89" (Straight Paths) must not be confused with accident types in Configuration K. Turn Into Path. For these codes the vehicles are proceeding (or attempting to proceed) straight ahead, usually at a junction.

Code "98" (Other accident type) is used for those events and collisions which do not reasonably fit any of the specified types. This code includes:

- o rollovers on the road;
- o third or subsequent vehicles involved in an accident; or
- o the second involved vehicle when the first harmful event involved a vehicle-to-object collision, or a noncollision.

Variable Name: Driver Presence in Vehicle

Element Values:

Blank (GV07 = 50-99)
0 Driver not present
1 Driver present
9 Unknown

Source: Researcher determined; inputs include the police report and interviews.

Remarks:

This variable serves as a flag to identify driverless motor vehicles in-transport.

Code "0" (Driver not present) is used if no driver was physically in the vehicle at the time that it was involved in the accident. If no driver was present and this driver's vehicle was towed, then no Occupant Assessment Form or Occupant Injury Form are required for this driver.

Code "1" (Driver present) includes those instances when this motor vehicle was a "hit-and-run" vehicle.

Variable Name: Number of Occupants This Vehicle

Element Values:

Range: 00 through 97, 99, Blank

Blank (GV07 = 50-99)

00-96 Code actual number of occupants for this vehicle

97 97 or more

99 Unknown

Source: Police report and interviewees

Remarks:

Code the actual number of persons (including the driver) that were occupants of this vehicle. The number of Occupant Assessment Forms submitted (GV18, Number of Occupant Forms Submitted) need not equal this value.

Code "99" (Unknown) is used when:

- o the actual number of occupants is unknown, or
- o this vehicle is a "hit-and-run" vehicle--unless reliable evidence clearly establishes the number of occupants present.

Variable Name: Number of Occupant Forms Submitted

Element Values:

Range: 00 through 30, Blank

Blank (GV07 = 50-99)

00-30 Code actual number of Occupant Assessment Forms submitted for this vehicle

Source: Researcher determined; inputs include police report, vehicle inspection, and interviews.

Remarks:

If this vehicle is a police reported towed CDS applicable vehicle [i.e., GV07, Body Type, equals "01"-"49" and GV09, Police Reported Vehicle Disposition, equals "1" (Towed due to vehicle damage)], then an Occupant Assessment Form must be completed for each occupant. Enter the number of forms encoded and submitted for this vehicle. If this vehicle is not a CDS applicable vehicle (i.e., GV07 equals "50"-"99"), then this variable must be left "Blank".

Code "00" (zero Occupant Assessment Forms submitted) when:

- o this vehicle is a police reported nontowed CDS applicable vehicle [i.e., GV07 equals "01"-"49" and GV09 equals "0" (Not towed due to vehicle damage) or "9" (Unknown)] except for AOPS vehicles, or
- o this vehicle was in-transport and unoccupied.

Code "01" (One occupant) is used in the case of a "hit-and-run" police reported towed CDS applicable vehicle, where it is assumed that only one occupant/driver was present. Additional Occupant Assessment Forms (and thus increase the number coded here) can be submitted if reliable evidence exists that additional occupants were present.

Variable Name: Vehicle Curb Weight (kg)

Element Values:

Range: 045 through 610, 999, Blank

Blank (GV07 = 50-99)

Code weight to the nearest 10 kilograms.

045 Less than 450 kilograms

610 6,100 kilograms or more

999 Unknown

Source: Primary and secondary sources are listed below.

Remarks:

Code this vehicle's curb weight to the nearest 10 kilograms as in the examples.

Weight: 1,465 kilograms
Code: "147"

Weight: 3,402 kilograms
Code: "340"

Do not confuse the rated Gross Vehicle Weight Rating (GVWR) with the curb weight since it is likely to be significantly greater than the curb weight.

"Vehicle" is defined on this variable to mean the same as that coded on GV07, Body Type.

If the vehicle model (GV06) is known, but the engine size is unknown (e.g., 6 or 8 cylinders), code the average between the high and low curb weights for the model and annotate that the "average" was reported.

When the vehicle specifications do not report the vehicle weight with the proper engine size, adjustments must be made. First, try to determine the weight differences from the vehicle specifications. If the weight difference cannot be determined from the specifications, then adjust as follows: 8 cyl. to 6 cyl. - subtract 45 kilograms; 6 cyl. to 4 cyl. - subtract 34 kilograms.

Add 45 kilograms to the shipping weight to obtain a curb weight on all CDS applicable vehicles.

The primary source for obtaining this vehicle's curb weight is the first source of reference material listed below; the next three sources are secondary.

Variable Name: Vehicle Curb Weight (cont'd.)

Passenger Vehicle Specifications
American Automobile Manufacturers Association (AAMA)
of the U.S., Inc.
300 New Center Building
Detroit, Michigan 48202

Automotive News
Crain Automotive Group, Inc.
965 East Jefferson Avenue
Detroit, Michigan 48207

Branham Automobile Reference Book
Branham Publishing Company
Post Office Box 1948
Santa Monica, California 90406-1948

Gasoline Truck Index and
Diesel Truck Index
Truck Index, Inc.
Post Office Box 10291
Santa Anna, California 92711

Annotate the source used in the space provided on the General Vehicle Form under this variable.

If variable GV21, Towed Trailing Unit, is coded "1" (Yes - towed trailing unit), then the weight of the trailer and its cargo is not coded here. Instead, it is coded under variable GV20, Vehicle Cargo Weight. For example, the weight of a boat trailer and its cargo are encoded on Vehicle Cargo Weight (GV20), distinct from the weight of the vehicle.

Code "999" (Unknown) when the curb weight of this vehicle cannot be determined.

Variable Name: Vehicle Cargo Weight (kg)

Element Values:

Range: 000 through 450, 999, Blank

Blank (GV07 = 50-99)

Code weight to nearest 10 kilograms.

000 Less than 5 kilograms

450 4,500 kilograms or more

999 Unknown

Source: Researcher determined -- inputs include vehicle inspection and interviewees.

Remarks:

If variable GV21, Towed Trailing Unit, is coded "1" (Yes - towed trailing unit), then the weight of the trailer and its cargo is coded here. Cargo may also be located in the passenger compartment area and/or trunk.

Do not include the weight of the occupants in the cargo weight. The weight of the occupants is included (along with cargo and vehicle curb weight) as a component of the single value which represents the vehicles combined weight on the CRASH Program Summary Form, if used.

Code this vehicle's cargo weight to the nearest 10 kilograms as in the examples.

Weight: 81 kilograms
Code: "008"

Weight: 1,465 kilograms
Code: "147"

Code "000" (Less than 5 kilograms) is used if the cargo weight is less than 5 kilograms.

Code "450" (4,500 kilograms or more) is used if the cargo weight is 4,500 kilograms or more.

Code "999" (Unknown) is used if the cargo weight is unknown.

Variable Name: Towed Trailing Unit

Element Values:

Blank (GV07 = 50-99)
0 No towed unit
1 Yes - towed trailing unit
9 Unknown

Source: Vehicle inspection, interviews, and police report

Remarks:

A trailing unit includes horse trailers, fifth wheel trailers, travel trailers, camper trailers, boat trailers, truck trailers, towed motor vehicles, or any other trailer.

If this variable is coded "1" (Yes - towed trailing unit), then enter the weight of the trailer as well as any cargo it may be carrying in variable GV20, Vehicle Cargo Weight.

Code "0" (No towed unit) is used when a trailing unit is not being towed by this CDS applicable vehicle.

Code "1" (Yes - towed trailing unit) is used when a trailing unit is being towed by this CDS applicable vehicle.

Code "9" (Unknown) is used when it is uncertain whether code "0" or "1" applies.

Variable Name: Documentation of Trajectory Data for This Vehicle

Element Values:

Blank (GV07 = 50-99)
0 No
1 Yes

Source: Researcher determined - inputs include scene inspection, vehicle inspection, police report, and interviews.

The purpose of this variable is to assess the availability of accident induced physical evidence for impact and final rest, including multiple impacts.

Code "0" (No) means there was insufficient accident induced physical evidence to know or approximate the point of impact and final rest position for this vehicle's Highest Delta V CDC (EV06-EV11, Collision Deformation Classification).

Code "1" (Yes) is used when sufficient accident induced physical evidence is available to know or approximate the point of impact and final rest position for this vehicle's Highest Delta V CDC, independently of whether the CRASHPC program trajectory algorithm could be used (e.g., multiple impacts, missing vehicle, etc.).

For multiple impacts assess this variable with respect to the highest delta V impact. To code "Yes" ("1") the point of impact must be known as well its next point of impact or, if the highest delta V impact is the last impact for this vehicle, its final rest position.

When a nonhorizontal and/or rollover type collision is the highest delta V impact for this vehicle, code "Yes" ("1") if the point of impact (trip point or first contact) and final rest position are known.

The word "approximated" as used above means that the impact and final rest positions do not need to be known precisely, but they are reasonably accurate based on the available physical evidence. Approximated does not mean guesstimated (i.e., level I sketch).

Variable Name: Post Collision Condition of Tree or Pole
(for Highest Delta V)

Element Values:

- Blank (GV07 = 50-99)
- 0 Not collision (for highest delta V) with tree or pole
- 1 Not damaged
- 2 Cracked/sheared
- 3 Tilted < 45 degrees
- 4 Tilted \geq 45 degrees
- 5 Uprooted tree
- 6 Separated pole from base
- 7 Pole replaced
- 8 Other (specify):
- 9 Unknown

Source: Scene inspection and PAR.

Remarks:

Codes "1" through "8" are used when EV05, Object Contacted, is encoded "41" [Tree (\leq 10 centimeters in diameter)], "42" [Tree ($>$ 10 centimeters in diameter)], "45" [Breakaway pole or post (any diameter)], or "50"- "53" (Nonbreakaway Pole or Post).

Code "0" [Not collision (for highest delta V) with tree or pole] is used when the EV05, Object Contacted, that produced this vehicle's highest delta V is not a tree or pole (e.g., vehicle-to-vehicle collision).

Code "1" (Not damaged) is used when the tree or pole has no visible damage or minor surface damage.

Code "2" (Cracked/sheared) describes a pole or tree that is cracked (10% or more of the fibers), sheared, or bent. Bent and cracked poles may be tilted and the bending/cracking can be at any height. This code takes precedence over codes "3" (Tilted < 45 degrees), "4" (Tilted \geq 45 degrees), and "5" (Uprooted tree). Fallen limbs do not constitute "cracked" for a tree; the assessment is made at the tree's trunk. This code does not describe metal breakaway poles sheared at their base [see code "6" (Separated pole from base)].

Code "3" (Tilted < 45 degrees) describes a pole or tree that is inclined at less than a 45 degree angle as a result of this collision. If the tree/pole is also cracked, then use code "2" (Cracked/sheared).

Code "4" (Tilted \geq 45 degrees) describes a pole or tree that is inclined at a 45 degree angle or greater as a result of this collision. If the tree/pole is also cracked, then use code "2" (Cracked/sheared).

Code "5" (Uprooted tree) describes a tree that was completely or partially torn out of the ground; the tree trunk remained intact; however, the root system was pulled from the soil.

Variable Name: Post Collision Condition of Tree or Pole
(for Highest Delta V) [cont'd.]

Code "6" (Separated pole from base) describes a breakaway pole that has sheared or separated at the point where it was designed to do so.

Code "7" (Pole replaced) is used when a replacement pole has been installed and insufficient data exist to categorize the damage to the original pole. This code takes precedence over code "9" (Unknown).

Code "8" (Other) describes pole or tree damage that cannot be captured by the preceding codes.

Code "9" (Unknown) is used when no data can be obtained regarding the pole or tree.

Variable Name: Rollover

Element Values:

Blank (GV07 = 50-99)

0 No rollover (no overturning)

Rollover (primarily about the longitudinal axis)

1 Rollover, 1 quarter turn only

2 Rollover, 2 quarter turns

3 Rollover, 3 quarter turns

4 Rollover, 4 or more quarter turns (specify):

5 Rollover--end-over-end (i.e., primarily about the lateral axis)

9 Rollover (overturn), details unknown

Source: Primary sources are the vehicle and scene inspections; secondary sources include photographs, police report, driver interviews, and other interviewees.

Remarks:

Rollover is defined as any vehicle rotation of 90 degrees or more about any true longitudinal or lateral axis. Rollover can occur at any time during the collision and is coded independently of other configuration questions.

Code "0" [No rollover (no overturning)] if uncertainty exists concerning whether or not this vehicle rolled over. In addition, use this code if a trailer attached to the vehicle rolled over but the vehicle itself did not.

Codes "1", "2", "3", and "4" (Rollover, ...) are coded on the basis of the researcher's accident reconstruction. A "quarter turn" is defined as a rotation of 90 degrees about an axis of the vehicle; this does not include rotation about the vertical axis, commonly called yaw. Therefore, if a vehicle rolled longitudinally onto its roof (i.e., side-to-side roll), then it rolled 180 degrees and is coded "2" (Rollover, 2 quarter turns). When a vehicle rolls four or more quarter turns, code "4" (Rollover, 4 or more quarter turns) and specify the number of quarter turns involved.

Code "5" [Rollover--end-over-end (i.e., primarily about the lateral axis)] is used when the rollover is mainly end-over-end. This code is used when a rollover is a combination of a side-to-side and end-over-end roll and it cannot be determined which type of rollover is most prevalent.

Variable Name: Front Override/Underride (this vehicle)
Rear Override/Underride (this vehicle)

Element Values:

Blank (GV07 = 50-99)

0 No override/underride, or not an end-to-end impact

Override (see specific CDC)

1 1st CDC

2 2nd CDC

3 Other not automated CDC (specify):

Underride (see specific CDC)

4 1st CDC

5 2nd CDC

6 Other not automated CDC (Specify):

7 Medium/heavy truck or bus override

9 Unknown

Source: Vehicle inspection (with exceptions as noted)

Remarks:

Override/Underride is coded from the perspective of vehicle impact configuration and is not based on: coding in columns 5 and/or 6 of the CDC, or vehicle measurement techniques (i.e., the "13-centimeters" rule for CRASH purposes).

These variables are intended to capture those instances where there is an uneven damage pattern caused by uneven amounts of crush in different vertical zones of the front and/or rear planes of the vehicle. Because of the different crush stiffnesses involved in these locations, these variables are included to alert the vehicle safety analysts to uneven crush patterns in front and rear impacts, which are not identified in the CDC (i.e., columns 5 and/or 6).

For those variables an impact with a not-in-transport vehicle (either CDC applicable or a medium/heavy truck) is considered a vehicle-to-vehicle impact and not a vehicle-to-object impact.

GV25, Front Override/Underride (this vehicle), specifies the override/underride result to the vehicle which sustained the frontal impact. Similarly, GV26, Rear Override/Underride (this vehicle), encodes either override or underride to the vehicle which sustained the rear impact.

The term "override" means a vehicle overrode (i.e., goes on top of) the bumper (front or rear) of the other vehicle.

The term "underride" means a vehicle underrode (i.e., goes below) the bumper (front or rear) of the other vehicle.

Variable Name: Front Override/Underride (this vehicle) [cont'd.]
Rear Override/Underride (this vehicle) [cont'd.]

If a vehicle is not equipped with a bumper (e.g., rear of some pickup trucks), then consider the equivalent end structure for coding these variables.

SITUATION A

GV25	GV26	
"1"- "3"	"0"	(VEH. #1)
"0"	"4"- "6"	(VEH. #2)

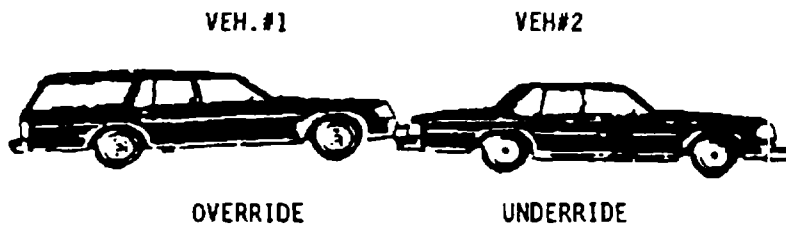
**SITUATION B**

GV25	GV26	
"4"- "6"	"0"	(VEH. #1)
"0"	"1"- "3"	(VEH. #2)

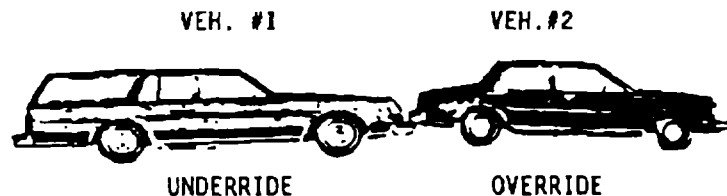

As indicated in Situation A, the trunk area of Vehicle #2 is damaged (i.e., "crushed") while the rear bumper is relatively undisturbed. Hence, the uneven damage pattern. Conversely, the front of Vehicle #1 is "crushed" at bumper height only, or is crushed uniformly at the bumper and grille levels (i.e., an "even" damage pattern). Even though Vehicle #1 may not exhibit the uneven damage pattern, it would still receive an applicable override code due to the resultant underride damage to Vehicle #2.

When the bumper receives measurable crush and the area above the bumper also receives measurable crush, the override/underride codes are applicable if the impact configuration applies. For example, (Situation B) the front bumper (Vehicle #1) may be crushed 2" rearward and the grille area may be crushed 6" rearward. While the averaging technique rule for CRASH does not apply for the different levels of crush, the impact may in fact meet the configuration rule for the override/underride variables.

When override/underride are applicable, these variables are coded based upon the corresponding CDC. Elements "1" and "4" (1st CDC) are used when EV06- EV11, represents the override or underride damage. Elements "2" and "5" (2nd CDC) are used when EV14-EV19 represents the override/underride damage. Elements "3" and "6" (Other not automated CDC) are used when the override/underride appears on the CDC Worksheet (Page 3 of the Exterior Vehicle Form) but is not coded in variables EV06-EV11 or EV14-EV19, Collision Deformation Classification.

Variable Name: Front Override/Underride (this vehicle) [cont'd.]
Rear Override/Underride (this vehicle) [cont'd.]

Code "0" (No override/underride, or not an end-to-end impact) when:

- o both vehicles are inspected and no override/underride occurred for the end-to-end impact (code "0" for both vehicles); or
- o the impact configuration is not end-to-end.

Codes "1" through "6" are used to record this CDS applicable vehicle's involvement with another CDS applicable vehicle in an end-to-end impact resulting in this vehicle either overriding or underriding the other involved CDS applicable vehicle.

Code "1", "2", or "3" [Override (see specific CDC)] when:

- o this inspected vehicle is involved in an override situation, and
- o its CDC is entered in: EV06-EV11 (code "1"), EV14-EV19 (code "2"), or on the CDC Worksheet only [Page 3 of the Exterior Vehicle Form (code "3")].

Code "4", "5", or "6" [Underride (see specific CDC)] when:

- o this inspected vehicle is involved in an underride situation, and
- o its CDC is entered in: EV6-EV11 (code "4"), EV14-EV19 (code "5"), or on the CDC Worksheet only [Page 3 of the Exterior Vehicle Form (code "6")].

Code "7" (Medium/heavy truck or bus override) is used if this inspected CDS applicable vehicle's front or rear bumper was underneath (i.e., underride) a medium/heavy truck or bus (GV07 = 50, 58, 59, 60-79) such that an uneven crush pattern resulted to this CDS applicable vehicle's: (1) bumper/grille area (or bumper/"trunk" area), and/or (2) the above-bumper (front or rear) and greenhouse areas.

Code "9" (Unknown) is used when:

- o this vehicle was involved in an end-to-end impact configuration and: (1) it was not inspected, or (2) it was repaired; or
- o this vehicle is inspected but the researcher cannot determine that an override/underride occurred for this vehicle for the end-to-end impact, and the other vehicle is not inspected; or
- o the vehicle-to-vehicle impact configuration type is unknown.

Variable Name: Heading Angle for This Vehicle
Heading Angle for Other Vehicle

Element Values:

- Blank (GV07 = 50-99)
- 000-359 Code actual value
- 997 Noncollision
- 998 Impact with object
- 999 Unknown

Source: Scene inspection, vehicle inspection, and interviews

Remarks:

GV27, Heading Angle for This Vehicle, records the heading angle for this vehicle's highest delta V when this impact was with another vehicle. Variable GV28, Heading Angle for Other Vehicle, records the corresponding angle for the other vehicle. Note, for these variables, parked vehicles are considered other vehicles and not objects.

For vehicle-to-vehicle collisions, use your scene diagram referencing system to determine the heading angles at the point of impact for this vehicle's highest delta V. All measurements are referenced to the north arrow on the diagram. The heading angle of each vehicle is determined by projecting the longitudinal axis of the vehicle through the extension of the north arrow. The angle value is obtained by using a 360° protractor and measuring in a clockwise direction from the north arrow. The north arrow always represents 0° (degrees). The angle is a positive value.

The following diagrams exemplify the measurement technique.

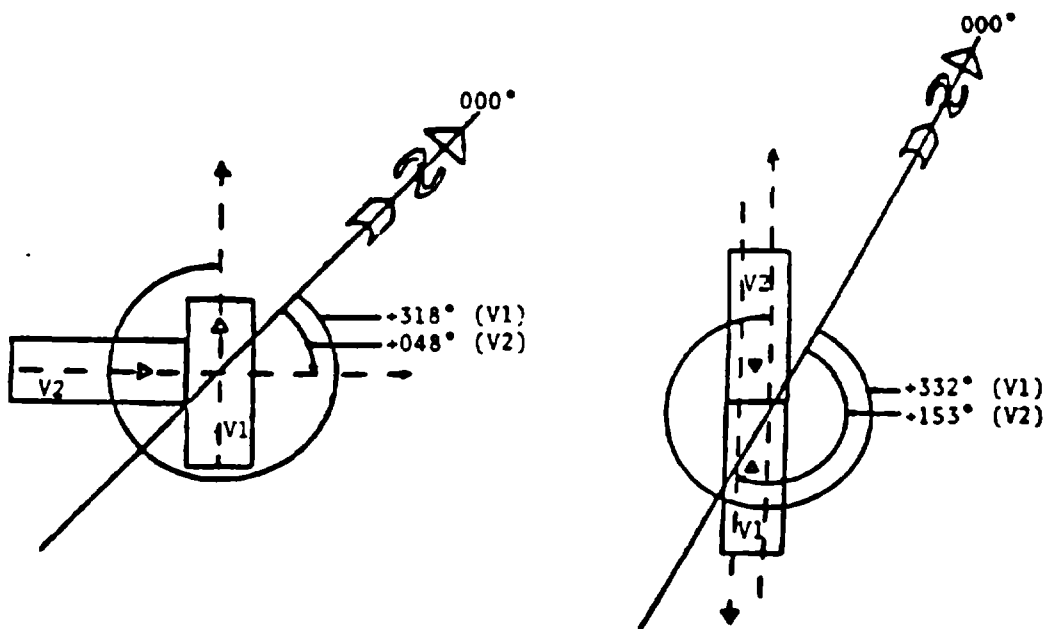

GENERAL VEHICLE FORM

GV27
GV28
(2)

Variable Name: Heading Angle for This Vehicle (cont'd.)
Heading Angle for Other Vehicle (cont'd.)

A value is recorded for all applicable vehicle-to-vehicle collisions regardless of the diagram level. Level I diagrams approximate vehicle orientations at impact (see discussion in Introductory--section 4.6).

Code "997" (Noncollision) is used for both variables when the Highest Delta V for this vehicle involves a noncollision event. See object contacted codes "31" through "39" for variable AC16 et al., Vehicle Number or Object Contacted, for identification of noncollision events (e.g., rollover).

Code "998" (Impact with object) is used for both variables when a collision with an object (EV05, Object Contacted, equals "41"-"69" or "72"-"98") results in this vehicle's highest delta V.

Code "999" (Unknown) is used only for vehicle-to-vehicle collisions and for both variables when either vehicle's impact position cannot be approximated on the scene diagram.

RECONSTRUCTION PROGRAMS OVERVIEW

Two algorithms are available for reconstruction in CDS NASS. Code GV29, Basis for Total Delta V (Highest), and the results GV30-GV33 (.... Delta V) whenever a reconstruction program is applicable. Reconstruct and encode the highest delta V. If there is a question as to which impact had the higher delta V, run a reconstruction program on all impacts and use the output to rank their severity. For additional information on each reconstruction program, refer to its particular reference manual.

CRASHPC

CRASHPC is based on (CRASH3) Calspan's Reconstruction of Accident Speeds on the Highway which is the primary algorithm used in CDS NASS. This program is designed to handle vehicle to vehicle or vehicle to barrier collisions. The CRASH3 program makes basic assumptions during its calculations. Because of these assumptions, the following collisions cannot be run on CRASHPC.

- o rollovers
- o yielding fixed objects
When GV23 (Post Collision of Tree or Pole) is coded 2-8, then the pole or tree is considered to have yielded and CRASHPC cannot be used.
- o sideswipes
- o nonhorizontal forces
- o severe override/underride
- o undercarriage damage
- o collisions with trains/large trucks
- o collisions with animals/pedestrians/cyclists
- o insufficient data (vehicle inspection required: see OLDMISS)
- o multiple impacts to the same area.

Damage Algorithm (CRASHPC)

The damage algorithm is the most often used portion of CRASHPC. This subroutine can be used when scene data are not available to generate a speed change. Because the delta V is based entirely on vehicle deformation, care must be taken to provide accurate information.

Shown on the next page in **Example A** is an output from a damage only run. The detailed output printout is obtained by selecting **OUTPUT** from the main menu, **DETAIL** from the output menu, and **PRINTER** from the submenu. Next, select **GRAPHICS** from the main menu, **SHOW DAMAGE** from the submenu, and press **P** on the keyboard.

RECONSTRUCTION PROGRAMS OVERVIEW

SUMMARY OF CRASHPC RESULTS USING DAMAGE

PSU99 Case No. 001B 85 Olds 98 and 85 Olds Firenza Head on

SPEED CHANGE
(DAMAGE)

VEHICLE #1

TOTAL 29 KPH (18 MPH)
LONGITUDINAL -29 KPH (-18 MPH)
LATITUDINAL 0 KPH (0 MPH)
PDOF ANGLE 0 DEGREES
ENERGY DISSIPATED = 50208 JOULES (37026 FT-LB)

VEHICLE #2

TOTAL 38 KPH (24 MPH)
LONGITUDINAL 38 KPH (24 MPH)
LATITUDINAL 0 KPH (0 MPH)
PDOF ANGLE -180 DEGREES
ENERGY DISSIPATED = 64964 JOULES (47908 FT-LB)

Example A

Trajectory Algorithm (CRASHPC)

In this method the scene data as well as vehicle data are used to estimate delta V. This subroutine calculates either a damage and trajectory estimate in axial [velocity vectors are within ten degrees of parallel (e.g., head-on, rear-end)] collisions or a Conservation of Linear Momentum solution in angular collisions. Because the scene data are calculated separately in the Conservation of Linear Momentum solution, a separate delta V is generated and a comparison with the damage delta V can be made for accuracy.

Reconciliation Of Different Results Between Damage And Trajectory (CRASHPC)

1. The axial collision solution is used when the initial velocity vectors are within ten degrees of parallel. Examples of use in CRASHPC are: head-on collisions, rear-end collisions, vehicles sliding sideways traveling straight into an oncoming vehicle or a stationary barrier, barrier impacts, etc.

The transition between the axial and angular solutions (i.e., a velocity vector change from within ten degrees of parallel to just outside ten degrees of parallel) may sometimes produce abrupt changes in delta V results. Therefore, the researcher should remember when running these cases to examine their results carefully.

RECONSTRUCTION PROGRAMS OVERVIEW

The axial collision printout will show impact speed (spinout and damage). These results are not coded. The program produces only one estimate [SPEED CHANGE (DAMAGE)] of delta V, which should be coded, if reasonable.

SUMMARY OF CRASHPC RESULTS USING DAMAGE

PSU99 CASE # 001B 85 OLDS 98 AND 85 OLDS FIRENZA Head on

	SPEED CHANGE (DAMAGE)	IMPACT SPEED (DAMAGE AND SPINOUT)
VEHICLE #1		
TOTAL	41 KPH (26 MPH)	44 KPH (28 MPH)
LONGITUDINAL	-41 KPH (-25 MPH)	44 KPH (28 MPH)
LATITUDINAL	7 KPH (4 MPH)	0 KPH (0 MPH)
PDOF ANGLE	-10 DEGREES	
ENERGY DISSIPATED =	113645 JOULES (83809 FT-LB)	
VEHICLE #2		
TOTAL	53 KPH (33 MPH)	51 KPH (32 MPH)
LONGITUDINAL	-53 KPH (-33 MPH)	51 KPH (32 MPH)
LATITUDINAL	9 KPH (6 MPH)	0 KPH (0 MPH)
PDOF ANGLE	-10 DEGREES	
ENERGY DISSIPATED =	116586 JOULES (85978 FT-LB)	

DAMAGE DATA

	VEHICLE #1	VEHICLE #2
SIZE CATEGORY	4	2
STIFFNESS CATEGORY	9	9
VEHICLE WEIGHT	1497 KGS (3300 LBS)	1161 KGS (2560 LBS)
CDC	12FDEW3	12FDEW3
PDOF ANGLE	-10 DEGREES	-10 DEGREES
CRUSH LENGTH	178 CM. (70 IN.)	152 CM. (60 IN.)
C1 (POINT 1)	66 CM. (26 IN.)	76 CM. (30 IN.)
C2 (POINT 2)	56 CM. (22 IN.)	71 CM. (28 IN.)
C3 (POINT 3)	51 CM. (20 IN.)	61 CM. (24 IN.)
C4 (POINT 4)	43 CM. (17 IN.)	46 CM. (18 IN.)
C5 (POINT 5)	25 CM. (10 IN.)	15 CM. (6 IN.)
C6 (POINT 6)	0 CM. (0 IN.)	0 CM. (0 IN.)
D (CRUSH OFFSET)	0 CM. (0 IN.)	0 CM. (0 IN.)

Example B

RECONSTRUCTION PROGRAMS OVERVIEW

2. The conservation of linear momentum solution is used for angle collisions (greater than ten degrees from parallel). The execution of the reconstruction program produces two independent estimates of delta V. The two results will seldom be precisely equal. The total, longitudinal, and lateral delta Vs associated with speed change "damage" and "linear momentum and trajectory" are each compared. Experience indicates that a satisfactory agreement exists between two estimates when their delta V components differ by no more than 4 kph or ten (10) percent, whichever is greater, and the angles are within the same o'clock direction. Be sure, when comparing delta Vs, to compare the V_i total delta V due to "damage" with the V_i total delta V due to "linear momentum and spinout". Likewise, make the same comparison for V_i longitudinal delta V, etc. When the agreement is not satisfactory, the data associated with each option should be reviewed for accuracy.

SUMMARY OF CRASHPC RESULTS USING TRAJECTORY

PSU 99 Case No. 103D	85 Olds 98 and 85 Olds Firenza		Angle
	SPEED CHANGE (DAMAGE)	SPEED CHANGE (LINEAR MOMENTUM AND TRAJECTORY)	IMPACT SPEED (LINEAR MOMENTUM AND TRAJECTORY)
VEHICLE #1			
TOTAL	27 KPH (17 MPH)	29 KPH (18 MPH)	41 KPH (25 MPH)
LONGITUDINAL	-21 KPH (-13 MPH)	-23 KPH (-14 MPH)	41 KPH (25 MPH)
LATITUDINAL	17 KPH (11 MPH)	18 KPH (11 MPH)	0 KPH (0 MPH)
PDOF ANGLE	-40 DEGREES	-39 DEGREES	
ENERGY DISSIPATED =	86522 JOULES (63807 FT-LB)	
VEHICLE #2			
TOTAL	35 KPH (22 MPH)	38 KPH (23 MPH)	35 KPH (22 MPH)
LONGITUDINAL	-22 KPH (-14 MPH)	-24 KPH (-15 MPH)	35 KPH (22 MPH)
LATITUDINAL	-27 KPH (-16 MPH)	-29 KPH (-18 MPH)	0 KPH (0 MPH)
PDOF ANGLE	50 DEGREES	51 DEGREES	
ENERGY DISSIPATED =	40805 JOULES (30092 FT-LB)	

Example C

RECONSTRUCTION PROGRAMS OVERVIEW

Shown above in **Examples B and C** are portions of the detailed output printout from one axial (**Example B**) and one angular (**Example C**) damage and trajectory run. The Total, Longitudinal, and Lateral speed changes of LINEAR MOMENTUM AND TRAJECTORY are each compared to the DAMAGE results. In **Example C** a good match is present, so additional reruns would not be made to improve the accuracy. Once the speed changes agree satisfactorily, the results for Total, Longitudinal, and Lateral speed changes are each averaged and the averaged results encoded in variables GV30-GV33 (... Delta V) on the General Vehicle Form. If agreement cannot be reached between the two methods, the case is flagged for special review by the zone center.

RECONSTRUCTION PROGRAMS OVERVIEW

OLDMISS

When the OLDMISS Program is applicable, the OLDMISS Program Summary form should be completed by the researcher and submitted with the case report.

This program is designed to handle vehicle-to-vehicle impacts when data on one of the vehicle's are missing.

Since the OLDMISS algorithm is based on the CRASH3 program the same basic CRASH3 assumptions must not be violated. Due to violations in the basic CRASH3 assumptions or the collision condition being outside of the scope of OLDMISS, the following collision types are not applicable to OLDMISS.

- o Side-to-side collisions
- o Side impacts - The known vehicle cannot be the vehicle with the side impact.
 - The angle of collision between the two vehicles, δ , must be within 10° of 90° or 270° , such that $80^\circ \leq \delta \leq 100^\circ$ OR $260^\circ \leq \delta \leq 280^\circ$.
- o End impacts - The angle of collision between the two vehicles, δ , must be within 20° of 0° or 180° , such that $-20^\circ \leq \delta \leq +20^\circ$ OR $160^\circ \leq \delta \leq 200^\circ$.
- o Sideswipe
- o Severe underide/override
- o Nonhorizontal force
- o Undercarriage damage
- o Collisions with vehicles "out of scope" (stiffness, size)
- o Multiple impacts to the same area on the known vehicle
- o Insufficient data

Information required on "unknown vehicle"

1. Size and stiffness category
2. Approximate "D" dimension
3. Curb weight (± 90 kilograms)
4. Heading angle at impact (approximate)
5. Area of damage (third character of CDC - "Area of Deformation")

Warnings:

- (1) When using the OLDMISS algorithm for pickups and vans, you must know additional information for a valid run.
 - a. Wheelbase [to determine size and stiffness (side impacts)]
 - b. Curb weight (± 90 kilograms)
 - c. Stiffness
 - o Rear impacts: Vehicles must have OEM (original equipment manufacturer) bumpers.
 - o Front impacts: Vehicle cannot have add-on equipment (e.g.: plow, winch, Nerf bars, etc.).

RECONSTRUCTION PROGRAMS OVERVIEW

- (2) OLDMISS results that are too high or low are not to be entered on the file.
- (3) Do not confuse the heading angle with the PDOF.
- (4) Check the PDOF result for the unknown vehicle. This PDOF must be a reasonably collinear angle for this collision.

Variable Name: Basis for Total Delta V (highest)

Element Values:

Blank (GV07 = 50-99)

Delta V calculated

- 1 CRASH program - damage only routine
- 2 CRASH program - damage and trajectory routine
- 3 Missing vehicle algorithm

Delta V not calculated

- 4 At least one vehicle (which may be this vehicle) is beyond the scope of an acceptable reconstruction program, regardless of collision conditions.
- 5 All vehicles within scope (CDC applicable) of CRASH program but one of the collision conditions is beyond the scope of the CRASH program or other acceptable reconstruction techniques, regardless of the adequacy of damage data.
- 6 All vehicles and collision conditions are within scope of one of the acceptable reconstruction programs, but there is insufficient data available.

Source: Researcher determined -- inputs include CRASH output (if applicable), vehicle inspection, scene inspection, police report, and photographs.

Remarks:

This variable is used to indicate: (1) which reconstruction program or routine was used to compute this vehicle's highest delta V [results encoded in GV30-GV33 (... Delta V)], or (2) the reason a reconstruction program was not applied to the most severe impact.

Code "1" (CRASH program - damage only routine) means the CRASH output [encoded in GV30-GV33 (... Delta V)] is based upon vehicle damage only.

Code "2" (CRASH program - damage and trajectory routine) means that the CRASH output [encoded in GV30-GV33 (... Delta V)] is based on trajectory evidence documented at the scene, in addition to vehicle damage.

Code "3" (Missing vehicle algorithm) means that in a two vehicle impact only one vehicle is inspected (damage measurements and CDC obtained), and for the other vehicle, the damage measurements (including CDC) are missing; however, enough data are available to use the OLDMISS algorithm.

Code "4" (At least one vehicle ... is beyond the scope ...) means that one of the vehicles (which may be this vehicle) involved in this vehicle's most severe collision cannot be adequately represented by the parameters in an acceptable reconstruction size/stiffness category (e.g., large truck, motorcycle, bus, etc.). As a general rule in CDS NASS, any vehicle that is not applicable for CDC is not applicable for an acceptable reconstruction program.

Variable Name: Basis for Total Delta V (highest) [cont'd.]

Code "5" (... one of the collision conditions is beyond the scope) means that the involved vehicles fit the vehicle parameters for an acceptable reconstruction program; however, the collision type is beyond the scope of the program (e.g., rollover, sideswipe, etc.).

Code "6" (... insufficient data available.) means that the involved vehicles and the collision type are applicable for an acceptable reconstruction program ("1" through "3" above), but due to insufficient data on one (or both) of the vehicles (or object), an acceptable reconstruction program ("1" through "3" above) cannot be used.

Variable Name: Total Delta V (kph)

Element Values:

Range: 000 through 160, 999, Blank

Blank (GV07 = 50-99)

Nearest kph

000 Less than 0.5 kph

160 159.5 kph and above

999 Unknown

Source: Reconstruction program

Remarks:

Code the Total Delta V from the results generated by the reconstruction program for this vehicle's most severe impact. This delta V must be for the same impact coded in Highest Delta V (EV04-EV11, Collision Deformation Classification).

Code "999" (Unknown) is used when the results for the most severe impact are unobtainable. If the CDC associated with the reconstruction program was only entered in Second Highest Delta V (EV12-EV19, Collision Deformation Classification), then enter the Total Delta V as shown in the results on the General Vehicle Form in the space available in the Secondary (noncoded) column.

Variable Name: Longitudinal Component of Delta V (kph)

Element Values:

Range: -160 to -001, _000, +001 to +160, _999, Blank

Blank (GV07 = 50-99)

Nearest kph

_000 Greater than -0.5 kph and less than +0.5 kph

±160 ≥159.5 kph and above

_999 Unknown

Source: Reconstruction program

Remarks:

Code the Longitudinal Component of Delta V from the results generated by the reconstruction program for this vehicle's most severe impact. This delta V must be for the same impact coded in the Highest Delta V (EV04-EV11, Collision Deformation Classification).

A plus (+) or minus (-) sign must be circled when encoding a value from a reconstruction program. Codes "000" (Greater than -0.5 kph and less than +0.5 kph) and "999" (Unknown) do not require a sign to be circled.

Code "999" (Unknown) is used when the results for the most severe impact are unobtainable. If the CDC associated with the reconstruction program was only entered in Second Highest Delta V (EV12-EV19, Collision Deformation Classification), then enter the Longitudinal Component of Delta V as shown in the results on the General Vehicle Form in the space available in the Secondary (noncoded) column.

Variable Name: Lateral Component of Delta V (kph)

Element Values:

Range: -160 to -001, _000, +001 to +160, _999, Blank

Blank (GV07 = 50-99)

Nearest kph

_000 Greater than -0.5 kph and less than +0.5 kph

±160 ≥159.5 kph and above

_999 Unknown

Source: Reconstruction program

Remarks:

Code the Lateral Component of Delta V from the results generated by the reconstruction program for this vehicle's most severe impact. This delta V must be for the same impact coded in Highest Delta V (EV04-EV11, Collision Deformation Classification).

A plus (+) or minus (-) sign must be circled when encoding a value from a reconstruction program. Codes "000" (Greater than -0.5 kph and less than +0.5 kph) and "999" (Unknown) do not require a sign to be circled.

Code "_999" (Unknown) is used when the results for the most severe impact are unobtainable. If the CDC associated with the reconstruction program was only entered in Second Highest Delta V (EV12-EV19, Collision Deformation Classification), then enter the Lateral Component of Delta V as shown in the results on the General Vehicle Form in the space available in the Secondary (noncoded) column.

Variable Name: Energy Absorption

Element Values:

Range: 0000 through 9997, 9999, Blank

Blank (GV07 = 50-99)

Nearest 100 joules

0000 Less than 50 joules

9997 999,650 joules or more

9999 Unknown

Source: Reconstruction program

Remarks:

Code the Energy Absorption from the results generated by the reconstruction program for this vehicle's most severe impact. This amount of energy must be for the same impact coded in Highest Delta V (EV04-EV11, Collision Deformation Classification).

Code "9997" (999,650 joules or more) if the reconstruction program is used and the amount of energy absorbed equals or exceeds 999,650 joules.

Code "9999" (Unknown) is used when the results for the most severe impact are unobtainable. If the CDC associated with the reconstruction program was only entered in Second Highest Delta V (EV12-EV19, Collision Deformation Classification), then enter the Energy Absorption as shown in the results on the General Vehicle Form in the space available in the Secondary (noncoded) column.

Variable Name: Confidence in Reconstruction Program Results
(for Highest Delta V)

Element Values:

- Blank (GV07 = 50-99)
- 0 No reconstruction
- 1 Collision fits model - results appear reasonable
- 2 Collision fits model - results appear high
- 3 Collision fits model - results appear low
- 4 Borderline reconstruction - results appear reasonable

Source: Researcher determined from reconstruction program results, vehicle inspection, scene inspection, and injury data.

Remarks:

Determine the quality of this vehicle's reconstruction program by evaluating the results of the reconstruction program and the data used to create those results for the Highest Delta V (EV04-EV11, Collision Deformation Classification). The vehicle inspection, scene inspection, and the injury information must all be reviewed for this determination.

Code "0" (No reconstruction) is used if no reconstruction program was used to determine the Highest Delta V (EV04-EV11, Collision Deformation Classification).

Code "1" (Collision fits model - results appear reasonable) is used if the results of the reconstruction in comparison to the actual collision are believed to be within an acceptable range for the Highest Delta V (EV04-EV11, Collision Deformation Classification).

Code "2" (Collision fits model - results appear high) is used if the results of the reconstruction in comparison to the actual collision appear to over represent the Highest Delta V (EV04-EV11, Collision Deformation Classification) for this vehicle. For example, vehicle damage is minor (bumper stroke only), and the total delta V is 25 kph.

Code "3" (Collision fits model - results appear low) is used if the results of the reconstruction in comparison to the actual collision appear to under represent the Highest Delta V (EV04-EV11, Collision Deformation Classification) for this vehicle. For example, vehicle damage is severe (60 centimeters of distributed frontal crush), injury level is high (AIS-3), and the total delta V is 25 kph.

Code "4" (Borderline reconstruction - results appear reasonable) is used if the results of the reconstruction in comparison to the actual collision are within an acceptable range for the Highest Delta V (EV04- EV11, Collision Deformation Classification) for this vehicle; however, some collision conditions were borderline for reconstruction.

Use this code for all uninspected vehicles whose delta V is determined by the OLDMISS program.

Variable Name: Type of Vehicle Inspection

Element Values:

- Blank (GV07 = 50-99)
- 0 No inspection
- 1 Complete inspection
- 2 Partial inspection (specify):

Source: Researcher determined

This variable is designed to allow users to identify cases with complete documentation of required damage data (exterior and interior).

Code "0" (No inspection) is used when neither a complete nor a partial inspection of this vehicle was obtained, irrespective of the reason (e.g., refusal, not required, etc.).

Code "1" (Complete inspection) is used when both the exterior and the interior of the unrepaired vehicle were inspected and all applicable measurements and photographs were obtained.

Code "2" (Partial inspection) is used when any phase of the inspection is not completed. This code includes inspection of partially or entirely repaired vehicles and non-towed CDS applicable vehicles when no Interior Vehicle Forms are required.

Variable Name: Injury Source Confidence Level
(1st through 10th or higher)

Element Values:

- 1 Certain
- 2 Probable
- 3 Possible
- 9 Unknown

Source: Zone Center determined--inputs include vehicle inspection, interviewee, and medical records.

Remarks:

The intent of this variable is to give analysts an assessment of the injury coder's confidence in the injury source coded for a specific injury.

Code "1" (Certain) if there is no reasonable doubt in the mind of the injury coder, based on occupant location, accident dynamics, contact points, and injury mechanism.

Code "2" (Probable) in those situations where there is not a certainty based on the factors noted above for code "1" (Certain).

Code "3" (Possible) if there is no supporting physical evidence but all factors point to an area of the vehicle or an object as the injury source.

Code "9" (Unknown) if the injury source is "97" (Injured, unknown source).

GENERAL VEHICLE FORM

GV36
(2)

Variable Name: Is this an AOPS Vehicle? (Cont'd)

Code "4" [VIN determined air bag and automatic (passive) belts] is used when: (1) the vehicle is not inspected; (2) there is no interview or medical record information with positive indication of the presence of an air bag system and automatic belts or deployment of an air bag and use of an automatic belt; and (3) it can be determined from the VIN (or AOPS listing following variable OA48) that this vehicle was manufactured with an air bag and automatic belts. Do not code availability (i.e., OA21 and OA44) based on this code.

OTHER DRUGS OVERVIEW

These variables focus upon "other drugs". For the purpose of these variables the word "drug" is defined in nonmedical terms. A "drug" is any chemical substance, natural or synthetic which, when taken into the human body, can impair the ability of the person to operate a motor vehicle safely. The word "other" in this phrase means all "drugs" except alcohol.

Drug observation/perception testing is a new and growing police field. It originated out of a growing frustration with identification of drug-impaired driving. For law enforcement, the following scenario is very familiar.

A driver is stopped on suspicion of alcohol-impaired driving and performs poorly on standardized field sobriety tests, only to "pass" a breath alcohol test. Is the driver ill, injured, or impaired, perhaps by a drug? And, if drugs are suspected, which drugs? Unfortunately, most law enforcement agencies do not have the resources or expertise to answer such questions. They might be able to obtain a urine or blood sample from the suspect but, unless they can give the laboratory some idea about what substances to look for, the analysis of the sample specimen for drugs can be exhaustive and expensive.

The Drug Evaluation and Classification (DEC) process is a standardized, systematic method of examining a driver suspected of impaired driving or some other alcohol-related and/or other drug-related offense. The process is designed to determine: (1) whether the suspect is impaired; and if so, (2) whether the impairment is other drug-related or medically-related (e.g., illness or injury); and if other drug-related, (3) the broad category (or combination of categories) of drugs likely to have caused the impairment.

The systematic process is based on a variety of observable signs and symptoms that are known to be reliable indicators of drug impairment. Conclusions are not based on any one element of the examination, but instead on the totality of facts that emerge. These facts are obtained from careful observations of the driver.

Trained police officers can perform these examinations in order to obtain compelling evidence establishing that a suspect was impaired at the time of the stop, and that the nature of the impairment was consistent with a particular category or subgroup of drugs. This examination evidence is extremely valuable in providing guidance to the laboratory in narrowing the universe of drugs that are to be tested for, decreasing the cost of the analyses, and increasing the odds that the analyses will produce a positive result.

A trained police officer is called a Drug Recognition Technician (DRT). This is the official title for an officer certified through the NHTSA DEC program. Researchers may also encounter police officers with the title DRE (Experts) or DRS (Specialist). Although DRT is the title that researchers should expect to

OTHER DRUGS OVERVIEW

encounter, the titles are interchangeable, provided that the police officer is certified in accordance with standards established by the International Association of Chiefs of Police (IACP).

It is important to understand several things that the DEC process is not.

- a. It is not a field test procedure. The process is a post-arrest investigative procedure that requires a carefully controlled environment that would be difficult if not impossible to secure at roadside.
- b. The process is not a means of determining what drug(s) the suspect has ingested. The evidence that the evaluation discloses does not permit the unique identification of drugs; rather, it **permits the presence of drugs to be narrowed down to certain broad categories**. For example, a trained police officer usually can determine if the suspect ingested a narcotic analgesic, but usually will not be able to tell whether it was morphine, demerol, heroin, codeine, or some other narcotic.
- c. The process is not a substitute for a chemical test. The process usually does supply a basis for suspecting that a particular category of drugs will be found in the driver's blood or urine, but it remains highly desirable to collect and analyze that blood or urine to secure the scientific evidence to corroborate the suspicion.

There are seven broad categories of drugs that can be identified through the DEC process. These do not exactly correspond to the classification schemes of drugs typically found in medical texts or pharmaceutical catalogs but, rather, are distinguished from one another on the basis of the observable signs they generate during the various examinations that comprise the DEC process.

The seven categories, with examples of each, follow below.

Narcotic Analgesics: Heroin is probably the most notorious member of this category, but the category also includes many other derivatives of opium, such as morphine, codeine, dilaudid, etc. It also includes many synthetic drugs, such as demerol and methadone.

Central Nervous System (CNS) Depressants: Alcohol is the most prominent member of this category, but the category also includes the various derivatives of barbiturate acid (phenobarbital, secobarbital, etc.); the anti-anxiety tranquilizers (Xanax, Valium, Librium, etc.); the anti-psychotic tranquilizers, such as Thorazine; and, many other drugs.

Central Nervous System (CNS) Stimulants: This category contains cocaine, Ritalin, the various members of the amphetamine family (methamphetamine, amphetamine sulfate, etc.), and many others.

OTHER DRUGS OVERVIEW

Hallucinogens: The drugs in this category cause hallucinations (i.e., perceptions of sights, sounds, odors, etc. that do not correspond to reality). Some naturally-occurring substances (e.g., peyote, psilocybin, morning glory seeds, etc.) belong to the hallucinogens, as well as many man-made drugs (e.g., LSD, MDA, STP, etc.).

Cannabis: This category consists of the various forms of the Cannabis Sativa plant (i.e., marijuana, hashish, hashish oil). The active ingredient in cannabis is delta-9 tetrahydrocannabinol, or THC.

Phencyclidine: This category consists of the drug PCP and its various analogs, or "chemical first cousins". PCP, sometimes called "angel dust", is a powerful anesthetic that does not render the user unconscious in recreational doses.

Inhalants: This is the category of the volatile solvents (model airplane glue, paint, gasoline, etc.); aerosols (propellant gases used in household products such as hairspray); and anesthetic gases (nitrous oxide, ether, etc.). Inhaling fumes of these substances can produce severe intoxication.

Each NASS CDS team must determine for the police jurisdictions in their PSU which ones have, or have access to, officers trained and certified in the drug evaluation and classification process (DEC). For each jurisdiction having certified "DRT"s, determine if their evaluations are recorded on the PAR. If evaluations are available, but they are not always recorded on the PAR, then determine how to obtain access to them. Finally, notify your zone center concerning which jurisdictions have certified DRTs and how you are obtaining their evaluations. This information is needed by the zone center for quality control purposes.

No laboratory, no matter how modern its equipment or competent its staff, can identify all drugs that are currently abused. Add to this the fact that new drugs, both licit and illicit, become available every week, and it soon becomes evident that the capacity for drug abuse always stays ahead of the capacity for chemical drug detection. Even if the laboratory does have the capability of identifying a particular drug, it will require that the drug be present at a specific minimum **concentration** before it can conclude that a "real" chemical detection has occurred. This is referred to as the **detection threshold**, and it varies from drug to drug, and from one chemical analytic method to another. Some of the analytic methods used by some laboratories to detect certain drugs do not actually seek to find the drug itself, but look instead for a **metabolite** of the drug. A metabolite is a chemical breakdown product of the drug.

OTHER DRUGS OVERVIEW

Other Drugs Sorted Alphabetically

D R U G	Synonym (or clarification)	Phonetic Spelling	DEC Process Category	Variable Number
Acetaminophen + Codeine	paracetamol	ah-set'ah-me'no-fen	Narcotic	GV40, GV41
Acetylmethadol	methadyl acetate	as'e-til-meth'ah-dol	Narcotic	GV40, GV41
Alphaprodine Hydrochloride	alphaprodine	al'fah-pro'den	Narcotic	GV40, GV41
Alprazolam		al-pra'zol am	Depressant	GV42, GV43
Amobarbital	amylorbarbitone, iso- amylethylbarbituric acid	am'o-bar'bi-tal	Depressant	GV42, GV43
Amphetamine		am-fe'tah-min	Stimulant	GV44, GV45
Amphetamine Sulfate		am-fe'tah-min	Stimulant	GV44, GV45
Amphetamine Variants	a. phosphate	am-fe'tah-min	Hallucinogen	GV46, GV47
Anileridine	a. hydrochloride	an'i-ler'i-den	Narcotic	GV40, GV41
APC + Codeine	acetylsalicylic acid-ASA (aspirin), phenacetin, & caffeine	ah-se'til-sal'ah-sil'ik fe-nas'e-tin kah-fer'	Narcotic	GV40, GV41
Aspirin + Codeine	acetylsalicylic acid-ASA	ah-se'til-sal'ah-sil'ik	Narcotic	GV40, GV41
Barbital		bar'bi-tal	Depressant	GV42, GV43
Barbiturate	barbituric acid (parent)	bar-bich'oorit	Depressant	GV42, GV43
Benzodiazepines		ben'zo-di-az'e-pen	Depressant	GV42, GV43
Benzoylcegonine	benzoyl compound	ben'zo-il	Stimulant	GV44, GV45
Benzphetamine Hydrochloride	benzphetamine	benz-fe'tah-men	Stimulant	GV44, GV45
Bufotenine		bu-fo'te-nin	Hallucinogen	GV46, GV47
Butabarbital Sodium	butabarbital, barbituric acid (derivative)	bu-tah-bar'bi-tal	Depressant	GV42, GV43
Carbamate	carbamic acid (parent)	kar'bah-mat	Depressant	GV42, GV43
Chloral Hydrate	chloral	klor'al hidrat	Depressant	GV42, GV43
Chlordiazepoxide Hydrochloride	a benzodiazepine		Depressant	GV42, GV43
Clonazepam Dipotassium	a benzodiazepine	klor-az'e-pat di'po-tas'e-um	Depressant	GV42, GV43
Cocaine	cocaine hydrochloride	ko'kan	Stimulant	GV44, GV45
Codeine	methylmorphine	ko'den	Narcotic	GV40, GV41
Delta-9-Tetrahydrocannabinol	THC, Delta 9		Cannabinoid	GV48, GV49
Dextroamphetamine	d. phosphate, d. sulfate	dek'stro-am-fe'tah-men	Stimulant	GV44, GV45
Diacetylmorphine	heroin, acetomorphine, dimorphine	di'ah-se'til-mor'fen	Narcotic	GV40, GV41
Diazepam	a benzodiazepine	di-az'e-pam	Depressant	GV42, GV43
Diethylpropion Hydrochloride	diethylpropion	di-eth'il-pro'pe-on	Stimulant	GV44, GV45
Dihydrocodeine	drocode	di-hi'dro-ko'den	Narcotic	GV40, GV41
Ethchlorvynol		eth-klor'vi-nol	Depressant	GV42, GV43
Ethylmorphine Hydrochloride	ethylmorphine	eth'il-mor'fen	Narcotic	GV40, GV41
Etorphine		Not listed in PDR/Dorland's	Narcotic	GV40, GV41
Fenethylamine Hydrochloride	fenethylamine	fen-eth'i-lin	Stimulant	GV44, GV45
Fentanyl Citrate	fentanyl, piperidine (derivative)	fen'tah-nil sit'rat	Narcotic	GV40, GV41
Fiorinal + Codeine	butalbital, aspirin, & caffeine	fe-or'i-nol bu-tal'bi-tal	Narcotic	GV40, GV41
Flurazepam Hydrochloride	a benzodiazepine	floo-az'e-pam	Depressant	GV42, GV43
Glytethimide		Not listed in PDR/Dorland's	Depressant	GV42, GV43
Halazepam		hal-az'e-pam	Depressant	GV42, GV43
Hashish	charas, churus	hash-esh'	Cannabinoid	GV48, GV49
Hashish Oil		hash-esh'	Cannabinoid	GV48, GV49
Heroin	diacetylmorphine	her'o-in	Narcotic	GV40, GV41
Hexobarbital	h. sodium	hek'so-bar'bi-tal	Depressant	GV42, GV43
Hydrocodone Bitartrate	dihydrocodeinone b.	hi'dro-ko'don	Narcotic	GV40, GV41
Hydromorphone	h. hydrochloride, dihydromorphanone h.	hi'dro-mor'fon	Narcotic	GV40, GV41
Hydroxyzine	h. hydrochloride, h. pamoate	hi-drok'si-zen	Depressant	GV42, GV43
Ibogaine		i-bo'gah-en	Hallucinogen	GV46, GV47

OTHER DRUGS OVERVIEW

Other Drugs Sorted Alphabetically (Cont'd.)

DRUG	Synonym (or clarification)	Phonetic Spelling	DEC Process Category	Variable Number
Levorphanol Tartrate		le-vor'fah-nol tahr'trat	Narcotic	GV40, GV41
Lorazepam		lor-ah'ze-pam	Depressant	GV42, GV43
Lysergic Acid Diethylamide	LSD, lysergide	li-sur'jik di'eth-il-am'in	Hallucinogen	GV46, GV47
Lysergic Acid-25		li-sur'jik	Hallucinogen	GV46, GV47
Marijuana	marihuana	mar'hi-hwah'nah	Cannabinoid	GV48, GV49
Marinol	dronabinol, THC		Cannabinoid	GV48, GV49
Mazindol		ma'zin-dol	Stimulant	GV44, GV45
Meperidine Hydrochloride	meperidine, isonipecaine, pethidine hydrochloride	me-per'i-den	Narcotic	GV40, GV41
Mephobarbital		mef'no-bar'bi-tal	Depressant	GV42, GV43
Meproamate		me-pro'bah-mat	Depressant	GV42, GV43
Mescaline		mes'kah-lin	Hallucinogen	GV46, GV47
Methadone Hydrochloride	methadone	meth'ah-don	Narcotic	GV40, GV41
Methamphetamine	m. hydrochloride	meth'am-fe'tah-men	Stimulant	GV44, GV45
Methaprylon		Not listed in PDR/Dorland's	Depressant	GV42, GV43
Methaqualone	m. hydrochloride	me-thah'kwah-lon	Depressant	GV42, GV43
Metharbital		me-thar'bi-tal	Depressant	GV42, GV43
Methylphenidate Hydrochloride	methylphenidate	meth'il-fer'i-dat	Stimulant	GV44, GV45
Morphine	dimethyl m., m. hydro- chloride, m. sulfate	mor'fen	Narcotic	GV40, GV41
Nalorphine	n. hydrochloride, allorphine, antorphine	na'lor-fen	Narcotic	GV40, GV41
Opium	anhydrous morphine	ope-um	Narcotic	GV40, GV41
Oxazepam	a benzodiazepine	oks-az'e-pam	Depressant	GV42, GV43
Oxycodone Hydrochloride	oxycodone	ok'se-kod'on	Narcotic	GV40, GV41
Oxymorphone Hydrochloride	oxymorphone	ok'se-mor'fon	Narcotic	GV40, GV41
Paregoric	opium (parent)	par'e-gor'ik	Narcotic	GV40, GV41
Parepectolin	paregoric (equivalent)		Narcotic	GV40, GV41
Pemoline		pen'ol en	Stimulant	GV44, GV45
Pentazocine	p. hydrochloride, p. lactate	pen-taz'o-sen	Narcotic	GV40, GV41
Pentobarbital	p. sodium, pentobarbitone	pen'to-bar'bi-tal	Depressant	GV42, GV43
Pethidine Hydrochloride	meperidine hydrochloride	peth'i-din	Narcotic	GV40, GV41
Peyote	peyotl	pa-d'te pa-d't'l	Hallucinogen	GV46, GV47
Phencyclidine Analogues		fen-sik'li-den	Phencyclidine	GV50, GV51
Phencyclidine Hydrochloride	PCP	fen-sik'li-den	Phencyclidine	GV50, GV51
Phendimetrazine Tartrate	phendimetrazine (generic)		Stimulant	GV44, GV45
Phermetrazine Hydrochloride	phermetrazine	fen-met'rah-zen	Stimulant	GV44, GV45
Phenobarbital	p. sodium, phenobarbitone, phenylethylbarbituric acid	fe'no-bar'bi-tal	Depressant	GV42, GV43
Phentermine	p. hydrochloride	fen'ter-men	Stimulant	GV44, GV45
Prazepam	a benzodiazepine derivative	prah'ze-pam	Depressant	GV42, GV43
Propoxyphene	p. hydrochloride, p. napsylate	pro-pok'se-fen	Narcotic	GV40, GV41
Psilocybin		si'lo-si'bin	Hallucinogen	GV46, GV47
Psilocyn		Not listed in PDR/Dorland's	Hallucinogen	GV46, GV47
Secobarbital	s. sodium, quinalbarbitone	se'ko-bar'bi-tal	Depressant	GV42, GV43
Talbutal		tal'bu-tal	Depressant	GV42, GV43
Temazepam		te-maz'e-pam	Depressant	GV42, GV43
Tetrahydrocannabinol	THC	tet'rah-hi'dro-kah-nabi-nol	Cannabinoid	GV48, GV49
Triazolam		tri-az'ol am	Depressant	GV42, GV43
Tybamate		ti'bah-mat	Depressant	GV42, GV43

OTHER DRUGS OVERVIEW

Other Drugs Sorted by General Vehicle Form Variable Numbers

D R U G	Synonym (or clarification)	Phonetic Spelling	DEC Process Category	Variable Number
Acetaminophen + Codeine	paracetamol	ah-set"ah-me'no-fen	Narcotic	GV40, GV41
Acetylmethadol	methadyl acetate	as"e-til-meth'ah-dol	Narcotic	GV40, GV41
Alphaprodine Hydrochloride	alphaprodine	al"feh-pro'den	Narcotic	GV40, GV41
Anileridine	a. hydrochloride	an"i-ler'i-den	Narcotic	GV40, GV41
APC + Codeine	acetylsalicylic acid-ASA (aspirin), phenacetin, & caffeine	ah-se'til-sal"ah-sil"ik fe-nas'e-tin kah-fen'	Narcotic	GV40, GV41
Aspirin + Codeine	acetylsalicylic acid-ASA	ah-se'til-sal"ah-sil"ik	Narcotic	GV40, GV41
Codeine	methylmorphine	ko'den	Narcotic	GV40, GV41
Diacetylmorphine	heroin, acetomorphine, dimorphine	di"ah-se'til-mor'fen	Narcotic	GV40, GV41
Dihydrocodeine	drocode	di-hi"dro-ko'den	Narcotic	GV40, GV41
Ethylmorphine Hydrochloride	ethylmorphine	eth"il-mor'fen	Narcotic	GV40, GV41
Etorphine		Not listed in PDR/Dorland's	Narcotic	GV40, GV41
Fentanyl Citrate	fentanyl, piperidine (derivative)	fen'tah-nil sit'rat	Narcotic	GV40, GV41
Fiorinal + Codeine	butalbital, aspirin, & caffeine	fe-or'i-nol bu-tal'bi-tal	Narcotic	GV40, GV41
Heroin	diacetylmorphine	her'o-in	Narcotic	GV40, GV41
Hydrocodone Bitartrate	dihydrocodeinone b.	hi"dro-ko'don	Narcotic	GV40, GV41
Hydromorphone	h. hydrochloride, dihydromorphinone h.	hi"dro-mor'fon	Narcotic	GV40, GV41
Levorphanol Tartrate		le-vor'fah-nol tahr'trat	Narcotic	GV40, GV41
Meperidine Hydrochloride	meperidine, isonipecaine, pethidine hydrochloride	me-per'i-den	Narcotic	GV40, GV41
Methadone Hydrochloride	methadone	meth'ah-don	Narcotic	GV40, GV41
Morphine	dimethyl m., m. hydro- chloride, m. sulfate	mor'fen	Narcotic	GV40, GV41
Nalorphine	n. hydrochloride, allorphine, antorphine	nal'or-fen	Narcotic	GV40, GV41
Opium	anhydrous morphine	ope-um	Narcotic	GV40, GV41
Oxycodone Hydrochloride	oxycodone	ok"se-ko'don	Narcotic	GV40, GV41
Oxymorphone Hydrochloride	oxymorphone	ok"se-mor'fon	Narcotic	GV40, GV41
Paregoric	opium (parent)	par"e-gor'ik	Narcotic	GV40, GV41
Parepectolin	paregoric (equivalent)		Narcotic	GV40, GV41
Pentazocine	p. hydrochloride, p. lactate	pen-taz'o-sen	Narcotic	GV40, GV41
Pethidine Hydrochloride	meperidine hydrochloride	peth'i-din	Narcotic	GV40, GV41
Propoxyphene	p. hydrochloride, p. napsylate	pro-pok'se-fen	Narcotic	GV40, GV41
Alprazolam		al-pra'zol am	Depressant	GV42, GV43
Amobarbital	amylbarbitone, iso- amylethylbarbituric acid	am'o-bar'bi-tal	Depressant	GV42, GV43
Barbital		bar'bi-tal	Depressant	GV42, GV43
Barbiturate	barbituric acid (parent)	bar-bich'oorit	Depressant	GV42, GV43
Benzodiazepines		ben"zo-di-az'e-pen	Depressant	GV42, GV43
Butabarbital Sodium	butabarbital, barbituric acid (derivative)	bu-tah-bar'bi-tal	Depressant	GV42, GV43
Carbamate	carbamic acid (parent)	kar'bah-mat	Depressant	GV42, GV43
Chloral Hydrate	chloral	klor'al hi'drat	Depressant	GV42, GV43
Chlordiazepoxide Hydrochloride	a benzodiazepine		Depressant	GV42, GV43
Clorazepate Dipotassium	a benzodiazepine	klor-az'e-pat di"po-tas'e-um	Depressant	GV42, GV43
Diazepam	a benzodiazepine	di-az'e-pam	Depressant	GV42, GV43
Ethchlorvynol		eth-klor'vi-nol	Depressant	GV42, GV43
Flurazepam Hydrochloride	a benzodiazepine	floo-az'e-pam	Depressant	GV42, GV43
Glytethimide		Not listed in PDR/Dorland's	Depressant	GV42, GV43

OTHER DRUGS OVERVIEW

Other Drugs Sorted by General Vehicle Form Variable Numbers (Cont'd.)

DRUG	Synonym (or clarification)	Phonetic Spelling	DEC Process Category	Variable Number
Halazepam		hal-az'e-pam	Depressant	GV42, GV43
Hexobarbital	h. sodium	hek''so-bar'bi-tal	Depressant	GV42, GV43
Hydroxyzine	h. hydrochloride, h. pamoate	hi-drok'si-zen	Depressant	GV42, GV43
Lorazepam		lor-ah'ze-pam	Depressant	GV42, GV43
Mephobarbital		mef''o-bar'bi-tal	Depressant	GV42, GV43
Meproamate		me-pro'bah-mat	Depressant	GV42, GV43
Methaprylon		Not listed in PDR/Dorland's	Depressant	GV42, GV43
Methaqualone	m. hydrochloride	me-thah'kwah-lon	Depressant	GV42, GV43
Metharbital		me-thar'bi-tal	Depressant	GV42, GV43
Oxazepam	a benzodiazepine	oks-az'e-pam	Depressant	GV42, GV43
Pentobarbital	p. sodium, pentobarbitone	pen''to-bar'bi-tal	Depressant	GV42, GV43
Phenobarbital	p. sodium, phenobarbitone, phenylethylbarbituric acid	fe''no-bar'bi-tal	Depressant	GV42, GV43
Prazepam	a benzodiazepine derivative	prah'ze-pam	Depressant	GV42, GV43
Secobarbital	s. sodium, quinalbarbitone	se''ko-bar'bi-tal	Depressant	GV42, GV43
Talbutal		tal'bu-tal	Depressant	GV42, GV43
Temazepam		te-maz'e-pam	Depressant	GV42, GV43
Triazolam		tri-'azol am	Depressant	GV42, GV43
Tybamate		ti'bah-mat	Depressant	GV42, GV43
Amphetamine		am-fe'tah-min	Stimulant	GV44, GV45
Amphetamine Sulfate		am-fe'tah-min	Stimulant	GV44, GV45
Benzoylcegonine	benzoyl compound	ben'zo-il	Stimulant	GV44, GV45
Benzphetamine Hydrochloride	benzphetamine	benz-fe'tah-men	Stimulant	GV44, GV45
Cocaine	cocaine hydrochloride	ko'kan	Stimulant	GV44, GV45
Dextroamphetamine	d. phosphate, d. sulfate	dek''stro-am-fe'tah-men	Stimulant	GV44, GV45
Diethylpropion Hydrochloride	diethylpropion	di-eth'il-pro'pe-on	Stimulant	GV44, GV45
Fenethylamine Hydrochloride	fenethylamine	fen-eth'i-lin	Stimulant	GV44, GV45
Mazindol		ma'zin-dol	Stimulant	GV44, GV45
Methamphetamine	m. hydrochloride	meth'am-fe'tah-men	Stimulant	GV44, GV45
Methylphenidate Hydrochloride	methylphenidate	meth''il-fe'ni-dat	Stimulant	GV44, GV45
Pemoline		pen'ol en	Stimulant	GV44, GV45
Phendimetrazine Tartrate	phendimetrazine (generic)		Stimulant	GV44, GV45
Phenmetrazine Hydrochloride	phenmetrazine	fen-me'trah-zen	Stimulant	GV44, GV45
Phentermine	p. hydrochloride	fen'ter-men	Stimulant	GV44, GV45
Amphetamine Variants	a. phosphate	am-fe'tah-min	Hallucinogen	GV46, GV47
Bufotenine		bu-fo'te-nin	Hallucinogen	GV46, GV47
Ibogaine		i-bo'gah-en	Hallucinogen	GV46, GV47
Lysergic Acid Diethylamide	LSD, lysergide	li-sur'jik di''eth-il-am'in	Hallucinogen	GV46, GV47
Lysergic Acid-25		li-sur'jik	Hallucinogen	GV46, GV47
Mescaline		mes'kah-lin	Hallucinogen	GV46, GV47
Peyote	peyotl	pa-d'te pa-d't'l	Hallucinogen	GV46, GV47
Psilocybin		si''lo-si'bin	Hallucinogen	GV46, GV47
Psilocyn		Not listed in PDR/Dorland's	Hallucinogen	GV46, GV47
Delta-9-Tetrahydrocannabinol	THC, Delta 9		Cannabinoid	GV48, GV49
Hashish	charas, churus	hash-esh'	Cannabinoid	GV48, GV49
Hashish Oil		hash-esh'	Cannabinoid	GV48, GV49
Marijuana	marihuana	mar''i-hwah'nah	Cannabinoid	GV48, GV49
Marinol	dronabinol, THC		Cannabinoid	GV48, GV49
Tetrahydrocannabinol	THC	tet''rah-hi''dro-kah-nabi-nol	Cannabinoid	GV48, GV49
Phencyclidine Analogues	PCP	fen-sik'li-den	Phencyclidine	GV50, GV51
Phencyclidine Hydrochloride	PCP	fen-sik'li-den	Phencyclidine	GV50, GV51

Variable Name: Police Reported Other Drug Presence

Element Values:

- 0 No other drugs present
- 1 Yes (other drug present)
- 7 Not reported
- 8 No driver present
- 9 Unknown

Source: Police report.

Remarks:

The phrase "other drug present" includes prescription and "over-the-counter" medications as well as "illicit" substances (e.g., in most cases, marijuana, cocaine, heroin, etc. where usage has not been prescribed by a doctor). Also, "other drug present" means that the driver had ingested an other drug prior to the accident, but it is not an indication that the drug usage was in any way the cause of the accident (or event), even though it may have been. Finding other drugs in the vehicle does not by itself constitute presence.

Code "0" (No other drugs present) is used if the investigating officer's assessment (as reported on the police report) is that no other drugs were present in the driver.

Code "1" [Yes (other drug present)] is used if the police indicate an other drug presence in the driver via: (1) a specific data element on the PAR, or (2) the police mention in the narrative section of the report that the driver had ingested an other drug.

Code "7" (Not reported) is used if there is a specific location on the police report for assessment of other drug presence but the investigating officer fails to make either a positive or negative assessment. In addition, use this code if the PAR does not have a specific location for reporting other drugs and the police do not mention other drugs in the narrative section.

Code "8" (No driver present) is used when an in-transport vehicle was involved in the accident but no driver was in the vehicle at the time.

Code "9" (Unknown) is used if other drug presence is indicated as unknown. A growing number of police reports have blocks to check either positive or negative other drug presence. However, if a police report has provision for the investigating officer to respond "unknown presence", then use this code. In addition, use this code for hit-and-run drivers unless clear evidence to the contrary exists.

Some PARs have a block labeled "Alcohol/Drugs". If "presence" is indicated, and it cannot be determined which was used (e.g., narrative, arrest/charged section, etc.), then assume alcohol presence. If the police report indicates that a driver was charged with DWI (driving while intoxicated or driving while impaired) and no clarification is offered to indicate if the DWI was alcohol related or other drug related (i.e., a specific data element; mentioned in the narrative section; BAC results), then assume alcohol presence.

Variable Name: Police Reported Drug Evaluation Classification (DEC)
Test for Driver

Element Values:

- 0 No DEC process available or given
- 1 DEC process given, results known
- 2 DEC process given, results unknown
- 3 DEC process available, unknown if given
- 8 No driver present

Source: Police report or other DEC related reports.

Remarks:

Every PSU must determine for each jurisdiction whether or not a DEC process is available to the police jurisdiction.

Code "0" (No DEC process available or given) is used when:

- (1) The police jurisdiction completing the PAR does not have, or have access to, a certified DRT, or
- (2) The PAR indicates, or it is known from other sources, that the DEC process was available at the police jurisdiction but the DEC process was not given by a certified DRT.

Code "1" (DEC process given, results known) is used whenever:

- (1) The police jurisdiction completing the PAR has, or has access to, a certified DRT, and
- (2) "Yes" or "no" (codes "1" or "0") is coded in GV37, Police Reported Other Drug Presence;
- (3) The PAR or other DEC related reports indicates that a DEC test for other drugs was given to the driver by a certified DRT, and;
- (4) The results are available to the researcher.

Code "2" (DEC process given, results unknown) is used whenever:

- (1) The police jurisdiction completing the PAR has, or has access to, a certified DRT, and
- (2) "Yes" or "no" (codes "1" or "0") is coded in GV37, Police Reported Other Drug Presence;
- (3) The PAR or other DEC related reports indicates that a DEC test for other drugs was given to the driver by a certified DRT, and;
- (4) The results are not available to the researcher.

Variable Name: Police Reported Drug Evaluation Classification (DEC)
Test for Driver (Cont'd)

Code "3" (DEC process available, unknown if given) is used when:

- (1) The police jurisdiction completing the PAR has, or has access to, a certified DRT, and
- (2) it is unknown if the DEC process was used to arrive at the determination encoded in GV37, Police Reported Other Drug Presence, when GV37 equals code "0" (No other drugs present), code "1" [Yes (other drug presence)], or code "9" (Unknown), or
- (3) the PAR does not have a block for coding the presence of other drugs [i.e., GV37 equals "7" (Not reported)], and the narrative does not indicate that other drugs were present, or
- (4) GV37 is coded "9" (Unknown)

Code "8" (No driver present) is used when an in-transport vehicle was involved in the accident but no driver was in the vehicle at the time.

Coding combinations expressed above are summarized in the table below.

GV37 equals	No DEC process available at the applicable jurisdiction	DEC process is available at the applicable jurisdiction
	GV38 equals	GV38 equals
0	0	0, 1, 2, 3
1	0	0, 1, 2, 3
7	0	0, 1, 2, 3
8	8	8
9	0	0, 3

Variable Name: Other Drug Specimen Test Type for Driver

Element Values:

- 0 No specimen test given
- 1 Blood test
- 2 Urine test
- 3 Other specimen test (specify)
- 7 Unspecified specimen test
- 8 No driver present
- 9 Unknown if specimen test given

Source: Police report, medical reports, or other official sources.

Remarks:

If a medical, police report, or other official source says that a certain drug was "screened for" or that it was "not detected", then you know that a specimen test was used. In addition, the presence of a measured quantity of an "other drug(s)" means that a specimen test was given. The specimen used in the test that obtained the measurement could be blood, urine, or an other specimen (e.g., nasal swab, saliva). Some drugs are tested using a particular type of specimen; others can be tested in multiple ways. Researchers need to review toxicology (or other official) records carefully to determine which specimen or specimens were used for the driver's evaluation. Specimens are hierarchically ordered with a blood test taking preference over a urine test and urine over other. Thus, if a driver was tested for cocaine by means of a blood test and a nasal swab, then code "1" (Blood test) would be encoded.

Code "0" (No specimen test given) is used whenever there is no indication that any of the driver's specimens were tested for other drugs. Medicals routinely report blood chemistry/gases for patients. Do not confuse these routine medical specimen examinations with a test for other drugs. In addition, use this code for hit-and-run drivers unless clear evidence to the contrary exists.

Code "1" (Blood test) is used whenever the specimen or specimens evaluated for other drugs included the driver's blood.

Code "2" (Urine test) is used whenever the specimen or specimens evaluated for other drugs included the driver's urine and did not include the driver's blood.

Code "3" (Other specimen test) is used whenever the only specimen or specimens evaluated for other drugs were other than blood and urine. Examples of other specimens include, but are not limited to, a nasal swab and saliva.

Code "7" (Unspecified specimen test) is used whenever it is known, or can be implied, that an evaluation for other drugs occurred but it is unknown exactly which specimen or specimens were evaluated.

Variable Name: Other Drug Specimen Test Type for Driver (Cont'd.)

Code "8" (No driver present) is used when an in-transport vehicle was involved in the accident but no driver was in the vehicle at the time.

Code "9" (Unknown if specimen test given) is used whenever GV37, Police Reported Other Drug Presence, is coded "1" [Yes (other drug present)] and no records (medical or otherwise) are available to confirm or deny that the police made their evaluation on the basis of a specimen test.

Variable Name: Narcotic Drug: DEC Test Results

Element Values:

- 0 No DEC test given
- 1 Passed DEC test
- 2 Failed DEC test
- 3 DEC test given - results unknown
- 8 No driver present
- 9 Unknown if DEC test given

Source: Police report, DEC related report or other official source.

Remarks:

Narcotic Analgesics: Heroin is probably the most notorious member of this category, but the category also includes many other derivatives of opium, such as morphine, codeine, dilaudid, etc. It also includes many synthetic drugs, such as demerol and methadone.

Code "0" (No DEC test given) is used when GV38 [Police Reported Drug Evaluation Classification (DEC) Test for Driver] is coded "J" (No DEC process available or given).

Code "1" (Passed DEC test) is used if it is known from an official source that the driver passed a DEC test administered by a certified DRT [i.e., GV38 equals "1" (DEC process given, results known)].

Do not use the fact that a negative specimen test result was obtained for a narcotic drug [i.e., GV41, Narcotic Drug: Specimen Test Results, equals "1" (Drug not found in specimen)] to conclude what the certified DRT found.

Code "2" (Failed DEC test) is used if it is known from an official source report that the driver failed a DEC test administered by a certified DRT [i.e., GV38 equals "1" (DEC process given, results known)].

Do not use the fact that a positive specimen result was obtained for a narcotic drug [i.e., GV41, Narcotic Drug: Specimen Test Results, equals "2" (Drug found in specimen)] to conclude what the certified DRT found. An official source must state that a narcotic drug was suspected as a result of the DEC test.

Code "3" (DEC test given - results unknown) is used if it is known that the driver was given a DEC test administered by a certified DRT [i.e., GV38 equals "2" (DEC process given, results unknown)] but the official source did not state "passed" or "failed", or did not identify which drugs or drug categories the driver was suspected of ingesting.

Variable Name: Narcotic Drug: DEC Test Results (Cont'd.)

Code "8" (No driver present) is used when an in-transport vehicle was involved in the accident but no driver was in the vehicle at the time.

Code "9" (Unknown if DEC test given) is used when GV38, Police Reported Drug Evaluation Classification (DEC) Test for Driver, is coded "3" (DEC process available, unknown if given).

Variable Name: Narcotic Drug: Specimen Test Results

Element Values:

- 0 No specimen test given
- 1 Drug not found in specimen
- 2 Drug found in specimen
- 7 Specimen test given, results unknown or not obtained
- 8 No driver present
- 9 Unknown if specimen test given

Source: Police report, medical reports, or other official sources.

Remarks:

Narcotic Analgesics: Heroin is probably the most notorious member of this category, but the category also includes many other derivatives of opium, such as morphine, codeine, dilaudid, etc. It also includes many synthetic drugs, such as demerol and methadone.

Code "0" (No specimen test given) is used when GV39, Other Drug Specimen Test Type for Driver, is coded "0" (No specimen test given). In addition, use this code if no narcotic drug is listed among the drugs which were tested.

Code "1" (Drug not found in specimen) is used if it is known that the driver had at least one type of specimen tested (i.e., GV39 equals "1", "2", "3", or "7") for a narcotic drug and the test results came back "negative" or the medical (or other) records had no narcotic drug mentioned among the drugs for which a positive result was found.

Code "2" (Drug found in specimen) is used if it is known that the driver had at least one type of specimen tested (i.e., GV39 equals "1", "2", "3", or "7") and that the driver had a positive test result for a narcotic drug. A positive test result is any measured quantity that exceeds the detection threshold of the laboratory which performed the test.

Code "7" (Specimen test given, results unknown or not obtained) is used when positive test results were found for drugs other than narcotics and the medical (or other) records fail to specify whether or not at least one narcotic drug was evaluated.

Code "8" (No driver present) is used when an in-transport vehicle was involved in the accident but no driver was in the vehicle at the time.

Code "9" (Unknown if specimen test given) is used when GV39, Other Drug Specimen Test Type for Driver, is coded "9" (Unknown if specimen test given).

If it is known that a drug screen was given and it is unknown if any positive results were found and it is also unknown what drugs were screened for, then use this code.

Variable Name: Depressant Drug: DEC Test Results

Element Values:

- 0 No DEC test given
- 1 Passed DEC test
- 2 Failed DEC test
- 3 DEC test given - results unknown
- 8 No driver present
- 9 Unknown if DEC test given

Source: Police report, DEC related report or other official source.

Remarks:

Central Nervous System (CNS) Depressants: Alcohol is the most prominent member of this category, but the category also includes the various derivatives of barbiturate acid (phenobarbital, secobarbital, etc.); the anti-anxiety tranquilizers (Xanax, Valium, Librium, etc.); the anti-psychotic tranquilizers, such as Thorazine; and, many other drugs.

Alcohol is coded under variables GV11, Police Reported Alcohol Presence, and GV12, Alcohol Test Result for Driver.

Code "0" (No DEC test given) is used when GV38 [Police Reported Drug Evaluation Classification (DEC) Test for Driver] is coded "0" (No DEC process available or given).

Code "1" (Passed DEC test) is used if it is known from an official source that the driver passed a DEC test administered by a certified DRT [i.e., GV38 equals "1" (DEC process given, results known)].

Do not use the fact that a negative specimen test result was obtained for a depressant drug [i.e., GV43, Depressant Drug: Specimen Test Results, equals "1" (Drug not found in specimen)] to conclude what the certified DRT found.

Code "2" (Failed DEC test) is used if it is known from an official source report that the driver failed a DEC test administered by a certified DRT [i.e., GV38 equals "1" (DEC process given, results known)].

Do not use the fact that a positive specimen result was obtained for a depressant drug [i.e., GV43, Depressant Drug: Specimen Test Results, equals "2" (Drug found in specimen)] to conclude what the certified DRT found. An official source must state that a depressant drug was suspected as a result of the DEC test.

Code "3" (DEC test given - results unknown) is used if it is known that the driver was given a DEC test administered by a certified DRT [i.e., GV38 equals "2" (DEC process given, results unknown)] but the official source did not state "passed" or "failed", or did not identify which drugs or drug categories the driver was suspected of ingesting.

GENERAL VEHICLE FORM

(V42
(2)

Variable Name: Depressant Drug: DEC Test Results (Cont'd.)

Code "8" (No driver present) is used when an in-transport vehicle was involved in the accident but no driver was in the vehicle at the time.

Code "9" (Unknown if DEC test given) is used when GV38, Police Reported Drug Evaluation Classification (DEC) Test for Driver, is coded "3" (DEC process available, unknown if given).

Variable Name: Depressant Drug: Specimen Test Results

Element Values:

- 0 No specimen test given
- 1 Drug not found in specimen
- 2 Drug found in specimen
- 7 Specimen test given, results unknown or not obtained
- 8 No driver present
- 9 Unknown if specimen test given

Source: Police report, medical reports, or other official sources.

Remarks:

Central Nervous System (CNS) Depressants: Alcohol is the most prominent member of this category, but the category also includes the various derivatives of barbiturate acid (phenobarbital, secobarbital, etc.); the anti-anxiety tranquilizers (Xanax, Valium, Librium, etc.); the anti-psychotic tranquilizers, such as Thorazine; and, many other drugs.

Code "0" (No specimen test given) is used when GV39, Other Drug Specimen Test Type for Driver, is coded "0" (No specimen test given). In addition, use this code if no depressant drug is listed among the drugs which were tested.

Code "1" (Drug not found in specimen) is used if it is known that the driver had at least one type of specimen tested (i.e., GV39 equals "1", "2", "3", or "7") for a depressant drug and the test results came back "negative" or the medical (or other) records had no depressant drug mentioned among the drugs for which a positive result was found.

Code "2" (Drug found in specimen) is used if it is known that the driver had at least one type of specimen tested (i.e., GV39 equals "1", "2", "3", or "7") and that the driver had a positive test result for a depressant drug. A positive test result is any measured quantity that exceeds the detection threshold of the laboratory which performed the test.

Code "7" (Specimen test given, results unknown or not obtained) is used when positive test results were found for drugs other than depressant and the medical (or other) records fail to specify whether or not at least one depressant drug was evaluated.

Code "8" (No driver present) is used when an in-transport vehicle was involved in the accident but no driver was in the vehicle at the time.

Code "9" (Unknown if specimen test given) is used when GV39, Other Drug Specimen Test Type for Driver, is coded "9" (Unknown if specimen test given).

If it is known that a drug screen was given and it is unknown if any positive results were found and it is also unknown what drugs were screened for, then use this code.

Variable Name: Stimulant Drug: DEC Test Results

Element Values:

- 0 No DEC test given
- 1 Passed DEC test
- 2 Failed DEC test
- 3 DEC test given - results unknown
- 8 No driver present
- 9 Unknown if DEC test given

Source: Police report, DEC related report or other official source.

Remarks:

Central Nervous System (CNS) Stimulants: This category contains cocaine, Ritalin, the various members of the amphetamine family (methamphetamine, amphetamine sulfate, etc.), and many others.

Code "0" (No DEC test given) is used when GV38 [Police Reported Drug Evaluation Classification (DEC) Test for Driver] is coded "0" (No DEC process available or given).

Code "1" (Passed DEC test) is used if it is known from an official source that the driver passed a DEC test administered by a certified DRT [i.e., GV38 equals "1" (DEC process given, results known)].

Do not use the fact that a negative specimen test result was obtained for a stimulant drug [i.e., GV45, Stimulant Drug: Specimen Test Results, equals "1" (Drug not found in specimen)] to conclude what the certified DRT found.

Code "2" (Failed DEC test) is used if it is known from an official source report that the driver failed a DEC test administered by a certified DRT [i.e., GV38 equals "1" (DEC process given, results known)].

Do not use the fact that a positive specimen result was obtained for a stimulant drug [i.e., GV45, Stimulant Drug: Specimen Test Results, equals "2" (Drug found in specimen)] to conclude what the certified DRT found. An official source must state that a stimulant drug was suspected as a result of the DEC test.

Code "3" (DEC test given - results unknown) is used if it is known that the driver was given a DEC test administered by a certified DRT [i.e., GV38 equals "2" (DEC process given, results unknown)] but the official source did not state "passed" or "failed", or did not identify which drugs or drug categories the driver was suspected of ingesting.

Variable Name: Stimulant Drug: DEC Test Results (Cont'd.)

Code "8" (No driver present) is used when an in-transport vehicle was involved in the accident but no driver was in the vehicle at the time.

Code "9" (Unknown if DEC test given) is used when GV38, Police Reported Drug Evaluation Classification (DEC) Test for Driver, is coded "3" (DEC process available, unknown if given).

Variable Name: Stimulant Drug: Specimen Test Results

Element Values:

- 0 No specimen test given
- 1 Drug not found in specimen
- 2 Drug found in specimen
- 7 Specimen test given, results unknown or not obtained
- 8 No driver present
- 9 Unknown if specimen test given

Source: Police report, medical reports, or other official sources.

Remarks:

Central Nervous System (CNS) Stimulants: This category contains cocaine, Ritalin, the various members of the amphetamine family (methamphetamine, amphetamine sulfate, etc.), and many others.

Code "0" (No specimen test given) is used when GV39, Other Drug Specimen Test Type for Driver, is coded "0" (No specimen test given). In addition, use this code if no stimulant drug is listed among the drugs which were tested.

Code "1" (Drug not found in specimen) is used if it is known that the driver had at least one type of specimen tested (i.e., GV39 equals "1", "2", "3", or "7") for a stimulant drug and the test results came back "negative" or the medical (or other) records had no stimulant drug mentioned among the drugs for which a positive result was found.

Code "2" (Drug found in specimen) is used if it is known that the driver had at least one type of specimen tested (i.e., GV39 equals "1", "2", "3", or "7") and that the driver had a positive test result for a stimulant drug. A positive test result is any measured quantity that exceeds the detection threshold of the laboratory which performed the test.

Code "7" (Specimen test given, results unknown or not obtained) is used when positive test results were found for drugs other than stimulant and the medical (or other) records fail to specify whether or not at least one stimulant drug was evaluated.

Code "8" (No driver present) is used when an in-transport vehicle was involved in the accident but no driver was in the vehicle at the time.

Code "9" (Unknown if specimen test given) is used when GV39, Other Drug Specimen Test Type for Driver, is coded "9" (Unknown if specimen test given).

If it is known that a drug screen was given and it is unknown if any positive results were found and it is also unknown what drugs were screened for, then use this code.

Variable Name: Hallucinogen Drug: DEC Test Results

Element Values:

- 0 No DEC test given
- 1 Passed DEC test
- 2 Failed DEC test
- 3 DEC test given - results unknown
- 8 No driver present
- 9 Unknown if DEC test given

Source: Police report, DEC related report or other official source.

Remarks:

Hallucinogens: The drugs in this category cause hallucinations (i.e., perceptions of sights, sounds, odors, etc. that do not correspond to reality). Some naturally-occurring substances (e.g., peyote, psilocybin, morning glory seeds, etc.) belong to the hallucinogens, as well as many man-made drugs (e.g., LSD, MDA, STP, etc.).

Code "0" (No DEC test given) is used when GV38 [Police Reported Drug Evaluation Classification (DEC) Test for Driver] is coded "0" (No DEC process available or given).

Code "1" (Passed DEC test) is used if it is known from an official source that the driver passed a DEC test administered by a certified DRT [i.e., GV38 equals "1" (DEC process given, results known)].

Do not use the fact that a negative specimen test result was obtained for a hallucinogen drug [i.e., GV47, Hallucinogen Drug: Specimen Test Results, equals "1" (Drug not found in specimen)] to conclude what the certified DRT found.

Code "2" (Failed DEC test) is used if it is known from an official source report that the driver failed a DEC test administered by a certified DRT [i.e., GV38 equals "1" (DEC process given, results known)].

Do not use the fact that a positive specimen result was obtained for a hallucinogen drug [i.e., GV47, Hallucinogen Drug: Specimen Test Results, equals "2" (Drug found in specimen)] to conclude what the certified DRT found. An official source must state that a hallucinogen drug was suspected as a result of the DEC test.

Code "3" (DEC test given - results unknown) is used if it is known that the driver was given a DEC test administered by a certified DRT [i.e., GV38 equals "2" (DEC process given, results unknown)] but the official source did not state "passed" or "failed", or did not identify which drugs or drug categories the driver was suspected of ingesting.

Variable Name: Hallucinogen Drug: DEC Test Results (Cont'd.)

Code "8" (No driver present) is used when an in-transport vehicle was involved in the accident but no driver was in the vehicle at the time.

Code "9" (Unknown if DEC test given) is used when GV38, Police Reported Drug Evaluation Classification (DEC) Test for Driver, is coded "3" (DEC process available, unknown if given).

Variable Name: Hallucinogen Drug: Specimen Test Results

Element Values:

- 0 No specimen test given
- 1 Drug not found in specimen
- 2 Drug found in specimen
- 7 Specimen test given, results unknown or not obtained
- 8 No driver present
- 9 Unknown if specimen test given

Source: Police report, medical reports, or other official sources.

Remarks:

Hallucinogens: The drugs in this category cause hallucinations (i.e., perceptions of sights, sounds, odors, etc. that do not correspond to reality). Some naturally-occurring substances (e.g., peyote, psilocybin, morning glory seeds, etc.) belong to the hallucinogens, as well as many man-made drugs (e.g., LSD, MDA, STP, etc.).

Code "0" (No specimen test given) is used when GV39, Other Drug Specimen Test Type for Driver, is coded "0" (No specimen test given). In addition, use this code if no hallucinogen drug is listed among the drugs which were tested.

Code "1" (Drug not found in specimen) is used if it is known that the driver had at least one type of specimen tested (i.e., GV39 equals "1", "2", "3", or "7") for a hallucinogen drug and the test results came back "negative" or the medical (or other) records had no hallucinogen drug mentioned among the drugs for which a positive result was found.

Code "2" (Drug found in specimen) is used if it is known that the driver had at least one type of specimen tested (i.e., GV39 equals "1", "2", "3", or "7") and that the driver had a positive test result for a hallucinogen drug. A positive test result is any measured quantity that exceeds the detection threshold of the laboratory which performed the test.

Code "7" (Specimen test given, results unknown or not obtained) is used when positive test results were found for drugs other than hallucinogen and the medical (or other) records fail to specify whether or not at least one hallucinogen drug was evaluated.

Code "8" (No driver present) is used when an in-transport vehicle was involved in the accident but no driver was in the vehicle at the time.

Code "9" (Unknown if specimen test given) is used when GV39, Other Drug Specimen Test Type for Driver, is coded "9" (Unknown if specimen test given).

If it is known that a drug screen was given and it is unknown if any positive results were found and it is also unknown what drugs were screened for, then use this code.

Variable Name: Cannabinoid Drug: DEC Test Results

Element Values:

- 0 No DEC test given
- 1 Passed DEC test
- 2 Failed DEC test
- 3 DEC test given - results unknown
- 8 No driver present
- 9 Unknown if DEC test given

Source: Police report, DEC related report or other official source.

Remarks:

Cannabis: This category consists of the various forms of the Cannabis Sativa plant (i.e., marijuana, hashish, hashish oil). The active ingredient in cannabis is delta-9 tetrahydrocannabinol, or THC.

Code "0" (No DEC test given) is used when GV38 [Police Reported Drug Evaluation Classification (DEC) Test for Driver] is coded "0" (No DEC process available or given).

Code "1" (Passed DEC test) is used if it is known from an official source that the driver passed a DEC test administered by a certified DRT [i.e., GV38 equals "1" (DEC process given, results known)].

Do not use the fact that a negative specimen test result was obtained for a Cannabinoid drug [i.e., GV49, Cannabinoid Drug: Specimen Test Results, equals "1" (Drug not found in specimen)] to conclude what the certified DRT found.

Code "2" (Failed DEC test) is used if it is known from an official source report that the driver failed a DEC test administered by a certified DRT [i.e., GV38 equals "1" (DEC process given, results known)].

Do not use the fact that a positive specimen result was obtained for a cannabinoid drug [i.e., GV49, Cannabinoid Drug: Specimen Test Results, equals "2" (Drug found in specimen)] to conclude what the certified DRT found. An official source must state that a cannabinoid drug was suspected as a result of the DEC test.

Code "3" (DEC test given - results unknown) is used if it is known that the driver was given a DEC test administered by a certified DRT [i.e., GV38 equals "2" (DEC process given, results unknown)] but the official source did not state "passed" or "failed", or did not identify which drugs or drug categories the driver was suspected of ingesting.

Variable Name: Cannabinoid Drug: DEC Test Results (Cont'd.)

Code "8" (No driver present) is used when an in-transport vehicle was involved in the accident but no driver was in the vehicle at the time.

Code "9" (Unknown if DEC test given) is used when GV38, Police Reported Drug Evaluation Classification (DEC) Test for Driver, is coded "3" (DEC process available, unknown if given).

Variable Name: Cannabinoid Drug: Specimen Test Results

Element Values:

- 0 No specimen test given
- 1 Drug not found in specimen
- 2 Drug found in specimen
- 7 Specimen test given, results unknown or not obtained
- 8 No driver present
- 9 Unknown if specimen test given

Source: Police report, medical reports, or other official sources.

Remarks:

Cannabis: This category consists of the various forms of the Cannabis Sativa plant (i.e., marijuana, hashish, hashish oil). The active ingredient in cannabis is delta-9 tetrahydrocannabinol, or THC.

Code "0" (No specimen test given) is used when GV39, Other Drug Specimen Test Type for Driver, is coded "0" (No specimen test given). In addition, use this code if no cannabinoid drug is listed among the drugs which were tested.

Code "1" (Drug not found in specimen) is used if it is known that the driver had at least one type of specimen tested (i.e., GV39 equals "1", "2", "3", or "7") for a cannabinoid drug and the test results came back "negative" or the medical (or other) records had no cannabinoid drug mentioned among the drugs for which a positive result was found.

Code "2" (Drug found in specimen) is used if it is known that the driver had at least one type of specimen tested (i.e., GV39 equals "1", "2", "3", or "7") and that the driver had a positive test result for a cannabinoid drug. A positive test result is any measured quantity that exceeds the detection threshold of the laboratory which performed the test.

Code "7" (Specimen test given, results unknown or not obtained) is used when positive test results were found for drugs other than cannabinoid and the medical (or other) records fail to specify whether or not at least one cannabinoid drug was evaluated.

Code "8" (No driver present) is used when an in-transport vehicle was involved in the accident but no driver was in the vehicle at the time.

Code "9" (Unknown if specimen test given) is used when GV39, Other Drug Specimen Test Type for Driver, is coded "9" (Unknown if specimen test given).

If it is known that a drug screen was given and it is unknown if any positive results were found and it is also unknown what drugs were screened for, then use this code.

Variable Name: Phencyclidine (PCP) Drug: DEC Test Results

Element Values:

- 0 No DEC test given
- 1 Passed DEC test
- 2 Failed DEC test
- 3 DEC test given - results unknown
- 8 No driver present
- 9 Unknown if DEC test given

Source: Police report, DEC related report or other official source.

Remarks:

Phencyclidine: This category consists of the drug PCP and its various analogs, or "chemical first cousins". PCP, sometimes called "angel dust", is a powerful anesthetic that does not render the user unconscious in recreational doses.

Code "0" (No DEC test given) is used when GV38 [Police Reported Drug Evaluation Classification (DEC) Test for Driver] is coded "0" (No DEC process available or given).

Code "1" (Passed DEC test) is used if it is known from an official source that the driver passed a DEC test administered by a certified DRT [i.e., GV38 equals "1" (DEC process given, results known)].

Do not use the fact that a negative specimen test result was obtained for a phencyclidine drug [i.e., GV51, Phencyclidine Drug: Specimen Test Results, equals "1" (Drug not found in specimen)] to conclude what the certified DRT found.

Code "2" (Failed DEC test) is used if it is known from an official source report that the driver failed a DEC test administered by a certified DRT [i.e., GV38 equals "1" (DEC process given, results known)].

Do not use the fact that a positive specimen result was obtained for a phencyclidine drug [i.e., GV51, Phencyclidine Drug: Specimen Test Results, equals "2" (Drug found in specimen)] to conclude what the certified DRT found. An official source must state that a phencyclidine drug was suspected as a result of the DEC test.

Code "3" (DEC test given - results unknown) is used if it is known that the driver was given a DEC test administered by a certified DRT [i.e., GV38 equals "2" (DEC process given, results unknown)] but the official source did not state "passed" or "failed", or did not identify which drugs or drug categories the driver was suspected of ingesting.

Variable Name: Phencyclidine Drug: DEC Test Results (Cont'd.)

Code "8" (No driver present) is used when an in-transport vehicle was involved in the accident but no driver was in the vehicle at the time.

Code "9" (Unknown if DEC test given) is used when GV38, Police Reported Drug Evaluation Classification (DEC) Test for Driver, is coded "3" (DEC process available, unknown if given).

Variable Name: Phencyclidine (PCP) Drug: Specimen Test Results

Element Values:

- 0 No specimen test given
- 1 Drug not found in specimen
- 2 Drug found in specimen
- 7 Specimen test given, results unknown or not obtained
- 8 No driver present
- 9 Unknown if specimen test given

Source: Police report, medical reports, or other official sources.

Remarks:

Phencyclidine: This category consists of the drug PCP and its various analogs, or "chemical first cousins". PCP, sometimes called "angel dust", is a powerful anesthetic that does not render the user unconscious in recreational doses.

Code "0" (No specimen test given) is used when GV39, Other Drug Specimen Test Type for Driver, is coded "0" (No specimen test given). In addition, use this code if no phencyclidine drug is listed among the drugs which were tested.

Code "1" (Drug not found in specimen) is used if it is known that the driver had at least one type of specimen tested (i.e., GV39 equals "1", "2", "3", or "7") for a phencyclidine drug and the test results came back "negative" or the medical (or other) records had no phencyclidine drug mentioned among the drugs for which a positive result was found.

Code "2" (Drug found in specimen) is used if it is known that the driver had at least one type of specimen tested (i.e., GV39 equals "1", "2", "3", or "7") and that the driver had a positive test result for a phencyclidine drug. A positive test result is any measured quantity that exceeds the detection threshold of the laboratory which performed the test.

Code "7" (Specimen test given, results unknown or not obtained) is used when positive test results were found for drugs other than phencyclidine and the medical (or other) records fail to specify whether or not at least one phencyclidine drug was evaluated.

Code "8" (No driver present) is used when an in-transport vehicle was involved in the accident but no driver was in the vehicle at the time.

Code "9" (Unknown if specimen test given) is used when GV39, Other Drug Specimen Test Type for Driver, is coded "9" (Unknown if specimen test given).

If it is known that a drug screen was given and it is unknown if any positive results were found and it is also unknown what drugs were screened for, then use this code.

Variable Name: Inhalant Drug: DEC Test Results

Element Values:

- 0 No DEC test given
- 1 Passed DEC test
- 2 Failed DEC test
- 3 DEC test given - results unknown
- 8 No driver present
- 9 Unknown if DEC test given

Source: Police report, DEC related report or other official source.

Remarks:

Inhalants: This is the category of the volatile solvents (model airplane glue, paint, gasoline, etc.); aerosols (propellant gases used in household products such as hairspray); and anesthetic gases (nitrous oxide, ether, etc.). Inhaling fumes of these substances can produce severe intoxication.

Code "0" (No DEC test given) is used when GV38 [Police Reported Drug Evaluation Classification (DEC) Test for Driver] is coded "0" (No DEC process available or given).

Code "1" (Passed DEC test) is used if it is known from an official source that the driver passed a DEC test administered by a certified DRT [i.e., GV38 equals "1" (DEC process given, results known)].

Do not use the fact that a negative specimen test result was obtained for an inhalant drug [i.e., GV53, Inhalant Drug: Specimen Test Results, equals "1" (Drug not found in specimen)] to conclude what the certified DRT found.

Code "2" (Failed DEC test) is used if it is known from an official source report that the driver failed a DEC test administered by a certified DRT [i.e., GV38 equals "1" (DEC process given, results known)].

Do not use the fact that a positive specimen result was obtained for an inhalant drug [i.e., GV53, Inhalant Drug: Specimen Test Results, equals "2" (Drug found in specimen)] to conclude what the certified DRT found. An official source must state that an inhalant drug was suspected as a result of the DEC test.

Code "3" (DEC test given - results unknown) is used if it is known that the driver was given a DEC test administered by a certified DRT [i.e., GV38 equals "2" (DEC process given, results unknown)] but the official source did not state "passed" or "failed", or did not identify which drugs or drug categories the driver was suspected of ingesting.

Variable Name: Inhalant Drug: DEC Test Results (Cont'd.)

Code "8" (No driver present) is used when an in-transport vehicle was involved in the accident but no driver was in the vehicle at the time.

Code "9" (Unknown if DEC test given) is used when GV38, Police Reported Drug Evaluation Classification (DEC) Test for Driver, is coded "3" (DEC process available, unknown if given).

Variable Name: Inhalant Drug: Specimen Test Results

Element Values:

- 0 No specimen test given
- 1 Drug not found in specimen
- 2 Drug found in specimen
- 7 Specimen test given, results unknown or not obtained
- 8 No driver present
- 9 Unknown if specimen test given

Source: Police report, medical reports, or other official sources.

Remarks:

Inhalants: This is the category of the volatile solvents (model airplane glue, paint, gasoline, etc.); aerosols (propellant gases used in household products such as hairspray); and anesthetic gases (nitrous oxide, ether, etc.). Inhaling fumes of these substances can produce severe intoxication.

Code "0" (No specimen test given) is used when GV39, Other Drug Specimen Test Type for Driver, is coded "0" (No specimen test given). In addition, use this code if no inhalant drug is listed among the drugs which were tested.

Code "1" (Drug not found in specimen) is used if it is known that the driver had at least one type of specimen tested (i.e., GV39 equals "1", "2", "3", or "7") for an inhalant drug and the test results came back "negative" or the medical (or other) records had no inhalant drug mentioned among the drugs for which a positive result was found.

Code "2" (Drug found in specimen) is used if it is known that the driver had at least one type of specimen tested (i.e., GV39 equals "1", "2", "3", or "7") and that the driver had a positive test result for an inhalant drug. A positive test result is any measured quantity that exceeds the detection threshold of the laboratory which performed the test.

Code "7" (Specimen test given, results unknown or not obtained) is used when positive test results were found for drugs other than inhalant and the medical (or other) records fail to specify whether or not at least one inhalant drug was evaluated.

Code "8" (No driver present) is used when an in-transport vehicle was involved in the accident but no driver was in the vehicle at the time.

Code "9" (Unknown if specimen test given) is used when GV39, Other Drug Specimen Test Type for Driver, is coded "9" (Unknown if specimen test given).

If it is known that a drug screen was given and it is unknown if any positive results were found and it is also unknown what drugs were screened for, then use this code.

Variable Name: Other Drug (Excluding Nicotine, Aspirin, Alcohol, Drugs Administered Post-Crash): DEC Test Results

Element Values:

- 0 No DEC test given
- 1 Passed DEC test
- 2 Failed DEC test
- 3 DEC test given - results unknown
- 8 No driver present
- 9 Unknown if DEC test given

Source: Police report, DEC related report or other official source.

Remarks:

Code "0" (No DEC test given) is used when GV38 [Police Reported Drug Evaluation Classification (DEC) Test for Driver] is coded "0" (No DEC process available or given).

Code "1" (Passed DEC test) is not used for this variable.

Code "2" (Failed DEC test) is not used for this variable.

Code "3" (DEC test given - results unknown) is used if it is known that the driver was given a DEC test administered by a certified DRT [i.e., GV38 equals "2" (DEC process given, results unknown)] but the official source did not identify which drugs or drug categories the driver was suspected of ingesting.

Code "8" (No driver present) is used when an in-transport vehicle was involved in the accident but no driver was in the vehicle at the time.

Code "9" (Unknown if DEC test given) is used when GV38, Police Reported Drug Evaluation Classification (DEC) Test for Driver, is coded "3" (DEC process available, unknown if given).

Variable Name: Other Drug (Excluding Nicotine, Aspirin, Alcohol, Drugs Administered Post-Crash): Specimen Test Results

Element Values:

- 0 No specimen test given
- 1 Drug not found in specimen
- 2 Drug found in specimen
- 7 Specimen test given, results unknown or not obtained
- 8 No driver present
- 9 Unknown if specimen test given

Source: Police report, medical reports, or other official sources.

Remarks:

Code "0" (No specimen test given) is used when GV39, Other Drug Specimen Test Type for Driver, is coded "0" (No specimen test given). In addition, use this code if no "other" drug is listed among the drugs which were tested.

Code "1" (Drug not found in specimen) is used if it is known that the driver had at least one type of specimen tested (i.e., GV39 equals "1", "2", "3", or "7") for an "other" drug and the test results came back "negative" or the medical (or other) records had no "other" drug mentioned among the drugs for which a positive result was found.

Code "2" (Drug found in specimen) is used if it is known that the driver had at least one type of specimen tested (i.e., GV39 equals "1", "2", "3", or "7") and that the driver had a positive test result for an "other" drug. A positive test result is any measured quantity that exceeds the detection threshold of the laboratory which performed the test.

Code "7" (Specimen test given, results unknown or not obtained) is used when positive test results were found for at least one of the seven DEC drug categories and the medical (or other) records fail to specify whether or not at least one non-DEC drug was evaluated.

Code "8" (No driver present) is used when an in-transport vehicle was involved in the accident but no driver was in the vehicle at the time.

Code "9" (Unknown if specimen test given) is used when GV39, Other Drug Specimen Test Type for Driver, is coded "9" (Unknown if specimen test given).

If it is known that a drug screen was given and it is unknown if any positive results were found and it is also unknown what drugs were screened for, then use this code.

Variable Name: Driver's ZIP Code

Element Values:

Range* (first, second, and third characters): 000,004-098,100-200,
202-212,214-268,270-340,342,346-347,349-352,354-397,400-418,
420-427,430-516,520-528,530-532,534-535,537-551,553-554,556-567,
570-577,580-588,590-606,609-620,622-631,633-641,644-658,660-662,
664-681,683-693,700-701,703-708,710-714,716-731,733-741,743-816,
820-838,840-847,850,852-853,855-857,859-860,863-865,870-875,
877-885,889-891,893- 895,897-898,900-928,930-999

00000 Driver not present
00001 Driver not a resident of U.S. or territories
Code actual 5-digit zip code
99999 Unknown

* Range is a compilation of Sections 6 and 12 of the 1991 National Five Digit Zip Code & Post Office Directory, Volume 2 N-W

Source: Primary source is the police report; secondary sources include interviewees, medical records, and other official documents.

Remarks:

Prioritization of data sources:

First, use the PAR. For the purposes of this variable, a driver is considered to reside at the address listed on the police accident report. This address was most likely taken from the driver's license given to the police officer and/or from the licensing state's drivers license file.

If the driver's address is present and the ZIP code is missing or not available, then determine the correct ZIP code by using the two volume National Five Digit Zip Code & Post Office Directory. Of the seventeen (17) NASS CDS states, five (5) currently do not list the driver's ZIP code (i.e., Arizona, Michigan, New Jersey, Pennsylvania, and Texas).

Second, use official records (e.g., medical). If the driver's ZIP code cannot be obtained from the PAR, then use official records, if available, to determine the correct ZIP code.

Third, use interviewee data. When no address (i.e., street number/name, city, state) is present on the PAR, ask the interviewee the driver's ZIP code as a "specific question" during the interview (page one of the Interview Form). If the interviewee does not know the driver's ZIP but does know the driver's address, then use this information to determine the ZIP code. When obtaining address information, determine what the driver considers his/her current permanent mailing address to be.

During the process of obtaining the interview, the vehicle inspection, or the associated medical records, researchers will discover, for some drivers, a conflict between the address listed on the PAR and the driver's current address. In conflict situations, always encode the ZIP code for the address given on the

Variable Name: Driver's ZIP Code (Cont'd.)

PAR or on an official document before encoding the ZIP code from the information obtained during the interview.

Code "00000" (Driver not present) is used when an in-transport vehicle was involved in the accident but no driver was in the vehicle at the time.

Code "00001" (Driver not a resident of U.S. or territories) is used when the address found on the PAR or obtained during the interview indicates that the driver resides at an address which has not been assigned a ZIP code by the U.S. Post Office.

Code "99999" (Unknown) is used whenever the ZIP cannot be determined. For example, use this code for "hit-and-run" drivers and for any driver's address that you discover is fictitious. In addition, use this code if the driver, licensed or not, has no permanent address. For example, the driver could be living out of his/her vehicle (camper, motorhome, etc.), or the driver could be "homeless".

Variable Name: Driver's Race/Ethnic Origin

Element Values:

- (0) Driver not present
- (1) White (non-Hispanic)
- (2) Black (non-Hispanic)
- (3) White (Hispanic)
- (4) Black (Hispanic)
- (5) American Indian, Eskimo or Aleut
- (6) Asian or Pacific Islander
- (8) Other (specify):
- (9) Unknown

Source: Researcher determined; primary source is the interviewee; secondary sources include police report, medical records, and other official documents.

Remarks:

The concept of race as used by the U.S. Census Bureau reflects self-identification; it does not denote any clear-cut scientific definition of biological stock. Self-identification represents self-classification by people according to the race with which they identify themselves. For drivers with parents of different races who cannot provide a single response, use the race of the driver's mother; however, if a single response cannot be provided for the driver's mother, the first race reported by the driver is encoded.

Hispanic is not a race but rather an ethnic origin. Persons of Spanish origin may be of any race. For the purpose of this variable, race and Hispanic origin have been combined using the elements listed above.

Prioritization of data sources:

First, use interviewee data. Ask the interviewee what the driver considers their race and ethnic origin to be. If the response does not clearly fit into one of the race and ethnic origin categories, then use the information provided by the interviewee concerning the driver's nationality/ethnic origin to select the correct element value.

Second, use the PAR. If race is given on the PAR and the PAR scheme is compatible with this variable, then use the PAR information. Researchers in states whose only available data source is the PAR, must code this variable Unknown, code "9".

If the PAR indicates White/Caucasian, Black/Negro, Hispanic/Spanish, or Other, then the PAR contains insufficient information to code this variable. Additional information is required to determine the combination of race and ethnic origin. In addition, the driver's name is not a reliable indicator of either race or ethnic origin and cannot be used when selecting the applicable element value for this variable. For example, a name such as: Mary Perez, tells you neither race (e.g., white or black) nor ethnic origin since the person may or may not consider themselves to be of Hispanic descent.

Variable Name: Driver's Race/Ethnic Origin (Cont'd.)

When Hispanic origin is known but race is not and when race is known but Hispanic origin is not, code "9" (Unknown).

Third, use official records (e.g., medical). If the data needed cannot be obtained from the interviewee and is not available or usable from the PAR, then use official records, if available, to determine the correct element value.

Code "0" (Driver not present) is used when an in-transport vehicle was involved in the accident but no driver was in the vehicle at the time.

Code "1" [White (non-Hispanic)] is used for drivers who consider themselves as having origins in any of the original peoples of Europe, North Africa, or the Middle East. The person may consider his/her race to be white and not of Hispanic origin.

Code "2" [Black (non-Hispanic)] is used for drivers who consider themselves as having origins in any of the black racial groups of Africa. The person may consider his/her race to be Black, Negro, or Afro-American and not of Hispanic origin.

Code "3" [White (Hispanic)] is used for drivers who consider themselves as having origins in any of the original peoples of Europe, North Africa, or the Middle East. The person may consider his/her race to be white and of Hispanic origin.

Code "4" [Black (Hispanic)] is used for drivers who consider themselves as having origins in any of the black racial groups of Africa. The person may consider his/her race to be Black, Negro, or Afro-American and of Hispanic origin.

Code "5" (American Indian, Eskimo or Aleut) is used for drivers who consider themselves as having origins in any of the original peoples of North America, and who maintains cultural identification through tribal affiliation or community recognition. For example, if a specific (or named) Indian tribe is given, then use this code.

Code "6" (Asian or Pacific Islander) is used for drivers who consider themselves as having origins in any of the original peoples of the Far East, Southeast Asia, the Indian subcontinent, or the Pacific Islands. This area includes, for example, China, India, Japan, Korea, the Philippine Islands, and Samoa.

Code "8" (Other) is used for drivers who consider themselves to be of a race or ethnic origin not described above. Use this code for descriptions such as: Eurasian, Cosmopolitan, inter-racial, etc. In addition, if the driver considers him/herself to be of Hispanic origin but not white or black, then use this code.

Variable Name: Driver's Race/Ethnic Origin (Cont'd.)

Code "9" (Unknown) is used when the source(s) available do not provide sufficient information to classify the driver's race. In addition use this code when Hispanic origin is known but race is not and when race is known but Hispanic origin is not.

Variable Name: Vehicle Special Use

Element Value

- 0 No special use
- 1 Taxi
- 2 Vehicle used as school bus
- 3 Vehicle used as other bus
- 4 Military
- 5 Police
- 6 Ambulance
- 7 Fire truck or car
- 8 Other (specify):
- 9 Unknown

Source: Researcher determined; primary source is the police report; secondary sources include vehicle inspection, and interviewees.

Remarks:

Code "0" (No special use) is used when no source indicates or implies that this vehicle was applicable to any of the special uses listed below.

Codes "1" (Taxi), "2" (Vehicle used as school bus), and "3" (Vehicle used as other bus) are "this trip" specific. The vehicle must be "on duty" as either a taxi or as a bus. External identification on the vehicle as a bus or taxi is not sufficient to determine its special use.

Code "1" (Taxi) is used when this vehicle was being used during this trip (at the time of the accident) on a "fee-for-hire" basis to transport persons. Most of these vehicles will be marked and formally registered as taxis; however, vehicles which are used as taxis, even though they are not registered (e.g., "Gypsy Cabs"), are included here. Taxis and drivers which are off-duty at the time of the accident are not included.

Code "2" (Vehicle used as school bus) is used if this motor vehicle (GV07, Body Type, need not equal "50") satisfies all of the following criteria:

- externally identifiable to other traffic units as a school/pupil transport vehicle. The vehicle may be equipped with flashing lights and/or a sway stop arm, and traffic may be required to stop for the vehicle when occupants enter or exit;
- operated, leased, owned, or contracted by a public or private school-type institution;
- whose occupants, if any, are associated with the institution; and,
- the vehicle is in operation at the time of the accident to and from the school or on a school-sponsored activity or trip.

Variable Name: Vehicle Special Use (cont'd.)

Code "3" (Vehicle used as other bus) is used when this motor vehicle is designed for transporting more than ten persons and does not satisfy all of the above criteria of a school bus.

Codes "4" (Military), "5" (Police), "6" (Ambulance), and "7" (Fire truck or car) are considered to be in use at all times. Special use means "in use" and not necessarily emergency use. External identification to the normal driving public is the sole criterion.

Code "4" (Military) is used for any vehicle which is owned by any of the Armed Forces regardless of body type. This code includes:

- military police vehicles;
- military ambulances;
- military hearses; and
- military fire vehicles

Code "5" (Police) is used for any readily identifiable (lights or markings) vehicle which is owned by any local, county, state, or federal police agency. Vehicles not owned by the agency or not readily identifiable which are used by officers or agents (e.g., undercover) are excluded.

Code "6" (Ambulance) is used for any readily identifiable (lights or markings) vehicles: (1) whose sole purpose is to provide ambulance service, or (2) who serve the dual purposes of a hearse--used for funeral services, and an ambulance--used for emergency services. For these dual purpose vehicles (ambulance/hearse), use this code only when the vehicle is used as an ambulance.

Code "7" (Fire truck or car) is used for any readily identifiable (lights or markings) vehicle which is owned by any government (typically local) or cooperative agency for the purpose of fire protection. For volunteer fire companies, fire fighting apparatus and other vehicles owned by the company or government qualify for this code. Privately owned vehicles, which are not in authorized use, even if equipped with lights, do not qualify (i.e., the volunteer firemen's vehicle).

Code "8" [Other (specify)] is used for any special use vehicle which is not identifiable above. This includes funeral hearses.

Code "9" (Unknown) is used when no information is available on the vehicle's special use for this trip (i.e., a hit-and-run vehicle).

ROLLOVER DATA OVERVIEW

The following variables provide a coded assessment of the occurrence of a rollover for this vehicle. A rollover is defined as any vehicle rotation of 90 degrees or more about any true longitudinal or lateral axis. A rollover may occur at any time during the accident sequence. When determining rollover presence, consider only the power unit, not any towed or trailing units. The variables also attempt to identify what initiated the rollover, at what plane of the vehicle exterior the tripping force was applied, and the direction of the initial roll.

These variables are not coded for non-CDS applicable vehicles.

Variable Name: Rollover Initiation Type

Element Values:

- Blank - (GV07 = 50-99)
- 0 No rollover
- 1 Trip-over
- 2 Flip-over
- 3 Turn-over
- 4 Climb-over
- 5 Fall-over
- 6 Bounce-over
- 7 Collision with another vehicle
- 8 Other rollover initiation type (specify):
- 9 Unknown rollover initiation type

Source: Researcher determined -- primary sources are the scene and vehicle inspections. Secondary sources are photographs, police report, driver interviews, and other interviewees.

Remarks:

Various types of rollovers are identified above. A vehicle action that cannot be categorized under any of the above elements "1" through "7" should be coded "8" (Other rollover initiation type).

Codes "1" through "7" below are used for rollovers initiated about the longitudinal axis. However, code "8" (Other rollover initiation type) is used when the rollover was initiated about the lateral axis (i.e., end-over-end).

Code "0" (No rollover) is used when variable GV24, Rollover, equals "0" [No rollover (no overturning)].

Code "1" (Trip-over) is used when the vehicle's lateral motion is suddenly slowed or stopped, inducing a rollover. The opposing force may be produced by a curb, pot-holes, or pavement/soil dug into by a vehicle's wheels.

Code "2" (Flip-over) is used when the vehicle is rotated about its longitudinal axis by a ramp-like object such as a turned down guardrail or the back slope of a ditch. The vehicle may be in a yaw when it comes in contact with the ramp-like object. For example, if the vehicle traveling backwards climbs the down turned end of a guardrail and rolls over about its longitudinal axis, use this code. To use this code, the vehicle's roll need not begin on the ramp-like structure or object. For example, if the vehicle transverses the turned-down end of a guardrail, continues along the level portion, then rolls back toward the side of the guardrail from which it came, use this code.

Code "3" (Turn-over) is used when centrifugal forces from a sharply turning or rotating vehicle produce a rollover when resisted by normal surface friction. This type of rollover is more likely to occur in vehicles

Variable Name: Rollover Initiation Type (Cont'd.)

with a higher center of gravity than most passenger vehicles. The surface type includes pavement surfaces plus gravel, grass, dirt, etc. The distinction between this code and code "1" (Trip-over) is that no furrowing, gouging, etc. occurs to the surface at the point of trip. In addition, see remarks for code "5" (Fall-over) below.

Code "4" (Climb-over) is used when a vehicle climbs up and over a fixed object such as a barrier or guardrail. The object should be high enough to lift the vehicle completely off the ground (i.e., the height should exceed the radius of the vehicle's largest diameter wheel). The vehicle must roll to the opposite side from which it approached the object.

Code "5" (Fall-over) is used when the surface the vehicle is transversing slopes downward in the direction of movement of the vehicle's center-of-gravity such that the vehicle's center of gravity becomes outboard of its wheels. The distinction between this code and code "3" (Turn-over) above involves the negative slope of the transversed surface. If the rotation and/or the surface friction causes the trip, then use code "3"; however, if the slope is so negative that a line straight downward through the vehicle's center-of-gravity (as shown in the illustration below) would fall outside the vehicle's track, then use this code. For example, if a vehicle goes off the road and encounters a substantial surface drop off because of the elevated nature of the road in relation to its environment (e.g., cliff, ditch, etc.), then use this code.

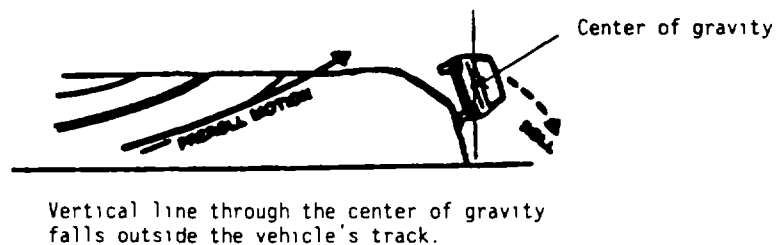

Code "6" (Bounce-over) is used when a vehicle deflects off of a fixed object (such as a guardrail, barrier, tree, or pole) such that the vehicle's rotation causes it to overturn. The deflection momentum contributes to a rollover. To use this code, the rollover must occur in close proximity to the object from which it deflected. For example, if a vehicle strikes a center median barrier and rotates across two traffic lanes prior to the vehicle rolling over, then codes "1" (Trip-over) or "3" (turn-over) would apply.

Variable Name: Rollover Initiation Type (Cont'd.)

- Code "7" (Collision with another vehicle) is used when an impact with another vehicle causes the rollover. The rollover must be the immediate result of the impact between the vehicles (e.g., intersection accidents where a vehicle is struck in the side and the momentum of the struck vehicle results in the rollover, or offset end-to-end type accidents when one vehicle will vault over the tapered end of another vehicle resulting in a rollover). Otherwise use codes "1" through "6" above. For example, if a vehicle is struck in the side and the vehicle rotates and does not produce any wheel/rim gouges or furrows in the surface nor encounters any prominent raised objects (e.g., a high curb) and overturns in close proximity to the point of impact, then use this code.
- Code "8" (Other rollover initiation type) is used when this vehicle's rollover initiation type cannot be described in codes "1" through "7" above. All end-over-end rollovers are coded here. Whenever this code is used, the Researcher is required to specify the type of rollover which occurred.
- Code "9" (Unknown rollover initiation type) is used when variable GV24, Rollover, equals "9" [Rollover (overturn), details unknown]. In addition, use this code when the vehicle rolled over and the rollover initiation type cannot be determined.

Variable Name: Rollover Initiation Type (Cont'd.)

CODING GUIDE FOR ROLLOVER INITIATION TYPES

1. **Trip-Over:** Vehicle lateral motion is resisted by opposing force, inducing roll moment.

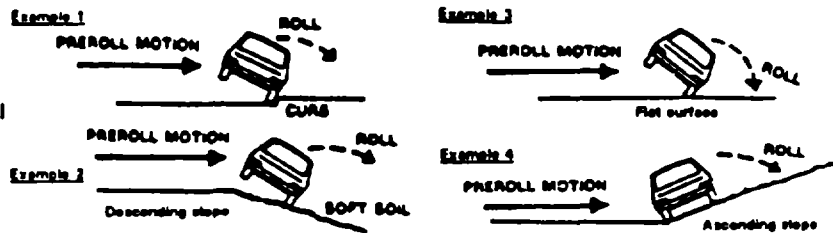

2. **Flip-Over:** Forward-moving vehicle is vigorously rotated about its longitudinal axis by ramp-like object such as a guardrail taper or ditch back slope.

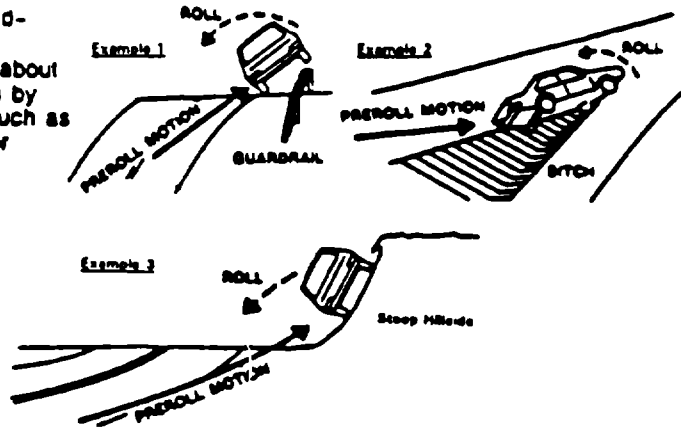

3. **Turn-Over:** Centrifugal forces from a sharply turning or rotating vehicle produce a rollover moment when resisted by surface friction.



4. **Climb-Over:** Vehicle climbs up and over fixed object such as barrier.



5. **Fall-Over:** Vehicle is tipped by slope so that its center of gravity is outboard of its wheels.

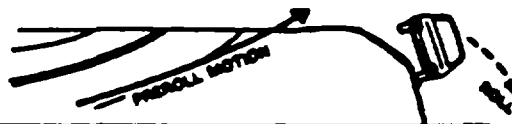

6. **Bounce-Over:** Any case where vehicle rebounds off fixed object (such as a guardrail), overturns as a consequence.



Variable Name: Location of Rollover Initiation

Element Values:

Blank - (GV07 = 50-99)
0 No rollover
1 On roadway
2 On shoulder-paved
3 On shoulder-unpaved
4 On roadside or divided trafficway median
9 Unknown

Source: Researcher determined -- primary source is the scene inspection. Secondary sources are vehicle inspection, photographs, police report, driver interviews, and other interviewees.

Remarks:

This variable defines the location of the trip point or start of the vehicle's roll that was identified in variable GV59, Rollover Initiation Type. Physical evidence on and/or off the roadway should be used to identify the point of initial roll. Scenes with no physical evidence such as gouges in the pavement or ground may be determined by the secondary sources listed above.

Code "0" (No rollover) is used when variable GV24, Rollover, equals "0" [No rollover (no overturning)].

Code "1" (On roadway) is used when the rollover initiates in the travel lanes of the roadway (i.e., between painted edgelines or between roadway edges when painted edgelines are absent). The median between roadways (divided highways such as Thruways or Expressways) is identified as codes "2" (On shoulder-paved), "3" (On shoulder-unpaved), or "4" (On roadside or divided trafficway median) as described below. For examples of roadways refer to pages 10-12 of the NASS CDS Data Collection, Coding and Editing Manual. ANSI defines a roadway as that part of a trafficway designed, improved and ordinarily used for motor vehicle travel, and excludes any shoulder alongside the roadway.

Code "2" (On shoulder-paved) is used when the rollover initiation occurs on a paved surface outside the painted edgeline or the outer edge or pavement seam of the roadway. A shoulder may exist within the median of a divided highway or on the outermost edge of the roadway. A shoulder is defined as that part of a trafficway contiguous with the roadway for emergency use, for accommodation of stopped road vehicles, and for lateral support of the roadway structure.

Code "3" (On shoulder-unpaved) is used when the rollover initiation begins within the confines of the improved area (i.e., gravel or stone) contiguous with the roadway. Unpaved shoulders, for NASS CDS purposes, are composed of loose gravel or stone. Combination gravel/stone and asphalt surfaces, such as macadam or "chip and seal", are considered as paved. Roadways without an improved, contiguous surface will be considered as not having shoulders.

Variable Name: Location of Rollover Initiation (Cont'd.)

- Code "4" (On roadside or divided trafficway median) is used when the rollover initiation occurs outside the roadway and the shoulder. There are roads where sod or dirt will support the roadway edge. When the rollover initiation occurs within this area, use this code because this roadway does not have shoulders. In addition, shoulders end wherever most curbs or fixed objects begin. If the trip begins on a curb that is adjacent on one side to a sidewalk, turf, or dirt, then use this code. If the roll is initiated by a fixed object (i.e., Objected Contacted, EV05/EV13, is code "41"-"60" or "62"-"68"), then use this code. Care must be exercised with some mountable curbs. If the mountable curb has paving on both sides and its primary function is to control water runoff, then use code "2" (On shoulder-paved).
- Code "9" (Unknown) is used when variable GV24, Rollover, equals "9" [Rollover (overturn), details unknown]. In addition, use this code when the vehicle rolled over and the specific location of the rollover initiation cannot be determined.

Variable Name: Rollover Initiation Object Contacted

Element Values:

Blank - (GV07 = 50-99)	54 Concrete traffic barrier	
00 No rollover	55 Impact attenuator	
01-30 — Vehicle number	56 Other traffic barrier (includes guardrail)	
Noncollision		
31 Turn-over — fall-over	57 Fence	
33 Jackknife	58 Wall	
	59 Building	
Collision With Fixed Object		
41 Tree (≤ 10 centimeters in diameter)	60 Ditch or culvert	
42 Tree (> 10 centimeters in diameter)	61 Ground	
43 Shrubbery or bush	62 Fire hydrant	
44 Embankment	63 Curb	
	64 Bridge	
	68 Other fixed object (specify):	
	69 Unknown fixed object	
45 Breakaway pole or post (any diameter)	Collision with Nonfixed Object	
Nonbreakaway Pole or Post		
50 Pole or post (≤ 10 centimeters in diameter)	71 Motor vehicle not in-transport	
51 Pole or post (> 10 centimeters but ≤ 30 centimeters diameter)	76 Animal	
52 Pole or post (> 30 centimeters in diameter)	77 Train	
53 Pole or post (diameter unknown)	78 Trailer, disconnected in transport	
	79 Object fell from vehicle in-transport	
	88 Other nonfixed object (specify):	
	89 Unknown nonfixed object	
	98 Other event (specify):	
	99 Unknown event or object	

Source: Researcher determined -- primary sources are the scene and vehicle inspections; secondary sources include the police report and interviewees.

Remarks:

This variable is related to GV59, Rollover Initiation Type, and identifies the source of the force that acted upon the vehicle which resulted in the rollover. These codes are obtained from the CDC Object Contacted codes (EV05/EV13). If the rollover was initiated by an impact which was assigned a CDC, then the applicable EV05/EV13 element value will be encoded for this variable. If the rollover was not initiated by a CDC applicable impact, then it is unlikely that the same value will be encoded. Therefore, the researcher must determine the cause (i.e., initiation force) of the rollover and consequently the object contacted during the rollover. For example, if a vehicle strikes a curb which trips the vehicle [(GV59 equals "1" (Trip-over))], then this variable is encoded "63" (Curb) even though the CDC Object Contacted (EV05/EV13) for the rollover would probably equal "31" (Overturn — rollover). Similarly, if a vehicle vaults a longitudinal barrier [(GV59 equals "4" (Climb-over))], then this variable is coded "54" or "56", depending upon the longitudinal barrier design. If a yawing vehicle rolls

Variable Name: Rollover Initiation Object Contacted (cont'd.)

as a result of centrifugal forces caused by normal surface friction or as a result of burrowing into soft soil, then code "61" (Ground) because the ground applied the force that acted as the tripping mechanism for the rollover.

Code "00" (No rollover) is used when variable GV24, Rollover, equals "0" [No rollover (no overturning)].

Codes "01" - "30" (Vehicle number) are used to report the vehicle number of a vehicle that impacted this vehicle and caused the rollover to occur [i.e., GV59 must equal "7" (Collision with another vehicle)]. This will be most common when one vehicle (generally with a high center of gravity) is involved in an offset head-on accident with a second vehicle (possibly with a lower sloping front end) resulting in a vaulting type rollover. Do not use these codes if the vehicle rolls over subsequent to its impact with another vehicle but because of centrifugal force or a tripping mechanism. These latter two causes would take priority.

Code "31" (Turn-over — fall-over) is used when the vehicle roll is precipitated by centrifugal or gravitational forces and GV59, Rollover initiation type, has been coded "3" (Turn-over) or "5" (Fall-over).

Code "33" (Jackknife) is used when a vehicle rolls over as result of a jackknife and the sole reason for the rollover is the force applied by the jackknifing trailer. For example, if a vehicle is pulling a trailer and the trailer jackknifes (i.e., ≥ 90 degrees rotation and intraunit damage) and overturns, for whatever reason (e.g., trailer tires furrow in soft earth, centrifugal force, trailer trips, loadshifts causing it to tip, etc.), and the trailer's overturning causes this vehicle to overturn, then use this code. However, if a centrifugal force or tripping mechanism causes the vehicle to overturn with or without the trailer overturning, then use another code.

Code "41" [Tree (≤ 10 centimeters in diameter)] is used when a vehicle impacts a tree which has a diameter of ten centimeters or less and the tree either (1) acts like a rigid barrier or (2) bends or breaks causing the vehicle to rollover [i.e., GV59 equals "1" (Trip-over), "2" (Flip-over), or "6" (Bounce-over)]. Do not use this code when a vehicle impacts a tree and experiences a subsequent rollover due to centrifugal forces or other tripping mechanisms.

Code "42" [Tree (> 10 centimeters in diameter)] is used when a vehicle impacts a tree with a diameter of greater than 10 centimeters and the tree either (1) acts like a rigid barrier or (2) bends or breaks causing the vehicle to rollover [i.e., GV59 equals "1" (Trip-over), "2" (Flip-over), or "6" (Bounce-over)]. Do not use this code when a vehicle impacts a tree and experiences a subsequent rollover due to centrifugal forces or other tripping mechanisms.

Variable Name: Rollover Initiation Object Contacted (cont'd.)

Code "43" (Shrubbery or bush) is used when a vehicle impacts shrubbery or bushes and the contacted object causes the vehicle to rollover [i.e., GV59 equals "1" (Trip-over) or "2" (Flip-over)]. This will be a very rare occurrence. Subsequent rollovers that result from centrifugal forces or other tripping mechanisms take priority for this variable.

Code "44" (Embankment) is coded when a vehicle rides up or over an embankment and the vehicle rolls over as a result of the angle of the embankment [i.e., GV59 equals "2" (Flip-over) or "5" (Fall-over)]. Vehicles which dig into the surface of an embankment and rollover as a result of this tripping mechanism are captured in code "61" (Ground).

Code "45" [Breakaway pole or post (any diameter)] is used whenever a vehicle impacts a breakaway pole or post (of any diameter) and that pole/post yields creating a ramping mechanism which causes a vehicle rollover. Do not use this code if a vehicle rolls over subsequent to the impact as a result of centrifugal forces or other tripping mechanisms.

Code "50" [Pole or post (≤ 10 centimeters in diameter)] is coded whenever a vehicle impacts a nonbreakaway pole with a diameter of 10 centimeters or less and that pole either (1) acts like a rigid barrier or (2) breaks or bends causing the vehicle to rollover [i.e., GV59 equals "2" (Flip-over) or "6" (Bounce-over)]. Do not use this code if a vehicle rolls over subsequent to the impact as a result of centrifugal forces or other tripping mechanisms.

Code "51" [Pole or post (> 10 centimeters but ≤ 30 centimeters in diameter)] is coded whenever a vehicle impacts a nonbreakaway pole with a diameter greater than ten centimeters but less than or equal to thirty centimeters and that pole either (1) acts like a rigid barrier or (2) breaks or bends causing the vehicle to rollover [i.e., GV59 equals "2" (Flip-over) or "6" (Bounce-over)]. Do not use this code if a vehicle rolls over subsequent to the impact as a result of centrifugal forces or other tripping mechanisms.

Code "52" [Pole or post (> 30 centimeters in diameter)] is coded whenever a vehicle impacts a nonbreakaway pole with a diameter greater than thirty centimeters and that pole either (1) acts like a rigid barrier or (2) breaks or bends causing the vehicle to rollover [i.e., GV59 equals "2" (Flip-over) or "6" (Bounce-over)]. Do not use this code if a vehicle rolls over subsequent to the impact as a result of centrifugal forces or other tripping mechanisms.

Code "53" [Pole or post (diameter unknown)] is coded whenever a vehicle impacts a pole or post of an unknown diameter and that pole either (1) acts like a rigid barrier or (2) breaks or bends causing the vehicle to rollover [i.e., GV59 equals "2" (Flip-over) or "6" (Bounce-over)]. Do not use this code if a vehicle rolls over subsequent to the impact as a result of centrifugal forces or other tripping mechanisms.

Variable Name: Rollover Initiation Object Contacted (cont'd.)

Code "54" (Concrete traffic barrier) is coded whenever a vehicle impacts a concrete traffic barrier and that impact causes a rollover [i.e., GV59 equals "2" (Flip-over), "4" (Climb-over), or "6" (Bounce-over)]. Rollovers which occur subsequent to the impact as a result of centrifugal force or other tripping mechanisms are not considered here. Refer to page EV-14 for examples and definitions of concrete traffic barriers.

Code "55" (Impact Attenuator) is coded whenever a vehicle impacts a crash cushion (refer to page EV-14) and that impact causes a rollover [i.e., GV59 equals "2" (Flip-over) or "6" (Bounce-over)]. Rollovers which occur subsequent to the impact as a result of centrifugal force or other tripping mechanisms are not considered here.

Code "56" (Other traffic barrier) is coded whenever a vehicle impacts a nonconcrete longitudinal barrier (e.g., a guardrail) as defined on page EV-14 and that impact causes a rollover [i.e., GV59 equals "2" (Flip-over), "4" (Climb-over), or "6" (Bounce-over)]. Rollovers which occur subsequent to the impact as a result of centrifugal force or other tripping mechanisms are not considered here.

Codes "57" (Fence), "58" (Wall), and "59" (Building) are used whenever one of these objects is contacted and that impact causes a rollover [i.e., GV59 equals "1" (Trip-over), "2" (Flip-over), "4" (Climb-over), or "6" (Bounce-over)]. Definitions of these objects are on page EV-15. Rollovers which occur subsequent to the impact as a result of centrifugal impacts and tripping mechanisms are not considered for these codes.

Code "60" (Ditch or Culvert) is used whenever a vehicle enters a ditch or culvert and the vehicle rolls over as a result of the slope of the ditch/culvert [i.e., GV59 equals "2" (Flip-over) or "5" (Fall-over)]. Refer to page EV-15 for definition of ditch or culvert. Vehicles in a ditch which dig into the surface and rollover as a result of this tripping mechanism are captured in code "61" (Ground).

Code "61" (Ground) is used when a vehicle rolls over as a result of contact with the ground [i.e., GV59 equals "1" (Trip-over)]. "Ground" applies whether the rollover resulted from digging into soft soil, tripping over an accumulation of dirt or gravel, or gouging into the pavement. Vehicles which dig into the ground on embankments or in ditches and rollover, as a result of that digging, take this code.

Code "62" (Fire Hydrant) is used whenever a vehicle impacts a fire hydrant and that impact causes a rollover. A fire hydrant is defined as a roadside device used by fire departments to provide water for fighting fires. Vehicles which rollover subsequent to a fire hydrant impact but not as a direct result of that impact (i.e., other tripping force) do not take this code.

Variable Name: Rollover Initiation Object Contacted (cont'd.)

Code "63" (Curb) includes both mountable and barrier curbs as described on page EV-16. Curbs which act as a tripping mechanism will frequently have an impact (CDC) associated with them although this is not a criterion for using this code. When a curb acts as a tripping mechanism, GV59 is coded "1" (Trip over).

Code "64" (Bridge) is used whenever a vehicle impacts a bridge and that impact causes a rollover [i.e., GV59 equals "2" (Flip-over), "4" (Climb-over), or "6" (Bounce-over)]. Refer to page EV-16 for the definition of a bridge. Vehicles which rollover subsequent to a bridge impact but not as a direct result of that impact (i.e., other tripping force) do not take this code.

Code "68" (Other fixed object) is used when a fixed object, other than those identified in codes "41" through "64", is impacted and that impact causes a rollover. Do not use this code if a vehicle rolls over subsequent to the impact as a result of centrifugal forces or other tripping mechanisms.

Code "69" (Unknown fixed object) is used when an unknown fixed object is impacted and that impact causes a rollover. Do not use this code if a vehicle rolls over subsequent to the impact as a result of centrifugal forces or other tripping mechanisms.

Code "71" (Motor vehicle not in-transport) is used when a vehicle impacts a not-in-transport vehicle and that impact causes the vehicle to rollover [i.e., GV59 equals "2" (Flip-over), "4" (Climb-over), or "6" (Bounce-over)]. Vehicles which rotate and rollover as a result of centrifugal forces or other tripping mechanisms are not captured in this response.

Code "76" (Animal) is used when a vehicle impacts an animal and that impact causes the vehicle to rollover. This should be a very rare occurrence. Subsequent rollovers due to other tripping mechanisms are not captured in this response.

Code "77" (Train) is coded when a vehicle is involved in an accident with a train and the impact causes the vehicle to rollover.

Code "78" (Trailer, disconnected in transport) is used to report a trailer that has been disconnected from its power unit and subsequently impacted this vehicle and caused the rollover to occur. This will likely occur when a small trailer is involved in a head-on accident with a larger vehicle resulting in a vaulting type rollover. Do not use this code if the vehicle rolls over subsequent to an initial impact as centrifugal forces or tripping mechanisms take priority.

Variable Name: Rollover Initiation Object Contacted (cont'd.)

- Code "79" (Object fell from vehicle in-transport) is used to report an object that was being carried by or was attached to a vehicle in-transport but fell from or became detached from that vehicle and subsequently impacted this vehicle and caused the rollover to occur. Do not use this code if the vehicle rolls over subsequent to an initial impact as centrifugal forces or tripping mechanisms take priority.
- Code "88" (Other nonfixed object) is used when a nonfixed object, other than those described in codes "71", "76", "77", or "78" is impacted and that impact causes a rollover. Do not use this code if a vehicle rolls over subsequent to the impact as a result of centrifugal forces or other tripping mechanisms.
- Code "89" (Unknown nonfixed object) is used when an unknown nonfixed object is impacted and that impact causes a rollover. Do not use this code if a vehicle rolls over subsequent to the impact as a result of centrifugal forces or other tripping mechanisms.
- Code "98" (Other event) is used when circumstances exist that cannot be captured in the element values above (e.g., loadshift, high winds).
- Code "99" (Unknown object) is used when variable GV24, Rollover, equals "9" [Rollover (overturn), details unknown]. In addition, use this code if a vehicle rolled over and the cause of the rollover (tripping mechanism) cannot be determined.

Variable Name: Location on Vehicle Where Initial Principal
Tripping Force is Applied

Element Values:

- Blank - (GV07 = 50-99)
- 0 No rollover
- 1 Wheels/tires
- 2 Side plane
- 3 End plane
- 4 Undercarriage
- 5 Other location on vehicle (specify):
- 8 Non-contact rollover forces (specify):
- 9 Unknown

Source: Researcher determined -- primary source is vehicle inspection. Secondary sources are scene inspection, photographs, police report, driver interviews, and other interviews.

Remarks:

Generally the tripping forces that initiate a rollover are applied at the wheels/tires. Occasionally the tripping force is applied at the undercarriage (e.g., when a vehicle mounts a guardrail) or at the side or end plane (e.g., when a barrier or another vehicle impacts the front or side plane of the vehicle and flips or initiates the rollover sequence). The purpose of this variable is to identify the specific point on the vehicle where the tripping force was applied.

Code "0" (No rollover) is used when variable GV24, Rollover, equals "0" [No rollover (no overturning)].

Code "1" (Wheels/Tires) is used whenever the tripping force is applied to the wheels or tires. The most common occurrences involve wheel/tire impacts to potholes and curbs, and wheels that gouge the pavement or dig into the earth.

Code "2" (Side plane) is used whenever the side plane other than the wheels and tires is contacted and that contact initiates the rollover.

Code "3" (End plane) is used whenever the end plane of the vehicle is contacted and sustained the rollover initiating force. For example, a vehicle was traveling at a high rate of speed when it impacted a concrete median barrier [i.e., GV61, Rollover Initiation Object Contacted, equals "54" (Concrete traffic barrier)] with its front left corner. The barrier redirects the vehicle upward and back towards the roadway. As a result, the vehicle rolls over; therefore use this code.

Code "4" (Undercarriage) is used when the rollover was caused by a force acting primarily through the undercarriage plane. For example, a vehicle strikes a guardrail [i.e., GV61 equals "56" [Other traffic barrier (includes guardrail)]] with its front right. The vehicle climbs up and over the guardrail and rolls over; therefore use this code.

Variable Name: Location on Vehicle Where Initial Principal
Tripping Force is Applied (Cont'd.)

Code "5" (Other location on vehicle) is used when the tripping force is applied at a location that cannot be captured in element values "0" through "4" or "8". This code should be rarely used and only after consultation with the zone center.

Code "8" (Non-contact rollover forces) is used when the vehicle rollover is precipitated by centrifugal or gravitational forces [i.e., GV59 equals "3" (Turn-over) or "5" (Fall-over)]. Specify the non-contact rollover force on the line provided.

Code "9" (Unknown) is used when variable GV24, Rollover, equals "9" [Rollover (overturn), details unknown]. In addition, use this code when the vehicle rolled over and the tripping point cannot be identified on the vehicle.

Variable Name: Direction of Initial Roll

Element Values:

Blank - (GV07 = 50-99)

0 No rollover

1 Roll right - primarily about the longitudinal axis

2 Roll left - primarily about the longitudinal axis

5 End-over-end (i.e., primarily about the lateral axis)

9 Unknown roll direction

Source: Researcher determined -- primary sources are the scene and vehicle inspections. Secondary sources are the police report, driver and other interviews.

Remarks:

During a side-over-side rollover, generally the corner or roof rail with the maximum crush is the trailing side. This will be a good indication of a roll to the right or a roll to the left. Striations or directional gouge marks on the vehicle are a good indication of a vehicle's roll along the longitudinal or lateral axis. Physical evidence at the accident scene, including yaw marks, scuffing, or gouging will also provide insight into the direction of the initial roll. It will not be uncommon to combine both vehicle and scene evidence when determining the direction of the initial roll.

Code "0" (No rollover) is used when variable GV24, Rollover, equals "0" [No rollover (no overturning)].

Code "1" (Roll right - primarily about the longitudinal axis) is used when the vehicle rolls over with the right side leading, a clockwise rollover from the driver's view.

Code "2" (Roll left - primarily about the longitudinal axis) is used when the vehicle rolls over with the left side leading, a counterclockwise rollover from the driver's view.

Code "5" [End-over-end (i.e., primarily about the lateral axis)] is used when a vehicle rolls end-over-end. Generally the rear plane will follow the frontal plane on an end-over-end rollover.

Code "9" (Unknown roll direction) is used when variable GV24, Rollover, equals "9" [Rollover (overturn), details unknown]. In addition, use this code when the vehicle was not inspected, or when the vehicle was inspected, but there is minimal physical evidence indicating the direction of roll.

PRECRASH DATA OVERVIEW

Coding of the precrash variables is completed for each of the in-transport vehicles in the accident. This means that the entire accident is first coded from the perspective of one vehicle, then coded from the perspective of a second vehicle, if any, and so forth. The precrash variables are:

- GV64, Pre-Event Movement (Prior to Recognition of Critical Event),
- GV65, Critical Precrash Event,
- GV14, Attempted Avoidance Maneuver,
- GV66, Precrash Stability After Avoidance Maneuver, and
- GV67, Precrash Directional Consequences of Avoidance Maneuver (Corrective Action)

The precrash variables are designed to identify the following:

- what was this vehicle doing just prior to the critical precrash event,
- what made this vehicle's situation critical,
- what was the avoidance response, if any, to this critical situation, and
- what was the subsequent movement of the vehicle to the avoidance maneuver?

The most important determination that must be made for each in-transport vehicle is: what was this vehicle's Critical Precrash Event, GV65 (i.e., what action by this vehicle, another vehicle, person, animal, or nonfixed object was critical to this vehicle's accident?). Once this determination is made, then determine the vehicle's avoidance response to the action which made this vehicle's involvement critical.

Attempted Avoidance Maneuver, GV14, is defined as movements/actions taken by the driver's vehicle, within a critical crash envelope, in response to a Critical Precrash Event, GV65.

Do not consider culpability as a factor for determining precrash data. Many accident scenarios will suggest fault, but this is considered coincidental rather than by design.

Critical Crash Envelope

The critical crash envelope begins at the point where:

- (1) the driver recognizes an impending danger (e.g., deer runs into the roadway), or
- (2) the vehicle is in an imminent path of collision with another vehicle, pedestrian, pedalcyclist, other nonmotorist, object, or animal.

The critical crash envelope ends when:

- (1) (a) the driver has made a successful avoidance maneuver
(b) has full steering control, and
(c) the vehicle is tracking; or
- (2) the driver's vehicle impacts another vehicle, pedestrian, pedalcyclist, other nonmotorist, object, or animal.

PRECRAASH DATA OVERVIEW (CONT'D)

Simple Single Critical Crash Envelope

Most accidents involve only a single critical crash envelope in which the object contacted is captured under the Critical Precrash Event, GV65 (e.g., A vehicle is traveling straight on a roadway; a deer runs into the roadway and is struck by the vehicle.). This scenario and similar ones are very straightforward and will not present many coding problems.

Complex Single Critical Crash Envelope

However, some single critical crash envelopes are more complex.

Example A: A driver avoids one obstacle and immediately impacts another vehicle, person, object, or animal. Because immediate is defined as not having an opportunity or sufficient time to take any additional avoidance actions, the Critical Precrash Event, GV65, is coded to the vehicle, person, object, or animal which the driver successfully avoided instead of the vehicle's first harmful event (i.e., its impact); see examples 4 and 7 below.

Example B: The driver avoids an obstacle only to (a) lose steering control and/or (b) have the vehicle stop tracking, and the vehicle subsequently impacts another vehicle, person, object, or animal. Regardless of whether the driver attempted to regain steering control; caused the vehicle to resume a tracking posture; or avoided the impacted vehicle, person, object, or animal; the Critical Precrash Event, GV65, is similarly coded to the vehicle, person, object, or animal which the driver successfully avoided because the driver's critical crash envelope was never stabilized.

In both examples above, the Attempted Avoidance Maneuver, GV14, records the successful action taken to avoid the Critical Precrash Event, GV65.

Vehicles that are not involved in an impact with another vehicle, person, object, or animal in the sequence of accident events that defines the accident are not included in the Crashworthiness Data System; and therefore, automated, encoded data are not collected for these vehicles. However, these vehicles are included in the recording of nonautomated information contained on the Accident Collision Diagram.

The coding order for a single critical crash envelope is illustrated below.

Typical Order of a Single Critical Crash Envelope

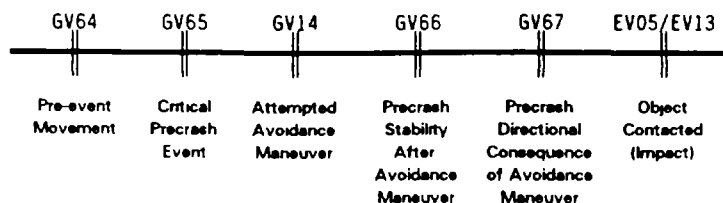

PRECRASH DATA OVERVIEW (CONT'D)

Multiple Critical Crash Envelopes

When accidents involve multiple critical crash envelopes, code only the final critical crash envelope. In this situation, encode the variable Pre-Event Movement ... , GV64, using code "16" (Successful avoidance maneuver to a previous critical event). The final critical crash envelope is the one that resulted in this vehicle's first harmful event (i.e., its impact) as shown in the following illustration.

Typical Order of Multiple Critical Crash Envelopes

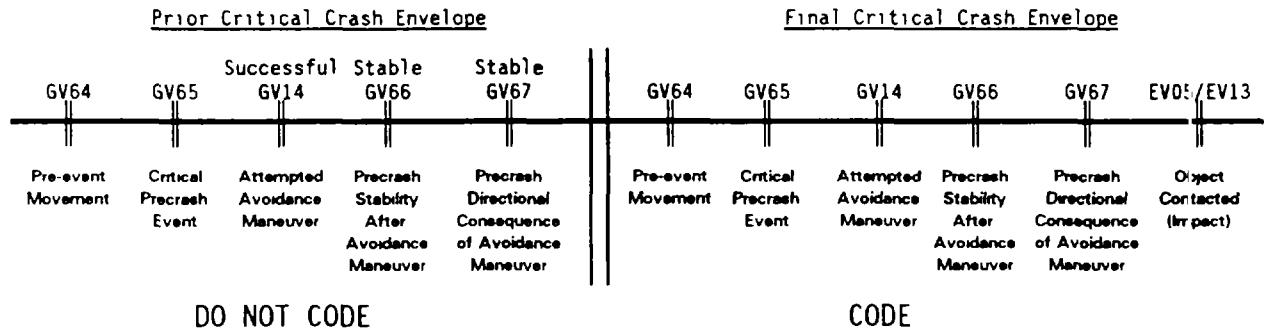

When there is doubt as to whether this vehicle had experienced multiple critical crash envelopes, code the Critical Precrash Event, GV65, to the vehicle, person, object, or animal which the driver successfully avoided. See Complex Single Critical Crash Envelope examples A and B above.

The pages that follow contain, first, a flowchart illustrating the proper method and protocol for determining the precrash variables, and second, seven examples of various accident event sequences which contain one or more critical crash envelopes.

PRECRASH DATA OVERVIEW (CONT'D)

Researcher Method for Determining Precrash Data

Method Flowchart

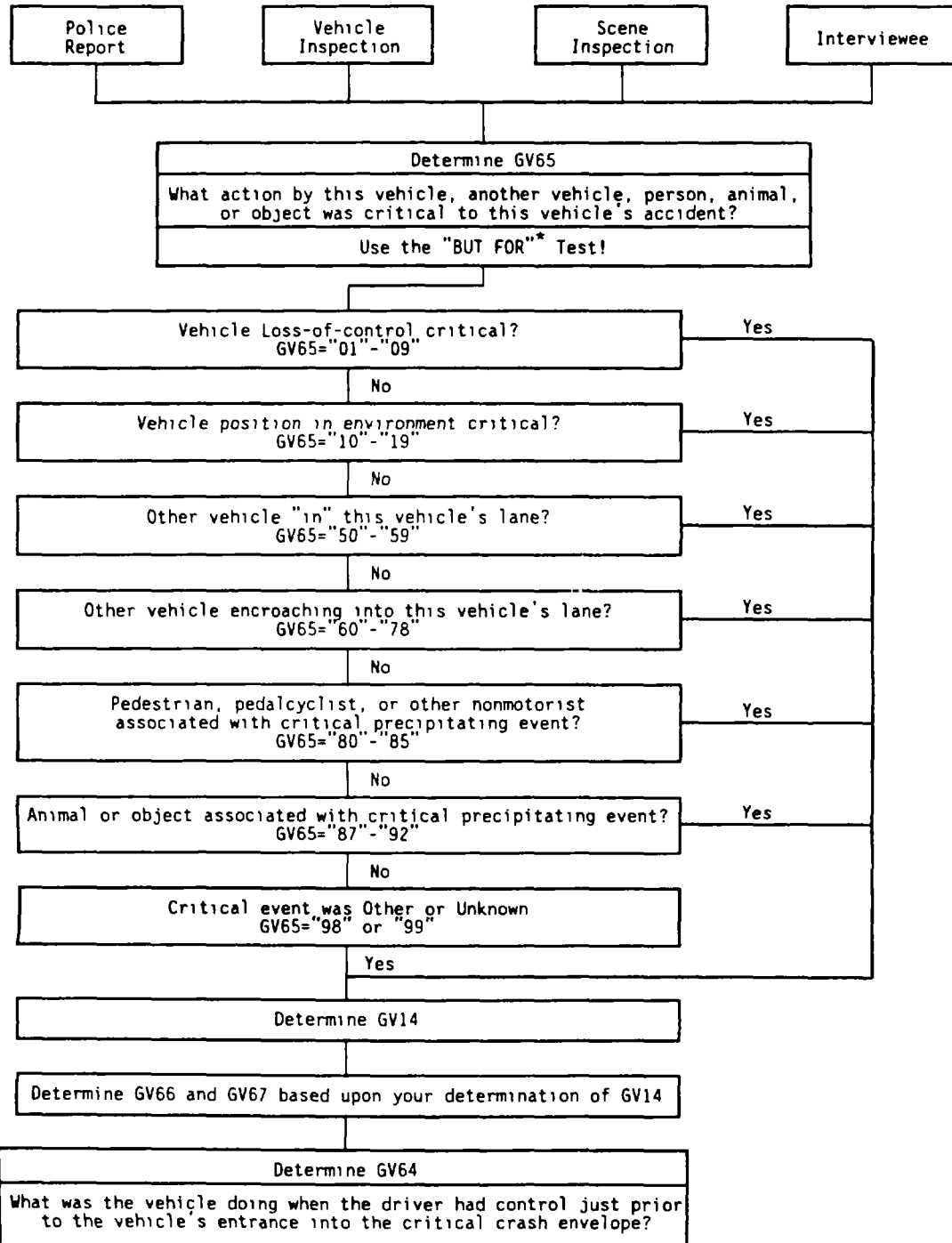

* F O R E X A M P L E

"But for" Vehicle # going left-of-center, this vehicle would not have been involved in this accident.

"But for" having entered into the intersection, this vehicle would not have been involved in this accident.

PRECRASH DATA OVERVIEW (CONT'D)

Researcher Method for Determining Precrash Data -- Continued

Method Protocol

Consider the information obtained from the Police Report, scene and vehicle inspections, and from the interviewee(s) as inputs to your decision making process.

1. Determine GV65, Critical Precrash Event.

What action by this vehicle, another vehicle, person, animal, or object was critical to this driver becoming involved in the accident (i.e., use the "BUT FOR"* test)?

ASK yourself questions (a) through (f) below. Proceed through each question that applies to the accident you are researching. Stop when the answer to the questions is "Yes". This is the Critical Precrash Event, GV65.

- (a) Did the vehicle exhibit a control loss?
- (b) Does the evidence suggest that the vehicle was in an environmentally dangerous position?
- (c) Was another vehicle "in" this vehicle's lane?
- (d) Was another vehicle entering into this vehicle's lane?
- (e) Was a pedestrian, pedalcyclist, or other nonmotorist in or approaching this vehicle's path?
- (f) Was an animal in or approaching this vehicle's path or was an object in this vehicle's path?

2. Determine GV14, Attempted Avoidance Maneuver.

What does your information indicate that the driver tried to do to avoid the accident?

- 3. Determine GV66, Precrash Stability After Avoidance Maneuver, and GV67, Precrash Directional Consequences of Avoidance Maneuver (Corrective Action).
- 4. Determine GV64, Pre-Event Movement (Prior to Recognition of Critical Event).

* F O R E X A M P L E :

"But for" Vehicle # going left-of-center, this vehicle would not have been involved in this accident.

"But for" having entered into the intersection, this vehicle would not have been involved in this accident.

PRECRASH DATA OVERVIEW (CONT'D)

Example 1

Vehicle 2 is northbound and passing through an intersection on a roadway without a traffic control. Vehicle 1 is eastbound on a crossing roadway with a stop sign but did not stop or slow down. Vehicle 1 crashes into the side of vehicle 2. Vehicle 2 did not see vehicle 1 coming. Vehicle 1 braked (leaving skid marks) just prior to impact, without any steering.

	<u>Vehicle 1</u>	<u>Vehicle 2</u>
GV64	(01) Going straight	(01) Going straight
GV65	(17) Crossing over (passing through) intersection	(66) From crossing street across path
GV14	(03) Braking (lockup)	(01) No avoidance actions
GV66	(2) Skidding longitudinally - rotation less than 30 degrees	(0) No avoidance maneuver
GV67	(1) Vehicle stayed in travel lane where avoidance maneuver was initiated	(0) No avoidance maneuver

In this example, vehicle 1 has one critical crash envelope (V_1CCE) which begins at the point where driver 1 recognizes that vehicle 1 is in an imminent collision path with vehicle 2. Vehicle 1's critical crash envelope ends at the point of impact with vehicle 2.

Vehicle 2 has one critical crash envelope (V_2CCE). Although the driver of vehicle 2 did not recognize the danger, vehicle 2's critical crash envelope begins at the point where vehicle 2 is in an imminent path of collision with vehicle 1. Vehicle 2's critical crash envelope ends at the point of impact with vehicle 1.

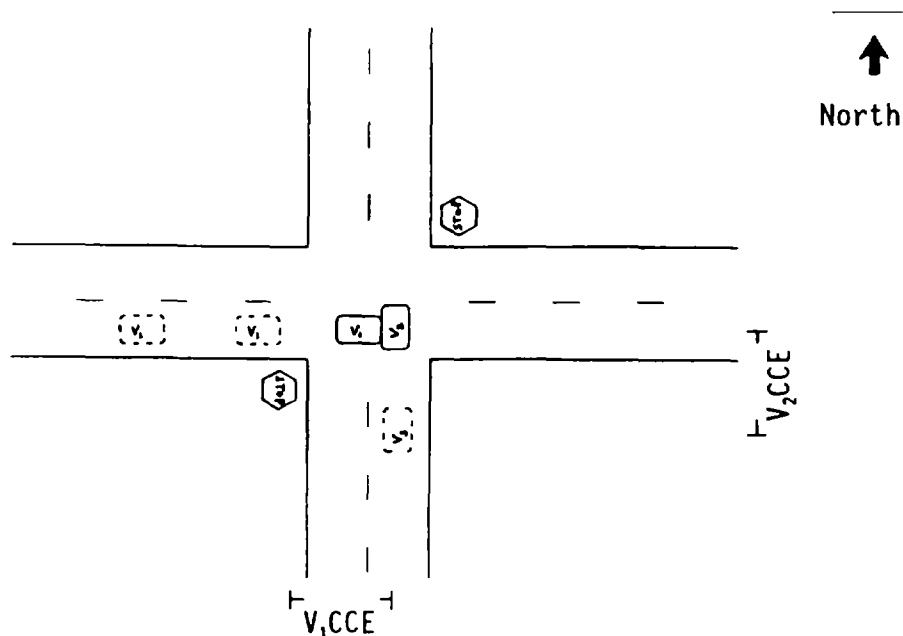

PRECRASH DATA OVERVIEW (CONT'D)

Example 2

Vehicle 1 and vehicle 2 are traveling in opposite directions on the same roadway. The driver of vehicle 1 falls asleep and crosses over the center line into the travel lane of vehicle 2. Vehicle 2 attempted to avoid vehicle 1 by steering right onto the shoulder and accelerating. Vehicle 1 impacted vehicle 2 in the side.

	<u>Vehicle 1</u>	<u>Vehicle 2</u>
GV64	(01) Going straight	(01) Going straight
GV65	(10) Over the lane line on left side of travel lane	(62) From opposite direction - over left lane line
GV14	(01) No avoidance actions	(12) Accelerating and steering right
GV66	(0) No avoidance maneuver	(1) Tracking
GV67	(0) No avoidance maneuver	(4) Vehicle departed roadway

In this example, vehicle 1 has one critical crash envelope (V_1CCE) which begins at the point where vehicle 1 crosses over the lane line and ends at the point of impact with vehicle 2.

Vehicle 2 has one critical crash envelope (V_2CCE) which begins at the point where driver 2 recognizes vehicle 1 encroaching into his/her travel lane. Vehicle 2's critical crash envelope ends at the point of impact with vehicle 1.

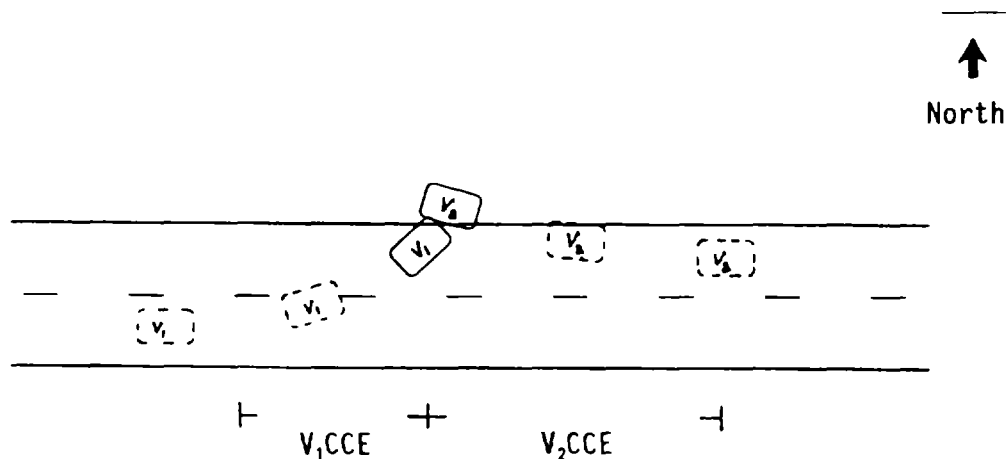

PRECRASH DATA OVERVIEW (CONT'D)

Example 3

Vehicle 1 is eastbound and passing through an intersection on a roadway without a traffic control. The noncontact vehicle (NCV) is northbound and stopped at the intersection on a crossing roadway with a stop sign. The noncontact vehicle turns right into the travel path of Vehicle 1. Vehicle 1 braked (without lockup) and steered left to avoid the noncontact vehicle. The driver of vehicle 1 successfully avoided the noncontact vehicle, maintained full control of vehicle 1, but consequently put vehicle 1 in the travel path of vehicle 2. Vehicle 2 attempted to avoid vehicle 1 by steering right and braking (with lockup). Vehicle 1 attempted to avoid vehicle 2 by steering right and braking (with lockup). Vehicle 1 and vehicle 2 crashed front left corner to front left corner.

		<u>Vehicle 1</u>		<u>Vehicle 2</u>
GV64	(16)	Successful avoidance maneuver to a previous critical event	(01)	Going straight
GV65	(10)	Over the lane line on left side of travel lane	(53)	Traveling in opposite direction
GV14	(09)	Braking and steering right	(09)	Braking and steering right
GV66	(2)	Skidding longitudinally - rotation less than 30 degrees	(2)	Skidding longitudinally - rotation less than 30 degrees
GV67	(1)	Vehicle stayed in travel lane where avoidance maneuver was initiated	(1)	Vehicle stayed in travel lane where avoidance maneuver was initiated

In this example, vehicle 1 has two critical crash envelopes (V_1CCE_1 and V_1CCE_2). Vehicle 1's first critical crash envelope (V_1CCE_1) ends at the point where the driver of vehicle 1 made a successful avoidance maneuver and maintained full control of the vehicle. Vehicle 1's second critical crash envelope (V_1CCE_2) begins immediately following the successful avoidance maneuver and ends at the point of impact with vehicle 2. Code the critical crash envelope which resulted in vehicle 1's first impact (V_1CCE_2).

Vehicle 2 has one critical crash envelope (V_2CCE) which begins at the point where driver 2 recognizes vehicle 1 in his/her travel lane and ends at the point of impact with vehicle 1.

The noncontact vehicle was not involved in an impact with another vehicle, person, animal, or object in the sequence of accident events and is therefore not included in the Crashworthiness Data System. However, the noncontact vehicle must be shown on the Accident Collision Diagram.

PRECRASH DATA OVERVIEW (CONT'D)

Example 3 (Cont'd)

↑
North

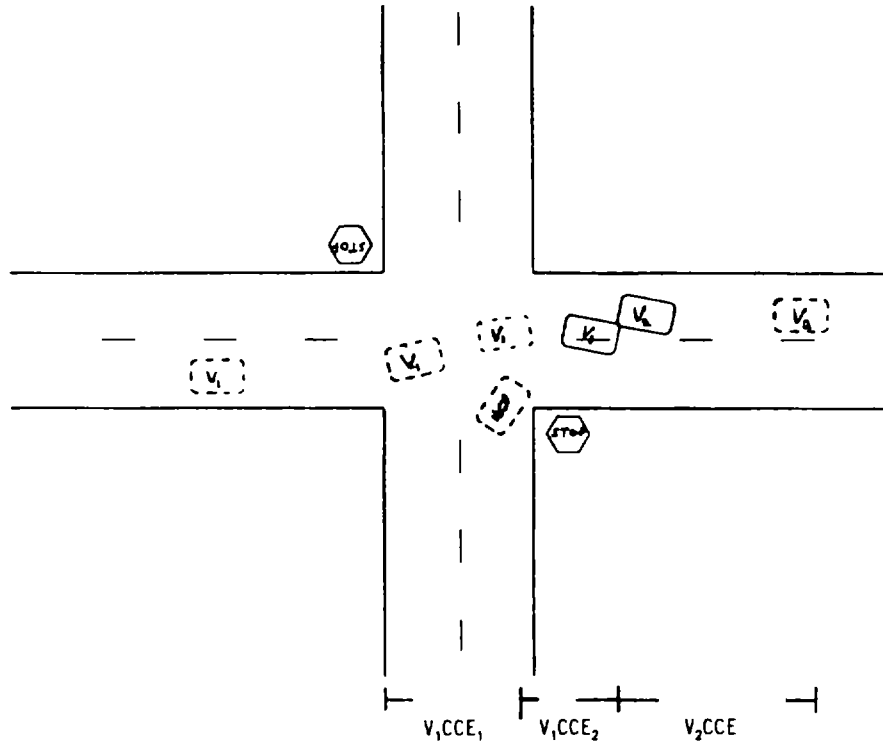

PRECRASH DATA OVERVIEW (CONT'D)

Example 4

Vehicle 1 and vehicle 2 are traveling in opposite directions on the same roadway. The driver of vehicle 1 brakes (without lockup) and steers left to avoid a pedestrian who darted into his/her travel lane. Vehicle 1 crosses over the center line into the travel path of vehicle 2. Vehicle 2 attempted to avoid vehicle 1 by braking and steering right onto the shoulder. Vehicle 2 skids and rotates clockwise about 45 degrees before it is impacted in the side by vehicle 1.

	<u>Vehicle 1</u>	<u>Vehicle 2</u>
GV64	(01) Going straight	(01) Going straight
GV65	(80) Pedestrian in roadway	(62) From opposite direction - over left lane line
GV14	(08) Braking and steering left	(09) Braking and steering right
GV66	(1) Tracking	(3) Skidding laterally - clockwise rotation
GV67	(2) Vehicle stayed on roadway but left travel lane where avoidance maneuver was initiated	(1) Vehicle stayed in travel lane where avoidance maneuver was initiated

In this example, vehicle 1 has one critical crash envelope (V_1CCE). Vehicle 1's critical crash envelope involved a successful avoidance of a pedestrian [i.e., GV65 (Critical Precrash Event) equals code "80"] which resulted in an immediate impact to vehicle 2. Therefore, the pedestrian is coded as the critical precrash event for vehicle 1. Vehicle 1's avoidance maneuver is coded as the action taken to avoid the pedestrian.

Vehicle 2 has one critical crash envelope (V_2CCE) which begins at the point where driver 2 recognized and reacted to vehicle 1 in his/her travel lane and ends at the point of impact with vehicle 1.

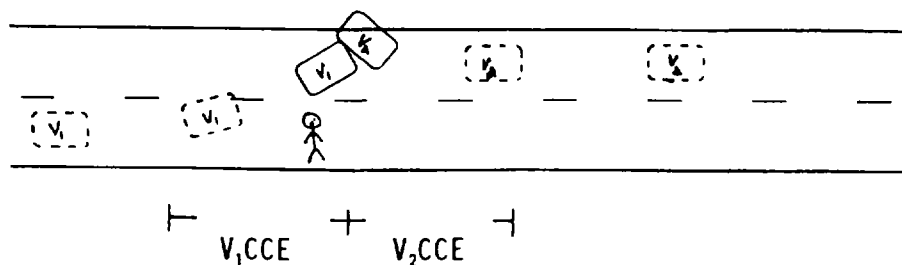

PRECRASH DATA OVERVIEW (CONT'D)

Example 5

Vehicle 1 and vehicle 2 are traveling in opposite directions on the same roadway. The driver of vehicle 1 steers left to avoid a pedestrian who darted into his/her travel lane. Vehicle 1 crosses over the center line and the adjacent travel lane, departing the roadway. Then driver 1 reenters the roadway, in full control of the vehicle but traveling in the lane of opposing traffic. Vehicle 2 attempted to avoid vehicle 1 by steering right and braking (with skidding and clockwise rotation greater than 30 degrees). Vehicle 1 attempted to avoid vehicle 2 by steering right without braking. Vehicle 1 impacted vehicle 2 in the side.

	<u>Vehicle 1</u>	<u>Vehicle 2</u>
GV64	(16) Successful avoidance maneuver to a previous critical event	(01) Going straight
GV65	(10) Over the lane line on left side of travel lane	(53) Traveling in opposite direction
GV14	(07) Steering right	(09) Braking and steering right
GV66	(1) Tracking	(3) Skidding laterally - clockwise rotation
GV67	(1) Vehicle stayed in travel lane where avoidance maneuver was initiated	(1) Vehicle stayed in travel lane where avoidance maneuver was initiated

In this example, vehicle 1 has two critical crash envelopes (V_1CCE_1 and V_1CCE_2). Vehicle 1's first critical crash envelope (V_1CCE_1) begins at the point where driver 1 recognize the pedestrian coming into his/her travel path and ends at the point where the driver of vehicle 1, having made a successful avoidance maneuver, regains full control of the vehicle. Vehicle 1's second critical crash envelope (V_1CCE_2) begins when driver 1, in full control of vehicle 1, reenters the roadway in the travel lane of opposing traffic and ends at the point of impact with vehicle 2. Code the critical crash envelope which resulted in vehicle 1's first impact (V_1CCE_2).

Vehicle 2 has one critical crash envelope (V_2CCE) which begins at the point where driver 2 recognized and reacted to vehicle 1 in his/her travel lane and ends at the point of impact with vehicle 1.

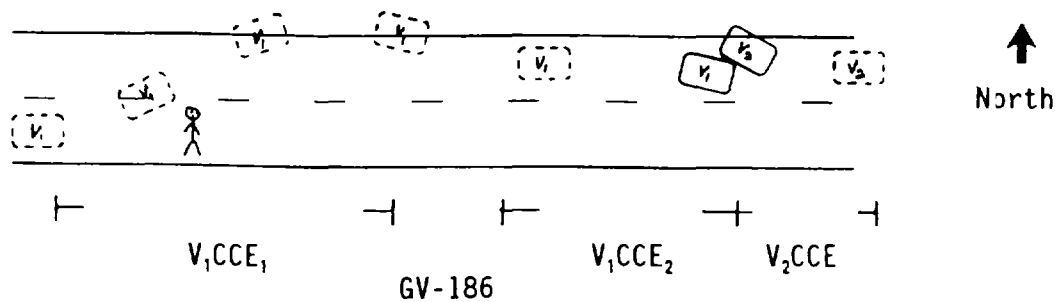

PRECRASH DATA OVERVIEW (CONT'D)

Example 6

Vehicle 1 and vehicle 2 are traveling in the same direction in adjacent lanes on a divided highway (with a painted median). Vehicle 1 has a blow out, driver 1 loses control, crosses the left lane line and impacts the right rear of vehicle 2. Vehicle 2 is redirected across the painted median, skidding and rotating clockwise, and subsequently impacts vehicle 3. Vehicle 3 attempted to avoid vehicle 2 by steering right and accelerating.

	<u>Vehicle 1</u>	<u>Vehicle 2</u>
GV64	(01) Going straight	(01) Going straight
GV65	(01) Blow out or flat tire	(61) From adjacent lane (same direction) - over right lane line
GV14	(01) No avoidance actions	(01) No avoidance actions
GV66	(0) No avoidance maneuver	(0) No avoidance maneuver
GV67	(0) No avoidance maneuver	(0) No avoidance maneuver
	<u>Vehicle 3</u>	
GV64	(01) Going straight	
GV65	(62) From opposite direction - over left lane line	
GV14	(12) Accelerating and steering right	
GV66	(1) Tracking	
GV67	(1) Vehicle stayed in travel lane where avoidance maneuver was initiated	

In this example, vehicle 1 has one critical crash envelope (V_1CCE) which begins with control loss due to the blow out and ends at the point of impact with vehicle 2. The blow out is coded as the critical precrash event (GV65 equals 01).

Vehicle 2 has two critical crash envelopes (V_2CCE_1 and V_2CCE_2). Vehicle 2's first critical crash envelope (V_2CCE_1) begins when vehicle 1 enters vehicle 2's travel lane and ends at the point of impact with vehicle 1. Vehicle 2's second critical crash envelope (V_2CCE_2) begins immediately after the first impact and ends at the point of impact with vehicle 3. Code the critical crash envelope which resulted in vehicle 2's first impact (V_2CCE_1), because the NASS CDS is only interested in coding the critical crash envelope which leads to a vehicle's first harmful event.

Vehicle 3 has one critical crash envelope (V_3CCE) which begins when driver 3 recognizes and reacts to vehicle 2 which is in an imminent path of collision with vehicle 3 and ends at the point of impact with vehicle 2.

PRECRASH DATA OVERVIEW (CONT'D)

Example 6 (Cont'd)

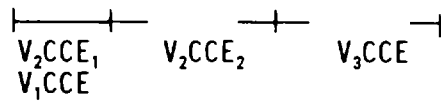
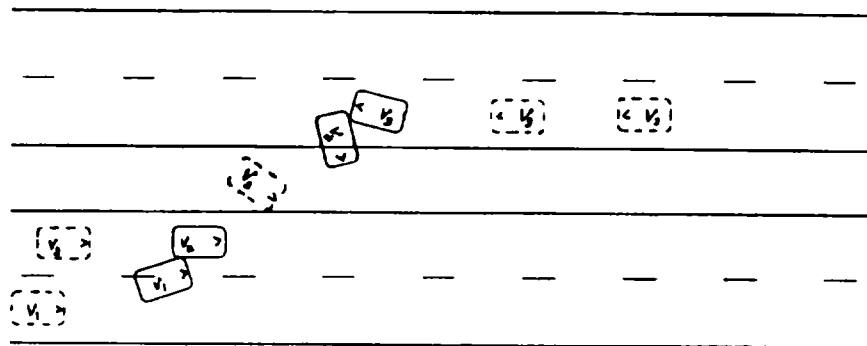

Variable Name: Critical Precrash Event (Cont'd.)

- Code "62" (From opposite direction—over left lane line) identifies a situation where the other vehicle crosses the left lane line while traveling in the opposite direction from this vehicle.
- Code "63" (From opposite direction—over right lane line) identifies a situation where the other vehicle crosses the right lane line while traveling in the opposite direction from this vehicle.
- Code "64" (From parking lane) is used when the other vehicle was departing a parking lane and entering the travel lane of this vehicle.
- Code "65" (From crossing street, turning into same direction) is used when the other vehicle was turning from another roadway onto this vehicle's roadway and attempted to travel in the same direction as this vehicle. Use this code for entrance ramps leading onto limited access highways.
- Code "66" (From crossing street, across path) is used when the other vehicle was continuing straight through the intersection and attempted to crossover this vehicle's roadway.
- Code "67" (From crossing street, turning into opposite direction) is used when the other vehicle was entering an intersection from another roadway and was turning or attempting to turn onto this vehicle's roadway in the opposite travel direction of this vehicle.
- Code "68" (From crossing street, intended path not known) is used when the other vehicle's entrance into the intersection was the critical factor which led to the collision, however, the other vehicle's travel direction could not be determined.
- Code "70" (From driveway, turning into same direction) is used when the other vehicle was turning from a driveway onto this vehicle's roadway and attempted to travel in the same direction as this vehicle.
- Code "71" (From driveway, across path) is used when the other vehicle was entering this vehicle's roadway from a driveway and was continuing straight across to another driveway or roadway.
- Code "72" (From driveway, turning into opposite direction) is used when the other vehicle was entering this vehicle's roadway from a driveway and was attempting to turn into the opposite travel direction of this vehicle.
- Code "73" (From driveway, intended path not known) is used to identify driveway related precrash events where details surrounding the other vehicle's intended path are not known.

Variable Name: Pre-Event Movement (Prior to Recognition of Critical Event)

Element Values:

- 01 Going straight
- 02 Slowing or stopping in traffic lane
- 03 Starting in traffic lane
- 04 Stopped in traffic lane
- 05 Passing or overtaking another vehicle
- 06 Disabled or parked in travel lane
- 07 Leaving a parking position
- 08 Entering a parking position
- 09 Turning right
- 10 Turning left
- 11 Making a U-turn
- 12 Backing up (other than for parking position)
- 13 Negotiating a curve
- 14 Changing lanes
- 15 Merging
- 16 Successful avoidance maneuver to a previous critical event
- 97 Other (specify):
- 98 No driver present
- 99 Unknown

Source: Researcher determined -- inputs include interviews and police report.

Remarks:

Record the attribute which best describes this vehicle's activity prior to the driver's realization of an impending critical event or just prior to impact if the driver took no action or had no time to attempt any evasive maneuvers.

Actions taken by the driver, of this vehicle, after realization of an impending danger are coded in GV14, Attempted Avoidance Maneuver.

Code "01" (Going straight) is used when this vehicle's path of travel was straight ahead without any attempted or intended changes.

Code "02" (Slowing or stopping in traffic lane) is used when this vehicle was traveling straight ahead within the traffic lane and was decelerating.

Code "03" (Starting in traffic lane) is used when this vehicle was in the process of starting forward from a stopped position within the traffic lane (e.g., start up from traffic signal).

Code "04" (Stopped in traffic lane) is used when this vehicle was stopped momentarily, with the motor running within the traffic lane (e.g., stopped for traffic signal).

Code "05" (Passing or overtaking another vehicle) is used when this vehicle was traveling straight ahead and was in the process of passing or overtaking another vehicle on the left or right.

Variable Name: Pre-Event Movement (Prior to Recognition of Critical Event)

- Code "06" (Disabled or parked in travel lane) is used when this vehicle was parked in a travel lane (e.g., double parked, disabled) with a driver present in the vehicle.
- Code "07" (Leaving a parking position) is used when this vehicle was entering the travel lane from a parking area adjacent to the traffic lanes.
- Code "08" (Entering a parking position) is used when this vehicle was leaving the travel lane to a parking area adjacent to the traffic lanes (i.e., in the process of parking).
- Code "09" (Turning right) is used when this vehicle was moving forward and turned right, changing lanes from one roadway to a different roadway (e.g., from or to a driveway, parking lot, or intersection).
- Code "10" (Turning left) is used when this vehicle was moving forward and turned left, changing lanes from one roadway to a different roadway (e.g., from or to a driveway, parking lot, or intersection).
- Code "11" (Making a U-turn) is used when this vehicle was making a U-turn (i.e., 180 degree directional change) on the roadway.
- Code "12" [Backing up (other than for parking position)] is used when this vehicle was traveling backwards within the trafficway. Do not use this code if the vehicle was backing into a parking space (See Code "08").
- Code "13" (Negotiating a curve) is used when this vehicle was continuing along a roadway that curved to the right or left.
- Code "14" (Changing lanes) is used when this vehicle was traveling straight ahead and changed travel lanes to the right or left while on the same roadway.
- Code "15" (Merging) is used when this vehicle was moving forward and merging from the left or right into a traffic lane (e.g., roadway narrows, exit/entrance ramps).
- Code "16" (Successful avoidance maneuver to a previous critical event) is used when this vehicle responded to a previous critical event and successfully avoided an impact. However, this precipitated a subsequent critical crash envelope which resulted in this vehicle's first impact.
- Code "97" [Other (specify)] is used when this vehicle's pre-event movement is known but none of the specified codes are applicable.
- Code "98" (No driver present) is used if no driver was in the vehicle when the accident occurred.
- Code "99" (Unknown) is used when the vehicle's movement prior to the driver's realization of an impending critical event is unknown.

Variable Name: Critical Precrash Event

Element Values:

This Vehicle Loss of Control Due To:

- 01 Blow out or flat tire
- 02 Stalled engine
- 03 Disabling vehicle failure (e.g., wheel fell off) (specify):
- 04 Non-disabling vehicle problem (e.g., hood flew up) (specify)
- 05 Poor road conditions (puddle, pot hole, ice, etc.) (specify)
- 06 Traveling too fast for conditions
- 08 Other cause of control loss (specify)
- 09 Unknown cause of control loss

This Vehicle Traveling

- 10 Over the lane line on left side of travel lane
- 11 Over the lane line on right side of travel lane
- 12 Off the edge of the road on the left side
- 13 Off the edge of the road on the right side
- 14 End departure
- 15 Turning left at intersection
- 16 Turning right at intersection
- 17 Crossing over (passing through) intersection
- 19 Unknown travel direction

Other Motor Vehicle In Lane

- 50 Stopped
- 51 Traveling in same direction with lower speed (i.e., lower steady speed or decelerating)
- 52 Traveling in same direction with higher speed
- 53 Traveling in opposite direction
- 54 In crossover
- 55 Backing
- 59 Unknown travel direction of other motor vehicle in lane

Other Motor Vehicle Encroaching Into Lane

- 60 From adjacent lane (same direction)—over left lane line
- 61 From adjacent lane (same direction)—over right lane line

- 62 From opposite direction—over left lane line
- 63 From opposite direction—over right lane line
- 64 From parking lane
- 65 From crossing street, turning into same direction
- 66 From crossing street, across path
- 67 From crossing street, turning into opposite direction
- 68 From crossing street, intended path not known
- 70 From driveway, turning into same direction
- 71 From driveway, across path
- 72 From driveway, turning into opposite direction
- 73 From driveway, intended path not known
- 74 From entrance to limited access highway
- 78 Encroachment by other vehicle—details unknown

Pedestrian or Pedalcyclist, or Other Nonmotorist

- 80 Pedestrian in roadway
- 81 Pedestrian approaching roadway
- 82 Pedestrian - unknown location
- 83 Pedalcyclist or other nonmotorist in roadway (specify)
- 84 Pedalcyclist or other nonmotorist approaching roadway (specify)
- 85 Pedalcyclist or other nonmotorist—unknown location (specify)

Object or Animal

- 87 Animal in roadway
- 88 Animal approaching roadway
- 89 Animal—unknown location
- 90 Object in roadway
- 91 Object approaching roadway
- 92 Object—unknown location
- 98 Other critical precrash event (specify):
- 99 Unknown

Variable Name: Critical Precrash Event (Cont'd.)

Source: Researcher determined -- inputs include scene inspection, vehicle inspection, driver interview, and police report.

Remarks:

This variable identifies the critical event which made the crash imminent (i.e., something occurred which made the collision possible). Responsive actions to this situation, if any, are coded under GV14, Attempted Avoidance Maneuver.

A precrash event is coded for each vehicle and identifies the circumstances leading to this vehicle's first impact in the accident.

Responses are grouped into six major categories and are prioritized as follows:

- This Vehicle Loss of Control Due To
- This Vehicle Traveling
- Other Motor Vehicle In Lane
- Other Motor Vehicle Encroaching Into Lane
- Pedestrian or Pedalcyclist, or Other Nonmotorist
- Object or Animal

Do not refer to culpability. Many accident scenarios will suggest fault, but this should be coincidental rather than by design. As an example, vehicle A was traveling too fast for conditions (code "06") when vehicle B crossed vehicle A's path from a driveway (code "71"). The situation which made the precrash event critical for vehicle A was vehicle B's movement across vehicle A's path and not vehicle A's speed.

This Vehicle Loss of Control Due To:

Codes "01"- "09" identify situations where the critical factor leading to the collision involved control loss of this vehicle. Control loss can be related to either mechanical failure or environmentally induced vehicle instability. When more than one condition applies and it cannot be determined which one had a greater effect, choose the lower element number (i.e., code "01" takes priority over code "02").

Code "01" (Blow out or flat tire) is used when a vehicle in motion loses control as the result of a tire "air out".

Code "02" (Stalled engine) refers to a vehicle which is in motion and loses engine power. A stalled engine situation must precipitate a collision to be coded in this variable. A vehicle which is stopped as the result of an engine malfunction does not take this code.

Variable Name: Critical Precrash Event (Cont'd.)

Code "03" [Disabling vehicle failure (e.g., wheel fell off)] is used when a mechanical malfunction, such as a component of the vehicle suspension or steering system, leads to the critical reason for the collision. Specify which component failure was involved in the space provided under this element.

Code "04" [Non-disabling vehicle problem (e.g., hood flew up)] is used when some mechanical abnormality occurred to this vehicle which leads to the critical reason for the collision. The abnormality must not be disabling damage. A space is provided under this element to specify the non-disabling vehicle problem.

Code "05" [Poor road conditions (puddle, pot hole, ice, etc.)] captures control loss due to environmental conditions of the roadway. These conditions must have initiated the precrash event which resulted in the collision. A space is provided under this element to specify the road condition attributed to initiating the precrash event.

Code "06" (Traveling too fast for conditions) identifies this vehicle's movement relative to its surroundings in which the subsequent loss of control lead to the collision. An example is a roadway departure on a curve where the driver failed to negotiate and departed the roadway resulting in an impact. If the driver merely steered straight while in a curve and departed the roadway, then codes "10" - "13" may apply.

Code "08" (Other cause of control loss) is used when it was determined that this vehicle's loss of control was the primary reason which made the event critical and codes "01" - "06" do not adequately identify the control loss condition. The condition cited should be annotated in the space provided on the form.

Code "09" (Unknown cause of control loss) is used when it is known control loss made the situation critical, but it is not known whether the vehicle or the environment caused the control loss.

This Vehicle Traveling

Codes "10" - "19" identify situations where the critical factor leading to the collision involved the travel path of this vehicle.

Code "10" (Over the lane line on left side of travel lane) is used when this vehicle departs its lane to the left and is entering or had entered the adjoining lane or shoulder. To use this code, change of travel path by this vehicle must precipitate the critical event for the collision. As an example, this vehicle attempts to pass another vehicle on the other vehicle's left and is struck by a vehicle traveling within its travel lane in the opposite direction. The

Variable Name: Critical Precrash Event (Cont'd.)

correct code for this vehicle would be "10" (Over the lane line on left side of travel lane). However, by modifying the scenario slightly the lane change may not always be the factor leading to the precrash event. Consider the same situation where this vehicle is passing to the left of the lead vehicle. If an animal runs into the roadway and is stuck by this vehicle, then the correct choice would be code "87" (Animal in roadway).

Code "11" (Over the lane line on right side of travel lane) is used when this vehicle departs its lane to the right and is entering or had entered the adjoining lane or shoulder. To use this code, change of travel path by this vehicle must precipitate the critical event for the collision. As an example, this vehicle attempts to pass another vehicle on the other vehicle's right and is struck in the rear by a vehicle traveling within its travel lane in the same direction. The correct code for this vehicle would be "11" (Over the lane line on right side of travel lane). However, by modifying the scenario slightly the lane change may not always be the factor leading to the precrash event. Consider the same situation where this vehicle is passing to the right of the lead vehicle. If an animal runs into the roadway and is stuck by this vehicle, then the correct choice would be code "87" (Animal in roadway).

Code "12" (Off the edge of the road on the left side) identifies a situation where the initial precrash event occurred beyond the left side shoulder area. This also includes departure into a median.

Code "13" (Off the edge of the road on the right side) identifies a situation where the initial precrash event occurred beyond the right side shoulder area.

Code "14" (End departure) is used when the vehicle departs the end of the roadway (e.g., "T" intersection).

Code "15" (Turning left at intersection) is used when this vehicle attempts a left turn from its roadway to another roadway or driveway.

Code "16" (Turning right at intersection) is used when this vehicle attempts a right turn from its roadway to another roadway or driveway.

Code "17" [Crossing over (passing through) intersection] identifies this vehicle's travel as proceeding through the intersection without any planned turning.

Code "19" (Unknown travel direction) is used for those occasions where this vehicle's travel made the situation critical, but it is unknown which travel direction this vehicle was moving.

Variable Name: Critical Precrash Event (Cont'd.)

Other Motor Vehicle In Lane

Codes "50" - "59" identify situations where the critical factor leading to the collision involved the travel of the other vehicle in the same lane as this vehicle.

Code "50" (Stopped) identifies a situation where the other vehicle is not in motion (i.e., stopped, parked, disabled) and in this vehicle's travel lane.

Code "51" [Traveling in same direction with lower speed (i.e., lower steady speed or decelerating)] is used when the other vehicle was the lead vehicle in the same travel lane, traveling in the same direction, and was either traveling slower than this vehicle or decelerating.

Code "52" (Traveling in same direction with higher speed) is used when the speed of the other vehicle was higher than this vehicle. The other vehicle must be overtaking this vehicle.

Code "53" (Traveling in opposite direction) is used when the other vehicle was in this vehicle's travel lane and traveling head-on in the opposite direction of this vehicle.

Code "54" (In crossover) is used when the other vehicle enters a cross over already occupied by this vehicle. A crossover is defined as a designated opening within a median used primarily for "U-turns".

Code "55" (Backing) identifies a situation where the other vehicle was in the process of backing up while in this vehicle's travel lane.

Code "59" (Unknown travel direction of other motor vehicle in lane) is used for situations where the other vehicle's activity (while in the same lane as this vehicle) precipitated the precrash event, but the travel direction and/or speed could not be determined.

Other Motor Vehicle Encroaching Into Lane

Codes "60" - "78" identify situations where the critical factor leading to the collision involves the other vehicle's movement into or across this vehicle's travel lane from another lane, intersection, driveway, or ramp.

Code "60" [From adjacent lane (same direction)—over left lane line] is used when the other vehicle was traveling in the same direction as this vehicle and crosses the left lane line with respect to this vehicle's travel lane (i.e., other vehicle crosses its right lane line).

Code "61" [From adjacent lane (same direction)—over right lane line] is used when the other vehicle was traveling in the same direction as this vehicle and crosses the right lane line with respect to this vehicle's travel lane (i.e., other vehicle crosses its left lane line).

Variable Name: Critical Precrash Event (Cont'd.)

- Code "62" (From opposite direction—over left lane line) identifies a situation where the other vehicle crosses the left lane line while traveling in the opposite direction from this vehicle.
- Code "63" (From opposite direction—over right lane line) identifies a situation where the other vehicle crosses the right lane line while traveling in the opposite direction from this vehicle.
- Code "64" (From parking lane) is used when the other vehicle was departing a parking lane and entering the travel lane of this vehicle.
- Code "65" (From crossing street, turning into same direction) is used when the other vehicle was turning from another roadway onto this vehicle's roadway and attempted to travel in the same direction as this vehicle. Use this code for entrance ramps leading onto limited access highways.
- Code "66" (From crossing street, across path) is used when the other vehicle was continuing straight through the intersection and attempted to crossover this vehicle's roadway.
- Code "67" (From crossing street, turning into opposite direction) is used when the other vehicle was entering an intersection from another roadway and was turning or attempting to turn onto this vehicle's roadway in the opposite travel direction of this vehicle.
- Code "68" (From crossing street, intended path not known) is used when the other vehicle's entrance into the intersection was the critical factor which led to the collision, however, the other vehicle's travel direction could not be determined.
- Code "70" (From driveway, turning into same direction) is used when the other vehicle was turning from a driveway onto this vehicle's roadway and attempted to travel in the same direction as this vehicle.
- Code "71" (From driveway, across path) is used when the other vehicle was entering this vehicle's roadway from a driveway and was continuing straight across to another driveway or roadway.
- Code "72" (From driveway, turning into opposite direction) is used when the other vehicle was entering this vehicle's roadway from a driveway and was attempting to turn into the opposite travel direction of this vehicle.
- Code "73" (From driveway, intended path not known) is used to identify driveway related precrash events where details surrounding the other vehicle's intended path are not known.

Variable Name: Critical Precrash Event (Cont'd.)

| Code "74" (From entrance to limited access highway) is used for entrance ramp situations where the other vehicle was attempting to enter (merge) onto the limited access highway which was being traveled by this vehicle.

Code "78" (Encroachment by other vehicle—details unknown) is used for situations where the other vehicle initiated the critical precrash event, but circumstances surrounding the other vehicle's encroachment are not known.

Pedestrian or Pedalcyclist, or Other Nonmotorist

Codes "80" - "85" identify situations where the critical factor leading to the collision for this vehicle involved a pedestrian, pedalcyclist, or other nonmotorist. A pedalcyclist is defined as a person riding a pedal power conveyance (e.g., bicycle, tricycle, etc.). A nonmotorist is defined as a person riding on or in a conveyance which is not motorized or propelled by pedalling (e.g., baby carriage, skate board, roller blades, etc.).

Code "80" (Pedestrian in roadway) is used when a pedestrian was present (e.g., sitting, standing, walking, or running, etc.) in the roadway.

Code "81" (Pedestrian approaching roadway) identifies situations where a pedestrian was within the trafficway and moving toward the roadway or attempting to enter the roadway, but was not on the roadway.

Code "82" (Pedestrian - unknown location) is used when it was determined the presence or action of a pedestrian was the critical factor which lead to this vehicle's collision, but the location or action of the pedestrian was not known.

Code "83" (Pedalcyclist or other nonmotorist in roadway) is used when a pedalcyclist or other nonmotorist was present in the roadway (irrespective of relative motion).

Code "84" (Pedalcyclist or other nonmotorist approaching roadway) identifies situations where the pedalcyclist or other nonmotorist was within the trafficway and moving toward the roadway or attempting to enter the roadway, but was not on the roadway.

Code "85" (Pedalcyclist or other nonmotorist—unknown location) is used when it was determined the presence or action of a pedalcyclist or other nonmotorist was the critical factor which lead to this vehicle's collision, but the action of the pedalcyclist or other nonmotorist was not known.

Variable Name: Critical Precrash Event (Cont'd.)

Object or Animal

Codes "87" - "92" identify situations where the critical factor leading to the collision for this vehicle involved an object or animal.

Code "87" (Animal in roadway) is used when an animal was present (i.e., stationary or moving) in the roadway.

Code "88" (Animal approaching roadway) identifies situations where an animal was within the trafficway and moving toward the roadway or attempting to enter the roadway, but not on the roadway.

Code "89" (Animal - unknown location) is used when it was determined the presence or action of an animal was the critical factor which lead to this vehicle's collision, but the action of the animal was not known.

Code "90" (Object in roadway) is used when an object was present in the roadway. An object is defined as being either fixed or nonfixed (refer to the object contacted codes listed under variable AC16 et al., Vehicle Number or Object Contacted, and EV05/EV13, ... C.D.C - Object Contacted).

Code "91" (Object approaching roadway) identifies situations where an object was within the trafficway and moving toward the roadway, but not on the roadway.

Code "92" (Object—unknown location) is used when it was determined the presence or movement of an object was the critical factor which lead to this vehicle's collision, but details surrounding the location of the object were not known.

Code "98" (Other critical precrash event) is used when a critical factor not previously listed resulted in the collision for this vehicle. Previous impacts in the accident are not considered as other critical precrash events. For example, use this code if the critical event developed from this vehicle's departure from a driveway.

Code "99" (Unknown) is used when the critical precrash event which resulted in the collision is not known. Missing interviews do not automatically result in the use of the "Unknown" code.

Variable Name: Precrash Stability After Avoidance Maneuver

Element Values:

- 0 No avoidance maneuver
- 1 Tracking
- 2 Skidding longitudinally—rotation less than 30 degrees
- 3 Skidding laterally—clockwise rotation
- 4 Skidding laterally—counterclockwise rotation
- 7 Other vehicle loss-of-control (specify)
- 8 No driver present
- 9 Precrash stability unknown

Source: Researcher determined: inputs include vehicle and scene evidence, interviews and police report.

Remarks:

The purpose of this variable is to assess the stability of the vehicle which resulted from the initiation of the avoidance maneuver coded in GV14, Attempted Avoidance Maneuver. The stability of the vehicle prior to an avoidance action is not considered except in the following situation: A vehicle that is out of control (e.g., yawing clockwise) prior to an avoidance maneuver is coded "7" (Other vehicle loss-of-control) only if an avoidance action was taken in response to an impending danger. Thus, this variable focuses upon this vehicle's dynamics which resulted from its avoidance maneuver.

Code "0" (No avoidance maneuver) is used whenever the driver took no evasive action prior to the first impact in the accident.

Code "1" (Tracking) is used whenever the driver took an avoidance maneuver which did not result in brake lockup and the vehicle continued along its intended path without rotating. Slowing, turning, moderate braking, or accelerating to avoid a rear-end collision are examples.

Code "2" (Skidding longitudinally—rotation less than 30 degrees) is coded whenever the driver applied the brakes with sufficient force to lock the brakes causing the car to skid. The vehicle must continue along its initial path (tracking) and cannot rotate more than 30 degrees clockwise or counterclockwise. If there is no information to support rotation greater than or equal to 30 degrees, then use this code.

Code "3" (Skidding laterally—clockwise rotation) is used whenever the driver of a vehicle applies the brakes with sufficient force to lock the wheels and the vehicle rotates clockwise, relative to the driver's seating position. The vehicle must rotate 30 degrees or more. This code also applies when the driver attempts a steering input (i.e., swerves right), but the vehicle rotates clockwise. In addition, use this code when it is known the vehicle rotated clockwise 30 degrees or more but it is unknown whether wheel lockup occurred.

Variable Name: Precrash Stability After Avoidance Maneuver

- Code "4" (Skidding laterally - counterclockwise rotation) is used whenever the driver of a vehicle applies the brakes with sufficient force to lock the wheels and the vehicle rotates counterclockwise, relative to the driver's seating position. The vehicle must rotate 30 degrees or more. This code also applies when the driver attempts a steering input (i.e., swerves left), but the vehicle rotates counterclockwise. In addition, use this code when it is known the vehicle rotated counterclockwise 30 degrees or more but it is unknown whether wheel lockup occurred.
- Code "7" (Other vehicle loss-of-control) is used whenever a driver loses control of a vehicle prior to attempting the avoidance action coded in GV14, Attempted Avoidance Maneuver, and is involved in an accident without regaining control. For example, if a driver loses control on a roadway and attempts to avoid the impending danger by taking some corrective action (e.g., steering), then use this code.
- Code "8" (No driver present) is used when no driver was in the vehicle at the time it was involved in the accident.
- Code "9" (Precrash stability unknown) is used whenever the stability of the vehicle following the avoidance maneuver cannot be determined. This code is also used whenever the attempted avoidance maneuver for this vehicle is unknown (i.e., GV14 equals "99").

Variable Name: Precrash Directional Consequences of Avoidance
Maneuver (Corrective Action)

Element Values:

- 0 No avoidance maneuver
- 1 Vehicle stayed in travel lane where avoidance maneuver was initiated
- 2 Vehicle stayed on roadway but left travel lane where avoidance maneuver was initiated
- 3 Vehicle stayed on roadway, not known if left travel lane where avoidance maneuver was initiated
- 4 Vehicle departed roadway
- 5 Avoidance maneuver initiated off roadway
- 8 No driver present
- 9 Directional consequences unknown

Source: Researcher determined: inputs include vehicle and scene evidence, interviews and police report.

Remarks:

This variable describes the consequences of the avoidance maneuver identified in variable GV14, Attempted Avoidance Maneuver, and further reports the results of the vehicle's precrash stability coded in variable GV66, Precrash Stability After Avoidance Maneuver. The responses for this variable must relate directly to the response coded for variable GV66.

Code "0" (No avoidance maneuver) is coded whenever the driver took no evasive action prior to the first impact for this vehicle.

Code "1" (Vehicle stayed in travel lane where avoidance maneuver was initiated) is used whenever a corrective action was taken and the "majority" of the vehicle remained within the boundaries of its initial travel lane. The perimeter of the vehicle is to be considered when determining the vehicle's status within its travel lane.

Code "2" (Vehicle stayed on roadway but left travel lane where avoidance maneuver was initiated) is coded whenever the "majority" of the vehicle departed its initial travel lane as a result of an avoidance maneuver; however, the "majority" of the vehicle remained within the boundaries of the roadway (travel lanes). Refer to pages 10-12 of this manual to determine the proper boundaries. The perimeter of the vehicle is to be considered when determining the vehicles status within the roadway.

Code "3" (Vehicle stayed on roadway, not known if left travel lane where avoidance maneuver was initiated) is coded whenever it was determined that an avoidance maneuver occurred, however, it cannot be ascertained whether the "majority" of the vehicle remained within its initial travel lane. To use this code, the "majority" of the vehicle must have remained within the boundaries of the roadway (See pages 10-12 of this manual).

Variable Name: Precrash Stability After Avoidance Maneuver

- Code "4" (Vehicle departed roadway) is used whenever the "majority" of the vehicle departed the roadway as a result of an avoidance maneuver initiated on the roadway. The roadway departure must be a result of an avoidance maneuver and not related to the post impact trajectory of an accident within the roadway.
- Code "5" (Avoidance maneuver initiated off roadway) is used whenever the avoidance maneuver was initiated outside the boundaries of the travel lanes. This includes maneuvers taken on the shoulders, within the median, on the roadside, or off the trafficway.
- Code "8" (No driver present) is used when no driver was present in the vehicle at the time it was involved in the accident.
- Code "9" (Directional consequences unknown) is used whenever the directional consequences of an avoidance maneuver cannot be determined. This code also applies when the attempted avoidance maneuver for this vehicle is unknown (i.e., GV14 equals "99")

PRECRASH GENERAL RULES

1. GV14 (Attempted Avoidance Maneuver) assesses what the vehicle did rather than what the driver stated he/she tried to do.
2. A traffic control signal/sign can never make the situation critical when coding GV65 (Critical Precrash Event).
3. When you know what sub-group of the "Critical Precrash Event" applies but is unable to select a specific element, then default to one of the "other" or "unknown" codes (i.e., "08", "19", "59", "78", "82", "85", "89", or "92") in that sub-group rather than using code "98" (Other critical precrash event).
4. If control is lost due to driver illness such as heart attacks, diabetic comas, etc., then GV65 (Critical Precrash Event) equals code "08" (Other cause of control loss).
5. In coding GV65 (Critical Precrash Event) loss of control must have occurred prior to the driver doing any avoidance maneuver. If the driver attempts a maneuver (i.e., brakes, steers, etc.) as a result of the driver's perception of a vehicle, object, pedestrian, or nonmotorist, then code the vehicle, object pedestrian, or nonmotorist as what made it critical. If the vehicle is in a yaw prior to the driver taking an avoidance action, then loss-of-control is what made it critical (e.g., critical curve scuff, hydroplaning, etc.).
6. If in coding GV65 (Critical Precrash Event) it can not be determined from available sources (e.g., PAR, scene inspections, interviews, etc.) which driver had the right-of-way at a controlled or uncontrolled intersection, then use the following as a guideline:
 - a. If the junction is controlled by a 3-way/4-way stop sign or is uncontrolled, then use the common rule that the vehicle on the right has the right-of-way for determining encroachment.
 - b. If the junction is controlled by an on-colors traffic control device, and both drivers claim a green light, then code both vehicles as being in an environmentally dangerous position, GV65 (Critical Precrash Event) equals code "17" [Crossing over (passing through) intersection].
7. In coding GV65 (Critical Precrash Event) for vehicles executing a left turn with the right-of-way, use code "62" (From opposite direction-over left lane line) or code "63" (From opposite direction-over right lane line).
8. In coding GV65 (Critical Precrash Event) "fixed" objects can not be in the roadway.
9. If a motor vehicle is stopped in a travel lane and is impacted by another motor vehicle ricocheting off a vehicle, then GV65 (Critical Precrash Event) for the ricocheting vehicle is coded as codes "51-59" (Other Motor Vehicle In Lane) or codes "60-74" (Other Motor Vehicle Encroaching Into Lane).
10. If there are no skid marks present at the scene and the vehicle did not rotate 30 degrees or more (either clockwise or counterclockwise), then code GV66 (Precrash Stability After Avoidance Maneuver) as "1" (Tracking).



EXTERIOR VEHICLE FORM

1. Primary Sampling Unit Number _____	3. Vehicle Number _____
2. Case Number - Stratum _____	

VEHICLE IDENTIFICATION

VIN _____ Model Year _____

Vehicle Make (specify): _____ Vehicle Model (specify): _____

LOCATOR

Locate the end of the damage with respect to the vehicle longitudinal center line or bumper corner for end impacts or an undamaged axle for side impacts.

Specific Impact No.	Location of Direct Damage	Location of Field L

CRUSH PROFILE IN CENTIMETERS

NOTES: Identify the plane at which the C-measurements are taken (e.g., at bumper, above bumper, at sill, above sill, etc.) and label adjustments (e.g., free space).

Measure and document on the vehicle diagram the location of maximum crush.

Measure C1 to C6 from driver to passenger side in front or rear impacts and rear to front in side impacts.

Free space value is defined as the distance between the baseline and the original body contour taken at the individual C locations. This may include the following: bumper lead, bumper taper, side protrusion, side taper, etc. Record the value for each C-measurement and maximum crush.

Use as many lines/columns as necessary to describe each damage profile.

Specific Impact Number	Plane of Impact C-Measurements	Direct Damage		Field L	C ₁	C ₂	C ₃	C ₄	C ₅	C ₆	±D
		Width (CDC)	Max Crush								

ORIGINAL SPECIFICATIONS WORK SHEET

Wheelbase ___ ___ . ___ inches x 2.54 = ___ ___ ___ cm
 Overall Length ___ ___ . ___ inches x 2.54 = ___ ___ ___ cm
 Maximum Width ___ ___ . ___ inches x 2.54 = ___ ___ ___ cm
 Curb Weight ___ ___, ___ . ___ pounds x .4536 = ___ ___, ___ . ___ kg
 Average Track ___ ___ . ___ inches x 2.54 = ___ ___ ___ cm
 Front Overhang ___ ___ . ___ inches x 2.54 = ___ ___ ___ cm
 Rear Overhang ___ ___ . ___ inches x 2.54 = ___ ___ ___ cm
 Undeformed End Width ___ ___ . ___ inches x 2.54 = ___ ___ ___ cm
 Engine Size: cyl./displ. ___ ___ ___ cc x .001 = ___ . ___ L
 ___ ___ ___ CID x .0164 = ___ . ___ L

VEHICLE DAMAGE SKETCH

<p>TIRE - WHEEL DAMAGE</p> <p>a. Rotation physically restricted _____</p> <p>b. Tire deflated _____</p> <p>RF _____ RF _____ LF _____ LF _____ RR _____ RR _____ LR _____ LR _____</p> <p>(1) Yes (2) No (8) NA (9) Unk.</p>	<p>ORIGINAL SPECIFICATIONS</p> <p>Wheelbase _____ cm</p> <p>Overall Length _____ cm</p> <p>Maximum Width _____ cm</p> <p>Curb Weight _____ kg</p> <p>Average Track _____ cm</p> <p>Front Overhang _____ cm</p> <p>Rear Overhang _____ cm</p> <p>Undeformed End Width _____ cm</p> <p>Engine Size: cyl./displ. _____ L</p>	<p>WHEEL STEER ANGLES (For locked front wheels or displaced rear axles only)</p> <p>RF ± _____ ° LF ± _____ ° RR ± _____ ° LR ± _____ °</p> <p>Within ± 5 degrees</p>
<p>TYPE OF TRANSMISSION</p> <p><input type="checkbox"/> Manual <input type="checkbox"/> Automatic</p>		<p>DRIVE WHEELS</p> <p><input type="checkbox"/> FWD <input type="checkbox"/> RWD <input type="checkbox"/> 4WD</p> <p>Approximate Cargo Weight _____ kg</p>

MEASUREMENTS IN CENTIMETERS

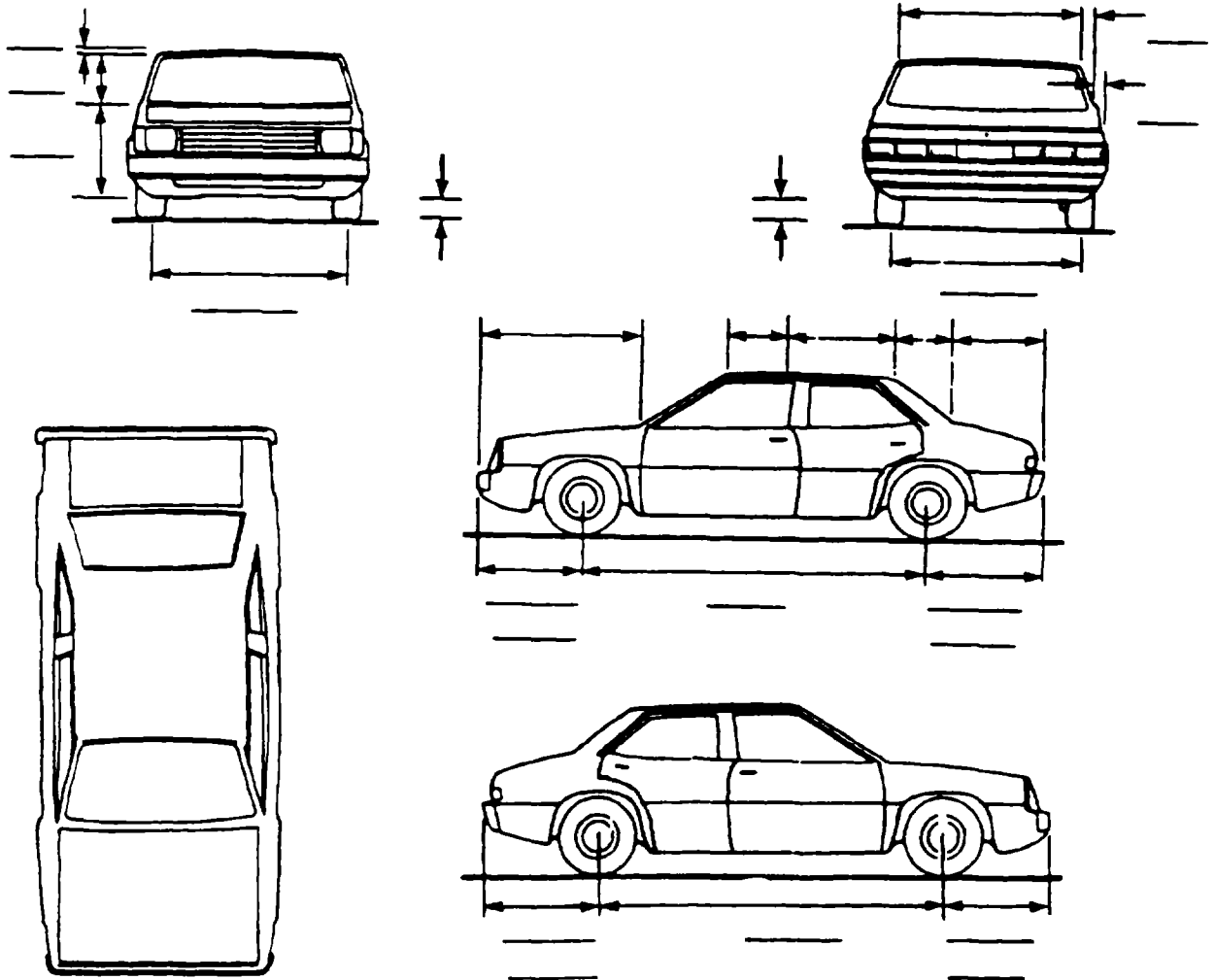

NOTES Sketch new perimeter and cross hatch direct damage and single hatch induced damage on all views. Annotate observations which might be useful in reconstructing the accident (e.g., grass in tire bead, direction of striations, scuff on sidewalls, etc.). If pulling trailer, sketch type of trailer and damage received on the back of this page.

Annotate any damage caused by extrication such as component removal by torching, prying, or hydraulic shears.

COLLISION DEFORMATION CLASSIFICATION

HIGHEST DELTA "V"

Accident Event Sequence Number	Object Contacted	(1) (2) Direction of Force	(3) Deformation Location	(4) Longitudinal or Lateral Location	(5) Vertical or Lateral Location	(6) Type of Damage Distribution	(7) Deformation Extent
--------------------------------	------------------	----------------------------	--------------------------	--------------------------------------	----------------------------------	---------------------------------	------------------------

4. _____ 5. _____ 6. _____ 7. _____ 8. _____ 9. _____ 10. _____ 11. _____

Second Highest Delta "V"

12. _____ 13. _____ 14. _____ 15. _____ 16. _____ 17. _____ 18. _____ 19. _____

CRUSH PROFILE IN CENTIMETERS

The crush profile for the damage described in the CDC(s) above should be documented in the appropriate space below. (ALL MEASUREMENTS ARE IN CENTIMETERS.)

HIGHEST DELTA "V"

20. L	21. C ₁	C ₂	C ₃	C ₄	C ₅	C ₆	22. ±D
_____	_____	_____	_____	_____	_____	_____	_____
_____	_____	_____	_____	_____	_____	_____	_____

Second Highest Delta "V"

23. L	24. C ₁	C ₂	C ₃	C ₄	C ₅	C ₆	25. ±D
_____	_____	_____	_____	_____	_____	_____	_____
_____	_____	_____	_____	_____	_____	_____	_____

26. Are CDCs Documented but Not Coded on The Automated File?
 (0) No
 (1) Yes

27. Researcher's Assessment of Vehicle Disposition
 (0) Not towed due to vehicle damage
 (1) Towed due to vehicle damage
 (9) Unknown

28. Original Wheelbase _____ Code to the nearest centimeter
 (999) Unknown

_____ inches X 2.54 = _____ centimeters

<p>29. Is This A Multi-Stage Manufactured Vehicle And/Or A Certified Altered Vehicle? _____</p> <p>(0) No post manufacturer modifications (1) Yes - post manufacturer modifications (specify): _____ _____</p> <p>(Include photograph of CERTIFICATION PLACARD in case report)</p> <p>(9) Unknown if vehicle is modified</p>	<p>34. Fuel Tank-1 Location _____</p>
<p>30. Fire Occurrence _____</p> <p>(0) No fire</p> <p>Yes, fire occurred</p> <p>(1) Minor (2) Major (9) Unknown</p>	<p>35. Fuel Tank-2 Location _____</p> <p>(0) No fuel tank (1) Aft of center of the rear wheels (rear axle) centered (2) Aft of center of the rear wheels (rear axle), left side (3) Aft of center of the rear wheels (rear axle) right side (4) Forward of center of the rear wheels (rear axle) centered (5) Forward of center of the rear wheels (rear axle) left side (6) Forward of center of the rear wheels (rear axle) right side (7) Over center of the rear wheels (rear axle) (8) Other (specify): _____ (9) Unknown</p>
<p>31. Origin of Fire _____</p> <p>(0) No fire (1) Vehicle exterior (front, side, back, top) (2) Exhaust system (3) Fuel tank (and other fuel retention system parts) (4) Engine compartment (5) Cargo/trunk compartment (6) Instrument panel (7) Passenger compartment area (8) Other location (specify): _____ (9) Unknown</p>	<p>36. Fuel Tank-1 Filler Cap Location _____</p>
<p>32. Type of Fuel Tank-1 _____</p>	<p>37. Fuel Tank-2 Filler Cap Location _____</p> <p>(0) No fuel tank (1) On back plane (2) Aft of center of the rear wheels (rear axle) on left side plane (3) Aft of center of the rear wheels (rear axle) on right side plane (4) Forward of center of the rear wheels (rear axle) on left side plane (5) Forward of center of the rear wheels (rear axle) on right side plane (6) Over the center of the rear wheels (rear axle) on left side plane (7) Over the center of the rear wheels (rear axle) on right side plane (8) Other (specify): _____ (9) Unknown</p>
<p>33. Type of Fuel Tank-2 _____</p> <p>(0) No fuel tank (electrical vehicle) (1) Metallic (2) Non-metallic (9) Unknown</p>	<p>38. Fuel Tank-1 Damage _____</p>
	<p>39. Fuel Tank-2 Damage _____</p> <p>(0) No fuel tank (1) No damage to fuel tank (2) Deformed, no seam failure (3) Deformed, with a seam failure (4) Punctured (5) Lacerated (ripped) (6) Abraded (scraped) (7) Filler neck separation from the fuel tank (8) Other damage (specify): _____ (9) Unknown</p>

<p>40. Location of Fuel System-1 Leakage _____</p> <p>41. Location of Fuel System-2 Leakage _____</p> <p>(0) No fuel tank</p> <p>(1) No fuel leakage</p> <p><i>Primary Area Of Leakage</i></p> <p>(2) Tank</p> <p>(3) Filler neck</p> <p>(4) Cap</p> <p>(5) Lines/pump/filter</p> <p>(6) Vent/emission recovery</p> <p>(8) Other (specify): _____</p> <p>(9) Unknown _____</p> <p>42. Fuel Type-1 _____</p> <p>43. Fuel Type-2 _____</p> <p><i>Single Fuel Type</i></p> <p>(00) No fuel tank</p> <p>(01) Gasoline</p> <p>(02) Diesel</p> <p>(03) CNG (Compressed Natural Gas)</p> <p>(04) LPG (Liquid Petroleum Gas) also known as Propane</p> <p>(05) LNG (Liquid Natural Gas)</p> <p>(06) Methanol (M100 or M85)</p> <p>(07) Ethanol (E100 or E85)</p> <p>(08) Other (Hydrogen or others) (specify): _____</p> <p><i>Electric Powered or Electric/Solar Powered Vehicles</i></p> <p>(10) Lead Acid Battery</p> <p>(11) Nickel-Iron Battery</p> <p>(12) Nickel-Cadmium Battery</p> <p>(13) Sodium Metal Chloride Battery</p> <p>(14) Sodium Sulfur Battery</p> <p>(18) Other (Specify): _____</p> <p>(98) Other Hybrid (specify): _____</p> <p>(99) Unknown fuel type</p>	<p>44. Is This Vehicle Equipped With More Than Two Fuel Tanks? _____</p> <p>(0) No (one or two tanks only)</p> <p><i>Yes - More Than Two Tanks</i></p> <p>(1) Yes -- <u>no damage</u> to any tank or filler cap and <u>no fuel system leakage</u></p> <p>(2) Yes -- <u>no damage</u> to any tank or filler cap but <u>there is fuel system leakage</u> (specify leakage location): _____</p> <p>(3) Yes -- <u>damage</u> to an additional tank or filler cap and <u>there is fuel system leakage</u> (specify the following): Type of tank _____ Tank location _____ Filler cap location _____ Tank damage _____ Location of leakage _____ Type of fuel _____</p> <p>(9) Unknown if more than two tanks</p>
<p style="text-align: center;">COMMENTS</p> <p>_____</p> <p>_____</p> <p>_____</p> <p>_____</p> <p>_____</p> <p>_____</p> <p>_____</p> <p>_____</p> <p>_____</p> <p>_____</p>	

*** STOP: IF THE CDS APPLICABLE VEHICLE WAS NOT TOWED AND WAS NOT AN AOPS ***
(I.E., GV09 = 0 OR 9 AND GV36 = 0), DO NOT COMPLETE THE INTERIOR VEHICLE FORM.



EXTERIOR VEHICLE LOG

TO BE COMPLETED BY TEAM																																																																																			
1. PSU Number _____	13. Number of Coded CDCs (0,1,2) _____																																																																																		
2. Case Number—Stratum _____	14. Number of Coded Crush Profiles (0,1,2) _____																																																																																		
3. Researcher Completing Form _____																																																																																			
4. Vehicle Number _____																																																																																			
5. Date Vehicle Inspected ____/____/____																																																																																			
6. Number of Exterior Vehicle Slides _____																																																																																			
TO BE COMPLETED BY ZONE CENTER																																																																																			
7. Applicable Precrash Measurements _____ (0) Not applicable (1) Substandard - beyond researcher control (2) Substandard (3) Standard	<p style="text-align: center;">DATA STATUS OF VARIABLE NUMBERS 4-32</p> <p>Highest CDC</p> <table style="margin-left: auto; margin-right: auto; border-collapse: collapse;"> <tr> <td style="padding: 2px 5px;">4</td><td style="padding: 2px 5px;">5</td><td style="padding: 2px 5px;">6</td><td style="padding: 2px 5px;">7</td><td style="padding: 2px 5px;">8</td><td style="padding: 2px 5px;">9</td><td style="padding: 2px 5px;">10</td><td style="padding: 2px 5px;">11</td> </tr> <tr> <td style="border: 1px solid black; width: 20px; height: 20px;"></td><td style="border: 1px solid black; width: 20px; height: 20px;"></td><td style="border: 1px solid black; width: 20px; height: 20px;"></td><td style="border: 1px solid black; width: 20px; height: 20px;"></td><td style="border: 1px solid black; width: 20px; height: 20px;"></td><td style="border: 1px solid black; width: 20px; height: 20px;"></td><td style="border: 1px solid black; width: 20px; height: 20px;"></td><td style="border: 1px solid black; width: 20px; height: 20px;"></td> </tr> </table> <p>Secondary CDC</p> <table style="margin-left: auto; margin-right: auto; border-collapse: collapse;"> <tr> <td style="padding: 2px 5px;">12</td><td style="padding: 2px 5px;">13</td><td style="padding: 2px 5px;">14</td><td style="padding: 2px 5px;">15</td><td style="padding: 2px 5px;">16</td><td style="padding: 2px 5px;">17</td><td style="padding: 2px 5px;">18</td><td style="padding: 2px 5px;">19</td> </tr> <tr> <td style="border: 1px solid black; width: 20px; height: 20px;"></td><td style="border: 1px solid black; width: 20px; height: 20px;"></td><td style="border: 1px solid black; width: 20px; height: 20px;"></td><td style="border: 1px solid black; width: 20px; height: 20px;"></td><td style="border: 1px solid black; width: 20px; height: 20px;"></td><td style="border: 1px solid black; width: 20px; height: 20px;"></td><td style="border: 1px solid black; width: 20px; height: 20px;"></td><td style="border: 1px solid black; width: 20px; height: 20px;"></td> </tr> </table> <p>Highest Crush Profile</p> <table style="margin-left: auto; margin-right: auto; border-collapse: collapse;"> <tr> <td style="padding: 2px 5px;">20</td><td style="padding: 2px 5px;">21</td><td style="padding: 2px 5px;">22</td> </tr> <tr> <td style="border: 1px solid black; width: 20px; height: 20px;"></td><td style="border: 1px solid black; width: 20px; height: 20px;"></td><td style="border: 1px solid black; width: 20px; height: 20px;"></td> </tr> </table> <p>Secondary Crush Profile</p> <table style="margin-left: auto; margin-right: auto; border-collapse: collapse;"> <tr> <td style="padding: 2px 5px;">23</td><td style="padding: 2px 5px;">24</td><td style="padding: 2px 5px;">25</td> </tr> <tr> <td style="border: 1px solid black; width: 20px; height: 20px;"></td><td style="border: 1px solid black; width: 20px; height: 20px;"></td><td style="border: 1px solid black; width: 20px; height: 20px;"></td> </tr> </table> <p>Highest CDC</p> <table style="margin-left: auto; margin-right: auto; border-collapse: collapse;"> <tr> <td style="padding: 2px 5px;">26</td><td style="padding: 2px 5px;">27</td><td style="padding: 2px 5px;">28</td><td style="padding: 2px 5px;">29</td><td style="padding: 2px 5px;">30</td><td style="padding: 2px 5px;">31</td><td style="padding: 2px 5px;">32</td><td style="padding: 2px 5px;">33</td> </tr> <tr> <td style="border: 1px solid black; width: 20px; height: 20px;"></td><td style="border: 1px solid black; width: 20px; height: 20px;"></td><td style="border: 1px solid black; width: 20px; height: 20px;"></td><td style="border: 1px solid black; width: 20px; height: 20px;"></td><td style="border: 1px solid black; width: 20px; height: 20px;"></td><td style="border: 1px solid black; width: 20px; height: 20px;"></td><td style="border: 1px solid black; width: 20px; height: 20px;"></td><td style="border: 1px solid black; width: 20px; height: 20px;"></td> </tr> </table> <p>Highest CDC</p> <table style="margin-left: auto; margin-right: auto; border-collapse: collapse;"> <tr> <td style="padding: 2px 5px;">34</td><td style="padding: 2px 5px;">35</td><td style="padding: 2px 5px;">36</td><td style="padding: 2px 5px;">37</td><td style="padding: 2px 5px;">38</td><td style="padding: 2px 5px;">39</td><td style="padding: 2px 5px;">40</td><td style="padding: 2px 5px;">41</td><td style="padding: 2px 5px;">42</td><td style="padding: 2px 5px;">43</td><td style="padding: 2px 5px;">44</td> </tr> <tr> <td style="border: 1px solid black; width: 20px; height: 20px;"></td><td style="border: 1px solid black; width: 20px; height: 20px;"></td><td style="border: 1px solid black; width: 20px; height: 20px;"></td><td style="border: 1px solid black; width: 20px; height: 20px;"></td><td style="border: 1px solid black; width: 20px; height: 20px;"></td><td style="border: 1px solid black; width: 20px; height: 20px;"></td><td style="border: 1px solid black; width: 20px; height: 20px;"></td><td style="border: 1px solid black; width: 20px; height: 20px;"></td><td style="border: 1px solid black; width: 20px; height: 20px;"></td><td style="border: 1px solid black; width: 20px; height: 20px;"></td><td style="border: 1px solid black; width: 20px; height: 20px;"></td> </tr> </table> <p>Data Status Codes:</p> <p>(Blank) Correct (1) Derived error (2) Non-correctable error (3) Correctable error (4) Change—no error (5) Sequencing error (7) Incorrect edit override (8) MDE error (9) Unknown coded</p>	4	5	6	7	8	9	10	11									12	13	14	15	16	17	18	19									20	21	22				23	24	25				26	27	28	29	30	31	32	33									34	35	36	37	38	39	40	41	42	43	44											
4	5	6	7	8	9	10	11																																																																												
12	13	14	15	16	17	18	19																																																																												
20	21	22																																																																																	
23	24	25																																																																																	
26	27	28	29	30	31	32	33																																																																												
34	35	36	37	38	39	40	41	42	43	44																																																																									
8. Impact Damage Documentation _____ (0) Not applicable (1) Substandard - beyond researcher control (2) Substandard (3) Standard																																																																																			
9. Quality Of Vehicle Damage Sketch _____ (0) Not applicable (e.g., repaired vehicle) (1) Substandard - beyond researcher control (2) Substandard (3) Standard																																																																																			
10. Exterior Slides Subject Quality _____ (0) Not applicable (1) Substandard - beyond researcher control (2) Substandard (3) Standard																																																																																			
11. Exterior Slides Quality _____ (0) Not applicable (1) Substandard - beyond researcher control (2) Substandard (3) Standard																																																																																			
12. Primary Error Source (Vehicle Plane) _____ (0) No error (1) Front (2) Side (left or right) (3) Back (rear) (4) Top (5) Undercarriage (8) Other (specify): _____																																																																																			
IF THIS VEHICLE WAS NOT TOWED (I.E., GV09 ≠ 1), DO NOT COMPLETE THE INTERIOR VEHICLE LOG																																																																																			

VEHICLE DAMAGE SKETCH

<p>TIRE - WHEEL DAMAGE</p> <p>a. Rotation physically restricted b. Tire deflated</p> <p>RF _____ RF _____ LF _____ LF _____ RR _____ RR _____ LR _____ LR _____</p> <p>(1) Yes (2) No (8) NA (9) Unk.</p>	<p>ORIGINAL SPECIFICATIONS</p> <p>Wheelbase _____ cm Overall Length _____ cm Maximum Width _____ cm Curb Weight _____ kg Average Track _____ cm Front Overhang _____ cm Rear Overhang _____ cm Undeformed End Width _____ cm Engine Size: cyl./displ. _____ L</p>	<p>WHEEL STEER ANGLES (For locked front wheels or displaced rear axles only)</p> <p>RF ± _____ ° LF ± _____ ° RR ± _____ ° LR ± _____ °</p> <p>Within ± 5 degrees</p>
<p>TYPE OF TRANSMISSION</p> <p><input type="checkbox"/> Manual <input type="checkbox"/> Automatic</p>	<p>DRIVE WHEELS</p> <p><input type="checkbox"/> FWD <input type="checkbox"/> RWD <input type="checkbox"/> 4WD</p>	<p>Approximate Cargo Weight _____ kg</p>

MEASUREMENTS IN CENTIMETERS

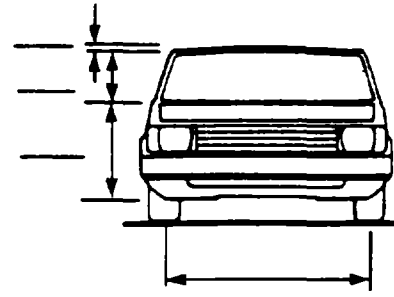

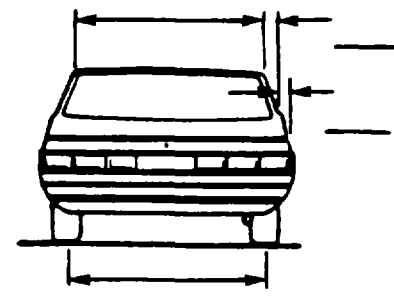



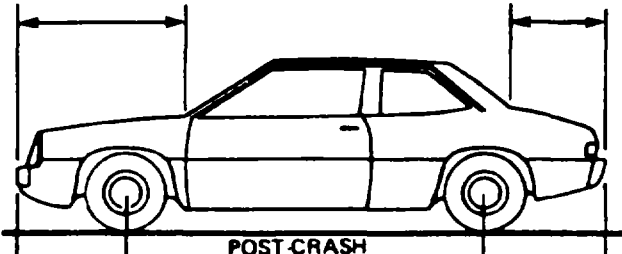

Bumper corner _____

Stringline _____

Bumper corner _____

Stringline _____

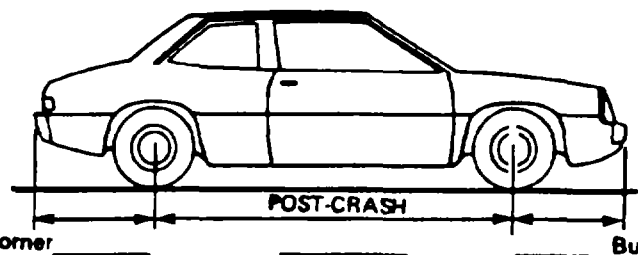

Bumper corner _____

Stringline _____

Bumper corner _____

Stringline _____

NOTES Sketch new penmeter and cross hatch direct damage and single hatch induced damage on all views. Annotate observations which might be useful in reconstructing the accident (e.g., grass in tire bead, direction of striations, scuff on sidewalls, etc.). If pulling trailer, sketch type of trailer and damage received on the back of this page.

Annotate any damage caused by extrication such as component removal by torching, prying, or hydraulic shears.

VEHICLE DAMAGE SKETCH

<p>TIRE—WHEEL DAMAGE a. Rotation physically restricted b. Tire deflated</p> <p>RF _____ LF _____ RR _____ LR _____</p> <p>RF _____ LF _____ RR _____ LR _____</p> <p>(1) Yes (2) No (8) NA (9) Unk.</p>	<p>ORIGINAL SPECIFICATIONS</p> <p>Wheelbase _____ cm</p> <p>Overall Length _____ cm</p> <p>Maximum Width _____ cm</p> <p>Curb Weight _____ kg</p> <p>Average Track _____ cm</p> <p>Front Overhang _____ cm</p> <p>Rear Overhang _____ cm</p> <p>Undeformed End Width _____ cm</p> <p>Engine Size: cyl./displ. _____ L</p>	<p>WHEEL STEER ANGLES (For locked front wheels or displaced rear axles only)</p> <p>RF ± _____ °</p> <p>LF ± _____ °</p> <p>RR ± _____ °</p> <p>LR ± _____ °</p> <p>Within ± 5 degrees</p> <hr/> <p>DRIVE WHEELS</p> <p><input type="checkbox"/> FWD <input type="checkbox"/> RWD <input type="checkbox"/> 4WD</p> <hr/> <p>Approximate Cargo Weight _____ kg</p>
<p>TYPE OF TRANSMISSION</p> <p><input type="checkbox"/> Manual <input type="checkbox"/> Automatic</p>		

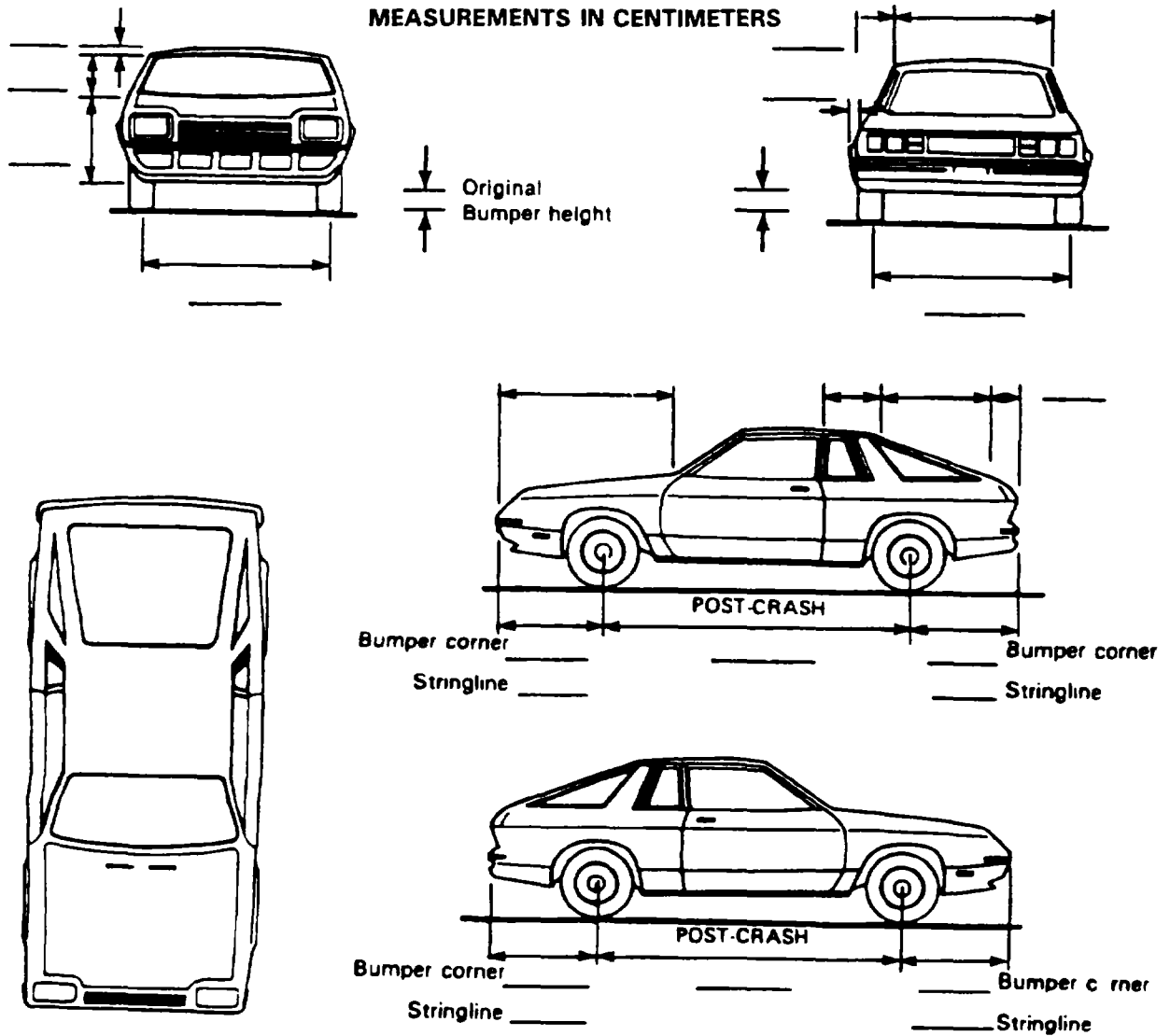

NOTES Sketch new penmeter and cross hatch direct damage and single hatch induced damage on all views. Annotate observations which might be useful in reconstructing the accident (e.g., grass in tire bead, direction of striations, scuff on sidewalls, etc.). If pulling trailer, sketch type of trailer and damage received on the back of this page

Annotate any damage caused by extrication such as component removal by torching, prying or hydraulic shears

VEHICLE DAMAGE SKETCH

<p>TIRE—WHEEL DAMAGE</p> <p>a. Rotation physically restricted _____ b. Tire deflated _____</p> <p>RF _____ RF _____ LF _____ LF _____ RR _____ RR _____ LR _____ LR _____</p> <p>(1) Yes (2) No (8) NA (9) Unk.</p>	<p>ORIGINAL SPECIFICATIONS</p> <p>Wheelbase _____ cm Overall Length _____ cm Maximum Width _____ cm Curb Weight _____ kg Average Track _____ cm Front Overhang _____ cm Rear Overhang _____ cm Undeformed End Width _____ cm Engine Size: cyl./displ. _____ L</p>	<p>WHEEL STEER ANGLES (For locked front wheels or displaced rear axles only)</p> <p>RF ± _____ ° LF ± _____ ° RR ± _____ ° LR ± _____ ° Within ± 5 degrees</p>
<p>TYPE OF TRANSMISSION</p> <p><input type="checkbox"/> Manual <input type="checkbox"/> Automatic</p>	<p>DRIVE WHEELS</p> <p><input type="checkbox"/> FWD <input type="checkbox"/> RWD <input type="checkbox"/> 4WD</p>	
		<p>Approximate Cargo Weight _____ kg</p>

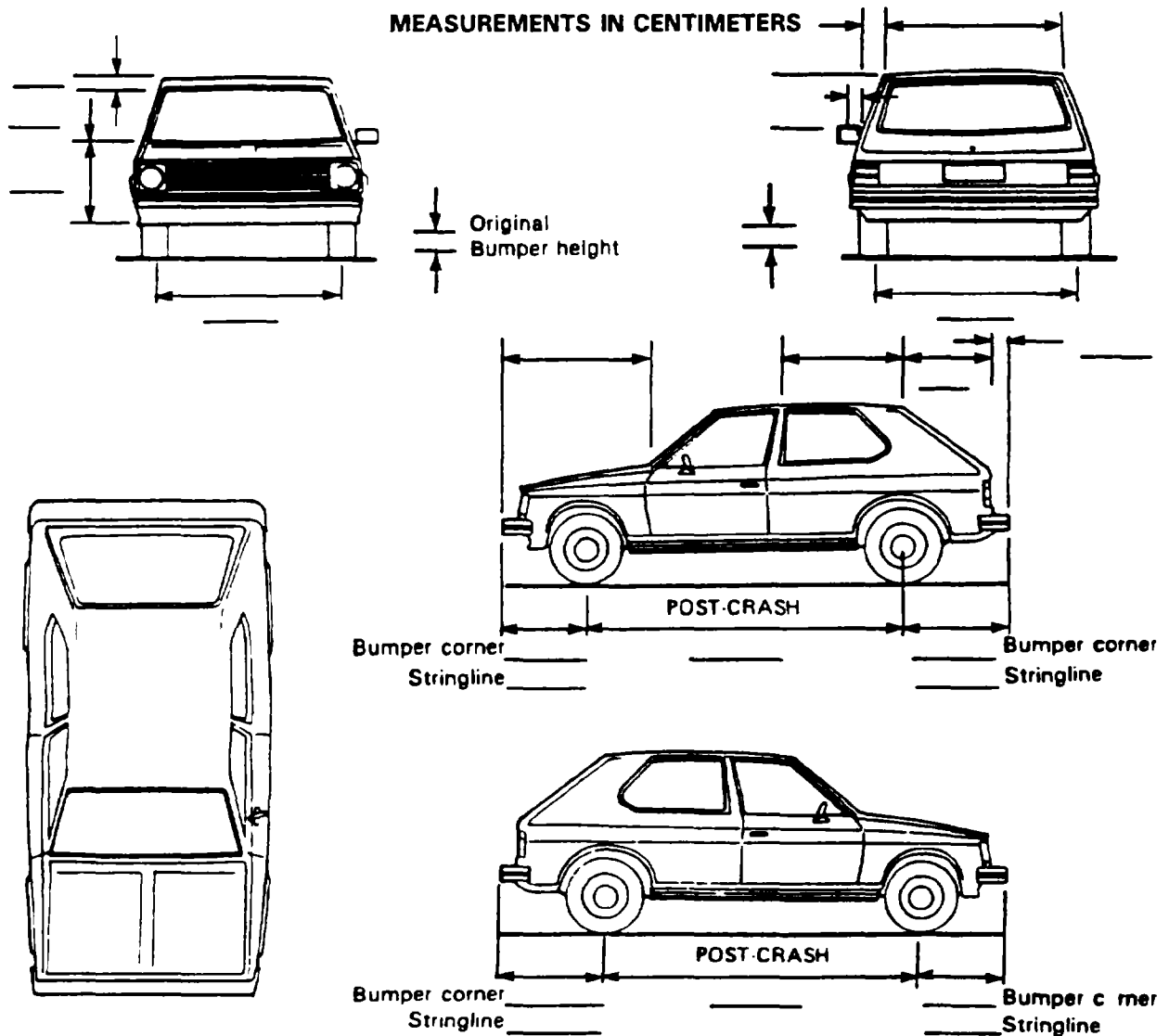

NOTES Sketch new perimeter and cross hatch direct damage and single hatch induced damage on all views. Annotate observations which might be useful in reconstructing the accident (e.g., grass in tire bead, direction of striations, scuff on sidewalls, etc.). If pulling trailer, sketch type of trailer and damage received on the back of this page.

Annotate any damage caused by extrication such as component removal by torching, prying, or hydraulic shears.

VEHICLE DAMAGE SKETCH

<p>TIRE—WHEEL DAMAGE</p> <p>a. Rotation physically restricted _____</p> <p>b. Tire deflated _____</p> <p>RF _____ RF _____</p> <p>LF _____ LF _____</p> <p>RR _____ RR _____</p> <p>LR _____ LR _____</p> <p>(1) Yes (2) No (8) NA (9) Unk.</p>	<p>ORIGINAL SPECIFICATIONS</p> <p>Wheelbase _____ cm</p> <p>Overall Length _____ cm</p> <p>Maximum Width _____ cm</p> <p>Curb Weight _____ kg</p> <p>Average Track _____ cm</p> <p>Front Overhang _____ cm</p> <p>Rear Overhang _____ cm</p> <p>Undeformed End Width _____ cm</p> <p>Engine Size: cyl./displ. _____ L</p>	<p>WHEEL STEER ANGLES (For locked front wheels or displaced rear axles only)</p> <p>RF ± _____ °</p> <p>LF ± _____ °</p> <p>RR ± _____ °</p> <p>LR ± _____ °</p> <p>Within ± 5 degrees</p>
<p>TYPE OF TRANSMISSION</p> <p><input type="checkbox"/> Manual <input type="checkbox"/> Automatic</p>		<p>DRIVE WHEELS</p> <p><input type="checkbox"/> FWD <input type="checkbox"/> RWD <input type="checkbox"/> 4WD</p>
		<p>Approximate Cargo Weight _____ kg</p>

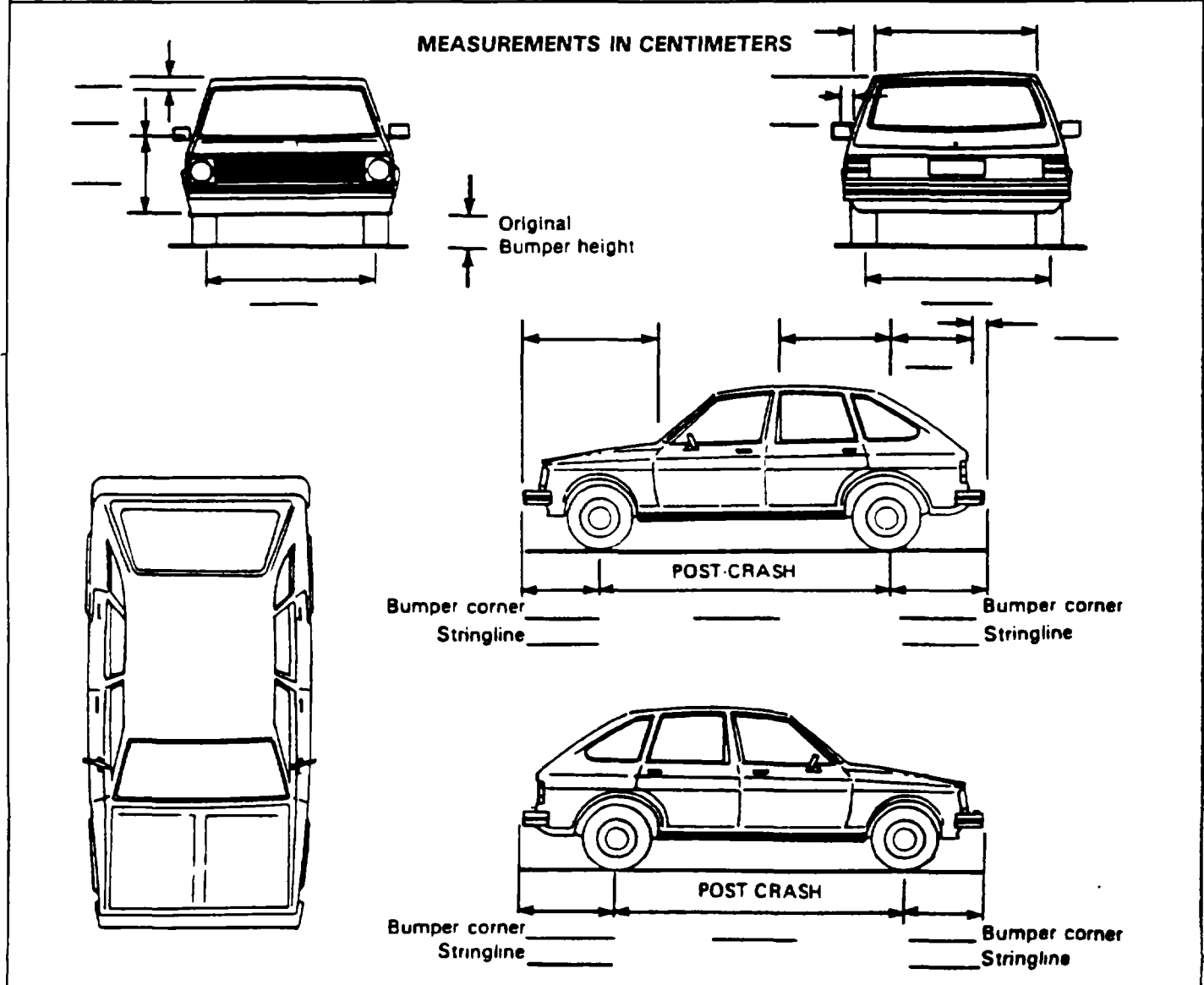

NOTES Sketch new perimeter and cross hatch direct damage and single hatch induced damage on all views. Annotate observations which might be useful in reconstructing the accident (e.g., grass in tire bead, direction of striations, scuff on sidewalls, etc.). If pulling trailer, sketch type of trailer and damage received on the back of this page.

Annotate any damage caused by extraction such as component removal by torching, prying, or hydraulic shears.

VEHICLE DAMAGE SKETCH

<p>TIRE—WHEEL DAMAGE</p> <p>a. Rotation physically restricted _____</p> <p>b. Tire deflated _____</p> <p>RF _____ RF _____ LF _____ LF _____ RR _____ RR _____ LR _____ LR _____</p> <p>(1) Yes (2) No (8) NA (9) Unk.</p>	<p>ORIGINAL SPECIFICATIONS</p> <p>Wheelbase _____ cm</p> <p>Overall Length _____ cm</p> <p>Maximum Width _____ cm</p> <p>Curb Weight _____ kg</p> <p>Average Track _____ cm</p> <p>Front Overhang _____ cm</p> <p>Rear Overhang _____ cm</p> <p>Undeformed End Width _____ cm</p> <p>Engine Size: cyl./displ. _____ L</p>	<p>WHEEL STEER ANGLES (For locked front wheels or displaced rear axles only)</p> <p>RF ± _____ ° LF ± _____ ° RR ± _____ ° LR ± _____ °</p> <p>Within ± 5 degrees</p>
<p>TYPE OF TRANSMISSION</p> <p><input type="checkbox"/> Manual <input type="checkbox"/> Automatic</p>	<p>DRIVE WHEELS</p> <p><input type="checkbox"/> FWD <input type="checkbox"/> RWD <input type="checkbox"/> 4WD</p> <p>Approximate Cargo Weight _____ kg</p>	

MEASUREMENTS IN CENTIMETERS

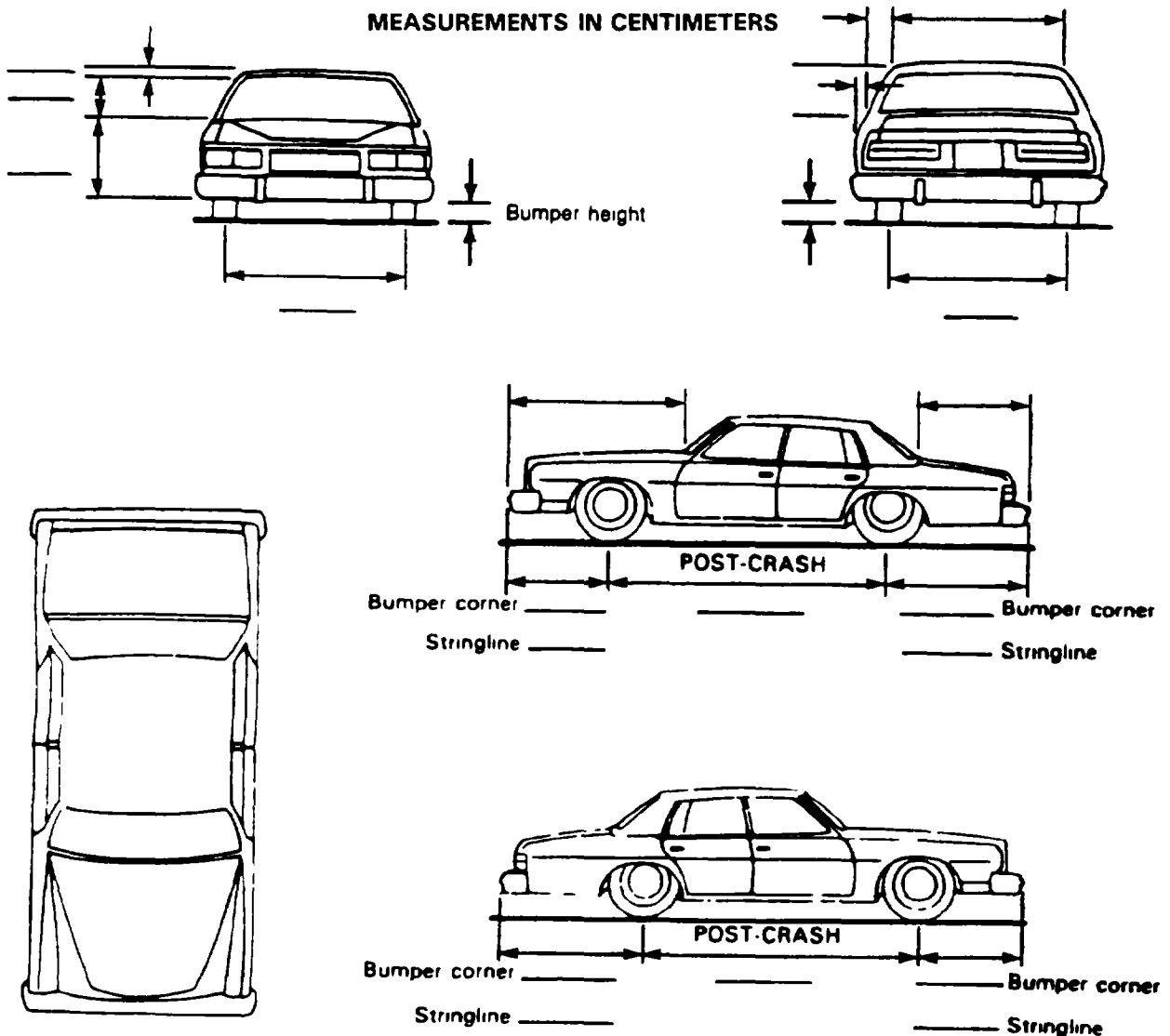

NOTES Sketch new penmeter and cross hatch direct damage and single hatch induced damage on all views. Annotate observations which might be useful in reconstructing the accident (e.g., grass in tire bead, direction of striations, scuff on sidewalls, etc.). If pulling trailer, sketch type of trailer and damage received on the back of this page.

Annotate any damage caused by extrication such as component removal by torching, prying, or hydraulic shears.

VEHICLE DAMAGE SKETCH

<p>TIRE—WHEEL DAMAGE a. Rotation physically restricted b. Tire deflated</p> <p>RF _____ RF _____ LF _____ LF _____ RR _____ RR _____ LR _____ LR _____</p> <p>(1) Yes (2) No (8) NA (9) Unk.</p>	<p>ORIGINAL SPECIFICATIONS</p> <p>Wheelbase _____ cm Overall Length _____ cm Maximum Width _____ cm Curb Weight _____ kg Average Track _____ cm Front Overhang _____ cm Rear Overhang _____ cm Undeformed End Width _____ cm Engine Size: cyl./displ. _____ L</p>	<p>WHEEL STEER ANGLES (For locked front wheels or displaced rear axles only)</p> <p>RF ± _____ ° LF ± _____ ° RR ± _____ ° LR ± _____ ° Within ± 5 degrees</p> <p>DRIVE WHEELS <input type="checkbox"/> FWD <input type="checkbox"/> RWD <input type="checkbox"/> 4WD</p> <p>Approximate Cargo Weight _____ kg</p>
<p>TYPE OF TRANSMISSION</p> <p><input type="checkbox"/> Manual <input type="checkbox"/> Automatic</p>		

MEASUREMENTS IN CENTIMETERS

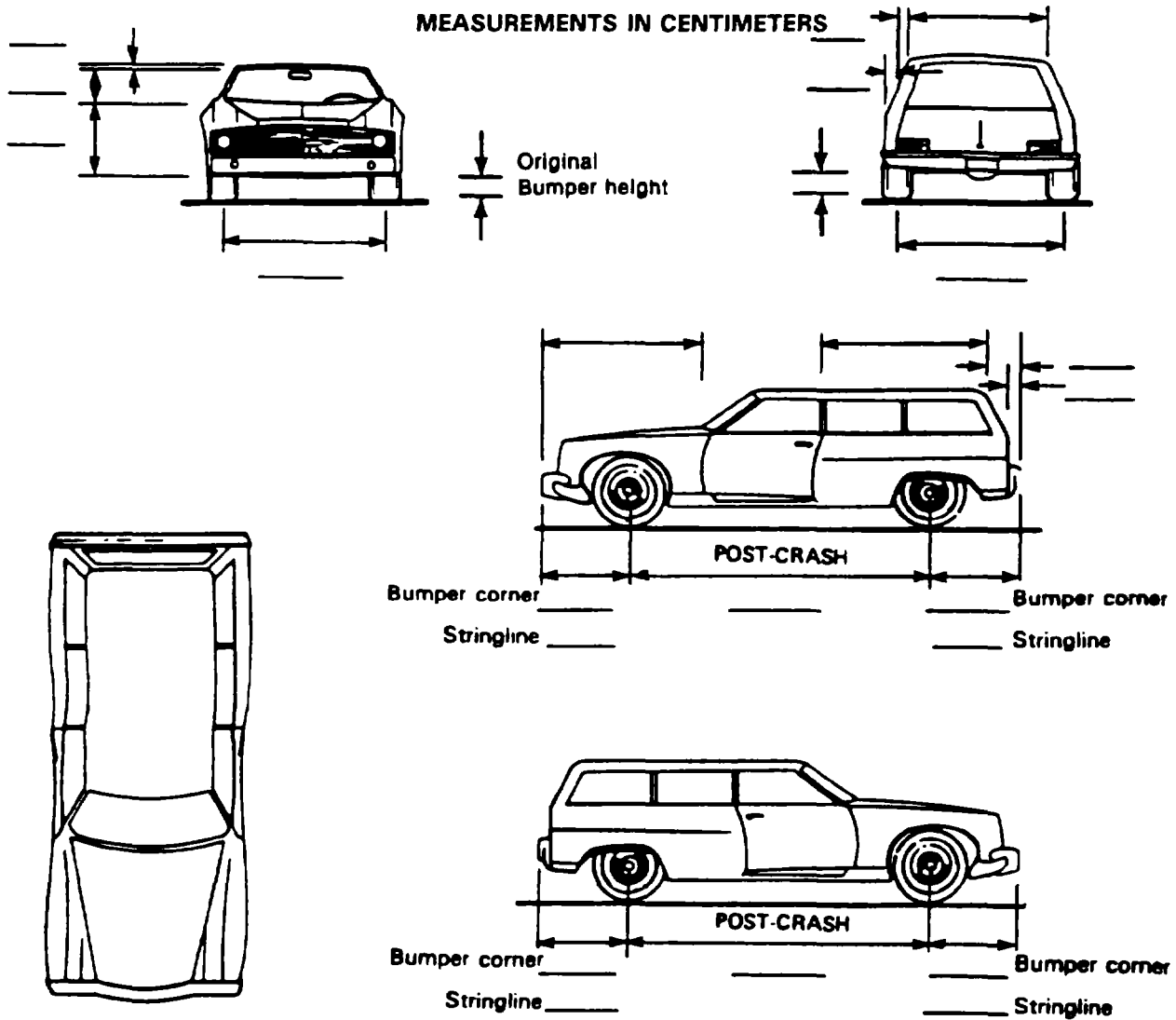

NOTES Sketch new perimeter and cross hatch direct damage and single hatch induced damage on all views. Annotate observations which might be useful in reconstructing the accident (e.g., grass in tire bead, direction of striations, scuff on sidewalls, etc.) If pulling trailer, sketch type of trailer and damage received on the back of this page. Annotate any damage caused by extrication such as component removal by torching, prying, or hydraulic shears.

VEHICLE DAMAGE SKETCH

<p>TIRE—WHEEL DAMAGE</p> <p>a. Rotation physically restricted RF _____ LF _____ RR _____ LR _____</p> <p>b. Tire deflated RF _____ LF _____ RR _____ LR _____</p> <p>(1) Yes (2) No (8) NA (9) Unk.</p>	<p>ORIGINAL SPECIFICATIONS</p> <p>Wheelbase _____ cm</p> <p>Overall Length _____ cm</p> <p>Maximum Width _____ cm</p> <p>Curb Weight _____ kg</p> <p>Average Track _____ cm</p> <p>Front Overhang _____ cm</p> <p>Rear Overhang _____ cm</p> <p>Undeformed End Width _____ cm</p> <p>Engine Size: cyl./displ. _____ L</p>	<p>WHEEL STEER ANGLES (For locked front wheels or displaced rear axles only)</p> <p>RF ± _____ °</p> <p>LF ± _____ °</p> <p>RR ± _____ °</p> <p>LR ± _____ °</p> <p>Within ± 5 degrees</p>
<p>TYPE OF TRANSMISSION</p> <p><input type="checkbox"/> Manual <input type="checkbox"/> Automatic</p>	<p>DRIVE WHEELS</p> <p><input type="checkbox"/> FWD <input type="checkbox"/> RWD <input type="checkbox"/> 4WD</p>	
		<p>Approximate Cargo Weight _____ kg</p>

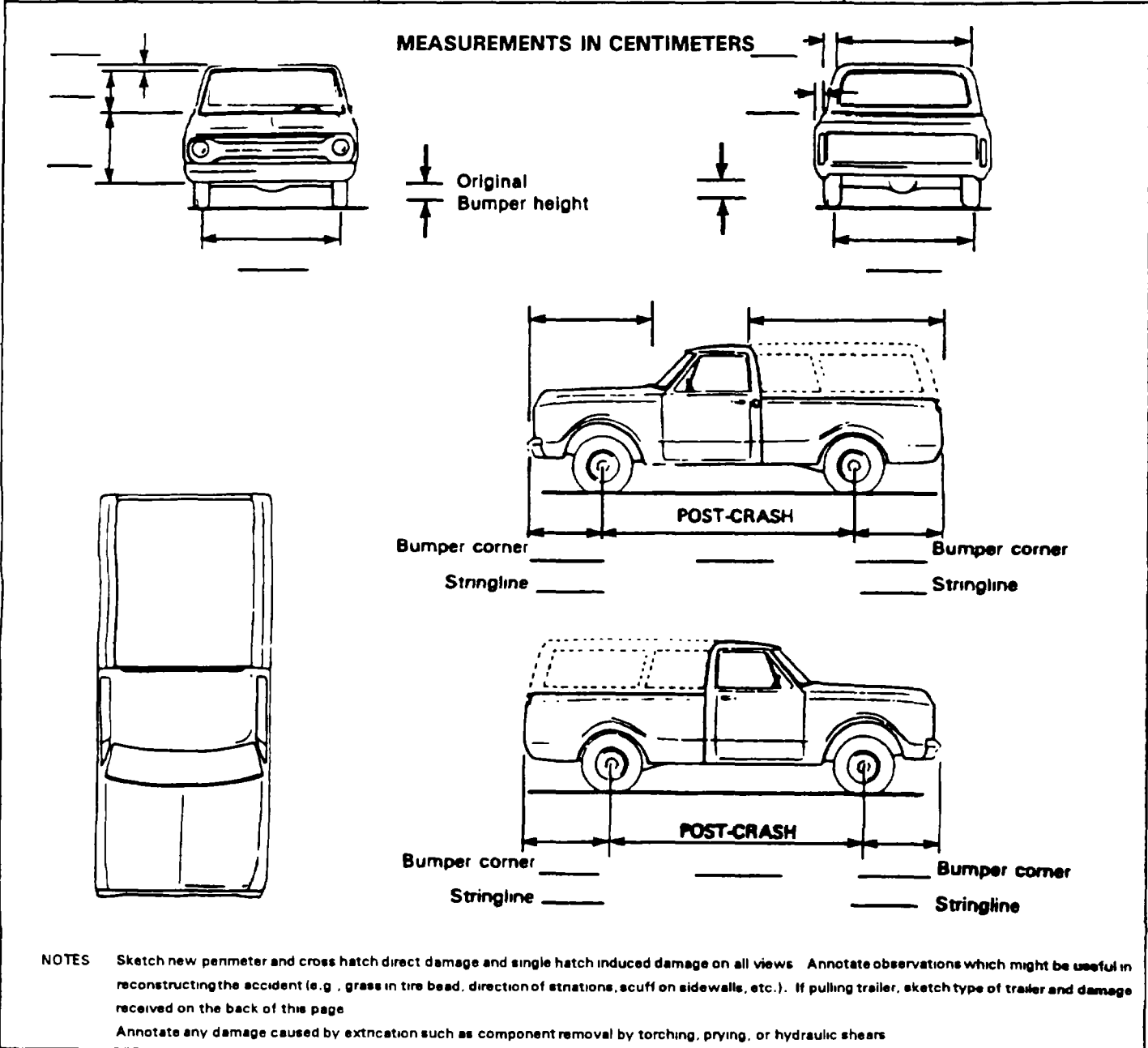

NOTES Sketch new penmeter and cross hatch direct damage and single hatch induced damage on all views. Annotate observations which might be useful in reconstructing the accident (e.g., grass in tire bead, direction of striations, scuff on sidewalls, etc.). If pulling trailer, sketch type of trailer and damage received on the back of this page.

Annotate any damage caused by extrication such as component removal by torching, prying, or hydraulic shears.

VEHICLE DAMAGE SKETCH

<p>TIRE—WHEEL DAMAGE</p> <p>a. Rotation physically restricted b. Tire deflated</p> <p>RF _____ RF _____ LF _____ LF _____ RR _____ RR _____ LR _____ LR _____</p> <p>(1) Yes (2) No (8) NA (9) Unk.</p>	<p>ORIGINAL SPECIFICATIONS</p> <p>Wheelbase _____ cm Overall Length _____ cm Maximum Width _____ cm Curb Weight _____ kg Average Track _____ cm Front Overhang _____ cm Rear Overhang _____ cm Undeformed End Width _____ cm Engine Size: cyl./displ. _____ L</p>	<p>WHEEL STEER ANGLES (For locked front wheels or displaced rear axles only)</p> <p>RF ± _____ ° LF ± _____ ° RR ± _____ ° LR ± _____ ° Within ± 5 degrees</p> <hr/> <p>DRIVE WHEELS</p> <p><input type="checkbox"/> FWD <input type="checkbox"/> RWD <input type="checkbox"/> 4WD</p> <hr/> <p>Approximate Cargo Weight _____ kg</p>
<p>TYPE OF TRANSMISSION</p> <p><input type="checkbox"/> Manual <input type="checkbox"/> Automatic</p>		

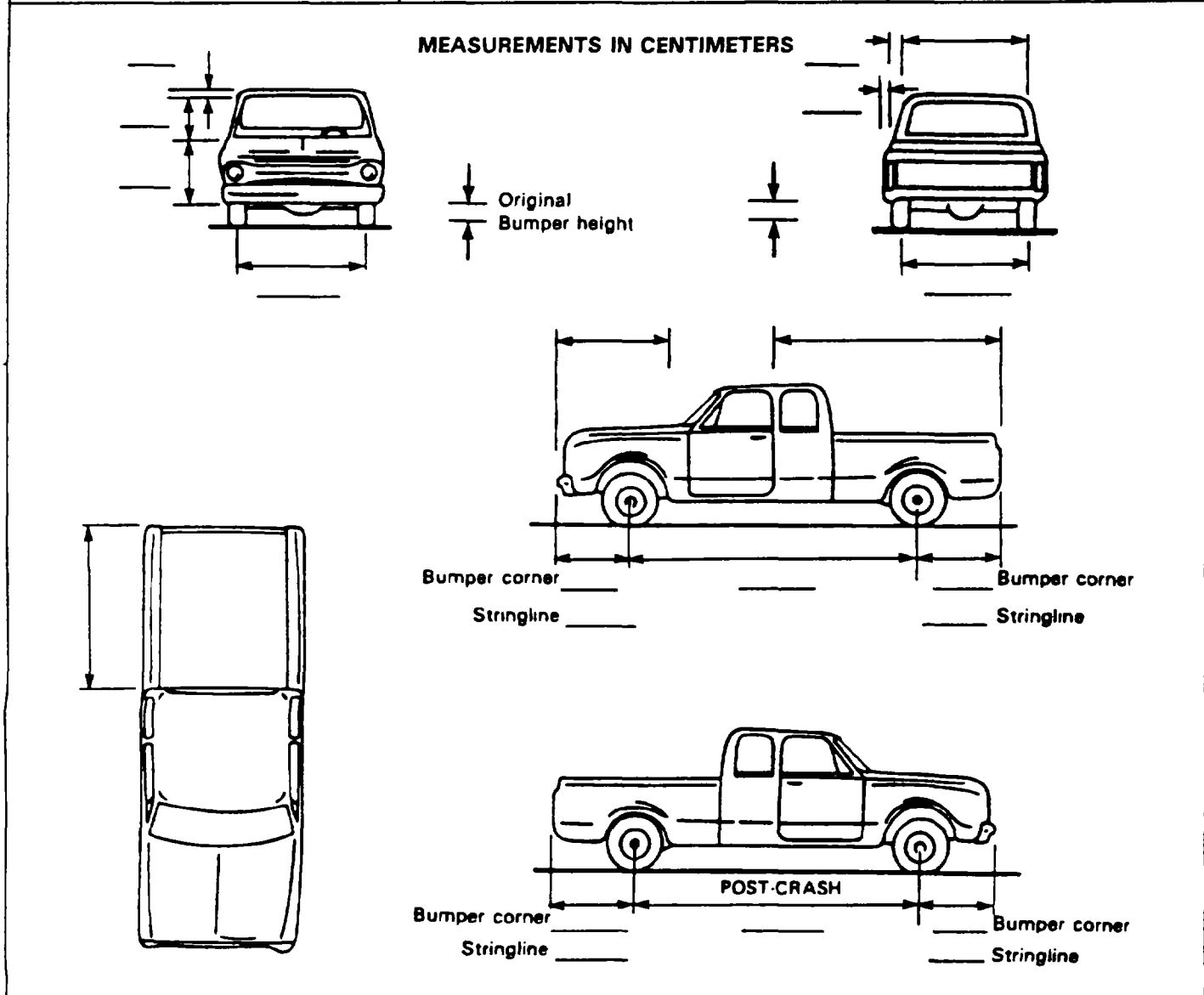

NOTES Sketch new perimeter and cross hatch direct damage and single hatch induced damage on all views. Annotate observations which might be useful in reconstructing the accident (e.g., grass in tire bead, direction of striations, scuff on sidewalls, etc.). If pulling trailer, sketch type of trailer and damage received on the back of this page.

Annotate any damage caused by extrication such as component removal by torching, prying, or hydraulic shears.

VEHICLE DAMAGE SKETCH

<p>TIRE - WHEEL DAMAGE</p> <p>a. Rotation physically restricted</p> <p>RF _____ LF _____ RR _____ LR _____</p> <p>b. Tire deflated</p> <p>RF _____ LF _____ RR _____ LR _____</p> <p>(1) Yes (2) No (8) NA (9) Unk.</p>	<p>ORIGINAL SPECIFICATIONS</p> <p>Wheelbase _____ cm</p> <p>Overall Length _____ cm</p> <p>Maximum Width _____ cm</p> <p>Curb Weight _____ kg</p> <p>Average Track _____ cm</p> <p>Front Overhang _____ cm</p> <p>Rear Overhang _____ cm</p> <p>Undeformed End Width _____ cm</p> <p>Engine Size: cyl./displ. _____ L</p>	<p>WHEEL STEER ANGLES (For locked front wheels or displaced rear axles only)</p> <p>RF ± _____ ° LF ± _____ ° RR ± _____ ° LR ± _____ °</p> <p>Within ± 5 degrees</p>
<p>TYPE OF TRANSMISSION</p> <p><input type="checkbox"/> Manual <input type="checkbox"/> Automatic</p>	<p>DRIVE WHEELS</p> <p><input type="checkbox"/> FWD <input type="checkbox"/> RWD <input type="checkbox"/> 4WD</p> <p>Approximate Cargo Weight _____ kg</p>	

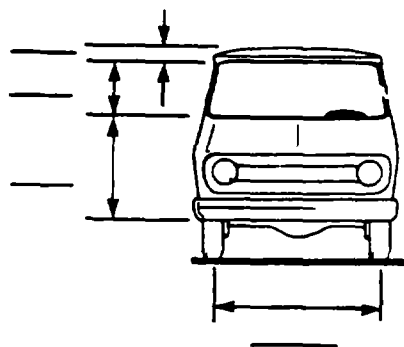

MEASUREMENTS IN CENTIMETERS

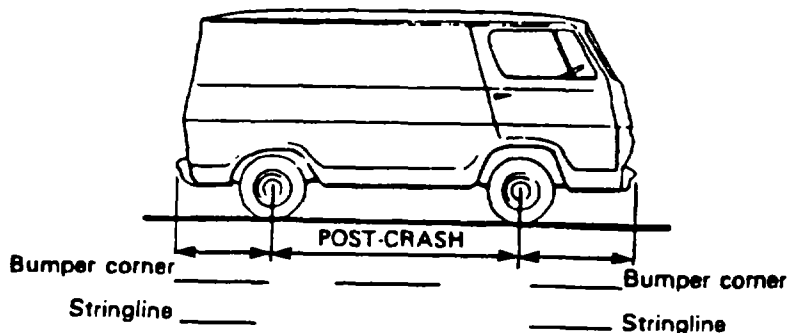
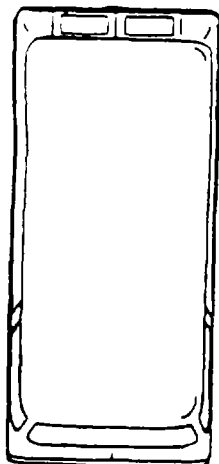
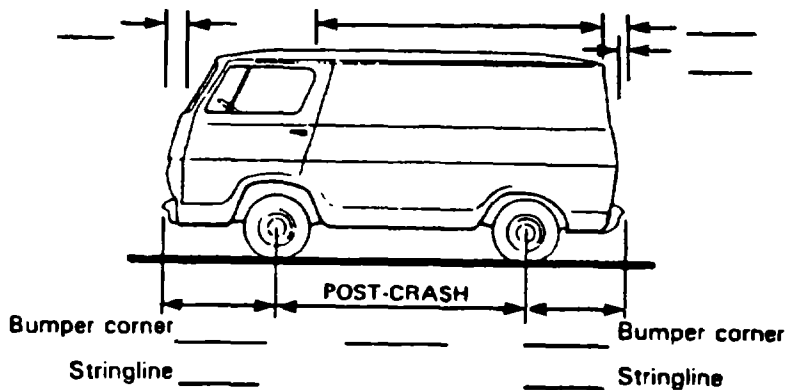
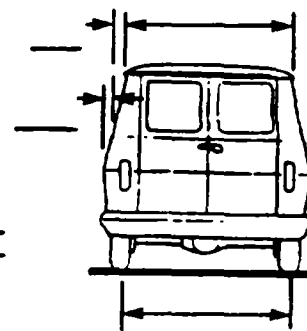

NOTES Sketch new penmeter and cross hatch direct damage and single hatch induced damage on all views. Annotate observations which might be useful in reconstructing the accident (e.g., grass in tire bead, direction of striations, scuff on sidewalls, etc.) If pulling trailer, sketch type of trailer and damage received on the back of this page. Annotate any damage caused by extrication such as component removal by torching, prying, or hydraulic shears.

VEHICLE DAMAGE SKETCH

<p>TIRE—WHEEL DAMAGE</p> <p>a. Rotation physically restricted b. Tire deflated</p> <p>RF _____ RF _____ LF _____ LF _____ RR _____ RR _____ LR _____ LR _____</p> <p>(1) Yes (2) No (8) NA (9) Unk.</p>	<p>ORIGINAL SPECIFICATIONS</p> <p>Wheelbase _____ cm Overall Length _____ cm Maximum Width _____ cm Curb Weight _____ kg Average Track _____ cm Front Overhang _____ cm Rear Overhang _____ cm Undeformed End Width _____ cm Engine Size: cyl./displ. _____ L</p>	<p>WHEEL STEER ANGLES (For locked front wheels or displaced rear axles only)</p> <p>RF ± _____ ° LF ± _____ ° RR ± _____ ° LR ± _____ °</p> <p>Within ± 5 degrees</p>
<p>TYPE OF TRANSMISSION</p> <p><input type="checkbox"/> Manual <input type="checkbox"/> Automatic</p>	<p>DRIVE WHEELS</p> <p><input type="checkbox"/> FWD <input type="checkbox"/> RWD <input type="checkbox"/> 4WD</p>	
		<p>Approximate Cargo Weight _____ kg</p>

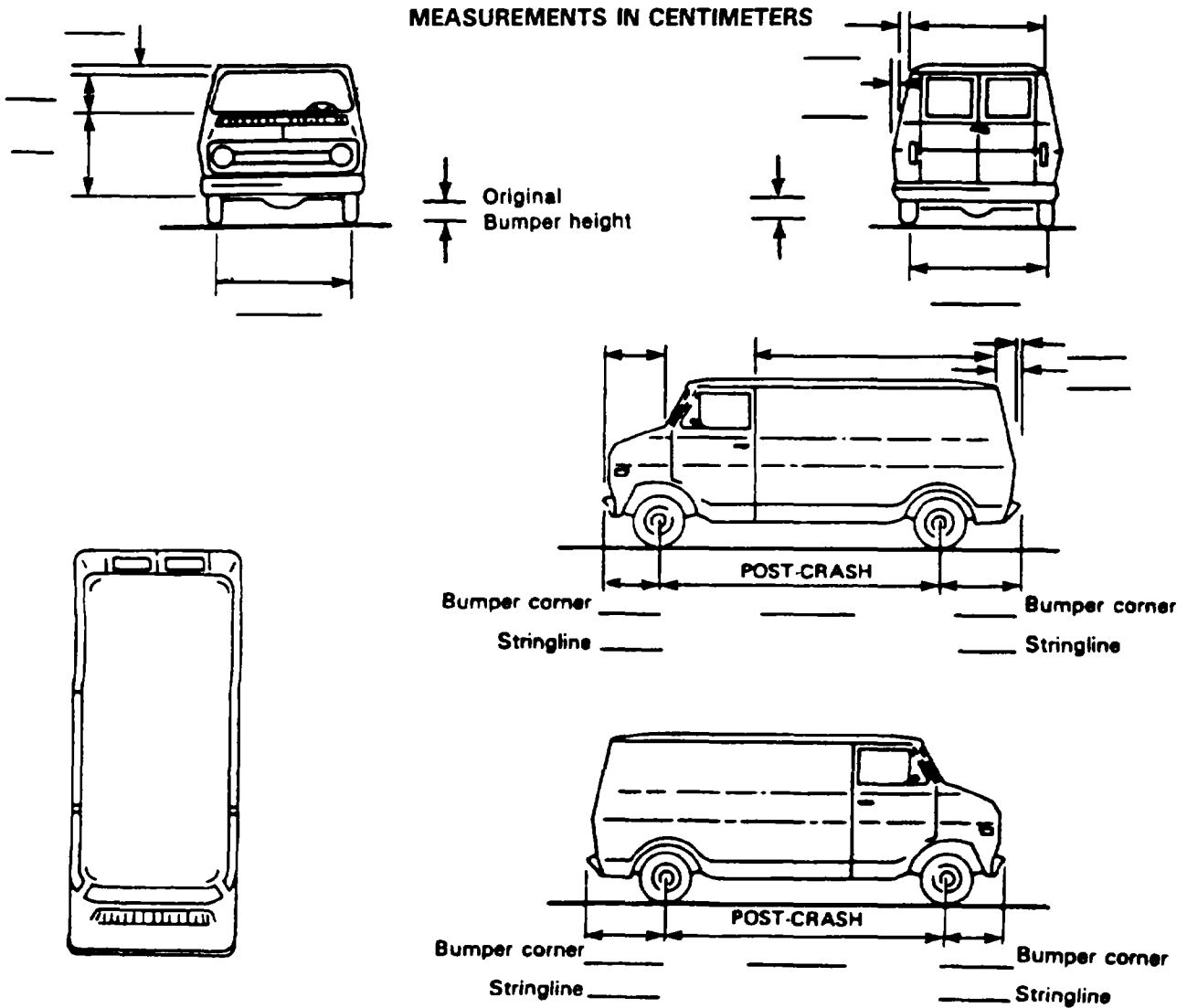

NOTES Sketch new perimeter and cross hatch direct damage and single hatch induced damage on all views. Annotate observations which might be useful in reconstructing the accident (e.g., grass in tire bead, direction of striations, scuff on sidewalls, etc.). If pulling trailer, sketch type of trailer and damage received on the back of this page.

Annotate any damage caused by extrication such as component removal by torching, prying, or hydraulic shears.

VEHICLE DAMAGE SKETCH

<p>TIRE—WHEEL DAMAGE</p> <p>a. Rotation physically restricted _____</p> <p>b. Tire deflated _____</p> <p>RF _____ LF _____ RR _____ LR _____</p> <p>RF _____ LF _____ RR _____ LR _____</p> <p>(1) Yes (2) No (8) NA (9) Unk.</p>	<p>ORIGINAL SPECIFICATIONS</p> <p>Wheelbase _____ cm</p> <p>Overall Length _____ cm</p> <p>Maximum Width _____ cm</p> <p>Curb Weight _____ kg</p> <p>Average Track _____ cm</p> <p>Front Overhang _____ cm</p> <p>Rear Overhang _____ cm</p> <p>Undeformed End Width _____ cm</p> <p>Engine Size: cyl./displ. _____ L</p>	<p>WHEEL STEER ANGLES (For locked front wheels or displaced rear axles only)</p> <p>RF ± _____ °</p> <p>LF ± _____ °</p> <p>RR ± _____ °</p> <p>LR ± _____ °</p> <p>Within ± 5 degrees</p>
<p>TYPE OF TRANSMISSION</p> <p><input type="checkbox"/> Manual <input type="checkbox"/> Automatic</p>	<p>DRIVE WHEELS</p> <p><input type="checkbox"/> FWD <input type="checkbox"/> RWD <input type="checkbox"/> 4WD</p>	
		<p>Approximate Cargo Weight _____ kg</p>

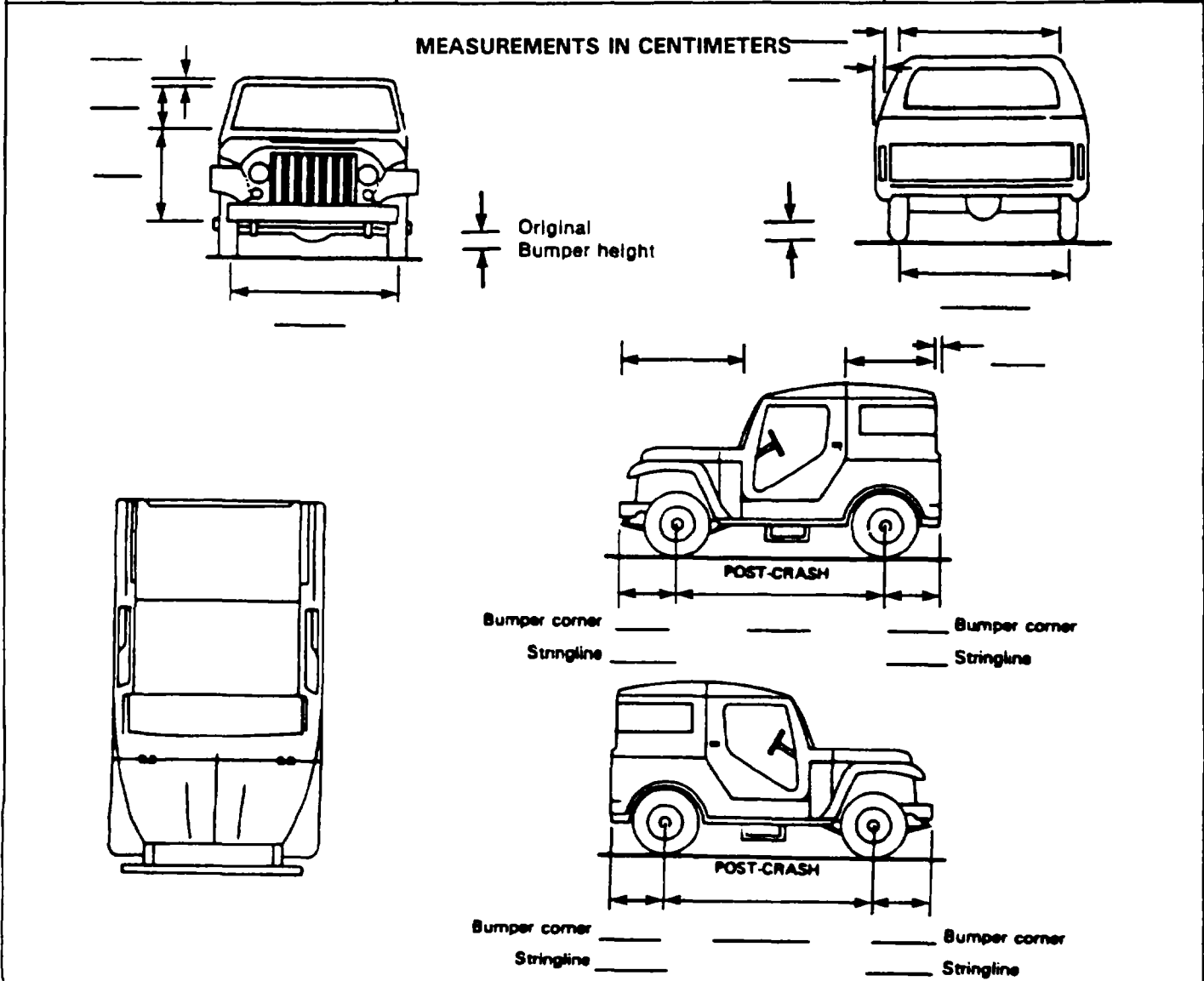

NOTES Sketch new penmeter and cross hatch direct damage and single hatch induced damage on all views. Annotate observations which might be useful in reconstructing the accident (e.g., grass in tire bead, direction of striations, scuff on sidewalls, etc.). If pulling trailer, sketch type of trailer and damage received on the back of this page.

Annotate any damage caused by extrication such as component removal by torching, prying, or hydraulic shears.

VEHICLE DAMAGE SKETCH

<p>TIRE—WHEEL DAMAGE</p> <p>a. Rotation physically restricted _____</p> <p>b. Tire deflated _____</p> <p>RF _____ LF _____ RR _____ LR _____</p> <p>RF _____ LF _____ RR _____ LR _____</p> <p>(1) Yes (2) No (8) NA (9) Unk.</p>	<p>ORIGINAL SPECIFICATIONS</p> <p>Wheelbase _____ cm</p> <p>Overall Length _____ cm</p> <p>Maximum Width _____ cm</p> <p>Curb Weight _____ kg</p> <p>Average Track _____ cm</p> <p>Front Overhang _____ cm</p> <p>Rear Overhang _____ cm</p> <p>Undeformed End Width _____ cm</p> <p>Engine Size: cyl./displ. _____ L</p>	<p>WHEEL STEER ANGLES (For locked front wheels or displaced rear axles only)</p> <p>RF ± _____ °</p> <p>LF ± _____ °</p> <p>RR ± _____ °</p> <p>LR ± _____ °</p> <p>Within ± 5 degrees</p>
<p>TYPE OF TRANSMISSION</p> <p><input type="checkbox"/> Manual <input type="checkbox"/> Automatic</p>	<p>DRIVE WHEELS</p> <p><input type="checkbox"/> FWD <input type="checkbox"/> RWD <input type="checkbox"/> 4WD</p>	
		<p>Approximate Cargo Weight _____ kg</p>

MEASUREMENTS IN CENTIMETERS

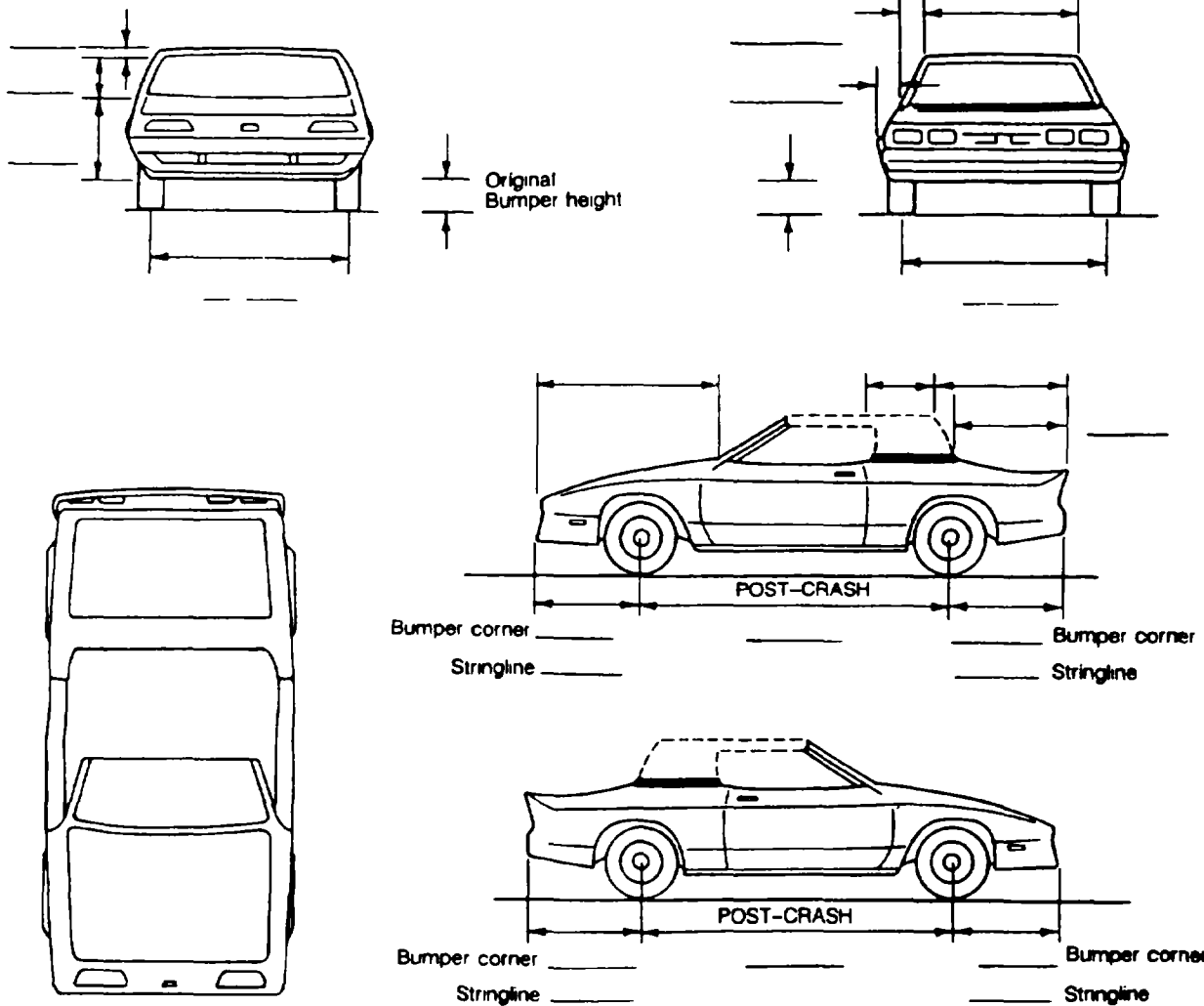

NOTES Sketch new penmeter and cross hatch direct damage and single hatch induced damage on all views. Annotate observations which might be useful in reconstructing the accident (e.g., grass in tire bead, direction of striations, scuff on sidewalls, etc.). If pulling trailer, sketch type of trailer and damage received on the back of this page.

Annotate any damage caused by extrication such as component removal by torching, prying, or hydraulic shears.

VEHICLE DAMAGE SKETCH

<p>TIRE—WHEEL DAMAGE</p> <p>a. Rotation physically restricted b. Tire deflated</p> <p>RF _____ RF _____ LF _____ LF _____ RR _____ RR _____ LR _____ LR _____</p> <p>(1) Yes (2) No (8) NA (9) Unk.</p>	<p>ORIGINAL SPECIFICATIONS</p> <p>Wheelbase _____ cm Overall Length _____ cm Maximum Width _____ cm Curb Weight _____ kg Average Track _____ cm Front Overhang _____ cm Rear Overhang _____ cm Undeformed End Width _____ cm Engine Size: cyl./displ. _____ L</p>	<p>WHEEL STEER ANGLES (For locked front wheels or displaced rear axles only)</p> <p>RF ± _____ ° LF ± _____ ° RR ± _____ ° LR ± _____ °</p> <p>Within ± 5 degrees</p>
<p>TYPE OF TRANSMISSION</p> <p><input type="checkbox"/> Manual <input type="checkbox"/> Automatic</p>	<p>DRIVE WHEELS</p> <p><input type="checkbox"/> FWD <input type="checkbox"/> RWD <input type="checkbox"/> 4WD</p> <p>Approximate Cargo Weight _____ kg</p>	

MEASUREMENTS IN CENTIMETERS

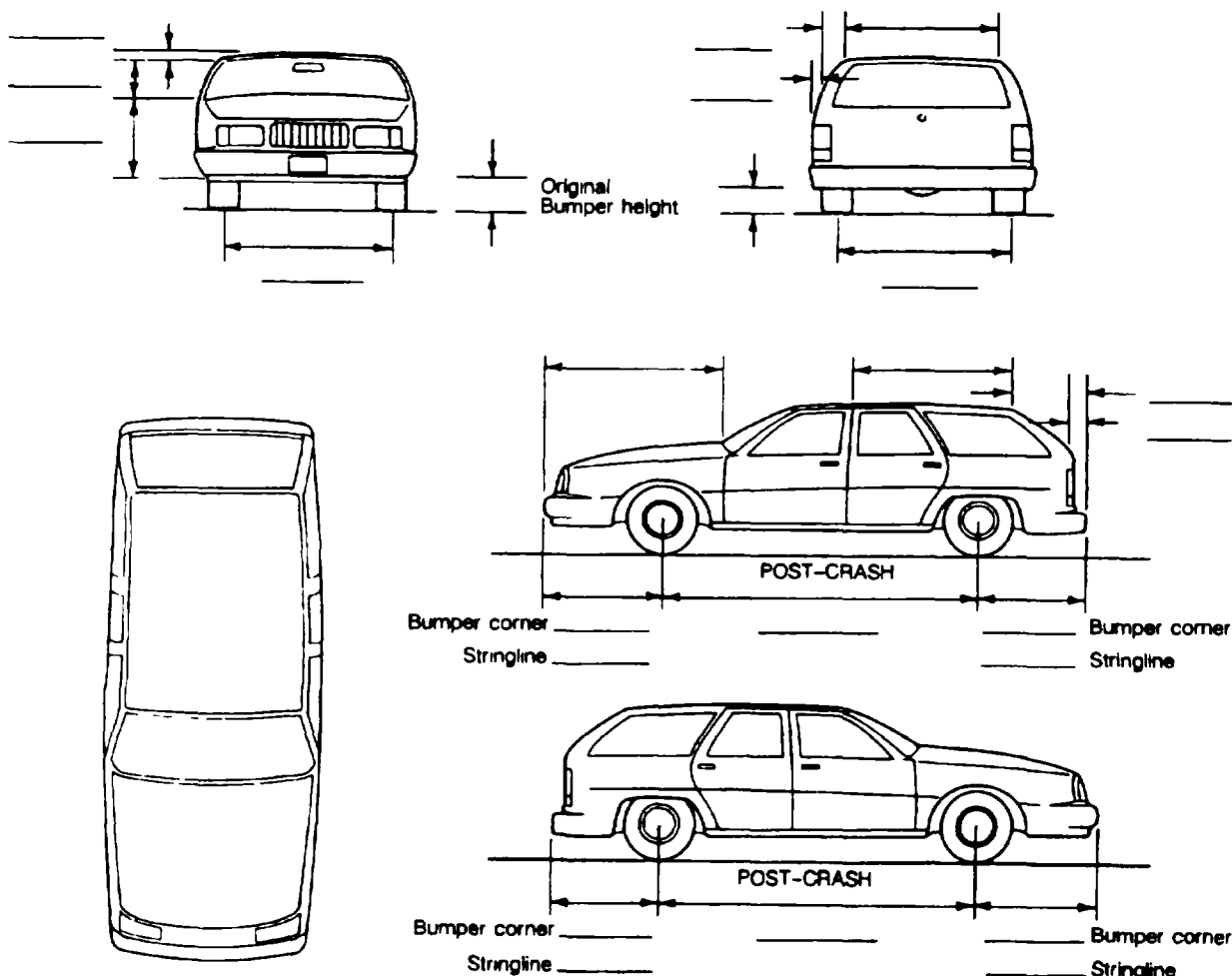

NOTES Sketch new perimeter and cross hatch direct damage and single hatch induced damage on all views. Annotate observations which might be useful in reconstructing the accident (e.g., grass in tire bead, direction of striations, scuff on sidewalls, etc.) If pulling trailer, sketch type of trailer and damage received on the back of this page.

Annotate any damage caused by extraction such as component removal by torching, prying, or hydraulic shears.

VEHICLE DAMAGE SKETCH

<p>TIRE - WHEEL DAMAGE</p> <p>a. Rotation physically restricted _____</p> <p>b. Tire deflated _____</p> <p>RF _____ LF _____ RR _____ LR _____</p> <p>RF _____ LF _____ RR _____ LR _____</p> <p>(1) Yes (2) No (8) NA (9) Unk.</p>	<p>ORIGINAL SPECIFICATIONS</p> <p>Wheelbase _____ cm</p> <p>Overall Length _____ cm</p> <p>Maximum Width _____ cm</p> <p>Curb Weight _____ kg</p> <p>Average Track _____ cm</p> <p>Front Overhang _____ cm</p> <p>Rear Overhang _____ cm</p> <p>Undeformed End Width _____ cm</p> <p>Engine Size: cyl./displ. _____ L</p>	<p>WHEEL STEER ANGLES (For locked front wheels or displaced rear axles only)</p> <p>RF ± _____ °</p> <p>LF ± _____ °</p> <p>RR ± _____ °</p> <p>LR ± _____ °</p> <p>Within ± 5 degrees</p>
<p>TYPE OF TRANSMISSION</p> <p><input type="checkbox"/> Manual <input type="checkbox"/> Automatic</p>	<p>DRIVE WHEELS</p> <p><input type="checkbox"/> FWD <input type="checkbox"/> RWD <input type="checkbox"/> 4WD</p> <p>Approximate Cargo Weight _____ kg</p>	

MEASUREMENTS IN CENTIMETERS

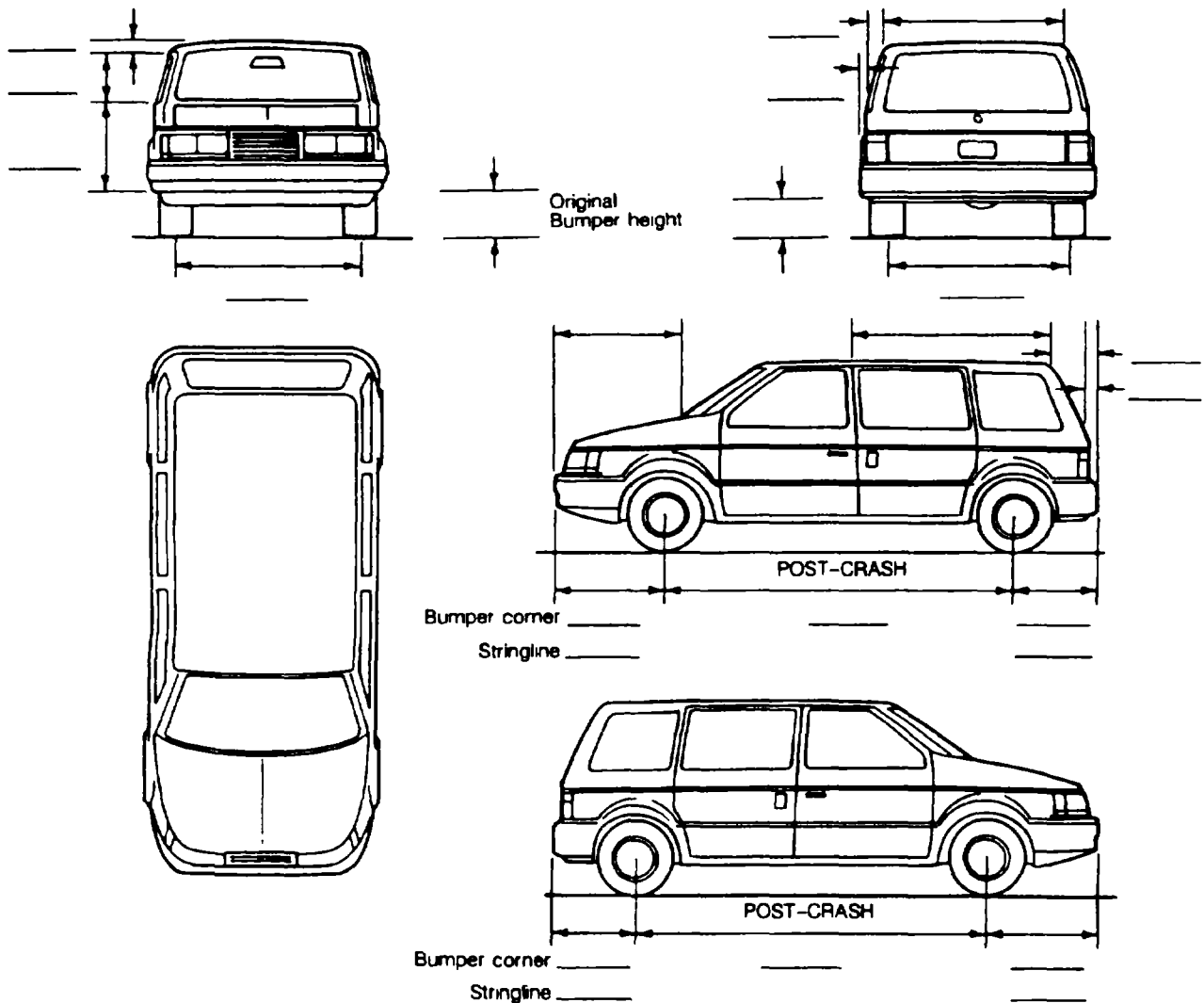

NOTES Sketch new perimeter and cross hatch direct damage and single hatch induced damage on all views. Annotate observations which might be useful in reconstructing the accident (e.g., grass in tire bead, direction of striations, scuff on sidewalls, etc.) If pulling trailer, sketch type of trailer and damage received on the back of this page.

Annotate any damage caused by extrication such as component removal by torching, prying, or hydraulic shears.

VEHICLE DAMAGE SKETCH

<p>TIRE—WHEEL DAMAGE</p> <p>a. Rotation physically restricted _____</p> <p>b. Tire deflated _____</p> <p>RF _____ RF _____</p> <p>LF _____ LF _____</p> <p>RR _____ RR _____</p> <p>LR _____ LR _____</p> <p>(1) Yes (2) No (8) NA (9) Unk.</p>	<p>ORIGINAL SPECIFICATIONS</p> <p>Wheelbase _____ cm</p> <p>Overall Length _____ cm</p> <p>Maximum Width _____ cm</p> <p>Curb Weight _____ kg</p> <p>Average Track _____ cm</p> <p>Front Overhang _____ cm</p> <p>Rear Overhang _____ cm</p> <p>Undeformed End Width _____ cm</p> <p>Engine Size: cyl./displ. _____ L</p>	<p>WHEEL STEER ANGLES (For locked front wheels or displaced rear axles only)</p> <p>RF ± _____ °</p> <p>LF ± _____ °</p> <p>RR ± _____ °</p> <p>LR ± _____ °</p> <p>Within ± 5 degrees</p>
<p>TYPE OF TRANSMISSION</p> <p><input type="checkbox"/> Manual <input type="checkbox"/> Automatic</p>	<p>DRIVE WHEELS</p> <p><input type="checkbox"/> FWD <input type="checkbox"/> RWD <input type="checkbox"/> 4WD</p> <p>Approximate Cargo Weight _____ kg</p>	

MEASUREMENTS IN CENTIMETERS

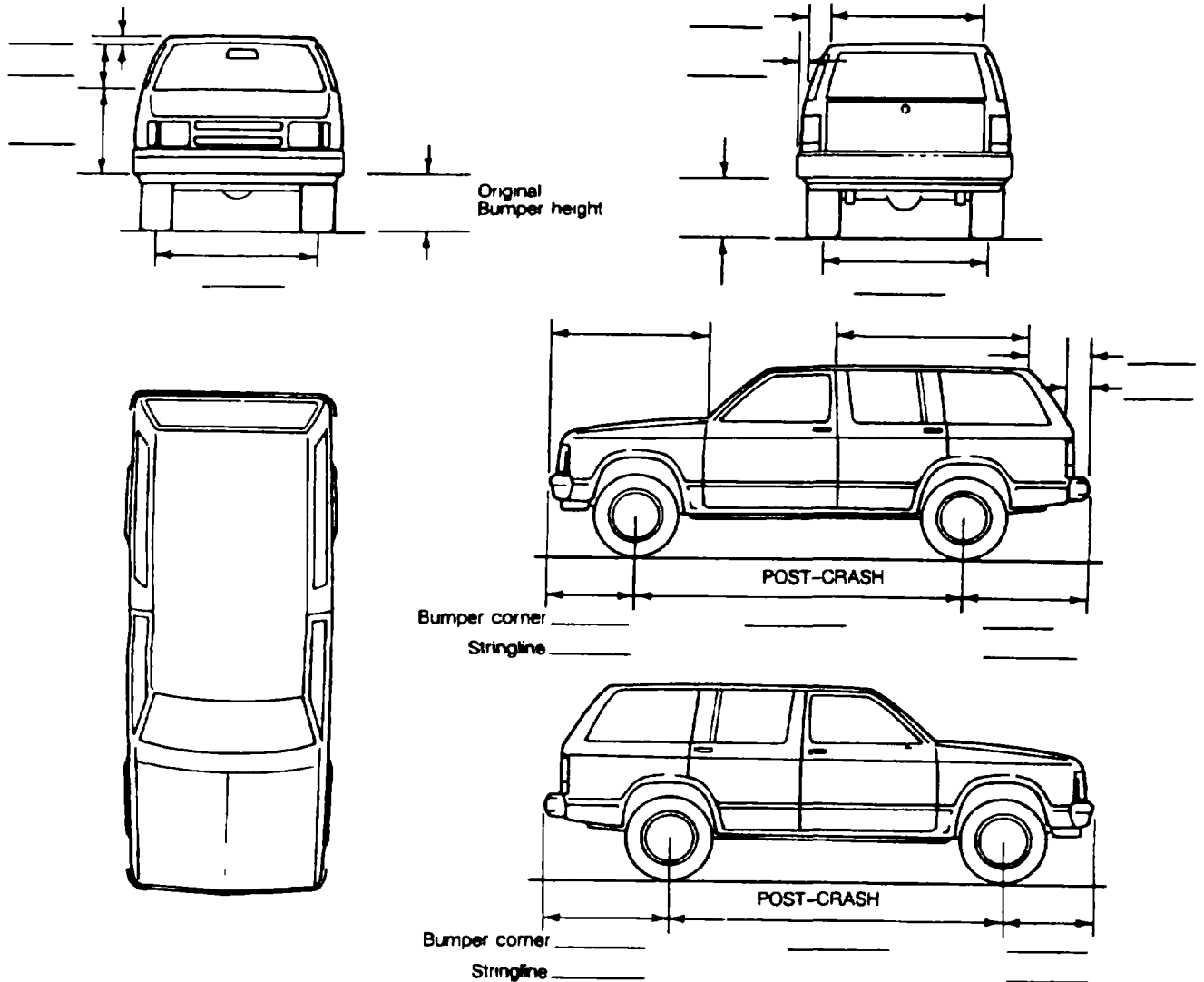

NOTES Sketch new perimeter and cross hatch direct damage and single hatch induced damage on all views. Annotate observations which might be useful in reconstructing the accident (e.g., grass in tire bead, direction of striations, scuff on sidewalls, etc.). If pulling trailer, sketch type of trailer and damage received on the back of this page.

Annotate any damage caused by extrication such as component removal by torching, prying, or hydraulic shears.

VEHICLE DAMAGE SKETCH

<p>TIRE—WHEEL DAMAGE</p> <p>a. Rotation physically restricted _____</p> <p>b. Tire deflated _____</p> <p>RF _____ LF _____ RR _____ LR _____</p> <p>RF _____ LF _____ RR _____ LR _____</p> <p>(1) Yes (2) No (8) NA (9) Unk.</p>	<p>ORIGINAL SPECIFICATIONS</p> <p>Wheelbase _____ cm</p> <p>Overall Length _____ cm</p> <p>Maximum Width _____ cm</p> <p>Curb Weight _____ kg</p> <p>Average Track _____ cm</p> <p>Front Overhang _____ cm</p> <p>Rear Overhang _____ cm</p> <p>Undeformed End Width _____ cm</p> <p>Engine Size: cyl./displ. _____ L</p>	<p>WHEEL STEER ANGLES (For locked front wheels or displaced rear axles only)</p> <p>RF ± _____ °</p> <p>LF ± _____ °</p> <p>RR ± _____ °</p> <p>LR ± _____ °</p> <p>Within ± 5 degrees</p> <hr/> <p>DRIVE WHEELS</p> <p><input type="checkbox"/> FWD <input type="checkbox"/> RWD <input type="checkbox"/> 4WD</p> <hr/> <p>Approximate Cargo Weight _____ kg</p>
<p>TYPE OF TRANSMISSION</p> <p><input type="checkbox"/> Manual <input type="checkbox"/> Automatic</p>		

MEASUREMENTS IN CENTIMETERS

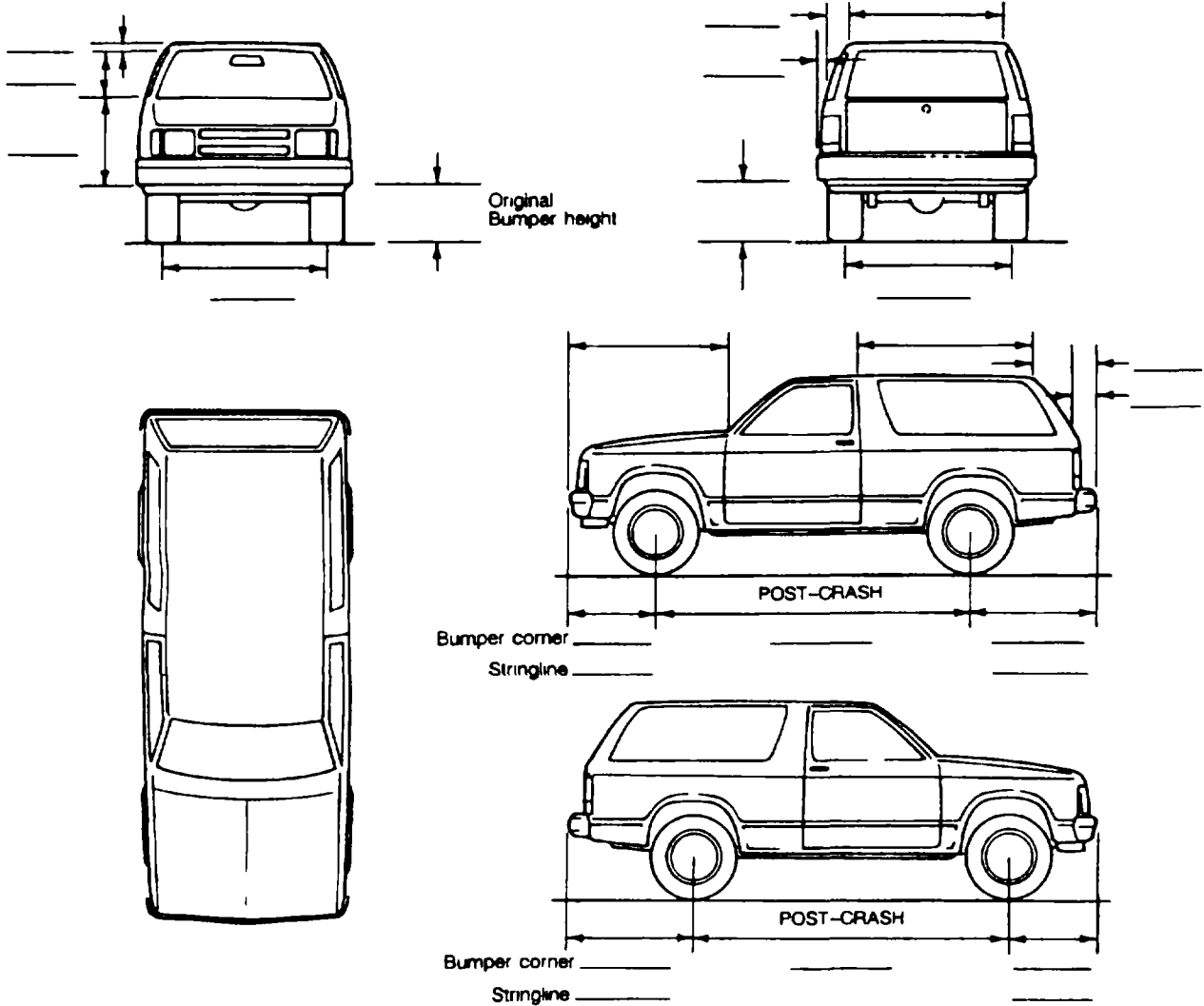

NOTES Sketch new perimeter and cross hatch direct damage and single hatch induced damage on all views. Annotate observations which might be useful in reconstructing the accident (e.g., grass in tire bead, direction of striations, scuff on sidewalls, etc.). If pulling trailer, sketch type of trailer and damage received on the back of this page.

Annotate any damage caused by extrication such as component removal by torching, prying, or hydraulic shears.

VEHICLE DAMAGE SKETCH

<p>TIRE - WHEEL DAMAGE</p> <p>a. Rotation physically restricted _____ b. Tire deflated _____</p> <p>RF _____ LF _____ RR _____ LR _____ RF _____ LF _____ RR _____ LR _____</p> <p>(1) Yes (2) No (8) NA (9) Unk.</p>	<p>ORIGINAL SPECIFICATIONS</p> <p>Wheelbase _____ cm Overall Length _____ cm Maximum Width _____ cm Curb Weight _____ kg Average Track _____ cm Front Overhang _____ cm Rear Overhang _____ cm Undeformed End Width _____ cm Engine Size: cyl./displ. _____ L</p>	<p>WHEEL STEER ANGLES (For locked front wheels or displaced rear axles only)</p> <p>RF ± _____ ° LF ± _____ ° RR ± _____ ° LR ± _____ ° Within ± 5 degrees</p>
<p>TYPE OF TRANSMISSION</p> <p><input type="checkbox"/> Manual <input type="checkbox"/> Automatic</p>	<p>DRIVE WHEELS</p> <p><input type="checkbox"/> FWD <input type="checkbox"/> RWD <input type="checkbox"/> 4WD</p> <p>Approximate Cargo Weight _____ kg</p>	

MEASUREMENTS IN CENTIMETERS

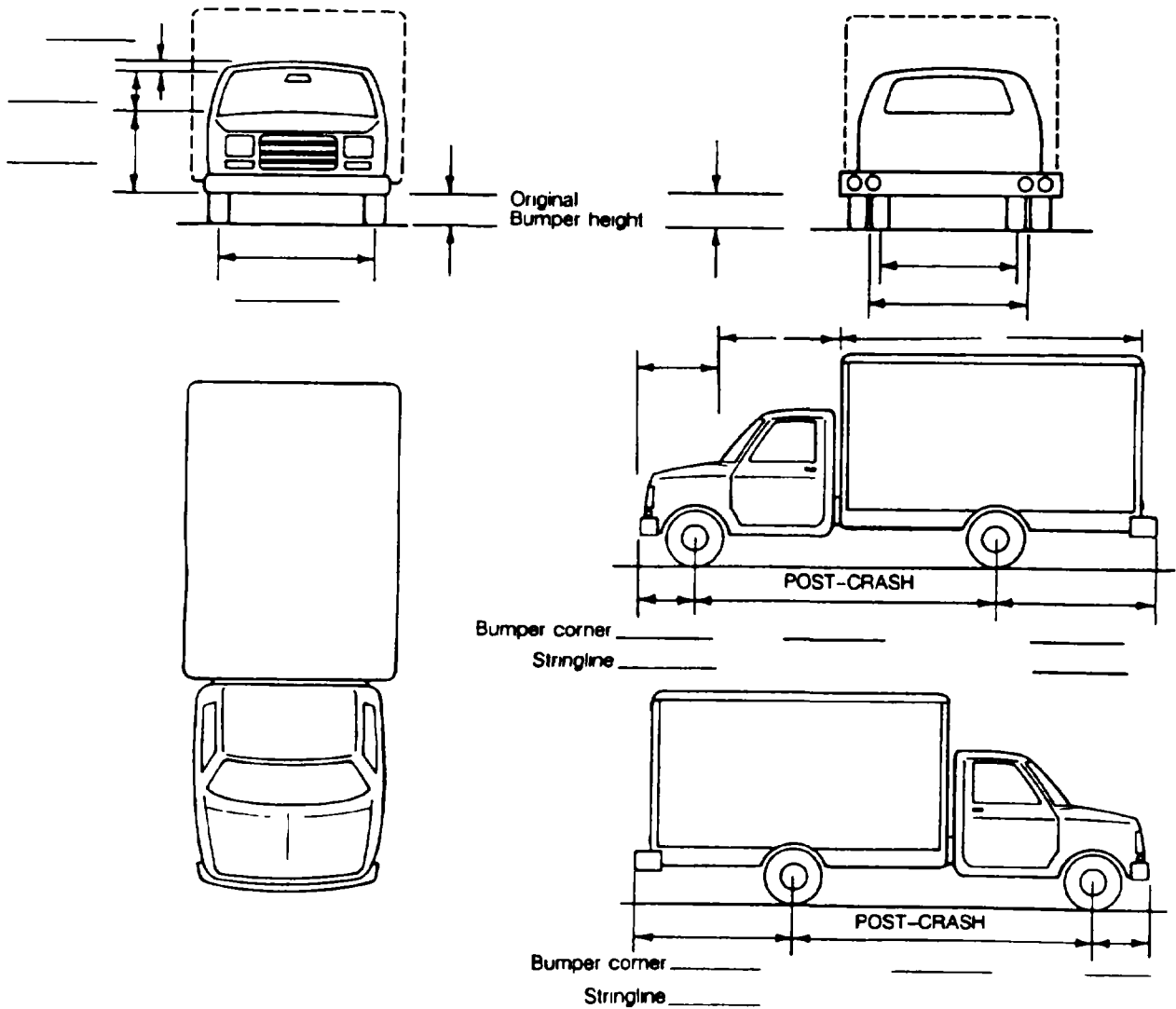

NOTES Sketch new perimeter and cross hatch direct damage and single hatch induced damage on all views. Annotate observations which might be useful in reconstructing the accident (e.g., grass in tire bead, direction of striations, scuff on sidewalls, etc.). If pulling trailer, sketch type of trailer and damage received on the back of this page.

Annotate any damage caused by extrication such as component removal by torching, prying, or hydraulic shears.

VEHICLE DAMAGE SKETCH

<p>TIRE - WHEEL DAMAGE</p> <p>a. Rotation physically restricted</p> <p>RF _____ LF _____ RR _____ LR _____</p> <p>b. Tire deflated</p> <p>RF _____ LF _____ RR _____ LR _____</p> <p>(1) Yes (2) No (8) NA (9) Unk.</p>	<p>ORIGINAL SPECIFICATIONS</p> <p>Wheelbase _____ cm</p> <p>Overall Length _____ cm</p> <p>Maximum Width _____ cm</p> <p>Curb Weight _____ kg</p> <p>Average Track _____ cm</p> <p>Front Overhang _____ cm</p> <p>Rear Overhang _____ cm</p> <p>Undeformed End Width _____ cm</p> <p>Engine Size: cyl./displ. _____ L</p>	<p>WHEEL STEER ANGLES (For locked front wheels or displaced rear axles only)</p> <p>RF ± _____ ° LF ± _____ ° RR ± _____ ° LR ± _____ °</p> <p>Within ± 5 degrees</p> <hr/> <p>DRIVE WHEELS</p> <p><input type="checkbox"/> FWD <input type="checkbox"/> RWD <input type="checkbox"/> 4WD</p> <hr/> <p>Approximate Cargo Weight _____ kg</p>
<p>TYPE OF TRANSMISSION</p> <p><input type="checkbox"/> Manual <input type="checkbox"/> Automatic</p>		

MEASUREMENTS IN CENTIMETERS

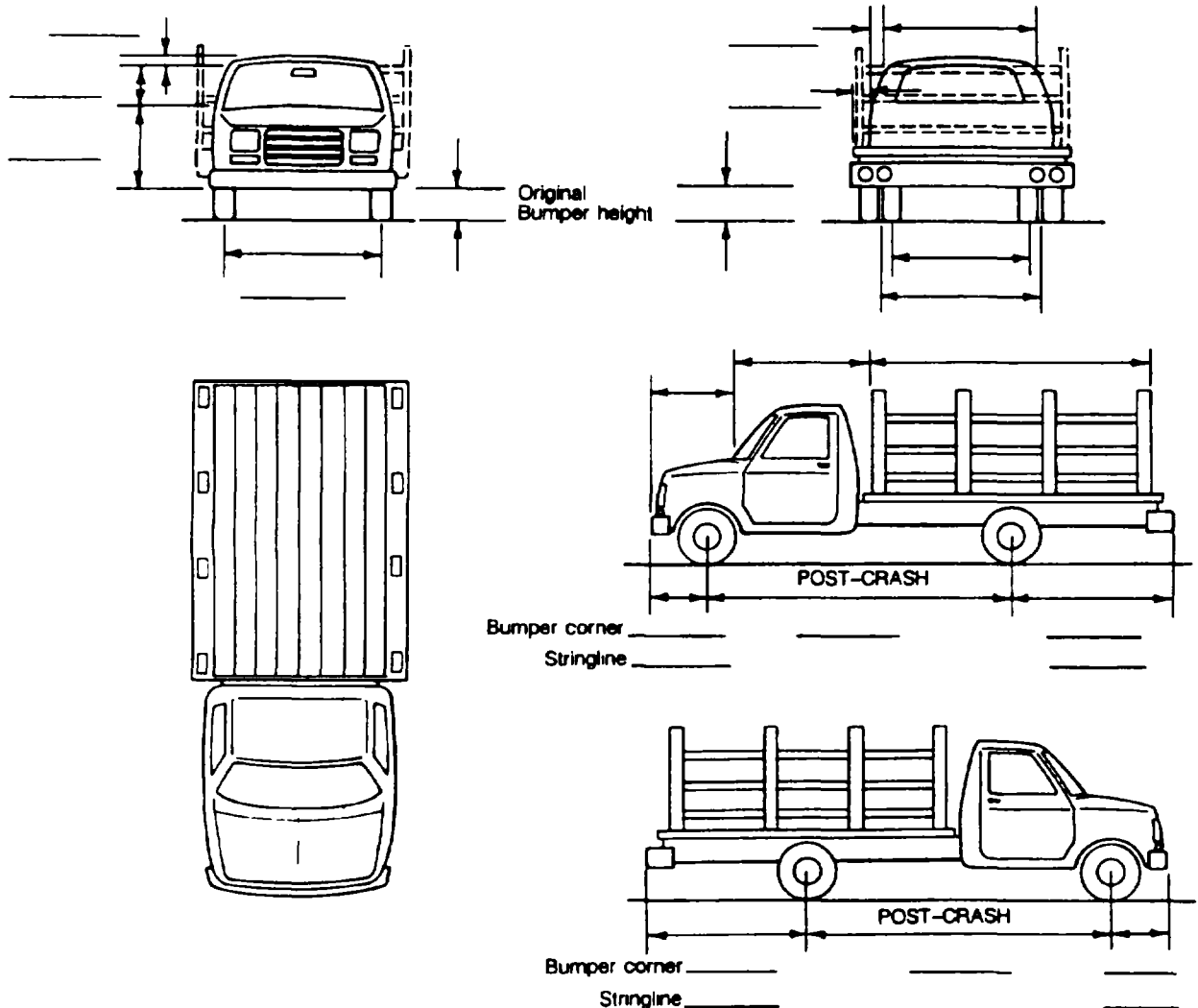

NOTES Sketch new perimeter and cross hatch direct damage and single hatch induced damage on all views. Annotate observations which might be useful in reconstructing the accident (e.g., grass in tire bead, direction of striations, scuff on sidewalls, etc.). If pulling trailer, sketch type of trailer and damage received on the back of this page.

Annotate any damage caused by extrication such as component removal by torching, prying, or hydraulic shears.

INSTRUCTIONS FOR COMPLETION OF CDS APPLICABLE FIELD MEASUREMENTS PAGE
(Note: All Measurements Are In Metric Dimensions)

The first page of the Exterior Vehicle Form is designed to be a comprehensive data collection tool arranged in a format to allow sufficient space for documenting vehicle damage profiles and associated relevant measurements. The established protocol for obtaining crush data is defined in the NASS Vehicle Measurement Techniques (July 1989). The procedures for recording that data in a format that will maintain system-wide consistency are included in the following remarks.

Side or End Damage

Undeformed end width is measured and recorded whenever a side or end plane is involved.

End shift at frame (CDC) is assessed to determine whether sufficient end shift or bowing exists to necessitate incrementing the direction of force. Remember, end shift of ten centimeters or more must be present on: both frame rails to allow for incrementation to the left or right, or at least one frame rail for vertical incrementation. If neither frame rail has end shift, this should be annotated on the form.

Locator

Locate end of damage with respect to the centerline or, for side impacts, to an undamaged axle. Spaces are provided to record the "Location of Direct Damage", "Location of Field L", and "Location of Maximum Crush" measurements with respect to the vehicle centerline or bumper corner for end impacts and an undamaged axle for side impacts. These required measurements are used to assist with CDC assignments (direct) and to determine the "D" dimension if not directly measured. The following examples include the data that are required.

Direct Damage:

- o begins 4 centimeters right of centerline (end plane), or
- o begins 48 centimeters rearward of the rear axle (side plane)

Field L:

- o Entire end plane involved, or
- o C₁ is 102 centimeters forward of the rear axle

Maximum Crush

- o located 15 centimeters left of centerline, or
- o located at C₃, 51 centimeters forward of the rear axle

These data are required for each impact. A space is provided to indicate the "Specific Impact Number". If there are more impacts than spaces, the data are listed on the back of the first page of the Exterior Vehicle Form.

Crush Profile

Several data elements are required to properly complete the crush profile data portion of the first page of the Exterior Vehicle Form. These data are grouped together as they are generally obtained during the vehicle inspection. Each column (or associated group of columns) is explained as below.

INSTRUCTIONS FOR COMPLETION OF CDS APPLICABLE FIELD MEASUREMENTS PAGE

Specific Impact Number contains the impact sequence number specific to this vehicle for which the data are being obtained.

Plane of C-Measurements contains the annotation of the plane at which the crush profile is documented (i.e., bumper, grille, sill, mid-door). This column is annotated "average" when used to indicate the resultant profile from an underride-type impact.

Direct Damage: Width contains the indication of the length of direct damage as measured on the vehicle.

Direct Damage: Max Crush contains the measured maximum crush for the profile being documented. Recall that maximum crush is determined after free space is subtracted. Indicate the free space at Max Crush in the space below the measurement. Use a third line to indicate the resultant maximum crush.

Field L contains the recorded Field L as obtained during the vehicle inspection. Recall that the Field L represents both direct and induced damage as measured along the reference line (shock cord). This measurement is used to locate the position of the C-measurements.

C1-C6 contains the recorded two, four, or six C-measurements (as appropriate) on the line for the crush profile being documented. On the line beneath, annotate the free space to be subtracted. A third line is used to record the resultant crush profile.

± D contains the recorded "D" dimension. The data obtained for the direct damage width is used to calculate "D"; indicate whether "D" is a positive or negative value.

If the spaces provided are not sufficient for the number of impacts which require documentation, include the additional data on the back of the first page of the Exterior Vehicle Form.

In the following example, a crush profile for a frontal bumper underride impact is displayed. This example is used as a guideline when completing the first page of the Exterior Vehicle Form.

INSTRUCTIONS FOR COMPLETION OF CDS APPLICABLE FIELD MEASUREMENTS PAGE

Specific Impact Number	Plane of C-Measurements	Direct Damage		Field L	C ₁	C ₂	C ₃	C ₄	C ₅	C ₆	=D
		Width (CDC)	Max Crush								
1	GRILLE	48	74	137	74	53	36	28	18	15	0
	-FREESPACE		15		15	11	10	10	11	15	
	RESULTANT		58		58	42	25	18	6	0	0
1	BUMPER	48	23	142	23	15	11	5	5	3	0
	-FREESPACE		5		5	3	1	1	3	5	
	RESULTANT		18		18	13	10	4	3	0	0
①	AVERAGE	48	38	142	38	27	18	11	3	0	0

INSTRUCTIONS FOR COMPLETION OF VEHICLE DAMAGE SKETCH

Exterior Vehicle Form Page 2 (and associated Pages 2B-2I) enables researchers to report data that are not encoded and might otherwise be omitted from the case. Pertinent data such as scrapes, scratches, buckling, paint transfers, and other indications of engagement or relative motion are reported on this page. In addition, sketch the vehicle damage profile on the outlines provided, using the established protocol as below.

- Outline the damage profile produced by the impact.
- Use cross hatches to indicate direct damage.
- Highlight induced damage and/or remote buckling with diagonal lines.

The following sketch exemplifies these procedures on the overhead profile.

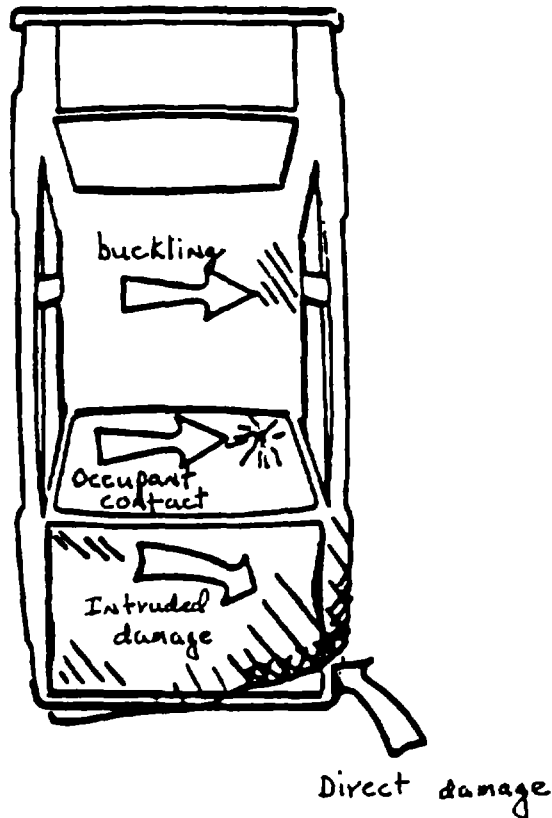

INSTRUCTIONS FOR COMPLETION OF VEHICLE DAMAGE SKETCH

Although researchers are reporting a vehicle's accident related damage, other damage may be observed which existed prior to the accident. These damaged areas, in addition to any towing related damage, are indicated and annotated accordingly.

Relevant measurements are required on the Vehicle Damage Sketch page in order to support other coded and noncoded data elements. Wheelbase and overhang measurements are necessary to provide relative measurements in support of documented crush profiles. Wheelbase and overhang are required from both sides of the vehicle for all vehicles inspected.

Extent zone measurements are also required; although, only the measurements which pertain to the damage plane are needed (i.e., hood length for frontal, side extents for side impacts, etc.). Obtain all measurements which may be needed when questions arise regarding the damaged plane. If doubt exists concerning whether an impact is to a frontal or a side plane, obtain both front and side extent zone measurements.

In addition, front and back pre-crash bumper height measurements must be obtained for vehicles sustaining any end plane impact with another vehicle (in-transport or not in-transport) [i.e., column (3) of CDC (including noncoded CDCs) must equal "F" or "B"].

- Measure from the bottom of the bumper face (reinforcement bar) to the ground.
- Include a calibrated instrument (contour gauge rod or 1 meter scale) in the photographs of the vehicle's bumper height.

The example below provides wheel base, overhang, and extent zone data for a frontal impact.

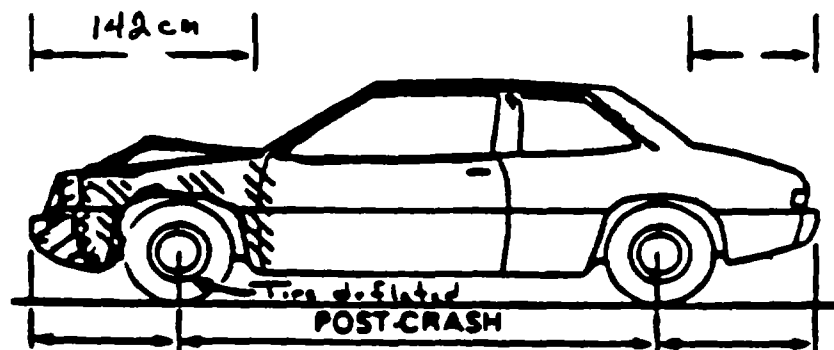

Bumper corner	[86 cm]	[251 cm]	[99 cm]	Bumper corner
Stringline	[100 cm]		[104 cm]	Stringline

Additional data required on the Vehicle Damage Sketch page includes.

- Original dimensions including: wheelbase, overall length, maximum width, curb weight, average track, and overhangs

INSTRUCTIONS FOR COMPLETION OF VEHICLE DAMAGE SKETCH

- o The engine displacement (i.e., 5.0 L) and number of cylinders (i.e., 4, 6, V6, or V8)
- o The transmission type: automatic or manual (3, 4, 5 speed, etc.)
- o The drive wheels: front wheel drive, rear wheel drive, or four wheel drive
- o Approximate cargo weight

Variable Name: 1st C.D.C. - Accident Event Sequence Number
2nd C.D.C. - Accident Event Sequence Number

Element Values:

Blank No event or not CDC applicable
01-98 Code the sequence number of the event selected for inclusion in the adjacent variables (i.e., Object Contacted, EV05 and EV13; and CDCs, EV06-EV11 and EV14-EV19).

Source: Primary sources are the scene and vehicle inspections; secondary sources include the police report and interviewee.

Remarks:

In accidents involving multiple events, the events are numbered in sequence by chronology in reference to the entire sequence. This total accident event sequence number is coded adjacent (EV04 or EV12) to the CDC that was produced during this event. For example, three cars are waiting at a red light. A pickup truck rear ends the third car in line and pushes it into the second car which in turn is pushed into the first car. The sequential event numbers in this accident would be as follows.









Event number 1 - pickup vs. 3rd car
Event number 2 - 3rd car vs. 2nd car
Event number 3 - 2nd car vs. 1st car

Do not forget that the numbers are actually encoded in accordance with CDC prioritization. Refer to the Overview section of the CDC Related Remarks (variables EV06-EV11, EV14-EV19 page 2) entitled "CDC Ranking" for comments on selecting the events to be encoded in the CDC variables.

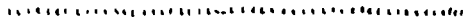
Code "Blank" (No event or not CDC applicable) is used when there is not an event or when an event exists but is not CDC applicable.

UNIFORM SYMBOLS FOR ACCIDENT DIAGRAMMING -- Continued

Scene Road Marking

	Point of impact
	Skidmarks
	Centripetal curve scuffs
	Tire scuff marks
	Rotating tire print
	Gouges
	Scratches
	Liquids (puddle and run-off)
	Debris (funnel out away from point of impact to show direction of force)

Any other accident-induced markings, components from vehicles, etc. should be shown in their approximate location and a reasonable likeness sketched on the diagram. However, do not clutter diagram; make an additional diagram, if necessary.

Variable Name: 1st C.D.C. - Object Contacted (cont'd.)
2nd C.D.C. - Object Contacted (cont'd.)

Code the appropriate object contacted for each event only if the event is CDC applicable. Events in which there is not a corresponding CDC (i.e., fire, explosion, other intraunit damage, or a noncollision injury), are identified on the Accident Form only. The object contacted codes are the same as those listed in the Accident Form under variable AC16, et.al., Vehicle Number or Object Contacted.

The coding priority of object contacted elements is based upon the highest and second highest delta V impacts. Refer to the overview of the "CDC Related Remarks" (EV06-EV11, EV14-EV19).

Code "Blank" (No event or not CDC applicable) is used when there is not an event or when an event exists but is not CDC applicable.

Noncollision events are accident circumstances which result in nonimpact related damage or harm.

Code "31" (Overturn - rollover) is used whenever a vehicle rolls over or overturns. This event is reported in the accident sequence variables on the Accident Form (AC12-AC18, AC19-AC25, etc.). It is assumed a rollover will generally involve contact with the road surface or ground. In this situation, the object contacted is encoded "31" (Overturn - rollover) and not code "61" (Ground). In the event another object in the environment is contacted during the rollover sequence, the rollover event is listed on the Accident Form, but may not be encoded in the CDC variables on the Exterior Vehicle Form (EV04-EV11, EV12-EV19), unless the rollover is applicable to CDC.

Code "32" (Fire or explosion) is not to be used on the Exterior Vehicle Form because no delta V is associated with a fire or explosion and the consequences are outside the scope of CDC. Therefore, this code is not used in variables EV06-EV11 or EV14-EV19, Collision Deformation Classification. If an impact causes a fire or explosion, then the impact is encoded as one event on the Accident Form in variables AC16, et al., Vehicle Number or Object Contacted, and on the Exterior Vehicle Form in variables EV06-EV11 or EV14-EV19, Collision Deformation Classification; whereas, the fire or explosion is encoded as another event only on the Accident Form.

Code "32" (Fire or explosion) is not to be used on the Exterior Vehicle Form.

Code "33" (Jackknife) is used whenever there is sufficient uncontrolled rotation (articulation) between a towing unit and a trailing unit such that they contact each other resulting in direct damage to the towing unit. Jackknife may occur to any vehicle which is pulling a trailing unit by a fixed linkage so long as the trailing unit and the pulling vehicle are capable of rotating (articulating) with respect to each other.

EXTERIOR VEHICLE FORM

E/05
E/13
(3)

Variable Name: 1st C.D.C. - Object Contacted (cont'd.)
2nd C.D.C. - Object Contacted (cont'd.)

Code "34" (Other intraunit damage) refers to situations where damage to the towing unit is caused by the trailing unit, but a jackknife did not occur. This event is outside the scope of the CDC and is not encoded in variables EV04-EV11 or EV14-EV19, Collision Deformation Classification.

Codes "34" (Other intraunit damage) and "35" (Noncollision injury) are not to be used on the Exterior Vehicle Form.

Code "35" (Noncollision injury) refers to situations where an occupant, of a vehicle not involved in an impact, sustains an injury. This includes "falling from vehicle". This event is outside the scope of CDC and is not encoded in variables EV04-EV19, Collision Deformation Classification.

| Code "38" (Other noncollision) is used only in consultation with the zone center. If this event is outside the scope of CDC, it is not encoded in variables EV04-EV19, Collision Deformation Classification.

Code "39" (Noncollision - details unknown) is used when it is known that the event was a noncollision but specifics are not known. If this event is outside the scope of CDC, it is not encoded in variables EV04-EV19, Collision Deformation Classification.

Codes "41" [Tree (\leq 10 centimeters in diameter)] and "42" [Tree ($>$ 10 centimeters in diameter)] refer to the diameter of the tree measured on the horizontal plane at the point of impact.

Code "43" (Shrubbery or bush) refers to vegetation which is usually of a woody multi-stemmed variety and in most instances is low growing rather than tall. Some common examples are boxwood, hawthorn, and mountain laurel.

Code "44" (Embankment) is used only when damage or injury results from impacting the embankment.

Codes "45" [Breakaway pole or post (any diameter)] and "50" through "53" (Pole or post ...) use the words "pole" and "post" in a general sense and include all types of supports for utility lines, light standards, post mounted mailboxes, warning devices, signs, and traffic control signals. Privately owned, as well as publicly owned, highway devices are included in these codes. They may be made of wood, metal, or concrete and may have various cross-sectional shapes and dimensions. The pole or post must be nontemporary (i.e., have a permanent base or be anchored in the ground). Fence posts are not included in these codes.

Variable Name: 1st C.D.C. - Object Contacted (cont'd.)
2nd C.D.C. - Object Contacted (cont'd.)

The following diagrams indicate the proper measurement for determining the "diameter" for use in coding pole/post attributes "45" [Breakaway pole or post (any diameter)] and "50" through "53" (Pole or post).

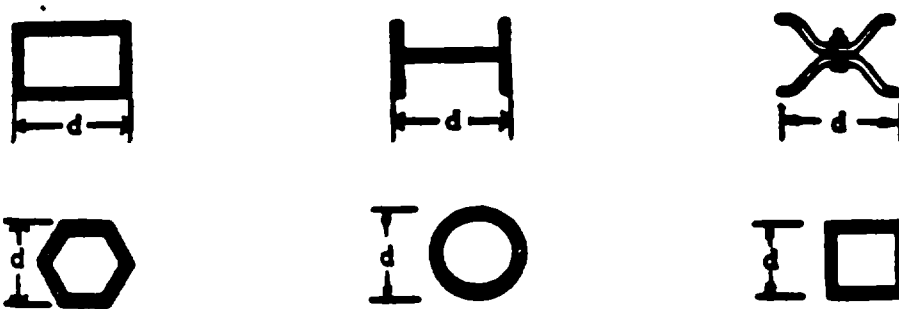

Code "45" [Breakaway pole or post (any diameter)] refers to a pole or post which is mounted on a base designed to readily disengage or fracture from an impacting vehicle above a predetermined force level. A pole or post fitted with such a device is a breakaway pole or post; otherwise, it is a nonbreakaway pole. Common types of breakaway bases are illustrated on the following pages.

Code "50" [Pole or post (≤ 10 centimeters in diameter)] refers to a pole or post whose diameter, when measured using the method shown above, is less than or equal to ten centimeters, and the pole or post is not mounted on a breakaway base.

Code "51" [Pole or post (> 10 but ≤ 30 centimeters in diameter)] refers to a pole or post which is not mounted on a breakaway base and whose diameter is within the range specified.

Code "52" [Pole or post (> 30 centimeters in diameter)] refers to poles or posts which are of the correct size and are not mounted on a breakaway base.

Code "53" (Pole, post - diameter unknown) is used for any pole or post, not on a breakaway base, of unknown diameter.

When a vehicle impacts a fixed object whose object contacted code is "41"- "43", "45", or "50"- "53" and causes the fixed object or any portion thereof to become dislodged or airborne such that the object or portion thereof subsequently falls on the vehicle, the appropriate object contacted code for the object in its dislodged or airborne state is the same as when the object was initially impacted (i.e., "41"- "43", "45", "50"- "53").

Variable Name: 1st C.D.C. - Object Contacted (cont'd.)
2nd C.D.C. - Object Contacted (cont'd.)

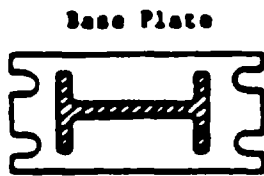
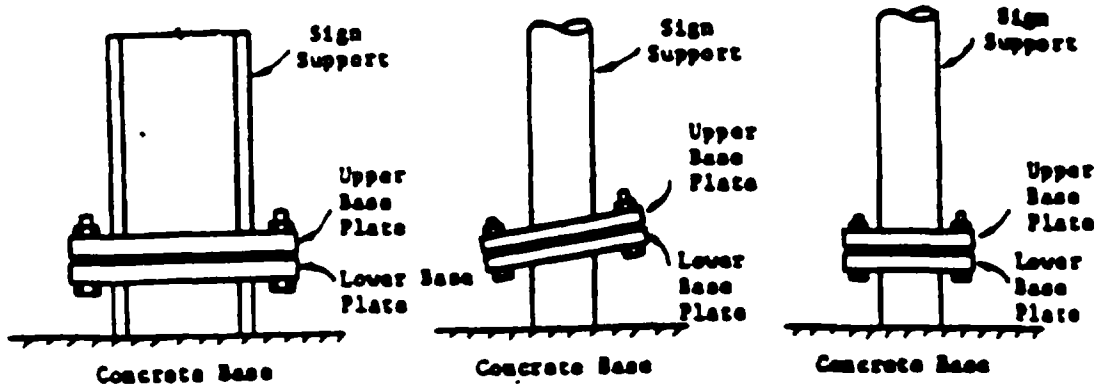

HORIZONTAL
SLIP BASE



INCLINED
SLIP BASE



TRIANGULAR
SLIP BASE

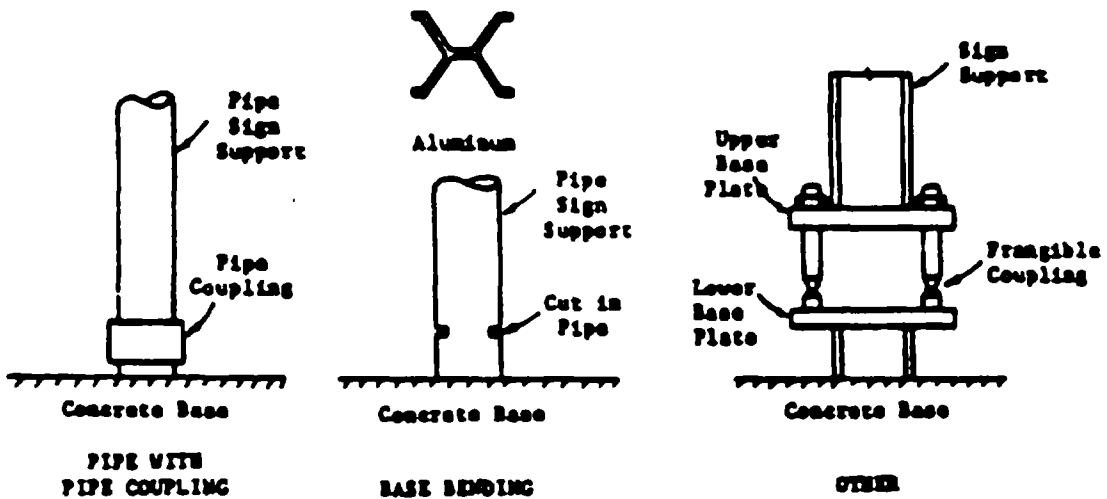

Variable Name: 1st C.D.C. - Object Contacted (cont'd.)
2nd C.D.C. - Object Contacted (cont'd.)

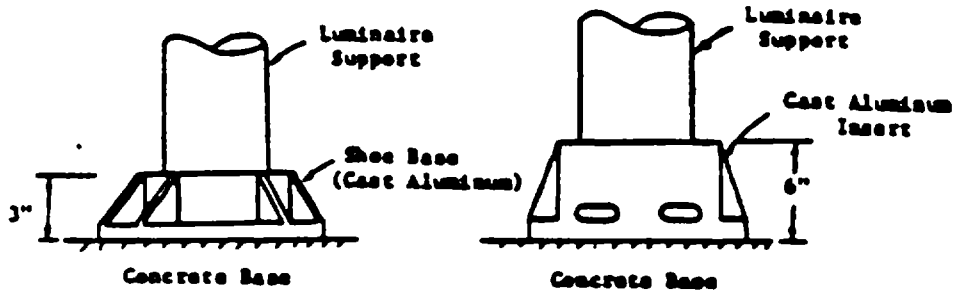

CAST ALUMINUM SHOE BASE/INSERT (FRANGIBLE)

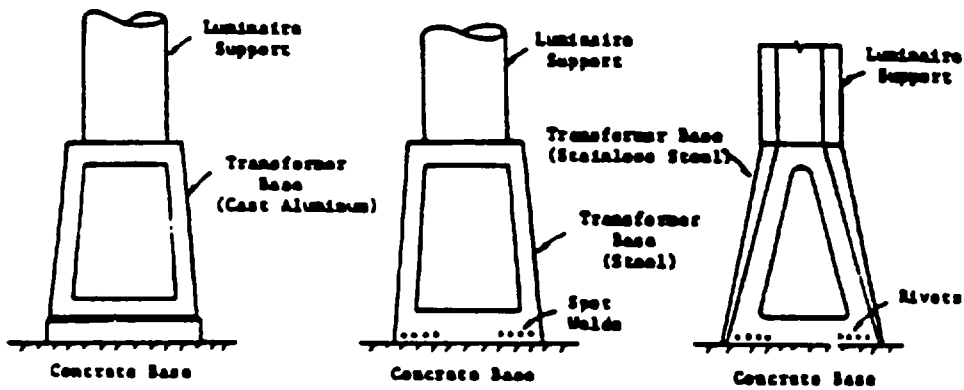

CAST ALUMINUM TRANSFORMER BASE (FRANGIBLE)

PROGRESSIVE SHEAR TRANSFORMER BASE

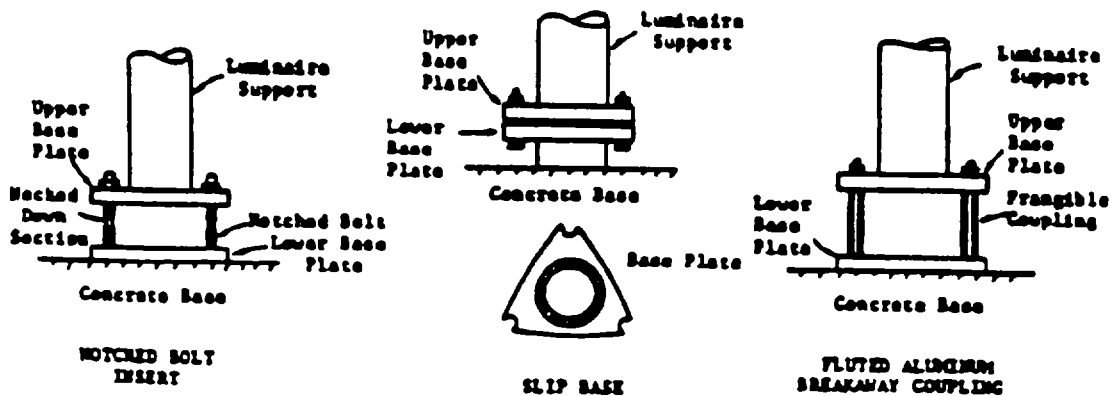

Variable Name: 1st C.D.C. - Object Contacted (cont'd.)
2nd C.D.C. - Object Contacted (cont'd.)

Code "54" (Concrete traffic barrier) refers to the longitudinal traffic barriers constructed of concrete and located: on the outside of the road surface, in a median, or in gore areas. This includes all temporary concrete barriers regardless of location (e.g., temporary Jersey barrier on a bridge being used to control traffic during bridge repair/construction). Concrete walls (vertical side surfaces) do not apply here, see code "58" (Wall). Below are a few of the common designs of concrete traffic barriers.

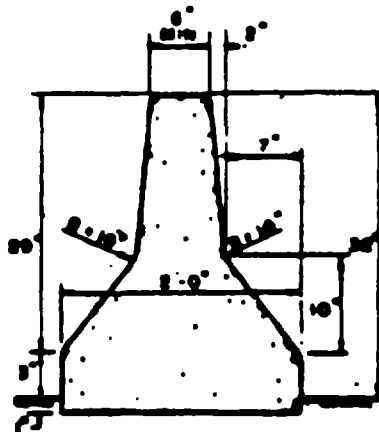

(Footing & Reinforcing Varies)

MB 3

Concrete Median Barrier

Continuously poured, reinforced, sloped faced, concrete section. Barrier can be anchored by dowels or an asphalt key.

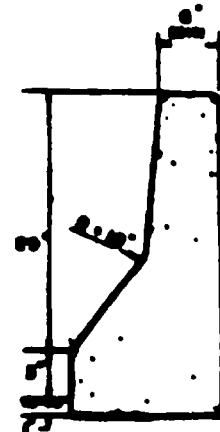

Concrete Safety Shape

Code "55" (Impact attenuator) refers to crash cushions which are barriers placed in front of fixed objects on the highway to absorb energy, and thus, to mitigate the injury effects of collisions at such sites. A number of common impact attenuating devices may be encountered; therefore, be sure to photograph them when encountered. Some common types are shown on continuation pages (12) and (13).

Code "56" (Other traffic barrier) refers to any longitudinal barrier not constructed of concrete. This includes all permanent guardrails and median barriers not on a bridge.

Variable Name: 1st C.D.C. - Object Contacted (cont'd.)
2nd C.D.C. - Object Contacted (cont'd.)

Code "57" (Fence) includes both the fence material and the support posts.

Code "58" (Wall) refers to solid, vertical faced, concrete, brick, stone, or other structurally sound roadside devices which may act as a traffic barrier in some locations. Do not confuse this code with "Fence" (code "57") or "Building" (code "59"). In most instances a wall will be backfilled with soil and will act as a vertically faced embankment.

Code "59" (Building) is used when the vehicle impacts a roofed and walled structure built for permanent use. The type of construction material used is not of interest, nor is the use of the building.

Code "60" (Ditch or culvert) refers to: (1) a man-made structure for drainage purposes, or (2) a man-made structure that allows passage over a drainage area and is that part of the structure which is intended to channel flow through the structure and maintain the stability/integrity of the road bed. If the culvert structure has a portion above the road surface which is of sufficient height to engage above the wheels of an errant CDS applicable vehicle and redirect it, that part of the structure is considered an "Other traffic barrier" (code "56"). When the sides of the ditch are approximately of equal height, it makes no difference which side of the ditch was struck; however, if the struck side is substantially higher than the other side, code the impact with the struck side as an "Embankment" (code "44"). Substantial means that an embankment existed had the ditch not been present.

Code "61" (Ground) refers to an impact with the ground. Collisions which may be classified using this code include (but are not limited to) vehicles which sustain undercarriage damage by (1) straddling the pavement and shoulder and impacting a prominent pavement lip, or (2) free falls or vaults from the road surface to the ground.

Code "62" (Fire hydrant) refers to the roadside device used by fire departments to provide water for fighting fires. Usually made of steel, these devices are also referred to as fireplugs or fire standpipes in some areas.

Variable Name: 1st C.D.C. - Object Contacted (cont'd.)
2nd C.D.C. - Object Contacted (cont'd.)

Code "63" (Curb) is used when the vehicle contacts a raised element at the edge of a roadway. Curbs are used to: control drainage, act as deterrents to vehicles leaving the pavement at hazardous points, delineate the edge of the pavement, present a more finished appearance, and assist in the orderly development of the roadway edge. Often a curb serves two or more of these purposes. Some typical highway curbs are illustrated in the diagrams below. Note that the dimensions are typical dimensions and may differ from the installations observed in the field.

Barrier Curbs

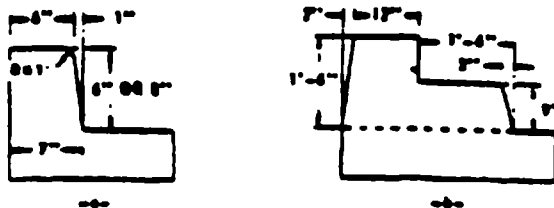

Mountable Curbs

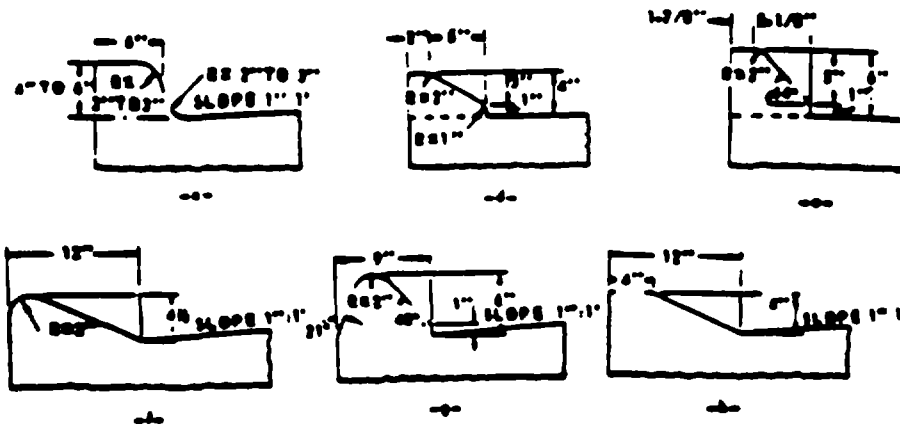

Typical Highway Curbs

Code "64" (Bridge) encompasses all structural members of an overpass structure used for vehicular or pedestrian traffic. This code includes guardrails, permanent concrete barriers, bridge rail/walls, bridge piers, bridge abutments, bridge parapet ends, wing walls associated with bridge abutments, and support columns. See continuation page (14) for a descriptive drawing.

Variable Name: 1st C.D.C. - Object Contacted (cont'd.)
2nd C.D.C. - Object Contacted (cont'd.)

- Code "68" (Other fixed object) is used for any other object of sufficient mass or anchored such that it is not readily movable; compare with code "88" (Other nonfixed object). Examples include large boulders, large logs (fallen trees), etc.
- Code "69" (Unknown fixed object) is used when it is known that the vehicle struck a fixed object but the specific type of object is not known.
- Code "71" (Motor vehicle not in transport) refers to a motor vehicle which is not on the roadway and not in motion (e.g., vehicle located in parking lane).
- Code "72" (Pedestrian) is defined as any person who is on a trafficway or on a sidewalk or path contiguous with a trafficway, and who is not in or on a nonmotorist conveyance. This includes persons who are in contact with the ground, roadway, etc., but who are holding onto a vehicle. A nonmotorist conveyance is defined as any human-powered device by which a nonmotorist may move, or by which a pedestrian or nonmotorist may move another nonmotorist, other than by pedaling. A nonmotorist conveyance includes the following: baby carriage, coaster wagon, ice skates, roller skates, push cart, scooter, skate board, skis, sled, wheelchair, rickshaw, etc. This includes those persons in a nonmotorist conveyance who hold onto a motor vehicle in motion. Excluded are pedalcyclists.
- Code "73" (Cyclist or cycle) refers to any occupant of a pedalcycle (see ANSI D16.1-1989, section 2.2.25, page 22), the cycle, or both. This includes those cyclists who hold onto a motor vehicle in motion.
- Code "74" (Other nonmotorist or conveyance) refers to a person who is not an occupant of a motor vehicle in-transport, a pedestrian, or a cyclist. Use this code if the impact was with a nonmotorist conveyance or a nonmotorist associated with a nonmotorist conveyance [if an animal is associated with this impact, see code "76" (Animal)]. This code also would be used for the occupants of a motor vehicle not in-transport, but only if they become separated from the not in-transport vehicle [see code "71" (Motor vehicle not in transport)].

Variable Name: 1st C.D.C. - Object Contacted (cont'd.)
2nd C.D.C. - Object Contacted (cont'd.)

Code "75" (Vehicle occupant) is used when the object contacted was any person who was an occupant of a motor vehicle in-transport; two examples follow. Use this code for an occupant who falls from a vehicle and is subsequently run over before stabilization occurred. In addition, use this code for any motorcyclist who separates from his/her motorcycle during impact and subsequently impacts a motor vehicle before stabilization occurred.

Code "76" (Animal) is used if the object contacted was an animal (stationary or nonstationary). Where a nonmotorist was associated with the animal (i.e., on the animal, or on or in an animal powered nonmotor vehicle transport device) use the following scheme. If the contact is to:

- o (1) the animal; the animal and the person; the animal and the conveyance; or the animal, conveyance, and the person; code "76" (Animal);
- o (2) the conveyance, or to the person, or to both the conveyance and the person, code "74" (Other nonmotorist or conveyance).

Code "77" (Train) refers to any railway train, moving or not moving.

Code "78" (Trailer, disconnected in transport) is used when the vehicle is contacted by or contacts a trailer which has become detached from its towing unit while the towing unit was in-transport. The type of trailer is not of interest; the only factors to consider are the detachment of the trailer and the transport status of the towing unit.

Code "79" (Object fell from vehicle in-transport) is used when the vehicle is contacted by or contacts an object that was being carried by or was attached to a vehicle in-transport but fell from or became detached from that vehicle. For example, a detached side mirror, spare tire, cargo, etc. Detached trailers are coded in "78" above.

Code "88" (Other nonfixed object) refers to any moveable object that is either readily moveable or is moving and is not specifically named above. Examples include trash cans, grocery carts, unoccupied pedalcycles, small boulders, sheared poles, etc.

Code "98" (Other event) is used when an event occurs which cannot be classified using one of the existing codes or definitions. A complete description should be given as well as describing the event on the Case Summary Form.

Code "99" (Unknown event or object) is used whenever the object contacted is not known or if an unknown event occurs and the researcher cannot determine what the event consisted of and how to code it.

Variable Name: 1st C.D.C. - Object Contacted (cont'd.)
2nd C.D.C. - Object Contacted (cont'd.)

SYSTEM	<p>C1 Steel Drums</p>	<p>C2 Hi-Dry Cell Sandwich</p>
BARRIER DESCRIPTION	<p>55 gallon light hood drums arranged in regular clusters. Fender panels or "fish scales" fastened to sides for side impact protection. 3/8" coils used to secure drums for side impacts. "H" ball chairs used to insure uniform siting of drums.</p>	<p>8" diameter, polypropyl chloride plastic cells filled with water. Fender panels (fish scales) are provided for re-direction.</p>

SYSTEM	<p>C3 Pitch Inertial Barrier</p>	<p>C4 Energetic Inertial Barrier</p>
BARRIER DESCRIPTION	<p>Specialty manufactured plastic containers (36" in diameter and height) filled with sand. Standard weights are 200, 400, 700, 1000 and 2100 lb. Volume and density of sand may vary.</p>	<p>Specialty manufactured plastic containers filled with sand. Standard size of container is 36" diameter top, 32" diameter base and 36 3/8" height. Standard weights of modules are 200, 400, 700 and 1000 lb.</p>

SYSTEM	<p>C5 Hi-Dry Cell Sandwich</p>	<p>C6 Hi-Dry Cell Cluster</p>
BARRIER DESCRIPTION	<p>Half-cell cartridges are arranged in a cluster along with fender panels (fish scales) to provide capabilities for hood-on and side impacts.</p>	<p>8" diameter, polypropyl chloride plastic cells arranged in a cluster and filled with water.</p>

Variable Name: 1st C.D.C. - Object Contacted (cont'd.)
2nd C.D.C. - Object Contacted (cont'd.)

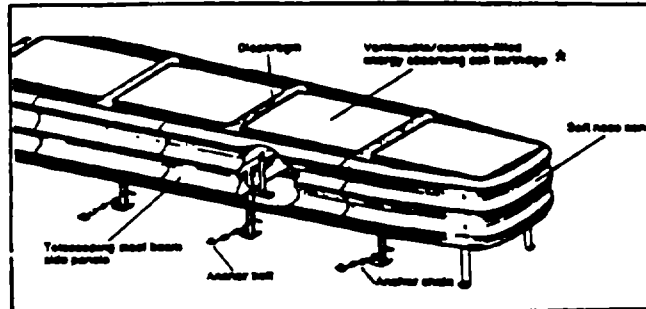

SYSTEM	Guard Rail Energy Absorbing Terminal (G.R.E.A.T.)	
BARBER DESCRIPTION	Minimum width of the terminal	7'0"
	Maximum width of the terminal	7'0" 7'6" with end overhang
	Weight	1,200 lbs. typical 5-bay unit
	Length	1'0" to 20' 14 bays to 10 bays

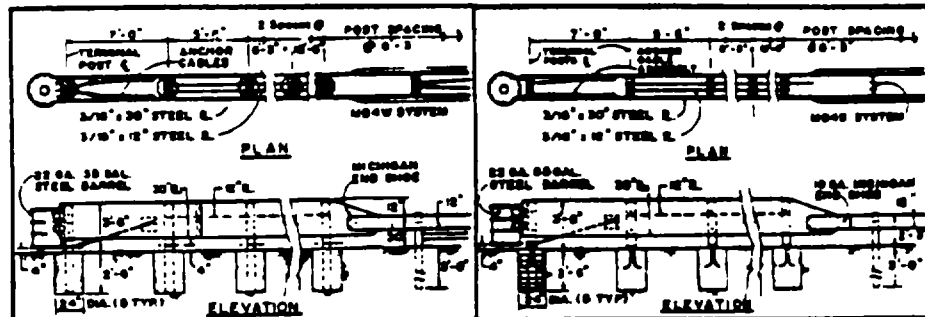

SYSTEM	TYPE I Median Barrier Breakaway Cable Terminal (Steel Post)	TYPE II Median Barrier Breakaway Cable Terminal (Steel Post)
BARBER DESCRIPTION	TYPICAL POST - 6\"/>	
	TYPICAL POST - 100-0 3 steel; TENSIONING POST - 700\"/>	

* The cartridge may also be filled with Hex-Foam which is a matrix of hex-shaped cardboard honeycomb filled with polyurethane foam. The cardboard is stacked in two and one-half centimeters layers in a cross-hatched fashion.

Variable Name: 1st C.D.C. - Object Contacted (cont'd.)
2nd C.D.C. - Object Contacted (cont'd.)

Bridge Components

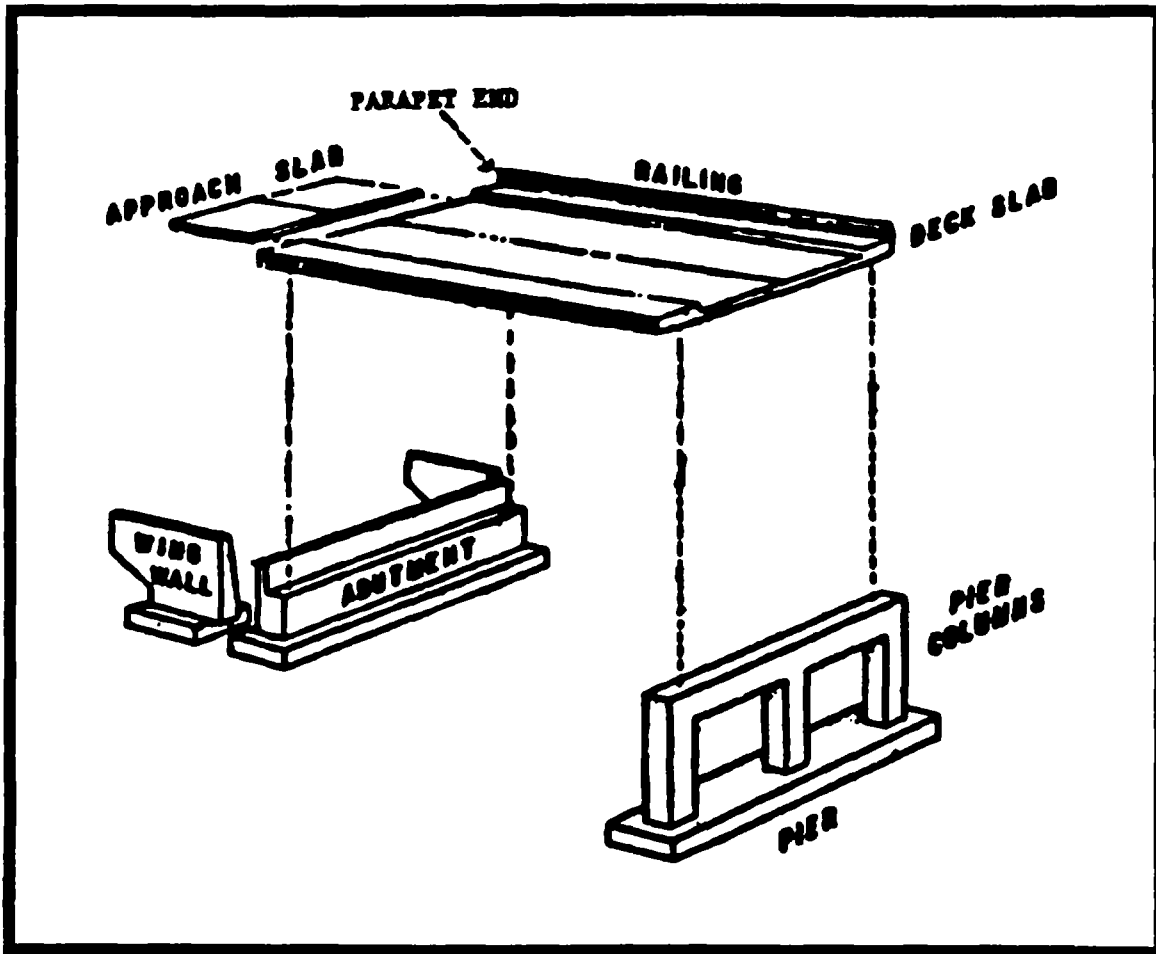

* Individual components of a bridge collectively become the bridge.

CDC RELATED REMARKSDirect Damage

The CDC generated for a particular impact is based upon damage resulting from direct contact only; it does not include induced damage. All CDCs are based entirely upon the procedures in SAE J224 MAR80.

No CDCs may be entered in variables EV06-EV11 and/or EV14-EV19 unless those CDCs are known in their entirety (i.e., "documented" CDCs). Partial CDCs, such as 99-F9EN-99, may be entered on the CDC WORKSHEET (Page 3 of the Exterior Vehicle Form), but are not applicable for coding in the CDC variables [i.e., a partial CDC is coded as an unknown CDC (99-9999-99) in variables EV06-EV11 and/or EV14-EV19]. Only those CDCs which are fully documented or unknown (i.e., 99-9999-99) are applicable for coding in the automated file (i.e., EV06-EV11 and EV14-EV19). Events which are outside the scope of CDC are not listed on the Exterior Vehicle Form in variables EV04-EV19. These events include: fire, intraunit damage caused by cargo shift, noncollision injury, etc.

Intraunit Damage

Intraunit direct damage caused by a jackknife can generate a CDC for the power (i.e., towing) unit only. The towed unit (if towed by a fixed linkage) is considered cargo, and even if that unit is another vehicle, a CDC is not applicable for any damage it may sustain. If the impact is to the cargo unit only and induced damage is incurred by the power unit, no CDC is generated for the induced damage to the power unit. If a trailer disconnects and subsequently causes direct damage to the power unit, then no CDC is generated for that damage because code "34" (Other intraunit damage) cannot be coded for Object Contacted, EV05/EV13. If, during an impact, cargo located in the trailing unit or in the bed of a pickup truck causes direct damage to the power unit or pickup truck respectively, then no CDC is generated for that damage. When intraunit direct damage caused by a jackknife exists, an Accident Event Sequence Number, EV04/EV12, is assigned and the Object Contacted, EV05/EV13, is equal to the Vehicle Number, EV03.

Add-on Components

Add-on components (e.g., snow plow blade, pickup cap, etc.) are considered cargo, and a CDC is not generated for direct damage sustained by the add-on component.

Overlapping Damage

During some accident sequences, a vehicle will sustain "overlapping damage" (i.e., multiple impacts in the same area of the vehicle). If the direct damage caused by each object contacted cannot be separated and described with individual CDCs, then one CDC is generated to describe all of the damage and this CDC is encoded in variables EV06-EV11.

CDC RELATED REMARKS (Continued)

Next, researchers must choose the object which caused most of the damage and enter: (1) the object's element number (i.e., "01"- "88") in variable EV05, 1st C.D.C. - Object Contacted, and (2) the event number in variable EV04, 1st C.D.C. - Accident Event Sequence Number. Finally, the object which caused the second greatest amount of damage is encoded in variable EV13, 2nd C.D.C. - Object Contacted; its event sequence number is encoded in EV12, 2nd C.D.C. - Accident Event Sequence Number, and an unknown CDC (99-9999-99) is entered in variables EV14-EV19.

Verbal Descriptions

Verbal descriptions by drivers, occupants, or owners may not form the basis for a CDC except in pedestrian accidents or very minor accidents (no residual damage); the vehicle must have been inspected. In cases involving no residual damage and where the vehicle is involved with another vehicle or object, that other vehicle or object must be inspected.

Additional Information

Refer to the document entitled: "Collision Deformation Classification/Truck Deformation Classification Advanced Reference Module", for more detailed discussions regarding CDC guidelines.

Single Impact/Event

If the vehicle sustained only one impact/event, the corresponding CDC (i.e., documented or unknown) is entered in EV06-EV11 and variables EV12-EV19 are left "Blank".

Multiple Impacts/Events

If the vehicle is involved in multiple impacts/events, the corresponding CDCs are ranked in order of highest delta V [i.e., greatest change in velocity experienced by the occupant(s) in the vehicle is usually the "most severe" impact]. If the CRASH program is applicable for every impact, the resultant delta Vs determine the CDC ranking. If CRASH is not applicable for every impact sustained by the vehicle, the CDC ranking must still reflect the greatest change in velocity as determined by the researcher.

All entries selected for coding in variables EV06-EV11 and EV14-EV19 must have encoded a corresponding event sequence number (EV04 and EV12) and object contacted (EV05 and EV13).

Variable Name: 1st C.D.C. - Direction of Force
2nd C.D.C. - Direction of Force

Element Values:

Range: Blank, 00-12, 20-32, 40-52, 60-72, 80-92, 99

Blank No C.D.C.

00	Nonhorizontal force	07	7 o'clock
01	1 o'clock	08	8 o'clock
02	2 o'clock	09	9 o'clock
03	3 o'clock	10	10 o'clock
04	4 o'clock	11	11 o'clock
05	5 o'clock	12	12 o'clock
06	6 o'clock	99	Unknown

Incremental Values for Above Force Directions

00	No shift
20	End shift vertical--up; top shift--forward
40	End shift vertical--down; top shift--rearward
60	End or top shift lateral--right
80	End or top shift lateral--left

Source: Restricted to vehicle inspection or photographs.

Remarks:

Code the principal direction of force incremented to indicate: (1) vertical or lateral shifting of vehicle basic end structures which occurred during horizontal force application, or (2) longitudinal or lateral shifting to the top structure resulting from nonhorizontal force application to the top. In other words, the combined value (Direction of Force + Incremental Value of Shift) is coded under this variable.

Code "00" (Nonhorizontal) (plus any Incremental Value of Shift for a top structure impact) any time a vehicle becomes inverted and impacts any object or vehicle while inverted. In addition, use this code in any other circumstance which is consistent with the directions contained in SAE J224 MAR80.

An estimated CDC is indicated for each impact (Page 3, Exterior Vehicle Form). In this estimate, write the direction of principal force in increments of ten degrees rather than in clock positions. Thus, if the direction appeared to be approximately ten degrees to the right of straight-ahead, indicate "010". If the direction of force appeared to be ten degrees left of straight-ahead, indicate "-010" (or "350"). The final coding of the CDC on Page 4 (Exterior Vehicle Form) reflects the direction of force in clock positions. For example if the principal direction of force (PDOF) is closest to ten degrees to the right of straight-ahead, "010" ["-005" ("355") to "025"], then the estimated Direction of Force is coded according to the clock direction--either "12" or "01" as determined by examining all available inputs to ensure accuracy for force

Variable Name: 1st C.D.C. - Direction of Force (cont'd.)
2nd C.D.C. - Direction of Force (cont'd.)

assignments. If, upon examining all the available inputs, the researcher believes the PDOF is more likely to be within +015 to +025 and classifies the clock direction (EV06 or EV14) as "01", then Page 3 (Direction of Force) still reflects the original value: "010".

When occasional differences which seem to be inconsistent (e.g., PDOF = 010° and clock position = 01) are encountered, they actually reflect the investigative method; therefore, reconcile the differences by reviewing the entire case and any CRASH output to determine if the difference is reasonable. This procedure allows the zone center reviewer to appreciate what the researcher thought the PDOF (Page 3) was, to the closest 10 degrees, based upon examination of that vehicle alone, while the clock position representing the force on Page 4 reflects the final determination after examining all sources (vehicles, objects contacted, scene evidence, CRASH program, etc.). In other words, it is not necessary for the force directions on Page 4 and the PDOFs on Page 3 to be compatible. However, any force direction on the final CRASH output must be compatible with the force direction coded in variable EV06 or EV14.

Refer to the document entitled: "Collision Deformation Classification Training Program: Intermediate Level - Training/Reference Module", for detailed definitions of the element values as well as instruction on proper usage. This document is based upon SAE J224 MAR80.

See the discussion in CDC Related Remarks (EV06-EV11, EV14-EV19) for coding clarifications and procedures.

Code "Blank" (No event or not CDC applicable) is used when there is not an event or when an event exists but is not CDC applicable.

Variable Name: 1st C.D.C. - Deformation Location
2nd C.D.C. - Deformation Location

Element Values:

Blank No C.D.C.
F Front
R Right side
L Left side
B Back (rear)
T Top
U Undercarriage
9 Unknown

Source: Restricted to vehicle inspection or photographs.

Remarks:

Refer to the document entitled: "Collision Deformation Classification Training Program: Intermediate Level - Training/Reference Module", for detailed definitions of the element values as well as instruction on proper usage. This document is based upon SAE J224 MAR80.

See the discussion in CDC Related Remarks (EV06-EV11, EV14-EV19) for coding clarifications and procedures.

Code "Blank" (No C.D.C.) is used when there is not an event or when an event exists but is not CDC applicable.

Variable Name: 1st C.D.C. - Specific Longitudinal or Lateral Location
2nd C.D.C. - Specific Longitudinal or Lateral Location

Element Values:

Blank No C.D.C.

Horizontal Impacts

D Distributed--side or end
L Left--front or rear
C Center--front or rear
R Right--front or rear
F Side front--left or right
P Side center section--L or R
B Side rear--left or right
Y Side (F + P) or end (L + C)
Z Side (P + B) or end (C + R)
9 Unknown

Top or Undercarriage

D Distributed (F+P+B)
F Front Section
P Center Section
B Rear Section
Y F+P
Z P+B
9 Unknown

Source: Restricted to vehicle inspection or photographs.

Remarks:

Element values "F", "P", "B", "Y", "Z", and "D" must be used for vehicles with top or undercarriage deformation ("T" or "U" in variable EV07 and/or EV15).

Refer to the document entitled: "Collision Deformation Classification Training Program: Intermediate Level - Training/Reference Module", for detailed definitions of the element values as well as instruction on proper usage. This document is based upon SAE J224 MAR80.

See the discussion in CDC Related Remarks (EV06-EV11, EV14-EV19) for coding clarifications and procedures.

Code "Blank" (No C.D.C.) is used when there is not an event or when an event exits but is not CDC applicable.

Variable Name: 1st C.D.C. - Specific Vertical or Lateral Location
2nd C.D.C. - Specific Vertical or Lateral Location

Element Values:

Blank No C.D.C.

CDC (Vertical - Front, Rear, or Side Impacts)

A All
H Top of frame to top
E Everything below belt line
G Belt line and above
M Middle--top of frame to belt line or hood
L Frame--top of frame, frame, bottom of frame (including undercarriage)
W Below undercarriage level (wheels and tires only)
9 Unknown

CDC (Lateral - Top and Undercarriage Impacts)

D Distributed
L Left
C Center
R Right
Y Left and Center (L + C)
Z Right and Center (R + C)
9 Unknown

Source: Restricted to vehicle inspection or photographs.

Remarks:

Refer to the document entitled: "Collision Deformation Classification Training Program: Intermediate Level - Training/Reference Module", for detailed definitions of the element values as well as instruction on proper usage. This document is based upon SAE J224 MAR80.

See the discussion in CDC Related Remarks (EV06-EV11, EV14-EV19) for coding clarifications and procedures.

Code "Blank" (No C.D.C.) is used when there is not an event or when an event exists but is not CDC applicable.

Variable Name: 1st C.D.C. - Type of Damage Distribution
2nd C.D.C. - Type of Damage Distribution

Element Values:

Blank No C.D.C.
W Wide impact area
N Narrow impact area
S Sideswipe
O Rollover (includes side)
A Overhanging structure
E Corner
K Conversion in impact type
U No residual deformation
9 Unknown

Source: Restricted to vehicle inspection or photographs.

Remarks:

Refer to the document entitled: "Collision Deformation Classification Training Program: Intermediate Level - Training/Reference Module", for detailed definitions of the element values as well as instruction on proper usage. This document is based upon SAE J224 MAR80.

See the discussion in CDC Related Remarks (EV06-EV11, EV14-EV19) for coding clarifications and procedures.

Code "Blank" (No C.D.C.) is used when there is not an event or when an event exists but is not CDC applicable.

Note: When recording a "K" conversion impact type on the Exterior Vehicle form, page 4, variables EV04-EV19 (Highest and Second Highest Delta V), follow the procedures below:

1. The "K" conversion is the only impact -- Code the first half of the "K" conversion in variables EV04-EV11 (highest delta V); and code the second half of the "K" conversion in variables EV12-EV19 (second highest delta V).
2. There are two or more impacts including a "K" conversion. The "K" conversion is the Highest or Second Highest Delta V. -- Code only the first half of the "K" conversion as the highest or second highest delta V (which-so-ever is appropriate). The other CDC row is coded with the appropriate highest or second highest delta V.

Variable Name: 1st C.D.C. - Deformation Extent Guide
2nd C.D.C. - Deformation Extent Guide

Element Values:

Blank	No C.D.C.
01	One
02	Two
03	Three
04	Four
05	Five
06	Six
07	Seven
08	Eight
09	Nine
99	Unknown

Source: Restricted to vehicle inspection or photographs.

Remarks:

Extent zone is coded from direct damage only, even when a body panel is torn loose from the vehicle frame due to impact; consider body panels torn loose from the frame as not representative of residual crush.

When you average two crush profiles, use the largest maximum crush for your extent zone (i.e., do not use the averaged maximum crush).

Refer to the document entitled: "Collision Deformation Classification Training Program: Intermediate Level - Training/Reference Module", for detailed definitions of the element values as well as instruction on proper usage. This document is based upon SAE J224 MAR80.

See the discussion in CDC Related Remarks (EV06-EV11, EV14-EV19) for coding clarifications and procedures.

Code "Blank" (No C.D.C.) is used when there is not an event or when an event exists but is not CDC applicable.

CRUSH PROFILE OVERVIEW

For the section entitled "Crush Profile", code the CDC associated damage dimensions for the Highest Delta "V" CDC (EV4-EV11) and the Second Highest Delta "V" (EV12-EV19). The encoded "L", "C"s and "D" values must be the actual data set used in the reconstruction program (i.e., CRASH or OLDMIS).

If the damage measurements are known, code the appropriate measurements to the nearest centimeter regardless of whether a reconstruction algorithm was completed. If only two or four C-values are collected (rare occasions), then leave the remaining C-value fields blank.

END DAMAGE MEASUREMENT PROTOCOL

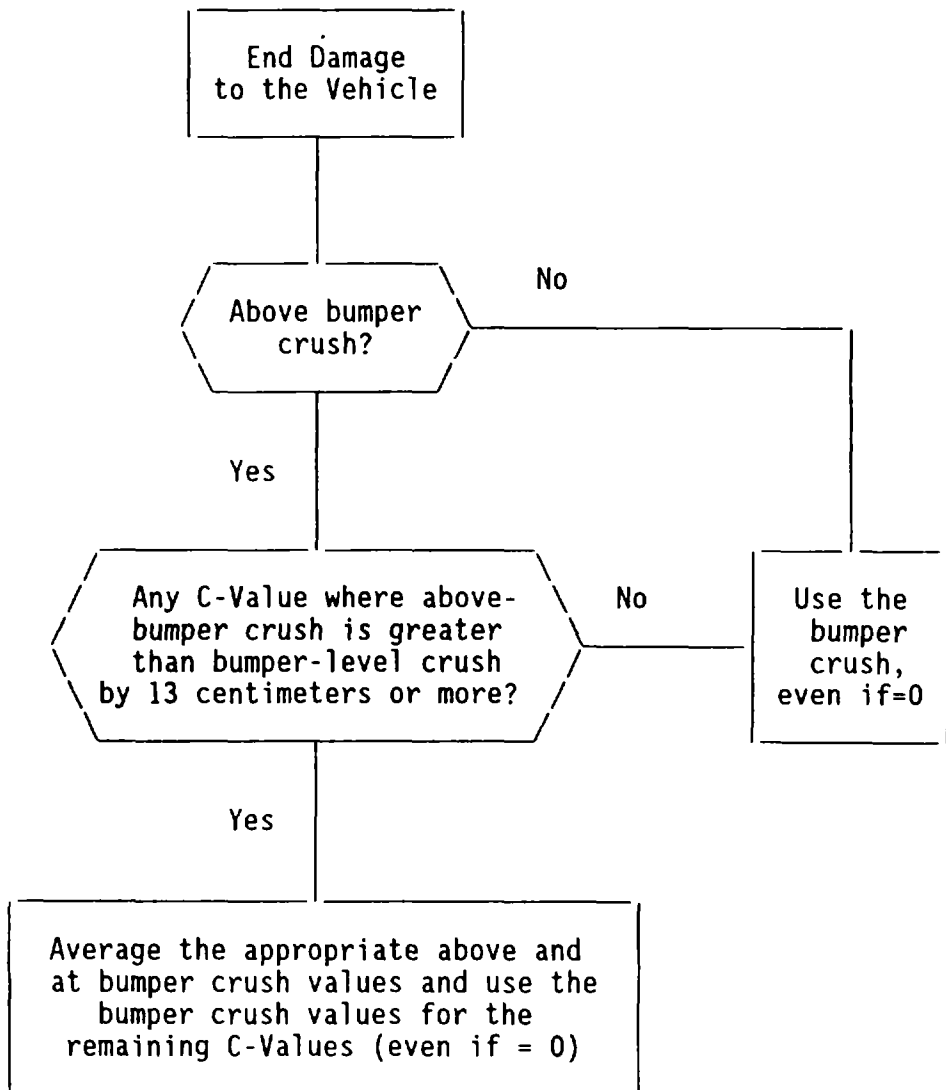

Variable Name: Location of Intrusion (cont'd.)
(1st through 10th)

Code "12" (Middle) is defined as the center sector of the Front Row.

Code "13" (Right) is defined as the right sector of the Front Row.

Code "21" (Left) is defined as the left sector of the Second Row. The lateral dimension of this sector is mathematically determined by dividing the original wall-to-wall dimension by three.

Code "22" (Middle) is defined as the center sector of the Second Row.

Code "23" (Right) is defined as the right sector of the Second Row.

Code "31" (Left) is defined as the left sector of the Third Row. The lateral dimension of this sector is mathematically determined by dividing the original wall-to-wall dimension by three.

Code "32" (Middle) is defined as the center sector of the Third Row.

Code "33" (Right) is defined as the right sector of the Third Row.

Code "41" (Left) is defined as the left sector of the Fourth Row. The lateral dimension of this sector is mathematically determined by dividing the original wall-to-wall dimension by three.

Code "42" (Middle) is defined as the center sector of the Fourth Row.

Code "43" (Right) is defined as the right sector of the Fourth Row.

Code "97" (Catastrophic) is coded when the intrusion damage to the occupant compartment is so devastating that the researcher is not able to discern any of the following: specific occupant locations, intruding components, magnitude of intrusions, and dominant crush.

Code "98" (Other enclosed area) is an area where no defined row exists. This would include an area where the entire seat row was folded down prior to the accident. Occasionally, the mid seat row in a passenger van will be removed leaving only the front and rearmost seat rows. If intrusion occurs within this area, the location should be identified here and specified.

Code "99" (Unknown) is used for the following situations.

- o The researcher cannot determine if there was any intrusion.
- o The vehicle was under repair at the time of inspection.

Variable Name: 1st Crush Profile - L
2nd Crush Profile - L

Element Values:

Range: 001 through 650 centimeters, Blank

Code measured value to the nearest centimeter.
Blank No crush profile for most severe impact(s)

Source: Vehicle inspection

Remarks:

These variables are the "L" dimensions normally used in the CRASH3 (or OLDMIS) input for the highest (EV04-EV11) and second highest (EV12-EV19) delta V impacts sustained by the vehicle. The damage measurements associated with one of these CDCs may be encoded regardless of the use of a reconstruction program (e.g., when the assumptions of the reconstruction program are not valid).

Code "Blank" [No crush profile for most severe impact(s)] when a reconstruction program is used but no value is entered into the reconstruction program or the measurement is unknown (i.e., CDC only run or OLDMISS where this vehicle's data are missing).

EXTERIOR VEHICLE FORM

EV21
EV24

Variable Name: 1st Crush Profile - C1-C6
2nd Crush Profile - C1-C6

Element Values:

Range: 000 through 250, Blank

Code measured value to the nearest centimeter.
Blank No crush profile for most severe impact(s)
250 250 centimeters or greater

Source: Vehicle inspection

Remarks:

The damage measurements associated with a priority (i.e., 1st or 2nd highest) CDC are coded regardless of the use of a reconstruction program. Code the obtained C-values for each impact (highest two delta V impacts) to the nearest centimeter in the space provided.

If a reconstruction program is used, the encoded values of "C" (i.e., C1, C2, C3, C4, C5, and C6) must be the same as the C-values used in the reconstruction program, and they may differ from C-measurements made in the field (e.g., averaged measurements for override).

Code "Blank" [No crush profile for most severe impact(s)] when a reconstruction program is used but no value is entered into the reconstruction program or the measurements are unknown (i.e., CDC only run or OLDMISS where this vehicle's data are missing).

Code "250" if there is 250 centimeters or more of crush.

Variable Name: 1st Crush Profile - D
2nd Crush Profile - D

Element Values:

Range: -300 to -001, _000, +001 to +300 centimeters, Blank

Code measured value to the nearest centimeter.

Blank No crush profile for most severe impact(s)

_000 Greater than -0.5 and less than +0.5 centimeters

Source: Vehicle inspection

Remarks:

The damage measurement associated with a priority (i.e., 1st or 2nd highest) CDC is coded regardless of the use of a reconstruction program. Encode the measurement normally used in the computer program.

Code "_000" if the measured or calculated "D" value for the particular crush profile is "0" (i.e., greater than -0.5 and less than +0.5) centimeters; otherwise, code the value to the nearest centimeter.

Code "Blank" [No crush profile for most severe impact(s)] when a reconstruction program is used but no value is entered into the reconstruction program or the measurement is unknown (i.e., CDC only run or OLDMISS where this vehicle's data are missing).

Variable Name: Are CDCs Documented but Not Coded on the Automated File?

Element Values:

0 No
1 Yes

Remarks:

A CDC must be known in its entirety to be considered "documented". An unknown (i.e., 99-9999-99) CDC is not a "documented" CDC, nor is a partial CDC (e.g., 12-F9EN-99).

Code "1" (Yes) if any "documented" CDC is written on the "CDC Worksheet" (Page 3 of the Exterior Vehicle Form), and it is not coded in variables EV06-EV11 or EV14-EV19 (Collision Deformation Classification); otherwise, code this variable "0" (No).

Variable Name: Researcher's Assessment of Vehicle Disposition

Element Values:

- 0 Not towed due to vehicle damage
- 1 Towed due to vehicle damage
- 9 Unknown

Source: Primary source is the vehicle; secondary source is interviewee(s).

Remarks:

Whereas variable GV09, Police Reported Vehicle Disposition, reports this vehicle's manner of leaving the scene based solely on the police report data, determine this variable (EV27) based on vehicle inspection (which is supplemented by interview data for a repaired vehicle).

"Towing" is defined identically to the definition in variable GV09 (i.e., towing must be a result of event-related disabling damage; towing must occur directly from the scene, etc.). A gray area exists, however, when attempting to define the term "disabling damage".

A police officer may categorize damage such as broken headlights, broken taillights, flat or restricted tires, etc., as "disabling", when, in fact, the vehicle is capable of being driven from the scene. Therefore, when the PAR indicates it was towed due to damage, use the following guideline.

Determine the severity of the damage during the vehicle's inspection. Code "0" (Not towed due to vehicle damage) if the damage is "minor" (i.e., minor mechanical repairs could have been completed at the scene). "Minor mechanical repairs" refers to items such as: replacing headlights or taillights, changing tires, pulling sheet metal away which may be restricting a wheel, etc.

NOTE: These repairs need not have been completed at the scene. They are merely examples of situations which do not require the vehicle to be categorized "disabled" for the NASS CDS study.

Code this variable independently of variable GV09, Police Reported Vehicle Disposition. The tow status reported here is determined primarily during vehicle inspection; however, if the vehicle was repaired, then code this variable based on input from an interviewee. Under no circumstance should the PAR be used as a source for coding this variable.

Annotate the reason for the encoded choice in the blank space at the bottom of Page 4 of the Exterior Vehicle Form. For example, a researcher selects code "0" (Not towed due to vehicle damage) and provides the following annotation: "The vehicle received only broken headlights in the collision; police required that the vehicle be towed".

Code "0" (Not towed due to vehicle damage) when the vehicle was driven from the scene, or when the vehicle was unnecessarily towed from the scene (i.e., could have been driven).

Variable Name: Researcher's Assessment of Vehicle Disposition (cont'd.)

Code "1" (Towed due to vehicle damage) when the vehicle sustained damage from the accident such that towing was required.

Code "9" (Unknown) when:

- o the vehicle was towed from the scene but the reason for the towing cannot be determined, or
- o the disposition of the vehicle from the scene cannot be determined.

Variable Name: Original Wheelbase

Element Values:

Range: 100-650, 999

Code to the nearest centimeter.

650 650 centimeters or more

999 Unknown

Source: Primary and secondary source materials are listed in variable GV19, Vehicle Curb Weight.

Remarks:

The wheelbase dimension is obtained from source materials and not from vehicle measurements. This dimension is encoded to the nearest centimeter.

Code "999" (Unknown) is used when this vehicle's original specification is not available.

Variable Name: Is This a Multi-Stage Manufactured Vehicle And/Or
A Certified Altered Vehicle?

Element Values:

- 0 No post manufacturer modifications
- 1 Yes - post manufacturer modifications (specify)
(Include photograph of CERTIFICATION PLACARD in case report)
- 9 Unknown if vehicle is modified

Source: Vehicle Inspection

Remarks:

Under the "Code of Federal Regulations, Title 49 - Transportation" Chapter V Part 567, Sections 567.5 and 567.7, a label certifying compliance with all Federal Motor Vehicle Safety Standards must be affixed to a multi-stage manufactured vehicle or altered (post manufactured) vehicle.

A multi-stage manufactured vehicle will generally begin as a chassis-cab (incomplete vehicle) and subsequently end up in final-stage as a pickup based utility truck (dump truck, flat bed, stake body, tow truck, etc.) or a van derivative (i.e., van conversion, Hi-cube, motor home, etc.).

Altered vehicles will generally involve a major modification of basic components such as suspension, frame, power plants, etc., with work generally performed by a recognized auto body shop. The lengthening of a standard automobile chassis to create a limousine would be one example of the type of alteration which would qualify for certification.

To determine if the vehicle qualifies, locate the certification label which should include one of the following statements:

Multi-stage vehicle

- o Incomplete manufactured vehicle (chassis-cab) certification label should include the statement: "**CHASSIS-CAB MANUFACTURED BY**" or "**CHASSIS-CAB MFD BY**".
- o Intermediate manufactured vehicle certification label should have the following statement: "**INTERMEDIATE MANUFACTURED BY**" or "**INTERMEDIATE MFD BY**".
- o Final manufactured vehicle certification label should have the following statements: "**MANUFACTURED BY**" or "**MFD BY**" and "**INCOMPLETE VEHICLE MANUFACTURED BY**" or "**INC VEH MFD BY**".

Altered vehicle

- o An altered vehicle certification label should include the statement: "This vehicle was altered by (individual or corporate name) in (month and year in which alterations were completed) and as altered it conforms to all applicable Federal Motor Vehicle Safety Standards affected by the alteration and in effect in (month, year)."

EXTERIOR VEHICLE FORM

EV29
(2)

Variable Name: Is This a Multi-Stage Manufactured Vehicle And/Or
A Certified Altered Vehicle? (cont'd.)

These labels are generally affixed in one of the following areas on the driver's side of the vehicle:

- o hinge pillar
- o door-latch post
- o door edge that meets the door-latch post
- o left side of the instrument panel
- o inward-facing surface of driver's door

Code "0" (No post manufacturer modifications) is used when this vehicle was a full-line manufactured vehicle. Full-line is interpreted as a vehicle that is completely assembled at the end of a plant assembly line of its original manufacturer. This would include vehicles which only require cosmetic additions such as additional paint, mirrors, wheels, etc., to be customer ready!

Code "1" (Yes - post manufacturer modifications) is used for multi-stage vehicles and/or altered certified vehicles. This includes vehicles which were in various stages of completion (i.e., incomplete, intermediate, final).

Vehicles that are altered via "backyard modification (i.e., addition of air shocks, spring spacers, cosmetic alteration including sheet metal and paint, etc.) are not identified as altered certified vehicles. Only those businesses which specialize in vehicle alterations (i.e., limo body shops, etc.) where a label of alteration is required by federal regulations and is present on the vehicle are identified in this element.

A slide (photo) of the certification label(s) is essential and must be included with the case. Refer to the following illustrations for examples of certifying labels.

MPD BY:	Crescent Cruiser Co.		
DATE OF MFR	10/88		
INC. VEH. MFD BY	Ford Motor Co.		
DATE OF INC MFR	9/88		
G.V.W.R	6100 LBS		
G.A.W.R FRONT	3095	WITH	225/76R15
TIRES	15X7 0	RIMS	AT
	35	PSI COLD SINGLE	
REAR	3408	WITH	225/76R15
TIRES	15X7 0	RIMS	AT
	35	PSI COLD	
THIS VEHICLE CONFORMS TO ALL APPLICABLE FEDERAL MOTOR VEHICLE SAFETY STANDARDS IN EFFECT IN			
V I N	9/88		
TYPE	MPV		

INCOMPLETE VEHICLE MANUFACTURED BY FORD MOTOR COMPANY MADE IN THE U S A			
DATE	02/90	GVWR	6100LB/2766KG
FRONT GAWR.	3095LB	REAR GAWR:	3408LB
1403KG	WITH	1644KG	WITH
P225/76R15SL	TIRES	P225/76R15SL	TIRES
15X6 0JK	RIMS	15X6 0JK	RIMS
AT 35 PSI COLD		AT 35 PSI COLD	
			
MJ			06
EXTERIOR PAINT COLOR			
138	E142	D8	T 19 44P
FOTA 1504A10 EA			

Variable Name: Is This a Multi-Stage Manufactured Vehicle And/Or
A Certified Altered Vehicle? (cont'd.)

Code "9" (Unknown) is used in the following situations.

- o The vehicle fits the description of a multi-stage or altered vehicle, but the researcher was not able to view the label(s) for positive identification.
- o The label(s) was removed/destroyed so a clear determination of whether the vehicle was a certified multi-stage or altered vehicle could not be made.

Variable Name: Fire Occurrence

Element Values:

0 No fire

Yes, fire occurred

1 Minor

2 Major

9 Unknown

Source: Primary source is the vehicle inspection; secondary sources include the interviewee(s), police accident report, and occupant medical records.

Remarks:

In order to classify fire damage, a fire must have occurred to this vehicle. (1) The fire could have resulted from an impact with another vehicle or object which consequently caused a fuel system integrity failure or electrical short circuit. (2) If the fire resulted from a noncollision event (e.g., electrical short circuit, fuel leakage, etc.) that occurred prior to this vehicle impacting with another vehicle or object, and if the crash qualifies for the NASS CDS, then both the noncollision event and all subsequent events are coded on the Accident Form.

As it pertains to the occurrence of fire, the crash circumstances are not considered stabilized until the threat of damage to this vehicle, or injury consequences to this vehicle's occupants, has ceased. Therefore, the crash sequence is not considered stabilized until all occupants have exited the vehicle and the scene has been declared safe by police or other authority. Fires that occur at a later time to vehicles abandoned at the scene (e.g., in open fields, on hillsides, etc) or to vehicles removed from the scene to another location (towyard, curbside, etc.) are not considered part of the accident sequence.

Code "0" (No fire) is used when no fire occurred to this vehicle during the accident sequence or before accident circumstances stabilized.

Code "1" (Minor) is a general term used to describe the degree of fire involvement and is used in the following situations:

- o Engine compartment only fire
- o Trunk compartment only fire
- o Partial passenger compartment only fire
- o Undercarriage only fire
- o Tire(s) only fire
- o The vehicle sustained fire damage and the extent of the fire damage could not be determined during vehicle inspection.

Variable Name: Fire Occurrence (cont'd.)

Code "2" (Major) identifies those situations where the vehicle experienced a greater fire involvement than defined under Code "1" above and is used in the following situations:

- o Combined engine and passenger compartment fire (either partial or total passenger compartment involvement).
- o Total passenger compartment fire.
- o Combined trunk and passenger compartment fire (either partial or total passenger compartment involvement).
- o Combined undercarriage and passenger compartment (either partial or total passenger compartment involvement).
- o Combined tire(s) and passenger compartment (either partial or total passenger compartment involvement).

Code "9" (Unknown) is used if a fire occurred in this crash, but it cannot be determined if this vehicle sustained a fire.

Variable Name: Origin of Fire

Element Values:

- 0 No fire
- 1 Vehicle exterior (front, side, back, top)
- 2 Exhaust system
- 3 Fuel tank (and other fuel retention system parts)
- 4 Engine compartment
- 5 Cargo/trunk compartment
- 6 Instrument panel
- 7 Passenger compartment area
- 8 Other location (specify):
- 9 Unknown

Source: Primary source is the vehicle inspection; secondary sources include the interviewee(s), and police accident report.

Remarks:

This variable identifies the location of fire initiation and should not be confused with magnitude of fire. As an example, if the vehicle appeared totally "burnt", code "7" (Passenger compartment area) would not necessarily be used unless the fire began in the vehicle's interior.

For many fires it will be difficult to determine fire origin especially when the entire vehicle was involved. The researcher should look for "hot" spots which generally appear lighter in coloration and are often accompanied by warped or melted metal.

If multiple fires occur to the same vehicle, choose the fire that started within this vehicle (i.e., choose an interior fire over an exterior fire), then choose the fire with the greater severity.

Code "0" (No fire) is used when no fire occurred to this vehicle during the accident sequence or before accident circumstances stabilized.

Code "1" [Vehicle exterior (front, side, back, top)] identifies fire source as occurring external to the vehicle. This generally occurs in a multiple vehicle collision where another vehicle initiates the fire and the fire is then introduced to this vehicle.

Code "2" (Exhaust system)) is used when components of the exhaust system initiated the fire. Components of the exhaust system include: "exhaust" pipes, muffler/resonator, and catalytic converter.

Code "3" [Fuel tank (and other fuel retention system parts)] includes: the fuel tank(s), fuel supply and vent lines, tank filler neck, and fuel filler cap. Use this code when the fuel tank area (defined above) sustains damage such that fuel leaks and is ignited by sparks from contact with the surface of crushing metal components, or is ignited by hot surfaces of the vehicle or object that is involved in producing the damage (e.g., lamp filaments, hot engine components of an impacting vehicle).

Variable Name: Origin of Fire

Do not use code "3" if fuel leakage occurs and is ignited in this vehicle's engine compartment [i.e., use code "4" (Engine compartment)]. If fuel leakage occurs in the fuel tank area and spills onto and is ignited by hot exhaust system components, then use code "2" (Exhaust system).

Code "4" (Engine compartment) is used when the fire initiates in the area (open or enclosed) which houses the engine. Generally, most engine compartments are located at the front end of the vehicle under the hood. However, some engines are mounted midway (referred to as mid-engine) on the chassis, and some are located at the rear of the vehicle.

The reason for fire initiation in these areas is inconsequential (whether fuel or electrical), but the fire's relative location to the engine is the important consideration.

Code "5" (Cargo/trunk compartment) identifies areas which are separated from the passenger compartment by a solid partition. In passenger automobiles, the partition will generally be formed by the seat back(s), package shelf, and trunk lid. However, areas designed to accommodate cargo (e.g., the area behind the second seat of a station wagon) are not considered a cargo compartment unless these areas were walled off by a solid partition. Please note, a grate fencing is not considered a solid partition. A solid partition is generally composed of a material which limits air flow between areas.

Cargo boxes on pickup trucks are generally separated from the occupant compartment by the back wall of the cab and are classified as a cargo compartment. Please note, operable windows in backlights of pickup cabs are considered part of the solid partition, regardless of opening status.

Light vans will generally not have a separate cargo compartment unless a solid wall was installed.

Code "6" (Instrument panel) is used when the fire originated under the instrument panel. The instrument panel is defined as the panel extending horizontally from A-pillar to A-pillar and vertically from the lower part of the windshield to the lowest vertical edge of the panel (refer to Figure 1 and 2 under variable IV95 for panel illustrations).

Code "7" (Passenger Compartment area) is used when the fire initiated within the designated passenger area. This includes cargo areas adjacent to seating areas which were not separated by a solid partition.

Code "8" (Other location) is used when codes "1"- "7" above do not apply and a fire was involved. Included in this code are fires occurring with wheels or brakes.

Variable Name: Origin of Fire

Code "9" (Unknown) is used in the following situations:

- o The vehicle was totally destroyed by fire and the origin could not be determined.
- o A combination of areas were involved but an estimate of point of origin could not be made.
- o A fire was reported, but the vehicle was repaired prior to inspection.

Variable Name: Type of Fuel Tank-1
Type of Fuel Tank-2

Element Values:

- 0 No fuel tank (electrical vehicle)
- 1 Metallic
- 2 Non-Metallic
- 9 Unknown

Source: Vehicle Inspection

Remarks:

This variable records the composition of the fuel tank that is permanently affixed to the vehicle as an energy reservoir for the vehicle's engine. Some vehicles may be equipped with reserve fuel tanks (i.e., more than one tank connected in series and controlled by the driver). Extra fuel tanks on-board a vehicle which are not designed to supply fuel to the vehicle's engine are not considered for this variable. Some examples include: fuel cans, bottled gas, and ancillary tanks for occupational related work (i.e., construction, etc.).

Code "0" [No fuel tank (electrical vehicle)] is used for both variables EV32 and EV33 when the vehicle is powered solely by electrical means.

For an electrical vehicle which uses a fossil or grain fuel back-up system, EV32 is coded "0" [No fuel tank (electrical vehicle)] and EV33, the tank for the back-up fuel system, is classified under codes "1", "2" or "9" below.

Code "1" (Metallic) is used for fuel tanks made from metal. This would include steel, aluminum (alloys), stainless steel, etc.

Code "2" (Non-metallic) is used for fuel tanks which are made from plastic. Plastic tanks are composed of high density polyethylene (HDPE).

Code "9" (Unknown) is be used as follows:

- o researcher could not make a determination due to inaccessibility,
- o vehicle was dismantled during inspection and the fuel tank(s) was not available, or
- o the type of tank material could not be determined,

The following information has been compiled from discussions with automobile manufacturers, service and parts representatives and the National Automotive History Collection. In coding variable EV32, this information should be confirmed by visual and/or mechanical means.

Variable Name: Type of Fuel Tank-1 (Cont'd.)
Type of Fuel Tank-2 (Cont'd.)

Vehicle Fuel Tank Material

HDPE (High Density Polyethylene)

- (1) Ford Motor Co.
- | | |
|------------------------|--|
| Ford Aerostar Mini Van | HDPE |
| Ranger PU (89-on) | HDPE |
| Explorer | HDPE |
| Cougar/T-Bird (90-on) | Some have HDPE with steel reinforcement |
| F Series PU | Some of the earlier models may have HDPE |
| Escort (91-on) | Some have HDPE |
| Tracer (91-on) | Some have HDPE |
| Mustang (93-on) | Some have HDPE |
- (2) General Motors Corp.
- Chevrolet
- | | |
|------------------|------|
| Lumina Mini Van | HDPE |
| "B" Body (91-on) | HDPE |
| - Caprice | |
| - Impala | |
| - Station Wagons | |
| "L" Body (91-on) | HDPE |
| - Corsica | |
| - Beretta | |
- Pontiac
- | | |
|---------------------|------|
| Tran Sport Mini Van | HDPE |
| Parisienne | HDPE |
- Oldsmobile
- | | |
|---------------------|------|
| Silhouette Mini Van | HDPE |
| Custom Cruiser | HDPE |
- Buick
- | | |
|------------------------|------|
| LeSabre Estate (90-on) | HDPE |
| Roadmaster | HDPE |
- Saturn
- HDPE - all models
- (3) Chrysler Corp.
- Plymouth
- | | |
|---------------------|---------------------------------|
| Voyager Wagon | HDPE in optional 20 gallon tank |
| Trailduster (80-on) | HDPE |

Variable Name: Type of Fuel Tank-1 (Cont'd.)
Type of Fuel Tank-2 (Cont'd.)

Dodge	
Caravan Wagon	HDPE in optional 20 gallon tank
Sportsman (1980)	Optional tank was HDPE
(88-on)	HDPE
Ram Wagon (1980)	Optional tank was HDPE
(88-on)	HDPE
Tradesman (1980)	Optional tank was HDPE
(88-on)	HDPE
Ram Van (1980)	Optional tank was HDPE
(88-on)	HDPE
Ram PU (80-on)	HDPE
Power Ram PU (80-on)	HDPE
Ramcharger (80-on)	HDPE
Dakota (86-on)	HDPE
Monaco	HDPE
Eagle	
Premier (88-on)	HDPE
Jeep	
CJ5 (83-91)	Optional tank was HDPE
CJ7 (81-86)	Optional tank was HDPE
CJ8 (81-86)/Scrambler	Optional tank was HDPE
Wrangler (87-on)	Optional tank (22 gal) was HDPE
Cherokee (80-on)	HDPE
Wagoneer (80-on)	HDPE
J10, J20 PU (80-on)	HDPE
Grand Wagoneer (84-on)	HDPE
(4) Peugeot	
505	HDPE
Station Wagon	HDPE
Sedan	HDPE
(5) Volkswagen	
Golf (85-86, 89-on)	HDPE
Jetta (90-on)	HDPE
Passat (92-on)	HDPE
Corrado (89-on)	HDPE
(6) Volvo	
700 Series (85-on)	HDPE
(7) Saab	
All Models (80-on)	HDPE

Variable Name: Fuel Tank-1 Location
Fuel Tank-2 Location

Element Values:

- 0 No fuel tank
- 1 Aft of center of the rear wheels (rear axle) centered
- 2 Aft of center of the rear wheels (rear axle) left side
- 3 Aft of center of the rear wheels (rear axle) right side
- 4 Forward of center of the rear wheels (rear axle) centered
- 5 Forward of center of the rear wheels (rear axle) left side
- 6 Forward of center of the rear wheels (rear axle) right side
- 7 Over center of the rear wheels (rear axle)
- 8 Other (specify):
- 9 Unknown

Source: Vehicle Inspection

Remarks:

These variables identify the location(s) of this vehicle's fuel tank(s). Code the first and second fuel tank locations beginning from left to right in side mounted fuel tanks or front to back in fore and aft mounted fuel tanks. If the vehicle is equipped with only one fuel tank, use EV34 to specify that fuel tank's location and code "0" for EV35.

Be sure to photograph the tank and surrounding area. Refer to the NASS Photography Guideline for a detailed description of the required photographs.

Code "0" (No fuel tank) is used in variable EV35 to indicate that only one fuel tank is present.

For an electrical vehicle which uses a fossil or grain fuel back-up system, EV34 is coded "0" (No fuel tank) and EV35 is classified under codes "1" through "9" below.

When the vehicle is powered solely by electrical means, both variables EV34 and EV35 are coded "0" (No fuel tank).

Code "1" [Aft of center of the rear wheels (rear axle) centered] is used to identify fuel tanks located in back of the center of the rear wheels (rear axle) and in the center third of the vehicle (e.g., between the frame rails if present).

Code "2" [Aft of center of the rear wheels (rear axle) left side] is used to identify fuel tanks located in back of the center of the rear wheels (rear axle) and in the left third of the vehicle (e.g., between the frame rails and the outer body surface).

Code "3" [Aft of center of the rear wheels (rear axle) right side] is used to identify fuel tanks located in back of the center of the rear wheels (rear axle) and in the right third of the vehicle (e.g., between the frame rails and the outer body surface).

Variable Name: Fuel Tank-1 Location (Cont'd)
Fuel Tank-2 Location (Cont'd)

Code "4" [Forward of center of the rear wheels (rear axle) centered] is used to identify fuel tanks located in front of the center of the rear wheels (rear axle) and in the center third of the vehicle.

Code "5" [Forward of center of the rear wheels (rear axle) left side] is used to identify fuel tanks located in front of the center of the rear wheels (rear axle) and in the left third of the vehicle.

Code "6" [Forward of center of the rear wheels (rear axle) right side] is used to identify fuel tanks located in front of the center of the rear wheels (rear axle) and in the right third of the vehicle.

Code "7" [Over center of the rear wheels (rear axle)] is used when any part of the fuel tank is located over the center of the rear wheels (rear axle). This code takes priority over codes 1-6.

Code "8" [Other (specify)] is used when the fuel tank is in a location other than as specified in codes "1" through "7" above. Included in this code are fuel tanks located inside the passenger compartment, trunk, cargo area, pickup bed, etc. The location is specified in the space provided.

Code "9" (Unknown) is used when:

- The vehicle was totally destroyed, or
- the fuel tank location can not be determined and an exemplar vehicle can not be located.

Variable Name: Fuel Tank-1 Filler Cap Location
Fuel Tank-2 Filler Cap Location

Element Values:

- 0 No fuel tank
- 1 On back plane
- 2 Aft of center of the rear wheels (rear axle) on left side plane
- 3 Aft of center of the rear wheels (rear axle) on right side plane
- 4 Forward of center of the rear wheels (rear axle) on left side plane
- 5 Forward of center of the rear wheels (rear axle) on right side plane
- 6 Over the center of the rear wheels (rear axle) on left side plane
- 7 Over the center of the rear wheels (rear axle) on right side plane
- 8 Other (specify):
- 9 Unknown

Source: Vehicle Inspection

Remarks:

These variables identify the location(s) of the fuel tank filler cap in its original undamaged position on the vehicle. Code the first and second fuel tank filler cap locations beginning from left to right or front to back. If the vehicle is equipped with only one filler cap use EV36 to specify the fuel tank filler cap location and use code "0" for variable EV37.1

Be sure to photograph the tank and surrounding area. Refer to the NASS Photography Guideline for a detailed description of the required photographs.

Code "0" (No fuel tank) is used in variable EV37 to indicate that only one fuel tank is present.

For an electrical vehicle which uses a fossil or grain fuel back-up system, EV36 is coded "0" (No fuel tank) and EV37 is classified under codes "1" through "9" below.

When the vehicle is powered solely by electrical means, both variables EV36 and EV37 are coded "0" (No fuel tank).

Code "1" (On back plane) is used when the fuel tank filler cap is located behind the center of the rear wheels (rear axle) on the back plane.

Code "2" [Aft of center of the rear wheels (rear axle) on left side plane] is used when the fuel tank filler cap is located behind the center of the rear wheels (rear axle) and on the left side.

Code "3" [Aft of center of the rear wheels (rear axle) on right side plane] is used when the fuel tank filler cap is located behind the center of the rear wheels (rear axle) and on the right side.

Variable Name: Fuel Tank-1 Filler Cap Location (Cont'd)
Fuel Tank-2 Filler Cap Location (Cont'd)

- Code "4" [Forward of center of the rear wheels (rear axle) on left side plane] is used when the fuel tank filler cap is located in front of the center of the rear wheels (rear axle) on the left side plane.
- Code "5" [Forward of center of the rear wheels (rear axle) on right side plane] is used when the fuel tank filler cap is located in front of the center of the rear wheel(s) (rear axle) on the right side plane.
- Code "6" [Over the center of the rear wheels (rear axle) on left side plane] is used when any part of the fuel tank filler cap is located over the center of the rear wheels (rear axle) on the left side plane. This code takes precedence over codes "1"- "5".
- Code "7" [Over the center of the rear wheels (rear axle) on right side plane] is used when any part of the filler cap is located over the center of the rear wheels (rear axle) on the right side plane. This code takes precedence over codes "1"- "5".
- Code "8" [Other (specify)] is used when the fuel tank filler cap is in a location other than as specified in choices "1" through "7" above. The location is specified in the space provided.
- Code "9" (Unknown) is used when:
- The vehicle was totally destroyed, or
 - the fuel tank filler cap location can not be determined and an exemplar vehicle can not be located.

Variable Name: Fuel Tank-1 Damage
Fuel Tank-2 Damage

Element Values:

- 0 No fuel tank
- 1 No damage to fuel tank
- 2 Deformed, no seam failure
- 3 Deformed, with a seam failure
- 4 Punctured
- 5 Lacerated (ripped)
- 6 Abraded (scraped)
- 7 Filler neck separation from the fuel tank
- 8 Other damage (specify):
- 9 Unknown

Source: Vehicle Inspection

Remarks:

These variables record the damage to the fuel tank(s) that occurred during the sequence of crash events. The objective of these variables is to identify damage to the fuel tank(s) that may or may not result in a loss of fuel system integrity. If the fuel tank(s) has more than one form of damage, code the damage that resulted in a fuel system integrity loss. If there were multiple types of integrity loss then select the first code which applies from the following prioritized list: codes "3", "4", "5", "6", "7", and "8". If there are multiple forms of damage and no fuel system integrity loss, then code according to the following prioritized list: Codes "2", "6", and "8".

Be sure to photograph the tank and surrounding area. Refer to the NASS Photography Guideline for a detailed description of the required photographs.

Code the first and second tank locations beginning from left to right side mounted tanks or front to back in forward and rearward mounted tanks. If the vehicle is equipped with only one fuel tank, use EV38 to specify the damage to the fuel tank and use code "0" for variable EV39.

In addition, annotate the pre-crash condition of the fuel tank on page 5 of the Exterior Vehicle Form in the area set aside for notes (i.e. corroded, leaking, etc).

Code "0" (No fuel tank) is used in variable EV39 to indicate that only one fuel tank is present.

For an electrical vehicle which uses a fossil or grain fuel back-up system, EV38 is coded "0" (No fuel tank) and EV39 is classified under codes "1" through "9" below.

When the vehicle is powered solely by electrical means, both variables EV38 and EV39 are coded "0" (No fuel tank).

Variable Name: Fuel Tank-1 Damage (Cont'd)
Fuel Tank-2 Damage (Cont'd)

Code "1" (No damage to fuel tank) is used when the fuel tank is not damaged during the sequence of crash events.

Code "2" (Deformed, no seam failure) is used when the fuel tank was deformed or crushed during the crash and the seam did not fail. Tanks which do not have a seam(s) (e.g., extruded fuel tanks such as high density polyethylene HDPE) should be evaluated for deformation and encoded under this attribute if applicable.

Code "3" (Deformed, with a seam failure) is used when the fuel tank was deformed or crushed during the crash and the seam failed. Single piece extruded tanks (i.e. no seams) which experience integrity loss are not coded here .

Code "4" (Punctured) is used when the fuel tank was punctured, perforated or pierced during the collision sequence.

Code "5" [Lacerated (ripped)] is used when the fuel tank was lacerated, cut, sliced, ripped or torn during the collision sequence.

Code "6" [Abraded (scraped)] is used when the fuel tank was abraded or scraped during the collision sequence.

Code "7" (Filler neck separation from the fuel tank) is used when the filler neck was separated from the fuel tank during the collision sequence.

Code "8" [Other damage (specify)] is used when damage to the fuel tank can not be described in codes "1"-"9".

Code "9" (Unknown) is used when:

- The vehicle was totally destroyed, or
- the fuel tank damage can not be determined.

Variable Name: Location of Fuel System-1 Leakage
Location of Fuel System-2 Leakage

Element Values:

- 0 No fuel tank
- 1 No fuel leakage

Primary Area Of Leakage

- 2 Tank
- 3 Filler neck
- 4 Cap
- 5 Lines/pump/filter
- 6 Vent/emission recovery
- 8 Other (specify):
- 9 Unknown

Source: Vehicle Inspection

Remarks:

These variables provide information on fuel retention by the fuel system during the crash sequence. The objective of these variables is to report fuel system leakage. If the fuel system has leakage from more than one source, code the leakage that resulted in a fire. If there are multiple areas of leakage and no fire, then code the most severe area of leakage. If the severity can not be determined, then use codes "2" through "8" in the priority listed.

Be sure to photograph the area of leakage and surrounding area(s). Refer to the NASS Photography Guideline for a detailed description of the required photographs.

Code the first and second location(s) of fuel system leakage beginning from left to right in side mounted fuel tanks or front to back in fore and aft mounted fuel tanks. If the vehicle is equipped with only one fuel tank, use EV40 to specify the location of the fuel system and use code "0" for variable EV41.

If the fuel system was leaking prior to the collision, (i.e., corrosion to tank, loose fuel line, etc.) annotate the information in the notes section on page 5 of the Exterior Vehicle Form.

Code "0" (No fuel tank) is used in variable EV40 to indicate that only one fuel tank is present.

For an electrical vehicle which uses a fossil or grain fuel back-up system, EV40 is coded "0" (No fuel tank) and EV41 is classified under codes "1" through "9" below.

When the vehicle is powered solely by electrical means, both variables EV40 and EV41 are coded "0" (No fuel tank).

Variable Name: Location of Fuel System-1 Leakage (Cont'd)
Location of Fuel System-2 Leakage (Cont'd)

Code "1" (No fuel leakage) is used when there has been no loss in fuel retention.

Code "2" (Tank) is used when the fuel tank was leaking as a result of an impact during the crash sequence. Also use this code when leakage occurs as a result of all the filler neck separating from the fuel tank.

Code "3" (Filler Neck) is used when the filler neck is the source of fuel leakage as a result of an impact during the crash sequence.

Code "4" (Cap) is used when the mouth of the filler neck or the filler cap is the source of fuel leakage that occurred as a result of damage from an impact during this vehicle's crash sequence.

Code "5" (Lines/pump/filter) is used when fuel was leaking from the fuel system lines, pump and/or fuel filter as a result of an impact during the crash sequence. If the vehicle is equipped with more than one fuel system line, pump or filter, code the location of the leakage to the applicable system. If the fuel systems are interconnected, code the first system that applies.

Code "6" (Vent/emission recovery) is used when fuel was leaking from the vent or emission recovery system as a result of an impact during the crash sequence.

Code "8" [Other (specify)] is used when fuel was leaking, as a result of the crash, from other than the sources specified in codes "2" through "6" above.

Code "9" (Unknown) is used when:

- The vehicle was totally destroyed in the crash and it cannot be determined if the fuel system experienced any leakage, or
- The source of the fuel system leakage could not be determined,

Variable Name: Fuel Type-1
Fuel Type-2

Element Values:

Single Fuel Type

- 00 No fuel tank
- 01 Gasoline
- 02 Diesel
- 03 CNG (Compressed Natural Gas)
- 04 LPG (Liquid Petroleum Gas) also known as Propane
- 05 LNG (Liquid Natural Gas)
- 06 Methanol (M100 or M85)
- 07 Ethanol (E100 or E85)
- 08 Other (Hydrogen or others) (specify):

*Electric Powered or Electric/Solar
Powered Vehicles*

- 10 Lead Acid Battery
- 11 Nickel-Iron Battery
- 12 Nickel-Cadmium Battery
- 13 Sodium Metal Chloride Battery
- 14 Sodium Sulfur Battery
- 18 Other (Specify):
- 98 Other Hybrid (specify):
- 99 Unknown fuel type

Source: Primary source is the vehicle inspection; secondary source is the interviewee(s).

Remarks:

These variables record the fuel type available in each fuel system during this crash sequence. The type of fuel the engine was operating on will normally be indicated on the vehicle. Typical locations include but are limited to fuel door, filler cap, fuel gauge and vehicle owner's manual.

Code "98" [Other hybrid (specify)] is used when the vehicle is powered by an alternative energy source such as a "flywheel" technology.

Code "99" (Unknown fuel type) is used when:

- The vehicle was totally destroyed, or
- the fuel type can not be determined.

Variable Name: Is This Vehicle Equipped With More Than Two Fuel Tanks?

Element Values:

0 No (one or two tanks only)

Yes - More Than Two Tanks

1 Yes -- no damage to any tank or filler cap and no fuel system leakage

2 Yes -- no damage to any tank or filler cap but there is fuel system leakage (specify leakage location):

3 Yes -- damage to an additional tank or filler cap and there is fuel system leakage(specify the following):

Type of tank _____

Tank location _____

Filler cap location _____

Tank damage _____

Location of leakage _____

Type of fuel _____

9 Unknown if more than two tanks

Source: Vehicle Inspection

Remarks:

Some vehicles may be equipped with more than two fuel tanks.

Code "0" [No (one or two tanks only)] is used when a vehicle is not equipped with more than two fuel tanks.

Code "1" (Yes -- no damage to any tank or filler cap and no fuel system leakage) is used when a vehicle is equipped with more than two fuel tanks and there is no damage to any tank or filler cap and no fuel system leakage.

Code "2" [Yes -- no damage to any tank or filler cap but there is fuel system leakage (specify leakage location)] is used when a vehicle is equipped with more than two fuel tanks and there is no damage to any tank or filler cap but fuel was leaking from the fuel system.

Code "3" [Yes -- damage to an additional tank or filler cap and there is fuel system leakage (specify the following)] is used when a vehicle is equipped with more than two fuel tanks and there is damage to at least one additional tank or filler cap and fuel was leaking from the fuel system. Specify the location of the fuel tank, filler cap, type of tank, damage, leakage and type of fuel.

Code "9" (Unknown if more than two tanks) is used when:

- The vehicle was totally destroyed, or
- the researcher is unable to determine if the vehicle is equipped with more than two fuel tanks.



INTERIOR VEHICLE FORM

1. Primary Sampling Unit Number _____
2. Case Number - Stratum _____
3. Vehicle Number _____

INTEGRITY

4. Passenger Compartment Integrity _____
(00) No integrity loss

Yes, Integrity Was Lost Through
(01) Windshield
(02) Door (side)
(03) Door/hatch (back door)
(04) Roof
(05) Roof glass
(06) Side window
(07) Rear window (backlight)
(08) Roof and roof glass
(09) Windshield and door (side)
(10) Windshield and roof
(11) Side and rear window (side window and backlight)
(12) Windshield and side window
(13) Door and side window
(98) Other combination of above (specify): _____
(99) Unknown

Door, Tailgate or Hatch Opening

5. LF _____ 6. RF _____ 7. LR _____ 8. RR _____ 9. TG/H _____

(0) No door/gate/hatch
(1) Door/gate/hatch remained closed and operational
(2) Door/gate/hatch came open during collision
(3) Door/gate/hatch jammed shut
(8) Other (specify): _____
(9) Unknown

Damage/Failure Associated with Door, Tailgate or Hatch Opening in Collision. If IV05-IV09 ≠ 2, Then code 0

10. LF _____ 11. RF _____ 12. LR _____ 13. RR _____ 14. TG/H _____

(0) No door/gate/hatch or door not opened

Door, Tailgate or Hatch Came Open During Collision
(1) Door operational (no damage)
(2) Latch/striker failure due to damage
(3) Hinge failure due to damage
(4) Door structure failure due to damage
(5) Door support (i.e., pillar, sill, roof side rail, etc.) failure due to damage
(6) Latch/striker and hinge failure due to damage
(8) Other failure (specify): _____
(9) Unknown

GLAZING

Glazing Damage from Impact Forces

15. WS _____ 16. LF _____ 17. RF _____ 18. LR _____ 19. RR _____
20. BL _____ 21. Roof _____ 22. Other _____

(0) No glazing damage from impact forces
(2) Glazing in place and cracked from impact forces
(3) Glazing in place and holed from impact forces
(4) Glazing out-of-place (cracked or not) and not holed from impact forces
(5) Glazing out-of-place and holed from impact forces
(6) Glazing disintegrated from impact forces
(7) Glazing removed prior to accident
(8) No glazing
(9) Unknown if damaged

Glazing Damage from Occupant Contact

23. WS _____ 24. LF _____ 25. RF _____ 26. LR _____ 27. RR _____
28. BL _____ 29. Roof _____ 30. Other _____

(0) No occupant contact to glazing or no glazing
(1) Glazing contacted by occupant but no glazing damage
(2) Glazing in place and cracked by occupant contact
(3) Glazing in place and holed by occupant contact
(4) Glazing out-of-place (cracked or not) by occupant contact and not holed by occupant contact
(5) Glazing out-of-place by occupant contact and holed by occupant contact
(6) Glazing disintegrated by occupant contact
(9) Unknown if contacted by occupant

If No Glazing Damage *And* No Occupant Contact or No Glazing, Then Code IV31 Through IV46 As 0

Type of Window/Windshield Glazing

31. WS _____ 32. LF _____ 33. RF _____ 34. LR _____ 35. RR _____
36. BL _____ 37. Roof _____ 38. Other _____

(0) No glazing contact and no damage, or no glazing
(1) AS-1 - Laminated
(2) AS-2 - Tempered
(3) AS-3 - Tempered-tinted
(4) AS-14 - Glass/Plastic
(8) Other (specify): _____
(9) Unknown

Window Precrash Glazing Status

39. WS _____ 40. LF _____ 41. RF _____ 42. LR _____ 43. RR _____
44. BL _____ 45. Roof _____ 46. Other _____

(0) No glazing contact and no damage, or no glazing
(1) Fixed
(2) Closed
(3) Partially opened
(4) Fully opened
(9) Unknown

INTRUSION WORKSHEET

Note: Sketch intruded areas

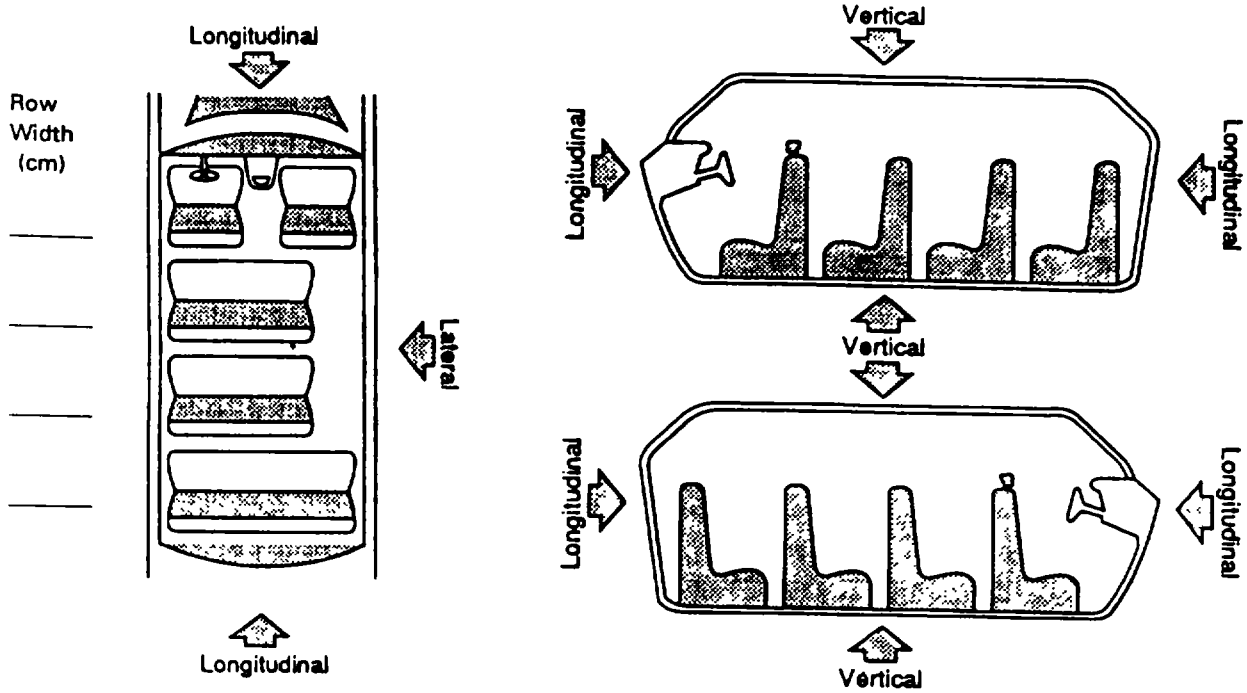

LOCATION OF INTRUSION	INTRUDED COMPONENT	(All Measurements Are In Centimeters)			DOMINANT CRUSH DIRECTION
		COMPARISON VALUE	INTRUDED VALUE	INTRUSION	
		-	=		
		-	=		
		-	=		
		-	=		
		-	=		
		-	=		
		-	=		
		-	=		
		-	=		
		-	=		
		-	=		
		-	=		
		-	=		
		-	=		
		-	=		
		-	=		
		-	=		
		-	=		
		-	=		
		-	=		
		-	=		

OCCUPANT AREA INTRUSION

Note: If no intrusions, leave variables IV47-IV86 blank.

	Location of Intrusion	Intruding Component	Magnitude of Intrusion	Dominant Crush Direction
1st	47. _____	48. _____	49. _____	50. _____
2nd	51. _____	52. _____	53. _____	54. _____
3rd	55. _____	56. _____	57. _____	58. _____
4th	59. _____	60. _____	61. _____	62. _____
5th	63. _____	64. _____	65. _____	66. _____
6th	67. _____	68. _____	69. _____	70. _____
7th	71. _____	72. _____	73. _____	74. _____
8th	75. _____	76. _____	77. _____	78. _____
9th	79. _____	80. _____	81. _____	82. _____
10th	83. _____	84. _____	85. _____	86. _____

INTRUDING COMPONENT

Interior Components

- (01) Steering assembly
- (02) Instrument panel left
- (03) Instrument panel center
- (04) Instrument panel right
- (05) Toe pan
- (06) A (A1/A2)-pillar
- (07) B-pillar
- (08) C-pillar
- (09) D-pillar
- (10) Door panel (side)
- (12) Roof (or convertible top)
- (13) Roof side rail
- (14) Windshield
- (15) Windshield header
- (16) Window frame
- (17) Floor pan (includes sill)
- (18) Backlight header
- (19) Front seat back
- (20) Second seat back
- (21) Third seat back
- (22) Fourth seat back
- (23) Fifth seat back
- (24) Seat cushion
- (25) Back door/panel (e.g., tailgate)
- (26) Other interior component (specify): _____

- (27) Side panel - forward of the A (A2)-pillar
- (28) Side panel - rear of the A (A2)-pillar

Exterior Components

- (30) Hood
- (31) Outside surface of this vehicle (specify): _____
- (32) Other exterior object in the environment (specify): _____
- (33) Unknown exterior object
- (97) Catastrophic
- (98) Intrusion of unlisted component(s) (specify): _____
- (99) Unknown

LOCATION OF INTRUSION

- Front Seat
- (11) Left
 - (12) Middle
 - (13) Right

- Second Seat
- (21) Left
 - (22) Middle
 - (23) Right

- Third Seat
- (31) Left
 - (32) Middle
 - (33) Right

- Fourth Seat
- (41) Left
 - (42) Middle
 - (43) Right

- (97) Catastrophic
- (98) Other enclosed area (specify) _____

- (99) Unknown

MAGNITUDE OF INTRUSION

- (1) ≥ 3 centimeters but < 8 centimeters
- (2) ≥ 8 centimeters but < 15 centimeters
- (3) ≥ 15 centimeters but < 30 centimeters
- (4) ≥ 30 centimeters but < 46 centimeters
- (5) ≥ 46 centimeters but < 61 centimeters
- (6) ≥ 61 centimeters
- (7) Catastrophic
- (9) Unknown

DOMINANT CRUSH DIRECTION

- (1) Vertical
- (2) Longitudinal
- (3) Lateral
- (7) Catastrophic
- (9) Unknown

STEERING RIM/SPOKE DEFORMATION

(All Measurements Are in Centimeters)

COMPARISON VALUE	—	DAMAGE VALUE	=	DEFORMATION
------------------	---	--------------	---	-------------

	—		=	
--	---	--	---	--

	—		=	
--	---	--	---	--

	—		=	
--	---	--	---	--

	—		=	
--	---	--	---	--

STEERING COLUMN

87. Steering Column Type _____
 (1) Fixed column
 (2) Tilt column
 (3) Telescoping column
 (4) Tilt and telescoping column
 (8) Other column type (specify): _____
 (9) Unknown _____

88. Blank _____ X X
 (This variable is left blank so that numbering consistency can be maintained with the 1988-94 CDS.)

89. Blank _____ X X X
 (This variable is left blank so that numbering consistency can be maintained with the 1988-94 CDS.)

90. Blank _____ X X X
 (This variable is left blank so that numbering consistency can be maintained with the 1988-94 CDS.)

91. Blank _____ X X X
 (This variable is left blank so that numbering consistency can be maintained with the 1988-94 CDS.)

92. Steering Rim/Spoke Deformation _____
 _____ Code actual measured
 deformation to the nearest centimeter
 (00) No steering rim deformation
 (01-14) Actual measured value in centimeters
 (15) 15 centimeters or more
 (98) Observed deformation cannot be measured
 (99) Unknown

93. Location of Steering Rim/Spoke Deformation _____
 (00) No steering rim deformation

Quarter Sections
 (01) Section A
 (02) Section B
 (03) Section C
 (04) Section D



Half Sections
 (05) Upper half of rim/spoke
 (06) Lower half of rim/spoke
 (07) Left half of rim/spoke
 (08) Right half of rim/spoke

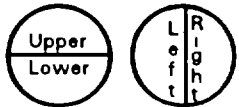

(09) Complete steering wheel collapse
 (10) Undetermined location
 (99) Unknown

INSTRUMENT PANEL

94. Odometer Reading _____,000
 _____ kilometers—Code to the nearest 1,000 kilometers
 (000) No odometer
 (001) Less than 1,500 kilometers
 (500) 499,500 kilometers or more
 (999) Unknown

_____ miles X 1.6093 = _____ kilometers

Source: _____

95. Instrument Panel Damage from Occupant Contact? _____
 (0) No
 (1) Yes
 (9) Unknown

96. Knee Bolsters Deformed from Occupant Contact? _____
 (0) No
 (1) Yes
 (8) Not present
 (9) Unknown

97. Did Glove Compartment Door Open During Collision(s)? _____
 (0) No
 (1) Yes
 (8) Not present
 (9) Unknown

VEHICLE INTERIOR SKETCHES

Note area of ejection/entrapment

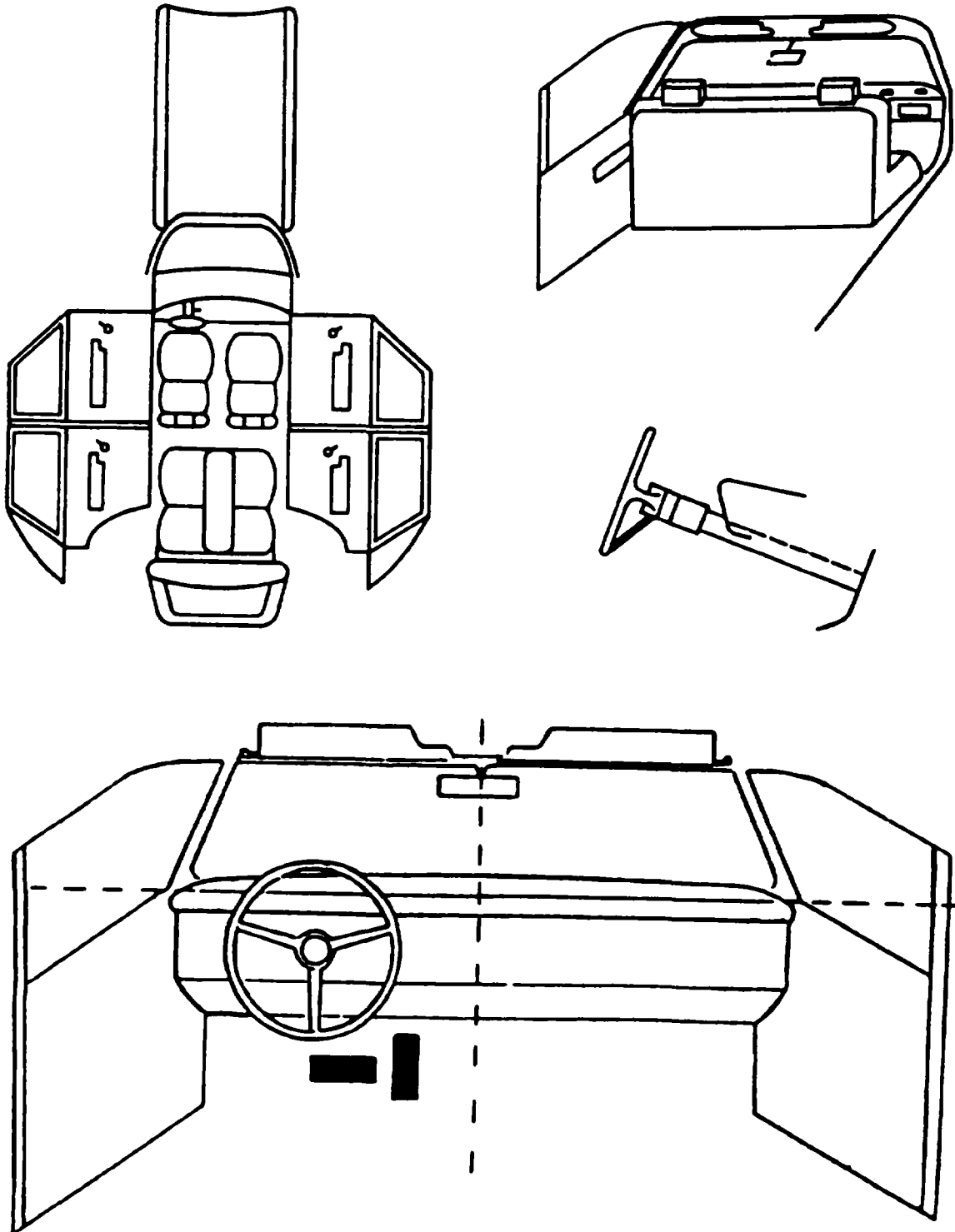

Sketch windshield contact(s) and the damaged area(s) on the instrument panel outline (e.g., radio, glove compartment, damage to instrument panel structure).

Cross hatch contact points, draw spider webs or use other annotation as may be appropriate.

Annotate the contacted area with a letter (begin with A) and list on the Points of Occupant Contact page.

POINTS OF OCCUPANT CONTACT

Contact	Interior Component Contacted	Occupant No. If Known	Body Region If Known	Supporting Physical Evidence	Confidence Level of Contact Point
A					
B					
C					
D					
E					
F					
G					
H					
I					
J					
K					
L					
M					
N					

CODES FOR INTERIOR COMPONENTS

FRONT

- (01) Windshield
- (02) Mirror
- (03) Sunvisor
- (04) Steering wheel rim
- (05) Steering wheel hub/spoke
- (06) Steering wheel (combination of codes 04 and 05)
- (07) Steering column, transmission selector lever, other attachment
- (08) Add on equipment (e.g., CB, tape deck, air conditioner)
- (09) Left instrument panel and below
- (10) Center instrument panel and below
- (11) Right instrument panel and below
- (12) Glove compartment door
- (13) Knee bolster
- (14) Windshield including one or more of the following: front header, A (A1/A2)-pillar, instrument panel, mirror, or steering assembly (driver side only)
- (15) Windshield including one or more of the following: front header, A (A1/A2)-pillar, instrument panel, or mirror (passenger side only)
- (16) Driver side air bag compartment cover
- (17) Passenger side air bag compartment cover
- (18) Windshield reinforced by exterior object (specify): _____
- (19) Other front object (specify): _____

LEFT SIDE

- (20) Left side interior surface, excluding hardware or armrests
- (21) Left side hardware or armrest
- (22) Left A (A1/A2)-pillar

- (23) Left B-pillar
- (24) Other left pillar (specify): _____
- (25) Left side window glass or frame
- (26) Left side window glass including one or more of the following: frame, window sill, A (A1/A2)-pillar, B-pillar, or roof side rail.
- (27) Other left side object (specify): _____
- (28) Left side window sill

RIGHT SIDE

- (30) Right side interior surface, excluding hardware or armrests
- (31) Right side hardware or armrest
- (32) Right A (A1/A2)-pillar
- (33) Right B-pillar
- (34) Other right pillar (specify): _____
- (35) Right side window glass or frame
- (36) Right side window glass including one or more of the following: frame, window sill, A (A1/A2)-pillar, B pillar, or roof side rail.
- (37) Other right side object (specify): _____
- (38) Right side window sill

INTERIOR

- (40) Seat, back support
- (41) Belt restraint webbing/buckle
- (42) Belt restraint B-pillar attachment point
- (43) Other restraint system component (specify): _____
- (44) Head restraint system
- (45) Air bag (use codes "16" and "17" for injuries sustained from air bag compartment covers)

- (46) Other occupants (specify): _____
- (47) Interior loose objects
- (48) Child safety seat (specify): _____
- (49) Other interior object (specify): _____

ROOF

- (50) Front header
- (51) Rear header
- (52) Roof left side rail
- (53) Roof right side rail
- (54) Roof or convertible top

FLOOR

- (56) Floor (including toe pan)
- (57) Floor or console mounted transmission lever, including console
- (58) Parking brake handle
- (59) Foot controls including parking brake

REAR

- (60) Backlight (rear window)
- (61) Backlight storage rack, door, etc.
- (62) Other rear object (specify): _____

CONFIDENCE LEVEL OF CONTACT POINT

- (1) Certain
- (2) Probable
- (3) Possible
- (9) Unknown

AUTOMATIC RESTRAINTS

NOTES: Encode the data for each applicable front seat position. The attribute for the variables may be found below. Restraint systems should be assessed during the vehicle inspection then coded on the Occupant Assessment Form.

AIR BAGS

		Left	Right
F I R S T	Availability/Function		
	Deployment		
	Failure		

Air Bag System Availability/Function

- (0) Not equipped/not available
- (1) Air bag
- Non-functional*
- (2) Air bag disconnected (specify): _____
- (3) Air bag not reinstalled
- (9) Unknown

Air Bag System Deployment

- (0) Not equipped/not available
- (1) Air bag deployed during accident (as a result of impact)
- (2) Air bag deployed inadvertently just prior to accident
- (3) Air bag deployed, accident sequence undetermined
- (4) Nondeployed
- (5) Unknown if deployed
- (6) Air bag deployed as a result of a noncollision event during accident sequence (e.g., fire, explosion, electrical)
- (9) Unknown

Are There Indications of Air Bag System Failure?

- (0) Not equipped/not available
- (1) No
- (2) Yes (specify): _____
- (9) Unknown

AUTOMATIC BELTS

		Left	Right
F I R S T	Availability/Function		
	Use		
	Type		
	Proper Use		
	Failure Modes		

Automatic (Passive) Belt System Availability/Function

- (0) Not equipped/not available
- (1) 2 point automatic belts
- (2) 3 point automatic belts
- (3) Automatic belts - type unknown
- Non-functional*
- (4) Automatic belts destroyed or rendered inoperative
- (9) Unknown

Automatic (Passive) Belt System Use

- (0) Not equipped/not available/destroyed or rendered inoperative
- (1) Automatic belt in use
- (2) Automatic belt not in use (manually disconnected, motorized track inoperative)
- (3) Automatic belt use unknown
- (9) Unknown

Automatic (Passive) Belt System Type

- (0) Not equipped/not available
- (1) Non-motorized system
- (2) Motorized system
- (9) Unknown

Proper Use of Automatic (Passive) Belt System

- (0) Not equipped/not available/not used
- (1) Automatic belt used properly
- (2) Automatic belt used properly with child safety seat
- Automatic Belt Used Improperly*
- (3) Automatic shoulder belt worn under arm
- (4) Automatic shoulder belt worn behind back
- (5) Automatic belt worn around more than one person
- (6) Lap portion of automatic belt worn on abdomen
- (7) Automatic lap and shoulder belt or automatic shoulder belt used improperly with child safety seat (specify): _____
- (8) Other improper use of automatic belt system (specify): _____
- (9) Unknown

Automatic (Passive) Belt Failure Modes During Accident

- (0) Not equipped/not available/not in use
- (1) No automatic belt failure(s)
- (2) Torn webbing (stretched webbing not included)
- (3) Broken buckle or latchplate
- (4) Upper anchorage separated
- (5) Other anchorage separated (specify): _____
- (6) Broken retractor
- (7) Combination of above (specify): _____
- (8) Other automatic belt failure (specify): _____
- (9) Unknown

MANUAL RESTRAINTS

NOTES: Encode the applicable data for each seat position in the vehicle. The attribute for the variable may be found below. Restraint systems should be assessed during the vehicle inspection then coded on the Occupant Assessment Form.

If a Child safety seat is present, encode the data on the back of this page.

If the vehicle has automatic restraints available, encode the appropriate data on the back of the previous page.

		Left	Center	Right
F I R S T	Availability			
	Evidence of usage			
	Used in this crash?			
	Proper Use			
	Failure Modes			
S E C O N D	Availability			
	Evidence of usage			
	Used in this crash?			
	Proper Use			
	Failure Modes			
O T H E R	Availability			
	Evidence of usage			
	Used in this crash?			
	Proper Use			
	Failure Modes			

Manual (Active) Belt System Availability

- (0) None available
- (1) Belt removed/destroyed
- (2) Shoulder belt
- (3) Lap belt
- (4) Lap and shoulder belt
- (5) Belt available - type unknown

Integral Belt Partially Destroyed

- (6) Shoulder belt (lap belt destroyed/removed)
- (7) Lap belt (shoulder belt destroyed/removed)

(8) Other belt (specify): _____

(9) Unknown

Manual (Active) Belt System Use

- (00) None used, not available, or belt removed/destroyed
- (01) Inoperable (specify): _____

- (02) Shoulder belt
- (03) Lap belt
- (04) Lap and shoulder belt
- (05) Belt used - type unknown
- (08) Other belt used (specify): _____

- (12) Shoulder belt used with child safety seat
- (13) Lap belt used with child safety seat
- (14) Lap and shoulder belt used with child safety seat
- (15) Belt used with child safety seat - type unknown
- (18) Other belt used with child safety seat (specify): _____
- (99) Unknown if belt used

Proper Use of Manual (Active) Belts

- (0) None used or not available
- (1) Belt used properly
- (2) Belt used properly with child safety seat

Belt Used Improperly

- (3) Shoulder belt worn under arm
- (4) Shoulder belt worn behind back or seat
- (5) Belt worn around more than one person
- (6) Lap belt worn on abdomen
- (7) Lap belt or lap and shoulder belt used improperly with child safety seat (specify): _____

(8) Other improper use of manual belt system (specify): _____

(9) Unknown

Manual (Active) Belt Failure Modes During Accident

- (0) No manual belt used or not available
- (1) No manual belt failure(s)
- (2) Torn webbing (stretched webbing not included)
- (3) Broken buckle or latchplate
- (4) Upper anchorage separated
- (5) Other anchorage separated (specify): _____

- (6) Broken retractor
- (7) Combination of above (specify): _____

(8) Other manual belt failure (specify): _____

(9) Unknown

CHILD SAFETY SEAT FIELD ASSESSMENT

When a child safety seat is present enter the occupant's number in the first row and complete the column below the occupant's number using the codes listed below. Complete a column for each child safety seat present.

Occupant Number						
1. Type of Child Safety Seat						
2. Child Safety Seat Orientation						
3. Child Safety Seat Harness Usage						
4. Child Safety Seat Shield Usage						
5. Child Safety Seat Tether Usage						
6. Child Safety Seat Make/Model	Specify Below for Each Child Safety Seat					

1. Type of Child Safety Seat

- (0) No child safety seat
- (1) Infant seat
- (2) Toddler seat
- (3) Convertible seat
- (4) Booster seat
- (7) Other type child safety seat (specify): _____
- (8) _____ Unknown child safety seat type
- (9) Unknown if child safety seat used

2. Child Safety Seat Orientation

- (00) No child safety seat
- Designed for Rear Facing for This Age/Weight
- (01) Rear facing
- (02) Forward facing
- (08) Other orientation (specify): _____
- (09) _____ Unknown orientation

Designed for Forward Facing for This Age/Weight

- (11) Rear facing
- (12) Forward facing
- (18) Other orientation (specify): _____
- (19) _____ Unknown orientation

Unknown Design or Orientation For This Age/Weight, or Unknown Age/Weight

- (21) Rear facing
- (22) Forward facing
- (28) Other orientation (specify): _____
- (29) _____ Unknown orientation
- (99) Unknown if child safety seat used

3. Child Safety Seat Harness Usage

4. Child Safety Seat Shield Usage

5. Child Safety Seat Tether Usage

Note: Options Below Are Used for Variables 3-5.

- (00) No child safety seat
- Not Designed with Harness/Shield/Tether
- (01) After market harness/shield/tether added, not used
- (02) After market harness/shield/tether used
- (03) Child safety seat used, but no after market harness/shield/tether added
- (09) Unknown if harness/shield/tether added or used

Designed With Harness/Shield/Tether

- (11) Harness/shield/tether not used
- (12) Harness/shield/tether used
- (19) Unknown if harness/shield/tether used

Unknown If Designed With Harness/Shield/Tether

- (21) Harness/shield/tether not used
- (22) Harness/shield/tether used
- (29) Unknown if harness/shield/tether used

- (99) Unknown if child safety seat used

6. Child Safety Seat Make/Model

(Specify make/model and occupant number)

HEAD RESTRAINTS/SEAT EVALUATION

NOTES: Encode the applicable data for each seat position in the vehicle. The attribute for these variables may be found at the bottom of the page. Head restraint type/damage and seat type/performance should be assessed during the vehicle inspection then coded on the Occupant Assessment Form.

		Left	Center	Right
F I R S T	Head Restraint Type/Damage			
	Seat Type			
	Seat Performance			
	Seat Orientation			
S E C O N D	Head Restraint Type/Damage			
	Seat Type			
	Seat Performance			
	Seat Orientation			
T H I R D	Head Restraint Type/Damage			
	Seat Type			
	Seat Performance			
	Seat Orientation			
O T H E R	Head Restraint Type/Damage			
	Seat Type			
	Seat Performance			
	Seat Orientation			

Head Restraint Type/Damage by Occupant at This Occupant Position

- (0) No head restraints
- (1) Integral – no damage
- (2) Integral – damaged during accident
- (3) Adjustable – no damage
- (4) Adjustable – damaged during accident
- (5) Add-on – no damage
- (6) Add-on – damaged during accident
- (8) Other Specify: _____
- (9) Unknown

Seat Type (this Occupant Position)

- (00) Occupant not seated or no seat
- (01) Bucket
- (02) Bucket with folding back
- (03) Bench
- (04) Bench with separate back cushions
- (05) Bench with folding back(s)
- (06) Split bench with separate back cushions
- (07) Split bench with folding back(s)
- (08) Pedestal (i.e., column supported)
- (09) Other seat type (specify): _____
- (10) Box mounted seat (i.e., van type)
- (99) Unknown

Seat Performance (this Occupant Position)

- (0) Occupant not seated or no seat
- (1) No seat performance failure(s)
- (2) Seat adjusters failed
- (3) Seat back folding locks or "seat back" failed specify: _____
- (4) Seat tracks/anchors failed
- (5) Deformed by impact of occupant
- (6) Deformed by passenger compartment intrusion (specify): _____
- (7) Combination of above (specify): _____
- (8) Other (specify): _____
- (9) Unknown

Seat Orientation (this Occupant Position)

- (0) Occupant not seated or no seat
- (1) Forward facing seat
- (2) Rear facing seat
- (3) Side facing seat (inward)
- (4) Side facing seat (outward)
- (8) Other (specify): _____
- (9) Unknown

DESCRIBE ANY INDICATION OF ABNORMAL OCCUPANT POSTURE (I.E., UNUSUAL OCCUPANT CONTACT PATTERN)

EJECTION/ENTRAPMENT DATA

Complete the following if the researcher has any indication that an occupant was either ejected from or entrapped in the vehicle. Code the appropriate data on the Occupant Assessment Form.

EJECTION No [] Yes []

Describe indications of ejection and body parts involved in partial ejection(s):

Occupant Number						
Ejection						
(Note on Vehicle Interior Sketch) Ejection Area						
Ejection Medium						
Medium Status						

Ejection

- (1) Complete ejection
- (2) Partial ejection
- (3) Ejection, Unknown degree
- (9) Unknown

Ejection Area

- (1) Windshield
- (2) Left front
- (3) Right front
- (4) Left rear
- (5) Right rear
- (6) Rear

(7) Roof

- (8) Other area (e.g., back of pickup, etc.) (specify): _____
- (9) Unknown

Ejection Medium

- (1) Door/hatch/tailgate
- (2) Nonfixed roof structure
- (3) Fixed glazing
- (4) Nonfixed glazing (specify): _____

(5) Integral structure

- (8) Other medium (specify): _____
- (9) Unknown

Medium Status (Immediately Prior to Impact)

- (1) Open
- (2) Closed
- (3) Integral structure
- (9) Unknown

ENTRAPMENT No [] Yes []

Describe entrapment mechanism: _____

Component(s): _____

(Note in vehicle interior diagram)



INTERIOR VEHICLE LOG

TO BE COMPLETED BY TEAM	DATA STATUS OF VARIABLE NUMBERS 4-97																																																																																																						
<p>1. PSU Number _____</p> <p>2. Case Number—Stratum _____</p> <p>3. Researcher Completing Form _____</p> <p>4. Vehicle Number _____</p> <p>5. Number of Interior Vehicle Slides _____</p>	<p>Integrity</p> <p style="text-align: center;">4 5 6 7 8 9 10 11 12 13 14</p> <table border="1" style="width: 100%; text-align: center;"> <tr> <td style="width: 25px; height: 20px;"> </td> <td style="width: 25px; height: 20px;"> </td> <td style="width: 25px; height: 20px;"> </td> <td style="width: 25px; height: 20px;"> </td> <td style="width: 25px; height: 20px;"> </td> <td style="width: 25px; height: 20px;"> </td> <td style="width: 25px; height: 20px;"> </td> <td style="width: 25px; height: 20px;"> </td> <td style="width: 25px; height: 20px;"> </td> <td style="width: 25px; height: 20px;"> </td> <td style="width: 25px; height: 20px;"> </td> <td style="width: 25px; height: 20px;"> </td> </tr> </table> <p>Glazing</p> <p style="text-align: center;">15 16 17 18 19 20 21 22 23 24 25</p> <table border="1" style="width: 100%; text-align: center;"> <tr> <td style="width: 25px; height: 20px;"> </td> <td style="width: 25px; height: 20px;"> </td> <td style="width: 25px; height: 20px;"> </td> <td style="width: 25px; height: 20px;"> </td> <td style="width: 25px; height: 20px;"> </td> <td style="width: 25px; height: 20px;"> </td> <td style="width: 25px; height: 20px;"> </td> <td style="width: 25px; height: 20px;"> </td> <td style="width: 25px; height: 20px;"> </td> <td style="width: 25px; height: 20px;"> </td> <td style="width: 25px; height: 20px;"> </td> <td style="width: 25px; height: 20px;"> </td> </tr> </table> <p style="text-align: center;">26 27 28 29 30 31 32 33 34 35 36</p> <table border="1" style="width: 100%; text-align: center;"> <tr> <td style="width: 25px; height: 20px;"> </td> <td style="width: 25px; height: 20px;"> </td> <td style="width: 25px; height: 20px;"> </td> <td style="width: 25px; height: 20px;"> </td> <td style="width: 25px; height: 20px;"> </td> <td style="width: 25px; height: 20px;"> </td> <td style="width: 25px; height: 20px;"> </td> <td style="width: 25px; height: 20px;"> </td> <td style="width: 25px; height: 20px;"> </td> <td style="width: 25px; height: 20px;"> </td> <td style="width: 25px; height: 20px;"> </td> <td style="width: 25px; height: 20px;"> </td> </tr> </table> <p style="text-align: center;">37 38 39 40 41 42 43 44 45 46</p> <table border="1" style="width: 100%; text-align: center;"> <tr> <td style="width: 25px; height: 20px;"> </td> <td style="width: 25px; height: 20px;"> </td> <td style="width: 25px; height: 20px;"> </td> <td style="width: 25px; height: 20px;"> </td> <td style="width: 25px; height: 20px;"> </td> <td style="width: 25px; height: 20px;"> </td> <td style="width: 25px; height: 20px;"> </td> <td style="width: 25px; height: 20px;"> </td> <td style="width: 25px; height: 20px;"> </td> <td style="width: 25px; height: 20px;"> </td> </tr> </table> <p>Intrusion</p> <p style="text-align: center;">47 48 49 50 51 52 53 54 55 56 57</p> <table border="1" style="width: 100%; text-align: center;"> <tr> <td style="width: 25px; height: 20px;"> </td> <td style="width: 25px; height: 20px;"> </td> <td style="width: 25px; height: 20px;"> </td> <td style="width: 25px; height: 20px;"> </td> <td style="width: 25px; height: 20px;"> </td> <td style="width: 25px; height: 20px;"> </td> <td style="width: 25px; height: 20px;"> </td> <td style="width: 25px; height: 20px;"> </td> <td style="width: 25px; height: 20px;"> </td> <td style="width: 25px; height: 20px;"> </td> <td style="width: 25px; height: 20px;"> </td> <td style="width: 25px; height: 20px;"> </td> </tr> </table> <p style="text-align: center;">58 59 60 61 62 63 64 65 66 67 68</p> <table border="1" style="width: 100%; text-align: center;"> <tr> <td style="width: 25px; height: 20px;"> </td> <td style="width: 25px; height: 20px;"> </td> <td style="width: 25px; height: 20px;"> </td> <td style="width: 25px; height: 20px;"> </td> <td style="width: 25px; height: 20px;"> </td> <td style="width: 25px; height: 20px;"> </td> <td style="width: 25px; height: 20px;"> </td> <td style="width: 25px; height: 20px;"> </td> <td style="width: 25px; height: 20px;"> </td> <td style="width: 25px; height: 20px;"> </td> <td style="width: 25px; height: 20px;"> </td> <td style="width: 25px; height: 20px;"> </td> </tr> </table> <p style="text-align: center;">69 70 71 72 73 74 75 76 77 78 79</p> <table border="1" style="width: 100%; text-align: center;"> <tr> <td style="width: 25px; height: 20px;"> </td> <td style="width: 25px; height: 20px;"> </td> <td style="width: 25px; height: 20px;"> </td> <td style="width: 25px; height: 20px;"> </td> <td style="width: 25px; height: 20px;"> </td> <td style="width: 25px; height: 20px;"> </td> <td style="width: 25px; height: 20px;"> </td> <td style="width: 25px; height: 20px;"> </td> <td style="width: 25px; height: 20px;"> </td> <td style="width: 25px; height: 20px;"> </td> <td style="width: 25px; height: 20px;"> </td> <td style="width: 25px; height: 20px;"> </td> </tr> </table> <p style="text-align: center;">80 81 82 83 84 85 86</p> <table border="1" style="width: 100%; text-align: center;"> <tr> <td style="width: 25px; height: 20px;"> </td> <td style="width: 25px; height: 20px;"> </td> <td style="width: 25px; height: 20px;"> </td> <td style="width: 25px; height: 20px;"> </td> <td style="width: 25px; height: 20px;"> </td> <td style="width: 25px; height: 20px;"> </td> <td style="width: 25px; height: 20px;"> </td> <td style="width: 25px; height: 20px;"> </td> </tr> </table> <p>Steering Column/Wheel and Instrument Panel</p> <p style="text-align: center;">87 88 89 90 91 92 93 94 95 96 97</p> <table border="1" style="width: 100%; text-align: center;"> <tr> <td style="width: 25px; height: 20px;"> </td> <td style="width: 25px; height: 20px;">XX</td> <td style="width: 25px; height: 20px;">XX</td> <td style="width: 25px; height: 20px;">XX</td> <td style="width: 25px; height: 20px;">XX</td> <td style="width: 25px; height: 20px;"> </td> <td style="width: 25px; height: 20px;"> </td> <td style="width: 25px; height: 20px;"> </td> <td style="width: 25px; height: 20px;"> </td> <td style="width: 25px; height: 20px;"> </td> <td style="width: 25px; height: 20px;"> </td> <td style="width: 25px; height: 20px;"> </td> </tr> </table>																																																																																												XX	XX	XX	XX							
	XX	XX	XX	XX																																																																																																			
TO BE COMPLETED BY ZONE CENTER																																																																																																							
<p>6. Documentation Of Integrity _____</p> <p>7. Documentation Of Glazing _____</p> <p>8. Documentation of Intrusions _____</p> <p>9. Documentation of Steering Column/Wheel _____</p> <p>10. Documentation of Occupant Contacts _____</p> <p>11. Documentation of Restraint Systems _____</p> <p>12. Documentation of Seats _____</p> <p>13. Interior Slides Subject Quality _____</p> <p>14. Interior Slides Quality _____</p> <p style="margin-top: 10px;">Codes For Log Variables 6-14 (0) Not applicable (1) Substandard - beyond researcher control (2) Substandard (3) Standard</p> <p>15. Number of Coded Intrusions _____</p>	<p>Data Status Codes:</p> <p>(Blank) Correct (1) Derived error (2) Non-correctable error (3) Correctable error (4) Change—no error (5) Sequencing error (7) Incorrect edit override (8) MDE error (9) Unknown coded</p>																																																																																																						



OCCUPANT ASSESSMENT LOG

TO BE COMPLETED BY TEAM																																																				
<p>1. PSU Number _____</p> <p>2. Case Number—Stratum _____</p> <p>3. Researcher Completing Form _____</p> <p>4. Vehicle Number _____</p> <p>5. Occupant Number _____</p> <p>6. Interviewer Number _____</p> <p>7. Date Interview Completed _____/_____/_____</p> <p>8. Date Official Medical Data Requested _____/_____/_____</p> <p>9. Date Official Medical Data Obtained _____/_____/_____</p> <p>10. Occupant's Role _____ (1) Driver (2) Passenger (9) Unknown</p> <p>11. Interviewee For This Occupant _____ (0) No interview (1) Same person</p> <p style="margin-left: 20px;"><i>Surrogate</i></p> <p>(2) Other occupant (3) Relative or friend (4) Multiple interviewees from above categories (specify): _____</p> <p>12. Manner Of Interview _____ (0) No attempt (1) Telephone (2) In-person (3) Questionnaire (9) Unknown (for Zone Center use only)</p> <p>13. Result Of Last Interview Attempt _____ (01) Unable to contact or locate (02) Hit and run (03) Fatal—surrogate not available (04) In intensive care—surrogate not available (05) Out-of-state resident (06) Refused interview (07) Insurance company refusal (08) Attorney refusal or litigation (09) No return of questionnaire (10) Other (specify): _____ (12) Partial interview (13) Complete interview</p>	<p>14. Was This Occupant Injured? _____ (0) No (1) Yes (9) Unknown</p> <p>15. Status of Medical Release _____ (0) Occupant not injured or not treated at a medical facility (1) Medical release not required at medical facility</p> <p style="margin-left: 20px;"><i>Medical Release Required</i></p> <p>(2) Required -- not obtained (3) Required -- obtained</p> <p>16. Injury Treatment Status _____ (00) Occupant not injured (01) No treatment (02) Fatal—died before hospitalization (03) Fatal—died after hospitalization (04) Hospitalization (05) Emergency room treatment only (06) Treatment at physician's office (07) Treatment at scene or self treatment (08) Outpatient surgery (09) Transported to a medical facility—unknown level of treatment (99) Unknown</p> <table style="width: 100%; border-collapse: collapse;"> <thead> <tr> <th style="width: 80%;"></th> <th style="width: 10%; text-align: center;">Form Received</th> <th style="width: 10%; text-align: center;">Record Status</th> </tr> </thead> <tbody> <tr> <td colspan="3"><i>Official</i></td> </tr> <tr> <td>a. Autopsy (invasive examination)</td> <td style="text-align: center;">_____</td> <td style="text-align: center;">_____</td> </tr> <tr> <td>b. Post-ER medical record which includes information about death based on non-invasive examination</td> <td style="text-align: center;">_____</td> <td style="text-align: center;">_____</td> </tr> <tr> <td>c. Admission record/summary of admission/discharge face sheet</td> <td style="text-align: center;">_____</td> <td style="text-align: center;">_____</td> </tr> <tr> <td>d. Discharge summary</td> <td style="text-align: center;">_____</td> <td style="text-align: center;">_____</td> </tr> <tr> <td>e. Operative report</td> <td style="text-align: center;">_____</td> <td style="text-align: center;">_____</td> </tr> <tr> <td>f. Radiographic record(s) (X-ray, CT scan)</td> <td style="text-align: center;">_____</td> <td style="text-align: center;">_____</td> </tr> <tr> <td>g. History and physical examination and/or consultation records</td> <td style="text-align: center;">_____</td> <td style="text-align: center;">_____</td> </tr> <tr> <td>h. Emergency room records (includes nurses' notes)</td> <td style="text-align: center;">_____</td> <td style="text-align: center;">_____</td> </tr> <tr> <td>j. Private physician</td> <td style="text-align: center;">_____</td> <td style="text-align: center;">_____</td> </tr> <tr> <td colspan="3"><i>Unofficial</i></td> </tr> <tr> <td>k. Lay coroner</td> <td style="text-align: center;">_____</td> <td style="text-align: center;">_____</td> </tr> <tr> <td>l. EMS record</td> <td style="text-align: center;">_____</td> <td style="text-align: center;">_____</td> </tr> <tr> <td>m. Interviewee</td> <td style="text-align: center;">_____</td> <td style="text-align: center;">_____</td> </tr> <tr> <td>n. Other source (specify): _____</td> <td style="text-align: center;">B</td> <td style="text-align: center;">_____</td> </tr> <tr> <td>o. Police report</td> <td style="text-align: center;">B</td> <td style="text-align: center;">_____</td> </tr> </tbody> </table> <p style="text-align: center; margin-top: 10px;">(See reverse side of this page for codes for variable 17)</p> <p>18. 1st Medical Facility Code (initial) _____</p> <p>19. 2nd Medical Facility Code _____</p>		Form Received	Record Status	<i>Official</i>			a. Autopsy (invasive examination)	_____	_____	b. Post-ER medical record which includes information about death based on non-invasive examination	_____	_____	c. Admission record/summary of admission/discharge face sheet	_____	_____	d. Discharge summary	_____	_____	e. Operative report	_____	_____	f. Radiographic record(s) (X-ray, CT scan)	_____	_____	g. History and physical examination and/or consultation records	_____	_____	h. Emergency room records (includes nurses' notes)	_____	_____	j. Private physician	_____	_____	<i>Unofficial</i>			k. Lay coroner	_____	_____	l. EMS record	_____	_____	m. Interviewee	_____	_____	n. Other source (specify): _____	B	_____	o. Police report	B	_____
	Form Received	Record Status																																																		
<i>Official</i>																																																				
a. Autopsy (invasive examination)	_____	_____																																																		
b. Post-ER medical record which includes information about death based on non-invasive examination	_____	_____																																																		
c. Admission record/summary of admission/discharge face sheet	_____	_____																																																		
d. Discharge summary	_____	_____																																																		
e. Operative report	_____	_____																																																		
f. Radiographic record(s) (X-ray, CT scan)	_____	_____																																																		
g. History and physical examination and/or consultation records	_____	_____																																																		
h. Emergency room records (includes nurses' notes)	_____	_____																																																		
j. Private physician	_____	_____																																																		
<i>Unofficial</i>																																																				
k. Lay coroner	_____	_____																																																		
l. EMS record	_____	_____																																																		
m. Interviewee	_____	_____																																																		
n. Other source (specify): _____	B	_____																																																		
o. Police report	B	_____																																																		

National Accident Sampling System-Crashworthiness Data System: Occupant Assessment Log

CODES FOR OCCUPANT ASSESSMENT LOG VARIABLE 17 (INJURY INFORMATION)

OCCUPANT UPDATE FORM RECEIVED (FIRST COLUMN)

- (Blank) No or not applicable
- (1) Yes

STATUS OF MEDICAL RECORD (SECOND COLUMN)

- (Blank) Not medically treated/record not required
- (01) No record of treatment at medical facility
- (02) Medical release required—not obtained
- (03) Injury not related to accident
- (04) Noncooperative hospital
- (05) Hospital out-of-study area
- (06) Private physician would not release data
- (07) Unknown if medically treated
- (08) To be updated
- (09) Record not received before file closeout
- (10) Record not obtained
- (11) Record obtained
- (12) Partial record obtained—not to be updated
- (13) Partial record obtained—to be updated

TO BE COMPLETED BY ZONE CENTER

- 20 Documentation of Occupant Interview
(Excludes Injury Data)
- (0) Not applicable
- (1) Substandard - beyond researcher control
- (2) Substandard
- (3) Standard

DATA STATUS OF VARIABLE NUMBERS 4-53

4	5	6	7	8	9	10	11	12	13	14
15	16	17	18	19	20	21	22	23	24	25
26	27	28	29	30	31	32	33	34	35	36
37	38	39	40	41	42	43	44	45	46	47
48	49	50	51	52	53					

Data Status Codes.

- (Blank) Correct
- (1) Derived error
- (2) Non-correctable error
- (3) Correctable error
- (4) Change—no error
- (5) Sequencing error
- (7) Incorrect edit override
- (8) MDE error
- (9) Unknown coded

Variable Name: Passenger Compartment Integrity

Element Values:

00 No integrity loss

Yes, Integrity Was Lost Through:

01 Windshield

02 Door (side)

03 Door/hatch (back door)

04 Roof

05 Roof glass

06 Side window

07 Rear window (backlight)

08 Roof and roof glass

09 Windshield and door (side)

10 Windshield and roof

11 Side and rear window (side window and backlight)

12 Windshield and side window

13 Door and side window

98 Other combination of above (specify):

99 Unknown

Source: Vehicle inspection

Remarks:

Consider the passenger compartment as a "package" which is designed to contain the occupant. If an opening occurs of sufficient magnitude through which an occupant could have been ejected totally or partially (although it is not necessary for an occupant to have been ejected), the integrity of the compartment should be considered to have been lost. While it is difficult to define the magnitude of the opening in a universal manner, the minimum size of the opening would be equivalent to the head of most adults. Components which may lose their integrity are restricted to the windshield glazing, window glazing (side, rear, or roof), door or roof.

The question of integrity loss is assessed with respect to impact related damage. The damage can be either direct or induced. Damage which is not impact related (e.g., fire, extrication) is not considered.

Doors which open upon impact or glazing that is broken during the impact sequence are considered integrity loss. However, doors which were left open prior to an impact do not constitute damage related loss of integrity and should be reported under IV05-IV09 (Door, Tailgate Or Hatch Opening) code "8" (Other).

Code "00" (No integrity loss) is encoded when the doors, roof, and glazing (as listed below) remained intact during the impact sequence.

Code "01" (Windshield) is encoded when the glazing is either holed/slit or displaced sufficiently to allow an adult size head to pass through.

Variable Name: Passenger Compartment Integrity (cont'd.)

- Code "02" [Door (side)] refers to the door structure and excludes glazing areas. All side doors, whether hinged or sliding are considered here.
- Code "03" [Door/hatch (back door)] identifies integrity loss of the back door structure and not the glazing. Back doors include hatchback, tailgate, and liftback. In situations where the rear hatch or upper portion of the tailgate is entirely made of glazing material and secured with a latching mechanism, only the latching mechanism should be considered for this code. Integrity loss through shattered or displaced rear window glazing is identified in code "07" (Rear window).
- Code "04" (Roof) refers only to the roof structure and not glazing areas. Roof structures containing metal panels (e.g., "T" top roofs) are reported here as well as closed convertible tops.
- Code "05" (Roof glass) reports glazing material in the roof structure which is broken or displaced.
- Code "06" (Side window) refers to glazing which was broken or displaced during the accident sequence. Glazing which was totally open prior to the accident and broken (i.e., sidelight rolled down into the door area) is not coded as integrity loss.
- Code "07" [Rear window (backlight)] includes backlights, hatchbacks/tailgates/liftbacks, and rear door glazing which were broken or displaced.
- Code "08" (Roof and roof glass) is coded when each specific component experiences integrity loss.
- Code "09" [Windshield and door (side)] identifies integrity loss through windshield glazing and side door structure, but excludes sidelight glazing.
- Code "10" (Windshield and roof) refers to integrity loss of the windshield glazing and roof structure. Windshield and roof glass is included in Code "98" (Other combination of above).
- Code "11" [Side and rear window (side window and backlight)] identifies integrity loss to glazing areas on either side of the vehicle in combination with hatchback/tailgate/liftback and rear door glazing.
- Code "12" (Windshield and side window) refers to integrity loss of the windshield glazing (see code "01") in combination with glazing on either side of the vehicle (see code "06").
- Code "13" (Door and side window) refers to integrity loss of the door structure (see code "02") in combination with glazing on either side of the vehicle (see code "06").

Variable Name: Passenger Compartment Integrity (cont'd.)

Code "98" (Other combination of above) includes any combination of codes "01"-
"07" above which are not listed in elements "08"-
"13". Integrity loss in areas not identified by elements "01"-
"07" (e.g., floor) is not considered for this variable.

Code "99" (Unknown) is used in the following situations:

- o extrication damage masked integrity loss, and
- o integrity loss could not be determined due to circumstances beyond the researcher's control.

DOOR, TAILGATE, OR HATCH OPENING OVERVIEW

It is the intent of variables IV05-IV09 to capture whether a passenger compartment door, tailgate, or hatch opened or remained closed during the accident sequence. Variables IV10-IV14 only document reasons for why doors came open during the accident.

The areas of interest include the left front, right front, left rear, right rear, and tailgate/hatch doors (i.e., LF, RF, LR, RR, TG/H, respectively). The LF and RF doors are the forwardmost side doors on the left and right sides of a vehicle and the LR and RR doors are the next door (or set of doors) rearward of the LF and RF doors. There are situations where two adjacent doors are used to cover a single opening (i.e., side or rear of a cargo van). These should be treated as a single door. Side doors are applicable whether hinged or on tracks.

Generally, hatch doors meet the following criteria:

- o provide access to the rear cargo area of a passenger car type vehicle, through a large opening backlight,
- o are composed primarily of glass and may or may not be framed,
- o are hinged at the top and latched at the bottom, and
- o are not used in conjunction with a lower door or tailgate.

Some vehicles are equipped with frameless glass hatches which may shatter as a result of an impact. This situation is considered a glazing loss (refer to variables IV15-IV46) rather than a hatch opening unless the hatch did, in fact, open prior to the glass breaking (i.e., release of the latching/hinging mechanism). Some glass hatches may be bordered by a narrow band of metal. The condition of this metal band is the focus of this variable group. These remarks also apply when the upper window of a tailgate assembly is being considered.

Generally, tailgates exist on the rear end plane of station wagon type vehicles. They may be one or two piece assemblies. In the instance of a two piece unit, they will be hinged at the top and bottom with a horizontal seam. One piece units may be hinged at the top for some vehicles or at the bottom with retracting rear windows for others. Pickup truck tailgates are not included in these variables.

Rear doors may be single or double units covering a single opening. The rear doors are hinged on one or both sides with a vertical seam present in dual door applications. Rear doors are most commonly found on van type vehicles and are encoded under variables IV09 and IV14, ... - TG/H.

IV05
IV06
IV07
IV08
IV09

Variable Name: Door, Tailgate Or Hatch Opening - LF
Door, Tailgate Or Hatch Opening - RF
Door, Tailgate Or Hatch Opening - LR
Door, Tailgate Or Hatch Opening - RR
Door, Tailgate Or Hatch Opening - TG/H

Element Values:

- 0 No door/gate/hatch
- 1 Door/gate/hatch remained closed and operational
- 2 Door/gate/hatch came open during collision
- 3 Door/gate/hatch jammed shut
- 8 Other (specify):
- 9 Unknown

Source: Vehicle inspection

Remarks:

This variable identifies the operational status of a door, tailgate or hatch during an accident sequence. Priority is given to doors which open during the collision. Where multiple doors cover a single opening, and the disposition of each door was different, select the code for the door which is first identified in the following priority list: "2" (... came open during collision), "3" (... jammed shut), "8" (Other), "1" (... remained closed and operational), and "9" (Unknown). As an example, if one door came open and the other was jammed shut, the proper code would be "2" (... came open during collision). Gaps caused by body deformation are not coded as door opening events. These gaps will be encoded in variable IV04, Passenger Compartment Integrity.

Code "0" (No door/gate/hatch) is used when no door, tailgate, or hatch exists in the appropriate area (i.e., LF, RF, LR, RR, TG/H).

Code "1" (Door/gate/hatch remained closed and operational) for any door, tailgate, or hatch which did not open during the accident sequence and remained operational.

Code "2" (Door/gate/hatch came open during collision) is coded when the door assembly opened during the accident sequence, irrespective of the cause. Further, the magnitude of the opening created is inconsequential when encoding this value. Note, if this code is used then the matching area in variables IV10-IV14 must not equal "0". The researcher must consider the potential that a sprung-mass situation may exist. In this condition, the door may have been opened after the accident, but due to vehicle body stresses the door cannot be shut. This is an important consideration when assessing whether the door came open during the collision.

INTERIOR VEHICLE FORM

]V05
]V06
]V07
]V08
]V09
 (2)

Variable Name: Door, Tailgate Or Hatch Opening - LF (cont'd.)
 Door, Tailgate Or Hatch Opening - RF (cont'd.)
 Door, Tailgate Or Hatch Opening - LR (cont'd.)
 Door, Tailgate Or Hatch Opening - RR (cont'd.)
 Door, Tailgate Or Hatch Opening - TG/H (cont'd.)

Code "3" (Door/gate/hatch jammed shut) is used when a door is rendered inoperable due to being jammed shut. Inoperable is defined as the inability of the researcher to open the door wide enough (through the use of reasonable force) to allow passage of an adult head. It is irrelevant whether the jamming is a result of latch or hinge failure, the displacement of adjacent body panels, or direct damage. Undamaged locked doors should not be coded as jammed or inoperable. Doors which were pried open following the accident are an indication of jamming and should be closely examined. In this situation, the researcher should thoroughly annotate and photograph the door area to support this conclusion.

Code "8" (Other) is used for those situations which cannot be identified with elements "0"- "3". Doors which are open prior to the accident take this code (e.g., hatchbacks open for cargo reasons, ventilation, etc.).

Code "9" (Unknown) is used when the researcher could not make a performance assessment of the door, tailgate or hatch.

INTERIOR VEHICLE FORM

IV10
IV11
IV12
IV13
IV14

Variable Name: Damage/Failure Associated with Door, Tailgate,
Or Hatch Opening In Collision - LF
Damage/Failure Associated with Door, Tailgate,
Or Hatch Opening In Collision - RF
Damage/Failure Associated with Door, Tailgate,
Or Hatch Opening In Collision - LR
Damage/Failure Associated with Door, Tailgate,
Or Hatch Opening In Collision - RR
Damage/Failure Associated with Door, Tailgate,
Or Hatch Opening In Collision - TG/H

Element Values:

- 0 No door/gate/hatch or door not opened
- Door, Tailgate, or Hatch Came Open During Collision
- 1 Door operational (no damage)
- 2 Latch/striker failure due to damage
- 3 Hinge failure due to damage
- 4 Door structure failure due to damage
- 5 Door support (i.e., pillar, sill, roof side rail, etc.) failure due to damage
- 6 Latch/striker and hinge failure due to damage
- 8 Other failure (specify):
- 9 Unknown

Source: Vehicle inspection

Remarks:

This variable is designed to capture the reason a door opened during the collision sequence as identified by code "2" (Door/gate/hatch came open during collision) in variables IV05-IV09, respectively.

Code "0" (No door/gate/hatch or door not opened) is used when no door, tailgate, or hatch exists or the door/tailgate/hatch did not open during the accident sequence. This code is also used when the door/tailgate/hatch is jammed shut. Doors which were open prior to the accident (hatchbacks open for cargo reasons, ventilation, etc.) also take this code.

Code "1" [Door operational (no damage)] is used when the door, tailgate, or hatch opened during the accident sequence, but the unit was undamaged and remained operational.

Code "2" (Latch/striker failure due to damage) is used when the door, tailgate, or hatch opened as a result of a failure of the latch/striker

INTERIOR VEHICLE FORM

IV10
 IV11
 IV12
 IV13
 IV14
 (2)

Variable Name: Damage/Failure Associated with Door, Tailgate,
 Or Hatch Opening In Collision - LF (cont'd.)
 Damage/Failure Associated with Door, Tailgate,
 Or Hatch Opening In Collision - RF (cont'd.)
 Damage/Failure Associated with Door, Tailgate,
 Or Hatch Opening In Collision - LR (cont'd.)
 • Damage/Failure Associated with Door, Tailgate,
 Or Hatch Opening In Collision - RR (cont'd.)
 Damage/Failure Associated with Door, Tailgate,
 Or Hatch Opening In Collision - TG/H (cont'd.)

assembly. The failure must be due to damage, either direct or induced, and must result in the forced unlatching of the latch/striker assembly or shearing of the striker post.

Code "3" (Hinge failure due to damage) is used to indicate that a hinge failure exists as a result of either direct or induced damage. A hinge failure includes the complete separation of the hinge assembly from the door structure, pillar or of the two or more components which comprise the hinge assembly.

Code "4" (Door structure failure due to damage) is used anytime the door structure sustained damage which allowed the latch, striker, or hinge to separate from the mounting surface (i.e., torn metal). The door structure is defined as all components of the door assembly exclusive of the door skin.

Code "5" [Door support (i.e., pillar, sill, roof side rail, etc.) failure due to damage] is used to define situations where the latch/striker assembly did not fail, but the door support areas are damaged sufficiently to allow for the door to open. This includes, but is not limited to, the failure of pillars, sills and/or roof side rails at its most severe level. Code "6" (Latch/striker and hinge failure due to damage) is used to describe situations where the entire door and adjacent components (i.e., pillars) are torn away by an impact.

Code "6" (Latch/striker and hinge failure due to damage) is used when both a latch/striker and hinge failure exists. Failure must be present to the latch/striker and at least one hinge, resulting in the door opening (i.e., door partially or completely torn off).

Code "8" (Other failure) is used to indicate that an opening exists which cannot be described with codes "1"- "6" above. This includes vehicles with a canvas roof and door structure (i.e., Jeeps, etc.).

IV10
IV11
IV12
IV13
IV14
(3)

Variable Name: Damage/Failure Associated with Door, Tailgate,
Or Hatch Opening In Collision - LF (cont'd.)
Damage/Failure Associated with Door, Tailgate,
Or Hatch Opening In Collision - RF (cont'd.)
Damage/Failure Associated with Door, Tailgate,
Or Hatch Opening In Collision - LR (cont'd.)
Damage/Failure Associated with Door, Tailgate,
Or Hatch Opening In Collision - RR (cont'd.)
Damage/Failure Associated with Door, Tailgate,
Or Hatch Opening In Collision - TG/H (cont'd.)

Code "9" (Unknown) is used when it cannot be determined which code (elements
"1"- "8") applies.

GLAZING DAMAGE OVERVIEW

Glazing is defined for these variables as a covering for openings in the vehicle's structure which has the ability to allow light to pass. The areas of interest include: the windshield, sidelight windows, backlight (hatchback, tailgate, liftback, rear window), and roof. Composition of glazing materials in use today include: glass, plastic, and glass-plastic.

The potential for occupant ejection is a major concern of rulemakers at NHTSA. Variables IV15-IV46 are designed to record the successes and failures of occupant containment by glazing when there is an occurrence of occupant contact to the glazing, or glazing damage by impact forces or vehicle damage.

Current use of glass-plastic (such as Inner Shield, Securiflex, etc.) involves a plastic anti-lacerative layer applied to the inner surface of windshields. Recently, Federal Motor Vehicle Safety Standard 205 was modified to allow voluntary (not compulsory) installation of this type of glazing. Glass-plastic should not be confused with the current design of laminate windshields which are made with a layer of plastic (Polyvinyl Butyral) between two layers of annealed glass. It should be noted that future considerations and uses of glass-plastic involve the side, rear, and roof glazing areas.

Researchers are required to thoroughly inspect all glazing for direct occupant contact/damage and encode their findings. This information is recorded independent of occupant ejection.

Glazing variables are divided into four sections.

- o Glazing Damage from Impact Forces (IV15-IV22)
- o Glazing Damage from Occupant Contact (IV23-IV30)
- o Type of Window/Windshield Glazing (IV31-IV38)
- o Window Pre-crash Glazing Status (IV39-IV46)

These sections are further divided into eight specific areas of interest.

- o WS = windshield
- o LF = left front window (driver's window)
- o RF = right front window
- o LR = left rear window (adjacent to LF window)
- o RR = right rear window (adjacent to RF window)
- o BL = backlight, tailgate/hatchback/liftgate window
- o Roof = sun roof, moon roof, "T" roof, etc.
- o Other = other sidelights, door wing windows, and any other light not identified above

The "other" category (as noted) encompasses areas where glazing may be directly contacted by occupants or damaged from impact forces and not identified by a specific location. This would include wing windows located in door areas. In the event more than one "other" area was involved, select the area with the highest priority number as ranked in variables IV15-IV30. When more than one

GLAZING DAMAGE OVERVIEW

glazing has the highest priority code, the researcher should select the glazing which is closest to the front of the vehicle with the left side taking precedence over the right side. The researcher must specify the selected glazing in the space provided on the form.

IV15
 IV16
 IV17
 IV18
 IV19
 IV20
 IV21
 IV22

Variable Name: Glazing Damage From Impact Forces - WS
 Glazing Damage From Impact Forces - LF
 Glazing Damage From Impact Forces - RF
 Glazing Damage From Impact Forces - LR
 Glazing Damage From Impact Forces - RR
 Glazing Damage From Impact Forces - BL
 Glazing Damage From Impact Forces - Roof
 Glazing Damage From Impact Forces - Other

Element Values:

- 0 No glazing damage from impact forces
- 2 Glazing in place and cracked from impact forces
- 3 Glazing in place and holed from impact forces
- 4 Glazing out-of-place (cracked or not) and not holed from impact forces
- 5 Glazing out-of-place and holed from impact forces
- 6 Glazing disintegrated from impact forces
- 7 Glazing removed prior to accident
- 8 No glazing
- 9 Unknown if damaged

Source: Vehicle inspection

Remarks:

These variables identify damage to the glazing as a result of impact forces and/or vehicle damage (including damage from interior loose objects). Damage caused by direct occupant contact should be recorded in variables IV23-IV30, Glazing Damage From Occupant Contact.

Code "0" (No glazing damage from impact forces) is used when there was no damage to the glazing. Glazing damage for these variables is defined as cracking, holed, out-of-place or disintegrated. Glazing which is scratched is considered not damaged.

Code "2" (Glazing in place and cracked from impact forces) is used when the glazing remained within the confines of its specific area and was cracked. Displaced glazing which was not totally separated from the vehicle should be treated as "in place". This would include windshields with partial bond separation and dislodged side glazing.

Code "3" (Glazing in place and holed from impact forces) is used when the glazing was "holed". "Holed" refers to a hole or slit in the glazing which is large enough in size to allow passage of an adult head.

NASS CDS Value Tables

TABLE A-15
 INTRUDING COMPONENT
 BY
 INJURY SOURCE
 (CONSISTENCY CHECK: CT009)
 (VERSION: 7.1)

INTRUDING COMPONENT (IV48)[n]	INJURY SOURCE (OI12)[n]	CHANGE VERSION
01	04, 05, 06, 07, 14	
02	08, 09, 13, 14, 58	
03	08, 10, 13	
04	08, 11, 12, 13, 15	
05	56, 59	
06	14, 15, 22, 26, 32, 36	
07	23, 26, 33, 36, 42	
08	24, 34	
09	24, 34	
10	20, 21, 26, 28, 30, 31, 36, 38	
12	54	
13	26, 36, 52, 53	
14	01, 02, 14, 15, 18	
15	14, 15, 18, 50	
16	25, 26, 35, 36	
17	56, 57	
18	51, 60	
19	40, 44	
20	40, 44	
21	40	
22	40	
23	40	
24	40	
25	61,62	
26	19, 24, 27, 34, 37, 49, 57, 62	
27	20, 30	
28	20, 21, 30, 31	
30	65	
31	66, 67	
32	70-82, 85	
33	83	
98	19, 27, 37, 49, 62	

IV15
IV16
IV17
IV18
IV19
IV20
IV21
IV22
(3)

Variable Name: Glazing Damage From Impact Forces - WS (cont'd.)
Glazing Damage From Impact Forces - LF (cont'd.)
Glazing Damage From Impact Forces - RF (cont'd.)
Glazing Damage From Impact Forces - LR (cont'd.)
Glazing Damage From Impact Forces - RR (cont'd.)
Glazing Damage From Impact Forces - BL (cont'd.)
Glazing Damage From Impact Forces - Roof (cont'd.)
Glazing Damage From Impact Forces - Other (cont'd.)

Code "8" (No glazing) is used for specific areas where the body structure was not designed to accept glazing (i.e., solid roof structure, etc.).

Code "9" (Unknown if damaged) is used in the following situations.

- o The degree of damage could not be determined as the result of post impact damage (i.e., extrication, towing operations, etc.).
- o Due to factors beyond the researcher's control, an adequate determination of glazing damage could not be made (i.e., catastrophic type vehicle damage, etc.). This should be a rare occurrence.
- o The cause of glazing damage (i.e., impact forces versus occupant contact) could not be determined by the researcher. Caution, it is anticipated this reason will be rarely used. When confronted with this dilemma, every effort must be made to code a known value for damaged glazing.

IV23
 IV24
 IV25
 IV26
 IV27
 IV28
 IV29
 IV30

Variable Name: Glazing Damage from Occupant Contact - WS
 Glazing Damage from Occupant Contact - LF
 Glazing Damage from Occupant Contact - RF
 Glazing Damage from Occupant Contact - LR
 Glazing Damage from Occupant Contact - RR
 Glazing Damage from Occupant Contact - BL
 Glazing Damage from Occupant Contact - Roof
 Glazing Damage from Occupant Contact - Other

Element Values:

- 0 No occupant contact to glazing or no glazing
- 1 Glazing contacted by occupant but no glazing damage
- 2 Glazing in place and cracked by occupant contact
- 3 Glazing in place and holed by occupant contact
- 4 Glazing out-of-place (cracked or not) by occupant contact and not holed by occupant contact
- 5 Glazing out-of-place by occupant contact and holed by occupant contact
- 6 Glazing disintegrated by occupant contact
- 9 Unknown if contacted by occupant

Source: Vehicle inspection

Remarks:

These variables report direct occupant contact to the glazing during the accident sequence. The codes are arranged in an increasing number priority scheme [i.e., code "3" (Glazing in place and holed by occupant contact) takes precedence over code "2" (Glazing in place and cracked by occupant contact), etc.].

Code "0" (No occupant contact to glazing or no glazing) is used when there are *no direct occupant contacts detected to the glazing* or when variables IV15-IV22, Glazing Damage from Impact Forces, are coded "7" (Glazing removed prior to accident) or "8" (No glazing).

Code "1" (Glazing contacted by occupant but no glazing damage) is used when an occupant directly contacted the glazing, but the contact did not result in glazing damage.

Code "2" (Glazing in place and cracked by occupant contact) refers to glazing that was damaged (not holed) by direct occupant contact. The term "in place" describes glazing which has remained within the confines of its specific area. Displaced glazing which was not totally separated from

IV23
 IV24
 IV25
 IV26
 IV27
 IV28
 IV29
 IV30
 (2)

Variable Name: Glazing Damage from Occupant Contact - WS (cont'd.)
 Glazing Damage from Occupant Contact - LF (cont'd.)
 Glazing Damage from Occupant Contact - RF (cont'd.)
 Glazing Damage from Occupant Contact - LR (cont'd.)
 Glazing Damage from Occupant Contact - RR (cont'd.)
 Glazing Damage from Occupant Contact - BL (cont'd.)
 Glazing Damage from Occupant Contact - Roof (cont'd.)
 Glazing Damage from Occupant Contact - Other (cont'd.)

the vehicle should be treated as "in place". This would include windshields with partial bond separation and dislodged side glazing.

- Code "3" (Glazing in place and holed by occupant contact) is used when the glazing was "holed". "Holed" refers to a hole or slit in the glazing which was produced by direct occupant contact. This opening is equivalent in size to the space necessary to allow passage of an adult head.
- Code "4" [Glazing out-of-place (cracked or not) by occupant contact and not holed by occupant contact] refers to glazing which was directly contacted by an occupant and was totally separated from the vehicle during the accident sequence. Windshields with 100 percent bond separation take this code. Caution must be exercised by the researcher not to consider shattered tempered glass (i.e., sidelights, etc.) as out-of-place. This situation is reported under code "6" (Glazing disintegrated by occupant contact).
- Code "5" (Glazing out-of-place by occupant contact and holed by occupant contact) refers to glazing which was contacted and holed by direct occupant contact and totally separated from the vehicle during the accident sequence. "Holed" refers to a hole or slit in the glazing which was produced by direct occupant contact. This opening is equivalent in size to the space necessary to allow passage of an adult head.
- Code "6" (Glazing disintegrated by occupant contact) refers to glazing that was totally destroyed by direct occupant contact. This usually occurs with shattered tempered glass (i.e., sidelights, etc.). Windshields that were separated from the vehicle should not be considered disintegrated. Uncertainty may exist when determining the cause of shattered sidelight glazing when the collision occurred adjacent to an occupied seat. As a rule of thumb, impact forces and/or vehicle damage generally cause disintegration of the sidelight prior to occupant contact.

IV23
 IV24
 IV25
 IV26
 IV27
 IV28
 IV29
 IV30
 (3)

Variable Name: Glazing Damage from Occupant Contact - WS (cont'd.)
 Glazing Damage from Occupant Contact - LF (cont'd.)
 Glazing Damage from Occupant Contact - RF (cont'd.)
 Glazing Damage from Occupant Contact - LR (cont'd.)
 Glazing Damage from Occupant Contact - RR (cont'd.)
 Glazing Damage from Occupant Contact - BL (cont'd.)
 Glazing Damage from Occupant Contact - Roof (cont'd.)
 Glazing Damage from Occupant Contact - Other (cont'd.)

Code "9" (Unknown if contacted by occupant) is used in the following situations.

- o Direct occupant contact/damage could not be determined due to post impact damage (i.e., extrication, towing operations, etc.).
- o Due to factors beyond the researcher's control, an adequate determination of direct occupant contact/damage could not be made.

IV31
 IV32
 IV33
 IV34
 IV35
 IV36
 IV37
 IV38

Variable Name: Type of Window/Windshield Glazing - WS
 Type of Window/Windshield Glazing - LF
 Type of Window/Windshield Glazing - RF
 Type of Window/Windshield Glazing - LR
 Type of Window/Windshield Glazing - RR
 Type of Window/Windshield Glazing - BL
 Type of Window/Windshield Glazing - Roof
 Type of Window/Windshield Glazing - Other

Element Values:

- 0 No glazing contact and no damage, or no glazing
- 1 AS-1 - Laminated
- 2 AS-2 - Tempered
- 3 AS-3 - Tempered-tinted
- 4 AS-14 - Glass/Plastic
- 8 Other (specify):
- 9 Unknown

Source: Vehicle inspection

Remarks:

Glazing types are identified by unique AS (American Standard) numbers which are etched in the glazing surface. The AS numbers are generally grouped with other glazing information and together make up an informational symbol referred to as a "water mark" (see diagram below).

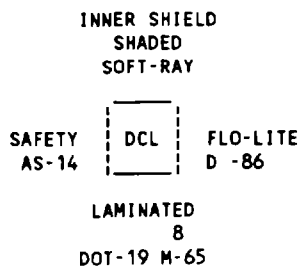

The following codes record information for specific areas identified in variable groups IV15-IV22, Glazing Damage from Impact Forces, and IV23-IV30, Glazing Damage from Occupant Contact.

Code "0" (No glazing contact and no damage, or no glazing) is used when any glazing area was not identified as either damaged from impact forces or contacted by an occupant in variables IV15-IV30. In addition, use

IV31
 IV32
 IV33
 IV34
 IV35
 IV36
 IV37
 IV38
 (2)

Variable Name: Type of Window/Windshield Glazing - WS (cont'd.)
 Type of Window/Windshield Glazing - LF (cont'd.)
 Type of Window/Windshield Glazing - RF (cont'd.)
 Type of Window/Windshield Glazing - LR (cont'd.)
 Type of Window/Windshield Glazing - RR (cont'd.)
 Type of Window/Windshield Glazing - BL (cont'd.)
 Type of Window/Windshield Glazing - Roof (cont'd.)
 Type of Window/Windshield Glazing - Other (cont'd.)

this code when codes "7" (Glazing removed prior to accident) or "8" (No glazing) in variables IV15-IV22, Glazing Damage from Impact Forces, were encoded.

Codes "1"- "4", or "8" are used when any glazing area was identified as damaged from impact forces or direct occupant contact in variable groups IV15-IV22 and IV23-IV30. When all side and rear windows have been broken out, examine the window track or frame for remnants of broken glass. If such glass is present and the remnants are small clear granules (or cracked in granule size pieces), then it is permissible to code "2" (AS-2 - Tempered). If these remnants are tinted, then it is permissible to code "3" (AS-3 - Tempered-Tinted). If these remnants have any plastic tint shield clinging to them, then it is permissible to code "8" (Other).

Code "1" (AS-1 - Laminated) refers to a layer of plastic between two layers of glass. This type of glazing is widely used in current windshield installations.

Code "2" (AS-2 - Tempered) refers to glass which has the ability to break into small glass granules when damaged.

Code "3" (AS-3 - Tempered-tinted) refers to manufactured tinted (privacy) glass which has the ability to break into small glass granules when damaged. Glazing which has an aftermarket plastic tint shield applied should be listed under code "8" (Other).

Code "4" (AS-14 - Glass/Plastic) refers to glazing which uses plastic on its inner surface. This is used in anti-lacerative windshields (i.e., Inner Shield, Securiflex, etc.).

Code "8" (Other) refers to any glazing which has an AS number different from AS-1, AS-2, AS-3 and AS-14. Write the AS number of the glazing in the space provided. This includes plastic (AS-11C), bullet proof (AS-10), aftermarket plastic tint shield, etc.

INTERIOR VEHICLE FORM

IV31
IV32
IV33
IV34
IV35
IV36
IV37
IV38
(3)

Variable Name: Type of Window/Windshield Glazing - WS (cont'd.)
Type of Window/Windshield Glazing - LF (cont'd.)
Type of Window/Windshield Glazing - RF (cont'd.)
Type of Window/Windshield Glazing - LR (cont'd.)
Type of Window/Windshield Glazing - RR (cont'd.)
Type of Window/Windshield Glazing - BL (cont'd.)
Type of Window/Windshield Glazing - Roof (cont'd.)
Type of Window/Windshield Glazing - Other (cont'd.)

Code "9" (Unknown) is used in the following situations.

- o Due to factors beyond the researcher's control, an adequate determination of glazing damage and/or direct occupant contact could not be made.
- o A reasonable determination of the AS number could not be made.

IV39
 IV40
 IV41
 IV42
 IV43
 IV44
 IV45
 IV46

Variable Name: Window Pre-crash Status - WS
 Window Pre-crash Status - LF
 Window Pre-crash Status - RF
 Window Pre-crash Status - LR
 Window Pre-crash Status - RR
 Window Pre-crash Status - BL
 Window Pre-crash Status - Roof
 Window Pre-crash Status - Other

Element Values:

0 No glazing contact and no damage, or no glazing
 1 Fixed
 2 Closed
 3 Partially opened
 4 Fully opened
 9 Unknown

Source: Vehicle inspection.

Remarks:

These variables record the operational modes of the glazing prior to the accident.

Code "0" (No glazing contact and no damage, or no glazing) is used when any glazing area was not identified as either damaged from impact forces or directly contacted by an occupant in variables IV15-IV30. In addition, use this code when codes "7" (Glazing removed prior to accident) or "8" (No glazing) in variables IV15-IV22, Glazing Damage from Impact Forces, are encoded.

Code "1" (Fixed) identifies glazing which is not designed to open (e.g. windshields, etc.).

Code "2" (Closed) refers to any operable glazing which was fully closed (i.e., no air gaps).

Code "3" (Partially opened) refers to any operable glazing which is not firmly closed (i.e., air gaps present) and not fully opened. Note, the researcher should code the placement of the window in relationship to the opening and not by window design limitations.

Code "4" (Fully opened) refers to any operable glazing which is attached to the vehicle (i.e., window tracks) and was placed in the open position such that the glazing was not restricting the opening of the vehicle

V39
V40
V41
V42
V43
V44
V45
V46
(2)

Variable Name: Window Pre-crash Status - WS (cont'd.)
Window Pre-crash Status - LF (cont'd.)
Window Pre-crash Status - RF (cont'd.)
Window Pre-crash Status - LR (cont'd.)
Window Pre-crash Status - RR (cont'd.)
Window Pre-crash Status - BL (cont'd.)
Window Pre-crash Status - Roof (cont'd.)
Window Pre-crash Status - Other (cont'd.)

structure. This element is assessed independently of window design limitations (i.e., side windows designed to only roll down halfway cannot receive this code).

Code "9" (Unknown) is used in the following situations.

- o Damage due to impact forces and/or glazing contact by an occupant could not be determined due to post-impact damage (i.e., extrication, tow operations, etc.).
- o Due to factors beyond the researcher's control, an adequate determination of damage and/or direct occupant contact could not be made.
- o A reasonable determination of the glazing pre-crash status could not be determined.

OCCUPANT AREA INTRUSION OVERVIEW

Intrusion results whenever the internal boundary surface of the passenger compartment is moved inward due to direct or indirect damage resulting from the application of a crushing force to the exterior surface of a vehicle. A passenger compartment is defined as that interior occupant space which is normally available for occupant seating, based upon both the vehicle design and seat configuration at the time of the accident. Adjacent cargo areas and other enclosed areas are included for consideration in the following situations.

- o The area behind the last row of seats designed by the manufacturer for cargo is integral with the passenger compartment.
- o An area where a seat row was either removed or folded down to accommodate cargo.

Intrusion can occur from the vertical, longitudinal, or lateral direction. Intrusion can also occur from the displacement of interior seatbacks and/or seat cushions.

Measurement of Passenger Compartment Intrusion

Types of Intrusion. Two types of intrusions occur most often in accidents. They are:

- Type A:** Intrusion which is limited to one part of the passenger compartment and where the other side of the vehicle remains relatively free of distortion. This is likely to be the case in the majority of accidents. In many cases it will be possible to obtain undeformed vehicle dimensions as the vehicle is symmetrical about the longitudinal centerline.
- Type B:** Intrusion which occurs in many sections of the passenger compartment with little of the vehicle remaining free of distortion. In this case, it will be necessary to obtain "original" dimensions by comparison with a second (unintruded) vehicle of the same type.

OCCUPANT AREA INTRUSION OVERVIEW

An example of Type A and Type B intrusions are shown in Figure 1.

Type A Intrusion:

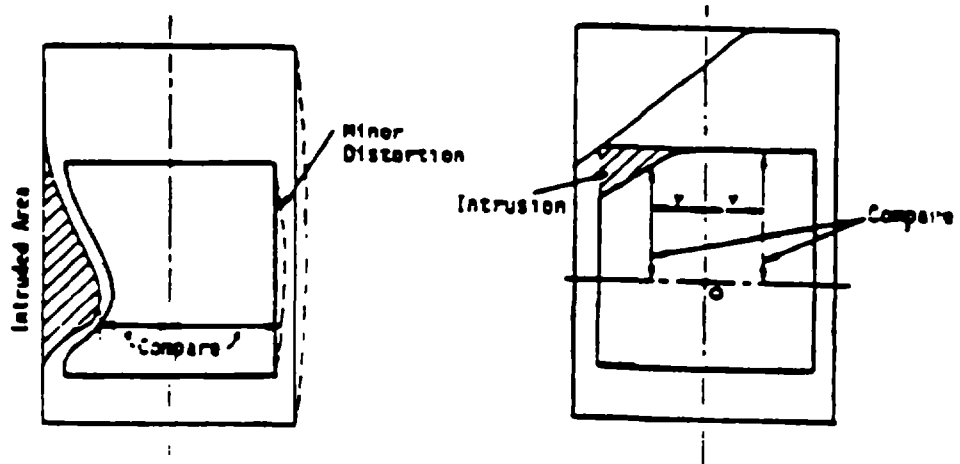

Type B Intrusion:

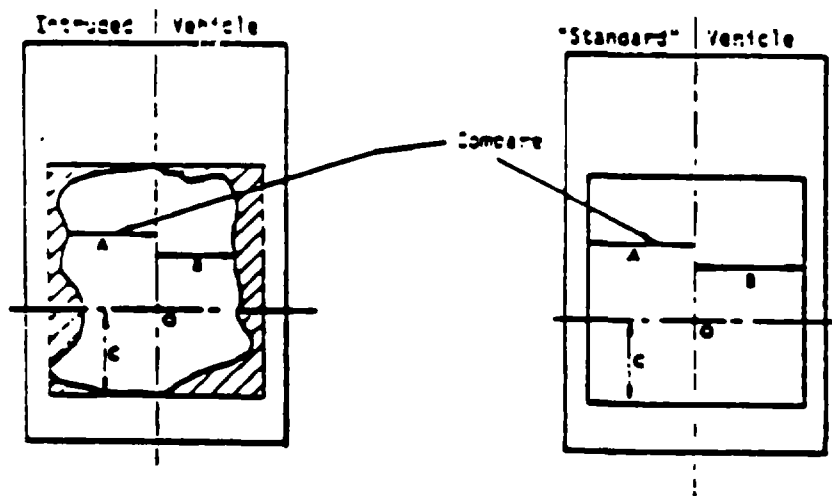

Figure 1

Establishment of Reference Axis. In order to compare one side of a vehicle with the other or compare two vehicles, a coordinate system within the vehicle is required.

OCCUPANT AREA INTRUSION OVERVIEW

This system is defined by an orthogonal set of axes (x-y-z) and an origin (0) as shown in Figure 2. The position of the origin is typically on the longitudinal centerline of the vehicle and has an arbitrary location, both vertically and longitudinally. However, its location must be identical for the intruded and "reference" vehicle. Note, the axes are referenced to the floor plane of the vehicle.

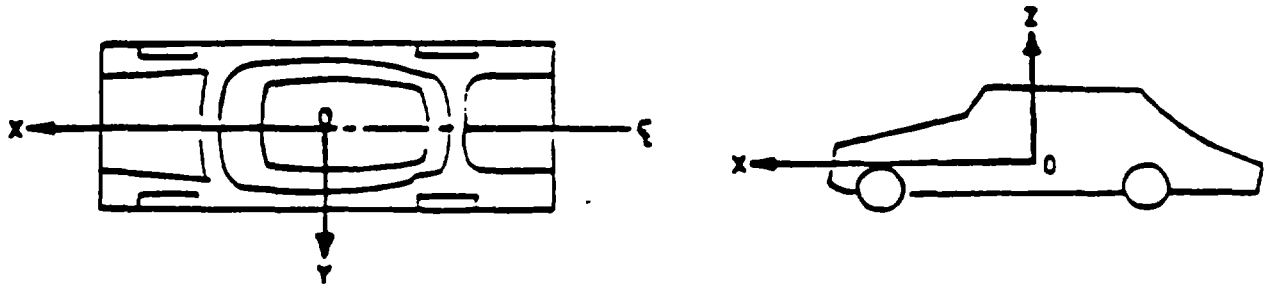

Figure 2

The x-axis is on the longitudinal centerline of the vehicle. This could be set up along the transmission drive shaft tunnel for a rear wheel drive vehicle or along a centerline which is equidistant from the sides of the vehicle in a front wheel drive vehicle.

The y-axis is in a side-to-side or lateral direction. This plane may be set up in any convenient location which can be readily established in the "reference" vehicle.

The z-axis is the vertical axis. A location at the top of the transmission drive shaft tunnel may be convenient to reference roof collapse in many cases. The point established by these intersecting planes defines the origin (0).

Establishing a frame of reference and measuring intrusion can be simplified.

- In a frontal collision, there is rarely intrusion at the rear, and vice-versa for a rear collision.
- Side impacts generally damage only one side of the vehicle.
- Roof impacts leave the floor pan undistorted.

Not all intrusions require the establishment of all three axes.

The ordering of intrusions reflects the intrusion severity as recorded in column three (i.e., Magnitude of Intrusion variables).

OCCUPANT AREA INTRUSION OVERVIEW

An intruded component is assessed for its Dominant Crush Direction (IV50 et al.) as determined from the Magnitude of Intrusion (IV49 et al.). This component must not be coded as having greater than one Dominant Crush Direction in any specific sector.

Code the ten most severe intrusions in descending order, beginning with the most severe, then the second most severe component, etc. If there is no intrusion, variables IV47-IV50 should be left "Blank". If there are less than ten intruding components, the lines following the last encoded intrusion should be left "Blank".

Displacement of less than three centimeters is not coded as an intrusion.

A passenger compartment that has been damaged catastrophically is encoded as "97", "97", "7", "7" in variables IV47-IV50.

Variable Name: Location of Intrusion
(1st through 10th)

Element Values:

Front Row
11 Left
12 Middle
13 Right

Second Row
21 Left
22 Middle
23 Right

Third Row
31 Left
32 Middle
33 Right

Fourth Row
41 Left
42 Middle
43 Right

97 Catastrophic
98 Other enclosed area (specify):
99 Unknown

Source: Vehicle inspection

Remarks:

The interior space of a vehicle is divided into specific sectors as outlined in the following diagram. These sectors are based upon seat rows and not occupant seat locations. Cargo areas open to the passenger area (i.e., station wagons, vans, etc.) are assessed in these variables. Intrusion into the trunk area of an automobile with a rear seat position or into a cargo area covered by a privacy curtain/shelf is excluded.

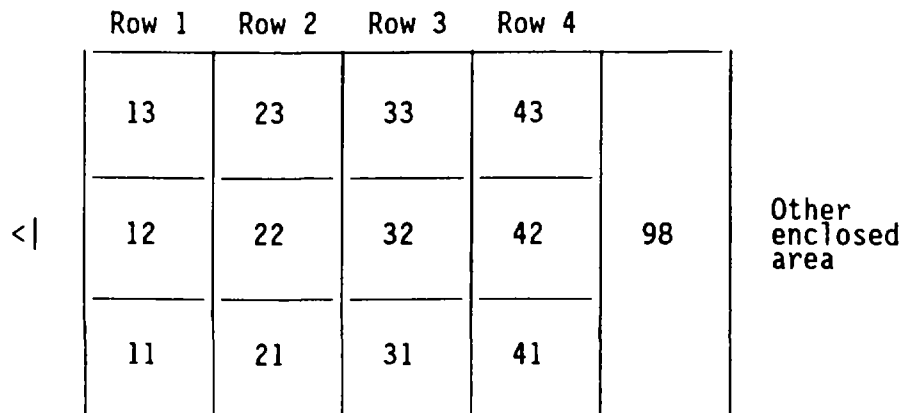

Variable Name: Location of Intrusion (cont'd.)
(1st through 10th)

Front Row, Second Row, Third Row, Fourth Row are identified by the presence of an installed seat. Each row is equally divided into three sectors. As an example, the Front Row is divided into sectors 11, 12, 13 regardless of the seating configuration.

In the situation where half of the row is folded down (i.e., split back seats) to accommodate cargo, the entire lateral area (wall-to-wall) is divided into three equal sectors. When the entire seat row is folded down or removed prior to the accident, this area is considered an "Other enclosed area" (code "98").

The following rules guide us in the determination of "seat rows" versus "other enclosed areas" and in the derivation of the lateral dimension of each row sector.

- o Cargo areas in passenger cars which are separated from the passenger compartment are not considered for intrusion. This would include trunk areas and rear cargo areas of hatchbacks and station wagons which were covered by a privacy curtain/shelf. The area above the privacy curtain/shelf is considered for intrusion and would be listed under code "98" (Other enclosed area).
- o The lateral occupant space dimension for the front seat row is obtained by measuring the distance from the vehicle's side-surface to side-surface (undamaged dimension) and dividing by three. Note, there is no implied correlation between seating capacity and sectors.
- o The area behind the front row of a pickup truck where jump seats are installed should be identified by the status of these seats prior to the accident. When at least one seat was in the operational mode (i.e., open) at the time of the accident, the entire area is divided into three sectors (i.e., "21", "22", "23"). Otherwise, this area is assessed under code "98" (Other enclosed area).
- o A problematic area in vans is the situation where a row was removed prior to the accident. A seat row area that was removed prior to an accident should be encoded as an "Other enclosed area" (code "98"); however, it should be tabulated as a seat row to identify any sequential rows.
- o Vans with single seating positions behind the Front Row (usually high back swivel chairs) are compressed into a single seat row.
- o The fifth row in a van (envisioned as a rare occurrence) is identified as an "Other enclosed area" (code "98").

Code "11" (Left) is defined as the left sector of the Front Row. The lateral dimension of this area is mathematically determined by dividing the original wall-to-wall dimension by three.

Variable Name: Location of Intrusion (cont'd.)
(1st through 10th)

Code "12" (Middle) is defined as the center sector of the Front Row.

Code "13" (Right) is defined as the right sector of the Front Row.

Code "21" (Left) is defined as the left sector of the Second Row. The lateral dimension of this sector is mathematically determined by dividing the original wall-to-wall dimension by three.

Code "22" (Middle) is defined as the center sector of the Second Row.

Code "23" (Right) is defined as the right sector of the Second Row.

Code "31" (Left) is defined as the left sector of the Third Row. The lateral dimension of this sector is mathematically determined by dividing the original wall-to-wall dimension by three.

Code "32" (Middle) is defined as the center sector of the Third Row.

Code "33" (Right) is defined as the right sector of the Third Row.

Code "41" (Left) is defined as the left sector of the Fourth Row. The lateral dimension of this sector is mathematically determined by dividing the original wall-to-wall dimension by three.

Code "42" (Middle) is defined as the center sector of the Fourth Row.

Code "43" (Right) is defined as the right sector of the Fourth Row.

Code "97" (Catastrophic) is coded when the intrusion damage to the occupant compartment is so devastating that the researcher is not able to discern any of the following: specific occupant locations, intruding components, magnitude of intrusions, and dominant crush.

Code "98" (Other enclosed area) is an area where no defined row exists. This would include an area where the entire seat row was folded down prior to the accident. Occasionally, the mid seat row in a passenger van will be removed leaving only the front and rearmost seat rows. If intrusion occurs within this area, the location should be identified here and specified.

Code "99" (Unknown) is used for the following situations.

- o The researcher cannot determine if there was any intrusion.
- o The vehicle was under repair at the time of inspection.

Variable Name: Intruding Components
(1st through 10th)

Element Values:

Interior Components

- 01 Steering assembly
- 02 Instrument panel left
- 03 Instrument panel center
- 04 Instrument panel right
- 05 Toe pan
- 06 A (A1/A2)-pillar
- 07 B-pillar
- 08 C-pillar
- 09 D-pillar
- 10 Door panel (side)
- 12 Roof (or convertible top)
- 13 Roof side rail
- 14 Windshield
- 15 Windshield header
- 16 Window frame
- 17 Floor pan (includes sill)
- 18 Backlight header
- 19 Front seat back
- 20 Second seat back
- 21 Third seat back
- 22 Fourth seat back
- 23 Fifth seat back
- 24 Seat cushion
- 25 Back door/panel (e.g., tailgate)
- 26 Other interior component (specify):
- 27 Side panel - forward of the A (A1/A2)-pillar
- 28 Side panel - rear of the A (A2)-pillar

Exterior Components

- 30 Hood
- 31 Outside surface of this vehicle (specify):
- 32 Other exterior object in the environment (specify):
- 33 Unknown exterior object

- 97 Catastrophic
- 98 Intrusion of unlisted component(s)
- 99 Unknown

Source: Vehicle inspection

Remarks:

Code "01" (Steering assembly) consists of the entire steering column which includes the steering rim, hub, and spokes.

Code "02" (Instrument panel left) refers to the left side of the panel. This

Variable Name: Intruding Components (cont'd.)
(1st through 10th)

should correlate with the same lateral dimension generated for the sector space "11" (Front Seat - Left) in variables IV47 et al., Location of Intrusion.

Code "03" (Instrument panel center) refers to the center third area of the instrument panel. This should correlate with the same lateral dimension generated for the sector space "12" (Front Seat - Middle) in variables IV47 et al., Location of Intrusion.

Code "04" (Instrument panel right) refers to the right side of the instrument panel. This should correlate with the same lateral dimension generated for the sector space "13" (Front Seat - Right) in variables IV47 et al., Location of Intrusion.

Code "05" (Toe pan) refers to the front portion of the floor that angles up to meet the dash panel.

Code "06" [A (A1/A2)-pillar] refers to the upper and lower portion of the forward most structural post of the passenger compartment on both side planes. Some vehicles (e.g., GM APV minivan) are designed with two upper A-pillars on each side. The forward most pillar is called an A1-pillar which is primarily designed to secure the windshield to the vehicle. The second pillar is labeled as an A2-pillar. This pillar generally lends support to the roof and also helps to establish the front door opening. Annotation should be provided on the Interior Vehicle Form specifying which pillar was most severely intruded.

Code "07" (B-pillar) refers to the upper and lower portion of the structural post located at the rear edge of the front doors on both side planes. It should be noted, some vehicles do not have upper B-pillars.

Code "08" (C-pillar) refers to the upper and lower portion of the structural side post located at the rearmost edge of the rear door of a four door vehicle or the upper portion of the structural side post located between the backlight and side window glass on two door vehicles.

Code "09" (D-pillar) refers to the upper and lower portion of the rearward most structural post, usually available on station wagons, vans, or utility vehicles. The D-pillar is not to be confused with the C-pillar which is the rearmost pillar of the passenger compartment on most two and four door vehicles.

Code "10" [Door panel (side)] refers to the side interior surface and related components of a door.

Code "12" (Roof or convertible top) refers to the top structural member of the greenhouse supported by the side pillars, windshield header and backlight header.

Variable Name: Intruding Components (cont'd.)
(1st through 10th)

Code "13" (Roof side rail) refers to the longitudinal horizontal stiffeners located along the edge of the roof.

Code "14" (Windshield) refers to the lateral glazing located at the forward most surface of the greenhouse.

Code "15" (Windshield header) refers to the front forward lateral edge of the roof directly above the windshield.

Code "16" (Window frame) refers to the longitudinal frame that encloses the side window glazings and composes that portion of the door above the window sill.

Code "17" [Floor pan (includes sill)] refers to the floor of the vehicle. This includes the lower portion of the passenger compartment (e.g., door sills).

Code "18" (Backlight header) refers to the rear most lateral edge of the roof directly above the backlight.

Code "19" (Front seat back) refers to the back support of the front seat.

Code "20" (Second seat back) refers to the back support of the second seat.

Code "21" (Third seat back) refers to the back support of the third seat.

Code "22" (Fourth seat back) refers to the back support of the fourth seat.

Code "23" (Fifth seat back) refers to the back support of the fifth seat.

Code "24" (Seat cushion) refers to the horizontal portion of the seat assembly that was designed for seating.

Code "25" [Back door/panel (e.g., tailgate)] refers to the interior surface and related components of the back door or if no door exists, the interior surface of the back wall.

Code "26" (Other interior component) refers to any interior component that may intrude into an occupant seating position.

Code "27" [Side panel - forward of the A (A2)-pillar] refers to the interior panel located on the side of the vehicle and forward of the front doors. This includes areas directly below the instrument panel sometimes referred to as a "kickpanel". See code "06" for A2 definition.

Variable Name: Intruding Components (cont'd.)
(1st through 10th)

Code "28" [Side panel - rear of the A (A2)-pillar] refers to any side surface area excluding doors, window frames, and associated glazing rearward of the A-pillar, below the roof rail, above the sill, and in front of any back door or wall. See code "06" for A2 definition.

Code "30" (Hood) refers to the horizontal structure covering the front compartment of the vehicle located forward of the windshield.

Code "31" (Outside surface of this vehicle) is used when any outside surface of this vehicle not mentioned above has violated the internal boundary surface of the passenger compartment (e.g., spare tire, jack, outside mirror, etc.).

Code "32" (Other exterior object in the environment) refers to an object external to the vehicle (trees, poles, other vehicle, etc.) which penetrates the internal boundary of this vehicle.

Code "33" (Unknown exterior object) is used if there is evidence that an object intruded but it's unknown what that object was.

Code "97" (Catastrophic) is coded when the intrusion damage to the occupant compartment is so devastating that the researcher is not able to discern any of the following: specific occupant locations, intruding components, magnitude of intrusions, and dominant crush.

Code "98" [Intrusion of unlisted component(s)] is used if there is intrusion of any component not listed above.

Code "99" (Unknown) is used for the following situations.

- o The researcher cannot determine if there was any intrusion.
- o The vehicle was under repair at the time of inspection.

Variable Name: Magnitude of Intrusion

Element Values:

- 1 \geq 3 centimeters but < 8 centimeters
- 2 \geq 8 centimeters but < 15 centimeters
- 3 \geq 15 centimeters but < 30 centimeters
- 4 \geq 30 centimeters but < 46 centimeters
- 5 \geq 46 centimeters but < 61 centimeters
- 6 \geq 61 centimeters
- 7 Catastrophic
- 9 Unknown

Source: Vehicle inspection

The extent of component intrusion into a row sector is identified by ranges listed in codes "1"- "6". It should be noted the beginning value of a range should not exceed the pre-impact dimension of that sector. For example, the left front door intruded laterally through sector 11 and continued 25 centimeters into sector 12 [see IV47 et al., code "11" (Front Seat - Left) and code "12" (Front Seat - Middle)]. If each sector had a pre-impact dimension of fifty centimeters, then for sector 11 code "5" (\geq 46 centimeters but < 61 centimeters) and for sector 12 code "3" (\geq 15 centimeters but < 30 centimeters).

As described in the intrusion overview, intrusions are listed in order of severity (i.e., code "6" takes priority over code "5", etc.) with only the ten highest intrusions encoded. Although sector 12 was encoded as the second highest intrusion in the simplistic example listed above, there may be situations where sector 12 would not be captured due to higher intrusion magnitudes in other sectors.

If the magnitude cannot be measured, but can be visibly seen, estimate the magnitude of the intrusion. If the estimated measurement is in the gray area between ranges, then default to the lower range. For example, if a measurement looks like it might be about fourteen or fifteen centimeters, then select the lower code, code "2" (\geq 8 centimeters but < 15 centimeters).

To determine sector dimensions, refer to the measurement techniques outlined in the intrusion overview and variables IV47 et al., Location of Intrusion.

Code "6" (\geq 61 centimeters) is used when an intrusion in a sector equals or exceeds sixty-one centimeters.

Code "7" (Catastrophic) is coded when the intrusion damage to the occupant compartment is so devastating that the researcher is not able to discern any of the following: specific occupant locations, intruding components, magnitude of intrusions, and dominant crush.

Variable Name: Magnitude of Intrusion (cont'd.)

Code "9" (Unknown) is used in the following situations.

- o The researcher cannot determine if there was any intrusion.
- o The vehicle was under repair at the time of inspection.
- o The researcher was not able to measure the intrusion.

Variable Name: Dominant Crush Direction

Element Values:

- 1 Vertical
- 2 Longitudinal
- 3 Lateral
- 7 Catastrophic
- 9 Unknown

Source: Vehicle inspection

Remarks:

This variable assesses the direction of displacement for the component identified in variables IV47 et al. The direction of movement is determined independently from the PDOF applied to the vehicle.

Code "1" (Vertical) refers to components which intrude into the passenger compartment from either an upward or downward direction.

Code "2" (Longitudinal) refers to components which move forward or rearward into the passenger compartment.

Code "3" (Lateral) refers to components which are displaced either left or right within the passenger compartment.

Code "7" (Catastrophic) is coded when the intrusion damage to the occupant compartment is so devastating that the researcher is not able to discern any of the following: specific occupant locations, intruding components, magnitude of intrusions, and dominant crush.

Code "9" (Unknown) is used for the following situations.

- o The researcher cannot determine if there was any intrusion.
- o The vehicle was under repair at the time of inspection.

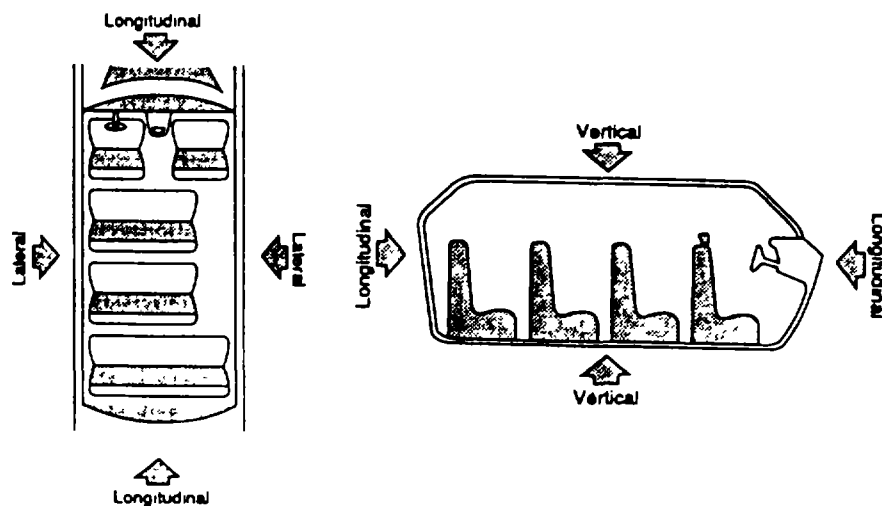

STEERING COLUMN OVERVIEW

Variables IV87 and IV92-IV93 identify specific areas of interest involving the steering column and steering rim/spokes. Information obtained from these components is crucial to the understanding of injury causation.

The researcher is required to identify steering column types and analyze steering rim/spokes (treated as one group) for steering column deformation.

Variable Name: Steering Column Type

Element Values:

- 1 Fixed column
- 2 Tilt column
- 3 Telescoping column
- 4 Tilt and telescoping column
- 8 Other column type (specify):
- 9 Unknown

Source: Vehicle inspection

Code "1" (Fixed column) refers to a standard nonadjustable steering column.

Code "2" (Tilt column) refers to a steering column designed to allow the steering wheel or column to be tilted at an angle selected by the operator to improve driving comfort. The presence of these types can generally be verified by the existence of an extra control stalk on the column. This stalk is separate from the turn signal, headlight, or wiper controls and is usually mounted near the bend point of the tilt wheel, or near the lower part of the instrument panel for the tilt column. Characteristically, the control stalk is unmarked and may be located on the left or right side of the column in relative proximity to the steering wheel end.

Code "3" (Telescoping column) refers to a steering column that has an adjustable length. The column can be shortened or lengthened to suit operator comfort. The telescoping feature can generally be identified by the presence of a knurled ring around the column. Rotating this ring allows the column to be lengthened or shortened, while retightening the ring locks the column at the desired adjustment.

Code "4" (Tilt and telescoping column) refers to a column that has both the tilt wheel and adjustable length features.

Code "8" (Other column type) includes steering columns which cannot be described by elements "1"- "4". This would include swing away columns, etc.

IV88
IV89
IV90
IV91

Variable Name: Blank

VARIABLES IV88 - IV91 ARE LEFT BLANK SO THAT NUMBERING CONSISTENCY CAN BE MAINTAINED WITH THE AUTOMATED FILES OF THE 1988 THROUGH 1993 NASS CRASHWORTHINESS DATA SYSTEM. PREVIOUS NAMES OF VARIABLES ARE AS FOLLOW:

IV88 Steering Column Collapse Due to Occupant Loading

IV89 Direction And Magnitude of Steering Column Vertical Movement

IV90 Direction And Magnitude of Steering Column Lateral Movement

IV91 Direction And Magnitude of Steering Column Longitudinal Movement

Variable Name: Steering Rim/Spoke Deformation

Element Values:

00 No steering rim deformation
Code actual measured deformation to the nearest centimeters.
01-14 Actual measured value in centimeters
15 15 centimeters or more
98 Observed deformation cannot be measured
99 Unknown

Source: Vehicle inspection.

Remarks:

The intent is to capture deformation caused by occupant contact rather than induced damage.

The center of the steering wheel hub is the reference plane for determining magnitude of deformation. A measurement is taken from this reference plane to that area of the rim which has the greatest deformation. This measurement should be referenced to an undisplaced area of the rim or compared to the rim of a similar undamaged vehicle.

The following diagram illustrates this measurement procedure. The undeformed edge is 8 centimeters from the reference line. The deformed edge is 5 centimeters from the reference line. Therefore, 3 centimeters of deformation occurred.

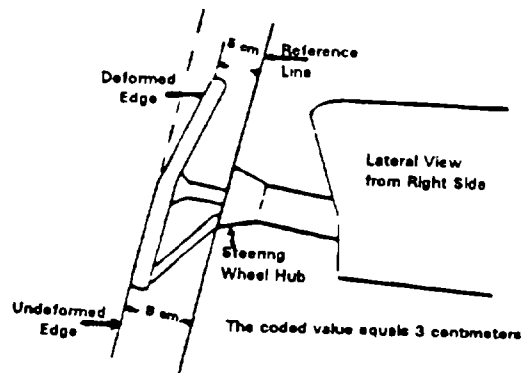

Code "00" (No steering rim deformation) is used when there was no deformation caused by occupant contact of the rim or spokes. Check your observation by placing a flat object (i.e., clipboard) across the plane of the steering rim prior to selecting this code.

Code "01" is used when the deformation is greater than zero but less than 1.5 centimeters.

Code "15" (15 centimeters or more) is used when deformation equals or exceeds 14.5 centimeters.

Variable Name: Steering Rim/Spoke Deformation (cont'd.)

Code "8" (Observed deformation cannot be measured) is used when the situation does not permit the direct measurement of a deformed rim.

Code "9" (Unknown) is used in the following situations.

- o It is not known if the rim was deformed by occupant contact.
- o An assessment of rim damage cannot be made because the vehicle is repaired.

Variable Name: Location of Steering Rim/Spoke Deformation

Element Values:

00 No steering rim deformation

Quarter Sections

- 01 Section A
- 02 Section B
- 03 Section C
- 04 Section D

Half Sections

- 05 Upper half of rim/spoke
- 06 Lower half of rim/spoke
- 07 Left half of rim/spoke
- 08 Right half of rim/spoke
- 09 Complete steering wheel collapse
- 10 Undetermined location
- 99 Unknown

Source: Vehicle inspection

Remarks:

The steering wheel rim is divided into four quarter sections (A through D) and four half sections (upper half, lower half, left half, right half). Note, the half designation should not be considered as a grouping of quarter sections. The accompanying diagrams identify the location of the quarter and half sections.

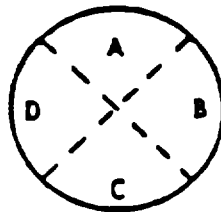

Quarter Sections

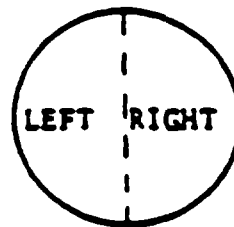
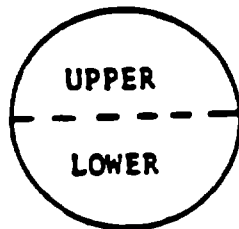

Half Sections

Variable Name: Location of Steering Rim/Spoke Deformation (cont'd.)

Evaluate the deformation of the rim with respect to the wheel design and not the wheel position observed during the vehicle inspection. For example, if the designed top section was deformed and rotated to the bottom position, then the correct response for this variable is "01" (Section A); see below.

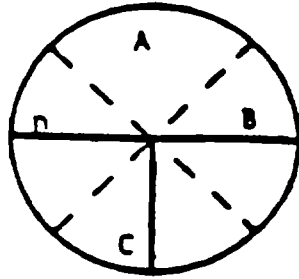

Straight Ahead
Position

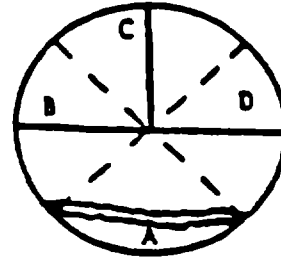

Post-impact
Position

When evaluating which quarter or half to encode, place primary emphasis upon downward deflection since the coding captures occupant caused deformation. When two half sections are deformed, select the half with the greatest deformation.

Code "09" (Complete steering wheel collapse) is used in the event two half sections are deformed axially downward, beyond the hub.

Code "10" (Undetermined location) is used when it is known the rim was deformed, but as the result of extrication or other post-impact activity the original deformed section could not be determined.

Code "99" (Unknown) is used in the following situations.

- o It is not known if the rim was deformed by occupant contact.
- o An assessment of rim damage could not be made as the vehicle was repaired.

Variable Name: Odometer Reading (Kilometers)

Element Values:

Range: 000, 001 through 500, 999

Kilometers - Code to the nearest 1,000 kilometers

000 No odometer
 001 Less than 1,500 kilometers
 500 499,500 kilometers or more
 999 Unknown

Source: Primary source is the vehicle inspection.

Remarks:

This variable measures the distance the vehicle has traveled as indicated on the odometer. However, in cases where it is known that the odometer was working but had turned over (i.e., recycled) the coded value represents the total distance traveled by the vehicle rather than the reading on the odometer. Annotate the source of information when it is determined that the odometer had turned over.

Code to the nearest 1,000 kilometers as in the examples below.

Kilometers: 12,498	Kilometers: 29,418
Code: "012"	Code: "029"
Kilometers: 12,502	Kilometers: 237,673
Code: "013"	Code: "238"

Code "000" (No odometer) is used for vehicles manufactured without an odometer.

Code "001" (Less than 1,500 kilometers) if the vehicle's odometer reading is less than 1,500 kilometers.

Code "999" (Unknown) is used when:

- o it is known that the odometer was disconnected or broken before the collision;
- o the vehicle is equipped with an electronic instrument cluster and an analog "back-up" odometer is not present; or
- o the vehicle's odometer reading is unknown.

Variable Name: Instrument Panel Damage from Occupant Contact?

Element Values:

0 No
1 Yes
9 Unknown

Source: Vehicle inspection only.

Remarks:

Instrument panel damage is defined as damage caused by occupant contact during the impact sequence. This damage includes: breakage, dents, scratches, and abrasions. Deformities resulting from impact forces such as lateral shift or buckling are excluded.

The instrument panel is defined as that panel extending horizontally from A (A1/A2)-pillar to A (A1/A2)-pillar (Figure 1) and vertically from the lower part of the windshield to the lowest vertical edge of the panel (Figure 2). This excludes the steering assembly and all center mounted consoles.

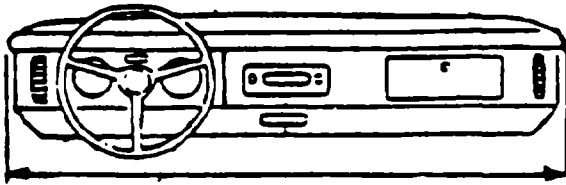

Figure 1

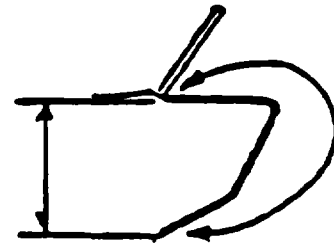

Figure 2

Code "0" (No) is used when the instrument panel was not damaged by occupant contact.

Code "1" (Yes) is used when the instrument panel was damaged by occupant contact.

Code "9" (Unknown) is used when the instrument panel is under repair or replaced.

Variable Name: Knee Bolsters Deformed from Occupant Contact?

Element Values:

- 0 No
- 1 Yes
- 8 Not present
- 9 Unknown

Source: Vehicle inspection.

Remarks:

Knee bolsters are defined as energy absorbing panels fitted to the lower portion of the instrument panel to help restrict forward movement of the front seat occupant's lower body during an accident. Knee bolsters may or may not extend from A (A1/A2)-pillar to A (A1/A2)-pillar depending on the vehicle make and model. Vehicles equipped with a passive restraint system using only an upper torso (shoulder) belt or an airbag are generally equipped with a knee bolster. This padded attachment is designed to prevent the occupant from submarining under the shoulder belt and instrument panel during an impact. The diagram below illustrates the location of the knee bolster in relation to the vehicle occupant.

Right Side Lateral View

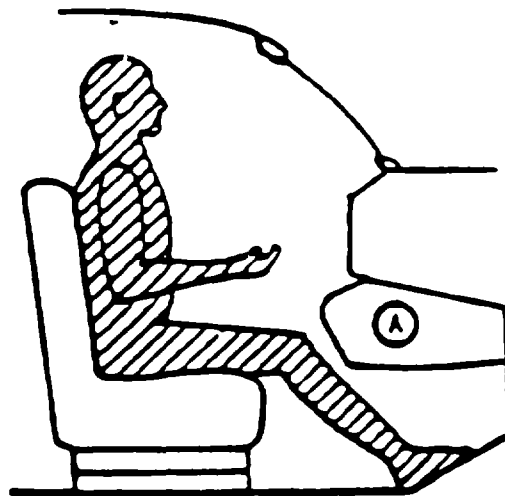

A=Knee Bolster

This variable reports deformation (indentation) of the knee bolster as a result of occupant contact and not as a result of impact related damage.

Code "0" (No) is used when there is no occupant caused deformation of the knee bolster. Minor scuffing and transfers are not considered deformation.

Variable Name: Knee Bolsters Deformed from Occupant Contact? (cont'd.)

Code "1" (Yes) is used when occupant caused deformation is present on the knee bolster. Minor dents are considered deformation; however, scuffing and transfers are not deformation. Occupant contact evidence is included on the Vehicle Interior Sketches page, Points of Occupant Contact page, and highlighted in the photographs.

Code "8" (Not present) is used when no knee bolster is present.

Code "9" (Unknown) is used when knee bolster deformation is present but it is unknown if it was occupant caused.

Variable Name: Did Glove Compartment Door Open During Collision(s)?

Element Values:

- 0 No
- 1 Yes
- 8 Not present
- 9 Unknown

Source: Researcher determined; inputs include the vehicle inspection and interview.

Remarks:

This variable reports the status of the glove compartment door (if present) during an accident. The primary objective is to determine whether the door latch mechanism released during a collision(s).

Code "0" (No) is used when the door did not open or the door opened but the latch mechanism did not fail (e.g., body of door separates from the latch mechanism which is intact and engaged).

Code "1" (Yes) is used when the door opened because the latch mechanism released. Reasons may include: occupant contact, shifting or buckling of vehicle components, or impact forces.

Code "8" (Not present) is used when no glove compartment door is available (i.e., vans).

Code "9" (Unknown) is used when:

- o that portion of the instrument panel is under repair, or
- o the glove box door is known to be open but it is unknown whether the door opened as a result of the accident [i.e., door could have been open prior to the accident, or it could have been opened after the accident (e.g., to remove driver registration information)].

**INSTRUCTIONS FOR COMPLETION OF VEHICLE INTERIOR SKETCHES
AND POINTS OF OCCUPANT CONTACT PAGES**

The VEHICLE INTERIOR SKETCHES page and corresponding POINTS OF OCCUPANT CONTACT page provide a valuable link between vehicle interior documentation and occupant injury data. Properly completed, these records identify evidence of occupant contact points and relate the contact points to the part of the occupant's body that produced the evidence.

In completing the Vehicle Interior Sketches, assess the occupant trajectory in conjunction with the impact configuration, direction of force, and use of restraints. As contact points are identified, they should be documented as follows.

- o Sketch the damaged area on the instrument panel outline (e.g., radio, glove compartment, damage to instrument panel structure).
- o Annotate the contacted area with a letter (begin with A) and list on the Points of Occupant Contact page.
- o In the column adjacent to the respective letter, identify the interior component contacted. Specify the number of the contacting occupant if it can be determined.
- o Identify the type of evidence present (i.e., scuff, tissue transfer, tooth, etc.) in the "Supporting Physical Evidence" column.
- o Specify the level of confidence which you feel best represents your conclusion using the scale of: 1 (Certain), 2 (Probable), 3 (Possible), or 4 (Unknown).
- o Within the vehicle, highlight the contact with yellow (or similar) tape for photographic purposes.
- o Annotate the area through which the occupant was ejected or the area in which the occupant was entrapped.

An example of a completed Vehicle Interior Sketches (Page 4) and Points of Occupant Contact (Page 5) page follow. If sufficient space is not available to identify all contacts, use the back of the Page 4.

INSTRUCTIONS FOR COMPLETION OF VEHICLE INTERIOR SKETCHES AND POINTS OF OCCUPANT CONTACT PAGES

(2)

VEHICLE INTERIOR SKETCHES

Note area of ejection/entrapment

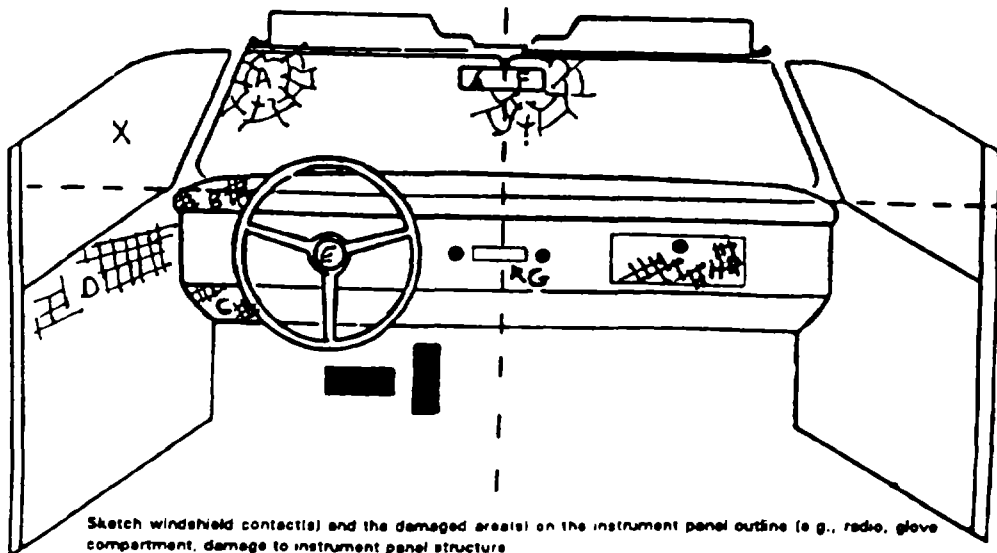
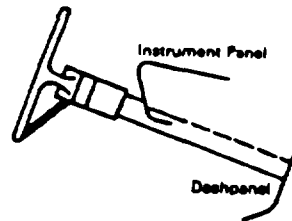
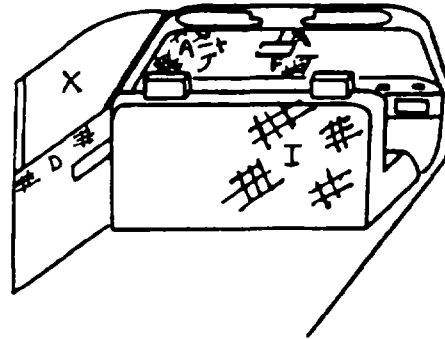
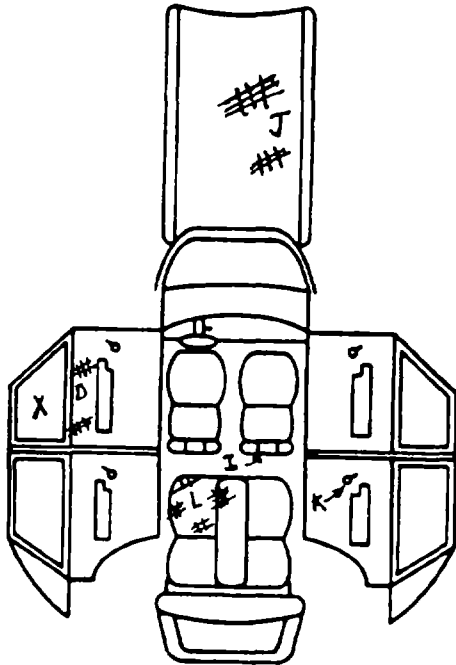

Sketch windshield contact(s) and the damaged area(s) on the instrument panel outline (e.g., radio, glove compartment, damage to instrument panel structure)
 Cross hatch contact points, draw spider webs or use other annotation as may be appropriate
 Annotate the contacted area with a letter (begin with A) and list on the Points of Occupant Contact page

INSTRUCTIONS FOR COMPLETION OF VEHICLE INTERIOR SKETCHES AND POINTS OF OCCUPANT CONTACT PAGES

(3)

POINTS OF OCCUPANT CONTACT					
Contact	Interior Component Contacted	Occupant No. If Known	Body Region If Known	Supporting Physical Evidence	Confidence Level of Contact Point
A	01	1	head	dark hair, windshield contact	1
B	09	1	hand	deformation, tissue transfer	1
C	09	1	L. knee	Plastic cracked, denim scuff	1
D	20	1	shoulder	deformed outward	1
E	06	1	chest	rim deformed, hub on floor	1
F	15	2	head	mirror cracked, contacted windshield	1
G	10	2	unknown	control knob missing	2
H	12	2	knees	Plastic door shattered	1
I	40	3	Torso	deformed forward, scuff, torn	1
J	54	3	head	hair lodged in roof covering	1
K	30	3	unknown	door handle missing	3
L	40	3	---	blood deposit, probable FRP=3	2
M					
N					

CODES FOR INTERIOR COMPONENTS

FRONT

- (01) Windshield
- (02) Mirror
- (03) Sunvisor
- (04) Steering wheel rim
- (05) Steering wheel hub/spoke
- (06) Steering wheel (combination of codes 04 and 05)
- (07) Steering column, transmission selector lever, other attachment
- (08) Add on equipment (e.g., CB, tape deck, air conditioner)
- (09) Left instrument panel and below
- (10) Center instrument panel and below
- (11) Right instrument panel and below
- (12) Glove compartment door
- (13) Knee bolster
- (14) Windshield including one or more of the following: front header, A (A1/A2)-pillar, instrument panel, mirror, or steering assembly (driver side only)
- (15) Windshield including one or more of the following: front header, A (A1/A2)-pillar, instrument panel, or mirror (passenger side only)
- (16) Driver side air bag compartment cover
- (17) Passenger side air bag compartment cover
- (18) Windshield reinforced by exterior object (specify) _____
- (19) Other front object (specify): _____

LEFT SIDE

- (20) Left side interior surface, excluding hardware or armrests
- (21) Left side hardware or armrest
- (22) Left A (A1/A2) pillar

(23) Left B-pillar

- (24) Other left pillar (specify): _____
- (25) Left side window glass or frame
- (26) Left side window glass including one or more of the following: frame, window sill, A (A1/A2)-pillar, B pillar, or roof side rail.
- (27) Other left side object (specify): _____
- (28) Left side window sill

RIGHT SIDE

- (30) Right side interior surface, excluding hardware or armrests
- (31) Right side hardware or armrest
- (32) Right A (A1/A2)-pillar
- (33) Right B-pillar
- (34) Other right pillar (specify): _____
- (35) Right side window glass or frame
- (36) Right side window glass including one or more of the following: frame, window sill, A (A1/A2)-pillar, B pillar, or roof side rail.
- (37) Other right side object (specify): _____
- (38) Right side window sill

INTERIOR

- (40) Seat, back support
- (41) Belt restraint webbing/buckle
- (42) Belt restraint B-pillar attachment point
- (43) Other restraint system component (specify): _____
- (44) Head restraint system
- (45) Air bag (use codes "16" and "17" for injuries sustained from air bag compartment covers)

(46) Other occupants (specify): _____

- (47) Interior loose objects
- (48) Child safety seat (specify): _____
- (49) Other interior object (specify): _____

ROOF

- (50) Front header
- (51) Rear header
- (52) Roof left side rail
- (53) Roof right side rail
- (54) Roof or convertible top

FLOOR

- (56) Floor (including toe pan)
- (57) Floor or console mounted transmission lever, including console
- (58) Parking brake handle
- (59) Foot controls including parking brake

REAR

- (60) Backlight (rear window)
- (61) Backlight storage rack, door, etc.
- (62) Other rear object (specify): _____

CONFIDENCE LEVEL OF CONTACT POINT

- (1) Certain
- (2) Probable
- (3) Possible
- (9) Unknown

MANUAL RESTRAINTS

Restraint usage data, recorded on the noncoded section of the Interior Vehicle Form under the title "MANUAL RESTRAINTS", is based solely on the evidence obtained during the vehicle inspection.

An indication of restraint usage is determined for every seating position in the vehicle, regardless of whether the seating position is occupied. The "indication of usage" represents "recent usage" rather than "usage ever", whenever possible. The following evidence is sought when assessing restraint usage:

- o **belts/fittings damaged by occupant loading:** deformed anchor components, stretched webbing, latch metal peening (loading impression on metal);
- o **placement of belts:** on, behind, or under seatbacks or cushions; and,
- o **condition of belts:** dirty, dust covered, mechanically unusable, knotted, size adjustment on fixed length belts, cut for convenience or comfort (out of the way, near housings), or cut for occupant extraction by emergency personnel (usually at an easily accessible position).

Restraint "usage in this accident" is not generally determined on the Interior Vehicle Form. Vehicle evidence along with police report information, interviews, relationship of contact points to seat position given the PDOF applied to the vehicle, presence of belt-caused occupant injuries, and presence or absence of ejection are considered before encoding restraint usage on the Occupant Assessment Form.

CHILD SAFETY SEAT FIELD ASSESSMENT

For each child safety seat present in the vehicle, assign (unless you have knowledge regarding what the occupant's number is) the seat a temporary occupant number. Determine the correct answer for each of the six row variables present on the reverse side of Page 6. Due to the transient nature of child safety seats, annotate questions regarding its position for use during the interview. From this data, the actual position of the child safety seat at the time of the accident and the occupant's correct number can be determined for the inclusion on the Occupant Assessment Form.



OCCUPANT ASSESSMENT FORM

1. Primary Sampling Unit Number _____

2. Case Number - Stratum _____

3. Vehicle Number _____

4. Occupant Number _____

OCCUPANT'S CHARACTERISTICS

5. Occupant's Age _____
Code actual age at time of accident.
(00) Less than one year old (specify by month): _____
(97) 97 years and older
(99) Unknown

6. Occupant's Sex _____
(1) Male
(2) Female
(9) Unknown

7. Occupant's Height _____
Code actual height to the nearest centimeter.
(999) Unknown

_____ inches X 2.54 = _____ centimeters

8. Occupant's Weight _____
Code actual weight to the nearest kilogram.
(999) Unknown

_____ pounds X .4536 = _____ kilograms

9. Occupant's Role _____
(1) Driver
(2) Passenger
(9) Unknown

OCCUPANT'S SEATING

10. Occupant's Seat Position _____

Front Seat
(11) Left side
(12) Middle
(13) Right side
(14) Other (specify): _____
(15) On or in the lap of another occupant

Second Seat
(21) Left side
(22) Middle
(23) Right side
(24) Other (specify): _____
(25) On or in the lap of another occupant

Third Seat
(31) Left side
(32) Middle
(33) Right side
(34) Other (specify): _____
(35) On or in the lap of another occupant

Fourth Seat
(41) Left side
(42) Middle
(43) Right side
(44) Other (specify): _____
(45) On or in the lap of another occupant

(97) In or on unenclosed area
(98) Other seat (specify): _____
(99) Unknown

11. Occupant's Posture _____
(0) Normal posture

Abnormal posture
(1) Kneeling or standing on seat
(2) Lying on or across seat
(3) Kneeling, standing or sitting in front of seat
(4) Sitting sideways or turned to talk with another occupant or to look out a rear window
(5) Sitting on a console
(6) Lying back in a reclined seat position
(7) Bracing with feet or hands on a surface in front of seat
(8) Other abnormal posture (specify): _____
(9) Unknown

EJECTION/ENTRAPMENT

12. Ejection _____

- (0) No ejection
- (1) Complete ejection
- (2) Partial ejection
- (3) Ejection, unknown degree
- (9) Unknown

13. Ejection Area _____

- (0) No ejection
- (1) Windshield
- (2) Left front
- (3) Right front
- (4) Left rear
- (5) Right rear
- (6) Rear
- (7) Roof
- (8) Other area (e.g., back of pickup, etc.)
(specify): _____
- (9) Unknown

14. Ejection Medium _____

- (0) No ejection
- (1) Door/hatch/tailgate
- (2) Nonfixed roof structure
- (3) Fixed glazing
- (4) Nonfixed glazing (specify):

- (5) Integral structure
- (8) Other medium (specify):

- (9) Unknown

15. Medium Status (Immediately Prior To Impact) _____

- (0) No ejection
- (1) Open
- (2) Closed
- (3) Integral structure
- (9) Unknown

16. Entrapment _____

- (NOTE: Entrapped means that part of the person was in the vehicle and mechanically restrained; jammed doors and immobilizing injuries by themselves are not sufficient to constitute entrapment.)
- (0) Not entrapped
 - (1) Entrapped
 - (9) Unknown

RESTRAINT SYSTEM EVALUATION

17. Manual (Active) Belt System Availability _____

- (0) None available
- (1) Belt removed/destroyed
- (2) Shoulder belt
- (3) Lap belt
- (4) Lap and shoulder belt
- (5) Belt available—type unknown

Integral Belt Partially Destroyed

- (6) Shoulder belt (lap belt destroyed/removed)
- (7) Lap belt (shoulder belt destroyed/removed)

(8) Other belt (specify): _____

(9) Unknown _____

18. Manual (Active) Belt System Use _____

- (00) None used, not available, or belt removed/destroyed
- (01) Inoperative (specify): _____

- (02) Shoulder belt
- (03) Lap belt
- (04) Lap and shoulder belt
- (05) Belt used—type unknown
- (08) Other belt used (specify): _____

- (12) Shoulder belt used with child safety seat
- (13) Lap belt used with child safety seat
- (14) Lap and shoulder belt used with child safety seat
- (15) Belt used with child safety seat—type unknown
- (18) Other belt used with child safety seat (specify): _____
- (99) Unknown if belt used

19. Proper Use of Manual (Active) Belts _____

- (0) None used or not available
- (1) Belt used properly
- (2) Belt used properly with child safety seat

Belt Used Improperly

- (3) Shoulder belt worn under arm
- (4) Shoulder belt worn behind back or seat
- (5) Belt worn around more than one person
- (6) Lap belt worn on abdomen
- (7) Lap belt or lap and shoulder belt used improperly with child safety seat (specify): _____

(8) Other improper use of manual belt system (specify) _____

(9) Unknown _____

20. Manual (Active) Belt Failure Modes _____

During Accident

- (0) No manual belt used
- (1) No manual belt failure(s)
- (2) Torn webbing (stretched webbing not included)
- (3) Broken buckle or latchplate
- (4) Upper anchorage separated
- (5) Other anchorage separated (specify): _____

(6) Broken retractor _____

(7) Combination of above (specify): _____

(8) Other manual belt failure (specify). _____

(9) Unknown _____

21. Air Bag System Availability/Function _____

- (0) Not equipped/not available
- (1) Air bag

Non-functional

(2) Air bag disconnected (specify): _____

(3) Air bag not reinstalled _____

(9) Unknown _____

22. Air Bag System Deployment _____

- (0) Not equipped/not available
- (1) Air bag deployed during accident (as a result of impact)
- (2) Air bag deployed inadvertently just prior to accident
- (3) Air bag deployed, accident sequence undetermined
- (4) Nondeployed
- (5) Unknown if deployed
- (6) Air bag deployed as a result of a noncollision event during accident sequence (e.g., fire, explosion, electrical)
- (9) Unknown

23. Are There Indications of Air Bag System Failure? _____

- (0) Not equipped/not available
- (1) No
- (2) Yes (specify): _____

(9) Unknown _____

Note: See Variables 44 through 48 (Page 5) for Information on Automatic Belts

24. Police Reported Restraint Use _____

- (0) None used
- (1) Police did not indicate restraint use
- (2) Shoulder belt
- (3) Lap belt
- (4) Lap and shoulder belt
- (5) Belt used, type not specified
- (6) Child safety seat
- (7) Other or automatic restraint (specify): _____

(8) Restrained, type unknown _____

(9) Police indicated "unknown" _____

HEAD RESTRAINT AND SEAT EVALUATION

25. Head Restraint Type/Damage by Occupant at This Occupant Position _____
- (0) No head restraints
 - (1) Integral—no damage
 - (2) Integral—damaged during accident
 - (3) Adjustable—no damage
 - (4) Adjustable—damaged during accident
 - (5) Add-on—no damage
 - (6) Add-on—damaged during accident
 - (8) Other (specify): _____
 - (9) Unknown

26. Seat Type (this Occupant Position) _____
- (00) Occupant not seated or no seat
 - (01) Bucket
 - (02) Bucket with folding back
 - (03) Bench
 - (04) Bench with separate back cushions
 - (05) Bench with folding back(s)
 - (06) Split bench with separate back cushions
 - (07) Split bench with folding back(s)
 - (08) Pedestal (i.e., column supported)
 - (09) Other seat type (specify): _____
 - (10) Box mounted seat (i.e., van type)
 - (99) Unknown

27. Seat Performance (this Occupant Position) _____
- (0) Occupant not seated or no seat
 - (1) No seat performance failure(s)
 - (2) Seat adjusters failed
 - (3) Seat back folding locks or "seat back" failed (specify): _____
 - (4) Seat track/anchors failed
 - (5) Deformed by impact of occupant
 - (6) Deformed by passenger compartment intrusion (specify): _____
 - (7) Combination of above (specify): _____
 - (8) Other (specify): _____
 - (9) Unknown

CHILD SAFETY SEAT

28. Child Safety Seat Make/Model _____
 (000) No child safety seat
 Applicable codes are found in your NASS CDS
 Data Collection, Coding and Editing
 (950) Built-in child safety seat
 (997) Other make/model (specify):

 (998) Unknown make/model
 (999) Unknown if child safety seat used
29. Type of Child Safety Seat _____
 (0) No child safety seat
 (1) Infant seat
 (2) Toddler seat
 (3) Convertible seat
 (4) Booster seat
 (7) Other type child safety seat (specify):

 (8) Unknown child safety seat type
 (9) Unknown if child safety seat used
30. Child Safety Seat Orientation _____
 (00) No child safety seat
- Designed for Rear Facing for This Age/Weight*
 (01) Rear facing
 (02) Forward facing
 (08) Other orientation (specify):

 (09) Unknown orientation
- Designed For Forward Facing for This Age/Weight*
 (11) Rear facing
 (12) Forward facing
 (18) Other orientation (specify):

 (19) Unknown orientation
- Unknown Design or Orientation For This
 Age/Weight, or Unknown Age/Weight*
 (21) Rear facing
 (22) Forward facing
 (28) Other orientation (specify):

 (29) Unknown orientation
- (99) Unknown if child safety seat used

31. Child Safety Seat Harness Usage _____
32. Child Safety Seat Shield Usage _____
33. Child Safety Seat Tether Usage _____

Note: Options below applicable to
 Variables OA31-OA33.

(00) No child safety seat

Not Designed With Harness/Shield/Tether

- (01) After market harness/shield/tether
 added, not used
 (02) After market harness/shield/tether used
 (03) Child safety seat used, but no after market
 harness/shield/tether added
 (09) Unknown if harness/shield/tether
 added or used

Designed With Harness/Shield/Tether

- (11) Harness/shield/tether not used
 (12) Harness/shield/tether used
 (19) Unknown if harness/shield/tether used

Unknown If Designed With Harness/Shield/Tether

- (21) Harness/shield/tether not used
 (22) Harness/shield/tether used
 (29) Unknown if harness/shield/tether used
- (99) Unknown if child safety seat used

INJURY CONSEQUENCES

34. Injury Severity (Police Rating) _____

- (0) O - No injury
- (1) C - Possible injury
- (2) B - Nonincapacitating injury
- (3) A - Incapacitating injury
- (4) K - Killed
- (5) U - Injury, severity unknown
- (6) Died prior to accident
- (9) Unknown

35. Treatment - Mortality _____

- (0) No treatment
- (1) Fatal
- (2) Fatal - ruled disease (specify):

Nonfatal

- (3) Hospitalization
- (4) Transported and released
- (5) Treatment at scene - nontransported
- (6) Treatment later
- (8) Treatment - other (specify):

- (9) Unknown

36. Type Of Medical Facility (for Initial Treatment) _____

- (0) Not treated at a medical facility
- (1) Trauma center
- (2) Hospital
- (3) Medical clinic
- (4) Physician's office
- (5) Treatment later at medical facility
- (8) Other (specify):

- (9) Unknown

37. Hospital Stay _____

- (00) Not Hospitalized
- _____ Code the number of days (up through 60)
that the occupant stayed in hospital.
- (61) 61 days or more
- (99) Unknown

38. Working Days Lost _____

- _____ Code the number of days
(up through 60) that the occupant
lost from work due to the accident
- (00) No working days lost
- (61) 61 days or more
- (62) Fatally injured
- (97) Not working prior to accident
- (99) Unknown

STOP - GO TO VARIABLE 44 ON PAGE 7**VARIABLES 39 THROUGH 43 ARE
COMPLETED BY THE ZONE CENTER**

39. Time to Death _____

- _____ Code number of hours from time of
accident to time of death up through 24
hours. If time of death is greater than 24
hours, code number of days. (Note: 1 day =
31, 2 days = 32, ... n days = 30 + n up
through 30 days = 60)
- (00) Not fatal
- (96) Fatal - ruled disease
- (99) Unknown

40. 1st Medically Reported Cause of Death _____

41. 2nd Medically Reported Cause of Death _____

42. 3rd Medically Reported Cause of Death _____

- _____ Code the Occupant Injury from line
number(s) for the medically reported
injury(s) which reportedly contributed to
this occupant's death
- (00) Not fatal or no additional causes
- (96) Mode of death given but specific
injuries are not linked to cause
of death. (specify):

- (97) Other result (includes fatal ruled
disease) (specify):

- (99) Unknown

43. Number of Recorded Injuries for
This Occupant _____

- _____ Code the actual number of
injuries recorded for this occupant.
- (00) No recorded injuries
- (97) Injured, details unknown
- (99) Unknown if injured

AUTOMATIC BELT SYSTEM	
<p>44. Automatic (Passive) Belt System Availability/Function _____</p> <p>(0) Not equipped/not available</p> <p>(1) 2 point automatic belts</p> <p>(2) 3 point automatic belts</p> <p>(3) Automatic belts - type unknown</p> <p><i>Non-functional</i></p> <p>(4) Automatic belts destroyed or rendered inoperative</p> <p>(9) Unknown</p>	<p>48. Automatic (Passive) Belt Failure Modes During Accident _____</p> <p>(0) Not equipped/not available/not in use</p> <p>(1) No automatic belt failure(s)</p> <p>(2) Torn webbing (stretched webbing not included)</p> <p>(3) Broken buckle or latchplate</p> <p>(4) Upper anchorage separated</p> <p>(5) Other anchorage separated (specify): _____</p> <p>(6) Broken retractor</p> <p>(7) Combination of above (specify): _____</p> <p>(8) Other automatic belt failure (specify): _____</p> <p>(9) Unknown</p>
<p>45. Automatic (Passive) Belt System Use _____</p> <p>(0) Not equipped/not available/destroyed or rendered inoperative</p> <p>(1) Automatic belt in use</p> <p>(2) Automatic belt not in use (manually disconnected, motorized track inoperative) (specify): _____</p> <p>(3) Automatic belt use unknown</p> <p>(9) Unknown</p>	<p>49. Seat Orientation (this Occupant Position) _____</p> <p>(0) Occupant not seated or no seat</p> <p>(1) Forward facing seat</p> <p>(2) Rear facing seat</p> <p>(3) Side facing seat (inward)</p> <p>(4) Side facing seat (outward)</p> <p>(8) Other (specify): _____</p> <p>(9) Unknown</p>
<p>46. Automatic (Passive) Belt System Type _____</p> <p>(0) Not equipped/not available</p> <p>(1) Non-motorized system</p> <p>(2) Motorized system</p> <p>(9) Unknown</p>	<p>Check the Primary Source Used In Determining Belt Use.</p> <p><input type="checkbox"/> Not equipped/not available/destroyed or rendered inoperative</p> <p><input type="checkbox"/> Vehicle inspection</p> <p><input type="checkbox"/> Official injury data</p> <p><input type="checkbox"/> Driver/occupant interview</p> <p><input type="checkbox"/> Other (specify): _____</p> <p><input type="checkbox"/> Unknown if belt used</p> <p>_____</p> <p>_____</p> <p>_____</p> <p>_____</p>
<p>47. Proper Use of Automatic (Passive) Belt System _____</p> <p>(0) Not equipped/not available/not used</p> <p>(1) Automatic belt used properly</p> <p>(2) Automatic belt used properly with child safety seat</p> <p><i>Automatic Belt Used Improperly</i></p> <p>(3) Automatic shoulder belt worn under arm</p> <p>(4) Automatic shoulder belt worn behind back</p> <p>(5) Automatic belt worn around more than one person</p> <p>(6) Lap portion of automatic belt worn on abdomen</p> <p>(7) Automatic lap and shoulder belt or automatic shoulder belt used improperly with child safety seat (specify): _____</p> <p>(8) Other improper use of automatic belt system (specify): _____</p> <p>(9) Unknown</p>	<p>Check the Primary Source Used In Determining Belt Use.</p> <p><input type="checkbox"/> Not equipped/not available/destroyed or rendered inoperative</p> <p><input type="checkbox"/> Vehicle inspection</p> <p><input type="checkbox"/> Official injury data</p> <p><input type="checkbox"/> Driver/occupant interview</p> <p><input type="checkbox"/> Other (specify): _____</p> <p><input type="checkbox"/> Unknown if belt used</p> <p>_____</p> <p>_____</p> <p>_____</p> <p>_____</p>

ARE ALL APPLICABLE MEDICAL RECORDS INCLUDED WITH INITIAL SUBMISSION? NO [] YES []

UPDATE CANDIDATE? NO [] YES []

STOP - VARIABLES 50 THROUGH 53 ARE COMPLETED BY THE ZONE CENTER

TRAUMA DATA

50. Glasgow Coma Scale (GCS) Score _____
 (at Medical Facility)
 (00) Not injured
 (01) Injured - not treated at medical facility
 (02) No GCS Score at medical facility
 (03-15) Code the actual value of the
 initial GCS Score recorded at medical
 facility.
 (97) Injured, details unknown
 (99) Unknown if injured
51. Was the Occupant Given Blood? _____
 (1) No - blood not given
 (2) Yes - blood given
 (specify units): _____
 (9) Unknown if blood given
52. Arterial Blood Gases (ABG) - HCO_3 _____
 (00) Not injured
 (01) Injured, ABGs not measured or reported
 (02-50) Code the actual value of the HCO_3
 (96) ABGs reported, HCO_3 unknown
 (97) Injured, details unknown
 (99) Unknown if injured

BELT USE DETERMINATION

53. Primary Source of Belt Use Determination _____
 (0) Not equipped/not available/destroyed
 or rendered inoperative
 (1) Vehicle inspection
 (2) Official injury data
 (3) Driver/occupant interview
 (8) Other (specify): _____
 (9) Unknown if belt used

Variable Name: Vehicle Number

Element Values:

Range: 01 through 30

Source: Researcher assigned.

Remarks:

Code the Vehicle Number for the vehicle, in or on which, this occupant was riding (i.e., as a driver or as a passenger--in or on the vehicle). See GV03, Vehicle Number.

Assume that only one occupant is in a hit-and-run vehicle (unless reliable evidence to the contrary exists), and assume this person is the driver.

This variable is a file structuring variable.

Variable Name: Occupant Number

Element Values:

Range: 01 through 30

Source: Researcher assigned.

Remarks:

Occupant numbers must be assigned sequentially, beginning in the enclosed area with "01". No numbers may be skipped. Assign numbers left to right and front to back among occupants.

Assign numbers last to persons on the vehicle or in an unenclosed area. Persons appended to vehicle for motion (e.g., bicyclist holding onto vehicle) are either pedestrians or other nonmotorists and not occupants; therefore, no form is completed, and no number is assigned.

Drivers do not have to be coded "01" (e.g., right hand drive vehicles containing left front occupant). However, code the assumed driver of a hit-and-run vehicle as "01".

An occupant on or in the lap of another person should be assigned a number one higher than the person whose lap they were on or in.

Occupants sharing a seating position should be assigned numbers using the guidelines stated in the first paragraph above.

This variable is a file structuring variable.

OCCUPANT'S CHARACTERISTICS OVERVIEW

The Occupant's characteristics section of the Occupant Assessment Form consists of two areas, physical characteristics, and role/position. These two areas provide a coded sketch of the occupant. Physical characteristics are noted in the variables OA06 (Occupant's Sex), OA07 (Occupant's Height), and OA08 (Occupant's Weight). The demographics of the occupant are completed by the variable OA05 (Occupant's Age). Position and function of the occupant are also critical bits of information in the overall picture of the accident. These are provided by the variables OA10 (Occupant's Seating Position), OA09 (Occupant's Role), and OA11 (Occupant's Posture).

This section provides a base of information that is vital to the analytical process. Ergonomic engineers design the interior of vehicles to be most comfortable for a range of occupants. The height and weight for a particular age bracket are considered in establishing the leg room, head room, and other interior dimensions for a vehicle. Restraint design relies heavily on this type of information. Initial designs of active belts were determined to be very uncomfortable and difficult to wear. The use of a wider range of heights and weights, which also has a bearing on seat adjustments, resulted in belts which were much more comfortable to wear and therefore encouraged use.

Occupant demographics and position play an important role in the injury mechanism, restraint system effectiveness, and vehicle design analysis. For example, the vehicle design, which includes the restraint system, must take into consideration the differences between a 163 centimeters, 45 kilograms driver and a 198 centimeters, 136 kilograms passenger. Both of these occupants must be provided with the same amount of protection by the vehicle in an accident.

Societal costs are also derived from these variables and the related injury assessment variables in this and the Occupant Injury Form.

In many cases the only source for this information is the interview. For this reason the researcher should ask probing questions to elicit complete and accurate responses to these, and all other, variables.

Federal Motor Vehicle Safety Standards--FMVSS 202 (Head Restraints), FMVSS 206 (Door Locks and Door Retention Components), FMVSS 207 (Seating Systems), FMVSS 208 (Occupant Protection), FMVSS 212 (Windshield Mountings), FMVSS 213 (Child Restraint System), and FMVSS 214 (Side Door Strength), are all assessed relative to their potential for reduction of injury to occupants. For this reason it is necessary to have the occupant's characteristics as complete as possible for correct and accurate assessment of the various vehicle components and FMVSS's which apply.

Variable Name: Occupant's Age

Element Values:

Range: 00-97, 99
00 Less than one year old
97 97 years and older
99 Unknown

Source: Primary source is interviewee; secondary sources include police reports and other official records (i.e., medical records).

Remarks:

The occupant's age at the time of the accident is recorded with respect to the occupant's last birthday.

If you are unable to obtain the age of a driver, request a driver's license record. This action must be discussed and a policy determined with your zone center and COTR. Licensing file data takes precedence over police or interview data.

Variable Name: Occupant's Sex

Element Values:

- 1 Male
- 2 Female
- 9 Unknown

Source: Primary source is interviewee; secondary sources include police report and official records (e.g., medical).

Remarks:

Code "1" (Male) consists of men and boys; of the masculine gender.

Code "2" (Female) consists of women and girls; of the feminine gender.

Variable name: Occupant's Height

Element Values:

Range: 030 through 220 centimeters

999 Unknown

Source: Researcher determined--inputs include interviewee or official records (e.g., medical).

Remarks:

Code actual height to nearest centimeter.

Code "220" (220 centimeters) is used for any occupant whose height equals or exceeds 219.5 centimeters.

The PAR may be used as a source if it contains this data, but it is superseded if other data exists.

Autopsies often include this information; use it when present.

Conversion: 1 inch = 2.54 centimeters

Variable Name: Occupant's Weight

Element Values:

Range: 002 through 150 kilograms
999 Unknown

Source: Researcher determined--inputs include interviewee or official records (e.g., medical)

Remarks:

Code actual weight to nearest kilogram.

Code "150" (150 kilograms) is used for any occupant whose weight equals or exceeds 149.5 kilograms.

The PAR may be used as a source if it contains this data, but it is superseded if other data exists.

Autopsies often include this information; use it when present.

Conversion: 1 pound = .4536 kilograms

Variable Name: Occupant's Role

Element Values:

- 1 Driver
- 2 Passenger
- 9 Unknown

Source: Primary source is interviewee; secondary source is police report.

Remarks:

Hit-and-run vehicles are assumed to have only one occupant (unless reliable evidence to the contrary exists), and that person is assumed to be the driver. All other persons riding in or on the vehicle are considered to be passengers.

Variable Name: Occupant's Seat Position

Element Values:

Front Seat	Third Seat
11 Left side	31 Left side
12 Middle	32 Middle
13 Right side	33 Right side
14 Other (specify)	34 Other (specify)
15 On or in the lap of another occupant	35 On or in the lap of another occupant
Second Seat	Fourth Seat
21 Left side	41 Left side
22 Middle	42 Middle
23 Right side	43 Right side
24 Other (specify)	44 Other (specify)
25 On or in the lap of another occupant	45 On or in the lap of another occupant
97 In or on unenclosed area	
98 Other seat (specify)	
99 Unknown	

Source: Primary source is interviewee; secondary source is police report.

Remarks:

Seat position is coded by the location of the occupant in relation to the seat row and the forward longitudinal axis of the vehicle.

Only one person may be assigned seating positions "11" through "13", "21" through "23", "31" through "33", and "41" through "43". When two or more persons are occupying the same seating location (e.g., sitting side-by-side), assign the seat position as follows:

- first, to the occupant who is using the manual and/or automatic belt; if more than one occupant is using the manual and/or automatic belt or if no occupant is using a manual and/or automatic belt, then
- second, to the oldest occupant.

In seat rows designed for only two passengers, use codes "11", "13", "21", "23", "31", "33", "41", "43", or "98".

Code "11" (Front Seat - Left side) should be assigned to the assumed driver of a hit-and-run vehicle unless evidence indicates a different position for the person or persons.

Codes "14", "24", "34", "44", (... - Other) and "98" (Other seat) can be used in a variety of occupant seating situations. Some example situations are:

Variable Name: Occupant's Seat Position (cont'd.)

- occupant on the floor [i.e., in front of a designated seat (e.g., sitting, standing, etc.)];
- occupant lying across one or more seating positions; and
- occupant sitting side-by-side of another occupant in the same seating position--only one can be assigned the seating position;

If an occupant is standing or kneeling in a designated seating position, the occupant is assigned that seating position with exceptions as noted above. That the occupant is not correctly seated is captured in variable OA11 (Occupant's Posture).

If the only seat in the front seating area is a driver's seat (e.g., bucket, pedestal, etc.) and the occupant was in the area but not in the seat, code "14" (Front Seat - Other) is used. This situation could occur because of vehicle design or seat removal. The same logic applies to other seat areas. A person in the fourth seat row but not in a seat is coded "44" (Fourth Seat - Other), and the actual position described.

Codes "15", "25", "35", "45" (... - On or in the lap of another occupant) and "98" (Other seat) are used whenever an occupant(s) is sitting, standing, etc. in or in the lap of another occupant.

Code "97" (In or on unenclosed area) includes those occupants riding on a fender, the boot of a convertible, the open cargo box on a light truck, etc.

Code "98" (Other seat) is used for anyone in the fifth or higher numbered seat area. In addition, use this code when an occupant(s) is in an enclosed area where no defined seating exists. Further, if an occupant(s) is using a fold-down type seat in its folded down position, then use this code.

If seating in the vehicle is longitudinal rather than lateral, use the basic idea of a vehicle interior being divided laterally into roughly equal thirds and visualize lateral rows of seats to determine what seat position is the best descriptor. The diagram below illustrates the intended seat positions for areas of a vehicle.

For rearward facing seats use the basic idea described above in the previous paragraph to describe the occupant's seat position. The fact that the seat does not face forward is addressed in OA11, Occupant's Posture.

Using the diagram below, coding for seat positions "11", "13", "21", "22", "23", "31", "41", and "98" are self-explanatory. For someone seated in the far right third of the offset seat in row three, the proper code is "32" (Third Seat - Middle). A person in the center of that same seat (i.e., row three) is coded "34" (Third Seat - Other).

Variable Name: Occupant's Seat Position (cont'd.)

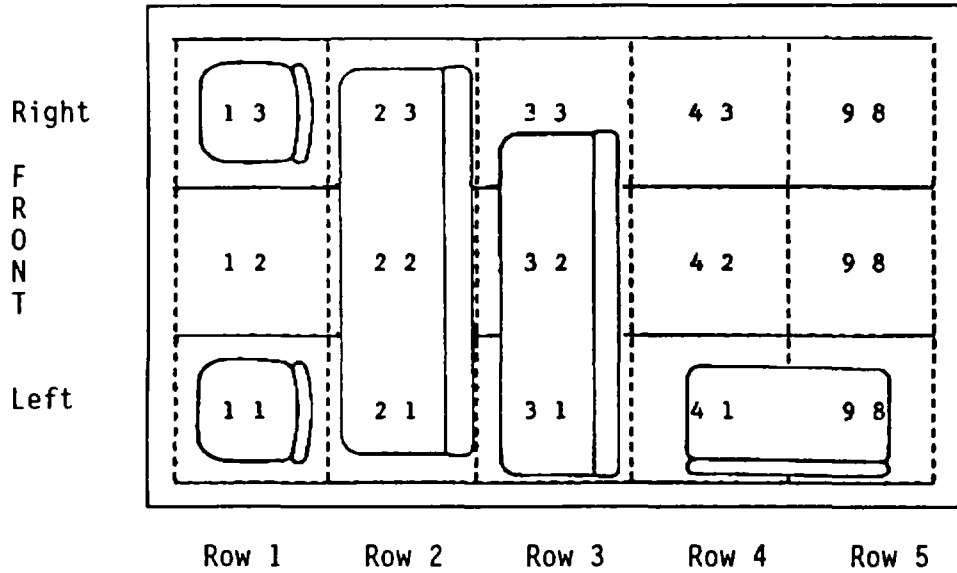

If a seat row has more than three designated seat positions, the occupants in the left and right positions have their positions assigned as usual (e.g., "31" and "33"), while the two center positions are coded as "Other" (i.e., "14", "24", "34", "44", or "98") depending upon the seat row.

Persons appended to the vehicle for motion are not considered to be occupants of the vehicle.

Variable Name: Occupant's Posture

Element Values:

0 Normal posture

Abnormal posture

1 Kneeling or standing on seat

2 Lying on or across seat

3 Kneeling, standing or sitting in front of seat

4 Sitting sideways or turned to talk with another occupant or to look out a rear window

5 Sitting on a console

6 Lying back in a reclined seat position

7 Bracing with feet or hands on a surface in front of seat

8 Other abnormal posture (specify):

9 Unknown

Source: Primary source is interviewee; secondary sources include vehicle inspection, police report, or official records (i.e., medical).

Remarks:

This variable is designed to capture those instances where an occupant was not in the usual upright, forward facing seated position except for occupants correctly seated in child safety seats.

The occupant's posture is assessed as the last known position that the occupant was in just prior to impact. If the occupant cannot recall his/her position just prior to impact, then code the last known position just prior to recognizing an impending danger.

The posture of an occupant of a child safety seat is normal if the occupant is correctly seated in the seat as designed. If the occupant is not seated (i.e., kneeling or standing) in the child safety seat as designed, then the occupant's posture is abnormal and code "8" (Other abnormal posture) is used.

Code "1" (Kneeling or standing on seat) is used whenever an occupant is not seated but is kneeling or standing on seat.

Code "2" (Lying on or across seat) is used whenever an occupant is not seated but is lying with body, or body and legs across one or more seating positions.

Code "3" (Kneeling, standing or sitting in front of seat) is used whenever an occupant is not seated but is on the floor kneeling, standing, or sitting in front of a seat.

Code "4" (Sitting sideways or turned to talk with another occupant or to look out a rear window) is used whenever an occupant is seated but is sitting sideways or turned to talk with another occupant or to look out a rear window just prior to impact.

Variable Name: Occupant's Posture (Cont'd)

Code "5" (Sitting on a console) is used whenever an occupant is not in a seated position but is sitting on a console.

Code "6" (Lying back in a reclined seat position) is used whenever an occupant in a seated position has reclined the seat back rearward and is lying back in the seat.

Code "7" (Bracing with feet or hands on a surface in front of seat) is used whenever a seated occupant has assumed a position of bracing on the surface in front of the seating position just prior to the collision.

Code "8" (Other abnormal posture) includes but is not limited to:

- sitting normally in a designed rearward or side-facing seat except for occupants correctly seated in child safety seats,
- leaning over in the seat,
- sitting on another occupant's lap
- Sitting side-by-side of another occupant in same seating position.
- being in an unenclosed area,
- being in an enclosed area that does not have designated seating positions,
- Incorrectly seated in a child safety seat
- etc.

It is extremely important in locating injuries associated with various items within the passenger compartment to know as much as possible about the occupant's trajectory or path inside the vehicle during the collision. The accuracy of this analysis depends on knowing exactly where the occupant was before the collision. Therefore, details about the occupant's posture are necessary.

As an example, if the right front passenger was sitting sideways in the seat facing the driver immediately prior to a frontal collision, it is reasonable to assume that his injuries would be confined to the right side of his body from contact with the instrument panel area. If he is reported simply as "sitting on the seat", his normal position would be with his right toward the door. For the same collision situation described above he would probably then contact the instrument panel with the front of his body rather than the side.

Code "9" (Unknown) if the occupant's posture cannot be determined.

EJECTION/ENTRAPMENT OVERVIEW

Variables in this section provide a coded assessment of the occurrence of entrapment or ejection of this occupant. There is one variable which addresses entrapment OA16, Entrapment. It is a presence or absence variable. There is no further assessment of entrapment in a coded format. Ejection has a more complete coded description regarding (a) occurrence, OA12, Ejection, (b) route of ejection, OA13, Ejection Area, (c) type of opening the occupant was ejected through, OA14, Ejection Medium, and (d) condition of the opening prior to impact OA15, Medium Status (Immediately Prior to Impact). All of the variables in this section are considered final assessments which are coded at the end of all field research and interviewing. Much of the information regarding them will come from the vehicle inspection. Verification of questionable ejection or entrapment will come from the interview.

Historically, ejection from the vehicle has been a major cause of fatalities and more serious injuries. The chances of being killed if ejected are about 1 in 5; whereas, if the occupant remains inside the vehicle, the chances of dying are reduced to about 1 in 200 for all fatal accidents. Unfortunately ejection from the vehicle is not that uncommon and has become a significant part of the fatality (30%) and severe (15%) injury accidents. Further contributing to the ejection problem is the increase in window surface area and more hatchback models. Despite the current emphasis on restraint use through legal requirements for occupants to be buckled up, a significant portion of the population continues to be unrestrained and at risk to ejection. All evidence indicates that this trend will continue into the foreseeable future.

A problem not often addressed is that of partial ejection. This refers to those instances where some part but not all of an occupant's body is, at some time during the accident sequence, outside the occupant compartment. Although it would not seem to be a problem it can be, and often is, fatal if the part outside is the occupant's head. Because of the dynamics of the vehicle and the kinematics of the occupants during an ejection sequence, it is often the occupant's own vehicle which causes the injury as it rolls onto the occupant.

Entrapment poses a different problem area. Recent years have brought about a vast improvement in the delivery of emergency medical attention to motor vehicle accident victims. This improvement has been achieved through the establishment of regional trauma centers, well equipped Mobile Intensive Care Units manned by trained paramedics even in rural areas, and a general increase in the knowledge of how to treat acute trauma. This improvement has not helped those victims who are restrained within the vehicle by deformed components. The improved care cannot be delivered because the personnel are unable to get to the victim, remove the victim from the vehicle, and deliver the victim to a treatment facility in a reasonable amount of time. Also, previous extrication tools used by rescue personnel were crude and sometimes injury causing themselves, an example of which is the large metal cutting saws. Within the last few years a device known as the "Jaws of Life" was developed and widely distributed. It is a hydraulically driven mechanism which can be used to increase the size of openings, extricate entrapped occupant's limbs and force open doors which are jammed. This development came about because of the perceived need for an extrication tool which operated quickly yet did not further injure the occupant.

EJECTION/ENTRAPMENT OVERVIEW

Federal Motor Vehicle Safety Standards (FMVSS) which were developed in response to the problems seen in these areas are FMVSS 201 (Occupant Protection in Interior Impact), FMVSS 205 (Glazing Materials), FMVSS 206 (Door Locks and Door Retention Components), FMVSS 212 (Windshield Mounting), and FMVSS 214 (Roof Crush Resistance Passenger Cars).

Analytically this group of variables is a stand alone package most of the time. It can form the basis of an analysis without the use or comparison to any other variables. This would be used mostly in exploring the number and types of ejections and entrapments. Expanding the scope somewhat to include injury severity allows a determination of the increase or decrease in the ejection problem. Inclusion of injury source would provide an idea of the severity of all occurrences of entrapment and ejection. Injury source also provides an idea of the kinematics of the occupant during the sequence. The addition of a cross-tabulation for AIS level would show the relative severity between the injuries incurred inside the vehicle and those outside the vehicle.

Other areas of interest to the analyst are the ejection route and performance of integral structures. The integral structure performance is directly governed by the FMVSS 206 and 212. These areas are of increasing interest to NHTSA since the real world performance can help support the findings from the staged collisions and will help determine the effectiveness of the standards.

Lastly, new glazing techniques are being introduced in windshields and some side windows. These new types of window have a plastic layer on the interior surface of the window. Tests have shown a reduction in lacerative injuries which was the primary objective but also an increased resistance to ejection through the window. Further study of real world performance is needed to provide an accurate evaluation of this secondary benefit.

Gathering the data, which will allow the researcher to accurately code the variables, is a multistage process. It will begin with the PAR which may give an indication of either ejection or entrapment. Inspection of the vehicle will provide the evidence needed to substantiate either occurrence. Further, documentation should be obtained through the scene inspection, interview, and injury data. Only at the end of the data gathering process should these variables be coded. Particular attention should be paid to the vehicle inspection since most evidence of ejection will be less apparent and not easily discerned.

In summary, this group of variables assesses the level of a very significant problem in today's accident picture. Correct accurate assessment is a result of a multistage research process which will be individualized by case. Attention to detail will result in a correct assessment. This is one area which is directly tied to the FMVSS, and all gathered data results in a direct evaluation of the applicable standards.

EJECTION/ENTRAPMENT OVERVIEW

Coding OA12-OA16 Special Conditions

Ejection and Entrapment

Using the guidelines given below, OA12-OA16 may be coded for towed CDS applicable vehicles and nontowed CDS applicable AOPS vehicles based on PAR and accident severity when there is no vehicle inspection, no interview, and the answer is obvious. If there is any doubt, annotate accordingly and code "9" (Unknown).

1. For occupants of hit-and-run towed CDS applicable vehicles and hit-and-run nontowed CDS applicable AOPS vehicles, in general, OA12-OA16 may be coded "0" (Not entrapped/No ejection).
2. For other towed CDS applicable vehicles and other nontowed CDS applicable AOPS vehicles: (Strata A to H)
 - (a) OA12-OA15 (ejection variables) may be coded "0" (No ejection) if the PAR specifically so states for a given occupant. For all other occupants about whom the PAR is silent, code "9" (Unknown).

If the PAR indicates that an occupant is ejected, this is sufficient to code OA12 "1" (Complete ejection) or "2" (Partial ejection) if the PAR so states. If complete versus partial ejection is not stated on the PAR, then code OA12 equal "3" (Ejection, unknown degree) may be used.

Note, however, that OA13-OA15 can be coded only if the PAR provides sufficient detail.

- (b) OA16 (Entrapment) may be coded "0" (Not entrapped) if the PAR specifically so states for a given occupant. For all other occupants about whom the PAR is silent, code "9" (Unknown).

Recall, however, that if the PAR states that an occupant is entrapped, this is not sufficient to code Entrapment (because PAR definition of entrapment is different from NASS definition). Unless Entrapment is verified through other sources, OA16 must be coded "9" (Unknown).

Variable Name: Ejection

Element Value:

- 0 No ejection
- 1 Complete ejection
- 2 Partial ejection
- 3 Ejection, unknown degree
- 9 Unknown

Source: Researcher determined--inputs include the vehicle inspection, interviewee, medical records, and the police report.

Remarks:

Ejection refers to persons being completely or partially thrown from the vehicle as a result of an impact or rollover. If a person already has a body part protruding from the vehicle (e.g., an elbow, arm, etc.) and the PDOF acting on the vehicle would likely cause further protrusions of the body part, then at least partial ejection is encoded.

Code "0" (No ejection) for any persons riding on the exterior of a vehicle, such as the fenders (this does not include pickup beds, boot of a convertible, and persons riding on open tailgates).

Code "1" (Complete ejection) refers to a situation where the occupant's body is entirely outside the vehicle but may be in contact with the vehicle.

Code "2" (Partial ejection) refers to a situation where part of the occupant's body remains in the vehicle. This does not apply to occupants who are not initially in the seating compartment of the vehicle [e.g., pickup beds, boot of a convertible, and persons riding on open tailgates, since any ejection for them is coded as "1" (Complete ejection)].

Police reported ejections may be coded if there is no vehicle inspection or occupant interview, provided that the ejectee was in the seating compartment of the vehicle, and there is no evidence which contradicts the reported ejection.

Variable Name: Ejection Area

Element Values:

- 0 No ejection
- 1 Windshield
- 2 Left front
- 3 Right front
- 4 Left rear
- 5 Right rear
- 6 Rear
- 7 Roof
- 8 Other area (e.g., back of pickup, etc.) (specify)
- 9 Unknown

Source Researcher determined--inputs include the vehicle inspection, interviewee, and the police report.

Remarks:

Code "0" (No ejection) applies to persons who are not ejected, or to persons riding on fenders.

Code "6" (Rear) is restricted to persons riding in a passenger compartment, who are ejected through the rear window, tailgate (e.g., station wagon), hatchback, etc.

Code "7" (Roof) applies to all hardtops, convertibles, sun roofs, t-bar roofs, and detachable hardtops (such as fiberglass tops) that are used to cover areas designed for passenger protection.

Examples follow for how variables 0A14, Ejection Medium, and 0A15, Medium Status (Immediately Prior to Impact), should be coded when 0A13 equals 7 (Roof).

0A12	Roof Type	0A13	0A14	0A15
Ejection 1-3	Hardtop, ripped open during crash	7	5	3
Ejection 1-3	Removable hardtop, detached prior to crash	7	2	1
Ejection 1-3	Convertible, in down or open position	7	2	1
Ejection 1-3	Convertible, in closed position	7	2	2
Ejection 1-3	Sun or t-bar, ripped open during crash	7	2	2
Ejection 1-3	Sun or t-bar, open/removed prior to crash	7	2	1
Ejection 1-3	Sun or t-bar, closed prior to crash	7	2	2

Variable Name: Ejection Area (cont'd.)

Codes "1" through "7" are designated for use with areas designed for passenger protection (e.g., passenger cars, vans, light truck cabs, self-contained mini- RVs and mini-motor homes). Trailers, add-on campers, etc., are to be assigned code "8" (Other area).

Code "8" (Other area) also applies to persons riding on open tailgates.

Code "9" (Unknown) if the sole source for the ejection is the police report, unless the PAR provides a clear, distinguishable avenue of occupant ejection.

Variable Name: Ejection Medium

Element Values:

- 0 No ejection
- 1 Door/hatch/tailgate
- 2 Nonfixed roof structure
- 3 Fixed glazing
- 4 Nonfixed glazing (specify)
- 5 Integral structure
- 8 Other medium (specify)
- 9 Unknown

Source: Researcher determined--inputs include the vehicle inspection, interviewee, and the police report.

Remarks:

- Code "0" (No ejection) applies to persons who are not ejected, or to persons riding on fenders.
- Code "1" (Door/hatch/tailgate) includes any door, hatch, or tailgate that is opened during the course of the impact sequence.
- Code "2" (Nonfixed roof structure) applies only to convertible, sun roofs, t-bar roofs, and removable hardtops when detached.
- Codes "3" (Fixed glazing) and "4" (Nonfixed glazing) refer to any glazing in the vehicle.
- Code "5" (Integral structure) includes removable hardtops when attached to the vehicle.
- Code "8" (Other medium) applies to persons riding in pickup beds, on open tailgates, and for other situations which cannot be classified in codes "1" through "5". In addition, use this code when someone is ejected from a trailer, add-on camper, etc.
- Code "9" (Unknown) if the sole source for the ejection is the police report, unless the PAR provides a clear, distinguishable avenue of occupant ejection.

Variable Name: Medium Status (Immediately Prior to Impact)

Element Values:

- 0 No ejection
- 1 Open
- 2 Closed
- 3 Integral structure
- 9 Unknown

Source: Researcher determined--inputs include the vehicle inspection, interviewee, and the police report.

Remarks:

This variable is a description of the status of the area through which an occupant was ejected.

Code "0" (No ejection) applies to persons who are not ejected, or to persons riding on fenders.

Code "1" (Open) applies to convertible roofs, sun roofs, t-bar roofs, windows, doors or tailgates that are completely or partially open immediately prior to impact, or to other open areas of vehicles such as pickup beds, etc.

Codes "1" (Open) and "2" (Closed) refer to the status of the medium immediately prior to the impact.

Code "2" (Closed) refers to a window that is completely closed when damaged, or to a convertible, sun, or t-bar roof that is closed when damaged. Sun and t-bar roofs are coded here if the ejection occurred through the designed opening in the sun or t-bar roof. However, if the roof was of a sun or t-bar type but the ejection occurred because a sizeable opening was torn in the roof structure, then code "3" (Integral structure) should be used. This code is also used for fixed glazings such as windshields and backlights which are in place prior to the collision.

Code "2" (Closed) also refers to a door that is closed, but when damaged, experiences latch and/or hinge failure causing the door to open.

Code "3" (Integral structure) should be used when any vehicle structure, not designed to be opened (e.g., standard roof), is torn open during the accident such as to permit ejection.

Code "9" (Unknown) if the sole source for the ejection is the police report, unless there is a clear indication on the PAR of the medium status.

Variable Name: Entrapment

Element Values:

- 0 Not entrapped
- 1 Entrapped
- 9 Unknown

Source: Researcher determined--inputs include the vehicle inspection, interviewee, and the police report.

Remarks:

Code "1" (Entrapped) means that part of the occupant was in the vehicle and mechanically restrained by a damaged vehicle component; jammed doors and immobilizing injuries, by themselves, are not sufficient to constitute entrapment. Entrapment by cargo shift is also not sufficient.

Persons who are completely or partially ejected and subsequently become pinned by their own vehicle and any surface other than their own vehicle are not considered entrapped.

If the vehicle is not inspected and/or the occupant is not interviewed but the police report states that the person was "trapped", the researcher must verify through the officer, emergency personnel, or other witnesses that the person was, in fact, in the vehicle and mechanically restrained. This is because the above definition is more restrictive than common usage of the term. Code "9" (Unknown) if unable to obtain verification in the above situation.

An occupant is not considered entrapped (OA16 = 1) when their seat belt buckle release mechanism is jammed as a result of their accident. If this occurs, then OA20 [Manual (Active) Belt Failure Modes During Impact] must be coded "8" (Other manual belt failure), and a Potential Safety Problem Bulletin should be submitted.

RESTRAINT SYSTEM AND SEATS OVERVIEW

Variables in this section are designed to describe the availability, function, and use of restraint systems, seats, and head restraints. The variables are grouped by area assessed. Variables OA17 through OA20 are concerned with the active belts; OA21 through OA23 describe air bags; OA44 through OA48 report about automatic belts; OA24 refers to police reported restraint use; and OA25 through OA27 assess head restraint, seat type, and seat performance.

Active belts are the keystone to occupant protection during collisions. Restraint presence has been mandated by law since the 1968 model year. Manual (Active) Belt System Availability (OA17) describes the type of restraint that this occupant had the opportunity to use. The use of the restraint is then coded in OA18, Manual (Active) Belt System Use. Correct use has become a very large issue since many of the torso restraints are reportedly uncomfortable to wear especially for shorter persons. This information is captured in OA19, Proper Use of Manual (Active) Belts. Failure of the system, while rare, occurs often enough to be of interest to the rule making section of the NHTSA. Failures are coded in OA20, Manual (Active) Failure Modes During Accident.

Passive restraint systems are being installed in an increasing range of vehicles. Beginning in 1991 the description of the passive restraint system is split into "air bag" variables (OA21-OA23) and "automatic belt" variables (OA44-OA48). For air bag passive restraint systems, their availability and function is coded in variable OA21, Air Bag System Availability/Function. How well the air bags worked is described in OA22, Air Bag System Deployment, and OA23, Are There Indications of Air Bag System Failure?. For automatic belt type passive restraint systems, their availability and function is coded in variable OA44, Automatic (Passive) Belt System Availability/Function. The use of the passive belts is then coded in OA45, Automatic (Passive) Belt System Use. The type of passive belt system (i.e., motorized versus nonmotorized) is described in OA46, Automatic (Passive) Belt System Type, and the properness of the passive belt use is described in OA47, Proper Use of Automatic (Passive) Belt System. Finally, OA48, Automatic (Passive) Belt Failure Modes During Accident, describes any failures associated with the automatic belt.

The accuracy of "restraint use", when the PAR is the only source of data, has long been a concern. Since the PAR has been used in the past as a source of data, the police assessment is now coded as a separate variable OA24, Police Reported Restraint Use.

Head restraint type and performance are coded in a single variable OA25, Head Restraint Type/Damage by Occupant at This Occupant Position. Protection of the occupant from neck and back injuries has long been a concern, especially in rear-end impacts. FMVSS 202 (Head Restraints) specifies the requirements for head restraints.

Seat type and performance, which are delineated by FMVSS 207 (Seating Systems), have received increased attention in recent years because of the potential for significantly more severe injuries when the seat fails. This information is captured in variables OA26, Seat Type (This Occupant Position), and OA27, Seat Performance (This Occupant Position).

RESTRAINT SYSTEM AND SEATS OVERVIEW

From a historical standpoint, these variables (OA17 through OA27 and OA44 through OA48) have received more attention from the NHTSA, automakers, and the general public than any other injury reduction area. Much controversy has resulted over the introduction and mandating of passive restraint systems, laws requiring use of active restraints, and what is seen as government interference in the private lives of persons. Despite all the uproar and protests, the facts remain that if any form of restraint is used properly, the number of injuries and their severity will be reduced. Passive restraints, which have an increasing presence in the accident picture today, are some of the most effective occupant protection devices available. Evaluation of the effectiveness of both active and passive systems has long been a priority of the accident research effort of the NHTSA. Problems with systems and failures many times receive an inordinate amount of attention compared to the success rate. It becomes important to all concerned that the performance be evaluated in an objective manner and problems which deter use, such as active torso restraints being uncomfortable, be thoroughly documented.

Less attention is paid to the head restraint and seat performance issue, but it is no less important in the overall injury picture. Neck and back injuries are some of the most common and most debilitating that occur in motor vehicle accidents. No accurate assessment of the societal loss due to reduced or poor productivity of occupants related to neck and back injuries has been made. Many times a person with this type of injury does not miss any days of work but is at a reduced level of productivity and has to undergo therapy or treatment for a long period of time. Head restraint design and performance is critical to reduction of trauma to the neck and back.

Seat performance, especially the seat back, is critical to injury reduction in the more severe collisions. Deformation limits of the seat back are covered by specifications in FMVSS 207. These limits are responsible for injury reduction in that the seat back must contain the occupant, either from the front or the back, while absorbing energy from the impact. It is also critical that the adjusters and seat tracks not fail since failure can cause more severe injuries than would otherwise be expected. Increased injury severity has been reported with seat failure even when the occupant is belted.

Analysts consider these variables to be key areas of interest. Correlations between these variables and the injury coding variables are of particular interest. The most common comparisons are, of course, restraint usage versus injury severity, restraint availability versus use, and passive versus active availability. The more detailed analyses involve three-way comparisons (e.g. restraint use versus injury severity versus delta V). Injury severity is less when the occupant is restrained as delta V increases until the delta V reaches a certain level. At this juncture the injury severity for belted occupants becomes the same as for unrestrained ones.

The uses for the data from these variables are too numerous to list, but they are varied and relate to all other forms and areas of data in the case. The researcher should remember that these variables are not coded only from one source of data. The primary source is the vehicle inspection; it is supported by interviewee and injury data. Inspection of the vehicle should be very

RESTRAINT SYSTEM AND SEATS OVERVIEW

detailed, and the researcher should examine closely for all possible clues and evidence. Obvious belt use indicated by stretched or frayed webbing is the easiest to find. Also, a deformed seat back or headrest would indicate damage by one of the occupants. Less obvious are signs of regular use such as a lack of dust around the buckle area or slightly frayed areas on the belt, close to the tongue, indicating frequent adjustment.

Indicators which support the assumption of belt use are a low number of minor injuries and no knee contusions or facial lacerations. Probing questions in the interview will aid the researcher in assessing use. Proper use can be elicited by asking questions about the comfort of the belt and location on the body (e.g., "Where was lap portion of belt, low on the hips, waistline, etc?").

Seat type/performance and head restraint type/performance should be assessed primarily from the vehicle inspection. At times it is possible to get this information from other sources such as the interviewee, but anything beyond the interviewee is almost impossible. Many times deformation of the seat back can be visually observed. The obvious time to expect that type of damage is when the vehicle has sustained a rear impact. Seat back deformation also occurs with frontal impacts and unrestrained rear occupants. It is important to remember that many seat backs are now adjustable, especially bucket seats, and just because a seat appears to be out of correct vertical alignment does not indicate seat back damage.

Head restraint damage is fairly obvious since the restraint should follow the line of the seat back. If it deviates significantly from that line then there is a presumption of damage, and a careful examination should be conducted.

All of the above mentioned variables require expertise and concern with detail. Researchers should realize that the most obvious choice is sometimes not the best assessment. Careful thought and weighing of numerous factors are required in this area to obtain the best possible assessment.

Variable Name: Manual (Active) Belt System Availability
(for This Occupant's Seating Position)

Element Values:

- 0 Not available
- 1 Belt removed/destroyed
- 2 Shoulder belt
- 3 Lap belt
- 4 Lap and shoulder belt
- 5 Belt available - type unknown

Integral Belt Partially Destroyed

- 6 Shoulder belt (lap belt destroyed/removed)
- 7 Lap belt (shoulder belt destroyed/removed)
- 8 Other belt (specify)
- 9 Unknown

Source: Researcher determined--Primary source is the vehicle inspection; secondary sources include the interview, medical records, and police report. NOTE: The use of the police report is limited. If there is no vehicle inspection and the only secondary source is the PAR, then the PAR "narrative" must clearly state that the manual belt system was used or available. An indication of usage or availability in a "restraint system" block is, by itself, not usable.

Remarks:

Some belt restraint systems are a combination of manual (active) and automatic (passive) occupant protection devices. For this variable, consider only the manual portion of the system.

Availability is assessed based on the occupant's seating position. Select the manual belt system which was available for use, if so desired, by the occupant relative to the occupant's seating position in the vehicle. Availability is also determined by presence, functional status, and use of the manual belt system. Any occupant who is using a belt restraint system, or portion thereof, must by default have that system available to them. The correctness and/or appropriateness of the use is considered in OA19, Proper Use of Manual (Active) Belts.

Certain occupant seating situations involve abnormal posture. Examples are:

- occupant on the floor [i.e., in front of a designated seat (e.g., sitting, standing, etc.) or standing in the door entrance area];
- occupant lying across one or more seating positions;
- occupant sitting side-by-side of another occupant in the same seating position, since only one can be assigned to the seating position--see OA10, Occupant's Seat Position;
- Occupant standing or kneeling in a designated seating position; and
- occupant in or on the lap of another occupant (e.g., sitting, standing, kneeling, etc.).

Variable Name: Manual (Active) Belt System Availability [cont'd.]

Occupant on the floor: For this situation use code "0" (Not available). These occupants are not in a designated seating position and do not have a manual belt available.

Occupant lying across one or more seating positions: For an occupant lying across multiple seating positions, OA10 (Occupant's Seat Position) must equal code "14", "24", "34", or "44". These occupants can be using a manual belt: If they are, then code availability based upon the belt used. Do not confuse this situation with occupants lying against a door or side panel or against another occupant. Persons in this latter category are still considered to be occupying a single occupant seating position.

Occupant sitting side-by-side of another occupant in the same seating position: These occupants (i.e., OA10 equal "14", "24", "34", "44") do not have a manual belt available unless such a person is sharing the use of a manual belt (i.e., two or more persons sitting side-by-side using the same manual belt should have the same restraint available for each occupant).

Occupant standing or kneeling in a designated seating position: These occupants have manual belts available to them for use. Availability is assessed for these occupants based on the occupant's assigned seating position.

Occupant in or on the lap of another occupant: These occupants do not have a manual belt available unless such a person is sharing the use of a manual belt (i.e., two or more persons sitting in front of one another or on top of one another using the same manual belt).

Code "0" (Not available) indicates: (1) that at the time of the accident the designated seating position that the occupant was in, was not equipped with a manufacture installed or post manufacture installed manual belt (lap, shoulder, or lap and shoulder); (2) the occupant was not in a designated seating position (e.g., on the floor); (3) the occupant was not the person assigned the designated seating position and was not using a manual belt (e.g., sitting side-by-side); or (4) the seat position that the occupant was in was equipped only with an automatic (passive) belt system.

Researchers must determine the type of manual belt available at this occupant's seating position -- nonintegral versus integral and, for integral systems, continuous loop versus noncontinuous loop.

Variable Name: Manual (Active) Belt System Availability [cont'd.]

Nonintegral Manual Belt System:

Nonintegral manual belt systems are lap and shoulder belt combinations where the shoulder belt has to be integrated (e.g., by buckling) with the existing lap belt. Either the shoulder belt portion or the lap belt portion of a nonintegral manual belt system can be removed or destroyed. If a portion of a belt has been removed or destroyed, then the remaining portion is available. For example, some older vehicles (1968-1975) have had the separate shoulder belt removed leaving only the lap belt in the vehicle. In this situation, only the lap belt is available. The fact that the separate shoulder belt was removed or destroyed cannot be captured in this variable. If a portion of a nonintegral system has been rendered inoperative, then both portions are to be considered as available. For example, if the separate shoulder belt is tied so that it can no longer be integrated with the lap belt which was in use, then code lap and shoulder belt available (code "4") on this variable and lap belt (code "03") on OA18, Manual (Active) Belt System Use.

Integral Manual Belt System:

Integral manual belt systems are lap and shoulder belt combinations that have the shoulder belt permanently attached to the lap belt. Continuous loop integral manual belt systems are one continuous belt, with a sliding buckle, that functions as both a shoulder belt and a lap belt. If the manual belt system is integral and of the continuous loop design, and if any portion of the belt is removed or destroyed, then the entire system must be considered as removed or destroyed. Use code "1" (Belt removed/destroyed) in this situation. However, if the system is integral, but uses a noncontinuous loop design, then, depending upon the design, consideration must be given as to what portion was removed or destroyed. For example, if the shoulder belt has been cut leaving only a functional lap belt portion, then use code "7" [Lap belt (shoulder belt destroyed\removed)].

Built-in Child Safety Seat System:

A built-in child safety seat is an occupant seating concept that makes the child seat and the seating position integral with each other. The seats are designed as alternatives for existing toddler or booster seats. They are not intended as infant seats. These seats must be pulled or folded out of the existing seat back. If the built-in child safety seat was not put into its proper position, then ignore its existence and record only the manual belt system available. If the seat has been properly positioned, then identify and encode the type of manual belt system that is used in conjunction with the built-in child safety seat. If the built-in child safety seat is "self-contained" (i.e., does not use any part of the regular existing manual belt system available at the occupant seating position), then use code "8" (Other belt).

Code "1" (Belt removed/destroyed) indicates that the manual belt, initially installed at this occupant's seating position, was subsequently removed or destroyed (e.g., unbolted, cutout, etc.). If the belt is present but nonfunctional, then code the type of manual belt available on this variable and use code "01" (Inoperative) for OA18, Manual (Active) Belt System Use.

Variable Name: Manual (Active) Belt System Availability [cont'd.]

Belts which are knotted, buckled at the rear of the seat (bench or bucket), stored below the seat, etc., are available if they were otherwise operative.

- Code "2" (Shoulder belt) is used when this occupant's seat position was equipped with a manual upper torso restraint and no lap belt. The population of vehicles equipped with only manual shoulder belts is very small, therefore, care must be taken that a two-point passive belt is not identified as a manual belt (e.g., Volkswagen Rabbits 1981-1984).
- Code "3" (Lap belt) is used when this occupant's seat position is equipped with a manual belt that secures the pelvic area of the occupant in the seat and there is no manual upper torso belt.
- Code "4" (Lap and shoulder belt) is used when both a manual upper torso belt and a manual lap (pelvic area) belt are present at this occupant's seat position.
- Code "5" (Belt available - type unknown) is used when there is no vehicle inspection and there is disagreement regarding the type of manual belt system among the secondary sources. When the specific manual belt system cannot be determined, but it is known some type of belt is present, then use this code.
- Code "6" [Shoulder belt (lap belt destroyed/removed)] is used for integral noncontinuous loop manual belt systems when the lap belt portion of the belt has been removed or destroyed leaving only the shoulder belt portion present at this occupant's seating position.
- Code "7" [Lap belt (shoulder belt destroyed/removed)] is used for integral noncontinuous loop manual belt systems when the shoulder belt portion of the belt has been removed or destroyed leaving only the lap belt portion present at this occupant's seating position.
- Code "8" (Other belt) is used when the belt system is nonstandard or cannot be described with other codes. Specify (write out) the type of manual belt (e.g., 5 point competition harness, 4 inch wide webbing, etc.). In addition, use this code if a properly positioned "self-contained" built-in child safety seat was available at this occupant's seating position. Other child restraints are not recorded here, use variables OA28 through OA33.
- Code "9" (Unknown) is used when it cannot be determined whether or not manual belts were available for this occupant's seat position.

Variable Name: Manual (Active) Belt System Use

Element Values:

- 00 None used, not available, or belt removed/destroyed
- 01 Inoperative (specify)
- 02 Shoulder belt
- 03 Lap belt
- 04 Lap and shoulder belt
- 05 Belt used - type unknown
- 08 Other belt used (specify)
- 12 Shoulder belt used with child safety seat
- 13 Lap belt used with child safety seat
- 14 Lap and shoulder belt used with child safety seat
- 15 Belt used with child safety seat - type unknown
- 18 Other belt used with child safety seat (specify)
- 99 Unknown if belt used

Source: Researcher determined--Primary source is the vehicle inspection; secondary sources include the interview and medical records. NOTE: Do not use the police accident report as a source for coding this variable.

Remarks:

Select the manual belt system or portion of the system which was in use at the time of the accident by the occupant. The correctness of the use is not assessed on this variable [see variable OA19, Proper Use of Manual (Active) Belts]. This variable only identifies manual belt usage; do not consider the presence and use of a passive belt system.

Code "00" (None used, not available, or belt removed/destroyed) is used when: (1) OA17, Manual (Active) Belt System Availability, is coded "0" (Not available); (2) OA17 is coded "1" (Belt removed/destroyed); or (3) a manual belt was available (i.e., OA17=2-8) but not worn.

Code "01" (Inoperative) includes belts which are knotted, jammed, tucked behind the seat, or in any other fashion rendered unusable. In addition, use this code for belts which are inoperative because of extreme deterioration from aging. A belt system that was completely removed from or cut out of a vehicle is coded "00" (None used, not available, or belt removed/destroyed).

Code "02" (Shoulder belt) is used when a manual shoulder belt alone was in use. This can occur when: (1) the vehicle was not equipped with a lap belt, (2) only the shoulder belt portion of a nonintegral system was in use, or (3) when the lap belt portion of a noncontinuous loop integral lap and shoulder belt system was cut out leaving only a functional shoulder belt portion in use.

Code "03" (Lap belt) is used when a manual lap belt alone was in use. This can occur when: (1) the vehicle was not equipped with a shoulder belt, (2) only the lap belt portion of a nonintegral system was in use, or

Variable Name: Manual (Active) Belt System Use [cont'd.]

(3) when the shoulder belt portion of a noncontinuous loop integral lap and shoulder belt system was cut out leaving only a functional lap belt portion in use. Note, manual lap belts can be used in conjunction with a two-point automatic belt system [see OA44, Automatic (Passive) Belt System Availability/Function, and OA45, Automatic (Passive) Belt System Use]. For manual and automatic belt combinations, use this code for the manual lap belt usage, and encode the information about the two-point passive shoulder belt in variables OA44 and OA45.

Code "04" (Lap and shoulder belt) is used when the occupant is: (1) "encompassed" both in the lap and upper torso region by a manual lap and shoulder belt combination, or (2) using only a portion of an intact integral lap and shoulder belt system. For example, if a person has an integral lap and shoulder belt but is only using the lap portion (i.e., having the shoulder belt behind his or her back), then use this code. Improper use of the belt is assessed in variable OA19 [Proper Use of Manual (Active) Belts].

Code "05" (Belt used - type unknown) is used when there is no vehicle inspection or interview, and information from medical records indicates that a manual belt was used but the type of manual belt system cannot be determined.

Codes "12" through "18" (... with child seat) are used when the vehicle's manual belt system anchors a child safety seat to the vehicle. These codes do not refer to the belts which are part of the child seat itself.

Code "15" (Belt used with child safety seat - type unknown) is used when the vehicle belt type is unknown not the child safety seat type.

Code "99" (Unknown if belt used) is used if it cannot be determined whether or not a manual belt was in use by the occupant at the time of the accident.

Note, the presence of an air bag system (OA21 through OA23) does not mean that there are no active belts present. In fact, most if not all air-bag-equipped vehicles also have some manual belt system installed in the seat positions protected by the air bag(s).

Variable Name: Proper Use of Manual (Active) Belts

Element Values:

- 0 None used or not available
- 1 Belt used properly
- 2 Belt used properly with child seat

- Belt Used Improperly
- 3 Shoulder belt worn under arm
- 4 Shoulder belt worn behind back or seat
- 5 Belt worn around more than one person
- 6 Lap belt worn on abdomen
- 7 Lap belt or lap and shoulder belt used improperly with child safety seat (specify)
- 8 Other improper use of manual belt system (specify)
- 9 Unknown

Source: Researcher determined--Primary source is the vehicle inspection; secondary sources include the interview, police report, and medical records. NOTE: The use of the police report is limited. If there is no vehicle inspection and the only secondary source is the PAR, then the PAR "narrative" must clearly state that the manual belt system was used properly or improperly.

Remarks:

This variable must be assessed by the researcher using all available data. An improperly used manual belt can cause a large variety of injuries by itself or, depending upon the way it is improperly used, it can allow other injuries to occur which might not have happened if the restraint was properly used. In severe cases an improperly worn belt can be the cause of death. An improperly used belt can also lead to belt failure which is addressed in variable OA20, Manual (Active) Belt Failure Modes During Accident. If there is an improperly used belt and/or a belt system failure, they should be noted on the Case Summary Form.

Code "2" (Belt used properly with child seat) is to be indicated only when the safety seat is installed so as to comply with the manufacturer's directions (i.e., seat must be integrated with the vehicle via the manual seat belts) and is occupied by a child.

Code "4" (Shoulder belt worn behind back or seat) is used when an occupant has an integral lap and shoulder belt but is only "encompassed" by the lap portion (e.g., having the manual shoulder belt behind his or her back).

Code "5" (Belt worn around more than one person) is used when more than one occupant is sharing the same manual belt. Occupants may be sitting side-by-side, in front of one another, or on top of one another.

Code "6" (Lap belt worn on abdomen) is used when the manual lap belt, or lap belt portion of a manual system, is worn above the occupant's pelvic bones.

Variable Name: Proper Use of Manual (Active) Belts (cont'd.)

Code "7" (Lap belt or lap and shoulder belt used improperly with child safety seat) is used when a child safety seat is not installed according to the manufacturer's directions and is occupied by a child. Specify how the manual belt was used improperly.

Code "8" [Other improper use of manual belt (system)] is used to describe any improper use of the manual belt system which is not listed above. For example, use this code when a manual shoulder belt is worn on the outside of an occupant's arm (i.e., humeral area) as opposed to under the arm (code "3") or on top of the shoulder/clavicle (code "1").

Code "9" (Unknown) is used:

- when it is not known whether the manual belts used were used properly or improperly (i.e., no interview was conducted and no other information is present that identifies proper or improper use of the manual belts), and
- when a child safety seat is occupied by a child, but it is unknown if the seat was installed (using either the manufacturer's or the vehicle's manual belts) according to the manufacturer's directions.

Variable Name: Manual (Active) Belt Failure Modes During Accident

Element Values:

- 0 No manual belt used or not available
- 1 No manual belt failure(s)
- 2 Torn webbing (stretched webbing not included)
- 3 Broken buckle or latchplate
- 4 Upper anchorage separated
- 5 Other anchorage separated (specify)
- 6 Broken retractor
- 7 Combination of above (specify)
- 8 Other manual belt failure (specify)
- 9 Unknown

Source: Researcher determined--primary source is the vehicle inspection; secondary sources may include interviewee and police report if a vehicle inspection is obtained.

Remarks:

If any component of the manual belt system fails during the impact as a result of occupant loading, the failure is encoded on this variable. The failure is also recorded on the Case Summary Form and documented with photographs and diagrams as needed.

Code "0" (No manual belt used or not available) is used when OA18, Manual (Active) Belt System Use, equals "00" (None used, not available, or belt removed/destroyed), or "01" (Inoperative).

Code "1" [No manual belt failure(s)] is used when there is no physical evidence from the vehicle inspection to indicate that a failure occurred.

Codes "2" through "6" are used to indicate the specific failure of the restraint system. Select the code which corresponds to the appropriate manual belt failure mode that describes the component of the restraint system which failed (i.e., torn webbing, broken buckle or latchplate, anchorage separation, broken retractor). If a failure occurs, a complete and documented description of the failed component and the way it failed must accompany the case. Include photographs of the failed component(s).

Code "7" (Combination of above) is used when any combination of codes "2"- "6" above occurs and describes multiple manual belt failure modes. Manual belt failure modes which are not described in codes "2"- "6" are reported in code "8" below. Manual belt failures listed in codes "2"- "6" take priority over code "8".

Code "8" (Other manual belt failure) is used when the only manual belt failure(s) which occur are not described in codes "2"- "6" above.

Code "9" (Unknown) is used when OA18, Manual (Active) Belt System Use, equals "99" (Unknown if belt used) or when there is no vehicle inspection.

Variable Name: Air Bag System Availability/Function

Element Values:

- 0 Not equipped/not available
- 1 Air bag

Non-functional

- 2 Air bag disconnected (specify):
- 3 Air bag not reinstalled
- 9 Unknown

Source: Researcher determined--Primary source is the vehicle inspection; secondary sources include the interview, police report, and medical records. NOTE: The use of the police report is limited. If there is no vehicle inspection and the only secondary source is the PAR, then the PAR (1) must clearly indicate that an air bag deployed ("narrative" or "restraint system" block) or (2) the "narrative" must clearly state that the car was air bag equipped. For air bag systems, an indication of availability in a "restraint system" block is, by itself, not usable.

Remarks:

The following illustrations show a General Motors air bag system (used in the late 1970's), a Ford air bag system, and a driver air bag equipped steering wheel. The air bag wheel is the most easily identified part of an air bag system. All presently available air bag systems have a steering wheel similar to the one in the illustration.

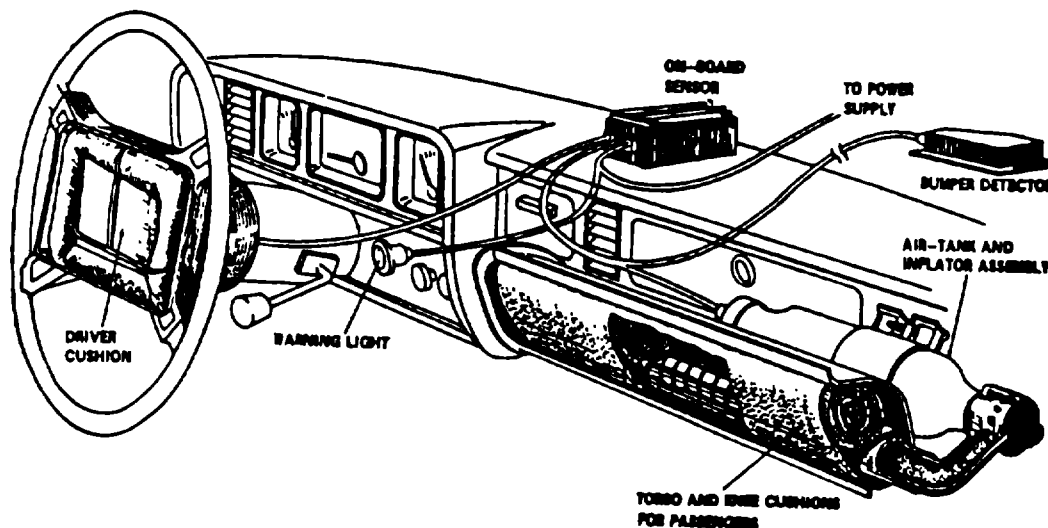

G.M. AIR BAG

Variable Name: Air Bag System Availability/Function (cont'd.)

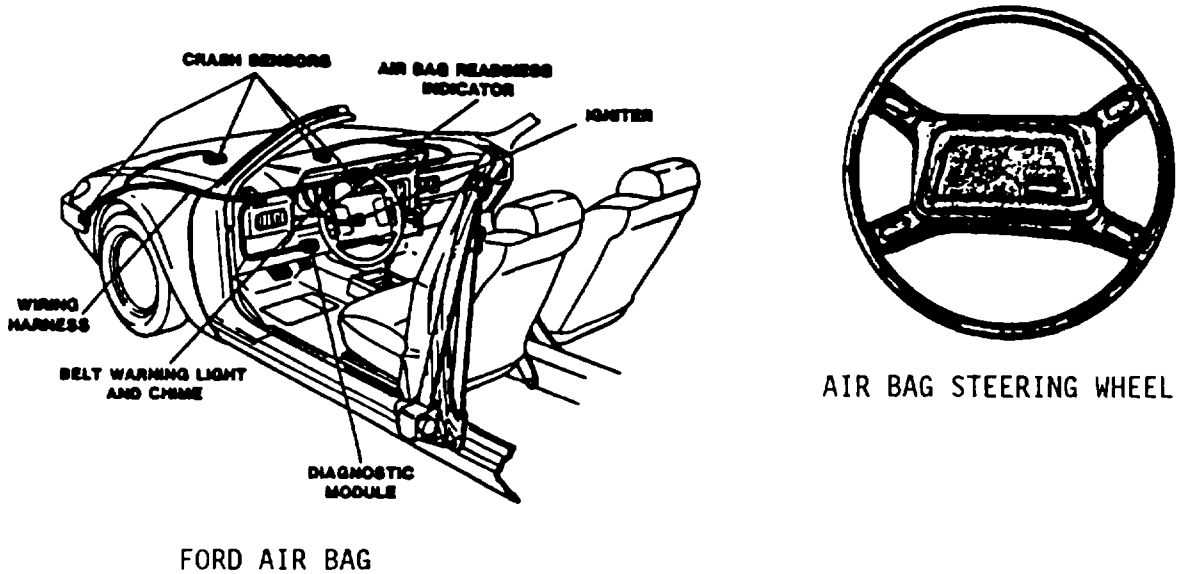

FORD AIR BAG

Code "0" (Not equipped/not available) is used when the vehicle is not equipped with an air bag for the occupant's seating position. Because some newer passenger vehicles (GV07="01"- "09" and "12") and vans (GV07="20" or "21") are equipped with front seat air bags, information must be obtained from a valid source prior to using this code. Use this code for all center-front seat occupants, rear seat occupants, for all occupants of 1971 or older vehicles, and for vehicle body types (GV07="10", "11", and "13"- "19" and "22"- "49") not using air bags irrespective of the model year.

Code "1" (Air bag) is used when the vehicle is equipped with an air bag for the occupant's seating position. Use caution when determining whether the air bag system is a "driver-only" or a "driver and passenger" design. Deployment of the air bag system has no bearing on the coding of this variable; refer to OA22, Air Bag System Deployment.

If the occupant's vehicle is not inspected and is a 1972 or newer model year passenger vehicle or a 1991 or newer van, and information from interview or medical sources indicates that the vehicle was equipped with an air bag, but its function is unknown, then use this code (i.e., the default assumption is that the air bag is functional).

Code "2" (Air bag disconnected) is used when any component of the air bag system is rendered inoperative prior to the collision (e.g., fuse removed).

Code "3" (Air bag not reinstalled) is used when the air bag is not replaced, or the system was not reactivated subsequent to a deployment prior to the accident being researched.

Variable Name: Air Bag System Availability/Function (cont'd.)

Code "9" (Unknown) is used for front outboard seat occupants of uninspected 1972 or newer passenger vehicles (GV07="01"-"09", "12") or 1991 or newer vans (GV07="20" or "21") where data from another valid source cannot be obtained to ascertain the presence or absence of an air bag system.

Certain occupant seating situations involve abnormal posture. Examples are:

- occupant on the floor [i.e., in front of a designated seat (e.g., sitting, standing, etc.)];
- occupant lying across one or more seating positions;
- occupant sitting side-by-side of another occupant in the same seating position, since only one can be assigned to the seating position--see OA10, Occupant's Seat Position;
- occupant standing or kneeling in a designated seating position; and
- occupant in or on the lap of another occupant (e.g., sitting, standing, kneeling, etc.).

Unlike belts (i.e., manual or automatic), air bags are less adaptable to occupants who are not sitting in the designated occupant seating positions. Whereas a belt can be extended (within certain limits) to accommodate multiple occupants, a fully deployed air bag is engineered for a specific area. A belt will provide some protection even for multiple occupants (assuming the lap portion is across the pelvic bones and/or the shoulder portion is across the clavicle). However, an air bag could be extremely dangerous for some occupants in seating situations which involve abnormal posture (e.g., occupant standing in front of the right-front seating position, occupant in or on the lap). Therefore, air bags are only available to the occupants sitting in the front outboard seating positions (i.e., OA10 equals "11" and/or "13"). Thus, use code "0" (Not equipped/not available) when an occupant's seating position (OA10) is "14" (... - Other) or "15" (... - On or in the lap of another occupant).

Some vehicles come equipped with a right-front passenger air bag and a front bench seat. In some vehicles the right-front air bag is big enough to cover the center front person [OA10="12" (Front Seat - Middle)]; however, the air bag was not engineered to provide protection to this occupant seating position. Therefore, occupants in the center front position, do not have an air bag available to them.

Variable Name: Air Bag System Deployment

Element Values:

- 0 Not equipped/not available
- 1 Air bag deployed during accident (as a result of impact)
- 2 Air bag deployed inadvertently just prior to accident
- 3 Air bag deployed, accident sequence undetermined
- 4 Nondeployed
- 5 Unknown if deployed
- 6 Air bag deployed as a result of a noncollision event during accident sequence (e.g., fire, explosion, electrical)
- 9 Unknown

Source: Researcher determined--Primary source is the vehicle inspection; secondary sources include the, interview, police report, and medical records. NOTE: The use of the police report is limited. If there is no vehicle inspection and the only secondary source is the PAR, then the PAR must clearly indicate that an air bag deployed either in the "narrative" or in a "restraint system" block.

Remarks:

Air bags are for occupants seated in the front outboard positions in post-1971 passenger cars or 1991 or newer vans. Thus, if the vehicle is not a post-1971 passenger car or a 1991 or newer van, or the occupant is not in a front outboard seating position (OA10, Occupant's Seat Position, equals "11" or "13"), then use code "0" (Not equipped/not available).

Code "0" (Not equipped/not available) is also used when the occupant is seated in a front outboard seating position in a post-1971 passenger car or 1991 or newer van but the vehicle was not equipped with an air bag [i.e., OA21, Air Bag System Availability/Function, equals "0" (Not equipped/not available)].

Code "1" [Air bag deployed during accident (as a result of impact)] is used when the vehicle is equipped with an air bag [OA21 equals "1" (Air bag)] and the air bag deployed as a result of an impact which produced a longitudinal deceleration through the vehicle of sufficient magnitude to cause inflation of the air bag. Note, an air bag is not designed to deploy in every collision.

Code "2" (Air bag deployed inadvertently just prior to accident) is used when an air bag deploys without an impact having caused its deployment, and the vehicle is subsequently involved in an accident.

Variable Name: Proper Use of Automatic (Passive) Belt System [cont'd.]

"encompassed" by the lap portion (i.e., having the automatic torso belt behind the occupant's back), or

- when an occupant has a two point automatic belt and is not "encompassed" by the torso portion (i.e., the automatic torso belt is attached and is behind the occupant's back).

Code "5" (Automatic belt worn around more than one person) is used when more than one occupant is sharing the same automatic belt. Occupants may be sitting side-by-side, in front of one another, or on top of one another. If the occupants are using a three point automatic belt such that the torso portion is worn behind one or more of the occupants backs while the lap portion encompasses their hips, then use this code.

Code "6" (Lap portion of automatic belt worn on abdomen) is used when the lap belt portion of a three point automatic belt system is worn above the occupant's pelvic bones.

Code "7" (Automatic lap and shoulder belt or automatic shoulder belt used improperly with child safety seat) is used when a child safety seat is not installed according to the manufacturer's directions and is occupied by a child. Specify how the automatic belt was used improperly.

Code "8" (Other improper use of automatic belt system) is used to describe any improper use of the automatic belt system which is not listed above. This includes when an automatic shoulder belt is worn on the outside of an occupant's arm as opposed to under the arm or on top of the shoulder.

Code "9" (Unknown) is used:

- when it cannot be determined from any source whether or not this occupant's seating position was equipped with an automatic belt system [i.e., OA44 equals "9" (Unknown)],
- when it is known that an automatic belt is available but the type cannot be determined--two point versus three point automatic belt [i.e., OA44 equals "3" (Automatic belts - type unknown),
- when it is not known whether the automatic belts used were used properly or improperly (i.e., no interview was conducted and no other information is present that identifies proper or improper use of the automatic belts), and
- when a child safety seat is occupied by a child, but it is unknown if the seat was installed (using either the manufacturer's or the vehicle's automatic belts) according to the manufacturer's directions.

Variable Name: Are There Indications of Air Bag System Failure?

Element Values:

- 0 Not equipped/not available
- 1 No
- 2 Yes (specify):
- 9 Unknown

Source: Researcher determined--Primary source is the vehicle inspection; secondary sources include the interview, police report, and medical records. NOTE: The use of all secondary sources is limited. If there is no vehicle inspection, then the secondary sources are limited to the reporting of "no failure". If the only secondary source is the PAR and no failure is alleged, then the PAR must clearly indicate that an air bag deployed either in the "narrative" or in a "restraint system" block.

Remarks:

Code "0" (Not equipped/not available) is used whenever OA21, Air Bag System Availability/Function, equals "0" (Not equipped/not available), "2" (Air bag disconnected), or "3" (Air bag not reinstalled) because this variable only focuses upon indications of failures in functioning air bag systems.

This variable flags "indications of air bag failures". "Indications of air bag failure" means that something abnormal has occurred to the air bag system. It may not necessarily mean that the air bag system was defective. An indication of air bag failure could be a cut in or blowout of the fabric, a rupture along a fabric seam, a cover which does not open properly causing a misaligned deployment, partial inflation, or any number of other problems. If an indication of air bag failure is suspected, then document the condition with slides and notes, then call your zone center for assistance.

A vehicle inspection is required in order to report an indication of air bag failure because the vehicle's delta V (GV31, Longitudinal Component of Delta V) may have been below the threshold for the air bag's deployment.

Code "1" (No) is used whenever the vehicle is known to be air bag equipped [i.e., OA21 equals "1" (Air bag)] and no indications of air bag failure are suspected. Use this code when an air bag did not deploy [i.e., OA22, Air Bag System Deployment, equals "4" (Nondeployed)] and no failure is suspected and the vehicle inspection indicates that the delta V sustained by the vehicle (i.e. GV31) was near or below the deployment threshold. In addition, use this code when the vehicle is not inspected but is known to be air bag equipped (e.g., VIN--GV08) and secondary sources make no allegation of "failure" (e.g., interviewee does not say "the bag did not work").

Code "2" (Yes) is used whenever an indication of air bag failure is suspected.

Code "9" (Unknown) is used whenever OA22 equals "5" (Unknown if deployed) or "9" (Unknown).

Variable Name: Police Reported Restraint Use

Element Values:

- 0 None used
- 1 Police did not indicate restraint use
- 2 Shoulder belt
- 3 Lap belt
- 4 Lap and shoulder belt
- 5 Belt used, type not specified
- 6 Child safety seat
- 7 Other or automatic restraint (specify)
- 8 Restrained, type unknown
- 9 Police indicated "unknown"

Source: Police report

Remarks:

This variable encodes what was documented on the PAR regarding occupant use of available vehicle restraints (i.e., manual belts, child safety seat, or automatic restraints). Code the first attribute which applies.

Code "1" (Police did not indicate restraint use) is used in two instances. The first is when the PAR has a space, box, line, etc. to indicate restraint use but there is no response present. The second is when there is no area of the PAR for the officer to report restraint use.

Code "5" (Belt used, type not specified) is used when the PAR indicates that available belts were used, but it is unclear what type of belts were actually in use.

Code "8" (Restrained, type unknown) is used when the PAR indicates that some type of restraint was in use, but the type of restraint is not clear.

Variable Name: Head Restraint Type/Damage by Occupant at This Occupant Position

Element Values:

- 0 No head restraints
- 1 Integral - no damage
- 2 Integral - damaged during accident
- 3 Adjustable - no damage
- 4 Adjustable - damaged during accident
- 5 Add-on - no damage
- 6 Add-on - damaged during accident
- 8 Other (specify)
- 9 Unknown

Source: Vehicle inspection.

Remarks:

Many passenger cars have head restraints for the front outboard seat positions. The head restraints can be of any design but must meet the requirements of FMVSS 202 (Head Restraints). Some examples of head restraint styles are shown below.



INTEGRAL

(Codes 1 or 2)

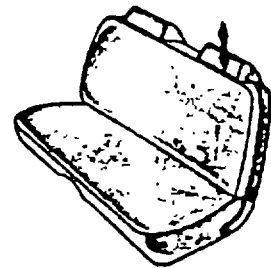
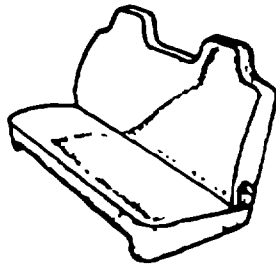

ADJUSTABLE

(Codes 3 or 4)

Any damage to a head restraint caused by the occupant in the seat position having the head restraint should have codes "2", "4", or "6" (... - damaged during accident) assigned.

Code "0" (No head restraints) is used when (1) no head restraint is available for this occupant's seating position, or (2) this occupant was not seated or no seat was available. In addition, use this code when there had been a head restraint but it had been removed prior to the accident.

Code "1" (Integral - no damage) and code "2" (Integral - damaged during accident) refer to head restraints which are a continuous part of the seat back structure or those which are a separate structure but are not vertically adjustable.

Code "3" (Adjustable - no damage) and code "4" (Adjustable - damaged during accident) apply to:

Variable Name: Head Restraint Type/Damage By Occupant At This Occupant Position (cont'd.)

- head restraints which can be moved vertically to accommodate occupants of varying heights, and
- head restraints which have a fixed outer framework and a separate center section which is adjustable vertically.

Code "5" (Add-on - no damage) and code "6" (Add-on - damaged during accident) refer to clamp-on, strap-on, or even bolt-on head restraints on a vehicle not originally equipped with head restraints. These two codes should be infrequently used.

Code "9" (Unknown) is used when: (1) there is no vehicle inspection, (2) the type of head restraint cannot be determined, or (3) it is unknown if damage to the restraint was caused by an occupant in the appropriate seat position.

Note: Some manufacturers are providing head restraints for rear seat occupants. These head restraints may be the same or similar to those used in the front seats, or they may be a slight rise in the rear seat back. Any damage to a rear seat head restraint by the occupant in the seat position must be coded regardless of the height of the restraint.

Certain occupant seating situations involve abnormal posture. Examples are:

- occupant on the floor [i.e., in front of a designated seat (e.g., sitting, standing, etc.)];
- occupant lying across one or more seating positions;
- occupant sitting side-by-side of another occupant in the same seating position, since only one can be assigned to the seating position--see OA10, Occupant's Seat Position;
- occupant standing or kneeling in a designated seating position; and
- occupant in or on the lap of another occupant (e.g., sitting, standing, kneeling, etc.).

The table below expresses the relationship between variables OA10, OA25, OA26, OA27, and OA49 for the situations which involve abnormal posture listed above. For the seating variables OA25 through OA27, the guiding principle is that if an occupant is floor associated, lap related, or lying across more than one seating position, then that occupant is not "seated" and the zero codes (i.e., OA25="0", OA26="00", OA27="0", and OA49="0") apply. Otherwise, the occupant is considered "seated" and the best descriptors are used.

OCCUPANT ASSESSMENT FORM

OA25
(3)

Variable Name: Head Restraint Type/Damage By Occupant At This Occupant Position (cont'd.)

Occupant's Situation					
	OA10	OA25	OA26	OA27	OA49
on the floor [i.e., in front of a designated seat (e.g., sitting, standing, etc.)]	14	0	00	0	C
	24	0	00	0	C
	34	0	00	0	C
	44	0	00	0	C
lying across one or more seating positions	14	0	00	0	C
	24	0	00	0	C
	34	0	00	0	C
	44	0	00	0	C
sitting side-by-side of another occupant in the same seating position	11-14	0-6,8-9	01-09,99	1-9	1-4,8,9
	21-24	0-6,8-9	01-09,99	1-9	1-4,8,9
	31-34	0-6,8-9	01-09,99	1-9	1-4,8,9
	41-44	0-6,8-9	01-09,99	1-9	1-4,8,9
standing or kneeling in a designated seating position	11-14	0-6,8-9	01-09,99	1-9	1-4,8,9
	21-24	0-6,8-9	01-09,99	1-9	1-4,8,9
	31-34	0-6,8-9	01-09,99	1-9	1-4,8,9
	41-44	0-6,8-9	01-09,99	1-9	1-4,8,9
in or on the lap of another occupant (e.g., sitting, standing, kneeling, etc.)	15	0	00	0	0
	25	0	00	0	0
	35	0	00	0	0
	45	0	00	0	0

- OA10 - Occupant's Seat Position
- OA25 - Head Restraint Type/Damage by Occupant at This Occupant Position
- OA26 - Seat Type (this Occupant Position)
- OA27 - Seat Performance (this Occupant Position)
- OA49 - Seat Orientation (this Occupant Position)

Variable Name: Seat Type (This Occupant Position)

Element Values:

- 00 Occupant not seated or no seat
- 01 Bucket
- 02 Bucket with folding back
- 03 Bench
- 04 Bench with separate back cushions
- 05 Bench with folding back(s)
- 06 Split bench with separate back cushions
- 07 Split bench with folding back(s)
- 08 Pedestal (i.e., column supported)
- 09 Other seat type (specify)
- 10 Box mounted seat (i.e., van type)
- 99 Unknown

Source: Vehicle inspection.

Remarks:

This variable assesses the type of seat occupied by this occupant.

The type of seat in which an occupant is positioned may have an effect on the occupant kinematics. For this reason the type of seat is important to analysts.

Code "00" (Occupant not seated or no seat) is used when it is determined that a person is not on a seat based on interviewee or PAR information obtained in variable OA10, Occupant's Seat Position.

Code "08" [Pedestal (i.e., column supported) includes both swivel and non-swivel type pedestal seats. A pedestal seat can be differentiated from a bucket seat by the presence of a column supporting the pedestal seat.

Below are examples of some seats and appropriate codes.



BUCKET

(Codes 01 or 02)

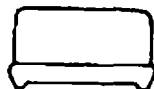

BENCH

(Code 03)



BENCH WITH
SEPARATE BACK
CUSHIONS

(Codes 04)

Variable Name: Seat Type (This Occupant Position) (cont'd.)

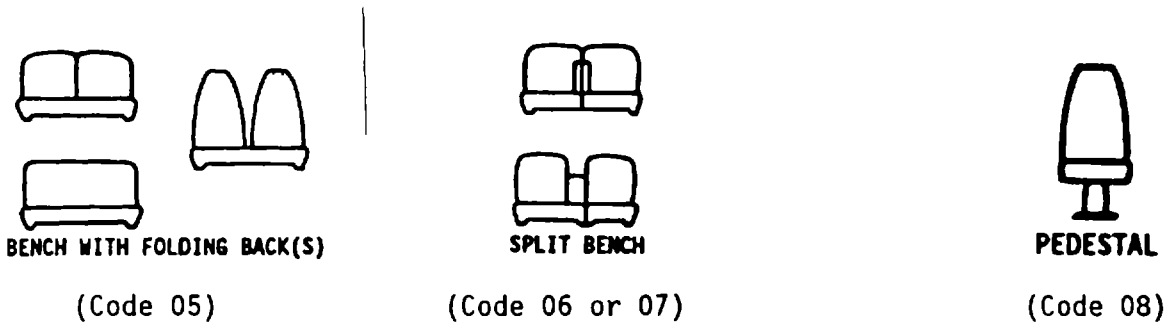

The term "folding back(s)" as used in codes "02", "05", and "07" refers to seat backs which fold forward to allow easier access to the area behind the seat. Seats which recline rearward are not considered to be folding backs. The seat back for the occupant in that seat position is the determining factor for folding back presence. If the seat back does not fold at that position do not use codes "02", "05", and "07". Folding backs, because of the additional possibility of failure of the folding mechanism, take precedence over solid or separate back cushions. For example, a bench seat with separate back cushions which fold forward would be coded "05" [Bench with folding back(s)].

The rear seats in many late model vehicles may be of unusual design. The researcher is cautioned to view only the seat type for the occupant's position. If the seat is of a bench type and the back cushion for the position folds, then the proper code is "05" [Bench with folding back(s)]. The fact that the seat cushion may also fold is not considered.

If the occupant was in a seat position with the seat folded prior to the accident (i.e., second seat area of a station wagon, etc.), then the proper code would be "00" (Occupant not seated or no seat).

Code "10" [Box mounted seat (i.e., van type)] is used to identify elevated seats which have as a part of their attachment design a box which is fastened to the floor and has seat tracks bolted to the top of the box. This type is often found in front row locations of vans. Do not confuse this design with pedestal seats (i.e., "08") which require a single post support column.

Code "99" (Unknown) is used when (1) it is unknown from the interview and FAR information if the person is seated and (2) there is no vehicle inspection or the seat type cannot be determined. However, if the occupant was not seated, then use code "00" (Occupant not seated or no seat).

Variable Name: Seat Performance (This Occupant Position)

Element Values:

- 0 Occupant not seated or no seat
- 1 No seat performance failure(s)
- 2 Seat adjusters failed
- 3 Seat back folding locks or "seat back" failed
- 4 Seat tracks/anchors failed
- 5 Deformed by impact of occupant
- 6 Deformed by passenger compartment intrusion (specify)
- 7 Combination of above (specify)
- 8 Other (specify)
- 9 Unknown

Source: Vehicle inspection

Remarks:

This variable assesses the performance of the seat occupied by this occupant. The codes are indications of whether the seat failed or was deformed in any way. Select the code which corresponds to the appropriate seat performance failure or deformation. Minor smudges, scrapes, dents, etc. are not considered deformation. If a failure or deformity occurs, then document the failure or deformation with a diagram and explanation. In addition, include photographs of the seat failure or deformity.

Code "0" (Occupant not seated or no seat) is used when it is determined that a person is not on a seat based on interviewee or PAR information obtained in variable OA10, Occupant's Seat Position.

Code "1" [No seat performance failure(s)] is used if the seat was not deformed or no portion of the seat structure failed during the accident.

Code "2" (Seat adjusters failed) is used if any of the mechanisms used to adjust a seat's "comfort" position are separated or deformed during the accident as a result of occupant loading.

Seat adjuster mechanisms include:

- Height adjustment
- Longitudinal (horizontal) seat track adjustment
- Rocker adjustment
- Swivel/rotational adjustment
- Seat back recliner adjustment

For a seat back recliner failure, the seat back must have released in a rearward direction. Do not use this code if the seat back failed in a forward direction and the seat has a folding lock mechanism (e.g., front seats in 2-door vehicles); see code "3" below.

Variable Name: Seat Performance (This Occupant Position)

This code should be used when multiple adjuster failures have been detected. Be sure to include supportive written and photographic documentation to support all failures.

Code "3" (Seat back folding locks or "seat back" failed) is used when the mechanism which is designed to lock the seat back in its upright position fails or separates allowing the seat back to move forward during the collision as a result of occupant loading. These seat back types are commonly found on two door vehicles where access to rear seating positions is obtained by folding the seat back forward.

"Seat back" failed refers to forward facing seats where seat back structural failures (e.g., seat back hinge points) resulted in a separation of the seat back from its anchorage points. Again, to be considered applicable for this code, the seat must have failed while moving forward during the collision as a result of occupant loading.

Code "4" (Seat tracks/anchors failed) is used if the seat separates, to any degree, from a seat track during the crash. In addition, use this code if the seat anchor that attaches the seat track to the floorpan separates, to any degree, during the crash. Box mounted seats are included in this code if a separation occurred between the box and the floor or the box and the seat track/anchor. Seat track or anchor failures must be a result of occupant loading.

Code "5" (Deformed by impact of occupant) is used when the seat is changed in form from its original design from occupant loading during the accident. Situations where seats are deformed and also experience mechanical failures should be identified under code "7" (Combination of above).

Code "6" (Deformed by passenger compartment intrusion) is used when the seat is deformed or failed by intrusion of an interior vehicle component(s) or exterior vehicle component(s) into the passenger compartment.

Code "7" (Combination of above) is used when any combination of codes "2"-"6" above occurs and describes multiple seat failures or deformations. Seat failures or deformations which are not described in codes "2"-"6" are reported in code "8" below. Seat failures or deformations listed in codes "2"-"6" take priority over code "8".

Code "8" (Other) is used when the only seat failure(s) or deformation(s) which occur are not described in codes "2"-"6" above (e.g., impact forces).

OCCUPANT ASSESSMENT FORM

OA27
(3)

Variable Name: Seat Performance (This Occupant Position)

Code "9" (Unknown) is used when (1) it is unknown from the interview and PAR information if the person is seated and (2) there is no vehicle inspection or the researcher is unable to determine if the seat was deformed or failed in the accident. However, if the occupant was not seated, then use code "0" (Occupant not seated or no seat).

CHILD RESTRAINT OVERVIEW

These variables are designed to capture a description of child restraints used in all the towed CDS applicable vehicles involved in the accident. Information about the seat is of two types: characteristics and usage. Characteristics are described in OA28, Child Safety Seat Make/Model and OA29, Type of Child Safety Seat. Usage of the seat is coded in OA30, Child Safety Seat Orientation and OA31-OA33, Child Safety Seat Harness/Shield/Tether Usage.

Injury and death of young children has long been a significant part of the motor vehicle accident problem. Unrestrained children have a much greater tendency to be out of place (i.e. not in a designated seating position and generally standing or kneeling on the seat cushion). On impact this makes them very susceptible to injury or death since they are unrestrained. For a number of years, motor vehicle accidents have been the leading cause of injury and death to children under the age of five. Many states have attempted to address this problem by legislation requiring young children to be protected by some sort of child restraint. While these efforts have resulted in a reduction of injuries and death, little data on the real world performance of the child seats has been gathered. Police reports many times fail to note the use of such a restraint.

Specifications for these seats come from Federal Motor Vehicle Safety Standard (FMVSS) 213 (Child Seating Systems). Approval of design and testing is the responsibility of the NHTSA. Most states with child restraint laws require the use of a DOT approved seat.

Performance of the seat is also an extremely critical issue. Other than staged laboratory tests, very little data exists on what happens to these seats and how well they perform in protecting the occupants. Analysts will compare use, injury severity levels, and delta V's for initial gross performance levels. Once that type of analysis is done, source of injury will be examined, along with seat type and make/model. All of these analyses will initially be used to evaluate the effectiveness of FMVSS 213 and help determine if the standard should be updated or modified. The other main use of performance analysis is to determine if any type or make/model has any significant problems.

All of the analyses are very dependent on having enough data. Researchers noting that a child younger than five years is an occupant in a CDS applicable vehicle must pursue the interview questions with the presumption that a child seat was present, especially if the jurisdiction has a child restraint law or ordinance. Probing questions should be asked during the interview, and whenever possible, an inspection of the seat should take place. Of course, if the seat is still with the vehicle it should be inspected at the same time as the vehicle. However, finding the seat with the vehicle is not a common occurrence. This is another area where the perseverance of the researcher pays off in needed information.

Child restraints are a major issue, and data collection in this area has a high priority. Much information is needed to provide a reliable evaluation of the real world performance of these restraints.

CHILD RESTRAINT OVERVIEW (Continued)

Beginning with the 1993 data collection year, the posture of occupants in child safety seats will not be considered abnormal for the presence of any child safety seat when the child was correctly seated in the seat as designed. In prior data collections years the posture of the occupant in a child safety seat was always considered abnormal because of the low frequency of usage of child safety seats. Most states now have laws that require the use of child safety seats for infants and children. This has resulted in a significant increase in child safety seat use. See variable OA11 (Occupant's Posture) for instructions for coding posture for occupants of child safety seats.

Variable Name: Child Safety Seat Make/Model

Element Values:

<u>Model Code</u>	<u>Make/Model</u>	<u>Includes</u>	<u>Manufacturer</u>
000	No child safety seat		
Infant Safety Seats			
101	GM Love Seat		Century Products
* 102	Century Infant Car Seat	560, 565, 570 (discontinued)	Century Products ¹
103	Century Infant Love Seat		Century/Chrysler
104	Cuddle Shuttle		Collier-Keyworth
* 105	Cosco TLC		Cosco
106	Trav-L-Ette		Cosco/Peterson
107	Cosco First Ride		Cosco/Peterson
108	Evenflo Infant Car Seat		Evenflo
* 109	Dyn-O-Mite		Evenflo ²
110	Infant Carrier		Ford
111	Snug Seat		Graco
* 112	Rock 'N Ride		Kolcraft
113	Swinger		Romer/KFS
114	Rockit Seat 640	639, 640	Strolee
* 115	Joy Ride		Evenflo
* 116	Cosco Dream Ride		Cosco
* 117	Travel Tandem		Evenflo
* 118	Fisher-Price Infant Seat		Fisher-Price
* 119	Gerry Guard with Glide		Gerico, Inc.
* 120	Safeline Sit'n'Stroll		Unknown
* 121	Century Infant Car Seat	580 (discontinued), 590	Century Products ¹
Convertible Safety Seats			
201	Century Safety Car Seat	100	Century Products
202	Century Safety Car Seat	200	Century Products
203	Century Safety Car Seat	300	Century Products
204	Century Safety Car Seat	400, XL	Century Products
* 205	Century S.T.E. Car Seat	1000	Century Products
* 206	Century S.T.E. Car Seat	2000	Century Products
* 207	Century S.T.E. Car Seat	3000, 3500 Premier	Century Products
208	Child Love Seat	GM Child Love Seat	Century Products
209	Safe & Sound	II	Collier-Keyworth
210	Roundtripper		Collier-Keyworth
211	Voyager		Collier-Keyworth
* 212	Cosco Soft Shield	Auto Trac, Autotrac	Cosco
213	Cosco Safe & Easy		Cosco
214	Cosco Safe & Snug		Cosco
* 215	5 Pt/Commuter (discontinued)	Luxury 5-Pt	Cosco
216	Explorer		Cosco
217	Safe-T-Seat		Cosco ³
218	Safe-T-Shield		Cosco/Peterson
219	Safe-T-Mate		Cosco/Peterson
220	Peterson Safety Shield		Cosco/Peterson

Variable Name: Child Safety Seat Make/Model (cont'd.)

<u>Model Code</u>	<u>Make/Model</u>	<u>Includes</u>	<u>Manufacturer</u>
Convertible Safety Seats (cont'd)			
221	Evenflo Convertible		Evenflo
* 222	Seven Year Car Seat		Evenflo
223	Bobby Mac	Deluxe II, Champion Super, Lite	Evenflo ²
* 224	One-Step		Evenflo ²
* 225	Fisher-Price Car Seat		Fisher-Price
* 226	Gerry Guardian	633 (discontinued), 643 653, 655	Gerico, Inc.
227	Little Trav'ler	310, 315	Graco
228	GT 100		Graco
229	Teddy Tot Astroseat	9100/9300 Series	International
230	Hi-Rider XL	"7"	Kolcraft
231	Redi-Rider		Kolcraft
232	Quikstep		Kolcraft
233	Ultra Ride		Kolcraft
* 234	Nissan Safety Seat	Infant/Child	Nissan
235	Pride-Ride	820 & 830 series	Pride-Trimble
236	Kantwet Care Seat		Questor/Kantwet
237	Kantwet Safe Guard		Questor/Kantwet
238	Peggy		Romer/KFS
239	Tip-up		Romer/KFS
240	Wee Care	500 Series	Strolee
241	Wee Care	600 Series	Strolee
242	GT	2000, 3000	Strolee
243	Quick Click		Strolee
244	Volvo Child Seat		Volvo
245	Child Cushion		Volvo
246	Welsh Travel Tot		Welsh
247	Perfect F.I.T.T.		Kolcraft
* 248	Ultra	I, II, V	Evenflo
* 249	Baby Sitter	Wonda Chair	Babyhood
* 250	Century S.T.E. Car Seat	5000, 5500 Premier	Century Products
* 251	Gerry Guardian	654	Gerico, Inc.
* 252	Auto-Mate	Dial-A-Fit	Kolcraft
* 253	Playskool Carseat		Kolcraft
254	Prodigy Kiwi	Kiwi Plus	Prodigy
255	Prodigy Shuttle		Prodigy
* 256	Renolux GT 2000		Renolux
* 257	Renolux GT 5000	4000 (discontinued) 7000	Renolux
* 258	Comfort Rule		Cosco
* 259	Champion	Scout	Evenflo
* 260	Traveler 700		Kolcraft
* 261	Premier	V	Evenflo
* 262	Gerry Guard SecureLock		Gerico, Inc.
* 263	Ronolux	Turn-a-Tot	Ronolux

Variable Name: Child Safety Seat Make/Model (cont'd.)

<u>Model</u>	<u>Code</u>	<u>Make/Model</u>	<u>Includes</u>	<u>Manufacturer</u>
Booster Safety Seats				
*	301	Century Commander		Century Products
	302	Safe-T-Rider	II, Deluxe	Century Products
	303	Co-Pilot	II	Collier-Keyworth
*	304	Cosco Explorer	I	Cosco
	305	Travel Hi-Lo	Deluxe High Back	Cosco/Peterson
*	306	Evenflo Booster		Evenflo
	307	Wings	by Bobby Mac	Evenflo ²
	308	Tot Guard		Ford
	309	Gerry Voyager		Gerico, Inc.
	310	Teddy Tot Astrorider	6000 Series	International
*	311	Tot Rider Quick Step	XL	Kolcraft
	312	Flip N' Go	II	Kolcraft
	313	#812		Pride-Trimble
	314	Click 'N Go	890 Series	Pride-Trimble
	315	Vario		Romer/KFS
	316	Wee Care Booster Seat	600 Series	Strolee
	317	Quick Click 605 Booster		Strolee
	318	Cosco Auto Booster		Cosco
*	319	Sightseer		Evenflo
*	320	Century CR-3		Century Products
*	321	Gerry DoubleGuard		Gerico, Inc.
Special Needs Safety Seats				
**	401	Swinger Infant Car Bed	Carry Cot	Shinn & Assoc. ⁴
**	402	Britax		Shinn & Assoc. ⁴
**	403	E-Z-On Vest	101-TCXS, 101-TC, 102-TC (8 sizes)	E-Z On Products ⁵
**	404	Carrie Car Seat System	(3 sizes): 20-40 lbs; 30-60 lbs; & 50-100 lbs	Tumble Forms
**	405	Modified E-Z-On Vest	101M	E-Z On Products
**	406	Travel Chair		Ortho-Kinetics
**	407	Preemie Bunting		Koziatek & Assoc.
**	408	SPELCAST		Koziatek & Assoc.
**	409	Columbia Orthopedic Seat		Columbia Medical
**	410	Kidster	(3 sizes)	Gunnell
**	411	Snug Seat		Snug Seat
**	412	900 Series Transporter		Safety Rehab
Harnesses				
*	501	Little Cargo Auto Vest	(Harness only)	New Harness
	950	Built-in child safety seat		
	997	Other make/model (specify)		
	998	Unknown make/model		
	999	Unknown if child safety seat used		

Variable Name: Child Safety Seat Make/Model (cont'd)

* All of these models are currently listed by the American Academy of Pediatrics in their publication entitled: 1992 Family Shopping Guide to Car Seats.

** All of these models are cited on page 4 of Safe Ride News, Spring 1989, published by the American Academy of Pediatrics.

- ¹ Gerber Furniture Group now owns Century Products.
- ² This Evenflo model was formerly produced by Questor/Kantwet.
- ³ This Cosco model was formerly produced by Cosco/Peterson.
- ⁴ These models were formerly produced by Evenflo
- ⁵ These models were formerly produced by Rupert.

Source: Researcher determined--inputs include vehicle inspection, interviewee, and police report.

Remarks:

Code "000" (No child safety seat) is used when (1) this person is not an infant or child (i.e., less than 23 kilograms and less than 102 centimeters or less than six years old if height and weight not known), or (2) this person is an infant or child, but was not using an infant or child seat.

Codes "001" through "998" (i.e., child safety seat make/model codes) are used when this person is an infant or child and is using a child safety seat. If a qualifying infant or child was using a child safety seat, then document the make/model from the list provided above and code the make/model's number.

If height and weight information is absent, then use age to establish if this person should be classified as an infant or child. Persons six years of age and older are not classified as an infant or child; thus, use code "000" (No child safety seat).

If this person is an infant or child and was an occupant of a hit-and-run vehicle, then code this variable from available information. If age, height, or weight information is unavailable on this hit-and-run occupant, then use code "000" (No child safety seat).

Code "950" (Built-in child safety seat) is used when a qualifying child is using a child safety seat which has been integrated into the child's seating position. Built-in child safety seats are currently designed as alternatives to existing toddler or booster seats (i.e., OA29, Type of Child Safety Seat, codes "2" or "4"). They are not intended as infant seats. These seats must be pulled or folded out of the existing seat back in order to be used. If the built-in child safety seat was not put into its proper position, then code "000" (No child safety seat).

Variable Name: Child Safety Seat Make/Model (cont'd)

Code "997" (Other make/model) is used when a qualifying infant or child is using a non-built-in child safety seat but the make/model (which is known) is not listed above.

Code "998" (Unknown make/model) is used when a qualifying infant or child is using a non-built-in child safety seat but the make/model is not known.

Code "999" (Unknown if child safety seat used) is used when it is unknown if the person under consideration is an infant or child, or it is unknown if this person was using a child safety seat.

Variable Name: Type of Child Safety Seat

Element Values:

- 0 No child safety seat
- 1 Infant seat
- 2 Toddler seat
- 3 Convertible seat
- 4 Booster seat
- 7 Other type child safety seat (specify)
- 8 Unknown child safety seat type
- 9 Unknown if child safety seat used

Source: Researcher determined--inputs include vehicle inspection, interviewee, and police report.

Remarks:

Code "0" (No child safety seat) is used when (1) this person is not an infant or child (i.e., less than 23 kilograms and less than 102 centimeters or less than six years old if height and weight not known), or (2) this person is an infant or child, but was not using an infant or child seat.

Use the person's age (i.e., less than six versus six and older) to determine if this person is an infant or child when height and weight information is absent. Child carriers that are not designed as safety seats are to be classified as "No child safety seat". Examples of these child carriers are shown below.

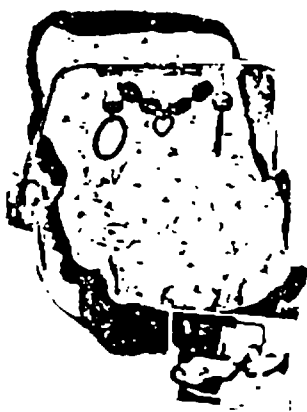

Kolcraft
"Baby's First Touch"

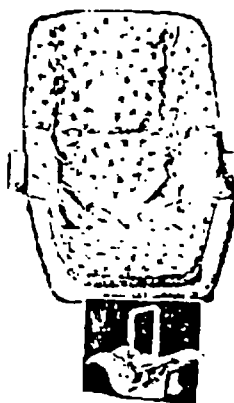

Century
"Kanga-Rocka-Roo"



Cosco
"Day Cradle/Carrier"

If this person is an infant or child and was an occupant of a hit-and-run vehicle, then code this variable from available information. If age, height, or weight information is unavailable on this hit-and-run occupant, then use code "0" (No child safety seat).

Variable Name: Type of Child Safety Seat (cont'd.)

Code "1" (Infant seat) is used when the seat is designed to only face the rear of the vehicle and the maximum capacity is 8-9 kilograms (this information will usually be found on the manufacturer's label). Infant safety seats are equipped with a five-point harness (straps) to secure the infant to the safety seat and use the vehicle's safety belt system (i.e., manual or automatic) to secure the seat to the vehicle. The five-point infant seat system includes a pair of straps that go over the infant's shoulders, a crotch strap, and the vehicle's belts as lap belts to secure the seat to the vehicle. The seat is tub-shaped and cradles the baby in a generally reclined position. Examples are shown below.

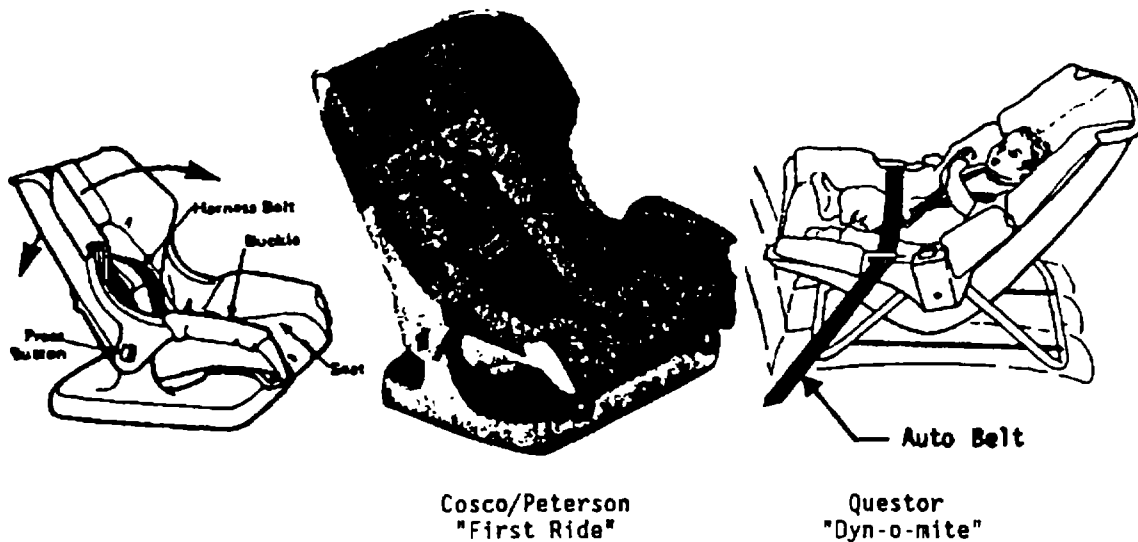

Code "2" (Toddler seat) is used when the seat is designed to only face the front of the vehicle and to carry a child weighing approximately 9-23 kilograms (this information will usually be found on the manufacturer's label). The toddler seat may also be referred to as a "child seat". Most have a five-point harness system (straps) to secure the child to the seat. All models secure the safety seat to the vehicle with the vehicle's safety belts (i.e., manual or automatic) and, in addition, some models have a tether strap which must be attached to the rear manual safety belt or deck lid to prevent tipping forward. The child is restrained by a shield, a harness, or a combination of the two in a generally upright sitting position, although some seats have multiple positions. Examples are shown below.

Variable Name: Type of Child Safety Seat (cont'd.)

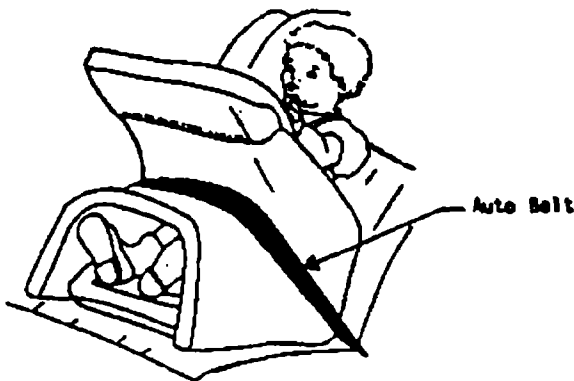

Shield Type

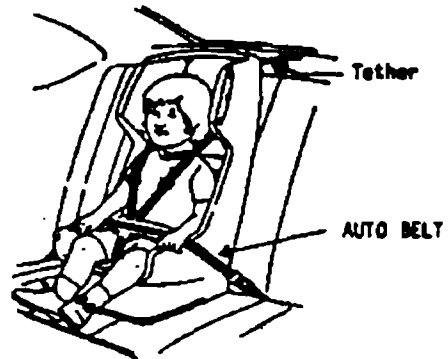

Harness Type

Code "3" (Convertible seat) is used when the seat is designed to face the front or rear of the vehicle and to carry a child ranging from birth to approximately 23 kilograms (this information will usually be found on the manufacturer's label). Most have a harness system (straps) to secure the child to the seat. All models secure the safety seat to the vehicle with the vehicle's safety belts (i.e., manual or automatic) and, in addition, some models have a tether strap which must be attached to the rear manual safety belt or deck lid to prevent tipping forward. The child is restrained by a shield, a harness, or a combination of the two in either a generally reclined rearward facing position (for small infants--birth to 9 kilograms) or a generally upright forward sitting position (for larger children--9-23 kilograms). Examples are shown below:

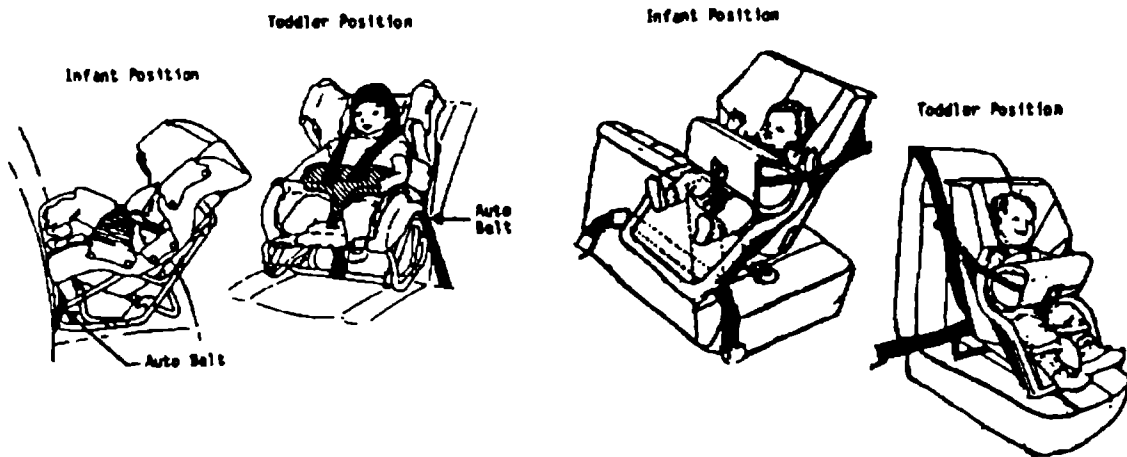

Harness Type
Century "200"

Combination Harness and Shield
Type Cosco/Peterson "SAFE & SNUG"

Variable Name: Type of Child Safety Seat (cont'd.)

Code "4" (Booster seat) is used when the seat is designed as a forward facing platform without a back (except for one Cosco/Peterson model which has a back) and adjusts to children up to 27 kilograms. The booster seat restrains the child in a raised upright sitting position with either a harness or shield. Booster seats are designed primarily to fill the gap between when a child outgrows the standard child safety seat and when the child can use the adult belt (i.e., manual or automatic) and still see out the window. Some models can also be used for smaller children, as small as 9 kilograms. Examples of booster seats are shown below.

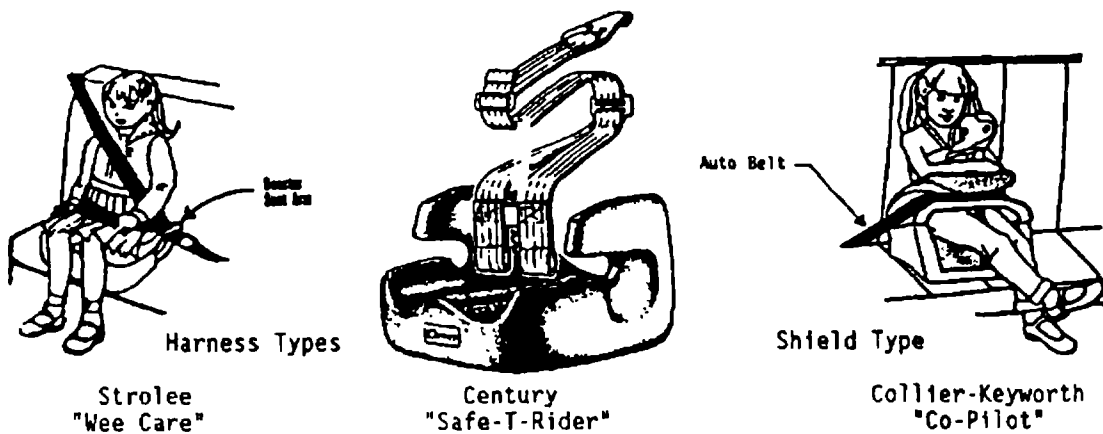

Some of the above infant, child, convertible and booster seats require a tether. When a tether-required seat is placed in the vehicle's front seat, the tether should run over the top of the seat and attach to a rear manual seat belt or possibly to one of the anchors for a front seat belt (i.e., manual or automatic). When a tether-required seat is placed in the vehicle's rear seat, the tether should run over the top of the rear seat and attach to an anchor on the rear window shelf or possibly pass through the rear window shelf and attach to one of the anchors for a rear manual seat belt.

Used with Lap Belt and Harness



Code "7" (Other type child safety seat) is used when the infant or child safety seat cannot be described by codes "1" through "4" above. Specify the type.

Code "8" (Unknown child safety seat) is used when a child safety seat is in use but the type of child safety seat is unknown.

Code "9" (Unknown if child safety seat used) is used when it is unknown if the person under consideration is an infant or child, or it is unknown if this person was using a child safety seat.

Variable Name: Child Safety Seat Orientation

Element Values:

00 No child safety seat

Designed for Rear Facing for This Age/Weight

01 Rear facing

02 Forward facing

08 Other orientation (specify)

09 Unknown orientation

Designed for Forward Facing for This Age/Weight

11 Rear facing

12 Forward facing

18 Other orientation (specify)

19 Unknown orientation

Unknown Design or Orientation for This
Age/Weight, or Unknown Age/Weight

21 Rear facing

22 Forward facing

28 Other orientation (specify)

29 Unknown orientation

99 Unknown if child safety seat used

Source: Researcher determined--inputs include vehicle inspection, interviewee, and police report.

Remarks:

Code "00" (No child safety seat) is used when (1) this person is not an infant or child (i.e., less than 23 kilograms and less than 102 centimeters or less than six years old if height and weight not known), or (2) this person is an infant or child, but was not using an infant or child seat.

If height and weight information is absent, then use age to establish if this person should be classified as an infant or child. Persons six years of age and older are not classified as an infant or child; thus, use code "00" (No child safety seat).

If this person is an infant or child and was an occupant of a hit-and-run vehicle, then code this variable from available information. If age, height, or weight information is unavailable on this hit-and-run occupant, then use code "00" (No child safety seat).

The researcher must determine from the seat, using the Child Safety Seat Identification Guide, the designed orientation for this person's weight or age. Next, the actual orientation of the seat at-impact must be determined to obtain the correct code.

Variable Name: Child Safety Seat Orientation (cont'd)

For example, a one and one-half year old child whose weight is 8 kilograms was sitting in a forward facing Century 300 child safety seat. The correct code based upon the Child Safety Seat Identification Guide is "02" (Forward facing). At this age and weight the convertible seat should be rear facing but was forward facing.

Before using any code the researcher must carefully review the subcategories and choose the appropriate code based on designed orientation at the occupant's age and weight.

Code "01", "11", or "21" (Rear facing) or "02", "12", or "22" (Forward facing) if at the time of the accident the seat was facing the rear of the vehicle or the front of the vehicle, respectively. Do not code with respect to the vehicle's direction of travel (e.g., backing vehicle).

Code "08", "18", or "28" (Other orientation) if the seat was facing other than rear or forward at the time of the accident (e.g., on the floor, sideways, on top of or underneath something).

Code "09", "19", or "29" (Unknown orientation) is used when a child safety seat is in use but the orientation at the time of the accident is unknown (e.g., at the time of vehicle inspection the child safety seat is not present or is unattached and there is no information from an interview or the PAR).

Code "99" (Unknown if child safety seat used) is used when it is unknown if the person under consideration is an infant or child, or it is unknown if this person was using a child safety seat.

Variable Name: Child Safety Seat Harness Usage
Child Safety Seat Shield Usage
Child Safety Seat Tether Usage

Element Values:

00 No child safety seat

Not Designed with Harness/Shield/Tether

01 After market harness/shield/tether added, not used

02 After market harness/shield/tether used

03 Child safety seat used, but no after market harness/shield/tether added

09 Unknown if harness/shield/tether added or used

Designed with Harness/Shield/Tether

11 Harness/shield/tether not used

12 Harness/shield/tether used

19 Unknown if harness/shield/tether used

Unknown If Designed with Harness/Shield/Tether

21 Harness/shield/tether not used

22 Harness/shield/tether used

29 Unknown if harness/shield/tether used

99 Unknown if child safety seat used

Source: Researcher determined--inputs include vehicle inspection, interviewee, and police report.

Remarks:

Code "00" (No child safety seat) is used when (1) this person is not an infant or child (i.e., less than 23 kilograms and less than 102 centimeters or less than six years old if height and weight not known), or (2) this person is an infant or child, but was not using an infant or child seat. If height and weight information is absent, then use age to establish if this person should be classified as an infant or child. Persons six years of age and older are not classified as an infant or child; thus, use code "00" (No child safety seat).

If this person is an infant or child and was an occupant of a hit-and-run vehicle, then code this variable from available information. If age, height, or weight information is unavailable on this hit-and-run occupant, then use code "00" (No child safety seat). The design of each child safety seat must be assessed regarding harness, shield, and tether use.

Refer to the Child Safety Seat Identification Guide to ascertain the design of the seat and the applicability of the harness, shield, and tether to each seat individually.

OCCUPANT ASSESSMENT FORM

0A31
0A32
0A33
(2)

Variable Name: Child Safety Seat Harness Usage(cont'd.)
Child Safety Seat Shield Usage (cont'd.)
Child Safety Seat Tether Usage (cont'd.)

An "after market" harness/shield/tether is one added by the user to a child safety seat not originally designed to use the device.

Code "99" (Unknown if child safety seat used) is used when it is unknown if the person under consideration is an infant or child, or it is unknown if this person was using a child safety seat.

INJURY/CONSEQUENCES OVERVIEW

These variables are grouped into two areas. First, how severely was this occupant injured, and second, what were the injury consequences for this occupant. Variables which address the first area are OA34, Injury Severity (Police Rating), OA43, Number of Recorded Injuries for This Occupant, and OA35, Treatment-Mortality. The second area is addressed by the variables OA35, Treatment-Mortality, OA36, Type of Medical Facility (for Initial Treatment), OA37, Hospital Stay, OA38, Working Days Lost, and OA39, Time to Death. Treatment - Mortality (OA35) addresses both areas because of its format.

Variables OA40 through OA42, Medically Reported Cause of Death, indicate which of the recorded injuries on the Occupant Injury Form, reported by a physician or lay coroner, were the causes of death.

Treatment and delivery of care for minor to moderately injured accident victims has improved and is being provided in areas where it was not available previously. The long term results of trauma continue to be lessened through this improved care delivery and treatment system. Availability of care has increased due to competition in the medical industry. Neighborhood clinics have become prevalent in all areas, especially in some of the smaller rural communities. This expansion of care has not been fully documented for the motor vehicle accident picture and leaves the injury assessment area with some data loss. Persons that formerly went to the emergency room or the local hospital to see their family doctor, now may go to the neighborhood minor emergency medical clinic. This change is also somewhat a result of the improved protection for occupants from injuries caused by vehicle interiors during accidents.

Another factor that is changing rapidly is the length of time spent in a hospital. The current emphasis is to get the patient out of the hospital as quickly as possible and into a home environment for convalescence. For this reason the overall days lost are changing.

All of these changes are a direct reflection of changes in societal costs, both in terms of direct cost (e.g., injury and treatment) and indirect costs (e.g., lost productivity due to days lost while the vehicle is repaired). Since this is a rapidly changing picture, more documentation needs to be provided for good analysis.

Coding these variables is based primarily on medical records. There are only two variables which do not come from an official record, and they are Working Days Lost (OA38) and Type of Medical Facility (for Initial Treatment) (OA36). Sometimes no records are available, for example, when a treatment facility will not provide records, or when there was no treatment. In the case of no records, interviewee data are the primary source for all variables except the Injury Severity (Police Rating) (OA34), Time to Death (OA39), and Medically Reported Cause of Death (OA40 - OA42).

In summary, information from these variables forms the basis for analysis of occupant injury severity and injury consequences. Most of the information comes from official records, and the rest is completed by interviewee information. Perseverance in pursuit of this information will result in a high completion rate for these variables.

Variable Name: Injury Severity (Police Rating)

Element Values:

- 0 O - No injury
- 1 C - Possible injury
- 2 B - Nonincapacitating injury
- 3 A - Incapacitating injury
- 4 K - Killed
- 5 U - Injury, severity unknown
- 6 Died prior to accident
- 9 Unknown

Source: Police report.

Remarks:

Code the police reported injury severity for this occupant. It is possible that the police could have updated the PAR between the time it was stratified and when it was picked up. For example, a person might have been listed originally with incapacitating injuries (code "3"). Later the person dies (code "4"), and the PAR is changed accordingly. Therefore, use the latest information on the PAR at the time it was obtained from the police agency.

If the police report contains a detailed description of the injuries but does not translate the injuries into the KABCO codes, use the police method for doing so. For example, injuries which are considered to be of an incapacitating nature are classified as "A" (code "3"), nonincapacitating-evident injuries are classified as "B" (code "2"), and possible injuries are "C" (code "1"). Property damage only is classified as "O" (code "0").

Code "5" (U - Injury, severity unknown) is used when the police report indicates a "U" or in any other way communicates the idea that the person was injured but their severity is unknown.

Code "6" (Died prior to accident) is only used if the police explicitly so indicate.

As a general rule, if the PAR is "blank" where the injury severity is assessed and the person was at the scene during the police investigation, then code "0" (O - No injury). If the PAR is "blank" and the person was not present during the police investigation, then code "9" (Unknown).

Not all states use the KABCOU scheme. Listed below, by state, are alternative schemes; a mapping to the NASS scheme is provided.

Variable Name: Injury Severity (Police Rating) [cont'd.]

State	PAR Code/Definition	NASS Scheme/Code
Alabama	K = Killed	K - 4
	A = Visible or carried from scene	A - 3
	B = Bruise/abrasion/swelling	B - 2
	C = No visibility - has pain/faint	C - 1
	Blank = No documentation of driver or occupant injury = No set unknown code	Blank - 0 - 9
Arizona	1 = No injury	0 - 0
	2 = Possible injury	C - 1
	3 = Nonincapacitating injury	B - 2
	4 = Incapacitating injury	A - 3
	5 = Fatal	K - 4
	6 = Unknown	U - 9
California	1 = Fatal	K - 4
	2 = Severe wound/distorted member	A - 3
	3 = Other visible injury	B - 2
	4 = Complaint of pain	C - 1
	Blank = Occupant present Blank = Occupant not present	0 - 0 - 9
Colorado*	5 = Fatal	K - 4
	4 = Evident - incapacitating	A - 3
	3 = Evident - nonincapacitating	B - 2
	2 = Possible injury	C - 1
	1 = No injury	0 - 0
<p>* There is a box at the top of the PAR indicating number of persons injured. If this box is marked 0 and the injury code is left "blank", assume "No injury". If the box is marked 1 (or more) pertaining to the vehicle occupants in question and the injury code is "blank", assume "Injured, severity unknown". If "blanks" are present in both the persons injured box and the injury code box, assume "Unknown".</p>		
Florida	1 = No Injury	0 - 0
	2 = Possible Injury	C - 1
	3 = Nonincapacitating Injury	B - 2
	4 = Incapacitating Injury	A - 3
	5 = Fatal (IN 90 Days) Injury	K - 4
	6 = Non-Traffic Fatality = No set unknown code	U - 9 - 9

OCCUPANT ASSESSMENT FORM

OA34
(3)

Variable Name: Injury Severity (Police Rating) [cont'd.]

State	PAR Code/Definition			NASS Scheme/Code
Indiana	Nature of Most Severe Injury (21)	Location of Most Severe Injury (22)	Victim's Injury Status (23)	
	1-11 Any Entry	1-12 Any Entry	6 Dead	K - 4
	1-11 Any Entry	1-12 Any Entry	2 Semiconscious 3 Incoherent 4 Unconscious	A - 3
	1 Severed 2 Internal 4 Severe Burn 7 Severe Bleed (Arterial) 8 Fracture/dislocation	1-12 Any Entry	1 Conscious 5 Shock 7 Refused Med	A - 3
	3 Minor Burn 6 Minor Bleed 10 Complaint of Pain 11 None Visible	3 Eye	1 Conscious 5 Shock 7 Refused Med	A - 3
	3 Minor Burn 6 Minor Bleed	1-2, 4-12 (Any EXCEPT Eye)	1 Conscious 5 Shock 7 Refused Med	B - 2
	5 Abrasion 9 Contusion/Bruise	1-12 Any Entry	1 Conscious 5 Shock 7 Refused Med	B - 2
	10 Complaint of Pain 11 None Visible	1-2, 4-12 (Any EXCEPT Eye)	1 Conscious 5 Shock 7 Refused Med	C - 1
	11 None Visible	Blank or Slashed	1 Conscious	0 - 0
	Blank or Slashed	Blank or Slashed	Blank or Slashed	0 - 0
	Unknown	Unknown	Unknown	U - 9

OCCUPANT ASSESSMENT FORM

OA34
(4)

Variable Name: Injury Severity (Police Rating) [cont'd.]

State	PAR Code/Definition			NASS Scheme/Code
Maryland	5	Fatal		K - 4
	4	Incapacitating		A - 3
	3	Nonincapacitating		B - 2
	2	Possible injury		C - 1
	1	No injury/Damage only		0 - 0
	Blank	No documentation of driver or occupants on front of PAR		
Nebraska	4	Fatal		K - 4
	3	Incapacitating injury		A - 3
	2	Nonincapacitating injury		B - 2
	1	Possible injury		C - 1
	0	No injury		0 - 0
	Blank	Occupant present		0 - 0
	Blank = Occupant not present		- 9	
New Jersey	Location of Injury	Type of Injury	Victim's Condition	
	Any entry	Any entry	Killed	K - 4
	Any entry	Any entry	Incapacitated	A - 3
	Any entry	amputation, concussion, internal, fracture/dislocation	Moderate injury complaint of pain	A - 3
	Eye	burn, bleeding, complaint of pain	Moderate injury Complaint of pain	A - 3
	Any entry	bleeding, contusion, bruise, abrasion	Moderate injury	B - 2
	Any entry (except eye)	complaint of pain	Complaint of pain	C - 1
	-	-	-	0 - 0
	U	U	U	- 9

OCCUPANT ASSESSMENT FORM

OA34
(5)

Variable Name: Injury Severity (Police Rating) [cont'd.]

State	PAR Code/Definition			NASS Scheme/Code
New York	Location of Injury {14}	Type of Injury {15}	Victim's Status {16}	
	1-12 Any entry	1-13 Any entry	1 Apparent death	K - 4
	1-12 Any entry	1-13 Any entry	2 Unconscious, 3 Semi-conscious, 4 Incoherent	A - 3
	1-12 Any entry	1 Amputation, 2 Concussion, 3 Internal, 5 Severe Bleeding, 7 Moderate Burn, 8 Severe Burn, 9 Fracture - Dislocation	5 Shock, 6 Conscious	A - 3
	3 Eye	4 Minor Bleeding, 6 Minor Burn, 12 Complaint of Pain	5 Shock, 6 Conscious	A - 3
	All but eye 1, 2, 4-12	4 Minor Bleeding, 6 Minor Burn	5 Shock, 6 Conscious	B - 2
	1-12 Any entry	10 Contusions - Bruise, 11 Abrasion	5 Shock, 6 Conscious	B - 2
	All but eye 1, 2, 4-12	12 Complaint of Pain	5 Shock, 6 Conscious	C - 1
	-	13 None Visible	6 Conscious	O - 0
	X	X	X	- 9

OCCUPANT ASSESSMENT FORM

OA34
(6)

Variable Name: Injury Severity (Police Rating) [cont'd.]

State	PAR Code/Definition	NASS Scheme/Code
Pennsylvania	0 = No injury	O - 0
	1 = Death	K - 4
	2 = Major injury	A - 3
	3 = Moderate injury [and] Type of Apparent Injury	A - 3
	- amputation	
	- broken bone(s)	
	- distorted member	
	- other incapacitating injury	
	3 = Moderate injury [and] Type of Apparent Injury	B - 2
	- abrasions/contusions/bruises	
- burns		
- bleeding		
- concussion		
- other		
4 = Minor injury [and] Type of Apparent Injury	C - 1	
- complaint of pain		
- dizziness		
- shock		
Tennessee	4 = Fatal Injury	K - 4
	3 = Incapacitating Injury	A - 3
	2 = Nonincapacitating Injury	B - 2
	1 = Possible Injury	C - 1
	0 = No Injury	O - 0
Washington	1 = No injury	O - 0
	2 = Dead at scene	K - 4
	3 = Dead on arrival	K - 4
	4 = Died in hospital	K - 4
	5 = Disabling injury	A - 3
	6 = Nondisabling injury	B - 2
	7 = Possible injury	C - 1
	Blank = Unknown	- 9

Variable Name: Treatment - Mortality

Element Values:

- 0 No treatment
- 1 Fatal
- 2 Fatal - ruled disease

Nonfatal

- 3 Hospitalized
- 4 Transported and released
- 5 Treatment at scene - nontransported
- 6 Treatment later
- 8 Treatment - other (specify)
- 9 Unknown

Source: Researcher determined--inputs include interviewee, police report, and medical records.

Remarks:

Official sources (if they exist) take precedence over interview data.

Code "0" (No treatment) includes persons transported to a hospital but who refuse treatment. As long as there was transportation directly from the scene, a refusal of treatment will not, on its own, affect the stratification of the case.

Code "1" (Fatal) is used when death occurs within 30 days of the accident. Death must have occurred as a consequence of injuries sustained in the traffic accident. Interview information alone should not be sufficient to select this code.

Code "2" (Fatal - ruled disease) is used in two situations. The first is when the effects of a disease can be deemed as a cause of the accident. Cause means that the on-set of the disease occurred prior to the first harmful event. When determining the time of on-set (relative to the first harmful event), the researcher can use any information source available. The researcher makes his/her determination after weighing all the evidence. (NOTE: The use of all available information sources is restricted to the determination of when the on-set occurred.)

Code "2" (Fatal - ruled disease) is used additionally when a medical examiner (or other official vested by the state to verify the cause of death) or an official medical report verifies that the death resulted from either (1) a diseased condition, or (2) not from accident related injuries.

Code "3" (Hospitalized) is used when hospitalization occurs as a result of injury (need not be taken directly to a hospital). See Hospital Stay

Variable Name: Treatment - Mortality (cont'd.)

(OA37) for hospitalization criteria. Also use this code if a person is treated and released then subsequently hospitalized as a result of injuries sustained in the accident.

Code "4" (Transported and released) is used when the person went directly from the accident scene to a treatment facility (hospital, clinic, doctor's office, etc.), and the person is examined for injuries at the facility. The person need not have been injured. The means of transportation is not a consideration.

Code "5" (Treatment at scene - nontransported) includes treatment at scene such as: first aid, self-treatment, EMT treatment, doctor treatment, etc.--and the person is not transported or does not go to a treatment facility (e.g., doctor, clinic, hospital, etc.) as a result of injuries sustained in this accident.

Code "6" (Treatment later) includes only professional treatment (e.g., doctor, clinic, hospital, etc.) where the person (1) did not go directly from the scene to treatment, and (2) was treated and released. If a person is treated at the scene, is not transported from the scene, and subsequently receives later treatment (without being hospitalized), then use this code.

Code "8" (Treatment - other) includes nonprofessional treatment such as first aid, self-treatment, etc., not at the scene of the accident. If this code is used, then OA36, Type of Medical Facility (for Initial Treatment), must be coded "0" (Not treated at a medical facility).

If a person survives the injuries and receives treatment at a hospital, but is not admitted for hospitalization, that person's treatment is to be coded as either "4" (Transported and released) or "6" (Treatment later), depending upon whether the person went directly or indirectly to the hospital. It does not matter if the person is treated for one hour or twelve, only that the person is released following treatment. Nor does it matter if the treatment begins prior to midnight and spans into the following day.

Variable Name: Type of Medical Facility (for Initial Treatment)

Element Values:

- 0 Not treated at a medical facility
- 1 Trauma center
- 2 Hospital
- 3 Medical clinic
- 4 Physician's office
- 5 Treatment later at medical facility
- 8 Other (specify)
- 9 Unknown

Source: Researcher determined--inputs include police report, interviewee, official records, and the American College of Surgeons classification criteria.

Remarks:

The treatment of injuries by a physician immediately (i.e., within one hour) following an accident is of utmost importance in serious injury accidents. In order to assess the quality of immediate care available to the victims in (DS accidents, the following criteria are used to categorize the various treatment facilities. Teams must develop a listing of treatment facilities serving their PSU and categorize each into this variable's coding scheme. Teams must communicate their list to their respective zone center.

Code "0" (Not treated at a medical facility) is used when the person was not injured or receives nonprofessional treatment such as first-aid, self-treatment, etc. In addition, use this code for persons who "died" at the scene or "died in-route" to a medical facility. Treatment at the scene or in-route to a medical facility by emergency medical personnel is not considered initial treatment for the purposes of this variable. This is true even if the facility has radio communications with their EMTs. If a person arrives at a medical facility and subsequently dies or is declared dead, then use one of the following codes. For example, an occupant arrives with no vital signs, CPR in progress, and a "flat" EKG and is declared "dead on arrival" on the ER report, code the facilities classification from one of the codes below.

Code "1" (Trauma center) is used when the occupant was initially treated at a Level I or Level II Trauma Center as defined by the American College of Surgeons' Committee on Trauma report entitled: "Hospital and pre-hospital resources for optimal care of the injured patient", American College of Surgeons Bulletin, Vol. 71, No. 10, October 1986, pp. 4-2.

The fact that a medical facility calls itself a "Trauma Center" or something of the same nature does not mean that it satisfies the criteria for code "1" (Trauma center). The facility must meet the criteria as noted in the preceding paragraph. Teams should contact their "hospitals" and ask each what they

Variable Name: Type of Medical Facility (for Initial Treatment) [cont'd.]

consider themselves to be (according to criteria referenced above). Teams should also be alert for communication releases (i.e., newspapers, radio, TV, etc.) which concern the trauma capability status of their area emergency rooms.

Code "2" (Hospital) is used for all "hospitals" which do not fall into the definition of a Level I or Level II Trauma Center as defined.

Code "3" (Medical clinic) is used for treatment facilities which provide outpatient medical care with related in-house laboratory facilities (e.g, x- ray). These are usually a group practice in which several physicians work cooperatively. This code also includes school clinics, work place clinics, or similar facilities if they are staffed by a physician while open. If a doctor is not normally present at a clinic while it is open, then the appropriate code is "8" (Other).

Code "4" (Physician's office) is used when the person is initially treated in an office of a professional health care provider which does not qualify for codes "1" (Trauma center), "2" (Hospital), or "3" (Medical clinic).

Code "5" (Treatment later at medical facility) is used when a person's initial treatment by a health care professional (i.e., doctor) took place more than one hour after the accident. In addition, use this code when OA35, Treatment-Mortality, is coded "6" (Treatment later).

Code "8" (Other) is used when a health care provider's facility is used for the initial treatment, and the facility does not qualify for one of the codes "1" (Trauma center), "2" (Hospital), "3" (Medical clinic), or "4" (Physician's office) above.

Code "9" (Unknown) is used when it is unknown what type of initial treatment facility was used or when it is unknown if treatment of any kind was obtained.

Variable Name: Hospital Stay

Element Values:

Range: 00-61, 99

00 Not hospitalized

Code the number of days (up through 60) that the occupant stayed in the hospital

61 61 days or more

99 Unknown

Source: Researcher determined--inputs include interviewee and medical reports.

Remarks:

Official sources (if they exist) take precedence over interview data.

Code "00" (Not hospitalized) is used when the person was not injured or injured but not admitted to the facility (i.e., admission to the facility's emergency room is not "admission" to the facility for the purposes of the hospitalization question). In addition, use this code if fatal at scene, pronounced dead on arrival, or survival does not extend beyond the emergency room.

The basis for the number of days coded is an overnight criterion. Every time a person remains past midnight subsequent to admission, it is one day. However, there are two exceptions. One exception occurs when a person dies on the same day as the admission. In this situation, use code "01". The other exception occurs when a person is admitted in the early morning hours (between midnight and 7:00 a.m.), usually for observation, and is subsequently released later in the same day (usually late morning or early afternoon). Code "01" is used because the person was hospitalized [OA35, Treatment - Mortality, equals "3" (Hospitalized)].

If your information indicates that the person died while in a critical care unit [e.g., intensive (i.e., ICU), coronary (i.e., CCU), etc.], then at least code "01" is used even if the person expires on the same day. In other words, a person is considered admitted if they are still alive when they are transferred to a critical care unit. On the other hand, in the event that the person survives the emergency room but subsequently dies during surgery, then code "00" (Not hospitalized) is used, because a person who goes directly from the emergency room to an operating room is not considered to have been admitted.

If a person is admitted, lives four days in the hospital, and subsequently expires, then use code "04".

This variable reports the number of days this occupant is hospitalized at a primary care facility. Primary care facilities includes medical facilities that receive patients via air transfer (e.g., "lifeline" and "medivac"). However, the number of days spent at secondary care facilities (i.e., rehabilitation or convalescent units, centers, facilities; or nursing homes) are not included in this variable.

Variable Name: Working Days Lost

Element Values:

Range: 00-62, 97, 99

00 No working days lost

Code the number of days (up through 60) that the occupant lost from work due to the accident

61 61 days or more

62 Fatally injured

97 Not working prior to accident

99 Unknown

Source: Primary source is the interviewee; a secondary source is the person's employer.

Remarks:

Report the actual number of "work" days lost due to the accident by an employed person or a full-time college student. Children, adolescents, retirees, or unemployed persons are not included [code "97" (Not working prior to accident)].

Employed is defined to mean that the person was scheduled to work at least four hours on each of the days lost. Each such day is counted as a full day so long as the person was scheduled to work at least four hours on the day lost. Do not accumulate the hours and convert to equivalent full-time days; however, indicate on the form if the person works less than full-time but greater than four hours per day by annotating "part-time" or "PT".

If during the interview a reasonable projection of future days lost can be made, then add those days to those already known to have been lost. If a reasonable projection cannot be made, then code "99" (Unknown).

The days lost need not be due to injury.

Days lost include Saturdays, Sundays, and afternoon and evening shifts if so scheduled. Do not count double shifts or days at time and one-half pay, etc., as more than one day.

Code "62" (Fatally injured) is used if a person is "fatal - ruled disease" or expires within thirty (30) days following the crash. Use this code regardless of whether or not the person missed any working days.

Code "97" (Not working prior to accident) is used when a person is not employed, not a full-time college student, or works less than four hours per day. This code includes all persons (except fatals) who do not qualify to lose working days.

Variable Name: Working Days Lost (cont'd.)

If the reported work days lost includes a fraction, round one-half (1/2) day or greater up to a whole day. Less than one-half day is excluded (rounded down).

If someone loses their job as a result of the accident, then count only the work days lost between the accident and the date of termination, inclusive.

Do not include days lost by persons who were not directly involved in the accident but who lost days because of it (e.g., husband who was not in accident but stayed home to take care of wife who was injured and required assistance).

If an involved person changes their work schedule as a result of an accident (e.g., to take care of someone injured in the accident), then the work time, which was given up as a result of the accident, shall not be considered as lost.

If no interview is obtained, assume that persons over 65 or under 17 are not employed full-time; for these persons code "97" (Not working prior to accident) is used unless the person is fatally injured [codes "1" (Fatal) or "2" (Fatal - ruled disease) for OA35, Treatment - Mortality].

Variable Name: Time to Death

Element Values:

Range: 00 through 24, 31 through 60, 96, 99

00 Not fatal

96 Fatal - ruled disease

99 Unknown

Source: Zone Center determined from police report, hospital/medical records, autopsy report, or other official records for actual time of death for fatally injured occupants.

Remarks:

Code "00" (Not fatal) identifies (from any source) all occupants who are not fatally injured (i.e., death does not occur, or death does not occur within thirty days of the accident). Occupants of hit-and-run vehicles are assumed not killed.

Record the time-of-death of all occupants who die within thirty days of the accident unless their death meets the criteria of code "96" (Fatal - ruled disease).

Code "01" identifies occupants who die within (less than) one and a half hours of the time of the accident.

Codes "02" through "24" identify occupants who die in the period of time between one and a half hours from the time of the accident to twenty-four hours after the accident. Code the time between accident and death to the nearest hour except for code "24" which is used only for the period between twenty-three and a half hours after the accident and twenty-four hours after the accident.

Codes "31" through "60" identify occupants who die in the period of time between greater than twenty-four hours after the accident and thirty days after the accident (24 hours and one minute is coded as "31" while 24 hours is coded as "24"). (NOTE: One day = "31", two days = "32", ..., twenty-nine days = "59", and thirty days = "60".) The number of days is rounded off to the nearest whole day except for code "60" which is used for the period between twenty- nine days and twelve hours and thirty days after the accident.

Code "96" (Fatal - ruled disease) is used in two situations. The first is when the effects of a disease can be deemed as a cause of the accident. Cause means that the on-set of the disease occurred prior to the first harmful event. When determining the time of on-set (relative to the first harmful event), the researcher can use any information source available. The researcher makes his/her determination after weighing all the evidence. (NOTE: The use of all available information sources is restricted to the determination of when the on-set occurred.)

Variable Name: Time to Death (cont'd.)

Code "96" (Fatal - ruled disease) is used additionally when a medical examiner (or other official vested by the state to verify the cause of death) or an official medical report verifies that the death resulted from either (1) a diseased condition, or (2) not from accident-related injuries.

Code "99" (Unknown) is used when the length of time between the time of the accident and the time the person was pronounced dead by a qualifying person (coroner, state medical examiner, etc.) is unknown. Do not code "01" unless the length of time is known to be less than one and one-half hours. Autopsy reports do not always specify time to death; thus, emergency room records must always be sought even when it is known that an autopsy report can be obtained.

The exact time period which applies to each code is shown in the table below.

Code	Time period in hours	Code	Time period in days
01	0 - < 1 1/2	31	> 1 - < 1 1/2
02	1 1/2 - < 2 1/2	32	1 1/2 - < 2 1/2
03	2 1/2 - < 3 1/2	33	2 1/2 - < 3 1/2
04	3 1/2 - < 4 1/2	34	3 1/2 - < 4 1/2
05	4 1/2 - < 5 1/2	35	4 1/2 - < 5 1/2
06	5 1/2 - < 6 1/2	36	5 1/2 - < 6 1/2
07	6 1/2 - < 7 1/2	37	6 1/2 - < 7 1/2
08	7 1/2 - < 8 1/2	38	7 1/2 - < 8 1/2
09	8 1/2 - < 9 1/2	39	8 1/2 - < 9 1/2
10	9 1/2 - < 10 1/2	40	9 1/2 - < 10 1/2
11	10 1/2 - < 11 1/2	41	10 1/2 - < 11 1/2
12	11 1/2 - < 12 1/2	42	11 1/2 - < 12 1/2
13	12 1/2 - < 13 1/2	43	12 1/2 - < 13 1/2
14	13 1/2 - < 14 1/2	44	13 1/2 - < 14 1/2
15	14 1/2 - < 15 1/2	45	14 1/2 - < 15 1/2
16	15 1/2 - < 16 1/2	46	15 1/2 - < 16 1/2
17	16 1/2 - < 17 1/2	47	16 1/2 - < 17 1/2
18	17 1/2 - < 18 1/2	48	17 1/2 - < 18 1/2
19	18 1/2 - < 19 1/2	49	18 1/2 - < 19 1/2
20	19 1/2 - < 20 1/2	50	19 1/2 - < 20 1/2
21	20 1/2 - < 21 1/2	51	20 1/2 - < 21 1/2
22	21 1/2 - < 22 1/2	52	21 1/2 - < 22 1/2
23	22 1/2 - < 23 1/2	53	22 1/2 - < 23 1/2
24	23 1/2 - 24	54	23 1/2 - < 24 1/2
		55	24 1/2 - < 25 1/2
		56	25 1/2 - < 26 1/2
		57	26 1/2 - < 27 1/2
		58	27 1/2 - < 28 1/2
		59	28 1/2 - < 29 1/2
		60	29 1/2 - 30

OCCUPANT ASSESSMENT FORM

OA40
OA41
OA42

Variable Name: 1st Medically Reported Cause of Death
2nd Medically Reported Cause of Death
3rd Medically Reported Cause of Death

Element Values:

- 00 Not fatal or no additional causes
Code the Occupant Injury from line number(s) for the medically reported injury(s) which reportedly contributed to this occupant's death
- 96 Mode of death given but specific injuries are not linked to cause of death. (specify)
- 97 Other result (includes fatal ruled disease) (specify)
- 99 Unknown

Source: Zone Center determined from official records

Remarks:

This variable records the injury(s) which was/were determined by the medical professional completing the report, or by trained Zone Center injury coders using official medical records, to be the cause of death. A "cause of death" statement may appear at the beginning or end of an official medical record or it may also appear in a "diagnosis" section or body of a medical record. Like the coding rule for injuries, probable or possible causes of death are not coded. If the occupant was not fatally injured, then these variables must all be coded "00" (Not fatal or no additional causes). If the occupant was killed and no official medical data was obtained, or the data obtained inadequately describes injuries which could have an affect on the occupant's death, then code OA40 as "99" (Unknown) and OA41 and OA42 as "00" (Not fatal or no additional causes). If the occupant was killed and acquired medical data do not provide a specific official medically reported cause of death, then the Zone Center injury coder will determine if injury data are sufficient to code OA40, and/or OA41, and/or OA42 with an appropriate coded injury row(s).

Code the row number(s) of the injury(s), from the Occupant Injury Form, which caused the death. If only one injury is reported as, or determined to be, the cause of death, code that injury row's number for OA40 and code OA41 and OA42 as "00" (Not fatal or no additional causes). The same logic applies if two injuries are reported.

Code up to three specific injuries detailed in a medically reported "cause of death" statement.

If the "cause of death" statement consist of nonspecific indefinite injuries (e.g., multiple injuries of head, trunk, etc., blunt force injuries of the chest etc., massive injury, and multiple traumatic injuries) and injuries are detailed in the official medical records such that the cause of death can be logically determined, then choose up to three specific injuries using the following guidelines:

- Choose the specific injuries which had the greatest affect on the occupant's death.

OCCUPANT ASSESSMENT FORM

OA40
OA41
OA42
(2)

Variable Name: 1st Medically Reported Cause of Death
2nd Medically Reported Cause of Death
3rd Medically Reported Cause of Death

- Proceed by first considering specific AIS-6 injuries, followed by AIS-5, then AIS-4, then AIS-3.

Note: AIS levels do not automatically identify an injury as the selected cause of death. For example, if the occupant has an AIS-6 burn injury but the medical says that the occupant was dead prior to the occupant's vehicle catching on fire, then burn was not the cause of death.

- Within each AIS level, determine the contribution the specific injury had on the occupant's chance of survival.

Code "96" (Mode of death given but specific injuries are not linked to cause of death) is used when it is determined that the occupant qualifies for code "1" (Fatal) in variable OA35, Treatment - Mortality, but specific injuries are not medically reported for the cause of death. The official medical report may give a mode of death such as (1) acute pulmonary embolis, (2) respiratory failure, (3) cardiac arrest, or (4) asphyxiation. This code is also used when the cause of death is reported from complications or consequences of injuries.

Code "97" (Other result) is used when it is determined that the occupant qualifies for code "2" (Fatal-ruled disease) in variable OA35, Treatment - Mortality.

If no cause of death is directly from an injury and there is no officially reported mode of death, then encode OA40 as "97" (Other result) and OA41 and OA42 as "00" (Not fatal or no additional causes).

Variable Name: Number of Recorded Injuries for This Occupant

Element Values:

Range: 00-96, 97, 99

00 No recorded injuries

Code the actual number of injuries recorded for this occupant

97 Injured, details unknown

99 Unknown if injured

Source: Zone Center determined--inputs include official medical records and interviewee data from the PSU.

Remarks:

The Zone Center will record this occupant's total number of coded injury rows that were recorded on the Occupant Injury Form.

Code "00" (No recorded injuries) is used when the occupant is uninjured.

Code "97" (Injured, details unknown) is used when the occupant is injured but the details are unknown. This means that the source(s) of injury information does not have sufficient injury detail to allow for the coding of injury data on the Occupant Injury Form.

Code "99" (Unknown if injured) is used when it is unknown if the occupant was injured.

If "00", "97", or "99" is coded, then the Occupant Injury Form is not used.

Variable Name: Automatic (Passive) Belt System Availability/Function

Element Values:

- 0 Not equipped/not available
- 1 2 point automatic belts
- 2 3 point automatic belts
- 3 Automatic belts - type unknown

Non-functional

- 4 Automatic belts destroyed or rendered inoperative
- 9 Unknown

Source: Researcher determined--Primary source is the vehicle inspection; secondary sources include medical records, the interview, and police report. NOTE: The use of the police report is limited. If there is no vehicle inspection and the only secondary source is the PAR, then the PAR "narrative" must clearly state that the automatic belt system was used or available. An indication of usage or availability in a "restraint system" block is, by itself, not usable.

Remarks:

Some belt restraint systems are a combination of manual (active) and automatic (passive) occupant protection devices. For this variable, consider only the automatic portion of the system. Select the automatic belt system which was available at the time of the accident for this occupant.

Automatic belts are designed to restrain an occupant and allow an occupant egress (the act of going from an enclosed place) without the requirement of manually activating the belt. Some systems use only a torso belt [code "1" (2 point automatic belts)], while others are designed with a lap and torso belt [code "2" (3 point automatic belts)]. A clue for proper system identification involves the egress issue. If you are sitting in the occupant's position and all belts are attached and you open the door, then determine if you have to detach any belt in order to exit the vehicle. Belts which do not require detaching are automatic belts. Note! The ease of egress is not considered because many automatic belt systems may appear cumbersome.

Availability is assessed based on the occupant's seating position. Select the automatic belt system which was available for use, if so desired, by the occupant relative to the occupant's seating position in the vehicle. Availability is also determined by presence, functional status, and use of the automatic belt system. Any occupant who is using a belt restraint system, or portion thereof, must by default have that system available to them. The correctness and/or appropriateness of the use is considered in OA47, Proper Use of Automatic (Passive) Belt System.

Certain occupant seating situations involve abnormal posture. Examples are:

Variable Name: Automatic (Passive) Belt System Availability/Function
[cont'd.]

- occupant on the floor [i.e., in front of a designated seat (e.g., sitting, standing, etc.)];
- occupant lying across one or more seating positions;
- occupant sitting side-by-side of another occupant in the same seating position, since only one can be assigned to the seating position--see OA10, Occupant's Seat Position;
- occupant standing or kneeling in a designated seating position); and
- occupant in or on the lap of another occupant (e.g., sitting, standing, kneeling, etc.).

Occupant on the floor: For this situation use code "0" (Not equipped/not available). These occupants are not in a designated seating position and do not have an automatic belt available.

Occupant lying across one or more seating positions: For an occupant lying across multiple seating positions, OA10 (Occupant's Seat Position) must equal code "14", "24", "34", or "44". These occupants can be using an automatic belt: If they are, then code availability based upon the belt used. Do not confuse this situation with occupants lying against a door or side panel or against another occupant. Persons in this latter category are still considered to be occupying a single occupant seating position.

Occupant sitting side-by-side of another occupant in the same seating position: These occupants (i.e., OA10 equal "14", "24", "34", "44") do not have an automatic belt available unless such a person is sharing the use of an automatic belt (i.e., two or more persons sitting side-by-side using the same automatic belt should have the same restraint available for each occupant).

Occupant standing or kneeling in a designated seating position: These occupants have automatic belts available to them for use. Availability is assessed for these occupants based on the occupant's assigned seating position.

Occupant in or on the lap of another occupant: These occupants do not have an automatic belt available unless such a person is sharing the use of an automatic belt (i.e., two or more persons sitting in front of one another or on top of one another using the same automatic belt).

Code "0" (Not equipped/not available) indicates: (1) that at the time of the accident the designated seating position that the occupant was in, was not equipped with a manufacture installed or post manufacture installed automatic belt (2 point or 3 point); (2) the occupant was not in a designated seat position (e.g., on the floor); (3) the occupant was not the person assigned the designated seat position and was not using an automatic belt (e.g., sitting side-by-side); or (4) the seat position that the occupant was in was equipped only with a manual (active) belt system.

Variable Name: Automatic (Passive) Belt System Availability/Function
[cont'd.]

Code "1" (2 point automatic belts) is used when a torso belt is anchored along the inboard side of the front seat and anchored either at the upper window frame of the door surface (adjacent to the upper B-pillar) or attached to a motorized track located along the upper A-pillar, roof side rail, and upper B-pillar. A two point automatic belt system requires the presence of either a manual lap belt or a knee bolster.

Code "2" (3 point automatic belts) is used for an automatic belt system consisting of a lap and torso belt. This system uses a common anchor for both belts located on the inboard side of the front seat and two anchors along the door surface (e.g., commonly used in late model General Motors cars). This system can be detected by sitting in the occupant's position with the latch plate/buckle attached and opening the door. If the belt travels with the door and allows egress without detaching the belt, then use this code--the system is automatic.

Code "3" (Automatic belts - type unknown) is used when (1) no vehicle inspection occurs and the occupant's seating position is known to have automatic belts (e.g., from the VIN--GV08) but the type (2 point versus 3 point) is unknown, or (2) a vehicle inspection occurs and the occupant's seating position is known to have automatic belts but the researcher is not able to determine from the vehicle inspection or any secondary sources what type of automatic belts are available.

If the type of automatic belt system is determinable, then the system's mechanization can also be determined because most manufacturers use the same type of system for a given vehicular model. In addition, if the type of automatic belt system is undeterminable, then it is assumed that the system is functional (i.e., code "3" takes precedence over code "4" below).

Code "4" (Automatic belts destroyed or rendered inoperative) is used when the automatic belt, initially installed at this occupant's seating position, was subsequently removed or destroyed (e.g., unbolted, cutout, etc.) or in any way rendered inoperative. In addition, use this code for belts which are extremely deteriorated from aging. Do not use this code for motorized belt tracks which are mechanically or electrically inoperative.

Belts which are knotted, buckled at the rear of the seat (bench or bucket), etc., are available if they were otherwise operative.

Code "9" (Unknown) is used for front outboard seat occupants of uninspected passenger vehicles (GV07="01"- "09", "12") where it cannot be determined from any secondary source whether or not this occupant's seating position was equipped with an automatic belt system.

Variable Name: Automatic (Passive) Belt System Use

Element Values:

- 0 Not equipped/not available/destroyed or rendered inoperative
- 1 Automatic belt in use
- 2 Automatic belt not in use (manually disconnected, motorized track inoperative) (specify)
- 3 Automatic belt use unknown
- 9 Unknown

Source: Researcher determined--Primary source is the vehicle inspection; secondary sources include the interview and medical records. NOTE: Do not use the police accident report as a source for coding this variable.

Remarks:

Code "0" (Not equipped/not available/destroyed or rendered inoperative) is used when OA44, Automatic (Passive) Belt System Availability/Function, is coded "0" (Not equipped/not available) or OA44 is coded "4" (Automatic belts destroyed or rendered inoperative).

Code "1" (Automatic belt in use) is used when OA44, Automatic (Passive) Belt System Availability/Function, equals "1" (2 point automatic belts), "2" (3 point automatic belts), or "3" (Automatic belts - type unknown) and this occupant was using the automatic belt. The correctness of the use is not assessed on this variable [see variable OA47, Proper Use of Automatic (Passive) Belt System].

Code "2" [Automatic belt not in use (manually disconnected, motorized track inoperative)] is used when the automatic belt's latch plate/buckle was detached at the time of the accident. For example, this code is used to capture disconnected 3-point, door mounted automatic belts (i.e., 1987 and newer General Motors vehicles) which can be used similar to an active lap and shoulder belt system.

This code is also used for motorized tracks which were not in the restrained position at the time of the accident. The motorized track may be inoperative because of fuse removal, electric motor failure, or track failure when the malfunction prevents the automatic belt system from moving along its track into the restrained position.

Note! This variable does not assess how this occupant uses the automatic belt when entering or exiting the seating position. For example, this occupant may routinely manually detach/attach the latch plate/buckle (i.e., uses the automatic belt system as if it were a manual belt system). This variable assumes that the nonmotorized automatic belt is available and functioning and assesses whether or not the latch plate/buckle was attached at the time of the accident. If the latch plate/buckle was attached at the time of the accident, then use code "1" (Automatic belt in use). On the other hand, if it was detached, then use code "2" [Automatic belt not in use (manually disconnected, motorized track inoperative)].

Variable Name: Automatic (Passive) Belt System Use [cont'd.]

For motorized belts, this variable assumes that the motorized belt system is locked in the restrained position with the belt attached at the time of the accident. If the motorized belt system was locked in the restrained position and the belt was attached at the time of the accident, then use code "1" (Automatic belt in use). If the motorized belt system was not locked in the restrained position or the belt was detached, then use code "2" [Automatic belt not in use (manually disconnected, motorized track inoperative)].

Code "3" (Automatic belt use unknown) is used when OA44, Automatic (Passive) Belt System Availability/Function, equals "1" (2 point automatic belts), "2" (3 point automatic belts), or "3" (Automatic belts - type unknown) and the researcher is unable to determine if the automatic belt was in use.

Code "9" (Unknown) is used when it cannot be determined from any source whether or not this occupant's seating position was equipped with an automatic belt system [i.e., OA44 equals "9" (Unknown)]

Variable Name: Automatic (Passive) Belt System Type

Element Values:

- 0 Not equipped/not available
- 1 Non-motorized system
- 2 Motorized system
- 9 Unknown

Source: Researcher determined--Primary source is the vehicle inspection; secondary sources include the interview, police report, and medical records. NOTE: The use of the police report is limited. If there is no vehicle inspection and the only secondary source is the PAR, then the PAR "narrative" must clearly state what type of automatic belt system was used.

Remarks:

Code "0" (Not equipped/not available) is used when OA44, Automatic (Passive) Belt System Availability/Function, is coded "0" (Not equipped/not available). If the automatic belt system was not functioning [i.e., OA44 equals "4" (Automatic belts destroyed or rendered inoperative)], then indicate the mechanization of the system by using code "1" (Non-motorized system) or "2" (Motorized system) below.

Code "1" (Non-motorized system) is used when the automatic belt system available to this occupant does not require a motor for operation.

Code "2" (Motorized system) is used when the automatic belt system available to this occupant requires a motor for operation.

Vehicles manufactured with automatic (passive) belts can be verified through their Vehicle Identification Number (VIN; i.e., GV08). To assist in this verification a table appears after variable OA48 of the Occupant Assessment Form and is entitled: Vehicles Manufactured With Automatic (Passive) Restraint Systems. This table is a comprehensive list of vehicular passive restraint type by specific vehicle year, make, model, and VIN character identification.

Code "9" (Unknown) is used when it cannot be determined from any source whether or not this occupant's seating position was equipped with an automatic belt system [i.e., OA44 equals "9" (Unknown)]. In addition, use this code when it is known that an automatic belt is available but the type (non-motorized or motorized) cannot be determined.

Variable Name: Proper Use of Automatic (Passive) Belt System

Element Values:

- 0 Not equipped/not available/not used
- 1 Automatic belt used properly
- 2 Automatic belt used properly with child safety seat

Automatic Belt Used Improperly

- 3 Automatic shoulder belt worn under arm
- 4 Automatic shoulder belt worn behind back
- 5 Automatic belt worn around more than one person
- 6 Lap portion of automatic belt worn on abdomen
- 7 Automatic lap and shoulder belt or automatic shoulder belt used improperly with child safety seat (specify)
- 8 Other improper use of automatic belt system (specify)
- 9 Unknown

Source: Researcher determined--Primary source is the vehicle inspection; secondary sources include the interview, police report, and medical records. NOTE: The use of the police report is limited. If there is no vehicle inspection and the only secondary source is the PAR, then the PAR "narrative" must clearly state that the automatic belt system was used properly or improperly.

Remarks:

This variable must be assessed by the researcher using all available data. An improperly used automatic belt can cause a large variety of injuries by itself or, depending upon the way it is improperly used, it can allow other injuries to occur which might not have happened if the restraint was properly used. In severe cases an improperly worn belt can be the cause of death. An improperly used belt can also lead to belt failure which is addressed in variable OA48, Automatic (Passive) Belt Failure Modes During Accident. If there is an improperly used belt and/or a belt system failure, they should be noted on the Case Summary Form.

Code "0" (Not equipped/not available/not used) is used when OA44, Automatic (Passive) Belt System Availability/Function, is coded "0" (Not equipped/not available), OA44 is coded "4" (Automatic belts destroyed or rendered inoperative), or OA45, Automatic (Passive) Belt System Use, is coded "2" [Automatic belt not in use (manually disconnected, motorized track inoperative)]. In other words, in order to assess the properness of use, the automatic belt must be available, functional, and in use [i.e., OA45 equals "1" (Automatic belt in use)].

Code "2" (Automatic belt used properly with child safety seat) is to be indicated only when the child safety seat is installed so as to comply with the manufacturer's directions (i.e., seat must be integrated with the vehicle via the automatic seat belts) and is occupied by a child.

Code "4" (Automatic shoulder belt worn behind back) is used:

- when an occupant has a three point automatic belt but is only

Variable Name: Proper Use of Automatic (Passive) Belt System [cont'd.]

"encompassed" by the lap portion (i.e., having the automatic torso belt behind the occupant's back), or

- when an occupant has a two point automatic belt and is not "encompassed" by the torso portion (i.e., the automatic torso belt is attached and is behind the occupant's back).

Code "5" (Automatic belt worn around more than one person) is used when more than one occupant is sharing the same automatic belt. Occupants may be sitting side-by-side, in front of one another, or on top of one another. If the occupants are using a three point automatic belt such that the torso portion is worn behind one or more of the occupants backs while the lap portion encompasses their hips, then use this code.

Code "6" (Lap portion of automatic belt worn on abdomen) is used when the lap belt portion of a three point automatic belt system is worn above the occupant's pelvic bones.

Code "7" (Automatic lap and shoulder belt or automatic shoulder belt used improperly with child safety seat) is used when a child safety seat is not installed according to the manufacturer's directions and is occupied by a child. Specify how the automatic belt was used improperly.

Code "8" (Other improper use of automatic belt system) is used to describe any improper use of the automatic belt system which is not listed above. This includes when an automatic shoulder belt is worn on the outside of an occupant's arm as opposed to under the arm or on top of the shoulder.

Code "9" (Unknown) is used:

- when it cannot be determined from any source whether or not this occupant's seating position was equipped with an automatic belt system [i.e., OA44 equals "9" (Unknown)],
- when it is known that an automatic belt is available but the type cannot be determined--two point versus three point automatic belt [i.e., OA44 equals "3" (Automatic belts - type unknown),
- when it is not known whether the automatic belts used were used properly or improperly (i.e., no interview was conducted and no other information is present that identifies proper or improper use of the automatic belts), and
- when a child safety seat is occupied by a child, but it is unknown if the seat was installed (using either the manufacturer's or the vehicle's automatic belts) according to the manufacturer's directions.

Variable Name: Automatic (Passive) Belt Failure Modes During Accident

Element Values:

- 0 Not equipped/not available/not in use
- 1 No automatic belt failure(s)
- 2 Torn webbing (stretched webbing not included)
- 3 Broken buckle or latchplate
- 4 Upper anchorage separated
- 5 Other anchorage separated (specify)
- 6 Broken retractor
- 7 Combination of above (specify)
- 8 Other automatic belt failure (specify)
- 9 Unknown

Source: Researcher determined--Primary source is the vehicle inspection; additional input may include the interview and police report if a vehicle inspection is obtained.

Remarks:

If any component of the automatic belt system fails during the impact, the failure is encoded in this variable. The failure is also recorded on the Case Summary Form and documented with photographs and diagrams as needed. Automatic belt system failures, unlike manual belt system failures, are not limited to those that resulted from occupant loading.

Code "0" (Not equipped/not available/not in use) is used when OA47, Proper Use of Automatic (Passive) Belt System, equals "0" (Not equipped/not available/not used). In other words, in order to assess the failure modes, the automatic belt must be available, functional, and in use [i.e., OA45 equals "1" (Automatic belt in use)].

Code "1" [No automatic belt failure(s)] is used when there is no physical evidence from the vehicle inspection to indicate or support that a failure occurred.

Codes "2" through "6" are used to indicate the specific failure of the restraint system. Select the code which corresponds to the appropriate automatic belt failure mode that describes the component of the restraint system which failed (i.e., torn webbing, broken buckle or latchplate, anchorage separation, broken retractor). If a failure occurs, a complete and documented description of the failed component and the way it failed must accompany the case. Include photographs of the failed component(s).

Code "7" (Combination of above) is used when any combination of codes "2"-"6" above occurs and describes multiple automatic belt failure modes. Automatic belt failures which are not described in codes "2"-"6" are reported in code "8" below. Automatic belt failures listed in codes "2"-"6" take priority over code "8".

Variable Name: Automatic (Passive) Belt Failure Modes During Accident
[cont'd.]

Code "8" (Other automatic belt failure) is used when the only automatic belt failure(s) which occur are not described in codes "2"- "6" above.

Code "9" (unknown) is used:

- when there is no vehicle inspection,
- when it cannot be determined from any source whether or not this occupant's seating position was equipped with an automatic belt system [i.e., OA45, Automatic (Passive) Belt System Use, equals "9" (Unknown)], or
- when it is known that an automatic belt is available and functional but it cannot be determined whether or not the automatic belt was in use [i.e., OA45 equals "3" (Automatic belt use unknown)].

OCCUPANT ASSESSMENT FORM

Vehicles Manufactured With Automatic (Passive) Restraint Systems

Vehicle Make GV05	Vehicle Model GV06	Vehicle Model Year GV04	NASS Make/Mode Code: GV05-GV06	Air Bag		Passive Belt		VIN Character Identifier			
				Driver Only	Driver & Passenger	Motorized	Non-Motorized	Model		Restraint	
								Place	Code	Place	Code
Acura (Honda)	Legend LS	1987 to 1989	54-032	Standard				4-6	KA3,4	8	6
	Integra	1990	54-031	Standard			Yes	4-6	DA9,DB1	8	4-6
		Legend (all)	1990					54-032	4-6	KA3,4	8
	Integra	1991	54-031	Standard			Yes	4-6	DA9,DB1	8	4-5,7,9
		Legend	1991					54-032	4-6	KA7,8	8
	NSX	1991	54-033	Standard				4-6	NA1	8	5,6
	Integra	1992 to 1993	54-031				Yes	4-6	DA9,DB1, DB2	8	4-8
	Integra	1994	54-031		Standard		Yes	4-6	DA9,DB1, DB2	8	???
	Legend : L,LS	1992	54-032	Standard				4-6	KA7,8	8	3
		1992	54-032					4-6	KA7,8	8	5-7
	NSX	1993 to 1994	54-032	Standard				4-6	KA7,8	8	3,5-7
		1992	54-033					4-6	NA1	8	5,6
Vigor : LS : GS	1993 to 1994	54-033	Standard				4-6	NA1	8	5,6	
	1992	54-034					4-6	CC2	8	4,5	
	1993	54-034					4-6	CC2	8	4	
	1993	54-034					4-6	CC2	8	5	
	1994	54-034	Standard				4-6	CC2	8	5	
Alfa Romeo	Spider 164	1991 to 1993	31-031	Standard				4-5	BB,BC	?	?
		1991 to 1993	31-035	Standard				4-5	EA	?	?
Aston Martin	Virage	1993	69-031		Standard			5-6	AM	7	2
Audi	80	1990	32-036	Standard				4,7-8	E,F..8A	6	1
	90	1990	32-036	Standard				4,7-8	G,H..8A	6	1
	100	1990	32-032	Standard				4,7-8	B,C..44	6	1
	200	1990	32-037	Standard				4,7-8	F,G,H..44	6	1
	Coupe Quattro	1990	32-039	Standard				4,7-8	?..8B	6	1
	V8	1990	32-038	Standard				4,7-8	K..44	6	1
	80	1991 to 1992	32-036	Standard				4,7-8	E,F..8A	6	2
	90	1991 to 1992	32-036	Standard				4,7-8	G,H..8A	6	2
	100	1991 to 1992	32-032	Standard				4,7-8	B,C..44	6	2
	200	1991 to 1992	32-037	Standard				4,7-8	F,G,H..44	6	2
	Coupe Quattro	1991 to 1992	32-039	Standard				4,7-8	G..8B	6	2
	V8	1991 to 1992	32-038	Standard				4,7-8	K..4C	6	2
	90	1992 to 1993	32-036	Standard				4,7-8	B,D,E..8C	6	5
		1994	32-036		Standard			4,7-8	B,D,E..8C	6	8
	100	1992 to 1994	32-032		Standard			4,7-8	A,B,D-F	6	8
		1994	32-041		Standard			4,7-8	???	6	8
	S4 Quattro	1992 to 1994	32-039		Standard			4,7-8	H..4C	6	8
	V8 Quattro	1992 to 1994	32-038		Standard			4,7-8	B..4C	6	8
Bentley (Rolls Royce)	All	1988 to 1989	69-042				??Yes??	2-3	CB	8	B
	All	1990 to 1993	69-042	Standard				2-3	CB	8	D
	All	1994	69-042		Standard			2-3	CB	8	???
BMW	735i	1987	34-037	Option				4-5	FH	8	1
	635CSi	1988 to 1989	34-036	Standard				4-5	EC	8	1
	735i	1988 to 1989	34-037	Standard				4-5	GB,GC	8	1
	318i	1991 to 1993	34-034	Standard				4-5	AF,AJ,BA	8	1
	1994	34-034		Standard				4-5	AF,AJ,BA	8	???

10th Character = Year: A=1980, B=1981, C=1982, D=1983, E=1984, F=1985, G=1986, H=1987, J=1988, K=1989, L=1990, M=1991, N=1992, P=1993, R=1994, S=1995, T=1996, V=1997, W=1998, X=1999

OCCUPANT ASSESSMENT FORM

Vehicles Manufactured With Automatic (Passive) Restraint Systems (Cont'd.)

Vehicle Make GV05	Vehicle Model GV06	Vehicle Model Year GV04	NASS Make/Model Code: GV05-GV06	Air Bag		Passive Belt		VIN Character Identifier			
				Driver Only	Driver & Passenger	Motorized	Non-Motorized	Model		Restraint	
								Place	Code	Place	Code
BMW (Cont'd)	325i	1990 to 1994	34-034	Standard				4-5	AA,AB,AD,AE,BB	8	1
	M3	1990 to 1993	34-034	Standard				4-5	AK	8	1
	525i	1990 to 1993	34-035	Standard				4-5	HC	8	1
		1994	34-035		Standard			4-5	HC	8	???
	530i	1994	34-035		Standard			4-5	???	8	???
	535i	1990 to 1993	34-035	Standard				4-5	HD	8	1
	540i	1994	34-035		Standard			4-5	???	8	???
	M5	1992 to 1993	34-035	Standard				4-5	HO	8	1
	735i	1990 to 1992	34-037	Standard				4-5	GB,GC	8	1
	740i	1993 to 1994	34-037		Standard			4-5	GB,GC	8	1
	750i	1990 to 1992	34-037	Standard				4-7	GC83	8	1
		1993 to 1994	34-037		Standard			4-7	GC83	8	1
		1991 to 1992	34-038	Standard				4-5	EG	8	1
	1993 to 1993	34-038		Standard			4-5	EG	8	1	
Buick	LeSabre	1974 to 1975	18-002		Option			2	N,P		
		1976	18-002		Option			2	P		
	Electra	1974	18-003		Option			2	T,V,X		
		1975 to 1976	18-003		Option			2	V,X		
	Riviera	1974	18-005		Option			2	Y		
		1975 to 1976	18-005		Option			2	Z		
	Century SW	1990 to 1992	18-007				Yes	4-5	AH,AL	7	4
	Century	1992	18-007				Yes	4-5	AG	7	4
		1993	18-007	Option			Yes	4-5	AG,H,L	7	3,4
	Special	1994	18-007	Standard				4-5	??	7	3
	Electra	1990	18-003				Yes	4-5	CF,CX	7	4
	LeSabre	1990 to 1991	18-002				Yes	4-5	BR,HP,HR	7	4
		1992 to 1993	18-002	Standard				4-5	HP,HR	7	3
		1994	18-002		Standard			4-5	HP,HR	7	2
	Park Avenue	1991 to 1993	18-003	Standard				4-5	CJ,CW	7	3
		1994	18-003		Standard			4-5	CJ,CW	7	2
	Reatta	1990 to 1991	18-021	Standard				4-5	EC	7	3
	Regal	1990 to 1991	18-020				Yes	4-5	WB,WD	7	4
		1992 to 1993	18-020				Yes	4-5	WB,D,F	7	4
	Custom	1994	18-020		Standard			4-5	WB	7	3
	Riviera	1990 to 1993	18-005	Standard				4-5	EZ	7	3
	Roadmaster	1992 to 1993	18-004	Standard				4-5	BN,BR,BT	7	3
		1994	18-004		Standard			4-5	BN,BR,BT	7	2
Skyhawk	1991	18-012				Yes	4-5	JE,JS	7	4	
SkyLark	1990 to 1991	18-018				Yes	4-5	NC,ND,NJ,NM,NV	7	4	
	1992 to 1993	18-018				Yes	4-5	NJ,NM	7	4	
	1994	18-018	Standard				4-5	NJ	7	3	
Cadillac	DeVille	1974 to 1976	19-003		Option			2	D		
	Eldorado	1974 to 1976	19-005		Option			2	L		
	Allante	1990 to 1993	19-009	Standard				4-5	VR,VS	7	3
	DeVille--2 dr	1990 to 1993	19-003	Standard				4-5	CD	7	3
	Eldorado	1990 to 1992	19-005	Standard				4-5	EL	7	3
		1993 to 1994	19-005		Standard			4-5	EL	7	2
	DeV Fleetwood--4 dr/Sixty	1990	19-003	Standard				4-5	CB,CS	7	3
		1991 to 1992	19-003	Standard				4-5	CB,CG	7	3
DeVille--4 dr/Sixty Touring	1993	19-003	Standard				4-5	CB,CT	7	3	
	1994	19-003		Standard			4-5	CB,CT	7	2	

10th Character = Year: A=1980, B=1981, C=1982, D=1983, E=1984, F=1985, G=1986, H=1987, J=1988, K=1989, L=1990, M=1991, N=1992, P=1993, R=1994, S=1995, T=1996, V=1997, W=1998, X=1999

OCCUPANT ASSESSMENT FORM

Vehicles Manufactured With Automatic (Passive) Restraint Systems (Cont'd.)

Vehicle Make GV05	Vehicle Model GV06	Vehicle Model Year GV04	NASS Make/Model Code: GV05-GV06	Air Bag		Passive Belt		VIN Character Identifier			
				Driver Only	Driver & Passenger	Motorized	Non-Motorized	Model		Restraint	
								Place	Code	Place	Code
Cadillac (Cont'd)	DeV Fleetwood Brougham-RWD	1990 to 1992	19-003				Yes	4-5	DW	7	4
		1993 to 1994	19-003		Standard			4-5	DW	7	2
	Seville	1990 to 1992	19-014	Standard				4-5	KS,KY	7	2
		1993 to 1994	19-014		Standard			4-5	KS,KY	7	2
Chevrolet	Impala	1973	20-002		Option			2	L		
	Astro: 4x2	1994	20-441	Standard				3,5-7	N.M15	N/A	N/A
	4x4	1994	20-441	Standard				3,5-7	N.L15	N/A	N/A
	Beretta	1990	20-019					4-5	LV,LW,LZ	7	4
		1991 to 1993	20-019	Standard				4-5	LV,LW,LZ	7	2
	Camaro	1990 to 1993	20-009	Standard				4-5	FP	7	2
		1994	20-009		Standard			4-5	FP	7	2
	Caprice	1990	20-002				Yes	4-5	BL,BN,BU	7	4
		1991 to 1993	20-002	Standard				4-5	BL,BN	7	2
		1994	20-002		Standard			4-5	BL,BN	7	2
	Cavalier	1990 to 1994	20-016				Yes	4-5	JC,JF	7	4
	Celebrity	1990	20-017				Yes	4-5	AW	7	4
	Corsica	1990	20-019				Yes	4-5	LT,LZ	7	4
		1991 to 1993	20-019	Standard				4-5	LT	7	2
	Corvette	1990 to 1993	20-004	Standard				4-5	YY,YZ	7	2
		1994	20-004		Standard			4-5	YY,YZ	7	2
	Geo Metro Hthbk	1990 to 1993	20-034				Yes	4-5	MR,MS	7	4
	Conv	1990 to 1993	20-034	Standard				4-5	MR	7	2
	Geo Prizm	1990 to 1992	20-032			Yes		4-5	SK,SL	7	4
		1993	20-032	Standard				4-5	SK	7	2
	,GSi	1994	20-032		Standard			4-5	SK	7	2
	Geo Sprint	1990 to 1992	20-033			Yes		4-5	MT	7	4
Geo Storm	1990 to 1993	20-035	Standard				4-5	RF,RT	7	2	
Lumina	1990	20-020				Yes	4-5	WL,WL	7	4	
	1991 to 1994	20-020				Yes	4-5	WL,WL,WP	7	4	
Lumina APV	1994	20-442	Standard				3,5,7	N.U06	N/A	N/A	
Van, G-series	1994	20-461	Standard				3,5	N.G	N/A	N/A	
Chrysler	New Yorker-RWD										
	5th Avenue	1988	06-010	Option*				5	F	4	Y
	Lebaron	1988	06-017	Option*				5	J	4	(,Y
	GTS	1988	06-017	Option*				5	H	4	(,Y
	New Yorker-RWD										
	5th Avenue	1989	06-010	Standard				5	M	4	(
	Lebaron	1989	06-017	Standard				5	J	4	(,Y
	GTS	1989	06-017	Standard				5	H	4	(,Y
	Concorde	1993 to 1994	06-041		Standard			5	L	4	E
	Lebaron GTS,C	1990 to 1992	06-017	Standard				5	J	4	(,Y
	Lebaron	1990 to 1991	06-016	Standard				5	A	4	(,Y
		1992 to 1993	06-016	Standard				5	A,U	4	(,Y
	, 2-dr	1994	06-016		Standard			5	U	4	E
	New Yorker-FWD										
	Imperial	1990 to 1991	06-014	Standard				5	Y	4	(
	1992 to 1993	06-014	Standard				5	V	4	(
New Yorker-FWD											
5th Avenue	1990 to 1991	06-010	Standard				5	Y	4	(
	1992 to 1993	06-010	Standard				5	V	4	(
New Yorker-FWD											
Salon, Landau	1990 to 1993	06-014	Standard				5	C	4	(

* Air bag became standard equipment in mid-year.

10th Character = Year: A=1980, B=1981, C=1982, D=1983, E=1984, F=1985, G=1986, H=1987, J=1988, K=1989, L=1990, M=1991, N=1992, P=1993, R=1994, S=1995, T=1996, V=1997, W=1998, X=1999

OCCUPANT ASSESSMENT FORM

Vehicles Manufactured With Automatic (Passive) Restraint Systems (Cont'd.)

Vehicle Make	Vehicle Model	Vehicle Model Year	NASS Make/Model Code: GV05-GV06	Air Bag		Passive Belt		VIN Character Identifier				
				Driver Only	Driver & Passenger	Motorized	Non-Motorized	Model		Restraint		
								Place	Code	Place	Code	
Chrysler (Cont'd)	New Yorker-LHS TC	1994	06-042					5	???	4	E	
		1990	06-031	Standard	Standard			6	1	7	X	
		1991	06-031	Standard				6	1	7	2	
	Town & Country	4x2	1992 to 1993	06-441	Standard				5-6	H5	N/A	N/A
			1994	06-441	Standard	Standard			5-6	H5	N/A	N/A
		4x4	1992 to 1993	06-441	Standard	Standard			5-6	K5	N/A	N/A
		1994	06-441	Standard	Standard			5-6	K5	N/A	N/A	
Daihatsu	Charade-hatchbk -sedan	1988 to 1989	60-031			Yes		4-5	FG,JG	7	2	
		1990 to 1992	60-031			Yes		4-5	FG,JG	7	1,2	
		1990 to 1992	60-031			Yes	Yes	4-5	EG,HG	7	1,2	
Dodge	Diplomat Daytona	1988	07-007	Option*				5	G	4	X,Y	
		1988	07-015	Option*				5	A	4	X,Y	
	Diplomat Daytona	1989	07-007	Standard					5	M	4	X,Y
		1989	07-015	Standard					5	G	4	X,Y
	Caravan:	4x2	1992 to 1993	07-442	Standard				5-6	H2,H4,4,5	N/A	N/A
			1994	07-442	Standard	Standard			5-6	H2,H4,4,5	N/A	N/A
	4x4	1992 to 1993	07-442	Standard					5-6	K4,5	N/A	N/A
		1994	07-442	Standard	Standard				5-6	K4,5	N/A	N/A
	Colt Hatchback 2,4 dr	Vista SW	1989 to 1992	09-034			Yes		5	U	4	C
			1993	09-034			Yes		5	A	4	C
	Daytona	Dynasty Intrepid Monaco Neon Omni Shadow Spirit Stealth	1991	09-441				Yes	5	G	4	C
			1992 to 1993	09-441				Yes	5	V,W,B,C	4	C
	Daytona	Dynasty Intrepid Monaco Neon Omni Shadow Spirit Stealth	1990 to 1991	07-015	Standard				5	G	4	X,Y
			1992 to 1993	07-015	Standard				5	W	4	X
	Daytona	Dynasty Intrepid Monaco Neon Omni Shadow Spirit Stealth	1990 to 1993	07-018	Standard				5	C,N	4	X,Y
			1993 to 1994	07-041	Standard	Standard			5	D	4	E
	Daytona	Dynasty Intrepid Monaco Neon Omni Shadow Spirit Stealth	1990 to 1992	07-040			Yes		5	B	4	C
			1995	07-020					5	???	4	E
	Daytona	Dynasty Intrepid Monaco Neon Omni Shadow Spirit Stealth	1990	07-008	Standard	Standard			5	L	4	X,Y
			1990 to 1994	07-017	Standard	Standard			5	P	4	X,Y
Daytona	Dynasty Intrepid Monaco Neon Omni Shadow Spirit Stealth	1990 to 1994	07-019	Standard	Standard			5	A	4	X,Y	
		1991 to 1993	07-039	Standard	Standard			5	D,E	4	X,Y	
Daytona	Dynasty Intrepid Monaco Neon Omni Shadow Spirit Stealth	1993	07-039	Standard	Standard			5	M,N	4	X	
		1994	07-039	Standard	Standard			5	M,N	4	E	
Daytona	Dynasty Intrepid Monaco Neon Omni Shadow Spirit Stealth	1992 to 1993	07-004	Standard	Standard		Yes	5	R	4	C	
		1994	07-004	Standard	Standard		Yes	5	R	4	X	
Eagle	Premier Summit	1990 to 1992	10-040			Yes		5	B	4	C	
		1990 to 1992	10-034			Yes		5	U	4	C	
		1993	10-034			Yes		5	A,B,C	4	C	
		1994	10-034	Standard				5	A,B,C	4	X	
	Talon	1991 to 1992	10-037			Yes		5	S,T	4	C	
		1993	10-037			Yes		5	F,G	4	C	
	Vision	1994	10-037	Standard				5	F,G	4	X	
		1993 to 1994	10-041	Standard	Standard			5	D	4	E	
Ford	Escort	1988	12-013			Yes		6-7	88-98	4	P	
		1989	12-013			Yes		6-7	90-98	4	P	
	Festiva	1988	12-033			Yes		6-7	06-13	4	P	
		1989	12-033			Yes		6-7	06,07	4	P	
	Tempo	1985 to 1986	12-015	Option				6-7	18-23	4	C	
		1987 to 1989	12-015	Option				6-7	30-39	4	C	

* Air bag became standard equipment in mid-year.

10th Character = Year: A=1980, B=1981, C=1982, D=1983, E=1984, F=1985, G=1986, H=1987, J=1988, K=1989, L=1990, M=1991, N=1992, P=1993, R=1994, S=1995, T=1996, V=1997, W=1998, X=1999

OCCUPANT ASSESSMENT FORM

Vehicles Manufactured With Automatic (Passive) Restraint Systems (Cont'd.)

Vehicle Make	Vehicle Model	Vehicle Model Year	NASS Make/Model Code: GV05-GV06	Air Bag		Passive Belt		VIN Character Identifier				
				Driver Only	Driver & Passenger	Motorized	Non-Motorized	Model		Restraint		
								Place	Code	Place	Code	
GV05	GV06	GV04										
Ford (Cont'd)	Aerostar: 4x2	1992 to 1994	12-441	Standard				5-7	A11,A31	N/A	N/A	
	: 4x4	1992 to 1994	12-441	Standard				5-7	A21,A41	N/A	N/A	
	Aspire	1994	12-036		Standard			6-7	???	4	L	
	Bronco	1994	12-421	Standard				5-7	U15	N/A	N/A	
	Club Wagon XL, E-150	1992 to 1994	12-441	Standard				5-7	E11	N/A	N/A	
	E-350	1992 to 1994	12-441	Standard				5-7	E31	N/A	N/A	
	E-350 Super	1992 to 1994	12-441	Standard				5-7	S31	N/A	N/A	
	Contour	1995	12-035		Standard			6-7	???	4	L	
	Crown Victoria: station wagon	1990 to 1991	12-016	Standard				6-7	76-79	4	C	
	Crown Victoria	1990 to 1991	12-016	Standard				6-7	72-74	4	C	
		1992	12-016	Standard		Option		6-7	72-75	4	C,L	
		1993 to 1994	12-016		Standard	Standard		6-7	72-74	4	L	
	Econoline Van, E-150	1993 to 1994	12-441	Standard				5-7	E14	N/A	N/A	
	E-250	1993 to 1994	12-441	Standard				5-7	E24,S24	N/A	N/A	
	Escort	1990	12-013				Yes	6-7	10-15,& 90-98	4	P	
		1991	12-013				Yes	6-7	10-15	4	P	
		1992 to 1993	12-013				Yes	6-7	10-16	4	P	
		1994	12-013	Standard				6-7	10-16	4	C	
	Festiva	1990 to 1993	12-033				Yes	6-7	05-07	4	P	
		1994	12-033		Standard			6-7	05-07	4	L	
	Mustang	1990 to 1993	12-003		Standard			6-7	40-45	4	C	
		1994			Standard			6-7	40-45	4	L	
	Probe	1990 to 1992	12-018				Yes	6-7	20-22	4	P	
		1993	12-018		Standard			6-7	20-22	4	C	
		1994	12-018		Standard			6-7	20,22	4	L	
	Taurus	1990 to 1991	12-017		Standard			6-7	50-58	4	C	
		1992	12-017		Standard			6-7	50-58	4	C,L	
		1993	12-017		Standard			6-7	52-58	4	C,L	
	1994	12-017		Standard	Option-Standard		6-7	52-58	4	L		
Tempo	1990 to 1991	12-015		Option		Yes	6-7	30-39	4	C,P		
	1992	12-015		Option		Yes	6-7	31-38	4	C,P		
	1993 to 1994	12-015		Option			6-7	31-37	4	C,P		
Thunderbird	1990 to 1992	12-004				Yes	6-7	60-64	4	P		
	1993	12-004				Yes	6-7	62-64	4	P		
	1994	12-004			Standard		6-7	62,64	4	L		
GMC	Safari: 4x2	1994	23-441	Standard				3,5-7	K.M15	N/A	N/A	
	: 4x4	1994	23-441	Standard				3,5-7	K.L15	N/A	N/A	
	Van, G-series	1994	23-461	Std/Opt				3,5	K.G	N/A	N/A	
Honda	Accord	1987	37-032				Yes	4-6	CA5	8	8	
		1988	37-032				Yes	4-6	CA5,CA6	8	6,8	
		1989	37-032				Yes	4-6	CA5,CA6	8	4,6,8	
		1990	37-032				Yes	4-6	CB7	8	4,5,6	
		1991	37-032				Yes	4-6	CB7	8	4,5,6,8	
		1991	37-032		Standard			4-6	CB9	8	5,6	
	wagon	1991	37-032					4-6	CB9	8	6	
	Civic CRX hatchback	1989 to 1991	37-031					Yes	4-6	ED8,ED9	8	6
	sedan	1990 to 1991	37-031					Yes	4-6	ED6,ED7	8	4,5,6
	wagon	1990 to 1991	37-031				Yes	4-6	ED3,ED4	8	4,5,6	
	Prelude	1988-1989	37-033					Yes	4-6	EE2,EE4	8	4,5
		1990	37-033				Yes	4-6	BA4	8	2,3,4	
		1991	37-033				Yes	4-6	BA4	8	1-5	
							Yes	4-6	BA4	8	2-5	

Air bag is optional in the U.S. but standard equipment in Canada.

10th Character = Year: A=1980, B=1981, C=1982, D=1983, E=1984, F=1985, G=1986, H=1987, J=1988, K=1989, L=1990, M=1991, N=1992, P=1993, R=1994, S=1995, T=1996, V=1997, W=1998, X=1999

OCCUPANT ASSESSMENT FORM

Vehicles Manufactured With Automatic (Passive) Restraint Systems (Cont'd.)

Vehicle Make GV05	Vehicle Model GV06	Vehicle Model Year GV04	NASS Make/Model Code: GV05-GV06	Air Bag		Passive Belt		VIN Character Identifier			
				Driver Only	Driver & Passenger	Motorized	Non-Motorized	Model		Restraint	
								Place	Code	Place	Code
Honda (Cont'd)	Accord SE wagon	1992 to 1993 1993 1992 to 1993 1994	37-032 37-032 37-032 37-032	Standard	Standard			4-6 4-6 4-6 4-6	CB7 ?CB7? CB9 CB9	8 8 8 8	4,5,7 ???
	Civic HB:C,D,VX	1992 1993	37-031 37-031	Standard		Yes		4-6 4-6	EH2 EH2	8 8	4,5,6 5,6,7
	HB:Si	1992 1993	37-031 37-031	Standard		Yes		4-6 4-6	EH3 EH3	8 8	8 8
	HB:SD:D,LX	1994 1992	37-031 37-031	Standard	Standard			4-6 4-6	EH2,3 EG8	8 8	???
	SD:EX	1993	37-031	Standard		Yes		4-6	EG8	8	4,5
	SD:SD	1992	37-031	Standard		Yes		4-6	EH9	8	9
	SD:Coupe DX	1993	37-031	Standard	Standard			4-6	EH9	8	9
	Coupe EX	1994	37-031	Standard	Standard			4-6	EG8,EH9	8	???
	DelSol S	1993	37-031	Standard				4-6	EJ2	8	4
	DelSol Si	1993	37-031	Standard				4-6	EJ1	8	5
	Prelude S	1994	37-031	Standard	Standard			4-6	EJ1	8	6
	Prelude Si	1993	37-031	Standard	Standard			4-6	EG1	8	4
	Prelude Si Vtec	1994	37-031	Standard	Standard			4-6	EG1	8	???
	Prelude Si 4WS	1993	37-031	Standard	Standard			4-6	EH6	8	6
		1994	37-031	Standard	Standard			4-6	EH6	8	???
		1992 to 1993	37-033	Standard	Standard			4-6	BAB	8	4
		1992 to 1993	37-033	Standard	Standard			4-6	BB2	8	5
		1993	37-033	Standard	Standard			4-6	BB2	8	7
		1994	37-033	Standard	Standard			4-6	BAB,BB1,2	8	???
		1992 to 1993	37-033	Standard	Standard			4-6	BB2	8	6
Hyundai	Excel	1987 to 1989 1990 to 1993	55-032 55-032			Yes Yes		4-5 4-5	LA,LD VA,VD	7 7	2 2
	Sonata	1989 to 1993 1994	55-033 55-033		Standard	Yes		4-5	BF	7	2
	Scoupe	1991 to 1993	55-034			Yes		4-5	VE	7	???
	Elantra	1992 to 1993	55-035				Yes	4-5	JF	7	2
Infiniti (Nissan)	M30	1990 to 1992	58-031	Standard				5	F	8	C
	Q45	1990 to 1993 1994	58-032 58-032	Standard				5	G	8	C
	G20	1991 to 1993 1994	58-033 58-033		Standard	Yes		5	G	8	D
	J30	1993 to 1994	58-034		Standard			5	P	8	P
					Standard			5	P	8	D
Isuzu	Impulse	1988-1989 1988-1989 1990 to 1993	38-032 38-032 38-032	Option Standard		Yes		4-5 4-5 6	BR CR	4 4	B C
	I-Mark	1989	38-031			Yes		6	2,4	7	3
	Stylus	1990 to 1993	38-033	Standard				4-5 6	RT S	7 7	4 3
Jaguar	XJ6	1990 to 1992 1993 1994	39-032 39-032 39-032	Standard		Yes		4 4 4	F F F	5 5 5	Y W ?W?
	XJ-S	1990 1991 to 1993 1994	39-031 39-031 39-031	Standard Standard	Standard			4 4 4	N,T T T	5 5 5	W W ?W?
Jeep	Grand Cherokee: 4x4	1993 to 1994	02-404	Standard				5-6	Z7	N/A	N/A
	Grand Wagoneer: 4x4	1993	02-431	Standard				5-6	Z8	N/A	N/A

10th Character = Year: A=1980, B=1981, C=1982, D=1983, E=1984, F=1985, G=1986, H=1987, J=1988, K=1989, L=1990, M=1991, N=1992, P=1993, R=1994, S=1995, T=1996, V=1997, W=1998, X=1999

OCCUPANT ASSESSMENT FORM

Vehicles Manufactured With Automatic (Passive) Restraint Systems (Cont'd.)

Vehicle Make GV05	Vehicle Model GV06	Vehicle Model Year GV04	NASS Make/Mode Code: GV05-GV06	Air Bag		Passive Belt		VIN Character Identifier				
				Driver Only	Driver & Passenger	Motorized	Non-Motorized	Model		Restraint		
								Place	Code	Place	Code	
Lexus (Toyota)	ES-250	1990 to 1991	59-031	Standard				5-6	V2	8	T	
	ES-300	1992 to 1993	59-031	Standard				5-6	K1	8	T	
		1994	59-031		Standard			5-6	K1	8	E	
	LS-400	1990 to 1992	59-032	Standard				5-6	F1	8	E	
	GS-300	1993 to 1994	59-032		Standard			5-6	F1	8	E	
		1994	59-034		Standard			5-6	???	8	E	
	SC-400/SC-300	1992	59-033	Standard				5-6	Z3	8	C	
		1993 to 1994	59-033		Standard			5-6	Z3	8	C	
Lincoln	Continental	1988	13-005		Standard			6-7	97,98	4	C	
		1989	13-005		Standard			6-7	97,98	4	L	
		1990	13-005		Standard	Standard+			6-7	97,98	4	C,L
	Mark VII Town Car	1990	13-002		Standard				6-7	92,93	4	C
		1990	13-001			Standard+			6-7	81-83	4	C,L
	Continental Mark VII Town Car	1991	13-005		Standard	Option+			6-7	97,98	4	C,L
		1991	13-002		Standard				6-7	92,93	4	C
			1991	13-001		Standard	Option+		6-7	81-83	4	C,L
	Continental Mark VII Town Car	1992 to 1993	13-005			Standard			6-7	97,98	4	L
		1992	13-002		Standard				6-7	92,93	4	C
1993 to 1994		13-002			Standard			6-7	91	4	L	
1992 to 1994		13-001			Standard			6-7	81-83	4	L	
Lotus	Esprit turbo	1990 to 1993	69-039	Standard				4	F	8	E	
		1994	69-039		Standard			4	F	8	???	
Maserati	228,430,Spyder	1990 to 1991	69-040			Yes		4	A-H	7	?	
Mazda	323	1990 to 1993	41-035			Yes		4-7	BG23	8		
	626 Hatchback	1990 to 1991	41-037			Yes		4-7	GD24	8		
		1990 to 1992	41-037			Yes		4-7	GD22	8	No	
	Sedan	1993	41-037		Standard			4-7	GD22	8		
		1994	41-037			Standard		4-7	GE22	8		
	929	1990 to 1991	41-043			Option	Yes		4-7	HC22	8	
		1992	41-043		Standard	Standard			4-7	HD46	8	
	MPV (Wagon)	1993 to 1994	41-043			Option*			4-7	HD46	8	Discern-
		1993	41-441		Option*				4-6	LVS	N/A	
		1994	41-441		Standard				4-6	LVS	N/A	
	MX-3	1992 to 1993	41-046			Standard	Yes		4-7	EC43	8	
		1994	41-046			Standard			4-7	EC43	8	
	MX-5 Miata	1990 to 1993	41-045		Standard				4-7	NA35	8	ible
		1994	41-045			Standard			4-7	NA35	8	
	MX-6	1990 to 1992	41-044			Standard	Yes		4-7	GD31	8	
1993		41-044		Standard				4-7	GE31	8		
1994		41-044			Standard			4-7	GE31	8		
Protege	1990 to 1993	41-035			Standard	Yes		4-7	BG22	8		
RX-7 hardtop convertible hardtop	1990 to 1991	41-034			Standard	Yes		4-7	FC33	8	Pattern	
	1990 to 1991	41-034		Standard				4-7	FC35	8		
	1993 to 1994	41-034		Standard				4-7	FD33	8		
Mercedes Benz	500SEC	1984	42-036	Option				4-7	CA44	8	B	
	SEL	1984	42-036	Option				4-7	CA37	8	B	
	300SD	1984	42-037	Option				4-7	CB20	8	B	
	380SE	1984	42-037	Option				4-7	CA32	8	B	
	190E	1984	42-039	Option				4-7	DA24	8	B	
	D	1984	42-039	Option				4-7	DB22	8	B	
		500SEC	1985	42-036	Option				4-7	CA44	8	B,D
	SEL	1985	42-036	Option				4-7	CA37	8	B,D	

* Air bag became standard equipment in mid-year.

Due to a production plant fire, Lincoln right-front passenger air bags were not available for many 1990 and 1991 model year vehicles. The passenger air bag is considered an option on 1991 model year vehicles but was not available until fall of 1991.

10th Character = Year: A=1980, B=1981, C=1982, D=1983, E=1984, F=1985, G=1986, H=1987, J=1988, K=1989, L=1990, M=1991, N=1992, P=1993, R=1994, S=1995, T=1996, V=1997, W=1998, X=1999

OCCUPANT ASSESSMENT FORM

Vehicles Manufactured With Automatic (Passive) Restraint Systems (Cont'd.)

Vehicle Make GV05	Vehicle Model GV06	Vehicle Model Year GV04	NASS Make/Mode Code: GV05-GV06	Air Bag		Passive Belt		VIN Character Identifier			
				Driver Only	Driver & Passenger	Motorized	Non-Motorized	Model		Restraint	
								Place	Code	Place	Code
Mercedes Benz (Cont'd)	300SD	1985	42-037	Option				4-7	CB20	8	B,D
	380SE	1985	42-037	Option				4-7	CA32	8	B,D
	190E	1985	42-039	Option				4-7	DA24	8	B,D
	D	1985	42-039	Option				4-7	DB22	8	B,D
	190E - 2.3	1986 to 1988	42-039	Standard				4-7	DA28	8	D
	E - 2.3-16	1986 to 1987	42-039	Standard				4-7	DA34	8	D
	E - 2.6	1986 to 1989	42-039	Standard				4-7	DA29	8	D
	D - 2.5	1986 to 1989	42-039	Standard				4-7	DB26	8	D
	D - 2.5 T	1987	42-039	Standard				4-7	DB28	8	D
	260E	1987 to 1989	42-031	Standard				4-7	EA26	8	D
	300CE	1988 to 1989	42-031	Standard				4-7	EA50	8	D
	D - 2.5 T	1989	42-031	Standard				4-7	EB28	8	D
	DT	1987	42-035	Standard				4-7	EB33	8	D
	E	1986 to 1989	42-031	Standard				4-7	EA30	8	D
	SDL	1987	42-037	Standard				4-7	CB25	8	D
	SE	1989	42-037	Standard				4-7	CA24	8	D
	SEL	1988 to 1989	42-035	Standard				4-7	CA25	8	D
	TDT	1987	42-035	Standard				4-7	EB93	8	D
	TE	1988 to 1989	42-031	Standard				4-7	EA90	8	D
	SD	1989	42-031	Standard				4-7	CB34	8	D
	SDL	1989	42-031	Standard				4-7	CB35	8	D
	420SEL	1986 to 1988	42-036	Standard				4-7	CA35	8	D
	560SEC	1986 to 1988	42-036	Standard				4-7	CA45	8	D
SEL	1986 to 1988	42-036	Standard				4-7	CA39	8	D	
SL	1986 to 1988	42-036	Standard				4-7	BA48	8	D	
Mercedes Benz**	190E - 2.6	1990 to 1991	42-039	Standard				4-7	DA29	8	D
	300CE	1990 to 1991	42-031	Standard	Option			4-7	EA51	8	D,E
	D - 2.5 T	1990 to 1991	42-031	Standard	Option			4-7	EB28	8	D,E
	E	1990 to 1991	42-031	Standard	Option			4-7	EA30	8	D,E
	E - 2.6	1990 to 1991	42-031	Standard	Option			4-7	EA26	8	D,E
	E - 4-Matic	1990 to 1991	42-031	Standard	Option			4-7	ED30	8	D,E
	SE	1990 to 1991	42-037	Standard	Option			4-7	CA24	8	D,E
	SEL	1990 to 1991	42-035	Standard	Option			4-7	CA25	8	D,E
	SL	1990 to 1991	42-033	Standard	Standard			4-7	FA61	8	E
	TE	1990 to 1991	42-031	Standard	Option			4-7	EA90	8	D,E
	TE -4-Matic	1990 to 1991	42-031	Standard	Option			4-7	ED90	8	D,E
	350SD	1990 to 1991	42-031	Standard	Option			4-7	CB34	8	D,E
	SDL	1990 to 1991	42-031	Standard	Option			4-7	CB35	8	D,E
	420SEL	1990 to 1991	42-036	Standard	Standard			4-7	CA35	8	E
500SL	1990 to 1991	42-033	Standard	Standard			4-7	FA66	8	E	
560SEC	1990 to 1991	42-036	Standard	Standard			4-7	CA45	8	E	
SEL	1990 to 1991	42-036	Standard	Standard			4-7	CA39	8	E	
Mercedes Benz	190E - 2.3	1992	42-039	Standard				4-7	DA28	8	D
	E - 2.6	1992	42-039	Standard				4-7	DA29	8	D
	300CE	1992	42-040	Standard	Option			4-7	EA51	8	D,E
	CE Conv	1992	42-040	Standard	Option			4-7	EA66	8	D,E
	D - 2.5 T	1992	42-031	Standard	Option			4-7	EB28	8	D,E
	E	1992	42-031	Standard	Option			4-7	EA30	8	D,E
	E - 2.8	1992	42-031	Standard	Option			4-7	EA28	8	D,E
	E - 4-Matic	1992	42-031	Standard	Option			4-7	ED32	8	D,E
	E - 4-Matic	1992	42-031	Standard	Option			4-7	ED30	8	D,E
	SD	1992	42-031	Standard	Standard			4-7	GA34	8	E
	SE	1992	42-037	Standard	Standard			4-7	CA24	8	E
	SEL	1992	42-035	Standard	Option			4-7	CA25	8	D,E
	SL	1992	42-033	Standard	Standard			4-7	FA61	8	E

** Mercedes Benz offers: (1) only a standard driver side air bag in the 190 class vehicles, (2) standard driver and passenger air bags for their models equipped with a V8 or a roadster (i.e., SL), and (3) standard driver and optional passenger air bags for models equipped with 6-cylinder engines (excluding the roadsters).

10th Character = Year: A=1980, B=1981, C=1982, D=1983, E=1984, F=1985, G=1986, H=1987, J=1988, K=1989, L=1990, M=1991, N=1992, P=1993, R=1994, S=1995, T=1996, V=1997, W=1998, X=1999

OCCUPANT ASSESSMENT FORM

Vehicles Manufactured With Automatic (Passive) Restraint Systems (Cont'd.)

Vehicle Make GV05	Vehicle Model GV06	Vehicle Model Year GV04	NASS Make/Mode Code: GV05- GV06	Air Bag		Passive Belt		VIN Character Identifier			
				Driver Only	Driver & Passenger	Motorized	Non-Motorized	Model		Restraint	
								Place	Code	Place	Code
Mercedes Benz (Cont'd)	TE	1992	42-031	Standard	Option			4-7	EA90	8	D,E
	TE - 4-Matic	1992	42-031	Standard	Option			4-7	ED90	8	D,E
	350SD	1992	42-031		Standard			4-7	CB34	8	E
	SDL	1992	42-031	Standard	Option			4-7	CB35	8	C,E
	400E	1992	42-041		Standard			4-7	EA34	8	E
	420SEL	1992	42-036		Standard			4-7	CA35	8	E
	500E	1992	42-042		Standard			4-7	EA36	8	E
	SEC	1992	42-036		Standard			4-7	GA70	8	E
	SEL	1992	42-036		Standard			4-7	GA51	8	E
	SL	1992	42-033		Standard			4-7	FA67	8	E
	560SEC	1992	42-036		Standard			4-7	CA45	8	E
	SEL	1992	42-036		Standard			4-7	CA39	8	E
	600SEC	1992	42-038		Standard			4-7	GA76	8	E
	SEL	1992	42-038		Standard			4-7	GA57	8	E
SL	1992	42-038		Standard			4-7	FA76	8	E	
Mercedes Benz	190E - 2.3	1993	42-039	Standard				4-7	DA28	8	D
	E - 2.6	1993	42-039	Standard				4-7	DA29	8	D
	220C	1993	42-031		Standard			4-7	???	8	E
	280C	1994	42-031		Standard			4-7	???	8	E
	300CE	1993 to 1994	42-040		Standard			4-7	EA52	8	E
	CE Conv	1993 to 1994	42-040		Standard			4-7	EA66	8	E
	D - 2.5 T	1993 to 1994	42-031		Standard			4-7	EB28	8	E
	E	1993 to 1994	42-031		Standard			4-7	EA30	8	E
	E - 2.8	1993 to 1994	42-031		Standard			4-7	EA28	8	E
	E - 4-Matic	1993 to 1994	42-031		Standard			4-7	ED30,EA32	8	E
	SD	1993 to 1994	42-037		Standard			4-7	GA34	8	L
	SE	1993 to 1994	42-037		Standard			4-7	CA24	8	L
	SL	1993 to 1994	42-033		Standard			4-7	FA61	8	L
	TE	1993 to 1994	42-031		Standard			4-7	EA90	8	L
	TE - 4-Matic	1993 to 1994	42-031		Standard			4-7	ED90	8	L
	400E	1993 to 1994	42-041		Standard			4-7	EA34	8	L
	SEL	1993 to 1994	42-041		Standard			4-7	EA34	8	L
	500E	1993 to 1994	42-042		Standard			4-7	EA36	8	L
	SEC	1993 to 1994	42-036		Standard			4-7	GA70	8	L
	SEL	1993 to 1994	42-038		Standard			4-7	GA51	8	L
SL	1993 to 1994	42-033		Standard			4-7	FA66	8	L	
600SEC	1993 to 1994	42-038		Standard			4-7	GA76	8	L	
SEL	1993 to 1994	42-038		Standard			4-7	GA57	8	L	
SL	1993 to 1994	42-033		Standard			4-7	FA76	8	L	
Mercury	Topaz	1985 to 1986	14-015	Option				6	71-76	4	C
		1987 to 1989	14-015	Option				6	30-38	4	C
	Capri	1991 to 1993	14-031	Standard				6-7	01,03	4	C
		1994	14-031		Standard			6-7	01,03	4	L
	Cougar	1990 to 1993	14-004		Standard	Yes		6-7	60,62	4	P
		1994	14-004		Standard			6-7	62	4	L
	Grand Marquis: SW	1990 to 1991	14-006	Standard				6-7	78,79	4	C
	Grand Marquis:	1990 to 1991	14-006	Standard				6-7	74,75	4	C
		1992 to 1994	14-006		Standard			6-7	74,75	4	-
	Mystique	1995	14-037		Standard			6-7	???	4	-
	Sable	1990 to 1991	14-017	Standard				6-7	50-58	4	C
		1992	14-017	Standard	Option			6-7	50-58	4	C,L
	1993 to 1994	14-017		Standard			6-7	50-58	4	-	
Topaz	1990 to 1994	14-015		Option		Yes	6-7	30-38	4	C,P	
Tracer	1991 to 1993	14-036		Option		Yes	6-7	10-15	4	C	

10th Character = Year: A=1980, B=1981, C=1982, D=1983, E=1984, F=1985, G=1986, H=1987, J=1988, K=1989, L=1990, M=1991, N=1992, P=1993, R=1994, S=1995, T=1996, V=1997, W=1998, X=1999

OCCUPANT ASSESSMENT FORM

Vehicles Manufactured With Automatic (Passive) Restraint Systems (Cont'd.)

Vehicle Make GV05	Vehicle Model GV06	Vehicle Model Year GV04	NASS Make/Model Code: GV05-GV06	Air Bag		Passive Belt		VIN Character Identifier			
				Driver Only	Driver & Passenger	Motorized	Non-Motorized	Model		Restraint	
								Place	Code	Place	Code
Mercury (Cont'd)	Villager	1993	14-443			Yes		5-7	V11	N/A	N/A
		1994	14-443	Option*		Yes		5-7	V11	N/A	N/A
Mitsubishi	Diamante	1992 to 1993	52-040	Standard				5	C	4	X
		1994	52-040		Standard			5	C,P	4	B
	Eclipse	1990 to 1992	52-037			Yes		5	S,T	4	C
		1993	52-037			Yes		5	F,G	4	C
	Expo	1992	52-041			Yes		5	V,W,Y,Z	4	C
		1993	52-041			Yes		5	B,C,D,E	4	C
	Galant	1990 to 1992	52-034			Yes		5	R,X	4	C
		1993	52-034			Yes		5	H	4	C
	Mirage	1990 to 1992	52-034		Standard			5	H	4	B
		1993	52-035			Yes		5	U	4	C
	Montero	1990 to 1992	52-035			Yes		5	A	4	C
		1993	52-401		Standard			5	R	N/A	N/A
	Precis	1990 to 1993	52-036				Yes	3-5	HVD	7	2
		1994	52-038		Standard			5	B	4	X
Sigma	1990	52-031				Yes	5	C	4	C	
	1991 to 1992	52-039		Standard			5	D,E	4	X	
Starion	1990	52-039					5	M,N	4	X	
	1993	52-039		Standard			5	M,N	4	B	
Nissan	240SX	1990 to 1993	35-032				Yes	5	S	8	A
		1990	35-034			Yes		5	Z	8	A
	300ZX	1991	35-034		Option		Yes	5	Z	8	A,H
		1992 to 1994	35-034		Standard			5	Z	8	C,F
	Altima	1993	35-047		Standard			5	U	8	C,F
		1994	35-047			Standard		5	U	8	???
	Axxess	1990 to 1991	35-442			Yes		5	M	8	B
		1990 to 1991	35-039			Yes		5	J	8	B
	Maxima	1992	35-039		Option		Yes	5	J	8	A,H
		1993 to 1994	35-039		Standard			5	J	8	C,F
	NX Coupe	1991 to 1994	35-044		Standard			3-5	1.B	8	C,F
		1990	35-044		Option		Yes	5	N	8	A,H
	Pulsar	1990	35-443					5-7	N11	N/A	N/A
		1993	35-443		Option*		Yes	5-7	N11	N/A	N/A
Quest	1994	35-443				Yes	3-5	4.B	8	A	
	1990 to 1992	35-043		Option		Yes	3-5	4.B	8	A,H	
Sentra	1990 to 1992	35-042			Yes		5	U	8	P	
	1993	35-042									
Oldsmobile	Delta 88	1974 to 1976	21-002		Option			2	L,N		
		1974	21-003		Option			2	T,V,X		
	Ninety-Eight	1975 to 1976	21-003		Option			2	V,X		
		1974	21-005		Option			2	U,W,Y		
	Toronado	1975 to 1976	21-005		Option			2	U,W,Y,Z		
	Achieva	1992 to 1993	21-021				Yes	4-5	NF,NL	7	4
		1994	21-021		Standard			4-5	NF	7	3
	Aurora	1994	21-022		Standard			4-5	???	7	3
		1990	21-002			Yes		4-5	BP	7	4
	Custom Cruiser	1991 to 1992	21-002		Standard			4-5	BP	7	3
		1990 to 1991	21-018			Yes		4-5	NF,NK, NL,NT	7	4
	Cutlass Calais	1990	21-017			Yes		4-5	AJ,AM,AS	7	4
		1991 to 1992	21-017			Yes		4-5	AJ,AL,AM	7	4
1993		21-017		Option	Yes		4-5	AJ,AG,AM	7	3,4	
1994		21-017		Standard			4-5	AJ,AG	7	3	

Air bag became standard equipment in mid-year.

10th Character = Year: A=1980, B=1981, C=1982, D=1983, E=1984, F=1985, G=1986, H=1987, J=1988, K=1989, L=1990, M=1991, N=1992, P=1993, R=1994, S=1995, T=1996, V=1997, W=1998, X=1999

OCCUPANT ASSESSMENT FORM

Vehicles Manufactured With Automatic (Passive) Restraint Systems (Cont'd.)

Vehicle Make GV05	Vehicle Model GV06	Vehicle Model Year GV04	NASS Make/Model Code: GV05-GV06	Air Bag		Passive Belt		VIN Character Identifier				
				Driver Only	Driver & Passenger	Motorized	Non-Motorized	Model		Restraint		
								Place	Code	Place	Code	
Oldsmobile (Cont'd)	Cutlass Supreme	1990 to 1991	21-020				Yes	4-5	WH,WR, WS,WT	7	4	
		1992 to 1993	21-020				Yes	4-5	WH,WR,WT	7	4	
	Supreme S	1994	21-020	Standard				4-5	???	7	3	
	Delta 88 Royale	1987 to 1991	21-002	Option				Yes	4-5	HN,HY	7	3,4
		1992 to 1993	21-002	Standard					4-5	HN,HY	7	3
	98 Regency	1994	21-020		Standard				4-5	HN,HY	7	2
		1990	21-003	Option				Yes	4-5	CW,CX	7	3,4
	98 Touring sedn	1991 to 1993	21-003	Standard					4-5	CW,CX	7	3
		1994	21-003		Standard				4-5	CW,CX	7	2
	Silhouette Toronado	1990	21-003					Yes	4-5	CV	7	4
1991 to 1993		21-003	Standard					4-5	CV	7	3	
1994		21-003		Standard				4-5	CV	7	2	
	1994	21-441	Standard					3,5-7	H,U06	N/A	N/A	
	1990	21-005					Yes	4-5	EV,EZ	7	4	
	1991 to 1992	21-005	Standard					4-5	EV,EZ	7	3	
Peugeot	405	1990 to 1991	44-036			Yes		4	D,E	7	3	
	505	1990 to 1991	44-034				Yes	4	B,C	7	2	
Plymouth	Gran Fury	1988	09-004	Option*				5	B	4	X,Y	
		1989	09-004	Standard				5	B	4	X,Y	
	Acclaim Colt Hatchback	1990 to 1993	09-019	Standard				Yes	5	A	4	X,Y
		1989	09-034					Yes	5	U	4	C
	2,4 dr 2,4 dr Vista SW	1991 to 1992	09-034					Yes	5	???	4	C
		1993	09-034					Yes	5	A	4	C
	Horizon Laser	1994	09-021	Standard					5	A	4	X
		1991	09-441					Yes	5	G,H	4	C
		1992	09-441					Yes	5	V	4	C
	Neon Sundance Voyager:	1993	09-441					Yes	5	B,C	4	C
		1990	09-008	Standard					5	L	4	X,Y
	4x2	1990 to 1991	09-037					Yes	5	S	4	C
		1992	09-037					Yes	5	S,T	4	C
	4x4	1993	09-037					Yes	5	F,G	4	C
1995		09-020						5	???	4	E	
	1990 to 1993	09-017	Standard	Standard				5	P	4	X,Y	
	1992 to 1993	09-442	Standard					5-6	H2,4,5	N/A	N/A	
	1994	09-442		Standard				5-6	H2,4,5	N/A	N/A	
	1992 to 1993	09-442	Standard					5-6	K4,5	N/A	N/A	
	1994	09-442		Standard				5-6	K4,5	N/A	N/A	
Pontiac	6000	1990 to 1991	22-017				Yes	4-5	AF,AJ	7	4	
		1990 to 1991	22-002				Yes	4-5	HX,HY,HZ	7	4	
	Bonneville ,SE ,SSE ,SSEi	1992 to 1993	22-002	Standard					4-5	HX	7	3
		1992 to 1993	22-002	Standard					4-5	HZ	7	2,3
	Firebird	1992 to 1993	22-002		Option				4-5	HY	7	2
		1994	22-002		Standard				4-5	HX,HY,HZ	7	2
	Firefly	1990 to 1992	22-009	Standard					4-5	FS,FW	7	3
		1993	22-009	Standard					4-5	FS,FV	7	3
	Grand Am	1994	22-009						4-5	FS,FV	7	2
		1990	22-398		Standard			Yes	4-5	MR,MT	7	4
		1991 to 1993	22-398				Yes	4-5	MR	7	4	
		1990	22-018				Yes	4-5	NE,NW	7	4	
		1991	22-018				Yes	4-5	NE,NG,NW	7	4	
		1992 to 1993	22-018				Yes	4-5	NE,NW	7	4	
	1994	22-018					4-5	NE,NW	7	3		

Air bag became standard equipment in mid-year.

10th Character = Year: A=1980, B=1981, C=1982, D=1983, E=1984, F=1985, G=1986, H=1987, J=1988, K=1989, L=1990, M=1991, N=1992, P=1993, R=1994, S=1995, T=1996, V=1997, W=1998, X=1999

OCUPANT ASSESSMENT FORM

Vehicles Manufactured With Automatic (Passive) Restraint Systems (Cont'd.)

Vehicle Make GV05	Vehicle Model GV06	Vehicle Model Year GV04	NASS Make/Mode Code: GV05-GV06	Air Bag		Passive Belt		VIN Character Identifier				
				Driver Only	Driver & Passenger	Motorized	Non-Motorized	Model		Restraint		
								Place	Code	Place	Code	
Pontiac (Cont'd)	Grand Prix	1990 to 1991	22-020				Yes	4-5	WJ,WP,WT	7	4	
		1992 to 1993	22-020				Yes	4-5	WH,WJ,WP,WT	7	4	
		1994	22-020		Standard				4-5	WH,WJ,WP,WT	7	2
	LeMans	1990 to 1991	22-031				Yes	4-5	TN,TR,TS,TX	7	4	
		1992 to 1993	22-031				Yes	4-5	TN,TX	7	4	
	Sunbird	1990	22-016					Yes	4-5	JB,JD,JU	7	4
		1991	22-016					Yes	4-5	JB,JC,JD,JU	7	4
		1992 to 1994	22-016					Yes	4-5	JB,JC,JD	7	4
	Porsche 944 S Turbo	1994	22-441		Standard				3,5,7	M.U06	N/A	N/A
		1987	45-037			Option			7-8	94	6	2
1987		45-037			Option			7-8	94	6	2	
1987		45-037			Standard			7-8	95	6	2	
944 S Turbo	1988 to 1989	45-037			Option			7-8	94	6	2	
	1988 to 1989	45-037			Standard			7-8	94	6	2	
	1988 to 1989	45-037			Standard			7-8	95	6	2	
	911	1990 to 1991	45-031			Standard			7-8	96	6	2
		1992	45-031			Standard			12-13	41-48	6	2
	928	1993 to 1994	45-031			Standard			12-13	41-46	6	2
		1990 to 1991	45-035			Standard			7-8	92	6	2
	944 968	1992 to 1994	45-035			Standard			12-13	81	6	2
1990 to 1991		45-037			Standard			7-8	94	6	2	
968	1992 to 1993	45-039			Standard			12-13	82,84	6	2	
	All All All	1989	69-042		Standard			??Yes??	2-3	CA	8	B
		1990 to 1993	69-042						2-3	CA	8	???
1994		69-042			Standard			2-3	CA	8	???	
Saab	9000 Turbo	1988 to 1989	47-034		Option			4	C	5	L	
	900 series	1990 to 1993	47-031		Standard			4	A	5	J,K,L	
		1994	47-031			Standard			4	A	5	???
	9000 series	1990 to 1993	47-034		Standard			4	C	5	J,K,L	
1994		47-034			Standard			4	C	5	???	
Saturn	SC - 2dr	1991	24-002				Yes	4-5	ZB,G,H	7	4	
		1992	24-002		Standard		Yes	4-5	ZB,G,H	7	5	
		1993	24-002		Standard			4-5	ZB,ZE,ZF,ZG,ZH	7	5	
	SL1	1991	24-001				Yes	4-5	ZB,F,G,H	7	4	
		1992 to 1993	24-001		Standard		Yes	4-5	ZB,F,G,H	7	5	
	SL2	1991	24-001				Yes	4-5	ZD,J,K	7	4	
		1992 to 1993	24-001		Standard		Yes	4-5	ZD,J,K	7	5	
	SL3	1993	24-001		Standard		Yes	4-5	ZL,ZM	7	5	
		1993	24-003		Standard		Yes	4-5	ZG,ZH	7	5	
	SW1 SW2	1993	24-003		Standard		Yes	4-5	ZJ,ZK	7	5	
1993		24-003		Standard				4-5	ZJ,ZK	7	5	
Sterling	B27s	1990 to 1991	61-031				Yes	6	4,8	7	3	
Subaru	Impreza	1993	48-038		Option*			4-5	???	8	3	
		1994	48-038			Standard		4-5	???	8	???	
	Justy	1990	48-036					Yes	4-5	KA,KD,KG	8	2
		1991 to 1993	48-036					Yes	4-5	KA,KD	8	2

* Air bag became standard equipment in mid-year.

10th Character = Year: A=1980, B=1981, C=1982, D=1983, E=1984, F=1985, G=1986, H=1987, J=1988, K=1989, L=1990, M=1991, N=1992, P=1993, R=1994, S=1995, T=1996, V=1997, W=1998, X=1999

OCCUPANT ASSESSMENT FORM

Vehicles Manufactured With Automatic (Passive) Restraint Systems (Cont'd.)

Vehicle Make	Vehicle Model	Vehicle Model Year	NASS Make/Mode Code: GV05-GV06	Air Bag		Passive Belt		VIN Character Identifier					
				Driver Only	Driver & Passenger	Motorized	Non-Motorized	Model		Restraint			
								Place	Code	Place	Code		
Subaru (Cont'd)	Legacy	1990	48-034	Option**		Yes		4-5	BC,BF,BJ	8	2		
		1991	48-034			Yes		4-5	BC,BJ	8	2,3		
		1992	48-034			Yes		4-5	BC,BJ	8	2,3		
		1993	48-034			Yes		4-5	BC,BJ	8	3		
	Loyale	1990	48-031	Standard		Yes		4-5	AC,AK,AN	8	2		
		1991 to 1993	48-031			Yes		4-5	AC,AN	8	2		
	SVX	1992 to 1993	48-037	Standard	Standard	Yes		4-5	CX	8	3		
	1994	48-037	Standard	4-5		CX		8	???				
XT, XT6	1990 to 1991	48-035	Standard		Yes		4-5	AX	8	2			
Suzuki	Swift	1990	53-034				Yes		4	A	5	C,D	
		1991 to 1993	53-034				Yes		4	A	5	C,D,E	
Toyota	Camry	1987	49-040			Yes		5	V	8	8th column reports		
		1988-1989	49-040			Yes		5	V	8			
		1981-1986	49-035			1987		49-035	Yes	5		X	8
						1988-1989		49-035	Yes	5		X	8
	Camry	1990 to 1991	49-040	Standard				5	V	8	Body		
		1992 to 1993	49-040					5	K	8			
	Celica	1994	49-040	Standard	Standard			5	K	8			
		1990 to 1993	49-033					5	T	8			
	Corolla	1994	49-033	Standard	Standard		Yes	5	T	8	Type		
		1990 to 1992	49-032					5	E	8			
	Cressida	1993	49-032	Standard	Standard			5	E	8	rather		
		1994	49-032					5	E	8			
	MR2	1990 to 1992	49-035	Standard		Yes		5	X	8			
		1991 to 1993	49-041					5	W	8			
	Paseo	1994	49-041	Standard	Standard		Yes	5	W	8	than		
		1992	49-042					5	L	8			
Previa	1993 to 1994	49-042	Standard	Standard			5	L	8	Restraint			
	1991 to 1993	49-441					4,5	AC	8				
Supra	1994	49-441	Standard	Standard			4,5	AC	8				
	1990 to 1993	49-034					5	A	8				
Tercel	1994	49-034	Standard				5	A	8	System			
	1990 to 1992	49-038					5	L	8				
	1993 to 1994	49-038	Standard				5	L	8				
Volkswagen	Golf/GTI	1985-1989	30-042				Yes		7-8	17	6	9	
		Rabbit	1981-1984				30-036		Yes	7-8	17	6	9
	Cabriolet	1990 to 1993	30-042	Standard					7-8	15	6	5	
		1990 to 1993	30-045						Yes	7-8	50	6	4
	Corrado	1990 to 1993	30-045						7-8	30	6	2	
		1990 to 1993	30-044						Yes	7-8	30	6	2
	Fox	1990 to 1992	30-042						7-8	1G	6	2	
		1993	30-042						Yes	7-8	1H	6	2
	Golf/GTI	1994	30-042	Standard	Option**				7-8	1H	6	8	
		1994	30-048						Yes	7-8	1H	6	2,8
	Jetta	1990 to 1991	30-040						7-8	1H	6	2	
1992 to 1993		30-040	Yes						7-8	1G	6	2	
Jetta III	1993	30-040	Option**					7-8	1H	6	2		
	1993	30-040						Yes	7-8	1H	6	2,8	
Passat	1990 to 1993	30-046						7-8	31	6	4		
	1990 to 1993	30-046						Yes	7-8	31	6	4	

** Air bag was offered as an option in mid-year.

10th Character = Year: A=1980, B=1981, C=1982, D=1983, E=1984, F=1985, G=1986, H=1987, J=1988, K=1989, L=1990, M=1991, N=1992, P=1993, R=1994, S=1995, T=1996, V=1997, W=1998, X=1999

OCCUPANT ASSESSMENT FORM

Vehicles Manufactured With Automatic (Passive) Restraint Systems (Cont'd.)

Vehicle Make GV05	Vehicle Model GV06	Vehicle Model Year GV04	NASS Make/Mode Code: GV05-GV06	Air Bag		Passive Belt		VIN Character Identifier			
				Driver Only	Driver & Passenger	Motorized	Non-Motorized	Model		Restraint	
								Place	Code	Place	Code
Volvo	740	1987	51-039	Option				4	F	5	A
	760	1987	51-038	Option*				4	G	5	A
	780	1987	51-038	Option*				4	H	5	A
	740 GLE Turbo	1988 to 1989	51-039	Option				4	F	5	A
		1988 to 1989	51-039	Standard				4	F	5	A
		1988 to 1989	51-038	Standard				4	G	5	A
		1988 to 1989	51-038	Standard				4	H	5	A
	240 series	1990 to 1991	51-034	Standard				4	A	5	A
		1992 to 1993	51-034	Standard				4	A	5	S,W
	740 series	1990 to 1992	51-039	Standard				4	F	5	A
	760 series	1990	51-038	Standard				4	G	5	A
	780 Coupe	1990 to 1992	51-038	Standard				4	H	5	A
		1993	51-042		Standard			4	L	5	S
	850 series	1994	51-042		Standard			4	L	5	S,W
		1991	51-040	Standard				4	J	5	A
940 series	1992 to 1993	51-040	Standard				4	J	5	S,W	
	1994	51-040		Standard			4	J	5	S,W	
960 series	1991	51-041	Standard				4	K	5	A	
	1992 to 1994	51-041		Standard			4	K	5	S,W	
Yugo	GV series	1990 to 1992	57-031				Yes	5	A-C,E	8	2

Air bag became standard equipment in mid-year.

10th Character = Year: A=1980, B=1981, C=1982, D=1983, E=1984, F=1985, G=1986, H=1987, J=1988, K=1989, L=1990, M=1991, N=1992, P=1993, R=1994, S=1995, T=1996, V=1997, W=1998, X=1999

Variable Name: Glasgow Coma Scale (GCS) Score [Cont'd.]

If more than one Glasgow Coma Scale (GCS) Score is recorded in the document without reference to initial GCS Score, then select the GCS Score to be coded in the following order:

- (a) code the GCS Score from the medical record with the earliest time to hospital treatment (i.e., code ER record over discharge summary)
- (b) code the GCS Score that appears first in a medical record other than the ER record
- (c) if two or more GCS Scores are recorded in the same record without reference to time, code the lowest GCS Score.

Code "15" is encoded when the occupant's medical record does not specifically indicate the GCS Score but does indicate one or more of the following pieces of information:

- AxOx3 (alert and oriented times three)
- neurologically intact, normal, etc., or
- CN II-XII okay, normal, intact, etc.

Code "97" (Injured, details unknown) is used when the occupant is injured but the details are unknown. Use this code whenever OA43, Number of Recorded Injuries for This Occupant, equals "97" (Injured, details unknown).

Code "99" (Unknown if injured) is used when it is unknown if the occupant was injured. Use this code whenever OA43, Number of Recorded Injuries for This Occupant, equals "99" (Unknown if injured).

Variable Name: Was the Occupant Given Blood?

Element Values:

- 1 No - blood not given
- 2 Yes - blood given (specify units)
- 9 Unknown if blood given

Source: Zone Center determined from official medical records or Emergency Medical Service (EMS) reports.

Remarks:

In general, blood consists of red blood cells (erythrocytes), white blood cells (leukocytes) and platelets (thrombocytes) suspended in plasma. In a transfusion, blood can be given in four separate forms: whole blood, packed red blood cells, plasma, or platelets; or in a combination of these forms.

Whole blood is blood from which none of the elements have been removed.

Packed red blood cells are whole blood from which plasma has been removed.

Plasma is the fluid (pale yellow liquid) of the blood in which the particulate components are suspended. Plasma is often given to burn patients.

Platelets are known for their role in blood coagulation. Platelets are often given when blood clotting is desired.

Code "1" (No - blood not given) is used whenever OA50, Glasgow Coma Scale (GCS) Score equals "00" (Not injured) or "01" (Injured - not treated at medical facility) or it is known that the person did not receive any professional treatment. In addition, use this code when:

- it is known that the occupant was injured and not given blood; or
- an occupant is transported and released and not subsequently hospitalized [i.e., OA35, Treatment - Mortality, equals "4" (Transported and released) or "6" (Treatment later)], independent of whether the occupant's records are acquired.

Code "2" (Yes - blood given) is used when this occupant was given "blood" in any of the four forms, or combinations, discussed above for injuries sustained as a result of their motor vehicle traffic accident. Excluded are transfusions which result from noninjury. For example, if a spontaneous abortion results to a mother who was not injured, but who was given a transfusion, then do not consider this occupant to have had blood given. Whenever an occupant is "taken to surgery" researchers should be alert to the possibility that a blood transfusion occurred. Whenever a transfusion occurs, write down the number of units of blood given. Do not specify the type of blood transfusion.

Variable Name: Was the Occupant Given Blood?

Code "9" (Unknown if blood given) is used whenever OA43, Number of Recorded Injuries for This Occupant, equals "97" (Injured, details unknown) or "99" (Unknown if injured). In addition, use this code when the occupant is:

- injured and treated at a medical facility [i.e., OA50, Glasgow Coma Scale (GCS) Score equals "02" through "15"] but it cannot be determined if blood was given.
- hospitalized and the occupant's records are inconclusive regarding whether blood was given;
- taken to surgery, regardless of hospitalization (e.g., died prior to being hospitalized), and the occupant's records are inconclusive regarding whether blood was given; or
- hospitalized or taken to surgery and the medical records are pending.

Variable Name: Arterial Blood Gases (ABG) - HCO₃

Element Values:

Range: 00-50, 96, 97, 99
 00 Not injured
 01 Injured, ABGs not measured or reported
 02-50 Code the actual value of the HCO₃
 96 ABGs reported, HCO₃ unknown
 97 Injured, details unknown
 99 Unknown if injured

Source: Zone Center determined from official medical records.

Remarks:

The table below presents the normal measures of arterial blood gases followed by the definitions of these measures and other keywords.

Arterial Blood Gases (ABGs)

Measure	Normal	Respiratory acidosis	Respiratory alkalosis	Metabolic acidosis	Metabolic alkalosis
pH	7.35 to 7.45	Normal or decreased	Increased	Decreased	Increased
PO ₂	90 to 95 mm Hg	Decreased	Altered	Normal or increased	Normal or decreased
PCO ₂	34 to 46 mm Hg	Increased	Decreased	Decreased	Increased
HCO ₃	24 to 26 mEq/L	Increased	Decreased	Decreased	Increased
RR	10/min to 20/min	Irregular	Altered	Increased	Decreased

Definitions of Measures

pH -- the symbol relating the hydrogen ion (H⁺) concentration or activity of a solution to that of a given standard solution. Numerically the pH is approximately equal to the negative logarithm of H⁺ concentration expressed in molarity. pH 7 is neutral; above it alkalinity increases and below it acidity increases.

Variable Name: Arterial Blood Gases (ABGs) - HCO_3 (Cont'd.)

PO_2 , pO_2 , Po_2 -- oxygen partial pressure (tension).

PCO_2 , pCO_2 , Pco_2 -- carbondioxide partial pressure or tension.

HCO_3 -- bicarbonate radical.

RR -- Respiratory rate.

Alphabetical Definitions of Keywords

acidosis (as"i-do'sis) -- a pathologic condition resulting from accumulation of acid or depletion of the alkaline reserve (bicarbonate content) in the blood and body tissues, and characterized by an increase in hydrogen ion concentration (decrease in pH). **metabolic a.** -- a disturbance in which the acid-base status of the body shifts toward the acid side because of loss of base or retention of noncarbonic, or fixed (nonvolatile), acids; called also nonrespiratory a. **respiratory a.** -- a state due to excess retention of carbon dioxide in the body; called also hypercapnic a.

alkali (al'kah-li) -- any of a class of compounds which form soluble soaps with fatty acids ... and form soluble carbonates.

alkalosis (al"kah-lo'sis) -- a pathologic condition resulting from accumulation of base, or from loss of acid without comparable loss of base in the body fluids, and characterized by decrease in hydrogen ion concentration (increase in pH). **metabolic a.** -- a disturbance in which the acid-base status of the body shifts toward the alkaline side because of retention of base or loss of noncarbonic, or fixed (nonvolatile), acids. **respiratory a.** -- a state due to excess loss of carbon dioxide from the body.

anion (an'i-on) -- an ion carrying a negative charge owing to a surplus of electrons.

bicarbonate (bi-kar'bo-nat) -- any salt containing the HCO_3^- anion. **blood b.** -- the bicarbonate of the blood, an index of the alkali reserve.

ion (i'on) -- an atom or radical having a charge of positive (cation) or negative (anion) electricity owing to the loss (positive) or gain (negative) of one or more electrons.

mEq/L -- milliequivalent per liter: a milliequivalent is the number of grams of a solute contained in one milliliter of a normal solution; therefore, the normal range for the bicarbonate of blood is 0.024 - 0.026 grams per milliliter. Thus, for a thousand milliliters, the normal values become 24 to 26 grams.

Variable Name: Arterial Blood Gases (ABGs) - HCO₃ (Cont'd.)

Medical records often provide ABG information in a condensed format. For example, a medical record presented the ABG information as follows.

ABG: 7.56 / 25 / 171 / 100 %

This equates to: pH = 7.56; PCO₂ = 25; PO₂ = 171 -- at 100 percent saturation

In this example, the measure desired is not reported; use code "96" (ABGs reported, HCO₃ unknown). The measure of interest is the HCO₃ (also referred to as the bicarbonate). Researchers must look carefully at their reported ABGs to insure that the desired measure is being obtained. The closeness in range between the normal values of HCO₃ and PCO₂, makes mistaking them easy. In general, when ABGs are reported as a set of three values, consider them to be the pH, PO₂, and PCO₂.

Code "00" (Not injured) is used when the occupant sustained no injuries as a result of the accident. Use this code whenever OA43, Number of Recorded Injuries for This Occupant, equals "00" (No recorded injuries).

Code "01" (Injured, ABGs not measured or reported) is used when:

- the occupant is injured (i.e., OA43, Number of Recorded Injuries for This Occupant, equals "01"-"96") and
- (1) was not treated at a medical facility [i.e., OA50, Glasgow Coma Scale Score, equals "01" (Injured - not treated at medical facility)], or
- (2) was treated at a medical facility but no official medical records were obtained, or
- (3) no ABG measures are reported in any of the occupant's obtained official medical records.

Codes "02" through "50" are used to report the measured HCO₃ (bicarbonate) value obtained for this occupant. If multiple ABG HCO₃ values are reported, code the lowest value.

Code "96" (ABGs reported, HCO₃ unknown) is used when ABG value(s) are reported in this occupant's medical records but the HCO₃ measure is unknown.

Code "97" (Injured, details unknown) is used when the occupant is injured but the details are unknown. Use this code whenever OA43, Number of Recorded Injuries for This Occupant, equals "97" (Injured, details unknown).

Code "99" (Unknown if injured) is used when it is unknown if the occupant was injured. Use this code whenever OA43, Number of Recorded Injuries for This Occupant, equals "99" (Unknown if injured).

Variable Name: Primary Source of Belt Use Determination

Element Values:

- 0 Not equipped/not available/destroyed or rendered inoperative
- 1 Vehicle inspection
- 2 Official injury data
- 3 Driver/occupant interview
- 8 Other (specify):
- 9 Unknown if belt used

Source: Researcher determined

This variable is designed to provide the users with the primary source of information used by the researcher in determining if the vehicle occupants were restrained. Note: Do not use the police accident report as a source for coding this variable. If multiple sources of information are available, select codes in the order listed. Priority is given to the lower numbered code.

Code "0" (Not equipped/not available/destroyed or rendered inoperative) is used when the researcher determines from the vehicle inspection, interview, or medical sources that: (1) at the time of the accident the designated seating position, that the occupant was in, was not equipped with a manufacture installed or post manufacture installed manual or automatic belt (lap, shoulder, or lap and shoulder); (2) the occupant was not in a designated seating position (e.g., on the floor); (3) the occupant was not the person assigned the designated seating position and was not using a manual or automatic belt (e.g., sitting side-by-side); or (4) the manual or automatic belt, initially installed at this occupant's seating position, was subsequently removed, destroyed, or rendered inoperative (e.g., unbolted, cutout, etc.).

Code "1" (Vehicle inspection) is used when conclusive evidence from the vehicle inspection indicates that the occupant was or was not restrained by a manual or automatic belt at the time of the crash.

Code "2" (Official injury data) is used when information (e.g., injury patterns) from an autopsy report or hospital medical record indicates that the occupant was or was not restrained by a manual or automatic belt at the time of the crash. Code "1" above takes precedence over this code.

Code "3" (Driver/occupant interview) is used when the researcher is confident that reliable information from the driver or occupant interview indicates that the occupant was or was not restrained by a manual or automatic belt at the time of the crash. Codes "1" and "2" above take precedence over this code.

Code "8" [Other (specify)] is used when information from other official sources such as the EMS, fire department (e.g., rescue or extrication personnel), or on-scene photographs indicates that the occupant was or was not restrained by a manual or automatic belt at the time of the crash. Codes "1", "2", and "3" above take precedence over this code.

Variable Name: Primary Source of Belt Use Determination (Cont'd)

Code "9" (Unknown if belt used) is used when the researcher is not able to determine from available information if the occupant was or was not restrained by a manual or automatic belt at the time of the crash. This includes hit-and-run crashes. Codes "1", "2", "3", and "8" above take precedence over this code.



OCCUPANT INJURY FORM

1. Primary Sampling Unit Number _____	3. Vehicle Number _____
2. Case Number - Stratum _____	4. Occupant Number _____

INJURY DATA

Record below the actual injuries sustained by this occupant that were identified from the official and unofficial data sources. Remember not to double count an injury just because it was identified from two different sources. If greater than ten injuries have been documented, encode the balance on the Occupant Injury Supplement.

	Source of Injury Data	A.I.S. - 90					Injury Source Confidence Level	Injury Source	Direct/ Indirect Injury	Occupant Area Intrusion Number	
		Body Region	Type of Anatomic Structure	Specific Anatomic Structure	Level of Injury	A.I.S. Severity					Aspect
1st	5. ___	6. ___	7. ___	8. ___	9. ___	10. ___	11. ___	12. ___	13. ___	14. ___	15. ___
2nd	16. ___	17. ___	18. ___	19. ___	20. ___	21. ___	22. ___	23. ___	24. ___	25. ___	26. ___
3rd	27. ___	28. ___	29. ___	30. ___	31. ___	32. ___	33. ___	34. ___	35. ___	36. ___	37. ___
4th	38. ___	39. ___	40. ___	41. ___	42. ___	43. ___	44. ___	45. ___	46. ___	47. ___	48. ___
5th	49. ___	50. ___	51. ___	52. ___	53. ___	54. ___	55. ___	56. ___	57. ___	58. ___	59. ___
6th	60. ___	61. ___	62. ___	63. ___	64. ___	65. ___	66. ___	67. ___	68. ___	69. ___	70. ___
7th	71. ___	72. ___	73. ___	74. ___	75. ___	76. ___	77. ___	78. ___	79. ___	80. ___	81. ___
8th	82. ___	83. ___	84. ___	85. ___	86. ___	87. ___	88. ___	89. ___	90. ___	91. ___	92. ___
9th	93. ___	94. ___	95. ___	96. ___	97. ___	98. ___	99. ___	100. ___	101. ___	102. ___	103. ___
10th	104. ___	105. ___	106. ___	107. ___	108. ___	109. ___	110. ___	111. ___	112. ___	113. ___	114. ___

OFFICIAL INJURY DATA — SOFT TISSUE INJURIES

Indicate the Location, Specific Anatomic Structure, Detail (size, depth, fracture type, head injury clinical signs and neurological deficits), and Source of all injuries indicated by official sources (or from PAR or other unofficial sources if medical records and interviewee data are unavailable.)

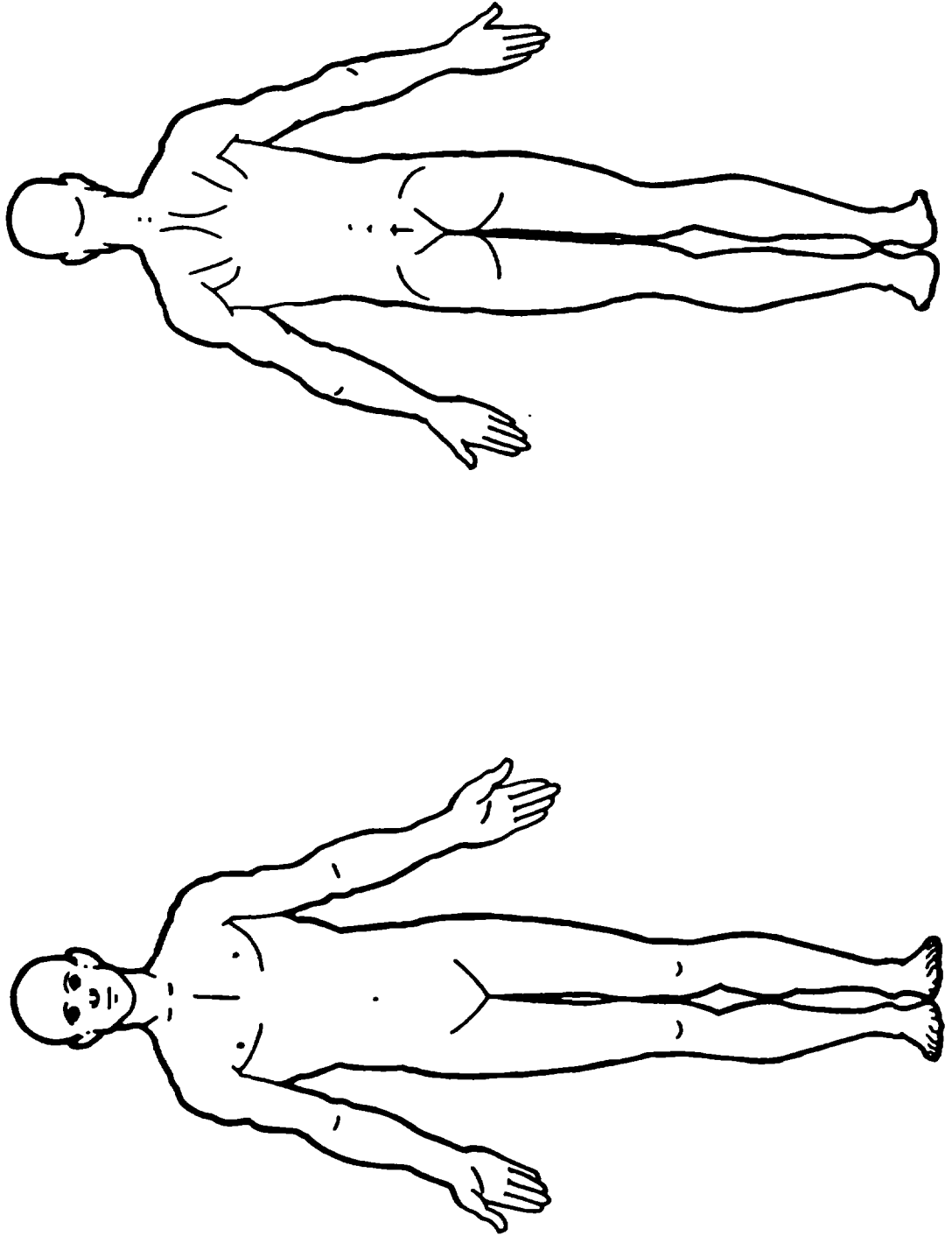

SOURCE OF INJURY DATA

OFFICIAL

- (1) Autopsy records with or without hospital/medical records
- (2) Hospital/medical records other than emergency room (e.g., discharge summary)
- (3) Emergency room records only (including associated X-rays or other lab reports)
- (4) Private physician, walk-in or emergency clinic

UNOFFICIAL

- (5) Lay coroner report
- (6) E.M.S. personnel
- (7) Interviewees
- (8) Other source (specify): _____
- (9) Police

INJURY SOURCE

FRONT

- (01) Windshield
- (02) Mirror
- (03) Sunvisor
- (04) Steering wheel rim
- (05) Steering wheel hub/spoke
- (06) Steering wheel (combination of codes 04 and 05)
- (07) Steering column, transmission selector lever, other attachment
- (08) Add on equipment (e.g., CB, tape deck, air conditioner)
- (09) Left instrument panel and below
- (10) Center instrument panel and below
- (11) Right instrument panel and below
- (12) Glove compartment door
- (13) Knee bolster
- (14) Windshield including one or more of the following: front header, A (A1/A2)-pillar, instrument panel, mirror, or steering assembly (driver side only)
- (15) Windshield including one or more of the following: front header, A (A1/A2) pillar, instrument panel, or mirror (passenger side only)
- (16) Driver side air bag compartment cover
- (17) Passenger side air bag compartment cover
- (18) Windshield reinforced by exterior object (specify): _____
- (19) Other front object (specify): _____

LEFT SIDE

- (20) Left side interior surface, excluding hardware or armrests
- (21) Left side hardware or armrest
- (22) Left A (A1/A2)-pillar
- (23) Left B-pillar
- (24) Other left pillar (specify): _____

- (25) Left side window glass or frame
- (26) Left side window glass including one or more of the following: frame, window sill, A (A1/A2)-pillar, B-pillar, or roof side rail.
- (27) Other left side object (specify): _____

- (28) Left side window sill

RIGHT SIDE

- (30) Right side interior surface, excluding hardware or armrests
- (31) Right side hardware or armrest
- (32) Right A (A1/A2)-pillar
- (33) Right B-pillar
- (34) Other right pillar (specify): _____

- (35) Right side window glass or frame
- (36) Right side window glass including one or more of the following: frame, window sill, A (A1/A2)-pillar, B-pillar, or roof side rail.
- (37) Other right side object (specify): _____

- (38) Right side window sill

INTERIOR

- (40) Seat, back support
- (41) Belt restraint webbing/buckle
- (42) Belt restraint B-pillar or door frame attachment point
- (43) Other restraint system component (specify): _____
- (44) Head restraint system
- (45) Air bag (use codes "16" and "17" for injuries sustained from air bag compartment covers)
- (46) Other occupants (specify): _____
- (47) Interior loose objects
- (48) Child safety seat (specify): _____
- (49) Other interior object (specify): _____

ROOF

- (50) Front header
- (51) Rear header
- (52) Roof left side rail
- (53) Roof right side rail
- (54) Roof or convertible top

FLOOR

- (56) Floor (including toe pan)
- (57) Floor or console mounted transmission lever, including console
- (58) Parking brake handle
- (59) Foot controls including parking brake

REAR

- (60) Backlight (rear window)

- (61) Backlight storage rack, door, etc.
- (62) Other rear object (specify): _____

EXTERIOR of OCCUPANT'S VEHICLE

- (65) Hood
- (66) Outside hardware (e.g., outside mirror, antenna)
- (67) Other exterior surface or tires (specify): _____
- (68) Unknown exterior objects

EXTERIOR OF OTHER MOTOR VEHICLE

- (70) Front bumper
- (71) Hood edge
- (72) Other front of vehicle (specify): _____
- (73) Hood
- (74) Hood ornament
- (75) Windshield, roof rail, A-pillar
- (76) Side surface
- (77) Side mirrors
- (78) Other side protrusions (specify)

- (79) Rear surface
- (80) Undercarriage
- (81) Tires and wheels
- (82) Other exterior of other motor vehicle (specify): _____

- (83) Unknown exterior of other motor vehicle

OTHER VEHICLE OR OBJECT IN THE ENVIRONMENT

- (84) Ground
- (85) Other vehicle or object (specify) _____
- (86) Unknown vehicle or object

NONCONTACT INJURY

- (90) Fire in vehicle
- (91) Flying glass
- (92) Other noncontact injury source (specify): _____
- (93) Air bag exhaust gases
- (97) Injured, unknown source

INJURY SOURCE CONFIDENCE LEVEL

- (1) Certain
- (2) Probable
- (3) Possible
- (9) Unknown

DIRECT/INDIRECT INJURY

- (1) Direct contact injury
- (2) Indirect contact injury
- (3) Noncontact injury
- (7) Injured, unknown source

OCCUPANT INJURY CLASSIFICATION

Body Region	Specific Anatomic Structure	Spine	Abbreviated Injury Scale
(1) Head	<u>Whole Area</u>	(02) Cervical	(1) Minor injury
(2) Face	(02) Skin - Abrasion	(04) Thoracic	(2) Moderate injury
(3) Neck	(04) Skin - Contusion	(06) Lumbar	(3) Serious injury
(4) Thorax	(06) Skin - Laceration	<u>Vessels, Nerves, Organs, Bones, Joints are assigned consecutive two digit numbers beginning with 02</u>	(4) Severe injury
(5) Abdomen	(08) Skin - Avulsion	<u>Level of Injury</u>	(5) Critical injury
(6) Spine	(10) Amputation	Specific injuries are assigned consecutive two-digit numbers beginning with 02.	(6) Maximum (untreatable)
(7) Upper Extremity	(20) Burn	To the extent possible, within the organizational framework of the AIS, 00 is assigned to an injury NFS as to severity or where only one injury is given in the dictionary for that anatomic structure. 99 is assigned to any injury NFS as to lesion or severity.	(7) Injured, unknown severity
(8) Lower Extremity	(30) Crush		<u>Aspect</u>
(9) Unspecified	(40) Degloving		(1) Right
<u>Type of Anatomic Structure</u>	(50) Injury - NFS		(2) Left
(1) Whole Area	(90) Trauma, other than mechanical		(3) Bilateral
(2) Vessels	<u>Head - LOC</u>		(4) Central
(3) Nerves	(02) Length of LOC		(5) Anterior
(4) Organs (includes muscles/ligaments)	(04, 06, 08) Level of Consciousness		(6) Posterior
(5) Skeletal (includes joints)	(10) Concussion		(7) Superior
(6) Head - LOC			(8) Inferior
(9) Skin			(9) Unknown
			(0) Whole region

OFFICIAL INJURY DATA — SKELETAL INJURIES

Indicate the Location, Specific Anatomic Structure, Detail (size, depth, fracture type, fracture type, head injury clinical signs and neurological deficits), and Source of all injuries indicated by official sources (or from PAR or other unofficial sources if medical records and interviewee data are unavailable.)

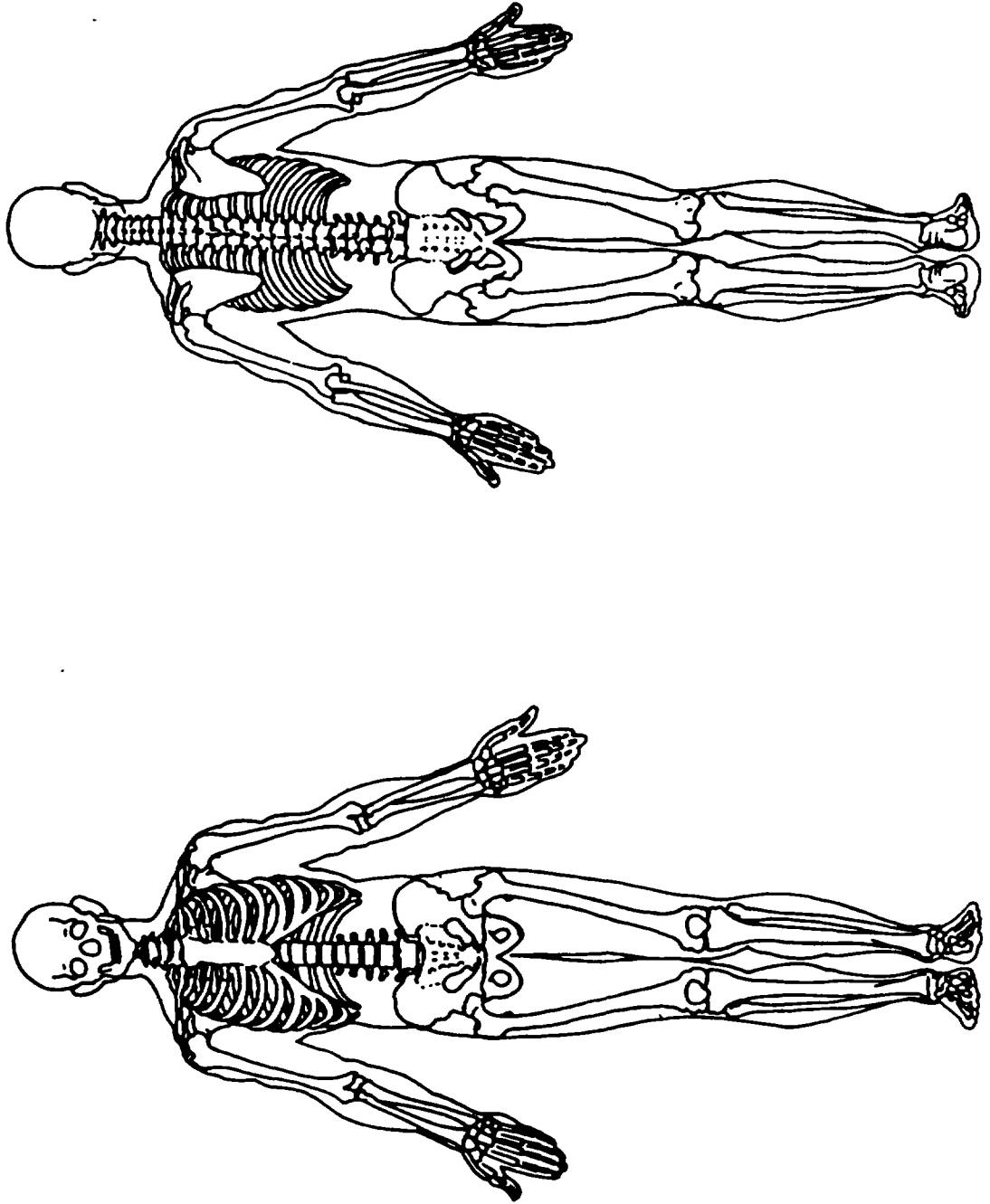

Restrained?
 ___ No
 ___ Yes

Blood Alcohol Level (mg/dl)
 BAL = _____

Glasgow Coma Scale Score
 GCSS = _____

Units of Blood Given
 Units = _____

Arterial Blood Gases
 pH = _____
 PO₂ = _____
 PCO₂ = _____
 HCO₃ = _____

OFFICIAL INJURY DATA – INTERNAL INJURIES

Indicate the Location, Specific Anatomic Structure, Detail (size, depth, fracture type, head injury clinical signs and neurological deficits), and Source of all injuries indicated by official sources (or from PAR or other unofficial sources if medical records and interviewee data are unavailable.)

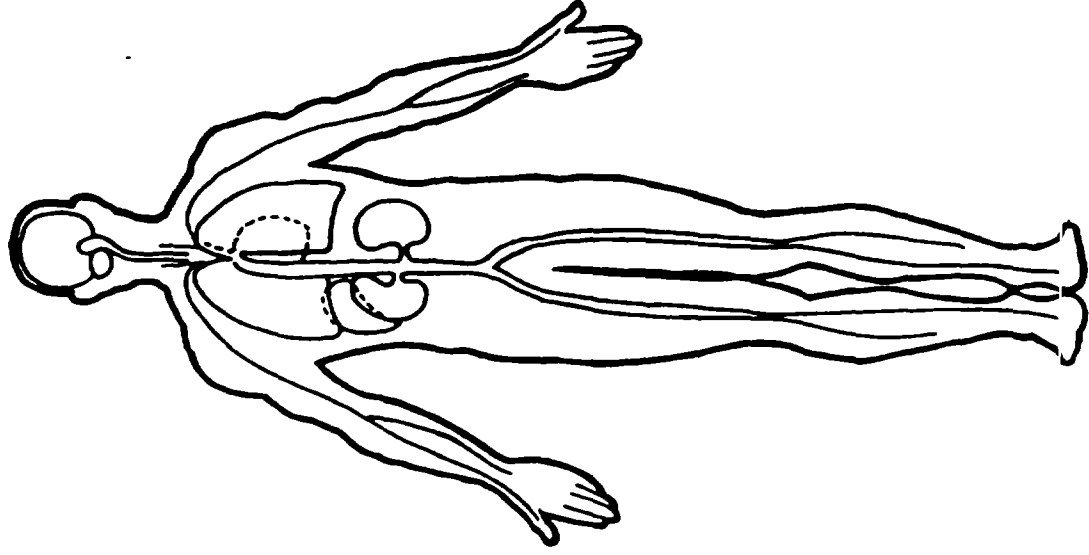
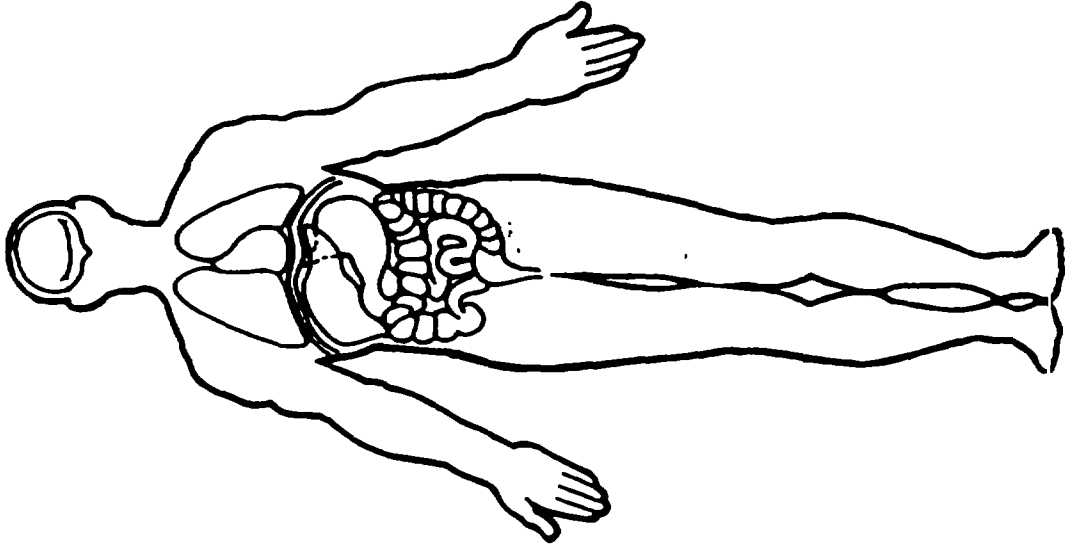



OCCUPANT INJURY LOG

TO BE COMPLETED BY ZONE CENTER	SECOND LEVEL REVIEW																																																									
<p>1. PSU Number _____</p> <p>2. Case Number—Stratum _____</p> <p>3. Vehicle Number _____</p> <p>4. Occupant Number _____</p> <p>5. Documentation of Interview Data on Manikin/Listing _____ (0) Not applicable (1) Substandard - beyond researcher control (2) Substandard (3) Standard</p>	<p>16. Documentation of Official Data on Manikin _____ (0) Not applicable (1) Substandard - beyond researcher control (2) Substandard (3) Standard</p> <p style="text-align: right;">AIS AIS 1-7 3-8</p> <p>17. Number of Rows Added by Second Level Reviewer _____</p> <p>18. Number of Rows Deleted by Second Level Reviewer _____</p>																																																									
INJURY INFORMATION CODING	ERROR STATUS FOR INJURY VARIABLES																																																									
<table style="width:100%; border-collapse: collapse;"> <thead> <tr> <th style="width:60%;"></th> <th style="width:20%; text-align: center;">Injury Information</th> <th style="width:20%; text-align: center;">Contact Mechanisms & Intrusions</th> </tr> </thead> <tbody> <tr> <td>6. Date Data Included With Initial Submission Coded _____</td> <td style="text-align: center;">___/___/___</td> <td style="text-align: center;">___/___/___</td> </tr> <tr> <td>7. Coded By (Initials) _____</td> <td style="text-align: center;">_____</td> <td style="text-align: center;">_____</td> </tr> <tr> <td>8. Date Update Received _____</td> <td style="text-align: center;">___/___/___</td> <td style="text-align: center;">___/___/___</td> </tr> <tr> <td></td> <th style="text-align: center;">Injury Information</th> <th style="text-align: center;">Contact Mechanisms & Intrusions</th> </tr> <tr> <td>9. Date Data Included With Updated Submission Coded _____</td> <td style="text-align: center;">___/___/___</td> <td style="text-align: center;">___/___/___</td> </tr> <tr> <td>10. Coded By (Initials) _____</td> <td style="text-align: center;">_____</td> <td style="text-align: center;">_____</td> </tr> <tr> <td></td> <td></td> <td style="text-align: center;">AIS AIS 1-7 3-8</td> </tr> <tr> <td>11. Number of Injury Rows Coded _____</td> <td style="text-align: center;">_____</td> <td style="text-align: center;">_____</td> </tr> <tr> <td>12. Number of Unknown Injuries _____</td> <td style="text-align: center;">_____</td> <td style="text-align: center;">_____</td> </tr> <tr> <td>13. Number of Unknown Injury Contact Mechanisms _____</td> <td style="text-align: center;">_____</td> <td style="text-align: center;">_____</td> </tr> </tbody> </table>		Injury Information	Contact Mechanisms & Intrusions	6. Date Data Included With Initial Submission Coded _____	___/___/___	___/___/___	7. Coded By (Initials) _____	_____	_____	8. Date Update Received _____	___/___/___	___/___/___		Injury Information	Contact Mechanisms & Intrusions	9. Date Data Included With Updated Submission Coded _____	___/___/___	___/___/___	10. Coded By (Initials) _____	_____	_____			AIS AIS 1-7 3-8	11. Number of Injury Rows Coded _____	_____	_____	12. Number of Unknown Injuries _____	_____	_____	13. Number of Unknown Injury Contact Mechanisms _____	_____	_____	<p style="text-align: center;">ERROR STATUS FOR INJURY VARIABLES</p> <p>Coding Errors (total number in each column)</p> <table style="width:100%; border-collapse: collapse; text-align: center;"> <tr> <td style="width:5%;"></td> <td style="width:5%;">5</td> <td style="width:5%;">6</td> <td style="width:5%;">7</td> <td style="width:5%;">8</td> <td style="width:5%;">9</td> <td style="width:5%;">10</td> <td style="width:5%;">11</td> <td style="width:5%;">12</td> <td style="width:5%;">13</td> <td style="width:5%;">14</td> <td style="width:5%;">15</td> </tr> <tr> <td></td> <td style="border: 1px solid black; width: 20px; height: 20px;"></td> <td style="border: 1px solid black; width: 20px; height: 20px;"></td> <td style="border: 1px solid black; width: 20px; height: 20px;"></td> <td style="border: 1px solid black; width: 20px; height: 20px;"></td> <td style="border: 1px solid black; width: 20px; height: 20px;"></td> <td style="border: 1px solid black; width: 20px; height: 20px;"></td> <td style="border: 1px solid black; width: 20px; height: 20px;"></td> <td style="border: 1px solid black; width: 20px; height: 20px;"></td> <td style="border: 1px solid black; width: 20px; height: 20px;"></td> <td style="border: 1px solid black; width: 20px; height: 20px;"></td> <td style="border: 1px solid black; width: 20px; height: 20px;"></td> </tr> </table> <p>19. Date Of Second Level Review _____/_____/_____</p> <p>20. Reviewed By (Initials) _____</p>		5	6	7	8	9	10	11	12	13	14	15												
	Injury Information	Contact Mechanisms & Intrusions																																																								
6. Date Data Included With Initial Submission Coded _____	___/___/___	___/___/___																																																								
7. Coded By (Initials) _____	_____	_____																																																								
8. Date Update Received _____	___/___/___	___/___/___																																																								
	Injury Information	Contact Mechanisms & Intrusions																																																								
9. Date Data Included With Updated Submission Coded _____	___/___/___	___/___/___																																																								
10. Coded By (Initials) _____	_____	_____																																																								
		AIS AIS 1-7 3-8																																																								
11. Number of Injury Rows Coded _____	_____	_____																																																								
12. Number of Unknown Injuries _____	_____	_____																																																								
13. Number of Unknown Injury Contact Mechanisms _____	_____	_____																																																								
	5	6	7	8	9	10	11	12	13	14	15																																															
UPDATED MDE STATUS																																																										
<p>14. Date MDE Updated _____/_____/_____</p> <p>15. MDE Updated By (Initials) _____</p>																																																										

INJURY DATA OVERVIEW

The Occupant Injury Form is a complete coded reduction of all injuries sustained by each injured occupant of a towed CDS applicable vehicle or a nontowed CDS applicable AOPS vehicle. The injuries are reported using a series of numeric codes to form a description of the injury, its severity, and associated information. The associated information includes the source of the injury data, the source of the injury, the confidence the Zone Center coder has in assigning that particular injury source, the directness of the injury as a result of a remotely applied force, and the relatedness of the injury to a vehicle intrusion. These data are grouped by columns and titles as seen on the form. The variable numbers are consecutive, and there is no theoretical upper limit to the number of injuries that can be coded.

Historically, injury information has provided a measure of the severity of the accident from the occupant's frame of reference. Beginning in 1993 the NASS CDS adopted the Association for the Advancement of Automotive Medicine's (AAAM) Abbreviated Injury Scale 1990 Revision (AIS 90), with a minor modification to include the injury aspect. The 1993 NASS CDS version of AIS 90 describes an injury and its severity based on an 8 digit numeric coding system. It includes the Body Region, Type of Anatomic Structure, Specific Anatomic Structure, Level of Injury, AIS Severity, and Aspect. This provides a complete coded description of the injury in an analyzable format that is widely accepted and can be compared against other injury assessment studies.

In past accident research, injury information by itself was often used as a measurement scale but still was incomplete in that the mechanism causing the injury was unknown. To rectify this situation, the early NASS included variables to report the object which caused the injury and later added variables to report whether the object intruded into the occupant's seating position and whether or not the injury was caused by direct contact with the object. Since the codes for these variables are based at times on less than concrete evidence, it was necessary to evaluate the reliability of the data by adding a variable for confidence level.

The availability of reliable injury information has long been a concern. In many of the prior accident research studies, injury data were accepted only from a medically qualified source such as a hospital or a physician. Problems in acquiring the injury information from official medical sources have led to allowing the researcher to obtain injury descriptions from the occupant or selected surrogates (e.g. Interviewee injury information). In allowing interviewee injury information, it was necessary to segregate the data by source since interviewee information are known to be less than totally reliable at times. The variable "Source of Injury Data" answers this need.

The addition of these associated variables to the coded injuries (AIS 90) has created a data base which can be analyzed for direct evaluation of some of the Federal Motor Vehicle Safety Standards (FMVSS). These standards came into being because of concerns about the injuries sustained in accidents in the early 1960's. Areas such as driver education and training and driver licensing criteria were found to be an inefficient means of reducing injuries to accident victims on the highways. This left occupant protection and injury reduction as the areas to focus upon. Attention was focused on the vehicle. Hard,

INJURY DATA OVERVIEW

unforgiving interior surfaces were removed; steering columns were designed to collapse into the engine compartment rather than impale the driver, and many of the projecting knobs and other surfaces were rounded, moved, or softened. Vehicles were designed to absorb the impact forces rather than transfer the force to the occupants. Many other improvements in overall vehicle design have taken place to satisfy the requirements specified by the FMVSS. These improvements were implemented by the automobile manufacturers and are monitored and tested by NHTSA. Much of the monitoring now comes from analyzing data provided by real world experience. All the standards can be evaluated to some extent using data from these variables.

Analysts may use these data to identify the injury severity levels of accidents, search for particular injury sources, determine direct versus indirect injury mechanism ratios, relate percentage of injuries by Body Region, Type of Anatomic Structure, Specific Anatomic Structure, Level of Injury, AIS severity level, and Aspect, and compare many other data combinations. These relationships can be determined by using the data from these variables. Comparisons with other variable groups can also be used to explore additional relationships. For example, comparisons of restraint use versus type of injuries (Type of Anatomic structure, Specific Anatomic structure, AIS level, etc) should show a direct correlation between restraint use and injury reduction. If such a correlation is not demonstrated, further exploration into the data and possibly additional detailed analyses are needed. Addition of delta V (change in velocity) levels to the comparison might show that at some speeds (e.g. very low and very high), the injury levels are the same regardless of restraint use. To continue the analyses, type of injury would be examined in the areas where AIS levels are the same. Also, the number of injuries would be a relevant data item for inclusion in the comparison.

All of the above mentioned comparisons and analyses are just a few examples of the uses for the data that are encoded here. For the Zone Center, these variables, for the most part, represent a distillation of several data sources. The injuries are coded from information found on the medical records, supplemented by the interviewee descriptions. The Injury Source and Occupant Area Intrusion Number will be obtained from the inspection of the vehicle interior. Injury Source Confidence Level and Direct/Indirect Injury are based on the Zone Center's assessment of all available information. The Zone Center's determination of injury source is derived primarily from vehicle data, occupant kinematics, interview data and official medical records.

INJURY DATA OVERVIEW**Official Injury Data Documentation on Diagrams
Specific Medical Record Data Used in Coding AIS 90**

The injury data from official medical records should be indicated on the appropriate diagram. There are three *Official Injury Data* diagrams. The first, for soft tissue injuries, is on **Page 2** of the Occupant Injury Form. The second, on **Page 3**, is for skeletal injuries; the third, on the reverse of **Page 3**, is for injuries to internal organs. Injuries should be clearly and precisely located on the diagrams, and the medical record classification of the injury and its extent should be completely annotated. All data used to code the AIS 90 version of injuries [e.g., size of lacerations, the first observed level of consciousness by a medical authority, loss of consciousness, size of hematoma or hemothorax (in "cc"s of blood), etc.] should be written on the diagram.

INJURY DATA OVERVIEW

NASS CDS Injury Information Coding

Beginning in data collection year 1993 the Zone Centers will code all NASS CDS injury information. In support of this effort, the NASS CDS Primary Sampling Units (PSU) are required to follow the protocol outlined below:

- Review all sources of crash information (i.e., police reports, newspapers, medical records, interview information, etc.) that will support injury coding and extract and code useful data on demographics and crash circumstances, including occupant information, restraint data, alcohol and injury consequences;
- Obtain and complete the interview injury information on the Interview Form manikin;
- Obtain and submit any official medical records as initial or update submissions (see procedure on next page);
- Continuously track the acquisition of medical records and report any significant delays to the Zone Center;
- Immediately report any changes in hospital cooperation which affect timeliness of submission and/or quality of data to the Zone Center and COTR.
- Thoroughly examine and document the interior and exterior of the vehicle for occupant contact points.
- Complete the Vehicle Interior Sketch on page 4 of the Interior Vehicle Form. Be sure to note areas of ejection and/or entrapment.
- Obtain all required photographs for case documentation and submission (see NASS Vehicle Photography Guideline requirements).
- Contact points must be highlighted with incremented tape.
- Document up to fifteen (ten are coded) most severe intrusions on the Intrusion Work Sheet on the back of page 1 of the Interior Vehicle Form.
- Intruded areas must be sketched.
- All areas where an occupant contact is known or suspected must be annotated.

INJURY DATA OVERVIEW**PSU Procedure For Submission of Official Injury Information**

Beginning in data collection year 1993 the Zone Centers will code all NASS CDS injury information. In support of this effort, the NASS CDS Primary Sampling Units (PSU) are required to submit all official injury information following the protocol outlined below:

Initial Submissions of Official Injury Records:

- The team shall print the following information on each official injury record:

PSU and Case Number,
Vehicle Number, and
Occupant Number.

- The teams shall enclose all of the official injury information record(s) in a 9 x 12 inch manilla envelope for each case.
- The team shall include the following information for each official injury record on the envelope. A pre-printed label (see Figure 1 on next page) will be provided by Headquarters. One Label per injured occupant shall be completed.

PSU and Case Number,
Vehicle Number,
Occupant Number, and
Type of Medical(s) enclosed.

- The envelope shall then be included with the casework after the last Occupant Assessment Form(s).
- Administrative Log-A variable ADL16 (Injury Coding Required?) must be coded as "1" (Yes).
- Occupant Assessment Log variable OAL14 (Was This Occupant Injured?) must be coded as "1" (Yes).

Update Submissions

If an official injury information record was submitted with the initial submission then complete the following:

- The team shall print the following information on each official injury record:

PSU and Case Number,
Vehicle Number, and
Occupant Number.

MEDICAL ENVELOPE INJURY LABEL

U.S. DOT/NHTSA

NASS/CDS

INJURY INFORMATION

TO BE COMPLETED BY TEAM

- 1. PSU Number ___
- 2. Case Number—Stratum ___
- 3. Vehicle Number ___
- 4. Occupant Number ___
- 5. Type of Medical Information
 - Official*
 - a. Autopsy (invasive examination) ___
 - b. Post-ER medical record which includes information about death based on non-invasive examination ___
 - c. Admission record/summary or admission/discharge face sheet ___
 - d. Discharge summary ___
 - e. Operative report ___
 - f. Radiographic record(s) (X-ray, CT scan) ___
 - g. History and physical examination and/or consultation records ___
 - h. Emergency room records (includes nurses' notes) ___
 - j. Private physician ___
 - Unofficial*
 - k. Lay Coroner ___
 - l. EMS record ___

HS Form 431G (1/94)

Figure 1

PSU
For code "5", check each type of document included with your initial case submission.

Zone Center
Add check marks as needed to reflect additional types of medical records obtained through the update process.

INJURY DATA OVERVIEW

PSU Procedure For Submission of Official Injury Information (Continued)

Update Submissions (Continued)

- The official injury information record(s) shall be attached to the back of a completed Update Form (HS Form 433C). These updates shall be submitted in accordance with procedures listed in section 5.2 (Case Submission -- Case Envelope). See page 81, paragraph 7.

If an official injury information record was not submitted with the initial submission then complete the following:

The team shall print the following information on each official injury record:

PSU and Case Number,
Vehicle Number, and
Occupant Number.

The teams shall enclose all of the official injury information record(s) in a 9 x 12 inch manilla envelope for each case.

The team shall include the following information for each official injury record on the envelope. A pre-printed label will be provided by Headquarters. One label per injured occupant shall be used.

PSU and Case Number,
Vehicle Number,
Occupant Number, and
Type of Medical(s) enclosed.

The envelope containing the official injury information record(s) for this case shall be attached to the back of a completed Update Form(s) (HS Form 433C). These update envelopes shall be combined with all other updates and submitted in accordance with procedures listed in section 5.2 (Case Submission -- Case Envelope). See page 81, paragraph 7.

INJURY DATA OVERVIEW**NASS CDS PSU Official Medical Record Acquisition Procedure**

The procedure that shall be followed by NASS CDS PSUs for obtaining official medical records from medical facilities for injured accident victims are as follows:

1. Review the police accident report (PAR) for occupant injury status to determine the vehicle occupants for which an official medical record should be obtained.
2. Request official medical records within two days of the sample date for each injured occupant of a CDS applicable vehicle where a patient release form is not required.
3. Review the injury information on the Interview Form obtained from interviewees and other unofficial sources to ascertain if any occupant of a CDS applicable vehicle received treatment from a medical facility or physician, including follow-up treatment. Ensure that official injury records have been requested or obtained. Obtain a signed medical release form if required.
4. Verify that the facility listed by the interviewee is consistent with the facility from which records were originally requested.
5. Review the official medical record to determine if all applicable records are obtained (i.e., a Discharge Summary is required for admitted occupants). If required, request additional records immediately.
6. For teams that transcribe medical data, if the official medical record indicates a possible injury source (i.e., specific vehicle component or other object), the researcher must ensure that the data is part of the injury documentation.

NASS CDS Official Medical Record Coding Procedure

1. Review the official medical record for information such as names, addresses, and phone numbers that will help in contacting occupants or locating vehicles.
2. Review the official medical record for information to code the alcohol and drug variables.
3. Review the official medical record obtained to determine the treatment level or mortality of this occupant.

INJURY DATA OVERVIEW**NASS Zone Center Injury Coding Overview**

The Zone Centers are required to follow the protocol outlined below for completion of injury information coding.

- All injury information will be coded by Zone Center personnel and selected qualified PSU researchers trained in AIS 90 coding procedures. Qualified PSU researchers are selected for injury coding at the discretion of their respective Zone Center with COTR approval;
- No Zone Center Team Coordinator shall code more than 50% of their assigned team cases;
- Injury mechanisms shall be assigned by team coordinators or other senior case reviewers;
- Zone Centers shall code the following Occupant Assessment Form variables:

- OA39 Time to Death;
- OA40-42 Medically Reported Cause(s) of Death;
- OA43 Number of Recorded Injuries for this Occupant;
- OA50 Glasgow Coma Scale (GCS) Score;
- OA51 Was the Occupant given Blood?, and;
- OA52 Arterial Blood Gases (ABG) - HCO₃.

- If all of the applicable injury information is submitted with the case then the injury information shall be added to a case within 30 days of the date the hard copy is received at the Zone Center. Injury information submitted as an "update" shall be coded within 2 weeks of receipt, and;
- The Zone Center shall be responsible for identification of cases with injury information and log data record keeping.

NASS Zone Center Quality Assurance Measures:

- An in-house review of injury information coded by the Zone Center injury staff (including coordinators) shall be made by an expert injury coding reviewer on 10% of cases coded, and;
- A sample of approved cases will be selected by NCSA to be shipped to the Field Operations Branch for review and evaluation. This includes copying and submitting cases to the other Zone Center for comparison coding. The final coding of each of the Zone Centers will be analyzed by the staff of the Field Operations Branch. Coding inconsistencies will then be discussed with the two Zone Centers and corrective measures taken if appropriate.

INJURY DATA OVERVIEW**NASS Zone Center Injury Coding Procedures**

The procedure that shall be followed by NASS Zone Centers in performing the injury coding tasks are as follows:

1. Determine if the official medical record(s) obtained are appropriate for this occupant. Correct or update the Occupant Assessment Log Form.
2. Review the official medical records to identify NASS codable injuries as defined in the NASS Injury Coding Manual. Highlight or underline these injuries.
3. Review the Interview Form for injury data from interviewees and other unofficial sources to ascertain NASS codable injuries. Verify that all required information is transcribed onto the unofficial data manikin. Make corrections as needed.
4. Combine and review the official and unofficial injury information to determine which injuries should be coded on the Occupant Injury Form.

Occupant Injury Form

5. List the NASS codable injuries on the "Official Manikin" of the Occupant Injury Form. Include all the information required to meet the NASS standard specified in the Documentation of Official Data on Manikin.
6. Code all the injuries on the Occupant Injury Form using the most current version of the NASS Injury Coding Manual as the primary source.
7. Determine the injury source mechanisms for all injuries. Evaluate the vehicle inspection information, including the PDOF, the interior vehicle damage sketches, the occupant contact points, the restraint information, and the photographic documentation to identify injury mechanisms for each injury. Make corrections as needed.
8. Determine and code the confidence level of the injury source for each line of injury coded.

Interior Vehicle Form

9. Verify the accuracy of the coded occupant area intrusions. Make corrections as needed and complete the appropriate Interior Vehicle Log variables.

INJURY DATA OVERVIEW

NASS Zone Center Injury Coding Procedures (Continued)

10. Determine if an injury resulted from an intruded component. Compare the injury and injury source to the "Occupant Area Intrusion" and the "Intrusion Work Sheet" of the Interior Vehicle Form.

Occupant Injury Form

11. Code the "Occupant Area Intrusion Number" from the "Occupant Area Intrusion" information on the Interior Vehicle Form.
12. Complete the Occupant Injury Log information.
13. Check all updatable variables and recode based on injury information reviewed.

Variable Name: Source of Injury Data
(1st through 10th or higher)

Element Values:

Official	Unofficial
1 Autopsy records with or without hospital/medical records	5 Lay coroner report
2 Hospital/medical records other than emergency room (e.g., discharge summary)	6 E.M.S. personnel
3 Emergency room records only (including associated x-rays or other lab reports)	7 Interviewee
4 Private physician, walk-in or emergency clinic	8 Other source (specify)
	9 Police

Source: Element chosen

Remarks:

Code "1" (Autopsy records with or without hospital/medical records) excludes records from lay, nonmedical personnel; they must be the result of an autopsy by a physician or other similarly qualified life scientist. A non-invasive external examination by a physician, though, should be coded either "2" (Hospital medical records other than emergency room) or "4" (Private physician, walk-in or emergency clinic) since it is generally a superficial listing of external injuries and possible internal injuries; therefore, injuries from a non-invasive exam should not be grouped with those from a thorough autopsy report.

Code "2" [Hospital/medical records other than emergency room (e.g., discharge summary)] is used whenever the injury is listed on the official post-emergency room records of a hospital or medical facility. If the injury was also listed on a facility's associated emergency room records, then the "2" code takes precedence. If the injury is also contained in an autopsy record--where the autopsy was performed by a physician or similarly qualified life scientist--then, code "1" (Autopsy records with or without hospital/medical records) takes precedence. However, this code includes non-invasive (external) examinations conducted by a physician on a deceased victim and documented as a hospital or medical examiner's record.

Code "3" [Emergency room records only (including associated x-rays or other lab reports)] is used when the injury only appears on a facility's emergency room record or on records that were completed in support of the person's examination in an emergency room. For example, an x-ray report that was completed because the emergency room physician requested it as a part of his/her examination would be included under

Variable Name: Source of Injury Data
(1st through 10th or higher)

this code. This code should not be used if the injury is subsequently listed on a post-emergency room record in a medical autopsy.

If both types of records (emergency room and post-emergency room) refer to the same injury, code "2" [Hospital/medical records other than emergency room (e.g., discharge summary)] is used as the code even if the detail provided on the emergency room records exceeds the detail provided on the post-emergency room records.

Code "4" (Private physician, walk-in or emergency clinic) refers to any physician (in private practice) who saw the injured person and who has records of that treatment (i.e., other than hospital or autopsy records). Also included in this code are non-invasive (external) examinations conducted by a private physician or similarly qualified life scientist on a deceased victim and documented as other than a hospital record (e.g., coroner's report).

In summary, examinations of deceased persons are distinguished first by qualifications of examiner [official (codes "1", "2", and "4") versus unofficial (code "5")], second by the type of examination [autopsy (code "1") versus non-invasive (codes "2" or "4")], and third by type of examination record [hospital (code "2") versus other than hospital (code "4")].

Code "5" (Lay coroner report) is used if the injury data is contained in a report where a non-invasive examination of the deceased was performed a non-physician, or lay coroner.

Code "6" (E.M.S. personnel) refers to a person certified by the state as trained in emergency medical service techniques. This code should not be used for ambulance attendants, police, or other personnel not trained in E.M.S. techniques.

Code "7" (Interviewee) refers to the person who was interviewed to get the information on this form (not necessarily the person described on this form). The interviewee is defined in a log variable.

Code "8" (Other source) is used when data are obtained from an unofficial source different from those explicitly listed above (e.g., chiropractors).

Code "9" (Police) can be used, but only when no other source of injury information is available.

Variable Name: Body Region
(1st through 10th or higher)

Element Values:

- 1 Head
- 2 Face
- 3 Neck
- 4 Thorax
- 5 Abdomen
- 6 Spine
- 7 Upper Extremity
- 8 Lower Extremity
- 9 Unspecified

Source: Variables OI05 et al., respectively

Remarks:

The 1993 NASS Injury Coding Manual contains a listing of most injuries. Use the manual to code, for each injury, its body region and record it on the form

Variable Name: Type of Anatomic Structure
(1st through 10th or higher)

Element Values:

- 1 Whole Area
- 2 Vessels
- 3 Nerves
- 4 Organs (includes muscles/ligaments)
- 5 Skeletal (includes joints)
- 6 Head - LOC
- 9 Skin

Source: Variables OI05 et al., respectively

Remarks:

The 1993 NASS Injury Coding Manual contains a listing of most injuries. Use the manual to code, for each injury, its type of anatomic structure and record it on the form.

Variable Name: Specific Anatomic Structure
(1st through 10th or higher)

Element Values:

Whole Area

02 Skin - Abrasion
04 Skin - Contusion
06 Skin - Laceration
08 Skin - Avulsion
10 Amputation
20 Burn
30 Crush
40 Degloving
50 Injury - NFS
90 Trauma, other than mechanical

Head - LOC

02 Length of LOC
04, 06, 08 Level of Consciousness
10 Concussion

Spine

02 Cervical
04 Thoracic
06 Lumbar

Vessels, Nerves, Organs, Bones,

Joints are assigned consecutive
two digit numbers beginning with 02

Source: Variables OI05 et al., respectively

Remarks:

The 1993 NASS Injury Coding Manual contains a listing of most injuries. Use the manual to code, for each injury, its specific anatomic structure and record it on the form.

Variable Name: Level of Injury
(1st through 10th or higher)

Element Values:

Specific injuries are assigned consecutive two-digit numbers beginning with 02.

To the extent possible, within the organizational framework of the AIS, 00 is assigned to an injury NFS as to severity or where only one injury is given in the dictionary for that anatomic structure. 99 is assigned to any injury NFS as to lesion or severity.

Source: Variables 0I05 et al., respectively

Remarks:

The 1993 NASS Injury Coding Manual contains a listing of most injuries. Use the manual to code, for each injury, its level of injury and record it on the form.

OCCUPANT INJURY FORM

OI10
et al.

Variable Name: Abbreviated Injury Scale
(1st through 10th or higher)

Element Values:

- 1 Minor injury
- 2 Moderate injury
- 3 Serious injury
- 4 Severe injury
- 5 Critical injury
- 6 Maximum (untreatable)
- 7 Injured, unknown severity

Source: Variables OI05 et al., respectively

Remarks:

The 1993 NASS Injury Coding Manual contains a listing of most injuries. Use the manual to code, for each injury, its A.I.S. value and record it on the form.

Variable Name: Aspect
(1st through 10th or higher)

Element Values:

- 1 Right
- 2 Left
- 3 Bilateral
- 4 Central
- 5 Anterior
- 6 Posterior
- 7 Superior
- 8 Inferior
- 9 Unknown
- 0 Whole region

Source: Variables OI05 et al., respectively

Remarks:

The 1993 NASS Injury Coding Manual contains a listing of most injuries. Use the manual to code, for each injury, its aspect value and record it on the form.

Variable Name: Injury Source
(1st through 10th or higher)

Element Values:

Front

- 01 Windshield
- 02 Mirror
- 03 Sunvisor
- 04 Steering wheel rim
- 05 Steering wheel hub/spoke
- 06 Steering wheel (combination of codes 04 and 05)
- 07 Steering column, transmission, selector lever, other attachment
- 08 Add on equipment (e.g., CB, tape deck, air conditioner)
- 09 Left instrument panel and below
- 10 Center instrument panel and below
- 11 Right instrument panel and below
- 12 Glove compartment door
- 13 Knee bolster
- 14 Windshield including one or more of the following: front header, A (A1/A2)-pillar, instrument panel, mirror, or steering assembly (driver side only)
- 15 Windshield including one or more of the following: front header, A (A1/A2)-pillar, instrument panel, or mirror (passenger side only)
- 16 Driver side air bag compartment cover
- 17 Passenger side air bag compartment cover
- 18 Windshield reinforced by exterior object (specify)
- *19 Other front object (specify)

Left Side

- 20 Left side interior surface, excluding hardware or armrest
- 21 Left side hardware or armrest
- 22 Left A (A1/A2)-pillar
- 23 Left B pillar
- *24 Other left pillar (specify)
- 25 Left side window glass or frame
- 26 Left side window glass including one or more of the following: frame, window sill, A (A1/A2)-pillar, B-pillar, or roof side rail
- *27 Other left side object (specify)
- 28 Left side window sill

Right Side

- 30 Right side interior surface, excluding hardware or armrest
- 31 Right side hardware or armrest
- 32 Right A (A1/A2)-pillar
- 33 Right B pillar
- *34 Other right pillar (specify)
- 35 Right side window glass or frame
- 36 Right side window glass including one or more of the following: frame, window sill, A (A1/A2)-pillar, B-pillar, or roof side rail
- *37 Other right side object (specify)
- 38 Right side window sill

Variable Name: Injury Source (cont'd.)
(1st through 10th or higher)

Interior

- 40 Seat, back support
- 41 Belt restraint webbing/buckle
- 42 Belt restraint B pillar or door frame attachment point
- *43 Other restraint system component (specify)
- 44 Head restraint system
- 45 Air bag (use codes "16" and "17" for injuries sustained from air bag compartment covers)
- *46 Other occupants (specify)
- 47 Interior loose objects
- *48 Child safety seat (specify)
- *49 Other interior object specify)

Roof

- 50 Front header
- 51 Rear header
- 52 Roof left side rail
- 53 Roof right side rail
- 54 Roof or convertible top

Floor

- 56 Floor including toe pan
- 57 Floor or console mounted transmission lever, including console
- 58 Parking brake handle
- 59 Foot controls including parking brake

Rear

- 60 Backlight (rear window)
- 61 Backlight storage rack, door, etc.
- *62 Other rear object (specify)

Exterior of Occupant's Vehicle

- 65 Hood
- 66 Outside hardware (e.g., outside mirror, antenna)
- *67 Other exterior surface or tires (specify)
- 68 Unknown exterior objects

Exterior of Other Motor Vehicle

- 70 Front bumper
- 71 Hood edge
- *72 Other front of vehicle (specify)
- 73 Hood
- 74 Hood ornament
- 75 Windshield, roof rail, A-pillar
- 76 Side surface

Variable Name: Injury Source (cont'd.)
(1st through 10th or higher)

- 77 Side mirrors
- *78 Other side protrusions (specify)
- 79 Rear surface
- 80 Undercarriage
- 81 Tires and wheels
- *82 Other exterior of other motor vehicle (specify)
- 83 Unknown exterior of other motor vehicle

Other Vehicle or Object in the Environment

- 84 Ground
- *85 Other vehicle or object (specify)
- 86 Unknown vehicle or object

Noncontact Injury

- 90 Fire in vehicle
- 91 Flying glass
- *92 Other noncontact injury source (specify)
- 93 Air bag exhaust gases

- 97 Injured, unknown source

Source: Zone Center determined--inputs include vehicle inspection, interviewee, and medical records.

Remarks:

Code "06" (Combination of rim and hub/spokes) when there is an unspecified steering wheel injury source.

Code "14" [Windshield including one or more of the following: front header, A (A1/A2)-pillar, instrument panel, mirror, or steering assembly (driver side only)] should be used for contacts on the left (driver) side of the vehicle interior. This code applies only when there is a continuous or simultaneous contact to the windshield and one of the listed components by a single Body Region of the occupant.

Note: Some vehicles (e.g., GM APV minivans) are designed with two upper A-pillars on each side. The forward most pillar is called an A1-pillar which is primarily designed to secure the windshield to the vehicle. The second pillar is labeled as an A2-pillar. This pillar generally lends support to the roof and also helps to establish the front door opening. Annotation should be provided on the Interior Vehicle Form specifying which pillar was most severely intruded.

Variable Name: Injury Source (cont'd.)
(1st through 10th or higher)

Code "15" [Windshield including one or more of the following: front header, A (A1/A2)-pillar, instrument panel, or mirror (passenger side only)] should be used for contacts on the right (passenger) side of the vehicle interior. This code applies only when there is a continuous or simultaneous contact to the windshield and one of the listed components by a single Body Region of the occupant.

Code "18" (Windshield reinforced by exterior object) is used when, for example, an occupant contacts a windshield which has been reinforced by the hood of the occupant's vehicle.

Codes "26" and "36" [Left (Right) side window glass including one or more of the following: frame, window sill, A (A1/A2)-pillar, B-pillar, or roof side rail] apply when there is a simultaneous or continuous contact by a single Body Region of an occupant to the appropriate side window glass and at least one of the listed components. The window sill consists, for this element, of the upper portion of the side interior surface immediately adjacent to the bottom of the side window opening.

Child restraining devices have caused confusion when they are the source of the injury. The child restraint (i.e., infant/child seat, booster seat, etc.) is considered to be an integral restraint (e.g., the whole seat is the restraint). When the restraint is used by an infant or child it should be coded as one unit. In the CDS the analyst is concerned with the complete seat and its performance.

Code "48" (Child safety seat) if contact with a child safety seat occurs from either (a) an infant or child restrained by the child safety seat or (b) any passenger including an infant or child who contacts a child safety seat but is not restrained by that seat.

When any body member of an infant or child restrained by child safety seat contacts an interior object other than the child safety seat, then code the appropriate interior object (i.e., Seat, back support - code "40"; Head restraint system - code "44" etc.)

Code "85" (Other vehicle or object) if an occupant of a vehicle in-transport impacts a parked (not in-transport) vehicle.

Code "90" (Fire in vehicle) is used for injuries which resulted from heat or flame from fire. The origin of the fire is unimportant.

Code "91" (Flying glass) is used for injuries which resulted from interior flying glass. Interior flying glass refers to the occupant being injured by glass which has already fractured due to an impact to the vehicle containing the glazing before the occupant's kinematics allowed the person to physically come into contact with the glazing. The flying glass may or may not be airborne when it injures the occupant. This does not refer to an occupant injury caused by glazing which shattered upon being impacted by the occupant.

Variable Name: Injury Source (cont'd.)
(1st through 10th or higher)

Code "92" (Other noncontact injury source) is used for injuries which resulted from impact force (no contact), battery acid, etc. For a more detailed discussion see the NASS Injury Coding Procedures.

Code "93" (Air bag exhaust gases) is used for injuries which resulted from burns sustained from gases released from an air bag during its inflation process at the time of the accident.

Use **Page 3** (or its reverse side) of the Interview Form to record the interviewee reported injury source evidence and pages four and five of the Vehicle Interior Form to record the physical injury source evidence. The researcher should record only those contact mechanisms which can be documented by some physical evidence (e.g., scuffs, hair, smudges, dents, cracks, etc.).

The element values encoded can be based on physical evidence, occupant kinematics, and interviewee information. Although physical evidence is preferred, it does not have to be present to support a contact mechanism.

* Note: Whenever an "other" code (i.e., "19", "24", "27", "34", "37", "43", "46", "48", "49", "62", "67", "72", "78", "82", "85", or "92") is encoded as injury source, clearly identify, in the space provided next to each code on the reverse side of **Page 2** of the Occupant Injury Form, a description of the "other" source.

Variable Name: Injury Source Confidence Level
(1st through 10th or higher)

Element Values:

- 1 Certain
- 2 Probable
- 3 Possible
- 9 Unknown

Source: Zone Center determined--inputs include vehicle inspection, interviewee, and medical records.

Remarks:

The intent of this variable is to give analysts an assessment of the injury coder's confidence in the injury source coded for a specific injury.

Code "1" (Certain) if there is no reasonable doubt in the mind of the injury coder, based on occupant location, accident dynamics, contact points, and injury mechanism.

Code "2" (Probable) in those situations where there is not a certainty based on the factors noted above for code "1" (Certain).

Code "3" (Possible) if there is no supporting physical evidence but all factors point to an area of the vehicle or an object as the injury source.

Code "9" (Unknown) if the injury source is "97" (Injured, unknown source).

Variable Name: Direct/Indirect Injury
(1st through 10th or higher)

Element Value:

- 1 Direct contact injury
- 2 Indirect contact injury
- 3 Noncontact injury
- 7 Injured, unknown source

Source: Zone Center determined--inputs include vehicle inspection, interviewee, and medical records.

Remarks:

The distinction between direct and indirect is covered in greater detail in NASS Injury Coding Procedures.

Code "1" (Direct contact injury) if the coded injury results from a force impacted directly on the injured Body Region by the component/object coded as the Injury Source (OI12 et al.).

Code "2" (Indirect contact injury) if the coded injury results from a force transmitted from the component/object coded as the Injury Source (OI12 et al.) through another Body Region to the injured Body Region (e.g., knee contacts dash, force transmitted through knee and femur causing a fractured pelvis).

If an occupant's Body Region (OI06 et al.) impacts an object producing an injury to the same Body Region, but the force was transmitted through the occupant's eyeglass, objects in the person's pocket, etc., code the injury as a direct contact ("1").

Code "3" (Noncontact injury) is used when the respective OI12 et al. equals "90" (Fire in vehicle), "91" (Flying glass), "92" (Other noncontact injury source), or "93" (Air bag exhaust gases).

Code "7" (Injured, unknown source) is used whenever the Injury Source is coded "97" (Injured, unknown source).

OCCUPANT INJURY FORM

OI15
et al.

Variable Name: Occupant Area Intrusion Number
(1st through 10th or higher)

Element Values:

Range: 00-10, 97, 99

00 No intrusion or injury not associated with a documented intrusion

97 Injury associated with a noncoded intrusion

99 Unknown

Source: Zone Center determined--inputs include vehicle inspection, interviewee, and medical records.

Remarks:

Code "00" (No intrusion or injury not associated with a documented intrusion) when the Injury Source (OI12 et al.) is not caused by an intruding component or when there are no intrusions coded on the Interior Vehicle Form (IV47-IV86). For example, use this code if the injury source is unknown but no intrusions were coded.

Code "97" (Injury associated with a noncoded intrusion) applies when the injury source is an intruding component but this intrusion was not coded on the Interior Vehicle Form because it (1) was not one of the ten most severe, (2) could not be or was not measured.

Code "99" (Unknown) when the injury source, OI12 et al., is coded unknown and at least one intrusion is present (i.e., IV47 et al is not coded "Blank"). If the rare situation exists where an injury coder cannot say what the injury source is, but can say definitely that none of the intruding components could possibly have produced the injury, then code "00" (No intrusion or injury not associated with an intrusion). In addition, use this code when the vehicle is not inspected or when the vehicle had been repaired prior to inspection.

For all other situations, code the row number of the intruding component which caused the injury. The Intruding Component (VI48 et al.) should be the same or a part of the injury source (OI12 et al.) coded for this injury row (i.e., 1st through 10th or higher).



UPDATE FORM

<p>1. Primary Sampling Unit Number _____</p> <p>2. Case Number – Stratum _____</p> <p>3. Vehicle Number _____</p> <p>4. Occupant Number _____</p>	<p>Driver or Occupant Name: _____</p> <p>Address: _____</p> <p>_____</p> <p>Other Information: _____</p> <p>_____</p> <p style="text-align: center;"><i>(Sanitize this section prior to Update submission.)</i></p>
---	---

STATUS OF LOG INJURY INFORMATION

	INITIAL SUBMISSION	UPDATED INFORMATION	
OAL08. Date Official Medical Data Requested _____/_____/_____			OAL18. Medical Facility Code _____
OAL09. Date Official Medical Data Obtained _____/_____/_____			GV12. Alcohol Test Results For Driver _____
OAL16. Injury Treatment Status _____			GV39. Other Drug Specimen Test Type For Driver _____
OAL17. Injury Information			
<u>Official</u>			
a. Autopsy (invasive examination)	<u>B</u>		
b. Post-ER medical record which includes information about death based on non-invasive examination	<u>B</u>		
c. Admission record/summary or admission/discharge face sheet	<u>B</u>		
d. Discharge summary	<u>B</u>		
e. Operative report	<u>B</u>		
f. Radiographic record(s) (X-ray, CT scan)	<u>B</u>		
g. History and physical examination and/or consultation records	<u>B</u>		
h. Emergency room records (includes nurses' notes)	<u>B</u>		
j. Private physician	<u>B</u>		
<u>Unofficial</u>			
k. Lay coroner	<u>B</u>		
l. EMS record	<u>B</u>		
m. Interviewee	<u>B</u>		
n. Other source (specify) _____	<u>B</u>	<u>B</u>	
o. Police report	<u>B</u>	<u>B</u>	

UPDATE FORM

An Update Form shall be placed in a notebook or file for all occupants whose drug information and/or medical(s) cannot be obtained prior to initial submission. The Update Forms may be filed by case number and occupant number or by the occupant's name (i.e., last name, first name, middle initial); in either case, a cross reference shall be maintained.

The driver/occupant's name and address or other pertinent information must be legibly written in the upper right-hand corner of the form. Sanitize this information prior to submitting the Update Form. Normally, only one Update Form will be submitted per occupant. However, on those occasions when more than one Update Form will be submitted for a given occupant, insert a new Update Form in the notebook or file being careful to record on the new form the most recent updated log information about the occupant.

Status of Log Injury Information

This section records the most current log status information pertaining to this occupant. The variables and element values are identical to: (1) OAL08 (Date Official Medical Data Requested); (2) OAL09 (Date Official Medical Data Obtained) (3) OAL16 (Injury Treatment Status); (4) OAL17 (Injury information); and (5) OAL18 (Medical Facility Code), where the status of the occupant's Injury Information was initially indicated [e.g., "08" (To be updated)]. Also included are alcohol test results and drug test type for drivers. The variables and elements are identical to: (1) GV12 (Alcohol Test Results for Driver) and (2) (Other Drug Specimen Test Type for Driver). Complete this form each time an Update Form is submitted for an occupant.

Two columns are provided. The column entitled "Initial Submission" contains the data submitted either (1) initially on the Occupant Assessment Form Log or (2) subsequently on a previous update for this occupant. Data in the column entitled "Updated Information" reports the most current correct log information for this occupant. For each updatable log variable, record its current value under the column entitled "Initial Submission". Leave the "Updated Information" column "Blank" for any variable whose element value remains the same. This procedure will help to highlight data changes that must be made by the Zone Center.

For example, suppose that a driver was hospitalized and subsequently died. Although you learned about the occupant's death, you were not able to acquire any of his medical records in time for initial submission. Subsequently, you acquire and submit the driver's Emergency Room records believing these to be the only records that you were going to acquire. Later, you are able to obtain his autopsy. Complete the "Updated Information" column and submit the Update Form and acquired autopsy records to the Zone Center.

Interview Introductory Statement

My name is _____. I research motor vehicle crashes under contract to the United States Department of Transportation in an important statistical research study of traffic accidents involving automobiles, vans, and light trucks. My information indicates that you were involved in an accident on (date) _____. May I ask you a few questions about the accident?

If a negative or uncertain response is received, then see the "OPTIONAL Supplemental Discussion" below.

If a positive response is received, then ask the following question:

"Can you provide a detailed description of the accident, beginning with:

- Events that led up to the collision
- What happened to your vehicle during the collision
- Where did your vehicle finally come to a stop."

OPTIONAL Supplemental Discussion

Let me give you more information about the program.

The name of the program is the National Accident Sampling System. This program involves the random selection of accidents in this county as well as in over sixty counties around the country. The program is only interested in statistical data which will be used to support and assess federal policies toward vehicle safety standards. The primary objective of this program is to provide meaningful data which will be used to continue the ongoing work of improving vehicle safety and the development of safer highway systems. The goal is to reduce injuries and fatalities.

You should also know that your input to this program will not be traceable as personal identifiers (i.e., names, addresses, phone numbers, etc.) are removed from the case file after it completes a quality control review procedure. The federal agency which oversees this program (the National Highway Traffic Safety Admistration) has a mandate from Congress to collect this information while at the same time protecting the confidentiality of participants.

Interview Accident Data Statement

"I would like to ask you about events that led up to the accident and what happened after the collision."

Interview Vehicle/Driver Data Statement

"I would now like to ask you some questions about your vehicle."

Interview Occupant Data Statement

"I would like to ask some questions about you (and your passengers) regarding injuries, seat belts, height, weight, seating position, and medical treatment."

ACCIDENT DIAGRAM



NORTH

The use of this diagram is optional. It may serve to aid in relating interviewee accident trajectory data (i.e., pre-impact to FRP orientations) to identifiable objects in the environment.



INTERVIEW FORM (B)

<p>1. Primary Sampling Unit Number _____</p> <p>2. Case Number - Stratum _____</p> <p>3. Vehicle Number _____</p>	<p>Interviewee(s) Role or Name(s): _____</p> <p>_____</p> <p>_____</p>
---	--

ACCIDENT DATA QUESTIONS

<p>1. Can you tell me in <u>which direction you were traveling</u>?</p> <p><input type="checkbox"/> North <input type="checkbox"/> South <input type="checkbox"/> East <input type="checkbox"/> West</p> <p>(Optional - Where were you coming from or going to?) _____</p> <p>2. <u>In which lane were you traveling?</u> (Note: Lane 1 is designated as the right curb lane.)</p> <p>[1] [2] [3] [4] <input type="checkbox"/> Other (specify): _____</p> <p>3. Can you remember your <u>estimated travel speed</u> (in miles per hour) before the accident?</p> <p><input type="checkbox"/> Stopped <input type="checkbox"/> 1-10 <input type="checkbox"/> 10-20 <input type="checkbox"/> 20-30 <input type="checkbox"/> 30-40 <input type="checkbox"/> 40-50 <input type="checkbox"/> 50-60 <input type="checkbox"/> 60-70 <input type="checkbox"/> 70+</p> <p>4. Just before the accident, can you tell me what you were intending to do or were doing?</p> <p><input type="checkbox"/> Going straight <input type="checkbox"/> Stopped <input type="checkbox"/> slowing <input type="checkbox"/> Accelerating <input type="checkbox"/> Turning left <input type="checkbox"/> Turning right <input type="checkbox"/> Changing lanes to left <input type="checkbox"/> Changing lanes to right <input type="checkbox"/> Backing <input type="checkbox"/> Other (specify): _____</p> <p>5. Did you experience any <u>loss of control</u> due to weather conditions or mechanical problems?</p> <p><input type="checkbox"/> No <input type="checkbox"/> Yes (If yes, describe below) _____ _____</p> <p>6. Did you have to take any <u>avoidance actions prior to the accident?</u></p> <p><input type="checkbox"/> No - Go to question 7 <input type="checkbox"/> Yes - Go to question 6a</p>	<p>6a. <u>What actions did you take?</u></p> <p><input type="checkbox"/> Braking with lock-up <input type="checkbox"/> Braking without lock-up <input type="checkbox"/> Releasing brakes <input type="checkbox"/> Accelerating <input type="checkbox"/> Steering left <input type="checkbox"/> Steering right <input type="checkbox"/> Other (specify): _____</p> <p>7. <u>Where was your vehicle at the time of the collision?</u></p> <p><input type="checkbox"/> Original travel lane <input type="checkbox"/> Different travel lane <input type="checkbox"/> In intersection <input type="checkbox"/> Off roadway to right <input type="checkbox"/> Off roadway to left <input type="checkbox"/> Other (specify): _____</p> <p>8. Was your <u>travel speed at the time of the collision</u> different from your previous travel speed?</p> <p><input type="checkbox"/> No <input type="checkbox"/> Lower <input type="checkbox"/> Higher <input type="checkbox"/> Unknown</p> <p>8a. <u>Can you estimate your speed at the time of the collision?</u></p> <p><input type="checkbox"/> Stopped <input type="checkbox"/> 1-10 <input type="checkbox"/> 10-20 <input type="checkbox"/> 20-30 <input type="checkbox"/> 30-40 <input type="checkbox"/> 40-50 <input type="checkbox"/> 50-60 <input type="checkbox"/> 60-70 <input type="checkbox"/> 70+</p> <p>9. Immediately following the collision, can you describe <u>how your vehicle moved to its stopped position?</u></p> <p>_____ _____ _____</p> <p>10. Can you tell me how many collisions your vehicle had during the accident and the source of the collisions?</p> <p>_____ _____</p>
--	---

1. Primary Sampling Unit Number _____
 2. Case Number - Stratum _____

3. Vehicle Number _____
 4. Occupant Number _____

VEHICLE/DRIVER DATA QUESTIONS

1. Can you tell me the year, make, model of your vehicle?

19 _____, _____, _____
 Year Make Model

2. Can you describe the damage to your vehicle?

3. Was there any previous damage to your vehicle that is not related to this accident?

- No
- Yes (If "yes", describe below)

4. Did any of the doors (hatch, tailgate) open during the accident?

- No
- Yes (If "Yes", describe below)

5. Did any of the windows break during the accident?

- No
- Yes (If "Yes", describe below)

6. Does your vehicle have a glove compartment?

- No
- Yes

6a. Did the glove compartment door come open during the accident?

- No
- Yes
- Unknown

7. Does your vehicle have "seat belts"?

- No (If "No", go to question 7b)
- Yes (If "Yes", go to question 7a)

7a. Can you describe the type of seat belt for each seat?

Driver's seat Lap Lap and shoulder
 Front seat middle Lap Lap and shoulder
 Front seat right Lap Lap and shoulder
 Rear seat left Lap Lap and shoulder
 Rear seat middle Lap Lap and shoulder
 Rear seat right Lap Lap and shoulder

(Identify seat belts for third row and beyond)

7b. Were any of the belts removed or not functional prior to the accident?

- No
- Yes (If "Yes", specify which belt and describe problem)

8. Do any of the front belts move along a motorized track when the door is opened or closed?

- No (If "No", go to question 9)
- Yes (If "Yes", what seat location?)
 - Left Front
 - Right Front

8a. Were the motorized belts working properly before the accident?

- No (If "No", describe condition below)

- Yes

8b. Were the belts connected to the track prior to the accident?

- No
- Yes
- Unknown

9. Do any of the front "seat" belts attach to the door such that when the door is opened the belt travels with the door?

- No (go to question 10)
- Yes

9a. Does this belt come across the _____?

- Chest only
- Lap and chest

9b. Was this belt connected prior to the accident?

- No
- Yes
- Unknown

AIR BAGS

10. Is your vehicle equipped with a driver's side air bag?

- No (go to question 11)
- Yes (go to question 10a)
- Unknown (go to question 11)

10a. Did the air bag inflate during the accident?

- No (go to questions 10b and 10c)
- Yes (go to question 10e)

1. Primary Sampling Unit Number _____

3. Vehicle Number _____

2. Case Number - Stratum _____

4. Occupant Number _____

VEHICLE/DRIVER DATA QUESTIONS (CONTINUED)

10b. Was the air bag wiring disconnected prior to the accident?

- No
 Yes (If "Yes", describe previous condition)

 Unknown

10c. Was your vehicle involved in any accidents prior to this accident which inflated the air bag?

- No (go to question 11)
 Yes (go to question 10d)
 Unknown

10d. Was the air bag re-installed after the accident?

- No (go to question 11)
 Yes
 Unknown

10e. Did the air bag inflate as you expected?

- No (If "No" describe below)

 Yes
 Unknown

11. Is your vehicle equipped with a passenger side air bag?

- No (If "No", go to question 12)
 Yes (If "Yes", go to question 11a)
 Unknown (If "Unknown", go to question 12)

11a. Did the passenger air bag inflate during the accident?

- No (go to question 11b)
 Yes (go to question 12)

11b. Was the passenger air bag wiring disconnected prior to the accident?

- No
 Yes (If "Yes", describe below)

 Unknown

11c. Was the passenger air bag inflated in a previous accident?

- No (go to question 12)
 Yes (go to question 11d)
 Unknown

11d. Was the passenger air bag re-installed after the accident?

- No (go to question 12)
 Yes
 Unknown

11e. Did the passenger air bag inflate as you expected?

- No (If "No" describe below)

 Yes
 Unknown

CHILD SAFETY SEAT

12. Was there a person in a child safety seat in your vehicle?

- No (If "No", go to question 13)
 Yes
 Unknown

12a. Can you tell me the manufacturer and model of the child safety seat?

12b. Can you describe the type of child safety seat?

- Infant
 Toddler
 Convertible
 Booster
 Other (specify): _____
 Unknown

12c. Where was the child safety seat(s) located?

- [12] [13]
 [21] [22] [23]
 [31] [32] [33]
 (Other) (specify): _____

12d. Can you tell me which direction the child safety seat was facing prior to the accident?

- Rear facing
 Forward facing
 Other (specify): _____
 Unknown

12e. Was a seat belt used to hold the child seat in place?

- No (If "No", go to question 12g)
 Yes (If "Yes", go to question 12f)
 Unknown

12f. Can you describe how the seat belt was secured to the child seat?

- Looped through designated rear framing struts?
 Looped through arm rest slots?
 Belt across safety shield?
 Looped through rear frame outside the designated framing struts?
 Other (specify): _____
 Unknown

12g. What was the child safety seat equipped with at the time of purchase? (check all that apply)

- Harness
 Shield
 Tether strap

If any box is checked, ask questions 12h - 12i.

1. Primary Sampling Unit Number _____

3. Vehicle Number _____

2. Case Number - Stratum _____

4. Occupant Number _____

VEHICLE/DRIVER DATA QUESTIONS (CONTINUED)

12h. Were any of these items added after you owned the child safety seat?

- Yes
(specify _____)
- No
- Unknown

12i. Were any of these items used during the accident?

- Yes (If "Yes", check all that apply)
 - Harness
 - Shield
 - Tether strap)
- No
- Unknown

OPTIONAL

If you do not know where the vehicle is or if the owner's permission is needed for inspection.

15. Do you know where the vehicle is currently located?

16. May I take a look at your vehicle to assess the damage?

- No
- Yes

CARGO WEIGHT AND MILEAGE

13. Was there any cargo in your vehicle?

- No (If "No", go to question 14)
- Yes (If "Yes", go to question 13a)
- Unknown

13a. Can you estimate the weight of the cargo?

_____ lbs.

Cargo description

14. Can you tell me the mileage on the vehicle?

_____ miles

DRIVER ONLY

17. What race do you consider yourself?

- White
- Black
- American Indian, Eskimo or Aleut, Asian or Pacific Islander
- Other (specify: _____)
- Unknown.

18. Are you of hispanic origin?

- No
- Yes

1. Primary Sampling Unit Number _____ 3. Vehicle Number _____
 2. Case Number - Stratum _____ 4. Occupant Number _____

VEHICLE ROLLOVER/FIRE QUESTIONS

ROLLOVER QUESTIONS	FIRE QUESTIONS
<p>1. Did the vehicle rollover during the accident? <input type="checkbox"/> No (If "No", go to question 2.) <input type="checkbox"/> Yes <input type="checkbox"/> Unknown (skip to question 2)</p> <p>1a. Describe where the rollover began. <input type="checkbox"/> On roadway <input type="checkbox"/> On shoulder <input type="checkbox"/> On roadside or median <input type="checkbox"/> Unknown</p> <p>1b. What caused the vehicle to rollover? <input type="checkbox"/> Other vehicle (specify vehicle number): _____ <input type="checkbox"/> Contacted object (specify): _____ <input type="checkbox"/> Other cause (specify): _____ <input type="checkbox"/> Unknown</p> <p>1c. Describe which direction the vehicle rolled. <input type="checkbox"/> Toward the right <input type="checkbox"/> Toward the left <input type="checkbox"/> End-over-end <input type="checkbox"/> Unknown</p> <p>1d. Estimate the number of sides (including the top and bottom) which contacted the ground during the rollover? <input type="checkbox"/> 1 side <input type="checkbox"/> 2 sides <input type="checkbox"/> 3 sides <input type="checkbox"/> 4 sides <input type="checkbox"/> Unknown</p> <p>1e. Did the vehicle roll over more than one complete turn (more than 4 sides)? <input type="checkbox"/> No (If "No", go to question 1g.) <input type="checkbox"/> Yes</p> <p>1f. Estimate the number of complete turns. <input type="checkbox"/> No <input type="checkbox"/> Yes (specify): _____ <input type="checkbox"/> Unknown</p> <p>1g. When the vehicle stopped rolling over, which side of the vehicle was in contact with the ground? <input type="checkbox"/> Left side <input type="checkbox"/> Right side <input type="checkbox"/> Top <input type="checkbox"/> Wheels <input type="checkbox"/> Unknown</p>	<p>2. Did the vehicle experience a fire? <input type="checkbox"/> No (If "No", skip to Occupant Data Questions) <input type="checkbox"/> Yes <input type="checkbox"/> Unknown</p> <p>2a. Describe where the fire started or where smoke was first seen. <input type="checkbox"/> Under the hood <input type="checkbox"/> Behind the instrument panel <input type="checkbox"/> In the passenger compartment <input type="checkbox"/> In the trunk/cargo area <input type="checkbox"/> Under the vehicle <input type="checkbox"/> From other involved vehicle <input type="checkbox"/> Unknown</p> <p>2b. Did the fire start with the electrical system? <input type="checkbox"/> No <input type="checkbox"/> Yes (specify): _____ <input type="checkbox"/> Unknown</p> <p>2c. Did the fire start with the fuel system? <input type="checkbox"/> No (If "No", skip to Occupant Data Questions) <input type="checkbox"/> Yes (go to question 2d) <input type="checkbox"/> Unknown</p> <p>2d. Describe which part of the fuel system that may have been involved? <input type="checkbox"/> No <input type="checkbox"/> Yes (specify): _____ _____ Fuel tank _____ Fuel lines _____ Engine compartment (specify component if known) <input type="checkbox"/> Unknown</p> <p style="text-align: center;">(Go To Occupant Data Questions)</p> <p style="text-align: center;">COMMENTS ON ROLLOVERS AND FIRES</p> <hr/> <hr/> <hr/> <hr/>

1. Primary Sampling Unit Number _____

3. Vehicle Number _____

2. Case Number - Stratum _____

4. Occupant Number _____

OCCUPANT DATA QUESTIONS

1. Was there anyone else in your vehicle at the time of the accident?
 No (If "No", go to question 4)
 Yes (If "Yes", specify number in question 2 below and then go to question 3)
 Unknown

2. How many?
 [1] One other person
 [2] Two other persons
 [3] Three other persons
 [4] Four other persons
 [5] Five other persons
 [6] Six other persons
 [7] Seven or more other persons (specify number:) _____

3. Where was this person sitting? (Circle seating positions)
- | | | |
|------|------|------|
| | [12] | [13] |
| [21] | [22] | [23] |
| [31] | [32] | [33] |
- Other (specify:) _____

- 5d. Were you (Was he/she)
 Sitting upright or
 Leaning to left side, or
 Leaning to right side?

OCCUPANT EJECTION

6. Were you (Was he/she) or any part of your (his/her) body thrown from the vehicle during the accident?
 No (If "No", go to question 7)
 Yes (If "Yes", go to question 6a)
 Unknown

- 6a. Can you remember out of what area of the vehicle you were (he/she was) thrown?
 No
 Yes (Describe:) _____

OCCUPANT RESTRAINT

7. Were you (Was he/she) wearing a seat belt just before the accident?
 No (If "No", go to question 8)
 Yes
 Unknown

- 7a. Were you (Was he/she) wearing the
 Lap belt?
 Lap and Shoulder belt?
 Shoulder belt?

- 7b. Can you describe how you were (he/she was) wearing the lap belt?
 Across the stomach
 Low on lap
 Other (specify:) _____
 Unknown

- 7c. Can you describe how you were (he/she was) wearing the shoulder belt?
 Over the shoulder
 Under the arm
 Behind the back
 Behind the seat
 Other (specify:) _____

- 7d. Did any part of the belt system break or tear?
 No
 Yes (If "Yes", describe) _____
 Unknown

OCCUPANT CHARACTERISTICS

4. Can I have your (his/her) height, weight, age, and sex?
 Height _____ Weight _____ Age _____
 Sex: Male Female

OCCUPANT POSTURE

5. Can you tell me how you (he/she was) were sitting in your vehicle?

- 5a. Can you describe the location of your (his/her) feet just prior to the collision?

- 5b. Can you describe the location of your (his/her) arms?

- 5c. Was your (his/her) back resting against the seat back rest?
 No (If "No", describe the position) _____
 Yes
 Unknown

OCCUPANT ENTRAPMENT

8. Were you (Was he/she) trapped in the vehicle?
 No
 Yes (If "Yes", describe) _____
 Unknown

PSU Number _____ Case Number—Stratum _____ Vehicle Number _____ Occupant Number _____

INJURY DATA FROM INTERVIEWEE(S)

Indicate the *Location, Lesion, Detail, and Source* of all injuries. Specify interviewee(s): _____

SOFT TISSUE/INTERNAL INJURIES

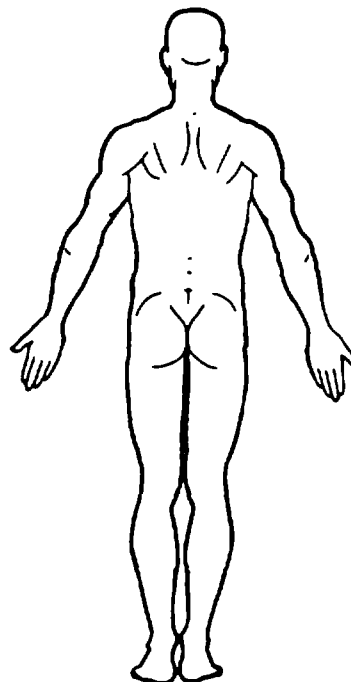
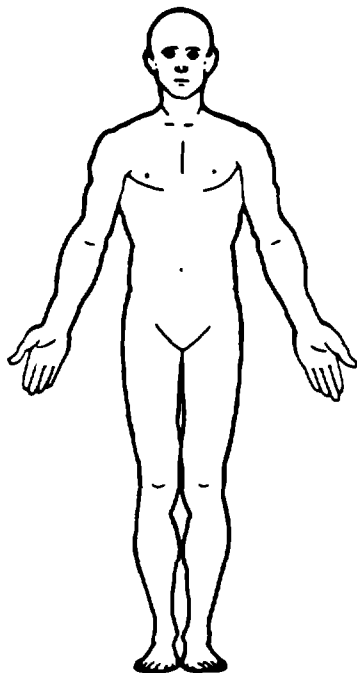

SKELETAL INJURIES

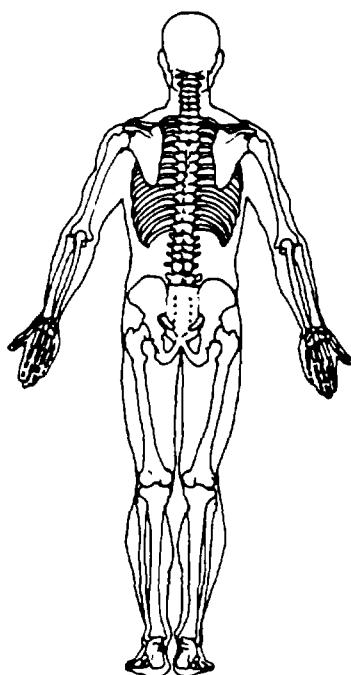
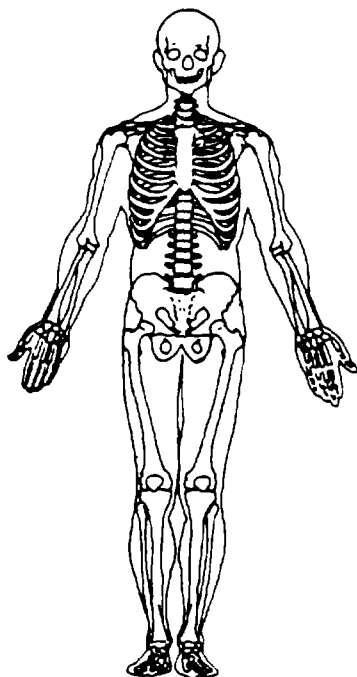

The space provided on the back of this page may be used to document injuries noted by the interviewee(s).

1. Primary Sampling Unit Number _____

3. Vehicle Number _____

2. Case Number - Stratum _____

4. Occupant Number _____

OCCUPANT INJURY DATA QUESTIONS

1. Were you (Was he/she) injured?

- No (If "No", skip to question 7)
 Yes (If "Yes", complete Occupant Injury Questions)
 Unknown

2. Did you (he/she) receive any cuts, abrasions, or bruises?

- No (go to question 3)
 Yes (If "Yes", record the exact location(s) and size on the manikin(s).)
 Unknown

2a. Do you know what caused your (his/her) injury(s)?

- No
 Yes (If "Yes", specify the component(s) or object(s) on the manikin(s).)
 Unknown

3. Did you (he/she) experience any broken bones?

- No (If "No", go to question 4)
 Yes (If "Yes", record the exact location(s) and type of fracture(s) on the manikin(s), and then go to question 3a.)
 Unknown

3a. Do you know what caused the injury(s)?

- No
 Yes (If "Yes", specify the component(s) or object(s) on the manikin(s).)
 Unknown

4. Did you (he/she) injure your (his/her) head? (skull/brain?)

- No (If "No", go to question 5)
 Yes (If "Yes", describe the type of injury(s) on the manikin(s), then go to question 4a.)
 Unknown

4a. Do you know what caused the injury(s)?

- No
 Yes (If "Yes", specify the component(s) on the manikin(s).)
 Unknown

5. Were any of your (his/her) internal organs injured?

- No (If "No", go to question 6)
 Yes (If "Yes", thoroughly describe the type of injury(s) and specify the internal organ(s) injured on the manikin(s), and then go to question 5a.)
 Unknown

5a. Do you know what caused this injury?

- No
 Yes (If "Yes", specify the component(s) on the manikin(s).)
 Unknown

6. Did you (he/she) suffer any joint sprains or muscle strains?

- No (If "No", go to question 7)
 Yes (If "Yes", specify on the manikin(s), and then go to question 6a.)
 Unknown

6a. Do you know what caused the injury(s)?

- No
 Yes (If "Yes", specify the component(s) on the manikin(s).)
 Unknown

7. Did you (he/she) receive any treatment?

- No (If "No", go to question 8)
 Yes (If "Yes", go to question 7a or return to question 2.)

7a. Were you (Was he/she) treated by (check all that apply):

- Hospital/trauma center? (specify hospital name): _____
 Medical clinic
 Out patient surgery? (specify medical facility): _____
 Paramedics or first aid at the scene?
 A doctor in his/her office?
 Treated at home?
 None of the above, go to question 8.

7b. Were you (Was he/she) treated and released from the emergency room?

- No (If "No", go to question 7c.)
 Yes (If "Yes", go to question 7e.)

7c. Were you (Was he/she) hospitalized?

- No (If "No", give an explanation)
 Yes (If "Yes", go to question 7d.)
- _____
- _____

7d. How many days were you (was he/she) in the hospital?
_____ days

1. Primary Sampling Unit Number _____

3. Vehicle Number _____

2. Case Number - Stratum _____

4. Occupant Number _____

OCCUPANT INJURY DATA QUESTIONS (CONTINUED)

7e. Have you (Has he/she) received any follow-up treatment?

No

Yes (If "Yes", describe:)

Unknown

8. Have you (he/she) lost any days from work or school (college)?

No

Yes (If "Yes", determine the number of days lost) (Specify:)

Not working prior to the accident

Unknown

7f. In order to achieve the best possible scientific data regarding your (his/her) injury(s), we need to obtain a copy of your (his/her) medical reports. Would you (he/she) sign a medical release form?

No

Yes (If "Yes", mail or present the form for signature.)



CONTACT LOG

1. PSU Number _____	3. Vehicle Number _____
2. Case Number—Stratum _____	4. Assigned Researcher Number _____

VEHICLE INSPECTION	INTERVIEW																																																																																																																																																																																																																																																																																																																																																																																																																																																						
<table border="1" style="width:100%; border-collapse: collapse;"> <thead> <tr> <th style="width:15%;">Date</th> <th style="width:15%;">Time</th> <th style="width:10%;">ID#</th> <th style="width:10%;">Contact</th> <th style="width:10%;">Manner</th> <th style="width:10%;">Result</th> </tr> </thead> <tbody> <tr><td>___/___/___</td><td>_____</td><td>___</td><td>___</td><td>___</td><td>___</td></tr> <tr><td>___/___/___</td><td>_____</td><td>___</td><td>___</td><td>___</td><td>___</td></tr> <tr><td>___/___/___</td><td>_____</td><td>___</td><td>___</td><td>___</td><td>___</td></tr> <tr><td>___/___/___</td><td>_____</td><td>___</td><td>___</td><td>___</td><td>___</td></tr> <tr><td>___/___/___</td><td>_____</td><td>___</td><td>___</td><td>___</td><td>___</td></tr> <tr><td>___/___/___</td><td>_____</td><td>___</td><td>___</td><td>___</td><td>___</td></tr> <tr><td>___/___/___</td><td>_____</td><td>___</td><td>___</td><td>___</td><td>___</td></tr> <tr><td>___/___/___</td><td>_____</td><td>___</td><td>___</td><td>___</td><td>___</td></tr> <tr><td>___/___/___</td><td>_____</td><td>___</td><td>___</td><td>___</td><td>___</td></tr> <tr><td>___/___/___</td><td>_____</td><td>___</td><td>___</td><td>___</td><td>___</td></tr> <tr><td>___/___/___</td><td>_____</td><td>___</td><td>___</td><td>___</td><td>___</td></tr> <tr><td>___/___/___</td><td>_____</td><td>___</td><td>___</td><td>___</td><td>___</td></tr> <tr><td>___/___/___</td><td>_____</td><td>___</td><td>___</td><td>___</td><td>___</td></tr> <tr><td>___/___/___</td><td>_____</td><td>___</td><td>___</td><td>___</td><td>___</td></tr> <tr><td>___/___/___</td><td>_____</td><td>___</td><td>___</td><td>___</td><td>___</td></tr> <tr><td>___/___/___</td><td>_____</td><td>___</td><td>___</td><td>___</td><td>___</td></tr> <tr><td>___/___/___</td><td>_____</td><td>___</td><td>___</td><td>___</td><td>___</td></tr> <tr><td>___/___/___</td><td>_____</td><td>___</td><td>___</td><td>___</td><td>___</td></tr> <tr><td>___/___/___</td><td>_____</td><td>___</td><td>___</td><td>___</td><td>___</td></tr> <tr><td>___/___/___</td><td>_____</td><td>___</td><td>___</td><td>___</td><td>___</td></tr> <tr><td>___/___/___</td><td>_____</td><td>___</td><td>___</td><td>___</td><td>___</td></tr> <tr><td>___/___/___</td><td>_____</td><td>___</td><td>___</td><td>___</td><td>___</td></tr> <tr><td>___/___/___</td><td>_____</td><td>___</td><td>___</td><td>___</td><td>___</td></tr> </tbody> </table>	Date	Time	ID#	Contact	Manner	Result	___/___/___	_____	___	___	___	___	___/___/___	_____	___	___	___	___	___/___/___	_____	___	___	___	___	___/___/___	_____	___	___	___	___	___/___/___	_____	___	___	___	___	___/___/___	_____	___	___	___	___	___/___/___	_____	___	___	___	___	___/___/___	_____	___	___	___	___	___/___/___	_____	___	___	___	___	___/___/___	_____	___	___	___	___	___/___/___	_____	___	___	___	___	___/___/___	_____	___	___	___	___	___/___/___	_____	___	___	___	___	___/___/___	_____	___	___	___	___	___/___/___	_____	___	___	___	___	___/___/___	_____	___	___	___	___	___/___/___	_____	___	___	___	___	___/___/___	_____	___	___	___	___	___/___/___	_____	___	___	___	___	___/___/___	_____	___	___	___	___	___/___/___	_____	___	___	___	___	___/___/___	_____	___	___	___	___	___/___/___	_____	___	___	___	___	<table border="1" style="width:100%; border-collapse: collapse;"> <thead> <tr> <th colspan="6" style="text-align: center;">DRIVER INTERVIEW</th> </tr> <tr> <th style="width:15%;">Date</th> <th style="width:15%;">Time</th> <th style="width:10%;">ID#</th> <th style="width:10%;">Contact</th> <th style="width:10%;">Manner</th> <th style="width:10%;">Result</th> </tr> </thead> <tbody> <tr><td>___/___/___</td><td>_____</td><td>___</td><td>___</td><td>___</td><td>___</td></tr> <tr><td>___/___/___</td><td>_____</td><td>___</td><td>___</td><td>___</td><td>___</td></tr> <tr><td>___/___/___</td><td>_____</td><td>___</td><td>___</td><td>___</td><td>___</td></tr> <tr><td>___/___/___</td><td>_____</td><td>___</td><td>___</td><td>___</td><td>___</td></tr> <tr><td>___/___/___</td><td>_____</td><td>___</td><td>___</td><td>___</td><td>___</td></tr> <tr><td>___/___/___</td><td>_____</td><td>___</td><td>___</td><td>___</td><td>___</td></tr> <tr><td>___/___/___</td><td>_____</td><td>___</td><td>___</td><td>___</td><td>___</td></tr> <tr><td>___/___/___</td><td>_____</td><td>___</td><td>___</td><td>___</td><td>___</td></tr> <tr><td>___/___/___</td><td>_____</td><td>___</td><td>___</td><td>___</td><td>___</td></tr> <tr><td>___/___/___</td><td>_____</td><td>___</td><td>___</td><td>___</td><td>___</td></tr> <tr><td>___/___/___</td><td>_____</td><td>___</td><td>___</td><td>___</td><td>___</td></tr> <tr><td>___/___/___</td><td>_____</td><td>___</td><td>___</td><td>___</td><td>___</td></tr> <tr><td>___/___/___</td><td>_____</td><td>___</td><td>___</td><td>___</td><td>___</td></tr> <tr><td>___/___/___</td><td>_____</td><td>___</td><td>___</td><td>___</td><td>___</td></tr> <tr><td>___/___/___</td><td>_____</td><td>___</td><td>___</td><td>___</td><td>___</td></tr> <tr><td>___/___/___</td><td>_____</td><td>___</td><td>___</td><td>___</td><td>___</td></tr> <tr><td>___/___/___</td><td>_____</td><td>___</td><td>___</td><td>___</td><td>___</td></tr> <tr><td>___/___/___</td><td>_____</td><td>___</td><td>___</td><td>___</td><td>___</td></tr> <tr><td>___/___/___</td><td>_____</td><td>___</td><td>___</td><td>___</td><td>___</td></tr> <tr><td>___/___/___</td><td>_____</td><td>___</td><td>___</td><td>___</td><td>___</td></tr> <tr><td>___/___/___</td><td>_____</td><td>___</td><td>___</td><td>___</td><td>___</td></tr> <tr><td>___/___/___</td><td>_____</td><td>___</td><td>___</td><td>___</td><td>___</td></tr> <tr><td>___/___/___</td><td>_____</td><td>___</td><td>___</td><td>___</td><td>___</td></tr> </tbody> </table> <table border="1" style="width:100%; border-collapse: collapse;"> <thead> <tr> <th colspan="6" style="text-align: center;">OCCUPANT INTERVIEW</th> </tr> <tr> <th style="width:5%;">Occ No</th> <th style="width:15%;">Date</th> <th style="width:15%;">Time</th> <th style="width:10%;">ID#</th> <th style="width:10%;">Contact</th> <th style="width:10%;">Manner Result</th> </tr> </thead> <tbody> <tr><td>___</td><td>___/___/___</td><td>_____</td><td>___</td><td>___</td><td>___</td></tr> <tr><td>___</td><td>___/___/___</td><td>_____</td><td>___</td><td>___</td><td>___</td></tr> <tr><td>___</td><td>___/___/___</td><td>_____</td><td>___</td><td>___</td><td>___</td></tr> <tr><td>___</td><td>___/___/___</td><td>_____</td><td>___</td><td>___</td><td>___</td></tr> <tr><td>___</td><td>___/___/___</td><td>_____</td><td>___</td><td>___</td><td>___</td></tr> <tr><td>___</td><td>___/___/___</td><td>_____</td><td>___</td><td>___</td><td>___</td></tr> <tr><td>___</td><td>___/___/___</td><td>_____</td><td>___</td><td>___</td><td>___</td></tr> <tr><td>___</td><td>___/___/___</td><td>_____</td><td>___</td><td>___</td><td>___</td></tr> <tr><td>___</td><td>___/___/___</td><td>_____</td><td>___</td><td>___</td><td>___</td></tr> <tr><td>___</td><td>___/___/___</td><td>_____</td><td>___</td><td>___</td><td>___</td></tr> <tr><td>___</td><td>___/___/___</td><td>_____</td><td>___</td><td>___</td><td>___</td></tr> <tr><td>___</td><td>___/___/___</td><td>_____</td><td>___</td><td>___</td><td>___</td></tr> <tr><td>___</td><td>___/___/___</td><td>_____</td><td>___</td><td>___</td><td>___</td></tr> <tr><td>___</td><td>___/___/___</td><td>_____</td><td>___</td><td>___</td><td>___</td></tr> <tr><td>___</td><td>___/___/___</td><td>_____</td><td>___</td><td>___</td><td>___</td></tr> <tr><td>___</td><td>___/___/___</td><td>_____</td><td>___</td><td>___</td><td>___</td></tr> <tr><td>___</td><td>___/___/___</td><td>_____</td><td>___</td><td>___</td><td>___</td></tr> <tr><td>___</td><td>___/___/___</td><td>_____</td><td>___</td><td>___</td><td>___</td></tr> <tr><td>___</td><td>___/___/___</td><td>_____</td><td>___</td><td>___</td><td>___</td></tr> <tr><td>___</td><td>___/___/___</td><td>_____</td><td>___</td><td>___</td><td>___</td></tr> <tr><td>___</td><td>___/___/___</td><td>_____</td><td>___</td><td>___</td><td>___</td></tr> <tr><td>___</td><td>___/___/___</td><td>_____</td><td>___</td><td>___</td><td>___</td></tr> </tbody> </table>	DRIVER INTERVIEW						Date	Time	ID#	Contact	Manner	Result	___/___/___	_____	___	___	___	___	___/___/___	_____	___	___	___	___	___/___/___	_____	___	___	___	___	___/___/___	_____	___	___	___	___	___/___/___	_____	___	___	___	___	___/___/___	_____	___	___	___	___	___/___/___	_____	___	___	___	___	___/___/___	_____	___	___	___	___	___/___/___	_____	___	___	___	___	___/___/___	_____	___	___	___	___	___/___/___	_____	___	___	___	___	___/___/___	_____	___	___	___	___	___/___/___	_____	___	___	___	___	___/___/___	_____	___	___	___	___	___/___/___	_____	___	___	___	___	___/___/___	_____	___	___	___	___	___/___/___	_____	___	___	___	___	___/___/___	_____	___	___	___	___	___/___/___	_____	___	___	___	___	___/___/___	_____	___	___	___	___	___/___/___	_____	___	___	___	___	___/___/___	_____	___	___	___	___	___/___/___	_____	___	___	___	___	OCCUPANT INTERVIEW						Occ No	Date	Time	ID#	Contact	Manner Result	___	___/___/___	_____	___	___	___	___	___/___/___	_____	___	___	___	___	___/___/___	_____	___	___	___	___	___/___/___	_____	___	___	___	___	___/___/___	_____	___	___	___	___	___/___/___	_____	___	___	___	___	___/___/___	_____	___	___	___	___	___/___/___	_____	___	___	___	___	___/___/___	_____	___	___	___	___	___/___/___	_____	___	___	___	___	___/___/___	_____	___	___	___	___	___/___/___	_____	___	___	___	___	___/___/___	_____	___	___	___	___	___/___/___	_____	___	___	___	___	___/___/___	_____	___	___	___	___	___/___/___	_____	___	___	___	___	___/___/___	_____	___	___	___	___	___/___/___	_____	___	___	___	___	___/___/___	_____	___	___	___	___	___/___/___	_____	___	___	___	___	___/___/___	_____	___	___	___	___	___/___/___	_____	___	___	___
Date	Time	ID#	Contact	Manner	Result																																																																																																																																																																																																																																																																																																																																																																																																																																																		
___/___/___	_____	___	___	___	___																																																																																																																																																																																																																																																																																																																																																																																																																																																		
___/___/___	_____	___	___	___	___																																																																																																																																																																																																																																																																																																																																																																																																																																																		
___/___/___	_____	___	___	___	___																																																																																																																																																																																																																																																																																																																																																																																																																																																		
___/___/___	_____	___	___	___	___																																																																																																																																																																																																																																																																																																																																																																																																																																																		
___/___/___	_____	___	___	___	___																																																																																																																																																																																																																																																																																																																																																																																																																																																		
___/___/___	_____	___	___	___	___																																																																																																																																																																																																																																																																																																																																																																																																																																																		
___/___/___	_____	___	___	___	___																																																																																																																																																																																																																																																																																																																																																																																																																																																		
___/___/___	_____	___	___	___	___																																																																																																																																																																																																																																																																																																																																																																																																																																																		
___/___/___	_____	___	___	___	___																																																																																																																																																																																																																																																																																																																																																																																																																																																		
___/___/___	_____	___	___	___	___																																																																																																																																																																																																																																																																																																																																																																																																																																																		
___/___/___	_____	___	___	___	___																																																																																																																																																																																																																																																																																																																																																																																																																																																		
___/___/___	_____	___	___	___	___																																																																																																																																																																																																																																																																																																																																																																																																																																																		
___/___/___	_____	___	___	___	___																																																																																																																																																																																																																																																																																																																																																																																																																																																		
___/___/___	_____	___	___	___	___																																																																																																																																																																																																																																																																																																																																																																																																																																																		
___/___/___	_____	___	___	___	___																																																																																																																																																																																																																																																																																																																																																																																																																																																		
___/___/___	_____	___	___	___	___																																																																																																																																																																																																																																																																																																																																																																																																																																																		
___/___/___	_____	___	___	___	___																																																																																																																																																																																																																																																																																																																																																																																																																																																		
___/___/___	_____	___	___	___	___																																																																																																																																																																																																																																																																																																																																																																																																																																																		
___/___/___	_____	___	___	___	___																																																																																																																																																																																																																																																																																																																																																																																																																																																		
___/___/___	_____	___	___	___	___																																																																																																																																																																																																																																																																																																																																																																																																																																																		
___/___/___	_____	___	___	___	___																																																																																																																																																																																																																																																																																																																																																																																																																																																		
___/___/___	_____	___	___	___	___																																																																																																																																																																																																																																																																																																																																																																																																																																																		
___/___/___	_____	___	___	___	___																																																																																																																																																																																																																																																																																																																																																																																																																																																		
DRIVER INTERVIEW																																																																																																																																																																																																																																																																																																																																																																																																																																																							
Date	Time	ID#	Contact	Manner	Result																																																																																																																																																																																																																																																																																																																																																																																																																																																		
___/___/___	_____	___	___	___	___																																																																																																																																																																																																																																																																																																																																																																																																																																																		
___/___/___	_____	___	___	___	___																																																																																																																																																																																																																																																																																																																																																																																																																																																		
___/___/___	_____	___	___	___	___																																																																																																																																																																																																																																																																																																																																																																																																																																																		
___/___/___	_____	___	___	___	___																																																																																																																																																																																																																																																																																																																																																																																																																																																		
___/___/___	_____	___	___	___	___																																																																																																																																																																																																																																																																																																																																																																																																																																																		
___/___/___	_____	___	___	___	___																																																																																																																																																																																																																																																																																																																																																																																																																																																		
___/___/___	_____	___	___	___	___																																																																																																																																																																																																																																																																																																																																																																																																																																																		
___/___/___	_____	___	___	___	___																																																																																																																																																																																																																																																																																																																																																																																																																																																		
___/___/___	_____	___	___	___	___																																																																																																																																																																																																																																																																																																																																																																																																																																																		
___/___/___	_____	___	___	___	___																																																																																																																																																																																																																																																																																																																																																																																																																																																		
___/___/___	_____	___	___	___	___																																																																																																																																																																																																																																																																																																																																																																																																																																																		
___/___/___	_____	___	___	___	___																																																																																																																																																																																																																																																																																																																																																																																																																																																		
___/___/___	_____	___	___	___	___																																																																																																																																																																																																																																																																																																																																																																																																																																																		
___/___/___	_____	___	___	___	___																																																																																																																																																																																																																																																																																																																																																																																																																																																		
___/___/___	_____	___	___	___	___																																																																																																																																																																																																																																																																																																																																																																																																																																																		
___/___/___	_____	___	___	___	___																																																																																																																																																																																																																																																																																																																																																																																																																																																		
___/___/___	_____	___	___	___	___																																																																																																																																																																																																																																																																																																																																																																																																																																																		
___/___/___	_____	___	___	___	___																																																																																																																																																																																																																																																																																																																																																																																																																																																		
___/___/___	_____	___	___	___	___																																																																																																																																																																																																																																																																																																																																																																																																																																																		
___/___/___	_____	___	___	___	___																																																																																																																																																																																																																																																																																																																																																																																																																																																		
___/___/___	_____	___	___	___	___																																																																																																																																																																																																																																																																																																																																																																																																																																																		
___/___/___	_____	___	___	___	___																																																																																																																																																																																																																																																																																																																																																																																																																																																		
___/___/___	_____	___	___	___	___																																																																																																																																																																																																																																																																																																																																																																																																																																																		
OCCUPANT INTERVIEW																																																																																																																																																																																																																																																																																																																																																																																																																																																							
Occ No	Date	Time	ID#	Contact	Manner Result																																																																																																																																																																																																																																																																																																																																																																																																																																																		
___	___/___/___	_____	___	___	___																																																																																																																																																																																																																																																																																																																																																																																																																																																		
___	___/___/___	_____	___	___	___																																																																																																																																																																																																																																																																																																																																																																																																																																																		
___	___/___/___	_____	___	___	___																																																																																																																																																																																																																																																																																																																																																																																																																																																		
___	___/___/___	_____	___	___	___																																																																																																																																																																																																																																																																																																																																																																																																																																																		
___	___/___/___	_____	___	___	___																																																																																																																																																																																																																																																																																																																																																																																																																																																		
___	___/___/___	_____	___	___	___																																																																																																																																																																																																																																																																																																																																																																																																																																																		
___	___/___/___	_____	___	___	___																																																																																																																																																																																																																																																																																																																																																																																																																																																		
___	___/___/___	_____	___	___	___																																																																																																																																																																																																																																																																																																																																																																																																																																																		
___	___/___/___	_____	___	___	___																																																																																																																																																																																																																																																																																																																																																																																																																																																		
___	___/___/___	_____	___	___	___																																																																																																																																																																																																																																																																																																																																																																																																																																																		
___	___/___/___	_____	___	___	___																																																																																																																																																																																																																																																																																																																																																																																																																																																		
___	___/___/___	_____	___	___	___																																																																																																																																																																																																																																																																																																																																																																																																																																																		
___	___/___/___	_____	___	___	___																																																																																																																																																																																																																																																																																																																																																																																																																																																		
___	___/___/___	_____	___	___	___																																																																																																																																																																																																																																																																																																																																																																																																																																																		
___	___/___/___	_____	___	___	___																																																																																																																																																																																																																																																																																																																																																																																																																																																		
___	___/___/___	_____	___	___	___																																																																																																																																																																																																																																																																																																																																																																																																																																																		
___	___/___/___	_____	___	___	___																																																																																																																																																																																																																																																																																																																																																																																																																																																		
___	___/___/___	_____	___	___	___																																																																																																																																																																																																																																																																																																																																																																																																																																																		
___	___/___/___	_____	___	___	___																																																																																																																																																																																																																																																																																																																																																																																																																																																		
___	___/___/___	_____	___	___	___																																																																																																																																																																																																																																																																																																																																																																																																																																																		
___	___/___/___	_____	___	___	___																																																																																																																																																																																																																																																																																																																																																																																																																																																		
___	___/___/___	_____	___	___	___																																																																																																																																																																																																																																																																																																																																																																																																																																																		

CONTACT

- (1) Owner/driver
- (2) Tow yard
- (3) Repair facility
- (4) Salvage yard
- (5) Police
- (6) Insurance company
- (7) Attorney
- (8) Other (specify) _____

MANNER

- (1) Telephone
- (2) In-person
- (3) Questionnaire
- (4) Other (specify) _____

RESULT

- (1) Complete inspection
- (2) Partial inspection
- (3) Refusal
- (4) Vehicle moved to known location
- (5) Vehicle moved to unknown location
- (6) Vehicle located, no permission to inspect
- (7) Vehicle repaired
- (8) No answer/not home
- (9) Other (specify) _____

CONTACT

- (0) No interview
- (1) Driver
- (2) Other occupant
- (3) Relative or friend
- (4) Multiple interviewees from above categories

MANNER

- (0) Vehicle not occupied
- (1) Telephone
- (2) In-person
- (3) Questionnaire
- (4) Other (specify) _____

RESULT

- (01) Unable to contact or locate
- (02) Hit and run
- (03) Fatal—surrogate not available
- (04) In intensive care—surrogate not available
- (05) Out-of-state resident
- (06) Refused interview
- (07) Insurance company refusal
- (08) Attorney refusal or litigation
- (09) No return of questionnaire
- (10) Other (specify) _____
- (11) Return of completed questionnaire
- (12) Partial interview
- (13) Complete interview

1. Primary Sampling Unit Number _____ 3. Vehicle Number _____
 2. Case Number - Stratum _____ 4. Occupant Number _____

OCCUPANT DATA QUESTIONS SUPPLEMENT

1. Who was the next occupant in your vehicle at the time of the accident?

2. Occupant Number _____ of _____.

3. Where were you (was this person) sitting? (Circle seating positions)

- | | | |
|------|------|------|
| | [12] | [13] |
| [21] | [22] | [23] |
| [31] | [32] | [33] |
- [] Other (specify:) _____

5d. Were you (Was he/she)
 Sitting upright or
 Leaning to left side, or
 Leaning to right side?

OCCUPANT EJECTION

6. Were you (Was he/she) or any part of your (his/her) body thrown from the vehicle during the accident?
 No (If "No", go to question 7)
 Yes (If "Yes", go to question 6a)
 Unknown

6a. Can you remember out of what area of the vehicle you were (he/she was) thrown?
 No
 Yes (Describe:) _____

OCCUPANT RESTRAINT

7. Were you (Was he/she) wearing a seat belt just before the accident?
 No (If "No", go to question 8)
 Yes
 Unknown

7a. Were you (Was he/she) wearing the
 Lap belt?
 Lap and Shoulder belt?
 Shoulder belt?

7b. Can you describe how you were (he/she was) wearing the lap belt?
 Across the stomach
 Low on lap
 Other (specify:) _____
 Unknown

7c. Can you describe how you were (he/she was) wearing the shoulder belt?
 Over the shoulder
 Under the arm
 Behind the back
 Behind the seat
 Other (specify:) _____

7d. Did any part of the belt system break or tear?
 No
 Yes (If "Yes", describe) _____
 Unknown

OCCUPANT CHARACTERISTICS

4. Can I have your (his/her) height, weight, age, and sex?

Height _____ Weight _____ Age _____

Sex: Male Female

OCCUPANT POSTURE

5. Can you tell me how you (he/she) was sitting in the vehicle?

5a. Can you describe the location of your (his/her) feet just prior to the collision?

5b. Can you describe the location of your (his/her) arms?

5c. Was your (his/her) back resting against the seat back rest?
 No (If "No", describe the position) _____

Yes
 Unknown

OCCUPANT ENTRAPMENT

8. Were you (Was he/she) trapped in the vehicle?
 No
 Yes (If "Yes", describe) _____

 Unknown

PSU Number _____ Case Number-Stratum _____ Vehicle Number _____ Occupant Number _____

INJURY DATA FROM INTERVIEWEE(S)

Indicate the *Location, Lesion, Detail, and Source* of all injuries. Specify interviewee(s): _____

SOFT TISSUE/INTERNAL INJURIES

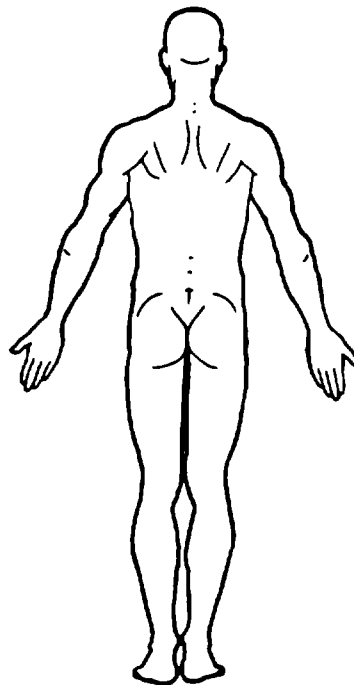
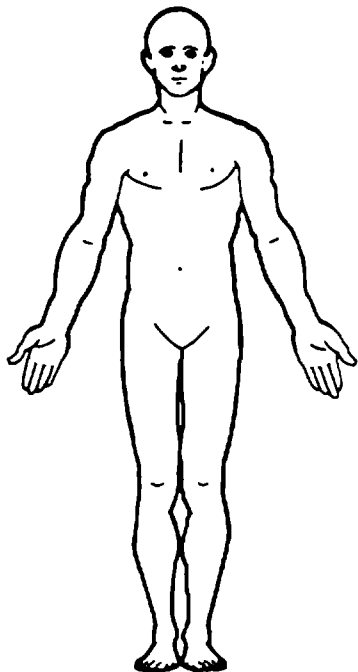

SKELETAL INJURIES

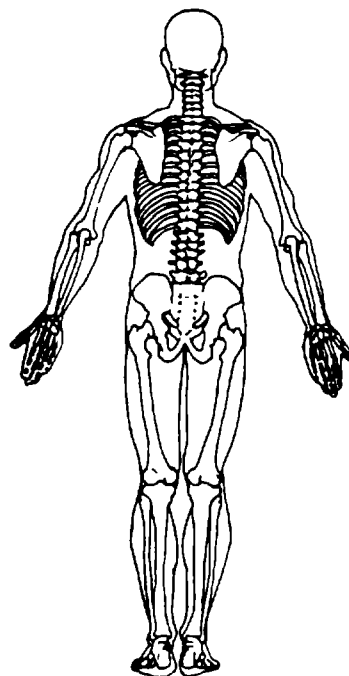
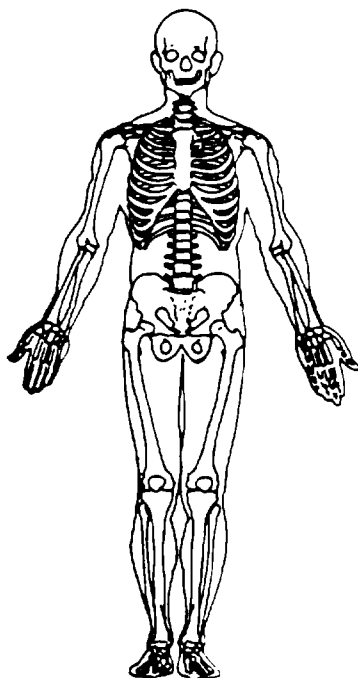

The space provided on the back of this page may be used to document injuries noted by the interviewee(s).

1. Primary Sampling Unit Number _____
 2. Case Number - Stratum _____

3. Vehicle Number _____
 4. Occupant Number _____

OCCUPANT INJURY DATA QUESTIONS

- 1. Were you (Was he/she) injured?
 No (If "No", skip to question 7)
 Yes (If "Yes", complete Occupant Injury Questions)
 Unknown
- 2. Did you (he/she) receive any cuts, abrasions, or bruises?
 No (go to question 3)
 Yes (If "Yes", record the exact location(s) and size on the manikin(s).)
 Unknown
- 2a. Do you know what caused your (his/her) injury(s)?
 No
 Yes (If "Yes", specify the component(s) or object(s) on the manikin(s).)
 Unknown
- 3. Did you (he/she) experience any broken bones?
 No (If "No", go to question 4)
 Yes (If "Yes", record the exact location(s) and type of fracture(s) on the manikin(s), and then go to question 3a.)
 Unknown
- 3a. Do you know what caused the injury(s)?
 No
 Yes (If "Yes", specify the component(s) or object(s) on the manikin(s).)
 Unknown
- 4. Did you (he/she) injure your (his/her) head? (skull/ brain?)
 No (If "No", go to question 5)
 Yes (If "Yes", describe the type of injury(s) on the manikin(s), then go to question 4a.)
 Unknown
- 4a. Do you know what caused the injury(s)?
 No
 Yes (If "Yes", specify the component(s) on the manikin(s).)
 Unknown
- 5. Were any of your (his/her) internal organs injured?
 No (If "No", go to question 6)
 Yes (If "Yes", thoroughly describe the type of injury(s) and specify the internal organ(s) injured on the manikin(s), and then go to question 5a.)
 Unknown

- 5a. Do you know what caused this injury?
 No
 Yes (If "Yes", specify the component(s) on the manikin(s).)
 Unknown
- 6. Did you (he/she) suffer any joint sprains or muscle strains?
 No (If "No", go to question 7)
 Yes (If "Yes", specify on the manikin(s), and then go to question 6a.)
 Unknown
- 6a. Do you know what caused the injury(s)?
 No
 Yes (If "Yes", specify the component(s) on the manikin(s).)
 Unknown
- 7. Did you (he/she) receive any treatment?
 No (If "No", go to question 8)
 Yes (If "Yes", go to question 7a or return to question 2.)
- 7a. Were you (Was he/she) treated by (check all that apply):
 Hospital/trauma center? (specify hospital name): _____
 Medical clinic
 Out patient surgery? (specify medical facility): _____
 Paramedics or first aid at the scene?
 A doctor in his/her office?
 Treated at home?
 None of the above, go to question 8.
- 7b. Were you (Was he/she) treated and released from the emergency room?
 No (If "No", go to question 7c.)
 Yes (If "Yes", go to question 7e.)
- 7c. Were you (Was he/she) hospitalized?
 No (If "No", give an explanation)
 Yes (If "Yes", go to question 7d.)

- 7d. How many days were you (was he/she) in the hospital?
 _____ days

1. Primary Sampling Unit Number _____

3. Vehicle Number _____

2. Case Number - Stratum _____

4. Occupant Number _____

OCCUPANT INJURY DATA QUESTIONS (CONTINUED)

7e. Have you (Has he/she) received any follow-up treatment?

No

Yes (If "Yes", describe:)

Unknown

8. Have you (he/she) lost any days from work or school (college)?

No

Yes (If "Yes", determine the number of days lost) (Specify:)

Not working prior to the accident

Unknown

7f. In order to achieve the best possible scientific data regarding your (his/her) injury(s), we need to obtain a copy of your (his/her) medical reports. Would you (he/she) sign a medical release form?

No

Yes (If "Yes", mail or present the form for signature.)

INTERVIEW FORM

Before completing the Interview Form make sure that the interviewee(s) have been clearly identified, including their relationship to the vehicle's driver. For example, "driver" is sufficient. On the other hand, "other occupant" needs further clarification if three or more persons were present in the vehicle. In general, if a surrogate is used, then both name and relationship must be indicated.

The Interview Form is designed to obtain accident, vehicle, and occupant data in an efficient and organized manner. The interviewer is encouraged to use this form as a guide for conducting the interview. It is understood that this interview structure may not meet the style of every NASS interviewer or attempt to meet all contingencies presented by interviewees. The interviewer will have the option of asking questions in a different order to successfully complete the requirements of the interview. However, this form should be followed in the order presented when possible to avoid overlooking data items.

In the event interview data are not obtained for any vehicle occupant, submit only the "Contact Log" with case materials. Do not include a blank Interview Form (A) or Interview Form (B) for this vehicle.

INTERVIEW FORM (A)

Driver's Description of Accident Events

Let the Driver (or interviewee) tell you what happened. Refrain from interrupting the interviewee's train-of-thought. Let the interviewee finish, then return with follow-up questions to areas of the accident sequence that are unclear.

Write legibly. Record faithfully the interviewee's response even when it disagrees with information and/or evidence that you have already acquired (e.g., from the vehicle and/or scene inspection).

Query the interviewee on all crashworthiness issues [see Interview Form (B)]. If this interviewee's vehicle was involved in the accident sequence in a manner which makes it applicable to the trajectory algorithm of the CRASHPC program, then interview so that particular attention is paid to accident details which would help you identify both its impact and final rest locations. Although it is desirable to locate both impact and final rest exactly, it is not necessary. The reasonable approximation of these locations based on accident dynamics and scene evidence enables you to run the trajectory algorithm and compare the results with those obtained through the damage algorithm of the CRASHPC program. Interviewee(s) many times know their pre-impact location, intended movements, and pre-crash avoidance behavior and can sometimes locate their vehicle at final rest relative to fixed objects in the environment (e.g., curb, tree, pole, etc.). Police measurements can also be used to approximate the vehicle's final rest position.

INTERVIEW FORM (A) (Cont'd.)

Immediately following the interview, summarize on Interview Form (A) interviewee comments obtained over the course of the interview which were not provided during the initial uninterrupted statement and were not part of the itemized questions on Interview Form (B). Sufficient space has been provided under the Driver's Description of Accident Events section to accommodate additional writing. If additional space is required, then copy and use as many Interview Form (A) face sheets as required.

Occupant's Description of Accident Events

Space is provided to record statements obtained from the occupant or other interviewee(s). As noted by the layout of the Interview Form (A) face sheet, more emphasis is placed upon statements obtained from the driver. The researcher should record as much information from the occupant as possible when the driver is not readily available. However, an appointment should be made to contact the driver for a follow-up interview.

Accident Diagram

Although the use of this diagram is optional, it can be of particular help during an in-person interview. Oftentimes the researcher has visited the scene prior to conducting the interview. Using your knowledge of the scene, you can pre-sketch the scene on this page. During the interview, you may confirm with the interviewee the accuracy of your sketch while simultaneously refreshing the interviewee's recollection of the scene by means of your visual aid. In addition, you may also assist the interviewee in recalling and reporting the accident sequence by using miniature vehicles (e.g., matchbox) on the sketch. Have the interviewee describe or show you how the vehicle(s) moved during the accident. This technique may sometimes reveal new insights into the accident dynamics. In addition, you may be able to obtain a good locational fix regarding the vehicle's final rest position. The ability to visualize the process may stimulate recollection.

INTERVIEW FORM (B)

This section of the Interview Form is divided into the following five subsections:

- Accident Data Questions
- Vehicle/Driver Data Questions
- Vehicle Rollover/Fire Questions
- Occupant Data Questions
- Occupant Injury Data Questions
- Occupant Data Questions Supplement

Each subsection contains structured questions with check boxes provided. The intent of this design is to reduce time required to write out responses and to establish a method for obtaining a large volume of data. "Go to" instructions are provided to streamline the interview process while emphasizing the requirement for detailed information. Additionally, alpha characters are used to denote subset questions of the primary question.

The interviewer should be knowledgeable of accident circumstances and review the Interview Form (B) prior to conducting the interview to ensure documentation of all pertinent data. As a suggestion, the interviewer should mention the subsections listed above to help focus the interview and provide some insight to the interviewee as to the nature of interview.

The interviewer need not ask questions where information is already known prior to the interview attempt. This is especially true for vehicle related questions where information has already been collected during the vehicle inspection. Where uncertainty exists, default by asking the appropriate questions.

To assist the Zone Center during case review, please review and use the following list of abbreviation codes to clarify when information was either obtained from the vehicle inspection, scene inspection, or not obtained. These codes should be written next to the specific question.

- VI = Vehicle Inspection [Indicates that a question (or series of questions) is/are not asked because the answer is known prior to the interview from the vehicle inspection.]
- SI = Scene Inspection [Indicates that a question (or series of questions) is/are not asked because the answer is known prior to the interview from the scene inspection.]
- R = Refused (Use this abbreviation if the interviewee refuses to answer this specific question.)
- UNK = Unknown (Use this abbreviation when the interviewee does not know the answer and a check off box was not provided as a choice.)
- NA = Not applicable (Use this abbreviation if a specific question is not pertinent to the interview and no preceding question directs the interviewer around the question by means of a "Go to..." directive. Use with caution.)

INTERVIEW FORM (B) (Cont'd.)

T = Terminated (Use this abbreviation at the point where an interviewee abruptly ends the interview. Also annotate the remaining unanswered subsections with this code to indicate the interview had not progressed to these areas.)

Accident Data Questions

Ten main questions under this subsection attempt to define this vehicle's pre-impact trajectory to final rest position (i.e., travel direction, speeds, control, avoidance, and impacted objects).

Vehicle/Driver Data Questions

There are eighteen main questions in this subsection which are specific to vehicle components and driver information. Questions concerning doors, glazing, glove box, seat belts, air bags, child safety seats, cargo, odometer reading, and driver's race and Hispanic origin are presented in a basic checkoff format with space provided for supplemental discussion.

The interviewer should note that belt restraint questions in this subsection attempt to only ascertain restraint type available in the vehicle. Belt restraint usage questions are located in the Occupant Data Questions subsection.

Vehicle Rollover/Fire Questions

There are thirteen main questions in this subsection which are specific to vehicle rollovers and fires. Rollover questions describing the location, cause, direction of roll, and quarter turns are presented in a basic checkoff format. Fire questions describing the origin of the fire, electrical or fuel system involvement, and the part of the fuel system where the fire may have originated are presented in a basic checkoff format. Space is provided for comments.

Occupant Data Questions

There are eight main questions under this subsection which attempt to determine the number of occupants, occupant characteristics, posture, ejection, restraint, and entrapment. The restraint questions focus on belt usage and not on type of restraint system available in the vehicle.

Occupant Injury Data Questions

There are eight main questions relating primary to injuries and medical treatment in this subsection. A manikin page precedes this subsection and can be removed to ease injury recording during questioning.

INTERVIEW FORM (B) (Cont'd.)

Each injury question is designed to probe for specific types of injuries, injury sources, and injury location. It is imperative the interviewer probe extensively using these questions to obtain the best injury description possible. Additionally, extra care should be exercised in recording specific injury detail on the manikin page. This includes thoroughly labeling body parts with the respective lesion and linking this information via arrow lines to the specific area on the manikin (e.g., abrasion of the left index finger, etc.).

Occupant Injury Data Questions (Continued)

The interviewer is reminded to ask if the interviewee received follow-up treatment and to identify the care giver. Medical records from follow-up treatment are needed to determine if the occupant sustained injuries in the accident which were not previously identified in medical reports.

Question "7f" concerning a signed patient release form is designed to remind the interviewer to present (or mail) this form in the following situations:

- o Medical facility treating the occupant requires a release in order to obtain "any" medical records
- o Medical facility treating occupant will only provide partial medical records (e.g., emergency room record only) without a signed patient release form.
- o Treated by a private physician
- o Uncertainty exists whether the person was treated at the stated medical facility

This question does not have to be asked if it is clear the only treatment received was provided by a medical facility which does not require a signed patient release form (i.e., write NA).

Occupant Data Questions Supplement

This subsection should be completed for each additional occupant in the vehicle. With the exception of the first two questions in this subsection, all questions from the Occupant Data and Occupant Injury subsections were duplicated in this Supplement.

APPENDICES

- Uniform Symbols for Scene Markings
- Uniform Symbols for Accident Diagramming
- Variable Computer Formats
- NASS CDS Value Tables
- 1994 NASS CDS Data Collection, Coding and Editing Manual
Modifications, Deletions, and Additions
- 1994 NASS CDS Field Data Collection Forms
Modifications, Deletions, and Additions

UNIFORM SYMBOLS FOR ACCIDENT DIAGRAMMING

Vehicle and Pedestrian Symbols

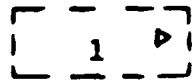

Automobile (pre-impact or at-impact position) Exception: draw solid outline if stopped at-impact.

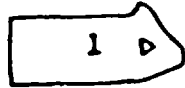

Automobile (final rest position)--showing damaged area



Automobile (final position on its top)



Automobile (final position on its left side) (reverse for right side)



Automobile involved in the accident as a temporary environmental factor, but not physically involved in the collision. (Noncontact Unit)

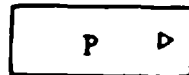

Parked automobile not struck (give it a number if it was struck)



Vehicle in which a witness was an occupant

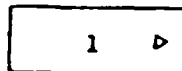

Truck (Panel, Van, Dump, etc.)



Truck tractor and semi-trailer



Utility trailer

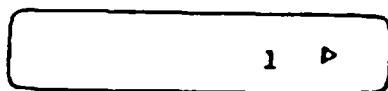

Bus or streetcar



Motorcyclist: bicyclist (handlebars are curved opposite the direction of travel)

UNIFORM SYMBOLS FOR ACCIDENT DIAGRAMMING -- Continued

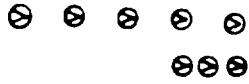

Pedestrian [pointer oriented to show direction of movement and dot spacing to show rate of movement (i.e., 1 meter apart walking and 2 meters apart running)]



Final position of body









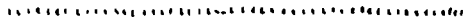

Pedestrian who witnessed accident

All symbols referring to colliding vehicles (plus Noncontact, Witness and Parked vehicles) are to have a broken outline if they are moving at the point in which they are depicted; the outline should be solid if the vehicle is stopped where depicted, or at final rest. Be careful to insure proper placement (location) or orientation on the diagram.

UNIFORM SYMBOLS FOR ACCIDENT DIAGRAMMING -- Continued













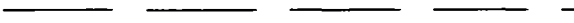

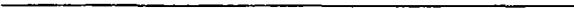
Scene Road Marking

	Point of impact
	Skidmarks
	Centripetal curve scuffs
	Tire scuff marks
	Rotating tire print
	Gouges
	Scratches
	Liquids (puddle and run-off)
	Debris (funnel out away from point of impact to show direction of force)

Any other accident-induced markings, components from vehicles, etc. should be shown in their approximate location and a reasonable likeness sketched on the diagram. However, do not clutter diagram; make an additional diagram, if necessary.











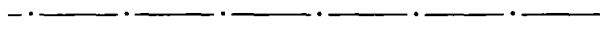
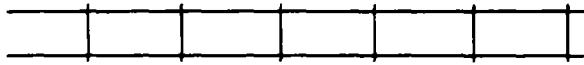
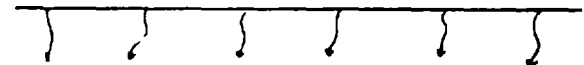

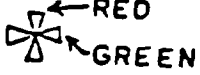
UNIFORM SYMBOLS FOR ACCIDENT DIAGRAMMING -- Continued

Topographical Highway & Environment Symbols

	Pavement edge
	Shoulder edge line (non-formal)
	Shoulder edge line (formal)
	Broken center or lane lines (4.6 meters long - 7.6 meters apart)
	Broken center line with No-Passing line
	Double yellow center lines
	Raised island and Grass median
	Painted median
	Curb
	Paved shoulders with diagonal lines
	Turn arrows
	Wall
	Bridge abutment and railing
	Guardrail

UNIFORM SYMBOLS FOR ACCIDENT DIAGRAMMING -- Continued

Topographical Highway & Environmental Symbols (Cont'd.)

	Fence
	Railroad tracks
	Embankment (arrows show "DOWN")
	Shrubbery - hedges
	Trees (draw trunk and perimeter of foliage to approximate size)
	Traffic signal
	Flashing light
	Traffic signs back to back
	Sign (indicate words or symbols)
	Street light and pole (arm length may change with scene)
	Street light without arm
	Public utility pole
	Building
	Fire Hydrant
	Street Sign
	Delineator post

All crosswalks, road surface symbols and other relevant markings should be depicted and drawn to approximate scale on the diagram as much as possible.

NASS CDS VARIABLE COMPUTER FORMATS

Accident Form

Name	Variable Identifier	SAS		Variable Column Length	Beginning Column Number
		Variable Number	Variable Type		
Primary Sampling Unit Number	AC01		Numeric	2	1
Case Number - Stratum	AC02		Alphanumeric	4	3
Number of Vehicle Forms Submitted	AC03		Numeric	2	7
Date of Accident	AC04		Numeric	6	9
Time of Accident	AC05		Numeric	4	15
SS15 Trauma Studies (Administrative Use)	AC06		Numeric	1	19
SS16 Pedestrian Crash Data Study	AC07		Numeric	1	20
SS17 Impact Fires	AC08		Numeric	1	21
SS18 Not used	AC09		Numeric	1	22
SS19 Not used	AC10		Numeric	1	23
Number of Recorded Events in This Accident	AC11		Numeric	2	24
1st Accident Event Sequence Number	AC12		Numeric	2	26
1st Vehicle Number	AC13		Numeric	2	28
1st Class of Vehicle--1st	AC14		Numeric	2	30
1st General Area of Damage--1st	AC15		Alphanumeric	1	32
1st Vehicle Number or Object Contacted	AC16		Numeric	2	33
1st Class of Vehicle--2nd	AC17		Numeric	2	35
1st General Area of Damage--2nd	AC18		Alphanumeric	1	37
2nd Accident Event Sequence Number	AC19		Numeric	2	38
2nd Vehicle Number	AC20		Numeric	2	40
2nd Class of Vehicle--1st	AC21		Numeric	2	42
2nd General Area of Damage--1st	AC22		Alphanumeric	1	44
2nd Vehicle Number or Object Contacted	AC23		Numeric	2	45
2nd Class of Vehicle--2nd	AC24		Numeric	2	47
2nd General Area of Damage--2nd	AC25		Alphanumeric	1	49
3rd Accident Event Sequence Number	AC26		Numeric	2	50
3rd Vehicle Number	AC27		Numeric	2	52
3rd Class of Vehicle--1st	AC28		Numeric	2	54
3rd General Area of Damage--1st	AC29		Alphanumeric	1	56
3rd Vehicle Number or Object Contacted	AC30		Numeric	2	57
3rd Class of Vehicle--2nd	AC31		Numeric	2	59
3rd General Area of Damage--2nd	AC32		Alphanumeric	1	61
4th Accident Event Sequence Number	AC33		Numeric	2	62
4th Vehicle Number	AC34		Numeric	2	64
4th Class of Vehicle--1st	AC35		Numeric	2	66
4th General Area of Damage--1st	AC36		Alphanumeric	1	68
4th Vehicle Number or Object Contacted	AC37		Numeric	2	69
4th Class of Vehicle--2nd	AC38		Numeric	2	71
4th General Area of Damage--2nd	AC39		Alphanumeric	1	73
5th Accident Event Sequence Number	AC40		Numeric	2	74
5th Vehicle Number	AC41		Numeric	2	76
5th Class of Vehicle--1st	AC42		Numeric	2	78
5th General Area of Damage--1st	AC43		Alphanumeric	1	80
5th Vehicle Number or Object Contacted	AC44		Numeric	2	81
5th Class of Vehicle--2nd	AC45		Numeric	2	83
5th General Area of Damage--2nd	AC46		Alphanumeric	1	85

NASS CDS VARIABLE COMPUTER FORMATS - Continued

Accident Form (Continued)
 (Accident Events Supplement)

Name	Variable Identifier	SAS Variable Number	Variable Type	Variable Column Length	Beginning Column Number
6th Accident Event Sequence Number	AC47		Numeric	2	86
6th Vehicle Number	AC48		Numeric	2	88
6th Class of Vehicle--1st	AC49		Numeric	2	90
6th General Area of Damage--1st	AC50		Alphanumeric	1	92
6th Vehicle Number or Object Contacted	AC51		Numeric	2	93
6th Class of Vehicle--2nd	AC52		Numeric	2	95
6th General Area of Damage--2nd	AC53		Alphanumeric	1	97
7th Accident Event Sequence Number	AC54		Numeric	2	98
7th Vehicle Number	AC55		Numeric	2	100
7th Class of Vehicle--1st	AC56		Numeric	2	102
7th General Area of Damage--1st	AC57		Alphanumeric	1	104
7th Vehicle Number or Object Contacted	AC58		Numeric	2	105
7th Class of Vehicle--2nd	AC59		Numeric	2	107
7th General Area of Damage--2nd	AC60		Alphanumeric	1	109
8th Accident Event Sequence Number	AC61		Numeric	2	110
8th Vehicle Number	AC62		Numeric	2	112
8th Class of Vehicle--1st	AC63		Numeric	2	114
8th General Area of Damage--1st	AC64		Alphanumeric	1	116
8th Vehicle Number or Object Contacted	AC65		Numeric	2	117
8th Class of Vehicle--2nd	AC66		Numeric	2	119
8th General Area of Damage--2nd	AC67		Alphanumeric	1	121
9th Accident Event Sequence Number	AC68		Numeric	2	122
9th Vehicle Number	AC69		Numeric	2	124
9th Class of Vehicle--1st	AC70		Numeric	2	126
9th General Area of Damage--1st	AC71		Alphanumeric	1	128
9th Vehicle Number or Object Contacted	AC72		Numeric	2	129
9th Class of Vehicle--2nd	AC73		Numeric	2	131
9th General Area of Damage--2nd	AC74		Alphanumeric	1	133
10th Accident Event Sequence Number	AC75		Numeric	2	134
10th Vehicle Number	AC76		Numeric	2	136
10th Class of Vehicle--1st	AC77		Numeric	2	138
10th General Area of Damage--1st	AC78		Alphanumeric	1	140
10th Vehicle Number or Object Contacted	AC79		Numeric	2	141
10th Class of Vehicle--2nd	AC80		Numeric	2	143
10th General Area of Damage--2nd	AC81		Alphanumeric	1	145

NASS CDS VARIABLE COMPUTER FORMATS - Continued

General Vehicle Form

Name	Variable Identifier	SAS Variable Number	Variable Type	Variable Column Length	Beginning Column Number
Primary Sampling Unit Number	GV01		Numeric	2	1
Case Number - Stratum	GV02		Alphanumeric	4	3
Vehicle Number	GV03		Numeric	2	7
Vehicle Model Year	GV04		Numeric	2	9
Vehicle Make	GV05		Numeric	2	11
Vehicle Model	GV06		Numeric	3	13
Body Type	GV07		Numeric	2	16
Vehicle Identification Number	GV08		Alphanumeric	17	18
Police Reported Vehicle Disposition	GV09		Numeric	1	35
Police Reported Travel Speed	GV10		Numeric	2	36
Police Reported Alcohol Presence	GV11		Numeric	1	38
Alcohol Test Result For Driver	GV12		Numeric	2	39
Speed Limit	GV13		Numeric	2	41
Attempted Avoidance Maneuver	GV14		Numeric	2	43
Accident Type	GV15		Numeric	2	45
Driver Presence in Vehicle	GV16		Numeric	1	47
Number of Occupants This Vehicle	GV17		Numeric	2	48
Number of Occupant Forms Submitted	GV18		Numeric	2	50
Vehicle Curb Weight	GV19		Numeric	3	52
Vehicle Cargo Weight	GV20		Numeric	2	55
Towed Trailing Unit	GV21		Numeric	1	57
Documentation of Trajectory Data for This Vehicle	GV22		Numeric	1	58
Post Collision Condition of Tree or Pole (for Highest Delta V)	GV23		Numeric	1	59
Rollover	GV24		Numeric	1	60
Front Override/Underride (this vehicle)	GV25		Numeric	1	61
Rear Override/Underride (this vehicle)	GV26		Numeric	1	62
Heading Angle for This Vehicle	GV27		Numeric	3	63
Heading Angle for Other Vehicle	GV28		Numeric	3	66
Basis for Total Delta V (Highest)	GV29		Numeric	1	69
Total Delta V	GV30		Numeric	2	70
Longitudinal Component of Delta V	GV31		Numeric	3	72
Lateral Component of Delta V	GV32		Numeric	3	75
Energy Absorption	GV33		Numeric	4	78
Confidence In Reconstruction Program Results(for Highest Delta V)	GV34		Numeric	1	82
Type of Vehicle Inspection	GV35		Numeric	1	83
Is This an AOPS Vehicle?	GV36		Numeric	1	84
Police Reported Other Drug Presence	GV37		Numeric	1	85
Police Reported Drug Evaluation Classification Test for Driver	GV38		Numeric	1	86
Other Drug Specimen Test Type for Driver	GV39		Numeric	1	87
Narcotic Drug DEC Test Results	GV40		Numeric	1	88
Narcotic Drug Specimen Test Results	GV41		Numeric	1	89
Depressant Drug DEC Test Results	GV42		Numeric	1	90
Depressant Drug Specimen Test Results	GV43		Numeric	1	91
Stimulant Drug DEC Test Results	GV44		Numeric	1	92
Stimulant Drug Specimen Test Results	GV45		Numeric	1	93
Hallucinogen Drug DEC Test Results	GV46		Numeric	1	94
Hallucinogen Drug Specimen Test Results	GV47		Numeric	1	95
Cannabinoid Drug DEC Test Results	GV48		Numeric	1	96
Cannabinoid Drug Specimen Test Results	GV49		Numeric	1	97
Phencyclidine (PCP) Drug DEC Test Results	GV50		Numeric	1	98
Phencyclidine (PCP) Drug Specimen Test Results	GV51		Numeric	1	99
Inhalant Drug DEC Test Results	GV52		Numeric	1	100
Inhalant Drug Specimen Test Results	GV53		Numeric	1	101
Other Drug DEC Test Results	GV54		Numeric	1	102
Other Drug Specimen Test Results	GV55		Numeric	1	103
Driver's Zip Code	GV56		Numeric	5	104
Driver's Race/Ethnic Origin	GV57		Numeric	1	109
Vehicle Special Use (This Trip)	GV58		Numeric	1	110
Rollover Initiation Type	GV59		Numeric	1	111
Location of Rollover Initiation	GV60		Numeric	1	112
Rollover Initiation Object Contacted	GV61		Numeric	2	113
Location on Vehicle Where Initial Principal Tripping Force Is Applied	GV62		Numeric	1	115
Direction of Initial Roll	GV63		Numeric	1	116
Pre-Event Movement (Prior to Recognition of Critical Event)	GV64		Numeric	2	117
Critical Precrash Event	GV65		Numeric	2	119
Precrash Stability After Avoidance Maneuver	GV66		Numeric	1	121
Precrash Directional Consequences of Avoidance Maneuver	GV67		Numeric	1	122

NASS CDS VARIABLE COMPUTER FORMATS - Continued

Exterior Vehicle Form

Name	Variable Identifier	SAS Variable Number	Variable Type	Variable Column Length	Beginning Column Number
Primary Sampling Unit Number	EV01		Numeric	2	1
Case Number - Stratum	EV02		Alphanumeric	4	3
Vehicle Number	EV03		Numeric	2	7
1st C.D.C. - Accident Event Sequence Number	EV04		Numeric	2	9
1st C.D.C. - Object Contacted	EV05		Numeric	2	11
1st C.D.C. - Direction of Force	EV06		Numeric	2	13
1st C.D.C. - Deformation Location	EV07		Alphanumeric	1	15
1st C.D.C. - Specific Longitudinal or Lateral Location	EV08		Alphanumeric	1	16
1st C.D.C. - Specific Vertical or Lateral Location	EV09		Alphanumeric	1	17
1st C.D.C. - Type of Damage Distribution	EV10		Alphanumeric	1	18
1st C.D.C. - Deformation Extent	EV11		Numeric	2	19
2nd C.D.C. - Accident Event Sequence Number	EV12		Numeric	2	21
2nd C.D.C. - Object Contacted	EV13		Numeric	2	23
2nd C.D.C. - Direction of Force	EV14		Numeric	2	25
2nd C.D.C. - Deformation Location	EV15		Alphanumeric	1	27
2nd C.D.C. - Specific Longitudinal or Lateral Location	EV16		Alphanumeric	1	28
2nd C.D.C. - Specific Vertical or Lateral Location	EV17		Alphanumeric	1	29
2nd C.D.C. - Type of Damage Distribution	EV18		Alphanumeric	1	30
2nd C.D.C. - Deformation Extent	EV19		Numeric	2	31
1st Crush Profile - L	EV20		Numeric	3	33
1st Crush Profile - C1-C6	EV21		Numeric	12	36
1st Crush Profile - D	EV22		Numeric	4	48
2nd Crush Profile - L	EV23		Numeric	3	52
2nd Crush Profile - C1-C6	EV24		Numeric	12	55
2nd Crush Profile - D	EV25		Numeric	4	67
Are CDCs Documented but Not Coded on The Automated File?	EV26		Numeric	1	71
Researcher's Assessment of Vehicle Disposition	EV27		Numeric	1	72
Original Wheelbase	EV28		Numeric	4	73
Is This A Multi-Stage Manufactured Vehicle And/Or A Certified Altered Vehicle?	EV29		Numeric	1	74
Fire Occurrence	EV30		Numeric	1	75
Origin of Fire	EV31		Numeric	1	76
Type of Fuel Tank-1	EV32		Numeric	1	77
Type of Fuel Tank-2	EV33		Numeric	1	78
Fuel Tank-1 Location	EV34		Numeric	1	79
Fuel Tank-2 Location	EV35		Numeric	1	80
Fuel Tank-1 Filler Cap Location	EV36		Numeric	1	81
Fuel Tank-2 Filler Cap Location	EV37		Numeric	1	82
Fuel Tank-1 Damage	EV38		Numeric	1	83
Fuel Tank-2 Damage	EV39		Numeric	1	84
Location of Fuel System-1 Leakage	EV40		Numeric	1	85
Location of Fuel System-2 Leakage	EV41		Numeric	1	86
Fuel Type-1	EV42		Numeric	2	87
Fuel Type-2	EV43		Numeric	2	88
Is This Vehicle Equipped With More Than Two Fuel Tanks?	EV44		Numeric	1	90

NASS CDS VARIABLE COMPUTER FORMATS - Continued

Interior Vehicle Form

Name	SAS		Variable Column Length	Beginning Column Number	
	Variable Identifier	Variable Number			Variable Type
Primary Sampling Unit Number	IV01		Numeric	2	1
Case Number - Stratum	IV02		Alphanumeric	4	3
Vehicle Number	IV03		Numeric	2	7
Passenger Compartment Integrity	IV04		Numeric	2	9
Door, Tailgate or Hatch Opening - LF	IV05		Numeric	1	11
Door, Tailgate or Hatch Opening - RF	IV06		Numeric	1	12
Door, Tailgate or Hatch Opening - LR	IV07		Numeric	1	13
Door, Tailgate or Hatch Opening - RR	IV08		Numeric	1	14
Door, Tailgate or Hatch Opening - TG/H	IV09		Numeric	1	15
Damage/Failure Associated With D/TG/H Opening In Collision - LF	IV10		Numeric	1	16
Damage/Failure Associated With D/TG/H Opening In Collision - RF	IV11		Numeric	1	17
Damage/Failure Associated With D/TG/H Opening In Collision - LR	IV12		Numeric	1	18
Damage/Failure Associated With D/TG/H Opening In Collision - RR	IV13		Numeric	1	19
Damage/Failure Associated With D/TG/H Opening In Collision - TG/H	IV14		Numeric	1	20
Glazing Damage from Impact Forces - WS	IV15		Numeric	1	21
Glazing Damage from Impact Forces - LF	IV16		Numeric	1	22
Glazing Damage from Impact Forces - RF	IV17		Numeric	1	23
Glazing Damage from Impact Forces - LR	IV18		Numeric	1	24
Glazing Damage from Impact Forces - RR	IV19		Numeric	1	25
Glazing Damage from Impact Forces - BL	IV20		Numeric	1	26
Glazing Damage from Impact Forces - Roof	IV21		Numeric	1	27
Glazing Damage from Impact Forces - Other	IV22		Numeric	1	28
Glazing Damage from Occupant Contact - WS	IV23		Numeric	1	29
Glazing Damage from Occupant Contact - LF	IV24		Numeric	1	30
Glazing Damage from Occupant Contact - RF	IV25		Numeric	1	31
Glazing Damage from Occupant Contact - LR	IV26		Numeric	1	32
Glazing Damage from Occupant Contact - RR	IV27		Numeric	1	33
Glazing Damage from Occupant Contact - BL	IV28		Numeric	1	34
Glazing Damage from Occupant Contact - Roof	IV29		Numeric	1	35
Glazing Damage from Occupant Contact - Other	IV30		Numeric	1	36
Type of Window/Windshield Glazing - WS	IV31		Numeric	1	37
Type of Window/Windshield Glazing - LF	IV32		Numeric	1	38
Type of Window/Windshield Glazing - RF	IV33		Numeric	1	39
Type of Window/Windshield Glazing - LR	IV34		Numeric	1	40
Type of Window/Windshield Glazing - RR	IV35		Numeric	1	41
Type of Window/Windshield Glazing - BL	IV36		Numeric	1	42
Type of Window/Windshield Glazing - Roof	IV37		Numeric	1	43
Type of Window/Windshield Glazing - Other	IV38		Numeric	1	44
Window Precrash Glazing Status - WS	IV39		Numeric	1	45
Window Precrash Glazing Status - LF	IV40		Numeric	1	46
Window Precrash Glazing Status - RF	IV41		Numeric	1	47
Window Precrash Glazing Status - LR	IV42		Numeric	1	48
Window Precrash Glazing Status - RR	IV43		Numeric	1	49
Window Precrash Glazing Status - BL	IV44		Numeric	1	50
Window Precrash Glazing Status - Roof	IV45		Numeric	1	51
Window Precrash Glazing Status - Other	IV46		Numeric	1	52
1st Location of Intrusion	IV47		Numeric	2	53
1st Intruding Component	IV48		Numeric	2	55
1st Magnitude of Intrusion	IV49		Numeric	1	57
1st Dominant Crush Direction	IV50		Numeric	1	58
2nd Location of Intrusion	IV51		Numeric	2	59
2nd Intruding Component	IV52		Numeric	2	61
2nd Magnitude of Intrusion	IV53		Numeric	1	63
2nd Dominant Crush Direction	IV54		Numeric	1	64
3rd Location of Intrusion	IV55		Numeric	2	65
3rd Intruding Component	IV56		Numeric	2	67
3rd Magnitude of Intrusion	IV57		Numeric	1	69
3rd Dominant Crush Direction	IV58		Numeric	1	70
4th Location of Intrusion	IV59		Numeric	2	71
4th Intruding Component	IV60		Numeric	2	73
4th Magnitude of Intrusion	IV61		Numeric	1	75
4th Dominant Crush Direction	IV62		Numeric	1	76
5th Location of Intrusion	IV63		Numeric	2	77
5th Intruding Component	IV64		Numeric	2	79
5th Magnitude of Intrusion	IV65		Numeric	1	81
5th Dominant Crush Direction	IV66		Numeric	1	82

NASS CDS VARIABLE COMPUTER FORMATS - Continued

Interior Vehicle Form (Continued)

Name	SAS			Variable Column Length	Beginning Column Number
	Variable Identifier	Variable Number	Variable Type		
6th Location of Intrusion	IV67		Numeric	2	83
6th Intruding Component	IV68		Numeric	2	85
6th Magnitude of Intrusion	IV69		Numeric	1	87
6th Dominant Crush Direction	IV70		Numeric	1	88
7th Location of Intrusion	IV71		Numeric	2	89
7th Intruding Component	IV72		Numeric	2	91
7th Magnitude of Intrusion	IV73		Numeric	1	93
7th Dominant Crush Direction	IV74		Numeric	1	94
8th Location of Intrusion	IV75		Numeric	2	95
8th Intruding Component	IV76		Numeric	2	97
8th Magnitude of Intrusion	IV77		Numeric	1	99
8th Dominant Crush Direction	IV78		Numeric	1	100
9th Location of Intrusion	IV79		Numeric	2	101
9th Intruding Component	IV80		Numeric	2	103
9th Magnitude of Intrusion	IV81		Numeric	1	105
9th Dominant Crush Direction	IV82		Numeric	1	106
10th Location of Intrusion	IV83		Numeric	2	107
10th Intruding Component	IV84		Numeric	2	109
10th Magnitude of Intrusion	IV85		Numeric	1	111
10th Dominant Crush Direction	IV86		Numeric	1	112
Steering Column Type	IV87		Numeric	1	113
BLANK	IV88		Numeric	2	114
BLANK	IV89		Numeric	3	116
BLANK	IV90		Numeric	3	119
BLANK	IV91		Numeric	3	122
Steering Rim/Spoke Deformation	IV92		Numeric	1	125
Location of Steering Rim/Spoke Deformation	IV93		Numeric	2	126
Odometer Reading	IV94		Numeric	3	128
Instrument Panel Damage from Occupant Contact?	IV95		Numeric	1	131
Knee Bolsters Deformed from Occupant Contact?	IV96		Numeric	1	132
Did Glove Compartment Door Opened During Collision(s)?	IV97		Numeric	1	133

NASS CDS VARIABLE COMPUTER FORMATS - Continued

Occupant Assessment Form

Name	Variable Identifier	SAS		Variable Column Length	Beginning Column Number
		Variable Number	Variable Type		
Primary Sampling Unit Number	OA01		Numeric	2	1
Case Number - Stratum	OA02		Alphanumeric	4	3
Vehicle Number	OA03		Numeric	2	7
Occupant Number	OA04		Numeric	2	9
Occupant's Age	OA05		Numeric	2	11
Occupant's Sex	OA06		Numeric	1	13
Occupant's Height	OA07		Numeric	2	14
Occupant's Weight	OA08		Numeric	3	16
Occupant's Role	OA09		Numeric	1	19
Occupant's Seat Position	OA10		Numeric	2	20
Occupant's Posture	OA11		Numeric	1	22
Ejection	OA12		Numeric	1	23
Ejection Area	OA13		Numeric	1	24
Ejection Medium	OA14		Numeric	1	25
Medium Status (Immediately Prior to Impact)	OA15		Numeric	1	26
Entrapment	OA16		Numeric	1	27
Manual (Active) Belt System Availability	OA17		Numeric	1	28
Manual (Active) Belt System Use	OA18		Numeric	2	29
Proper Use of Manual (Active) Belts	OA19		Numeric	1	31
Manual (Active) Belt Failure Modes During Impact	OA20		Numeric	1	32
Air Bag System Availability/Function	OA21		Numeric	1	33
Air Bag System Deployment	OA22		Numeric	1	34
Are There Indications of Air Bag System Failure?	OA23		Numeric	1	35
Police Reported Restraint Use	OA24		Numeric	1	36
Head Restraint Type/Damage by Occupant at This Occupant Position	OA25		Numeric	1	37
Seat Type (This Occupant Position)	OA26		Numeric	2	38
Seat Performance (This Occupant Position)	OA27		Numeric	1	40
Child Safety Seat Make/Model	OA28		Numeric	3	41
Type of Child Safety Seat	OA29		Numeric	1	44
Child Safety Seat Orientation	OA30		Numeric	2	45
Child Safety Seat Harness Usage	OA31		Numeric	2	47
Child Safety Seat Shield Usage	OA32		Numeric	2	49
Child Safety Seat Tether Usage	OA33		Numeric	2	51
Injury Severity (Police Rating)	OA34		Numeric	1	53
Treatment - Mortality	OA35		Numeric	1	54
Type Of Medical Facility (for Initial Treatment)	OA36		Numeric	1	55
Hospital Stay	OA37		Numeric	2	56
Working Days Lost	OA38		Numeric	2	58
Time to Death	OA39		Numeric	2	60
1st Medically Reported Cause of Death	OA40		Numeric	2	62
2nd Medically Reported Cause of Death	OA41		Numeric	2	64
3rd Medically Reported Cause of Death	OA42		Numeric	2	66
Number of Recorded Injuries for This Occupant	OA43		Numeric	2	68
Automatic (Passive) Belt System Availability/Function	OA44		Numeric	1	69
Automatic (Passive) Belt System Use	OA45		Numeric	1	70
Automatic (Passive) Belt System Type	OA46		Numeric	1	71
Proper Use of Automatic (Passive) Belt System	OA47		Numeric	1	72
Automatic (Passive) Belt Failure Modes During Accident	OA48		Numeric	1	73
Seat Orientation (this Occupant Position)	OA49		Numeric	1	74
Glasgow Coma Scale (GCS) Score (at Medical Facility)	OA50		Numeric	2	75
Was the Occupant Given Blood?	OA51		Numeric	1	77
Arterial Blood Gases (ABG) - HCO ₃	OA52		Numeric	1	78
Primary Source of Belt Use Determination	OA53		Numeric	1	79

NASS CDS VARIABLE COMPUTER FORMATS - Continued

Occupant Injury Form

Name	Variable Identifier	SAS		Variable Column Length	Beginning Column Number
		Variable Number	Variable Type		
Primary Sampling Unit Number	0101		Numeric	2	1
Case Number - Stratum	0102		Alphanumeric	4	3
Vehicle Number	0103		Numeric	2	7
Occupant Number	0104		Numeric	2	9
1st Source of Injury Data	0105		Numeric	1	11
1st Body Region	0106		Numeric	1	12
1st Type of Anatomic Structure	0107		Numeric	1	13
1st Specific Anatomic Structure	0108		Numeric	2	14
1st Level of Injury	0109		Numeric	2	16
1st Abbreviated Injury Scale Severity	0110		Numeric	1	18
1st Aspect	0111		Numeric	1	19
1st Injury Source	0112		Numeric	2	20
1st Injury Source Confidence Level	0113		Numeric	1	22
1st Direct/Indirect Injury	0114		Numeric	1	23
1st Occupant Area Intrusion Number	0115		Numeric	2	24
2nd Source of Injury Data	0116		Numeric	1	26
2nd Body Region	0117		Numeric	1	27
2nd Type of Anatomic Structure	0118		Numeric	1	28
2nd Specific Anatomic Structure	0119		Numeric	2	29
2nd Level of Injury	0120		Numeric	2	31
2nd Abbreviated Injury Scale Severity	0121		Numeric	1	33
2nd Aspect	0122		Numeric	1	34
2nd Injury Source	0123		Numeric	2	35
2nd Injury Source Confidence Level	0124		Numeric	1	37
2nd Direct/Indirect Injury	0125		Numeric	1	38
2nd Occupant Area Intrusion Number	0126		Numeric	2	39
3rd Source of Injury Data	0127		Numeric	1	41
3rd Body Region	0128		Numeric	1	42
3rd Type of Anatomic Structure	0129		Numeric	1	43
3rd Specific Anatomic Structure	0130		Numeric	2	44
3rd Level of Injury	0131		Numeric	2	46
3rd Abbreviated Injury Scale Severity	0132		Numeric	1	48
3rd Aspect	0133		Numeric	1	49
3rd Injury Source	0134		Numeric	2	50
3rd Injury Source Confidence Level	0135		Numeric	1	52
3rd Direct/Indirect Injury	0136		Numeric	1	53
3rd Occupant Area Intrusion Number	0137		Numeric	2	54
4th Source of Injury Data	0138		Numeric	1	56
4th Body Region	0139		Numeric	1	57
4th Type of Anatomic Structure	0140		Numeric	1	58
4th Specific Anatomic Structure	0141		Numeric	2	59
4th Level of Injury	0142		Numeric	2	61
4th Abbreviated Injury Scale Severity	0143		Numeric	1	63
4th Aspect	0144		Numeric	1	64
4th Injury Source	0145		Numeric	2	65
4th Injury Source Confidence Level	0146		Numeric	1	67
4th Direct/Indirect Injury	0147		Numeric	1	68
4th Occupant Area Intrusion Number	0148		Numeric	2	69
5th Source of Injury Data	0149		Numeric	1	71
5th Body Region	0150		Numeric	1	72
5th Type of Anatomic Structure	0151		Numeric	1	73
5th Specific Anatomic Structure	0152		Numeric	2	74
5th Level of Injury	0153		Numeric	2	76
5th Abbreviated Injury Scale Severity	0154		Numeric	1	78
5th Aspect	0155		Numeric	1	79
5th Injury Source	0156		Numeric	2	80
5th Injury Source Confidence Level	0157		Numeric	1	82
5th Direct/Indirect Injury	0158		Numeric	1	83
5th Occupant Area Intrusion Number	0159		Numeric	2	84

NASS CDS VARIABLE COMPUTER FORMATS - Continued

Occupant Injury Form (Continued)

Name	Variable Identifier	SAS Variable Number	Variable Type	Variable Column Length	Beginning Column Number
6th Source of Injury Data	0160		Numeric	1	86
6th Body Region	0161		Numeric	1	87
6th Type of Anatomic Structure	0162		Numeric	1	88
6th Specific Anatomic Structure	0163		Numeric	2	89
6th Level of Injury	0164		Numeric	2	91
6th Abbreviated Injury Scale Severity	0165		Numeric	1	93
6th Aspect	0166		Numeric	1	94
6th Injury Source	0167		Numeric	2	95
6th Injury Source Confidence Level	0168		Numeric	1	97
6th Direct/Indirect Injury	0169		Numeric	1	98
6th Occupant Area Intrusion Number	0170		Numeric	2	99
7th Source of Injury Data	0171		Numeric	1	101
7th Body Region	0172		Numeric	1	102
7th Type of Anatomic Structure	0173		Numeric	1	103
7th Specific Anatomic Structure	0174		Numeric	2	104
7th Level of Injury	0175		Numeric	2	106
7th Abbreviated Injury Scale Severity	0176		Numeric	1	108
7th Aspect	0177		Numeric	1	109
7th Injury Source	0178		Numeric	2	110
7th Injury Source Confidence Level	0179		Numeric	1	112
7th Direct/Indirect Injury	0180		Numeric	1	113
7th Occupant Area Intrusion Number	0181		Numeric	2	114
8th Source of Injury Data	0182		Numeric	1	116
8th Body Region	0183		Numeric	1	117
8th Type of Anatomic Structure	0184		Numeric	1	118
8th Specific Anatomic Structure	0185		Numeric	2	119
8th Level of Injury	0186		Numeric	2	121
8th Abbreviated Injury Scale Severity	0187		Numeric	1	123
8th Aspect	0188		Numeric	1	124
8th Injury Source	0189		Numeric	2	125
8th Injury Source Confidence Level	0190		Numeric	1	127
8th Direct/Indirect Injury	0191		Numeric	1	128
8th Occupant Area Intrusion Number	0192		Numeric	2	129
9th Source of Injury Data	0193		Numeric	1	131
9th Body Region	0194		Numeric	1	132
9th Type of Anatomic Structure	0195		Numeric	1	133
9th Specific Anatomic Structure	0196		Numeric	2	134
9th Level of Injury	0197		Numeric	2	136
9th Abbreviated Injury Scale Severity	0198		Numeric	1	138
9th Aspect	0199		Numeric	1	139
9th Injury Source	01100		Numeric	2	140
9th Injury Source Confidence Level	01101		Numeric	1	142
9th Direct/Indirect Injury	01102		Numeric	1	143
9th Occupant Area Intrusion Number	01103		Numeric	2	144
10th Source of Injury Data	01104		Numeric	1	146
10th Body Region	01105		Numeric	1	147
10th Type of Anatomic Structure	01106		Numeric	1	148
10th Specific Anatomic Structure	01107		Numeric	2	149
10th Level of Injury	01108		Numeric	2	151
10th Abbreviated Injury Scale Severity	01109		Numeric	1	153
10th Aspect	01110		Numeric	1	154
10th Injury Source	01111		Numeric	2	155
10th Injury Source Confidence Level	01112		Numeric	1	157
10th Direct/Indirect Injury	01113		Numeric	1	158
10th Occupant Area Intrusion Number	01114		Numeric	2	159

APPENDIX
VALUE TABLES
VERSION 7.1

TABLE A1
OCCUPANT AGE, SEX, HEIGHT
(CONSISTENCY CHECK: HH002)
(VERSION: 7.1)

AGE (OA05)	SEX (OA06)	HEIGHT (OA07)	CHANGE VERSION
0	1	038-086,	999
1	1	061-099,	999
2	1	071-109,	999
3	1	076-117,	999
4	1	086-124,	999
5	1	091-130,	999
6	1	091-137,	999
7	1	097-142,	999
8	1	107-147,	999
9	1	114-155,	999
10	1	119-160,	999
11	1	122-168,	999
12	1	122-175,	999
13	1	135-183,	999
14	1	140-188,	999
15	1	147-191,	999
16	1	152-193,	999
17-97	1	152-196,	999
0	2	036-086,	999
1	2	061-099,	999
2	2	071-107,	999
3	2	076-114,	999
4	2	086-122,	999
5	2	091-130,	999
6	2	091-135,	999
7	2	104-142,	999
8	2	107-150,	999
9	2	114-155,	999
10	2	122-163,	999
11	2	124-170,	999
12	2	132-175,	999
13	2	137-178,	999
14-97	2	140-183,	999

NASS CDS Value Tables

TABLE A2
 OCCUPANT AGE, SEX, WEIGHT
 (CONSISTENCY CHECK: HH007)
 (VERSION: 7.1)

HEIGHT (OA07)	SEX (OA06)	WEIGHT (OA08)	CHANGE VERSION
000-052	1	002-014, 999	
053-074	1	005-018, 999	
075-090	1	007-023, 999	
091-105	1	011-027, 999	
106-120	1	014-034, 999	
121-140	1	020-045, 999	
141-151	1	025-059, 999	
152-158	1	029-068, 999	
159-161	1	039-077, 999	
162-166	1	041-082, 999	
167-168	1	043-091, 999	
169-171	1	048-091, 999	
172-173	1	048-113, 999	
174-179	1	052-136, 999	
180-181	1	054-136, 999	
182-184	1	057-136, 999	
185-220	1	061-136, 999	
000-052	2	002-014, 999	
053-074	2	005-018, 999	
075-090	2	005-023, 999	
091-105	2	007-027, 999	
106-120	2	014-034, 999	
121-140	2	018-045, 999	
141-151	2	027-068, 999	
152-153	2	036-086, 999	
154-158	2	036-095, 999	
159-163	2	036-100, 999	
164-166	2	039-100, 999	
167-173	2	041-100, 999	
174-176	2	043-100, 999	
177-179	2	045-100, 999	
180-220	2	050-100, 999	

TABLE A4
 BODY TYPE
 BY
 VEHICLE CURB WEIGHT
 (CONSISTENCY CHECK: GGO08)
 (VERSION: 7.1)

BODY TYPE (GV07)	ACCEPTABLE RANGE FOR VEHICLE CURB WEIGHT (GV19)	CHANGE VERSION
01-10	054-272, 999	
11	091-272, 999	
12	181-363, 999	
14	068-227, 999	
15	113-272, 999	
16	136-318, 999	
20	091-227, 999	
21, 22, 28, 29	091-272, 999	
30	091-204, 999	
31	113-249, 999	
33	091-204, 999	
39	091-272, 999	
40-42, 45, 48, 49	091-454, 999	

TABLE A5
 NASS VALID OIC COMBINATIONS
 (CONSISTENCY CHECK: TT002)
 (VERSION: 7.1)

For valid combinations of Body Region, Type of Structure, Specific Structure, Level of Injury, A.I.S. Severity and Aspect, See the current Injury Coding Manual.

TABLE A-6
 1ST DIRECTION OF FORCE(EV06)
 BY
 ARCTANGENT(LATERAL DELTA V[GV32]/LONGITUDINAL DELTA V[GV31])
 (CONSISTENCY CHECKS: GE017,GE018)
 (VERSION: 7.1)

If EV06	then	arctan(GV32/GV31) in degrees	and	arctan(GV32/GV31) in degrees	CHANGE VERSION
06	GT	- 22.5		LT 22.5	
07	GT	7.5		LT 52.5	
08	GT	37.5		LT 82.5	
09	GT	67.5		LT 112.5	
10	GT	97.5		LT 142.5	
11	GT	127.5		LT 172.5	
12	GT	157.5		LT 202.5	
01	GT	187.5		LT 232.5	
02	GT	217.5		LT 262.5	
03	GT	247.5		LT 292.5	
04	GT	277.5		LT 322.5	
05	GT	307.5		LT 352.5	

TABLE A-7
 VEHICLE MAKE
 BY
 BODY TYPE
 (CONSISTENCY CHECK: GG005)
 (VERSION: 7.1)

MAKE (GV05)	BODY TYPE (GV07)	VERSION
01	01-09, 99	
02	14-16, 19, 31, 32, 39, 45, 48, 49, 99	
03	14, 15, 19, 21, 22, 28, 41, 45, 48, 49, 58-60, 63, 78, 99	
06	01-09, 20, 29, 99	
07	01-12, 14-16, 19-25, 28-33, 39-42, 45, 48-50, 58-79, 99	
08	01, 02, 04, 08, 09, 12, 99	
09	01-12, 15, 16, 19-21, 23, 28-30, 32, 33, 39, 42, 45, 48, 49, 99	
10	02-05, 07-09, 20, 99	
12	01-16, 19-25, 28-33, 39-42, 45, 48-50, 58-79, 92, 93, 97, 99	
13	01, 02, 04, 08, 09, 11, 12, 99	
14	01-09, 11, 12, 20, 99	
18	01-09, 11, 12, 99	
19	01-09, 11, 12, 99	
20	01-16, 19-25, 28-33, 39-42, 45, 48-50, 58-79, 99	
21	01-09, 11, 12, 14, 20, 29, 99	
22	01-09, 11, 12, 20, 29, 99	
23	10, 11, 14-16, 19-25, 28-33, 39-42, 45, 48-50, 58-79, 99	
24	01-09, 99	
25	22, 29, 49-79, 99	
30	01-10, 14, 19, 20, 28, 29, 99	
31	01-05, 07-09, 99	
32	01-09, 99	
33	01-05, 07-09, 99	
34	01, 02, 04, 08, 09, 80, 89, 99	
35	01-09, 14, 19, 20, 29, 30, 32, 33, 39, 40, 42, 45, 48, 49, 63, 78, 79, 99	
36	01-09, 61-64, 67-78, 99	
37	01-09, 14, 80-90, 99	7.1
38	01-09, 14, 30, 32, 33, 39, 40, 42, 45, 48, 49, 58, 61-64, 78, 79, 99	
39	01, 02, 04, 08, 09, 99	
40	01-04, 07-09, 99	
41	01-09, 14, 19, 20, 29, 30, 32, 33, 39, 40, 42, 45, 48, 49, 99	
42	01, 02, 04, 06, 08, 09, 12, 28, 29, 58, 59, 61-64, 67-79, 93, 97, 99	

TABLE A-7
 VEHICLE MAKE
 BY
 BODY TYPE
 (Continued)

43	01, 02, 08, 09, 99
44	04-09, 81, 99
45	01-03, 07-09, 99
46	01-09, 99
47	01-09, 99
48	01-10, 99
49	01-09, 14, 15, 19, 20, 30-33, 39, 40, 42, 45, 48, 49, 99
50	01, 02, 04, 08, 09, 80, 82, 89, 99
51	02, 04, 06, 08, 09, 58, 59, 61-64, 78, 99
52	02-09, 14, 19, 20, 28-30, 32, 33, 39, 40, 42, 45, 48, 49, 61-64, 78, 79, 99
53	01-09, 14, 19, 80-82, 88-90, 99
54	01-05, 07-09, 99
55	02-05, 07-09, 99
56	01-05, 07-09, 99
57	01, 03, 07-09, 99
58	02, 04, 09, 99
59	02, 04, 09, 99
60	03, 04, 09, 14, 19, 99
61	02, 04, 05, 09, 99
70	80, 88, 89, 99
71	80, 88, 89, 99
72	80, 88, 89, 99
73	80-82, 88-90, 99
74	80, 88, 89, 99
75	80, 88, 89, 99
76	80-82, 88-90, 97, 99
78	81
79	80-82, 88, 89
80	61-64, 67-78, 99
81	61-64, 67-78, 99
82	61-64, 67-78, 99
83	63, 67-78, 99
84	15, 16, 19, 22, 24, 25, 31, 32, 39-42, 45, 48-50, 58-79, 92, 93, 97, 99
85	61-64, 67-78, 99
86	61-64, 67-78, 99
87	61-64, 67-78, 99
88	61-64, 67-78, 99

NASS CDS Value Tables

TABLE 11
 ACCIDENT TYPE PAIRS
 (CONSISTENCY CHECK: GG032)
 (VERSION: 7.1)

ONE ACCIDENT TYPE (GV15[m])	OTHER ACCIDENT TYPE (GV15[n])	CHANGE VERSION
-----	-----	-----
20	21, 22, 23	
24	25, 26, 27	
28	29, 30, 31	
32	32	
33	33	
34	35	
36	37	
38	39	
40	41	
42	42	
43	43	
44	45	
46	45, 47	
47	45, 46	
48	48	
49	49	
50	51	
52	52	
53	53	
54	55	
56	57	
58	59	
60	61	
62	62	
63	63	
64	65	
66	66	
67	67	
68	69	
70	71	
72	73	
74	74	
75	75	
76	77	
78	79	
80	81	
82	83	
84	84	
85	85	
86	87	
88	89	
90	90	
91	91	

NASS CDS Value Tables

TABLE 12
 VIN CHECK DIGIT ALGORITHM
 (CONSISTENCY CHECK: GG091)
 (VERSION: 7.1)

THE CHECK DIGIT ALGORITHM APPLIES TO MODEL YEAR 1981 OR LATER VEHICLES WITH 17 DIGIT VINS. EACH NUMBER OR LETTER IN THE VIN HAS A VALUE AND EACH PLACE OR POSITION HAS A WEIGHT. EACH WEIGHT IS MULTIPLIED BY THE VALUE OF THE NUMBER OR LETTER IN THAT VIN POSITION. THE TOTALS IN EACH VIN POSITION ARE THEN ADDED TOGETHER AND THE GRAND TOTAL IS DIVIDED BY 11. THE REMAINDER MUST BE THE SAME AS THE NUMBER APPEARING IN THE CHECK DIGIT (THE NINTH VIN POSITION). WHEN THE REMAINDER IS 10, THE CHECK DIGIT WILL CONTAIN AN 'X'.

CHARACTER	VALUE	POSITION	WEIGHT
A	1	1	8
B	2	2	7
C	3	3	6
D	4	4	5
E	5	5	4
F	6	6	3
G	7	7	2
H	8	8	10
J	1	9	0
K	2	10	9
L	3	11	8
M	4	12	7
N	5	13	6
P	7	14	5
R	9	15	4
S	2	16	3
T	3	17	2
U	4		
V	5		
W	6		
X	7		
Y	8		
Z	9		
0	0		
1	1		
2	2		
3	3		
4	4		
5	5		
6	6		
7	7		
8	8		
9	9		

TABLE A-14
 VEHICLE CLASS AND CONTACTED CLASS
 BY
 BODY TYPE
 (CONSISTENCY CHECKS: AG027, AG028)
 (VERSION: 7.1)

VEHICLE CLASS (AC13)[n] CONTACTED CLASS (AC17)[n]	BODY TYPE (GV07)	CHANGE VERSION
01-09	01-13	
11	14, 19	
12	15, 16	
13	20, 21, 24, 25, 29	
14	20-23, 28	
15	30-33, 39	
18	40-42, 45	
19	48	
20	50	
21	58, 59	
22	60-65, 78, 79	
23	67	
24	68-70	
25	80-82, 88, 89	
28	90-93, 97	
99	49, 99	

NASS CDS Value Tables

TABLE A-15
 INTRUDING COMPONENT
 BY
 INJURY SOURCE
 (CONSISTENCY CHECK: CT009)
 (VERSION: 7.1)

INTRUDING COMPONENT (IV48)[n]	INJURY SOURCE (OI12)[n]	CHANGE VERSION
01	04, 05, 06, 07, 14	
02	08, 09, 13, 14, 58	
03	08, 10, 13	
04	08, 11, 12, 13, 15	
05	56, 59	
06	14, 15, 22, 26, 32, 36	
07	23, 26, 33, 36, 42	
08	24, 34	
09	24, 34	
10	20, 21, 26, 28, 30, 31, 36, 38	
12	54	
13	26, 36, 52, 53	
14	01, 02, 14, 15, 18	
15	14, 15, 18, 50	
16	25, 26, 35, 36	
17	56, 57	
18	51, 60	
19	40, 44	
20	40, 44	
21	40	
22	40	
23	40	
24	40	
25	61,62	
26	19, 24, 27, 34, 37, 49, 57, 62	
27	20, 30	
28	20, 21, 30, 31	
30	65	
31	66, 67	
32	70-82, 85	
33	83	
98	19, 27, 37, 49, 62	

NASS CDS Value Tables

TABLE A-16
 ACCIDENT TYPE
 BY
 DAMAGE AREA or CONTACTED AREA
 (CONSISTENCY CHECKS: AG047 & AG048)
 (VERSION: 7.1)

ACCIDENT TYPE (GV15)	DAMAGE AREA (AC15) CONTACTED AREA (AC18)	CHANGE VERSION
20, 24, 28, 34, 36, 38, 40, 50, 51, 54-61, 86, or 88	F, V	
21-23, 25-27, 29-31, 35, 37, 39, or 41	B, D, C	
87	R	
89	L	
OTHERS	ANY	

1/4/94

1994 NASS CDS DATA COLLECTION, CODING AND EDITING MANUAL
MODIFICATIONS, DELETIONS, AND ADDITIONS

Acknowledgement

Page i 3rd Paragraph Credit given to contributors

Description of the Sampling Frame

Page 32 3rd Paragraph Change in definition of late model year
Page 32 4-6th Paragraphs Classifying unknown vehicle model years for stratification purposes
Page 34 Tables 2-1, 2-2 Change in late model year specifications and table titles

Overview of Sampling Activities

Page 48 Table 3-1 Updated for 1994 sampling
Page 49 Table 3-2 Updated for 1994 sampling
Page 50 Table 3-3 Updated for 1994 sampling
Page 51 All paragraphs Change in data collection years
Page 57 Paragraph 4 Change in date of MDE manual
Page 58 Table 3-4 Updated version of 1994 ACSSR

Overview of Collected Information on Sampled CDS Accidents

Page 65 Paragraph 2, 8 References to nontowed AOPS are deleted
Page 66 Table 4-1 Form requirements for nontowed AOPS are deleted
Page 69 Paragraph 1-3 References to nontowed AOPS are deleted
Page 70 Paragraph 6 References to AOPS are deleted
Page 71 Paragraph 1 Other Updatable variables (GV12 & GV39) are added
Page 73 Addresses Mailing address for Zone Center 2 is added

CDS Submission Instructions

Page 80 Paragraph 7 Submission dates are changed
Page 80 Paragraph 8 1994 submission schedule is changed to weekly
Page 81 Paragraph 1, 2 1994 submission schedule is changed to weekly
Page 81 Paragraph 2 Reference to table 5-3 update
Page 81 Paragraph 7 Editorial changes to last three lines
Page 82-83 Table 5-2 Updated 1994 case submission schedule
Page 84-85 Table 5-3 Updated 1994 file closeout schedule
Page 86 Table 5-4 Updated version of 1994 Administrative Log-A
Page 87 Paragraph 1 Change in mailing addresses for Zone Centers

GES Quality Control and Submission Instructions

Page 91-98 All Revised 1994 GES instructions for PSUs

Accident Form

AC-1 "Zone Center Three" changed to "Zone Center Two"
AC-2 Range Allowable Case Numbers are changed to "001-500"
AC-2 Paragraph 1 The case number range is changed to "001-500"
AC-2 Paragraph 4 Numbering sequence for regular CDS cases and special study cases are specified

1994 NASS CDS Manual

AC-4	Year	The precoded year is changed from "1993" to "1994"
AC-6/7	Def. SS16/17	The definition/criteria of the Pedestrian Crash Data Study and the Impact Fires study are given.
AC-9	Last Paragraph	Revised instructions for coding fire related events
AC-10	Paragraphs 2 & 4	The word "qualifying" is added before the words "accidents" and "events"
AC-17	Code 79	A code is added for objects that fell from a vehicle in-transport

General Vehicle Form

GV-2	Range	The range of allowable model years is increased to "95"
GV-3-54	Make/Models	See attached list of "1994 New Make/Models and Modifications".
GV-66	References 1 & 2	Addresses for obtaining reference manuals in items 1 & 2 are changed.
GV-75	Element Values	Code "00" (No impact) is deleted. This code should have been dropped with the 1993 data collection year.
GV-81	Codes "02" & "07"	The phrase "locked brakes", in line 5, is added.
GV-82	Code "98"	The phrase "or a noncollision" is added to the end of the third bullet.
GV-88	Addresses	Corrections are made to the 1st, 3rd, and 4th addresses for ordering reference manuals.
GV-114	Code "4"	Change in OLDMISS instructions
GV-117		The note, referring to form requirements for AOPS, at the end of the page is deleted
GV-163	Code "8"	The code is changed to clarify that all end-over-end accidents use code "8"
GV-167	Code "79"	A code is added for objects that fell from a vehicle in-transport
GV-172	Code "79"	The rollover definition of code "79" (Object fell from vehicle in-transport) is added.
GV-191	Code "10"	Code "10" is modified so that it reads similar to Code "09".
GV-191	Code "11"	The word "degrees", in the second line is changed to "degree".
GV-194	Paragraph 4	The 1st and 2nd sentences are modified.
GV-195	Code "11"	Code "11" is modified so that it reads similar to code "10".
GV-197	Codes "65"-"71"	Codes "65" through "71" are modified.
GV-198	Code "74"	Code "74" is modified.
GV-204		General Rules for Precrash Data Coding are added.

Exterior Vehicle Form

EV-8	Code "79"	Code "79" (Object fell from vehicle in-transport) is added.
EV-9	Paragraph 1	The sentence that restricted fire information to annotation only is deleted.
EV-9	Paragraph 4	Definition of noncollision events is added.

1994 NASS CDS Manual

EV-9	Code "32"	The definition and use of code "32" (Fire or explosion) is modified.
EV-10	Code "38"	The use of this code is restricted to consultation with the Zone Center.
EV-18	Code "79"	The definition of code "79" (Object fell from vehicle in-transport) is added.
EV-18	Code "88"	The phrase "sheared poles" is added to the end of code "88".
EV-43	Source	The source of information for this variable is expanded.
EV-43	All Paragraphs	Change in definition and qualifications for fire accidents in the NASS CDS.
EV-44	Code "9"	The definition of "unknown" for fire occurrence is modified.
EV-47		Variable EV33 (Type of Fuel Tank-2) is added to provide coding for a second fuel tank
EV-45	Source	The source of information for this variable is expanded.
EV-45	Code "0"	Code "0" is modified to address the non-occurrence of any fire, regardless of initiation source.
EV-45	Code "3"	Code "3" is modified.
EV-48	Code "0"	Code "0" is modified to allow coding of electrical vehicles with alternative or back-up fuel systems
EV-49/50	Variables EV32/33	Type of fuel tank has been identified for the following additional vehicles. Mustang (93-on) Some have HDPE Passat (92-on) HDPE Corrado (89-on) HDPE
EV-48-61	New Variables	The following variables are added to provide additional information on fuel system integrity: EV33 Type of Fuel Tank-2 EV34 Fuel Tank-1 Location EV35 Fuel Tank-2 Location EV36 Fuel Tank-1 Filler Cap Location EV37 Fuel Tank-2 Filler Cap Location EV38 Fuel Tank-1 Damage EV39 Fuel Tank-2 Damage EV40 Location of Fuel System-1 Leakage EV41 Location of Fuel System-2 Leakage EV42 Fuel Type-1 EV43 Fuel Type-2 EV44 Is This Vehicle Equipped With More Than Two Fuel Tanks?

Interior Vehicle Form

IV-40 Code "00"

The phrase "caused by occupant" is added to line 2 of code "00".

1994 NASS CDS Manual

Occupant Assessment Form

OA-17	Source	The source for this variable is modified to include "medical reports".
OA-71	Mapping Scheme	The scheme for mapping injuries on state PARs to the KABCO codes is changed for Pennsylvania and Tennessee.
OA-77	Code "62"	Code is modified. No change in definition.
OA-113	New Variable	Variable OA53 (Primary Source of Belt Use Determination) is added.

Occupant Injury Form

OI-6	Revised label	The revised version of the "Injury Information" label is included
OI-27	Code "97"	The code is modified to address intrusions that could not be measured.

Update Form

UD-1	Third Paragraph	Information is included for the following variables that are added to the form: GV12 (Alcohol Test Results for Driver) GV39 (Other Drug Specimen Test Type for Driver)
------	-----------------	--

Interview Form (B)

IN-3	Paragraph 1	The subsection "Vehicle Rollover/Fire Questions" is added
IN-4	Paragraph 5	This paragraph provides information for the new subsection on "Vehicle Rollover/Fire Questions".

Appendices

---	Title Page	New sections on coding manual and field form changes are added.
AP-7	Special Studies	Fatal AOPS is dropped from the special study indicators. The Pedestrian Crash Data Study and Impact Fires are added.
AP-10	New Variables	The following variables are new for 1994. EV33 Type of Fuel Tank-2 EV34 Fuel Tank-1 Location EV35 Fuel Tank-2 Location EV36 Fuel Tank-1 Filler Cap Location EV37 Fuel Tank-2 Filler Cap Location EV38 Fuel Tank-1 Damage EV39 Fuel Tank-2 Damage EV40 Location of Fuel System-1 Leakage EV41 Location of Fuel System-2 Leakage EV42 Fuel Type-1 EV43 Fuel Type-2 EV44 Is This Vehicle Equipped With More Than Two Fuel Tanks?
AP-13	New Variable	The following variable is new for 1994. OA53 Primary Source of Belt Use Determination

1/4/94

1994 New Make/Models and Modifications

<u>New</u>					
06 042	LHS	New Yorker (94-on)	94-on	4	9***
07 020	Neon		94-on	3	9***
07 482	Ram 1500/2500/3500 P/U		94-on	per WB	8**
09 020	Neon		94-on	3	9***
12 035	Contour (spring of 94 release)		94-on	?	?
12 036	Aspire		94-on	1	1
12 442	Windstar (spring of 94 release)		94-on	?	?
14 037	Mystique (spring of 94 release)		94-on	?	?
20 036	Monte Carlo (FWD only)		95-on	3	9***
21 022	Aurora		94-on	4	9***
32 041	Cabriolet		94-on	2	2
37 401	Passport		94-on	3	8**
42 041	400/500 E	SE	92-on	3	3
42 042	220/280 C		94-on	?	?
59 034	GS-300		94-on	?	?
69 054	KIA	Sephia	all	per WB	= size

<u>Modified</u>					
06 014	New Yorker/E Class/ Imperial (90-93)/ 5th Avenue	FWD vehicles, Turbo	83-93	3	9***
06 035	Conquest	TSI, Turbo	87-89	2	2
12 033	Festiva		88-93	1	1
12 471	Ranger	Supercab, 4 x 4, STX, Splash	82-on	108" WB = 3	8**
18 005	Riviera	S-Type, T-Type	63-65	4	4
			66-76	5	5
			77-85	4	4
			86-93	3	9***
			94-on	4	9***
19 003	Deville/Fleetwood (except Limousine)	Coupe de Ville, Sedan de Ville, Fleetwood Bougham, Fleetwood 60 Special, d'Elegance	-76 RWD 77-on FWD 85-on	6 5 4	6 5 9***
20 010	Deville Monte Carlo (RWD only)	Concourse LS, SS, Aerocoupe, Landau	94-on 70-77 78-88	4 4 3	9*** 4 3
22 016	J2000/2000/Sunbird	Sunbird (84-on), LE, SE, GT, Convertible	82-on	2	9***
24 001	SL	SL1, SL2, SL3	91-on	3	3
24 002	SC	SC1, SC2	91-on	2	2
24 003	SW	SW1, SW2	93-on	3	3
37 032	Accord	LX, CVCC, SE-1, LX-1, EX, EX wagon	-81	1	1
41 471	B-4000		94-on	per WB	8**
45 031	911	L, S, E, T, SC, Carrera, Slopenose, Speedster	all	1	1
49 040	Camry	LE, Deluxe, XLE, Coupe	83-on	3	3
51 042	850	GLT, Wagon	93-on	3	3
52 031	Starion	2 + 2, LE, Turbo	83-90	2	2
52 038	Sigma		89-90	3	3
52 039	3000GT		91-on	2	2
52 040	Diamante		92-on	3	3
55 031	Pony		84-88	2	2

<u>Dropped</u>	
51 037	P-544

1/4/94

1994 NASS CDS FIELD DATA COLLECTION FORMS MODIFICATIONS, DELETIONS, AND ADDITIONS

This list identifies all changes to the NASS CDS data collection forms for use in the 1994 Crashworthiness Data System.

Codes for "Type of Changes" are:

- E Editorial - Grammatical corrections only
- A Automated system change

CASE SUMMARY

<u>Page Number</u>	<u>Variable Number</u>	<u>Nature of change</u>	<u>Type of Change</u>
2		Codes for "Body Region" -- All codes are arranged in alphabetical order. The word "noise" is changed to "nose".	E

SLIDE INDEX

NO CHANGE

ACCIDENT COLLISION MEASUREMENT TABLE

1		Second column, Level II Cont'd, second asterisk: change "scale" to "scaled".	E
---	--	--	---

ACCIDENT COLLISION DIAGRAM

1		Scale at bottom right of page: The conversion factor is left blank for researcher to complete	E
---	--	---	---

ACCIDENT FORM

1	AC04	(Date of Accident) Coded value for data collection year changed to "94"	A
1		(Special Study 14) This special study has been dropped. It was previously variable AC06. All other special study variable numbers have changed.	A
1	AC06	(Special Study 15) The variable number is changed from AC07 to AC06	A
1	AC07	(Special Study 16) This special study has been labeled "Pedestrian Crash Data Study".	A
1	AC08	(Special Study 17) This special study has been labeled "Impact Fires".	A
2	Object Contacted	Variables AC16, AC23, AC30, AC37, and AC44: Code "79" (Object fell from vehicle in-transport) is added.	A

<u>Page Number</u>	<u>Variable Number</u>	<u>Nature of change</u>	<u>Type of Change</u>
--------------------	------------------------	-------------------------	-----------------------

ACCIDENT EVENTS SUPPLEMENT

NO CHANGE

GENERAL VEHICLE FORM

1	GV08	(Vehicle Identification Number) The sequence number of each digit is added below the spaces for coding; in the Unknown code, the word "nine's is changed to "nines".	E
1	GV14	(Attempted Avoidance Maneuver) Code "00" (No impact) is deleted	A
3	GV30-GV33	Non-automated lines have been added for recording on the forms the highest and second highest values for all components of delta V and energy absorption.	E
4	GV37	(Police Reported Other Drug Presence) In code "0", change "drugs" to "drug(s)".	E
5R	Rollover Object Contacted	Variable GV61: Code "79" (Object fell from vehicle in-transport) is added	A
6	GV65	(Critical Precrash Event) Realign variable number and title to left. In code "82", change the small dash to a large dash.	E

EXTERIOR VEHICLE FORM

3	Object Contacted	Variables EV05 and EV13: Code "79" (Object fell from vehicle in-transport) is added	A
5	EV32	The title of the variable is changed to "Type of Fuel Tank-1".	E
5-6	EV33-EV38	The following new variables are added: EV33 Type of Fuel Tank-2 EV34 Fuel Tank-1 Location EV35 Fuel Tank-2 Location EV36 Fuel Tank-1 Filler Cap Location EV37 Fuel Tank-2 Filler Cap Location EV38 Fuel Tank-1 Damage EV39 Fuel Tank-2 Damage EV40 Location of Fuel System-1 Leakage EV41 Location of Fuel System-2 Leakage EV42 Fuel Type-1 EV43 Fuel Type-2 EV44 Is This Vehicle Equipped With More Than Two Fuel Tanks?	A

CRASH PROGRAM SUMMARY

1		Scene Information, second column, Impact Position, PSI: Delete the ". ____".	E
1		Vehicle Motion, first and second columns. Change "Skidding (Rotation)" to "Vehicle Rotation". Change "Skidding Stop Before Rest" to "Rotation Stop Before Rest"	E

<u>Page Number</u>	<u>Variable Number</u>	<u>Nature of change</u>	<u>Type of Change</u>
--------------------	------------------------	-------------------------	-----------------------

OLDMISS PROGRAM SUMMARY

NO CHANGE

INTERIOR VEHICLE FORM

3	IV88-IV91	(Blank variables) The years "1988-93" are changed to "1988-1994"	E
5R		Air Bag section, third column: The title of the variable is changed to "Are There Indications of Air Bag System Failure?"	E
6		Space for coding "Proper Use of Manual (Active) Belts" is provided in the table. The codes for "Proper Use of Manual (Active) Belts" is added in the second column below the table.	E
		The restraint information labeled "Third" is deleted. The row labeled "Use" is deleted and three new rows are added. The new rows are "Evidence of usage", "Used in this crash?", and "Proper Use".	E
6R		First column, item 4: The spelling of the word "Usage" is corrected.	E
8		First paragraph, second sentence: The spelling of the word "occupant" is corrected	E
8		(Ejection) The number of the second code under the ejection variable is changed from "1" to "2".	E

OCCUPANT ASSESSMENT FORM

4	OA27	[Seat Performance (this Occupant Position)] A line for specifying information is added to code "3".	E
7	OA47	[Proper Use of Automatic (Passive) Belt System] A right parenthesis is added after the word "Passive" in the title.	E
		Space is provided after variable OA49 for the researcher to check off the result of his/her determination of belt use.	
8	OA53	The following new variable is added: OA53 Primary Source of Belt Use Determination	A

OCCUPANT INJURY FORM

1, 1R		The column header "O.I.C.-A.I.S." is changed to "A.I.S. - 90"	E
1		(Occupant Injury Data Supplement) The column header "O.I.C.-A.I.S." is changed to "A.I.S - 90"	E

<u>Page Number</u>	<u>Variable Number</u>	<u>Nature of change</u>	<u>Type of Change</u>
<u>UPDATE FORM</u>			
1	OAL17(f) OAL17(h) OAL17(i) GV12 GV39	The phrase "post ER visit" is changed to "(X-ray, CT scan) The phrase "(includes nurses' notes)" is added. Code "i" is deleted. (Alcohol Test Results for Driver) is added (Other Drug Specimen Test Type for Driver) is added	E
<u>INTERVIEW FROM</u>			
1	INTV8	Interview Form B, Accident Data Questions: The word "Higher" in the code options is capitalized	E
5	INTV	This is a new set of questions that addresses the Fire and Rollover data.	E
6	INTV	1993 pages 5-8 are renumbered 6-9 in 1994 to allow for new page 5	E
6	INTV6a	Interview Form B, Occupant Data Questions, question 6: The question is changed to read as follows: "Can you remember out of what area of the vehicle you were (he/she was) thrown"?	E
7	INTV1	Interview Form B, Occupant Injury Data Questions, question 1: The first choice is changed to "No (If "No", go to question 4)".	E
	INTV4	The phrase "(skull/brain?)" is added to the title of the variable.	E
	INTV7	The variable title is changed to "Did you (he/she) receive any treatment?"	E
		The phrase "or return to question 2" is added to the second choice.	E
	INTV7a	The phrase "(check all that apply)" is added to the variable title.	E
<u>OCCUPANT DATA QUESTIONS SUPPLEMENT</u>			
1	INTV6a	Occupant Data Questions Supplement, questions 6: The question is changed to read as follows: "Can you remember out of what part of the vehicle you were (he/she was) thrown"?	E
3	INTV1	Occupant Injury Data Questions, question 1: The first choice is changed to "No (If "No", go to question 7)".	E
3	INTV4	The phrase "(skull/brain?)" is added to the title of the variable.	E
3	INTV7	The variable title is changed to "Did you (he/she) receive any treatment?"	E
		The phrase "or return to question 2" is added to the second choice.	E
	INTV7a	The phrase "(check all that apply)" is added to the variable title.	E

<u>Page Number</u>	<u>Variable Number</u>	<u>Nature of change</u>	<u>Type of Change</u>
<u>ZONE CENTER WORK SHEET</u>			
1	OA07	(Occupant's Height) Add a third space for coding the value	E
1	OA53	The following new variable is added: OA53 Seat Belt Use Determination	E
<u>ADMINISTRATIVE LOG-A</u>			
1	4	(Status of Assigned Researcher) Code "9" (Research assistant) is added.	A
1	8	(Special Study Cases) Special Studies are renumber SS15-SS19.	A
1	19	(Potential Safety Problem Bulletin) Code "4" is added and reads as follows: "Submitted by PSU and <u>not</u> sent to NHTSA by ZC"	A
<u>ADMINISTRATIVE LOG-B</u>			
1	23	(Type of Review) Code "d" is changed from "OLDMISS review" to "Reconstruction (CRASH or OLDMISS)".	E
1	27	(Manner of Case Review Feedback) A space is provided for coding the response	E
1	40, 41	Variable 40 (Final Log Entry Date) and variable 41 (Final Log Data Entered By) are added. The blank coding lines are renumbered "42" and "43".	
<u>ACCIDENT LOG</u>			
1	7	Variable "11" (Number of Scene Slides) is renumbered to variable "7". All other variables are renumbered appropriately.	A
<u>GENERAL VEHICLE LOG</u>			
1	GVL6	(Reason Vehicle Inspection Not Completed) In code "03", the word "repair" is changed to "repaired".	E
<u>EXTERIOR VEHICLE LOG</u>			
1	EVL10 & EVL11	(Exterior Slides Subject Quality) and (Exterior Slides Quality) Codes 1 and 2 are renumbered to codes 2 and 3. Code 1 (Substandard - beyond researcher control) is added.	A
1	6	Variable "9" (Number of Exterior Vehicle Slides) is renumbered to variable "6". All other variables are renumbered appropriately.	A
<u>INTERIOR VEHICLE LOG</u>			
1	5	Variable "12" (Number of Interior Vehicle Slides) is renumbered to variable "5". All other variables are renumbered appropriately.	A

<u>Page Number</u>	<u>Variable Number</u>	<u>Nature of change</u>	<u>Type of Change</u>
<u>OCCUPANT ASSESSMENT LOG</u>			
1	OAL10	(Occupant's Role) Code "3" is changed to code "9".	A
1	OAL13	(Result of Last Interview Attempt) Code "11" (Returned of completed questionnaire) is dropped.	A
1	OAL15	(Status of Medical Release) Change code "1" to read as follows: "Occupant not injured or not treated at a medical facility"	E

OCCUPANT ASSESSMENT LOG (Cont'd)

1	OAL16	(Injury Treatment Status) In code "09", the word "Treatment" is changed to "Transported to a".	E
1	OAL17	(Injury Information) In code "f", the phrase "post ER visit" is changed to "(X-ray, CTscan)".	E
1	OAL17	(Injury Information) Code "i" (Radiographic record(s) associated with ER visit) is dropped.	A
2	OAL18	(Documentation of Occupant Interview) The variable is renumbered from "18" to "19". Codes 1 and 2 are renumbered to codes 2 and 3. Code 1 (Substandard - beyond researcher control) is added.	A

OCCUPANT INJURY LOG

- 1	14, 15	The subtitle "MDE STATUS" is changed to "UPDATED MDE STATUS". The title of variable "14" changed from "Date MDE'ed" to "Date MDE Updated". The title of variable "15" changed from "MDE'ed By (Initials)" to "MDE Updated By (Initials)".	E
-----	--------	---	---

CONTACT LOG

NO CHANGE

INJURY INFORMATION

1	II05	(Type of Medical Information) In code "f", the phrase "post ER visit" is dropped.	E
1	II17	(Type of Medical Information) Code "i" (Radiographic record(s) associated with ER visit) is dropped.	A

NATIONAL ACCIDENT SAMPLING SYSTEM
1994 CRASHWORTHINESS DATA SYSTEM
DATA COLLECTION, CODING, AND EDITING MANUAL

January 4, 1994

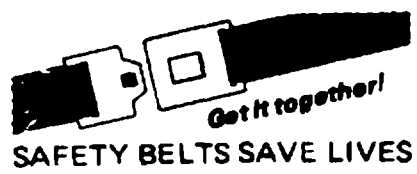

AUTO SAFETY HOTLINE
(800) 424-9393
Wash. D.C. Area 202-366-0123