



U.S. Department
of Transportation

**National Highway
Traffic Safety
Administration**

400 Seventh Street, S.W.
Washington, D.C. 20590

Dear Crash Data Researchers/Users:

Thank you for choosing crash data from the National Highway Traffic Safety Administration (NHTSA) for your research or other use. The information contained in this motor vehicle crash report is collected, maintained and distributed in accordance with Public Law 89-564. In accordance with this Public Law, NHTSA is required not to release any case information until completion of quality control procedures. These procedures include a review of the case material to extract all names, licenses and registration numbers, non-coded interview material, non-research related researcher comments in the margins, non-factual data, and the production number portion of the vehicle identification number (VIN).

If you requested NHTSA to query its database files in order to identify a specific crash, then that query was made using non-personal descriptors you provided for use in our search. This motor vehicle crash may have been identified from a data search and matches the general, non-personal descriptors you provided, but we cannot confirm that this is the specific crash report you requested.

If you have any questions with regard to the above procedures, please contact the Field Operations Branch, Crash Investigation Division, National Center for Statistics and Analysis at 202-366-4820. Again, please be advised that we cannot confirm that this is the case that you have specifically requested nor can we certify the information to be correct.

*** **



AUTO SAFETY HOTLINE
(800) 424-9393
Wash. D.C. Area 366-0123



CASE SUMMARY

PSU 41 CASE NO. 199A TYPE OF ACCIDENT Car vs Truck (Rear End Severe Under-ride)

A. DESCRIPTION OF THE ACCIDENT SEQUENCE AND ACCIDENT PECULIARITIES

(Provide a summary of the accident sequence as well as any particular event of the accident that is noteworthy. Injury mechanism and vehicle crashworthiness is the focus, not driver culpability. Do not include any personal identifiers.)

V-1 was northbound in the second lane from the right on a five lane highway. V-2 was northbound on the same highway in front of V-1. V-2 began to slow down, V-1 was unable to slow in time. V-1's front impacted V-2's back. V-1 underrode V-2 before coming to rest. The driver of V-1 expired on scene.

B. VEHICLE PROFILE(S)

Vehicle No.	Class of Vehicle	Year/Make/Model	Most Severe Damage Based on Vehicle Inspection		Component Failure
			Damage Plane	Severity Description	
01	Compact	1993/Toyota/Camry	Front	Severe	None
02	Truck >4500 kgs GVWR	1992/Ford	Back	Unknown	Unknown

DO NOT SANITIZE THIS FORM

C. PERSON PROFILE(S)

Vehicle No.	Person Role	Seat Position	Restraint Use	Most Severe Injury (TO BE COMPLETED BY ZONE CENTER)			
				Body Region	Injury Type	AIS	Injury Source
01	Driver	Front/Left	3pt Man. & Air Bag	<i>brain</i>	<i>hemorrhage</i>	<i>4</i>	
02	Driver	Front/Left	Unknown				

Body Region

Abdomen
 Ankle-foot
 Arm (upper)
 Back-thoracolumbar spine
 Brain
 Chest
 Ears
 Eye
 Elbow
 Face
 Forearm
 Head-skull
 Heart
 Kidneys
 Knee
 Leg (lower)
 Liver
 Lower limbs(s) (whole or unknown part)
 Mouth
 Neck-cervical spine
 Nose

Pelvic-hip
 Pulmonary-lungs
 Shoulder
 Spleen
 Thigh
 Thyroid, other endocrine gland
 Upper limb(s) (whole or unknown part)
 Vertebrae
 Whole body
 Wrist-hand

Injury Type

Abrasion
 Amputation
 Avulsion
 Burn
 Concussion
 Contusion
 Crush
 Detachment, separation
 Dislocation

Fracture
 Fracture and dislocation
 Laceration
 Other
 Perforation, puncture
 Rupture
 Sprain
 Strain
 Total severance, transection
 Unknown

Abbreviated Injury Scale





- (1) Minor injury
- (2) Moderate injury
- (3) Serious injury
- (4) Severe injury
- (5) Critical injury
- (6) Maximum (untreatable)
- (7) Injured, unknown severity

DO NOT SANITIZE THIS FORM

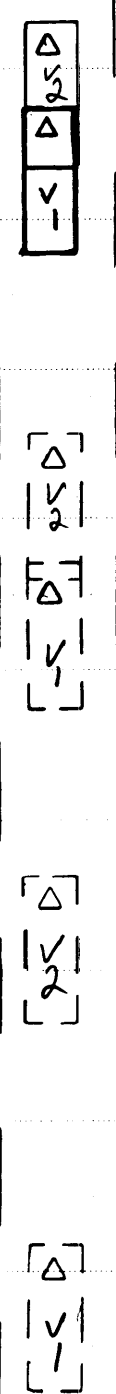

ACCIDENT COLLISION DIAGRAM

NOT TO SCALE

PSU No. <u>41</u>	Case Number - Stratum <u>199A</u>	Indicate North 
	<p style="writing-mode: vertical-rl; transform: rotate(180deg);">PAVED</p> <p style="writing-mode: vertical-rl; transform: rotate(180deg);">SHOULDER</p> <p style="writing-mode: vertical-rl; transform: rotate(180deg);">CLOSED FOR CONSTRUCTION</p>  	<p style="writing-mode: vertical-rl; transform: rotate(180deg);">PAVED</p> <p style="writing-mode: vertical-rl; transform: rotate(180deg);">SHOULDER</p> 



ACCIDENT COLLISION MEASUREMENT TABLE

Primary Sampling Unit Number 41

Case Number--Stratum 199A

ACCIDENT COLLISION DIAGRAM		CRASH DATA																		
<p style="text-align: center;">LEVEL I PHYSICAL EVIDENCE ABSENT</p> <p>To be accomplished when there is no physical evidence present at the scene:</p> <ul style="list-style-type: none"> • approximate vehicle orientation at impact and final rest • applicable road/roadway delineation (e.g., curbs/edge lines, lane markings, median markings, pavement markings, etc.) • applicable traffic controls (e.g., speed limit) • north arrow placed on diagram • sketch required 	<p style="text-align: center;">LEVEL II (Cont'd) physical evidence is present:</p> <ul style="list-style-type: none"> • document reference point and reference line relative to physical features present at the scene • scaled documentation of all accident induced physical evidence • scaled documentation of all roadside objects contacted • roadway surface type and condition of applicable roadways • grade measurements for all applicable roadways and at location of rollover initiation • scaled representations of the vehicle(s) at pre-impact, impact, and final rest based upon either: <ul style="list-style-type: none"> a) physical evidence, or b) reconstructed accident dynamics 	<table style="width: 100%; border-collapse: collapse;"> <tr> <td style="text-align: right;">VEH. #1</td> <td style="text-align: right;">VEH. #2</td> <td style="text-align: right;">VEH. #3</td> </tr> <tr> <td style="text-align: right;">Heading Angle</td> <td style="text-align: center;"><u>000°</u></td> <td style="text-align: center;"><u>000°</u></td> </tr> <tr> <td style="text-align: right;">Surface Type</td> <td style="text-align: center;"><u>Asphalt</u></td> <td style="text-align: center;"><u>Asphalt</u></td> </tr> <tr> <td style="text-align: right;">Surface Condition</td> <td style="text-align: center;"><u>Very Dry</u></td> <td style="text-align: center;"><u>Dry</u></td> </tr> <tr> <td style="text-align: right;">Grade (v/h) Measurement (between impact and final rest)</td> <td style="text-align: center;">—</td> <td style="text-align: center;">—</td> </tr> <tr> <td style="text-align: right;">Grade (v/h) Measurement (at location of rollover initiation)</td> <td style="text-align: center;">—</td> <td style="text-align: center;">—</td> </tr> </table>	VEH. #1	VEH. #2	VEH. #3	Heading Angle	<u>000°</u>	<u>000°</u>	Surface Type	<u>Asphalt</u>	<u>Asphalt</u>	Surface Condition	<u>Very Dry</u>	<u>Dry</u>	Grade (v/h) Measurement (between impact and final rest)	—	—	Grade (v/h) Measurement (at location of rollover initiation)	—	—
VEH. #1	VEH. #2	VEH. #3																		
Heading Angle	<u>000°</u>	<u>000°</u>																		
Surface Type	<u>Asphalt</u>	<u>Asphalt</u>																		
Surface Condition	<u>Very Dry</u>	<u>Dry</u>																		
Grade (v/h) Measurement (between impact and final rest)	—	—																		
Grade (v/h) Measurement (at location of rollover initiation)	—	—																		
<p style="text-align: center;">LEVEL II PHYSICAL EVIDENCE PRESENT</p> <p>In addition to the level I tasks noted above, the following must be accomplished when</p>																				

Reference Point: _____ Reference line: _____

Item	Distance and Direction from Reference Point	Distance and Direction from Reference Line



ACCIDENT FORM

1. Primary Sampling Unit Number 41
2. Case Number - Stratum 199A

IDENTIFICATION

3. Number of General Vehicle Forms Submitted 02
4. Date of Accident (Month, Day, Year) 19 4
5. Time of Accident 0334
Code reported military time of accident.
NOTE: Midnight = 2400
Unknown = 9999

SPECIAL STUDIES - INDICATORS

Check (✓) each special study (SS14-SS18 below) that has been completed; code 1 for the checked special studies and 0 for the special studies not checked.

6. ___ SS15 Administrative Use 0
7. ___ SS16 Pedestrian Crash Data Study 0
8. ___ SS17 Impact Fires 0
9. ___ SS18 _____ 0
10. ___ SS19 _____ 0

NUMBER OF EVENTS

11. Number of Recorded Events in This Accident 01
Code the number of events which occurred in this accident.

ACCIDENT EVENTS

For each event that occurred in the accident, code the lowest numbered vehicle in the left columns and the other involved vehicle or object on the right.

Accident Event Sequence Number	Vehicle Number	Class Of Vehicle	General Area of Damage	Vehicle Number or Object Contacted	Class Of Vehicle	General Area of Damage
12. <u>0 1</u>	13. <u>01</u>	14. <u>02</u>	15. <u>F</u>	16. <u>02</u>	17. <u>02</u>	18. <u>B</u>
19. <u>0 2</u>	20. _____	21. _____	22. _____	23. _____	24. _____	25. _____
26. <u>0 3</u>	27. _____	28. _____	29. _____	30. _____	31. _____	32. _____
33. <u>0 4</u>	34. _____	35. _____	36. _____	37. _____	38. _____	39. _____
40. <u>0 5</u>	41. _____	42. _____	43. _____	44. _____	45. _____	46. _____

IF GREATER THAN FIVE EVENTS, CONTINUE CODING ON THE ACCIDENT EVENT SUPPLEMENT

CODES FOR CLASS OF VEHICLE

- (00) Not a motor vehicle
- (01) Subcompact/mini (wheelbase < 254 cm)
- (02) Compact (wheelbase ≥ 254 but < 265 cm)
- (03) Intermediate (wheelbase ≥ 265 but < 278 cm)
- (04) Full size (wheelbase ≥ 278 but < 291 cm)
- (05) Largest (wheelbase ≥ 291 cm)
- (09) Unknown passenger car size
- (11) Compact utility vehicle
- (12) Large utility vehicle (≤ 4,500 kgs GVWR)
- (13) Passenger van (≤ 4,500 kgs GVWR)
- (14) Other van (≤ 4,500 kgs GVWR)
- (15) Pickup truck (≤ 4,500 kgs GVWR)
- (18) Other truck (≤ 4,500 kgs GVWR)
- (19) Unknown light truck type
- (20) School bus
- (21) Other bus
- (22) Truck (> 4,500 kgs GVWR)
- (23) Tractor without trailer
- (24) Tractor-trailer(s)
- (25) Motored cycle
- (28) Other vehicle
- (99) Unknown

CODES FOR GENERAL AREA OF DAMAGE (GAD)

CDS APPLICABLE AND OTHER VEHICLES

- (0) Not a motor vehicle
- (N) Noncollision
- (F) Front
- (R) Right side
- (L) Left side
- (B) Back
- (T) Top
- (U) Undercarriage
- (9) Unknown

TDC APPLICABLE VEHICLES

- (0) Not a motor vehicle
- (N) Noncollision
- (F) Front
- (R) Right side
- (L) Left side
- (B) Back of unit with cargo
area (rear of trailer or
straight truck)
- (D) Back (rear of tractor)
- (C) Rear of cab
- (V) Front of cargo area
- (T) Top
- (U) Undercarriage
- (9) Unknown

CODES FOR VEHICLE NUMBER OR OBJECT CONTACTED

(01-30) — Vehicle Number

Noncollision

- (31) Overturn — rollover
- (32) Fire or explosion
- (33) Jackknife
- (34) Other intraunit damage (specify):

(35) Noncollision injury

(38) Other noncollision (specify):

(39) Noncollision — details unknown

Collision With Fixed Object

- (41) Tree (≤ 10 cm in diameter)
- (42) Tree (> 10 cm in diameter)
- (43) Shrubbery or bush
- (44) Embankment

- (45) Breakaway pole or post (any diameter)

Nonbreakaway Pole or Post

- (50) Pole or post (≤ 10 cm in diameter)
- (51) Pole or post (> 10 cm but ≤ 30 cm in
diameter)
- (52) Pole or post (> 30 cm in diameter)
- (53) Pole or post (diameter unknown)

- (54) Concrete traffic barrier
- (55) Impact attenuator
- (56) Other traffic barrier (includes guardrail)
(specify):

(57) Fence

(58) Wall

(59) Building

(60) Ditch or culvert

(61) Ground

(62) Fire hydrant

(63) Curb

(64) Bridge

(68) Other fixed object (specify):

(69) Unknown fixed object

Collision with Nonfixed Object

- (71) Motor vehicle not in-transport
- (72) Pedestrian
- (73) Cyclist or cycle
- (74) Other nonmotorist or conveyance

(75) Vehicle occupant

(76) Animal

(77) Train

(78) Trailer, disconnected in transport

(79) Object fell from vehicle in-transport

(88) Other nonfixed object (specify):

(89) Unknown nonfixed object

(98) Other event (specify):

(99) Unknown event or object

OCCUPANT RELATED

- 16. Driver Presence in Vehicle 1
 (0) Driver not present
 (1) Driver present
 (9) Unknown
- 17. Number of Occupants This Vehicle 01
 (00-96) Code actual number of occupants for this vehicle
 (97) 97 or more
 (99) Unknown
- 18. Number of Occupant Forms Submitted 01

- 24. Rollover 0
 (0) No rollover (no overturning)

Rollover (primarily about the longitudinal axis)
 (1) Rollover, 1 quarter turn only
 (2) Rollover, 2 quarter turns
 (3) Rollover, 3 quarter turns
 (4) Rollover, 4 or more quarter turns (specify):

 (5) Rollover--end-over-end (i.e., primarily about the lateral axis)
 (9) Rollover (overturn), details unknown

VEHICLE WEIGHT ITEMS

- 19. Vehicle Curb Weight 1,340
 Code weight to nearest 10 kilograms.
 (045) Less than 450 kilograms
 (610) 6,100 kilograms or more
 (999) Unknown

 _____ lbs X .4536 = 1,335 kgs
 Source: [REDACTED]
- 20. Vehicle Cargo Weight 0,000
 Code weight to nearest 10 kilograms.
 (000) Less than 5 kilograms
 (450) 4,500 kilograms or more
 (999) Unknown

 _____ lbs X .4536 = _____ kgs

OVERRIDE/UNDERRIDE (THIS VEHICLE)

- 25. Front Override/Underride (this Vehicle) 7
- 26. Rear Override/Underride (this Vehicle) 0
 (0) No override/underride, or not an end-to-end impact

Override (see specific CDC)
 (1) 1st CDC
 (2) 2nd CDC
 (3) Other not automated CDC (specify):

Underride (see specific CDC)
 (4) 1st CDC
 (5) 2nd CDC
 (6) Other not automated CDC (specify):

 (7) Medium/heavy truck or bus override
 (9) Unknown

RECONSTRUCTION DATA

- 21. Towed Trailing Unit 0
 (0) No towed unit
 (1) Yes--towed trailing unit
 (9) Unknown
- 22. Documentation of Trajectory Data for This Vehicle 0
 (0) No
 (1) Yes
- 23. Post Collision Condition of Tree or Pole (For Highest Delta V) 0
 (0) Not collision (for highest delta V) with tree or pole
 (1) Not damaged
 (2) Cracked/sheared
 (3) Tilted < 45 degrees
 (4) Tilted ≥ 45 degrees
 (5) Uprooted tree
 (6) Separated pole from base
 (7) Pole replaced
 (8) Other (specify):

 (9) Unknown

HEADING ANGLE AT IMPACT FOR HIGHEST DELTA V

Values: (000)-(359) Code actual value
 (997) Noncollision
 (998) Impact with object
 (999) Unknown

- 27. Heading Angle For This Vehicle 000
- 28. Heading Angle For Other Vehicle 000

Category	Configuration	ACCIDENT TYPES (Includes Intent)					
I Single Driver	A Right Roadside Departure	01 DRIVE OFF ROAD	02 CONTROL/ TRACTION LOSS	03 AVOID COLLISION WITH VEH., PED., ANIM.	04 SPECIFICS OTHER	05 SPECIFICS UNKNOWN	
	B Left Roadside Departure	06 DRIVE OFF ROAD	07 CONTROL/ TRACTION LOSS	08 AVOID COLLISION WITH VEH., PED., ANIM.	09 SPECIFICS OTHER	10 SPECIFICS UNKNOWN	
	C Forward Impact	11 PARKED VEH.	12 STA. OBJECT	13 PEDESTRIAN/ ANIMAL	14 END DEPARTURE	15 SPECIFICS OTHER	16 SPECIFICS UNKNOWN
II Same Trafficway Same Direction	D Rear-End	20 STOPPED 21, 22, 23	22 SLOWER 24, 25, 27	26 DECEL. 28, 29, 31	30 AVOID COLLISION WITH VEH.	(EACH • 32) SPECIFICS OTHER	(EACH • 33) SPECIFICS UNKNOWN
	E Forward Impact	34 CONTROL/ TRACTION LOSS	36 CONTROL/ TRACTION LOSS	38 AVOID COLLISION WITH VEH.	40 AVOID COLLISION WITH OBJECT	(EACH • 42) SPECIFICS OTHER	(EACH • 43) SPECIFICS UNKNOWN
	F Sideswipe Angle	44, 45, 46, 47				(EACH • 48) SPECIFICS OTHER	(EACH • 49) SPECIFICS UNKNOWN
III Same Trafficway Opposite Direction	G Head-On	50 LATERAL MOVE				(EACH • 52) SPECIFICS OTHER	(EACH • 53) SPECIFICS UNKNOWN
	H Forward Impact	54 CONTROL/ TRACTION LOSS	56 CONTROL/ TRACTION LOSS	58 AVOID COLLISION WITH VEH.	60 AVOID COLLISION WITH OBJECT	(EACH • 62) SPECIFICS OTHER	(EACH • 63) SPECIFICS UNKNOWN
	I Sideswipe Angle	64 LATERAL MOVE				(EACH • 66) SPECIFICS OTHER	(EACH • 67) SPECIFICS UNKNOWN
IV Change Trafficway Vehicle Turning	J Turn Across Path	68 INITIAL OPPOSITE DIRECTIONS	71 INITIAL SAME DIRECTIONS	73		(EACH • 74) SPECIFICS OTHER	(EACH • 75) SPECIFICS UNKNOWN
	K Turn Into Path	77 TURN INTO SAME DIRECTION	79 TURN INTO OPPOSITE DIRECTIONS	81	83	(EACH • 84) SPECIFICS OTHER	(EACH • 85) SPECIFICS UNKNOWN
V Intersecting Paths (Vehicle Damage)	L Straight Paths	87	89			(EACH • 90) SPECIFICS OTHER	(EACH • 91) SPECIFICS UNKNOWN
VI Miscellaneous	M Backing Etc.	92 BACKING VEH.	93 OTHER VEH. OR OBJECT			96 Other Accident Type 99 Unknown Accident Type 00 No Impact	

OTHER DATA

56. Driver's Zip Code [REDACTED]

- (00000) Driver not present
- (00001) Driver not a resident of U.S. or territories
- Code actual 5-digit zip code
- (99999) Unknown

57. Driver's Race/Ethnic Origin 2

- (0) Driver not present
- (1) White (non-Hispanic)
- (2) Black (non-Hispanic)
- (3) White (Hispanic)
- (4) Black (Hispanic)
- (5) American Indian, Eskimo or Aleut
- (6) Asian or Pacific Islander
- (8) Other (specify): _____
- (9) Unknown

58. Vehicle Special Use (This Trip) 0

- (0) No special use
- (1) Taxi
- (2) Vehicle used as school bus
- (3) Vehicle used as other bus
- (4) Military
- (5) Police
- (6) Ambulance
- (7) Fire truck or car
- (8) Other (specify): _____
- (9) Unknown

ROLLOVER DATA

If GV07 (Body Type) \neq 1-49, leave GV59-GV63 blank.
 If GV24 (Rollover) = 0, then GV59-GV63 must equal 0.
 If GV24 = 9, then GV59-GV63 must equal 9.

59. Rollover Initiation Type 0

- (0) No rollover
- (1) Trip-over
- (2) Flip-over
- (3) Turn-over
- (4) Climb-over
- (5) Fall-over
- (6) Bounce-over
- (7) Collision with another vehicle
- (8) Other rollover initiation type specify): _____
- (9) Unknown rollover initiation type

60. Location of Rollover Initiation 0

- (0) No rollover
- (1) On roadway
- (2) On shoulder—paved
- (3) On shoulder—unpaved
- (4) On roadside or divided trafficway median
- (9) Unknown

61. Rollover Initiation Object Contacted 00

62. Location on Vehicle Where Initial Principal Tripping Force Is Applied 0

- (0) No rollover
- (1) Wheels/tires
- (2) Side plane
- (3) End plane
- (4) Undercarriage
- (5) Other location on vehicle (specify): _____
- (8) Non-contact rollover forces (specify): _____
- (9) Unknown

63. Direction of Initial Roll 0

- (0) No rollover
- (1) Roll right - primarily about the longitudinal axis
- (2) Roll left - primarily about the longitudinal axis
- (5) End-over-end (i.e., primarily about the lateral axis)
- (9) Unknown roll direction

PRECRASH DATA

64. Pre-Event Movement (Prior to Recognition of Critical Event) 01

- (01) Going straight
- (02) Slowing or stopping in traffic lane
- (03) Starting in traffic lane
- (04) Stopped in traffic lane
- (05) Passing or overtaking another vehicle
- (06) Disabled or parked in travel lane
- (07) Leaving a parking position
- (08) Entering a parking position
- (09) Turning right
- (10) Turning left
- (11) Making a U-turn
- (12) Backing up (other than for parking position)
- (13) Negotiating a curve
- (14) Changing lanes
- (15) Merging
- (16) Successful avoidance maneuver to a previous critical event
- (97) Other (specify): _____
- (98) No driver present
- (99) Unknown

CODES FOR ROLLOVER INITIATION OBJECT CONTACTED

- (00) No rollover
- (01-30) — Vehicle Number

Noncollision

- (31) Turn-over — fall-over
- (33) Jackknife

Collision With Fixed Object

- (41) Tree (≤ 10 cm in diameter)
- (42) Tree (> 10 cm in diameter)
- (43) Shrubbery or bush
- (44) Embankment

- (45) Breakaway pole or post (any diameter)

Nonbreakaway Pole or Post

- (50) Pole or post (≤ 10 cm in diameter)
- (51) Pole or post (> 10 cm but ≤ 30 cm in diameter)
- (52) Pole or post (> 30 cm in diameter)
- (53) Pole or post (diameter unknown)

- (54) Concrete traffic barrier
- (55) Impact attenuator
- (56) Other traffic barrier (includes guardrail)
(specify): _____

- (57) Fence
- (58) Wall
- (59) Building
- (60) Ditch or culvert
- (61) Ground
- (62) Fire hydrant
- (63) Curb
- (64) Bridge
- (68) Other fixed object (specify): _____

- (69) Unknown fixed object

Collision with Nonfixed Object

- (71) Motor vehicle not in-transport
- (76) Animal
- (77) Train
- (78) Trailer, disconnected in transport
- (79) Object fell from vehicle in-transport
- (88) Other nonfixed object (specify): _____

- (89) Unknown nonfixed object

- (98) Other event (specify): _____

- (99) Unknown event or object



EXTERIOR VEHICLE FORM

1. Primary Sampling Unit Number <u>41</u>	3. Vehicle Number <u>01</u>
2. Case Number - Stratum <u>199A</u>	

VEHICLE IDENTIFICATION

VIN JT2SK12E0P XXXXXXXXXX Model Year 93
 Vehicle Make (specify): Toyota Vehicle Model (specify): Camry

LOCATOR

Locate the end of the damage with respect to the vehicle longitudinal center line or bumper corner for end impacts or an undamaged axle for side impacts.

Specific Impact No.	Location of Direct Damage	Location of Field L
<u>01</u>	<u>LIF Quarter Panel to RIF Quarter Panel</u>	<u>SAME AS DIRECT</u>

CRUSH PROFILE IN CENTIMETERS

NOTES: Identify the plane at which the C-measurements are taken (e.g., at bumper, above bumper, at sill, above sill, etc.) and label adjustments (e.g., free space).

Measure and document on the vehicle diagram the location of maximum crush.

Measure C1 to C6 from driver to passenger side in front or rear impacts and rear to front in side impacts.

Free space value is defined as the distance between the baseline and the original body contour taken at the individual C locations. This may include the following: bumper lead, bumper taper, side protrusion, side taper, etc. Record the value for each C-measurement and maximum crush.

Use as many lines/columns as necessary to describe each damage profile.

Specific Impact Number	Plane of Impact C-Measurements	Direct Damage		Field L	C ₁	C ₂	C ₃	C ₄	C ₅	C ₆	±D
		Width (CDC)	Max Crush								
<u>01</u>	<u>Ball Level</u>	<u>130</u>		<u>130</u>	<u>NO C'S COULD BE TAKEN</u>						
					<u>HOOD OFF CAR, BUMPER</u>						
					<u>NOT DAMAGED.</u>						

ORIGINAL SPECIFICATIONS WORK SHEET

Wheelbase	<u>103.1</u>	inches x 2.54 =	<u>262</u> cm
Overall Length	<u>187.8</u>	inches x 2.54 =	<u>477</u> cm
Maximum Width	<u>69.7</u>	inches x 2.54 =	<u>177</u> cm
Curb Weight	<u>2,943</u>	pounds x .4536 =	<u>1,335</u> kg
Average Track	<u>60.0</u>	inches x 2.54 =	<u>152</u> cm
Front Overhang	<u> </u>	inches x 2.54 =	<u> </u> cm
Rear Overhang	<u> </u>	inches x 2.54 =	<u> </u> cm
Undeformed End Width	<u> </u>	inches x 2.54 =	<u> </u> cm
Engine Size: cyl./displ.	<u>4 2.2</u>	x .001 =	<u>2.2</u> L
	<u> </u>	CID x .0164 =	<u> </u> L

VEHICLE DAMAGE SKETCH

<p>TIRE—WHEEL DAMAGE</p> <p>a. Rotation physically restricted b. Tire deflated</p> <p>RF <u>2</u> *TIRE bead with block LF <u>2</u> *RF <u>1</u> RR <u>2</u> *LF <u>1</u> LR <u>2</u> *RR <u>1</u> LR <u>1</u></p> <p>(1) Yes (2) No (8) NA (9) Unk.</p>	<p>ORIGINAL SPECIFICATIONS</p> <p>Wheelbase <u>262</u> cm Overall Length <u>477</u> cm Maximum Width <u>177</u> cm Curb Weight <u>1335</u> kg Average Track <u>152</u> cm Front Overhang <u> </u> cm Rear Overhang <u> </u> cm Undeformed End Width <u>150</u> cm Engine Size: cyl./displ. <u>E-4 2.2</u> L</p>	<p>WHEEL STEER ANGLES (For locked front wheels or displaced rear axles only)</p> <p>RF ± <u> </u>° LF ± <u> </u>° RR ± <u> </u>° LR ± <u> </u>°</p> <p>Within ± 5 degrees</p> <p>DRIVE WHEELS</p> <p><input checked="" type="checkbox"/> FWD <input type="checkbox"/> RWD <input type="checkbox"/> 4WD</p> <p>Approximate Cargo Weight <u>A</u> kg</p>
<p>TYPE OF TRANSMISSION</p> <p><input type="checkbox"/> Manual <input checked="" type="checkbox"/> Automatic</p>		

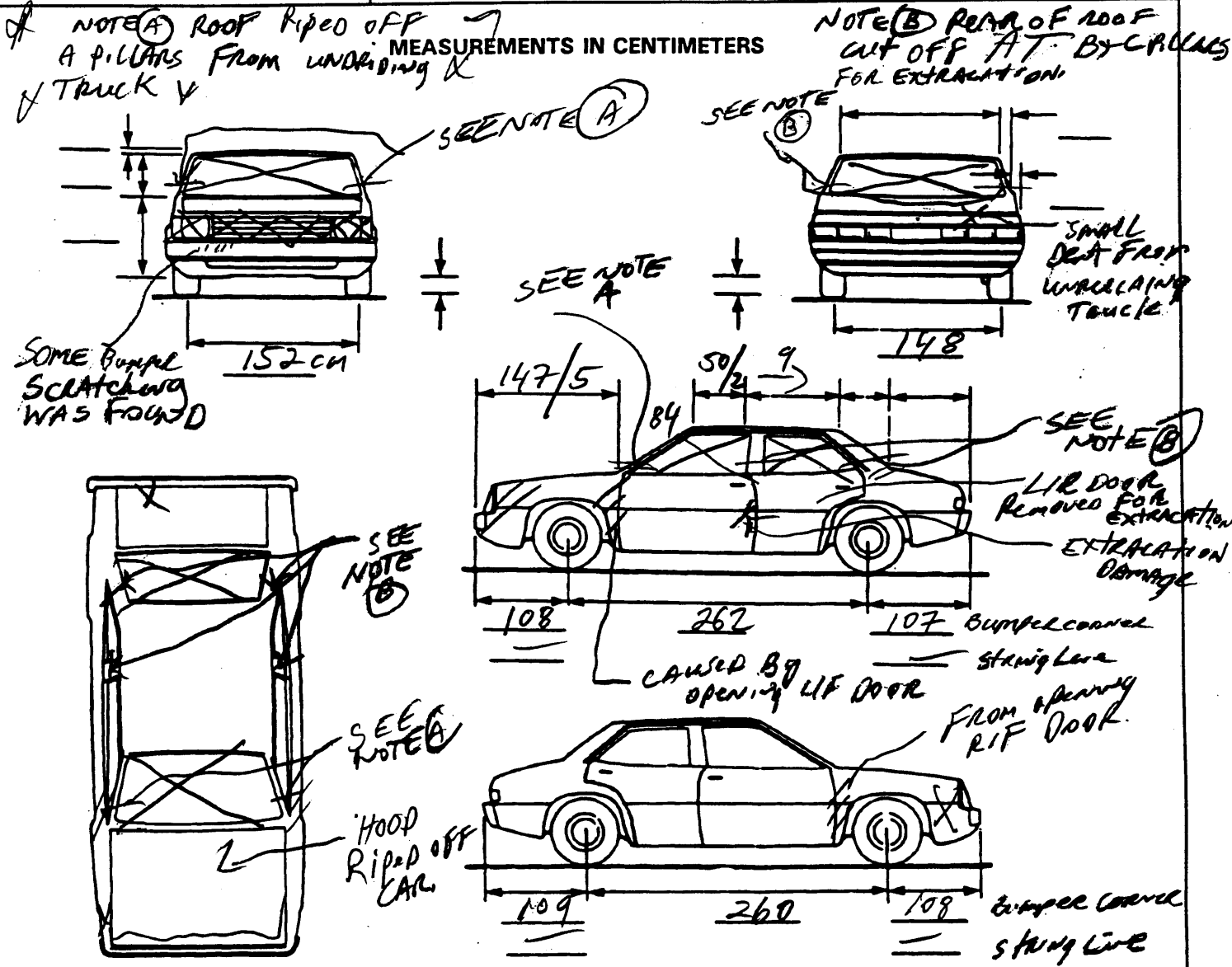

NOTES: Sketch new perimeter and cross hatch direct damage and single hatch induced damage on all views. Annotate observations which might be useful in reconstructing the accident (e.g., grass in tire bead, direction of striations, scuff on sidewalls, etc.). If pulling trailer, sketch type of trailer and damage received on the back of this page. Annotate any damage caused by extrication such as component removal by torching, prying, or hydraulic shears.

COLLISION DEFORMATION CLASSIFICATION

HIGHEST DELTA "V"

Accident Event Sequence Number	Object Contacted	(1) (2) Direction of Force	(3) Deformation Location	(4) Longitudinal or Lateral Location	(5) Vertical or Lateral Location	(6) Type of Damage Distribution	(7) Deformation Extent
4. <u>01</u>	5. <u>02</u>	6. <u>12</u>	7. <u>F</u>	8. <u>D</u>	9. <u>G</u>	10. <u>W</u>	11. <u>09</u>

Second Highest Delta "V"

12. _____	13. _____	14. _____	15. _____	16. _____	17. _____	18. _____	19. _____
-----------	-----------	-----------	-----------	-----------	-----------	-----------	-----------

CRUSH PROFILE IN CENTIMETERS

The crush profile for the damage described in the CDC(s) above should be documented in the appropriate space below. (ALL MEASUREMENTS ARE IN CENTIMETERS.)

HIGHEST DELTA "V"

20. <u>L</u>	21. <u>C₁</u>	<u>C₂</u>	<u>C₃</u>	<u>C₄</u>	<u>C₅</u>	<u>C₆</u>	22. <u>±D</u>
-----	-----	-----	-----	-----	-----	-----	+ ----- - -----

Second Highest Delta "V"

23. <u>L</u>	24. <u>C₁</u>	<u>C₂</u>	<u>C₃</u>	<u>C₄</u>	<u>C₅</u>	<u>C₆</u>	25. <u>±D</u>
-----	-----	-----	-----	-----	-----	-----	+ ----- - -----

26. Are CDCs Documented but Not Coded on The Automated File?
 (0) No
 (1) Yes 0

27. Researcher's Assessment of Vehicle Disposition +
 (0) Not towed due to vehicle damage
 (1) Towed due to vehicle damage
 (9) Unknown

28. Original Wheelbase 262
 Code to the nearest centimeter
 (999) Unknown

_____ inches X 2.54 = _____ centimeters

29. Is This A Multi-Stage Manufactured Vehicle And/Or A Certified Altered Vehicle?

0

- (0) No post manufacturer modifications
- (1) Yes - post manufacturer modifications (specify): _____

(Include photograph of CERTIFICATION PLACARD in case report)

- (9) Unknown if vehicle is modified

30. Fire Occurrence

0

- (0) No fire

Yes, fire occurred

- (1) Minor
- (2) Major
- (9) Unknown

31. Origin of Fire

0

- (0) No fire
- (1) Vehicle exterior (front, side, back, top)
- (2) Exhaust system
- (3) Fuel tank (and other fuel retention system parts)
- (4) Engine compartment
- (5) Cargo/trunk compartment
- (6) Instrument panel
- (7) Passenger compartment area
- (8) Other location (specify): _____

- (9) Unknown

32. Type of Fuel Tank-1

1

33. Type of Fuel Tank-2

0

- (0) No fuel tank (electrical vehicle)
- (1) Metallic
- (2) Non-metallic
- (9) Unknown

34. Fuel Tank-1 Location

4
0

35. Fuel Tank-2 Location

- (0) No fuel tank
- (1) Aft of center of the rear wheels (rear axle) centered
- (2) Aft of center of the rear wheels (rear axle) left side
- (3) Aft of center of the rear wheels (rear axle) right side
- (4) Forward of center of the rear wheels (rear axle) centered
- (5) Forward of center of the rear wheels (rear axle) left side
- (6) Forward of center of the rear wheels (rear axle) right side
- (7) Over center of the rear wheels (rear axle)
- (8) Other (specify): _____

- (9) Unknown

36. Fuel Tank-1 Filler Cap Location

2

37. Fuel Tank-2 Filler Cap Location

0

- (0) No fuel tank
- (1) On back plane
- (2) Aft of center of the rear wheels (rear axle) on left side plane
- (3) Aft of center of the rear wheels (rear axle) on right side plane
- (4) Forward of center of the rear wheels (rear axle) on left side plane
- (5) Forward of center of the rear wheels (rear axle) on right side plane
- (6) Over the center of the rear wheels (rear axle) on left side plane
- (7) Over the center of the rear wheels (rear axle) on right side plane
- (8) Other (specify): _____
- (9) Unknown

38. Fuel Tank-1 Damage

1

39. Fuel Tank-2 Damage

0

- (0) No fuel tank
- (1) No damage to fuel tank
- (2) Deformed, no seam failure
- (3) Deformed, with a seam failure
- (4) Punctured
- (5) Lacerated (ripped)
- (6) Abraded (scraped)
- (7) Filler neck separation from the fuel tank
- (8) Other damage (specify): _____

- (9) Unknown

40. Location of Fuel System-1 Leakage 1

41. Location of Fuel System-2 Leakage 0

(0) No fuel tank
(1) No fuel leakage

Primary Area Of Leakage

(2) Tank
(3) Filler neck
(4) Cap
(5) Lines/pump/filter
(6) Vent/emission recovery
(8) Other (specify): _____

(9) Unknown

42. Fuel Type-1 0 1

43. Fuel Type-2 0 0

Single Fuel Type

(00) No fuel tank
(01) Gasoline
(02) Diesel
(03) CNG (Compressed Natural Gas)
(04) LPG (Liquid Petroleum Gas) also known as Propane
(05) LNG (Liquid Natural Gas)
(06) Methanol (M100 or M85)
(07) Ethanol (E100 or E85)
(08) Other (Hydrogen or others) (specify): _____

Electric Powered or Electric/Solar Powered Vehicles

(10) Lead Acid Battery
(11) Nickel-Iron Battery
(12) Nickel-Cadmium Battery
(13) Sodium Metal Chloride Battery
(14) Sodium Sulfur Battery
(18) Other (Specify): _____

(98) Other Hybrid (specify): _____

(99) Unknown fuel type

44. Is This Vehicle Equipped With More Than Two Fuel Tanks? 0

(0) No (one or two tanks only)

Yes - More Than Two Tanks

(1) Yes -- no damage to any tank or filler cap and no fuel system leakage

(2) Yes -- no damage to any tank or filler cap but there is fuel system leakage (specify leakage location): _____

(3) Yes -- damage to an additional tank or filler cap and there is fuel system leakage (specify the following):
 Type of tank _____
 Tank location _____
 Filler cap location _____
 Tank damage _____
 Location of leakage _____
 Type of fuel _____

(9) Unknown if more than two tanks

COMMENTS

*** STOP: IF THE CDS APPLICABLE VEHICLE WAS NOT TOWED AND WAS NOT AN AOPS ***
 (I.E., GV09=0 OR 9 AND GV36=0), DO NOT COMPLETE THE INTERIOR VEHICLE FORM.



INTERIOR VEHICLE FORM

1. Primary Sampling Unit Number 41

2. Case Number - Stratum 199A

3. Vehicle Number 01

INTEGRITY

4. Passenger Compartment Integrity 12
(00) No integrity loss

Yes, Integrity Was Lost Through

- (01) Windshield
- (02) Door (side)
- (03) Door/hatch (back door)
- (04) Roof
- (05) Roof glass
- (06) Side window
- (07) Rear window (backlight)
- (08) Roof and roof glass
- (09) Windshield and door (side)
- (10) Windshield and roof
- (11) Side and rear window (side window and backlight)
- (12) Windshield and side window
- (13) Door and side window
- (98) Other combination of above (specify):

(99) Unknown

Door, Tailgate or Hatch Opening

5. LF 3 6. RF 1 7. LR 3 8. RR 1 9. TG/H 0

- (0) No door/gate/hatch
- (1) Door/gate/hatch remained closed and operational
- (2) Door/gate/hatch came open during collision
- (3) Door/gate/hatch jammed shut
- (8) Other (specify):

(9) Unknown

Damage/Failure Associated with Door, Tailgate or Hatch Opening in Collision. If IV05-IV09 ≠ 2, Then code 0

10. LF 0 11. RF 0 12. LR 0 13. RR 0 14. TG/H 0

(0) No door/gate/hatch or door not opened

Door, Tailgate or Hatch Came Open During Collision

- (1) Door operational (no damage)
- (2) Latch/striker failure due to damage
- (3) Hinge failure due to damage
- (4) Door structure failure due to damage
- (5) Door support (i.e., pillar, sill, roof side rail, etc.) failure due to damage
- (6) Latch/striker and hinge failure due to damage
- (8) Other failure (specify):

(9) Unknown

GLAZING

Glazing Damage from Impact Forces

15. WS 4 16. LF 6 17. RF 6 18. LR 0 19. RR 0

20. BL 0 21. Roof 2 22. Other 8

- (0) No glazing damage from impact forces
- (2) Glazing in place and cracked from impact forces
- (3) Glazing in place and holed from impact forces
- (4) Glazing out-of-place (cracked or not) and not holed from impact forces
- (5) Glazing out-of-place and holed from impact forces
- (6) Glazing disintegrated from impact forces
- (7) Glazing removed prior to accident
- (8) No glazing
- (9) Unknown if damaged

Glazing Damage from Occupant Contact

23. WS 0 24. LF 0 25. RF 0 26. LR 0 27. RR 0

28. BL 0 29. Roof 0 30. Other 0

- (0) No occupant contact to glazing or no glazing
- (1) Glazing contacted by occupant but no glazing damage
- (2) Glazing in place and cracked by occupant contact
- (3) Glazing in place and holed by occupant contact
- (4) Glazing out-of-place (cracked or not) by occupant contact and not holed by occupant contact
- (5) Glazing out-of-place by occupant contact and holed by occupant contact
- (6) Glazing disintegrated by occupant contact
- (9) Unknown if contacted by occupant

If No Glazing Damage *And* No Occupant Contact or No Glazing, Then Code IV31 Through IV46 As 0

Type of Window/Windshield Glazing

31. WS 1 32. LF 2 33. RF 2 34. LR 0 35. RR 0

36. BL 0 37. Roof 0 38. Other 0

- (0) No glazing contact and no damage, or no glazing
- (1) AS-1 - Laminated
- (2) AS-2 - Tempered
- (3) AS-3 - Tempered-tinted
- (4) AS-14 - Glass/Plastic
- (8) Other (specify):

(9) Unknown

Window Precrash Glazing Status

39. WS 1 40. LF 2 41. RF 2 42. LR 0 43. RR 0

44. BL 0 45. Roof 0 46. Other 0

- (0) No glazing contact and no damage, or no glazing
- (1) Fixed
- (2) Closed
- (3) Partially opened
- (4) Fully opened
- (9) Unknown

INTRUSION WORKSHEET

Note: Sketch intruded areas

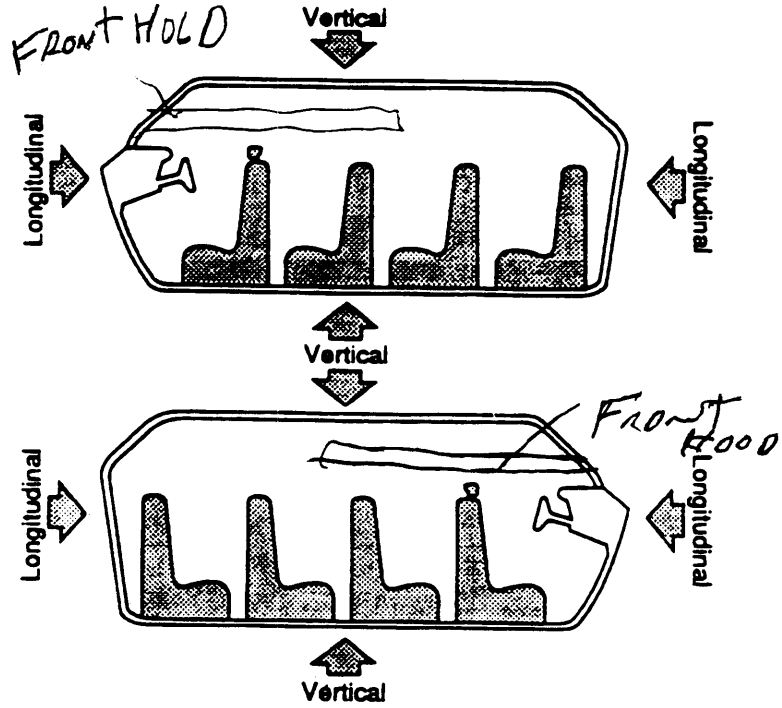
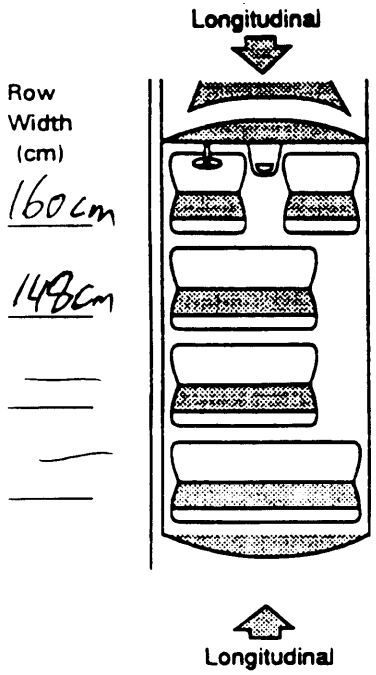

LOCATION OF INTRUSION	INTRUDED COMPONENT	(All Measurements Are In Centimeters)			DOMINANT CRUSH DIRECTION
		COMPARISON VALUE	INTRUDED VALUE	INTRUSION	
11	30 (Hood)	Ø	135cm	= 135	2 (long)
13	30	Ø	135cm	= 135	2
				=	
				=	
PLEASE NOT HOOD INTRUSION					
MEASURED FROM BASE OF WINDSHIELD					
				=	
				=	
				=	
				=	
				=	
				=	
				=	
				=	
				=	

OCCUPANT AREA INTRUSION

Note: If no intrusions, leave variables IV47-IV86 blank.

INTRUDING COMPONENT

	Location of Intrusion	Intruding Component	Magnitude of Intrusion	Dominant Crush Direction
1st	47. <u>11</u>	48. <u>30</u>	49. <u>6</u>	50. <u>2</u>
2nd	51. <u>13</u>	52. <u>30</u>	53. <u>6</u>	54. <u>2</u>
3rd	55. _____	56. _____	57. _____	58. _____
4th	59. _____	60. _____	61. _____	62. _____
5th	63. _____	64. _____	65. _____	66. _____
6th	67. _____	68. _____	69. _____	70. _____
7th	71. _____	72. _____	73. _____	74. _____
8th	75. _____	76. _____	77. _____	78. _____
9th	79. _____	80. _____	81. _____	82. _____
10th	83. _____	84. _____	85. _____	86. _____

Interior Components

- (01) Steering assembly
- (02) Instrument panel left
- (03) Instrument panel center
- (04) Instrument panel right
- (05) Toe pan
- (06) A (A1/A2)-pillar
- (07) B-pillar
- (08) C-pillar
- (09) D-pillar
- (10) Door panel (side)
- (12) Roof (or convertible top)
- (13) Roof side rail
- (14) Windshield
- (15) Windshield header
- (16) Window frame
- (17) Floor pan (includes sill)
- (18) Backlight header
- (19) Front seat back
- (20) Second seat back
- (21) Third seat back
- (22) Fourth seat back
- (23) Fifth seat back
- (24) Seat cushion
- (25) Back door/panel (e.g., tailgate)
- (26) Other interior component (specify): _____

- (27) Side panel - forward of the A (A2)-pillar
- (28) Side panel - rear of the A (A2)-pillar

Exterior Components

- (30) Hood
- (31) Outside surface of this vehicle (specify): _____
- (32) Other exterior object in the environment (specify): _____
- (33) Unknown exterior object
- (97) Catastrophic
- (98) Intrusion of unlisted component(s) (specify): _____
- (99) Unknown

LOCATION OF INTRUSION

- | | |
|-------------|------------------------------------|
| Front Seat | Fourth Seat |
| (11) Left | (41) Left |
| (12) Middle | (42) Middle |
| (13) Right | (43) Right |
| Second Seat | (97) Catastrophic |
| (21) Left | (98) Other enclosed area (specify) |
| (22) Middle | |
| (23) Right | (99) Unknown |
| Third Seat | |
| (31) Left | |
| (32) Middle | |
| (33) Right | |

MAGNITUDE OF INTRUSION

- (1) ≥ 3 centimeters but < 8 centimeters
- (2) ≥ 8 centimeters but < 15 centimeters
- (3) ≥ 15 centimeters but < 30 centimeters
- (4) ≥ 30 centimeters but < 46 centimeters
- (5) ≥ 46 centimeters but < 61 centimeters
- (6) ≥ 61 centimeters
- (7) Catastrophic
- (9) Unknown

DOMINANT CRUSH DIRECTION

- (1) Vertical
- (2) Longitudinal
- (3) Lateral
- (7) Catastrophic
- (9) Unknown

STEERING RIM/SPOKE DEFORMATION

(All Measurements Are in Centimeters)

COMPARISON VALUE	-	DAMAGE VALUE	=	DEFORMATION
* 13cm	-	* 21 cm	=	R 8cm
	-		=	
	-		=	
	-		=	

* Please note TOP of wheel  WAS PUSHED FORWARD 8cm by Interlocking Hood.*

STEERING COLUMN

87. Steering Column Type 2
 (1) Fixed column
 (2) Tilt column
 (3) Telescoping column
 (4) Tilt and telescoping column
 (8) Other column type (specify):
 (9) Unknown

88. Blank X X
 (This variable is left blank so that numbering consistency can be maintained with the 1988-94 CDS.)

89. Blank X X X
 (This variable is left blank so that numbering consistency can be maintained with the 1988-94 CDS.)

90. Blank X X X
 (This variable is left blank so that numbering consistency can be maintained with the 1988-94 CDS.)

91. Blank X X X
 (This variable is left blank so that numbering consistency can be maintained with the 1988-94 CDS.)

92. Steering Rim/Spoke Deformation 08
 Code actual measured deformation to the nearest centimeter
 (00) No steering rim deformation
 (01-14) Actual measured value in centimeters
 (15) 15 centimeters or more
 (98) Observed deformation cannot be measured
 (99) Unknown
please see note on BACK of pg 2

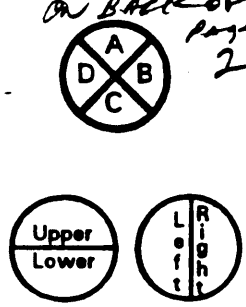
93. Location of Steering Rim/Spoke Deformation 05
 (00) No steering rim deformation
 Quarter Sections
 (01) Section A
 (02) Section B
 (03) Section C
 (04) Section D
 Half Sections
 (05) Upper half of rim/spoke
 (06) Lower half of rim/spoke
 (07) Left half of rim/spoke
 (08) Right half of rim/spoke
 (09) Complete steering wheel collapse
 (10) Undetermined location
 (99) Unknown
PLEASE see note on BACK of page 2

INSTRUMENT PANEL

94. Odometer Reading 999,000
 kilometers—Code to the nearest 1,000 kilometers
 (000) No odometer
 (001) Less than 1,500 kilometers
 (500) 499,500 kilometers or more
 (999) Unknown
TO MUST DASH DAMAGE TO READ ODOMETER
9999 miles x 1.6093 = 9.999 kilometers
 Source: 

95. Instrument Panel Damage from Occupant Contact? 0
 (0) No
 (1) Yes
 (9) Unknown

96. Knee Bolsters Deformed from Occupant Contact? 0
 (0) No
 (1) Yes
 (8) Not present
 (9) Unknown

97. Did Glove Compartment Door Open During Collision(s)? 1
 (0) No
 (1) Yes
 (8) Not present
 (9) Unknown
Due to HOOD Intrusion Damage

VEHICLE INTERIOR SKETCHES

Note area of ejection/entrapment

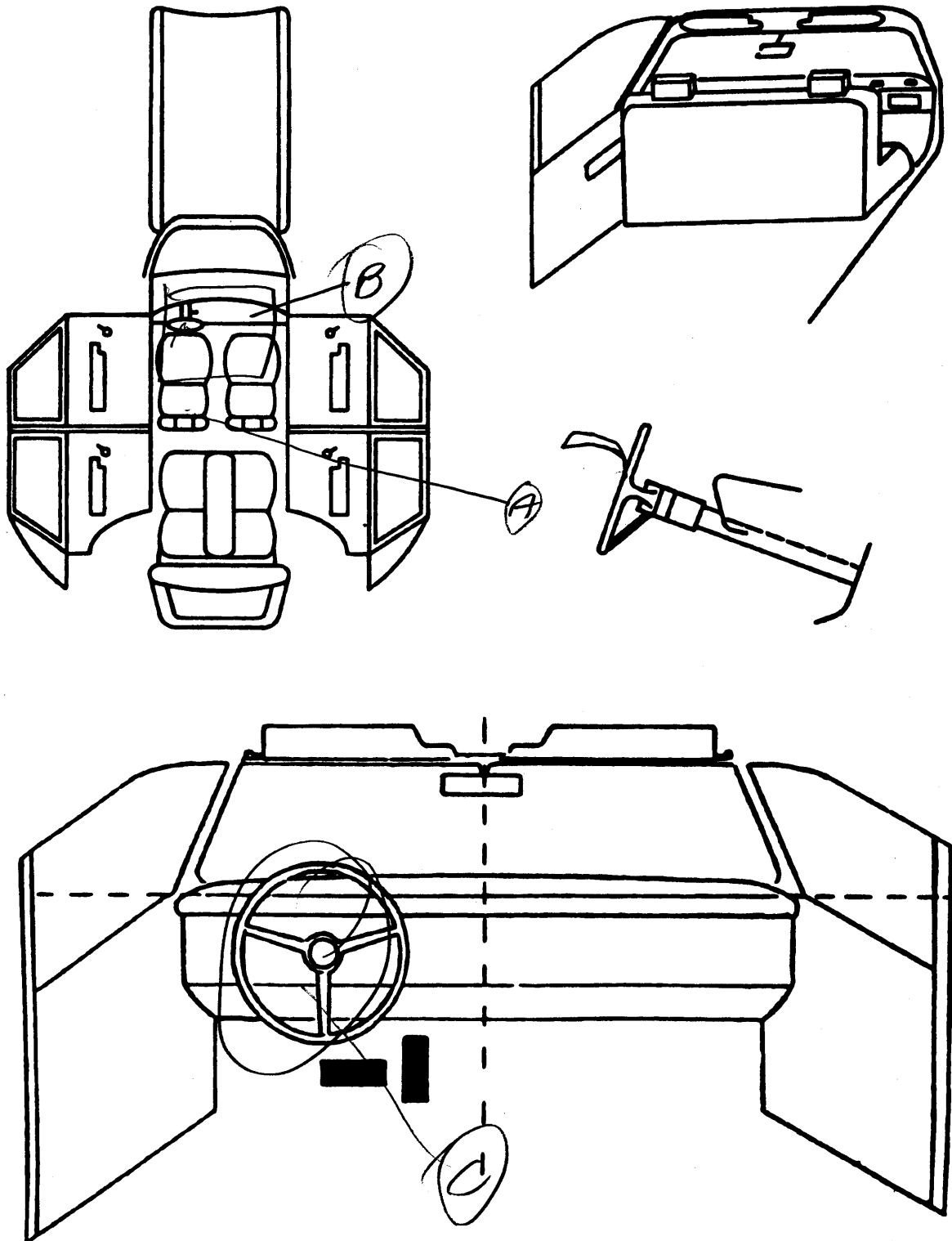

Sketch windshield contact(s) and the damaged area(s) on the instrument panel outline (e.g., radio, glove compartment, damage to instrument panel structure).
Cross hatch contact points, draw spider webs or use other annotation as may be appropriate.
Annotate the contacted area with a letter (begin with A) and list on the Points of Occupant Contact page.

POINTS OF OCCUPANT CONTACT

Contact	Interior Component Contacted	Occupant No. If Known	Body Region If Known	Supporting Physical Evidence	Confidence Level of Contact Point
A	40	1	BACK, BACKSEAT HEAD & NECK	BLOOD ON SEAT	1
B	Front Hood	1	HEAD	Front Hood when through cabin	1
C	45	1	Face	Air Bag Deployed	1
D					
E					
F					
G					
H					
I					
J					
K					
L					
M					
N					

CODES FOR INTERIOR COMPONENTS

FRONT

- (01) Windshield
- (02) Mirror
- (03) Sunvisor
- (04) Steering wheel rim
- (05) Steering wheel hub/spoke
- (06) Steering wheel (combination of codes 04 and 05)
- (07) Steering column, transmission selector lever, other attachment
- (08) Add on equipment (e.g., CB, tape deck, air conditioner)
- (09) Left instrument panel and below
- (10) Center instrument panel and below
- (11) Right instrument panel and below
- (12) Glove compartment door
- (13) Knee bolster
- (14) Windshield including one or more of the following: front header, A (A1/A2)-pillar, instrument panel, mirror, or steering assembly (driver side only)
- (15) Windshield including one or more of the following: front header, A (A1/A2)-pillar, instrument panel, or mirror (passenger side only)
- (16) Driver side air bag compartment cover
- (17) Passenger side air bag compartment cover
- (18) Windshield reinforced by exterior object (specify): _____
- (19) Other front object (specify): _____

- (23) Left B-pillar
- (24) Other left pillar (specify): _____
- (25) Left side window glass or frame
- (26) Left side window glass including one or more of the following: frame, window sill, A (A1/A2)-pillar, B-pillar, or roof side rail.
- (27) Other left side object (specify): _____
- (28) Left side window sill

RIGHT SIDE

- (30) Right side interior surface, excluding hardware or armrests
- (31) Right side hardware or armrest
- (32) Right A (A1/A2)-pillar
- (33) Right B-pillar
- (34) Other right pillar (specify): _____
- (35) Right side window glass or frame
- (36) Right side window glass including one or more of the following: frame, window sill, A (A1/A2)-pillar, B pillar, or roof side rail.
- (37) Other right side object (specify): _____
- (38) Right side window sill

INTERIOR

- (40) Seat, back support.
- (41) Belt restraint webbing/buckle
- (42) Belt restraint B-pillar attachment point
- (43) Other restraint system component (specify): _____
- (44) Head restraint system
- (45) Air bag (use codes "16" and "17" for injuries sustained from air bag compartment covers)

(46) Other occupants (specify): _____

- (47) Interior loose objects
- (48) Child safety seat (specify): _____
- (49) Other interior object (specify): _____

ROOF

- (50) Front header
- (51) Rear header
- (52) Roof left side rail
- (53) Roof right side rail
- (54) Roof or convertible top

FLOOR

- (56) Floor (including toe pan)
- (57) Floor or console mounted transmission lever, including console
- (58) Parking brake handle
- (59) Foot controls including parking brake

REAR

- (60) Backlight (rear window)
- (61) Backlight storage rack, door, etc.
- (62) Other rear object (specify): _____

LEFT SIDE

- (20) Left side interior surface, excluding hardware or armrests
- (21) Left side hardware or armrest
- (22) Left A (A1/A2)-pillar

CONFIDENCE LEVEL OF CONTACT POINT

- (1) Certain
- (2) Probable
- (3) Possible
- (9) Unknown

AUTOMATIC RESTRAINTS

NOTES: Encode the data for each applicable front seat position. The attribute for the variables may be found below. Restraint systems should be assessed during the vehicle inspection then coded on the Occupant Assessment Form.

AIR BAGS

		Left	Right
F I R S T	Availability/Function	1	
	Deployment	1	
	Failure	1	ASK MEER ABOUT TRUCK BAG + Delta

Air Bag System Availability/Function

- (0) Not equipped/not available
- (1) Air bag
- Non-functional*
- (2) Air bag disconnected (specify): _____
- (3) Air bag not reinstalled
- (9) Unknown

Air Bag System Deployment

- (0) Not equipped/not available
- (1) Air bag deployed during accident (as a result of impact)
- (2) Air bag deployed inadvertently just prior to accident
- (3) Air bag deployed, accident sequence undetermined
- (4) Nondeployed
- (5) Unknown if deployed
- (6) Air bag deployed as a result of a noncollision event during accident sequence (e.g., fire, explosion, electrical)
- (9) Unknown

Are There Indications of Air Bag System Failure?

- (0) Not equipped/not available
- (1) No
- (2) Yes (specify): _____
- (9) Unknown

Bag Ripped
OPEN either by
INSTANTLY HOOD
OR EXTRACTION

AUTOMATIC BELTS

		Left	Right
F I R S T	Availability/Function	0	0
	Use	0	0
	Type	0	0
	Proper Use	0	0
	Failure Modes	0	0

Automatic (Passive) Belt System Availability/Function

- (0) Not equipped/not available
- (1) 2 point automatic belts
- (2) 3 point automatic belts
- (3) Automatic belts - type unknown

Non-functional

- (4) Automatic belts destroyed or rendered inoperative
- (9) Unknown

Automatic (Passive) Belt System Use

- (0) Not equipped/not available/destroyed or rendered inoperative
- (1) Automatic belt in use
- (2) Automatic belt not in use (manually disconnected, motorized track inoperative)
- (3) Automatic belt use unknown
- (9) Unknown

Automatic (Passive) Belt System Type

- (0) Not equipped/not available
- (1) Non-motorized system
- (2) Motorized system
- (9) Unknown

Proper Use of Automatic (Passive) Belt System

- (0) Not equipped/not available/not used
- (1) Automatic belt used properly
- (2) Automatic belt used properly with child safety seat

Automatic Belt Used Improperly

- (3) Automatic shoulder belt worn under arm
- (4) Automatic shoulder belt worn behind back
- (5) Automatic belt worn around more than one person
- (6) Lap portion of automatic belt worn on abdomen
- (7) Automatic lap and shoulder belt or automatic shoulder belt used improperly with child safety seat (specify): _____
- (8) Other improper use of automatic belt system (specify): _____
- (9) Unknown

Automatic (Passive) Belt Failure Modes During Accident

- (0) Not equipped/not available/not in use
- (1) No automatic belt failure(s)
- (2) Torn webbing (stretched webbing not included)
- (3) Broken buckle or latchplate
- (4) Upper anchorage separated
- (5) Other anchorage separated (specify): _____
- (6) Broken retractor
- (7) Combination of above (specify): _____
- (8) Other automatic belt failure (specify): _____
- (9) Unknown

MANUAL RESTRAINTS

NOTES: Encode the applicable data for **each seat position** in the vehicle. The attribute for the variable may be found below. Restraint systems should be assessed during the vehicle inspection then coded on the Occupant Assessment Form.

If a Child safety seat is present, encode the data on the back of this page.

If the vehicle has automatic restraints available, encode the appropriate data on the back of the previous page.

		Left	Center	Right
FIRST	Availability	4	0	4
	Evidence of usage	04	00	00
	Used in this crash?	04	00	00
	Proper Use	1	0	0
	Failure Modes	1	0	0
SECOND	Availability	4	3	4
	Evidence of usage	00	00	00
	Used in this crash?	00	00	00
	Proper Use	0	0	0
	Failure Modes	0	0	0
OTHER	Availability	/		
	Evidence of usage	/		
	Used in this crash?	/		
	Proper Use	/		
	Failure Modes	/		

Please note:

Manual (Active) Belt System Availability

- (0) None available
- (1) Belt removed/destroyed
- (2) Shoulder belt
- (3) Lap belt
- (4) Lap and shoulder belt
- (5) Belt available - type unknown

Integral Belt Partially Destroyed

- (6) Shoulder belt (lap belt destroyed/removed)
- (7) Lap belt (shoulder belt destroyed/removed)

(8) Other belt (specify): _____

(9) Unknown

Proper Use of Manual (Active) Belts

- (0) None used or not available
- (1) Belt used properly
- (2) Belt used properly with child safety seat

Belt Used Improperly

- (3) Shoulder belt worn under arm
- (4) Shoulder belt worn behind back or seat
- (5) Belt worn around more than one person
- (6) Lap belt worn on abdomen
- (7) Lap belt or lap and shoulder belt used improperly with child safety seat (specify): _____

(8) Other improper use of manual belt system (specify): _____

(9) Unknown

Manual (Active) Belt System Use

- (00) None used, not available, or belt removed/destroyed
- (01) Inoperable (specify): _____
- (02) Shoulder belt _____
- (03) Lap belt _____
- (04) Lap and shoulder belt _____
- (05) Belt used - type unknown _____
- (08) Other belt used (specify): _____
- (12) Shoulder belt used with child safety seat
- (13) Lap belt used with child safety seat
- (14) Lap and shoulder belt used with child safety seat
- (15) Belt used with child safety seat - type unknown _____
- (18) Other belt used with child safety seat (specify): _____
- (99) Unknown if belt used

Manual (Active) Belt Failure Modes During Accident

- (0) No manual belt used or not available
- (1) No manual belt failure(s)
- (2) Torn webbing (stretched webbing not included)
- (3) Broken buckle or latchplate
- (4) Upper anchorage separated
- (5) Other anchorage separated (specify): _____
- (6) Broken retractor _____
- (7) Combination of above (specify): _____
- (8) Other manual belt failure (specify): _____
- (9) Unknown

There were NO FORWARD occupant contacts. Researcher believes driver was restrained.

CHILD SAFETY SEAT FIELD ASSESSMENT

When a child safety seat is present enter the occupant's number in the first row and complete the column below the occupant's number using the codes listed below. Complete a column for each child safety seat present.

Occupant Number						
1. Type of Child Safety Seat		N/A				
2. Child Safety Seat Orientation						
3. Child Safety Seat Harness Usage						
4. Child Safety Seat Shield Usage						
5. Child Safety Seat Tether Usage						
6. Child Safety Seat Make/Model	Specify Below for Each Child Safety Seat					

<p>1. Type of Child Safety Seat</p> <p>(0) No child safety seat (1) Infant seat (2) Toddler seat (3) Convertible seat (4) Booster seat (7) Other type child safety seat (specify): _____</p> <p>(8) <u>Unknown child safety seat type</u> (9) Unknown if child safety seat used</p> <p>2. Child Safety Seat Orientation</p> <p>(00) No child safety seat</p> <p>Designed for Rear Facing for This Age/Weight (01) Rear facing (02) Forward facing (08) Other orientation (specify): _____</p> <p>(09) <u>Unknown orientation</u></p> <p>Designed for Forward Facing for This Age/Weight (11) Rear facing (12) Forward facing (18) Other orientation (specify): _____</p> <p>(19) <u>Unknown orientation</u></p> <p>Unknown Design or Orientation For This Age/Weight, or Unknown Age/Weight (21) Rear facing (22) Forward facing (28) Other orientation (specify): _____</p> <p>(29) <u>Unknown orientation</u></p> <p>(99) Unknown if child safety seat used</p>	<p>3. Child Safety Seat Harness Usage</p> <p>4. Child Safety Seat Shield Usage</p> <p>5. Child Safety Seat Tether Usage Note: Options Below Are Used for Variables 3-5. (00) No child safety seat</p> <p>Not Designed with Harness/Shield/Tether (01) After market harness/shield/tether added, not used (02) After market harness/shield/tether used (03) Child safety seat used, but no after market harness/shield/tether added (09) Unknown if harness/shield/tether added or used</p> <p>Designed With Harness/Shield/Tether (11) Harness/shield/tether not used (12) Harness/shield/tether used (19) Unknown if harness/shield/tether used</p> <p>Unknown If Designed With Harness/Shield/Tether (21) Harness/shield/tether not used (22) Harness/shield/tether used (29) Unknown if harness/shield/tether used</p> <p>(99) Unknown if child safety seat used</p> <p>6. Child Safety Seat Make/Model (Specify make/model and occupant number)</p> <p>_____</p> <p>_____</p> <p>_____</p> <p>_____</p>
--	--

HEAD RESTRAINTS/SEAT EVALUATION

NOTES: Encode the applicable data for **each seat position** in the vehicle. The attribute for these variables may be found at the bottom of the page. Head restraint type/damage and seat type/performance should be assessed during the vehicle inspection then coded on the Occupant Assessment Form.

		Left	Center	Right
FIRST	Head Restraint Type/Damage	3	0	3
	Seat Type	01	00	01
	Seat Performance	1	0	1
	Seat Orientation	1	0	1
SECOND	Head Restraint Type/Damage	1	0	1
	Seat Type	07	07	07
	Seat Performance	1	1	1
	Seat Orientation	1	1	1
THIRD	Head Restraint Type/Damage	/		
	Seat Type	/		
	Seat Performance	/		
	Seat Orientation	/		
OTHER	Head Restraint Type/Damage	/		
	Seat Type	/		
	Seat Performance	/		
	Seat Orientation	/		

Head Restraint Type/Damage by Occupant at This Occupant Position

- (0) No head restraints
- (1) Integral — no damage
- (2) Integral — damaged during accident
- (3) Adjustable — no damage
- (4) Adjustable — damaged during accident
- (5) Add-on — no damage
- (6) Add-on — damaged during accident
- (8) Other Specify: _____
- (9) Unknown

Seat Type (this Occupant Position)

- (00) Occupant not seated or no seat
- (01) Bucket
- (02) Bucket with folding back
- (03) Bench
- (04) Bench with separate back cushions
- (05) Bench with folding back(s)
- (06) Split bench with separate back cushions
- (07) Split bench with folding back(s)
- (08) Pedestal (i.e., column supported)
- (09) Other seat type (specify): _____
- (10) Box mounted seat (i.e., van type)
- (99) Unknown

Seat Performance (this Occupant Position)

- (0) Occupant not seated or no seat
- (1) No seat performance failure(s)
- (2) Seat adjusters failed
- (3) Seat back folding locks or "seat back" failed specify: _____
- (4) Seat tracks/anchors failed
- (5) Deformed by impact of occupant
- (6) Deformed by passenger compartment intrusion (specify): _____
- (7) Combination of above (specify): _____
- (8) Other (specify): _____
- (9) Unknown

Seat Orientation (this Occupant Position)

- (0) Occupant not seated or no seat
- (1) Forward facing seat
- (2) Rear facing seat
- (3) Side facing seat (inward)
- (4) Side facing seat (outward)
- (8) Other (specify): _____
- (9) Unknown

DESCRIBE ANY INDICATION OF ABNORMAL OCCUPANT POSTURE (I.E., UNUSUAL OCCUPANT CONTACT PATTERN)

EJECTION/ENTRAPMENT DATA

Complete the following if the researcher has any indication that an occupant was either ejected from or entrapped in the vehicle. Code the appropriate data on the Occupant Assessment Form.

EJECTION No [] Yes []

Describe indications of ejection and body parts involved in partial ejection(s):

Occupant Number						
Ejection						
(Note on Vehicle Interior Sketch) Ejection Area						
Ejection Medium						
Medium Status						

Ejection

- (1) Complete ejection
- (2) Partial ejection
- (3) Ejection, Unknown degree
- (9) Unknown

Ejection Area

- (1) Windshield
- (2) Left front
- (3) Right front
- (4) Left rear
- (5) Right rear
- (6) Rear

(7) Roof

(8) Other area (e.g., back of pickup, etc.) (specify): _____

(9) Unknown

Ejection Medium

- (1) Door/hatch/tailgate
- (2) Nonfixed roof structure
- (3) Fixed glazing
- (4) Nonfixed glazing (specify): _____

(5) Integral structure

(8) Other medium (specify): _____

(9) Unknown

Medium Status (Immediately Prior to Impact)

- (1) Open
- (2) Closed
- (3) Integral structure
- (9) Unknown

ENTRAPMENT No [] Yes []

Describe entrapment mechanism: _____

Component(s): _____

(Note in vehicle interior diagram)



OCCUPANT ASSESSMENT FORM

1. Primary Sampling Unit Number 41
 2. Case Number - Stratum 199A
 3. Vehicle Number 01
 4. Occupant Number 01

OCCUPANT'S CHARACTERISTICS

5. Occupant's Age 22
 Code actual age at time of accident.
 (00) Less than one year old (specify by month):
 (97) 97 years and older
 (99) Unknown

6. Occupant's Sex 1
 (1) Male
 (2) Female
 (9) Unknown

7. Occupant's Height 180
185
 Code actual height to the nearest centimeter.
 (999) Unknown 180
~~73~~ inches X 2.54 = ~~185~~ centimeters
71

8. Occupant's Weight 075
073
 Code actual weight to the nearest kilogram.
 (999) Unknown 075
~~160~~ pounds X .4536 = ~~073~~ kilograms
166

9. Occupant's Role 1
 (1) Driver
 (2) Passenger
 (9) Unknown

OCCUPANT'S SEATING

10. Occupant's Seat Position 11
Front Seat
 (11) Left side
 (12) Middle
 (13) Right side
 (14) Other (specify):
 (15) On or in the lap of another occupant

Second Seat
 (21) Left side
 (22) Middle
 (23) Right side
 (24) Other (specify):
 (25) On or in the lap of another occupant

Third Seat
 (31) Left side
 (32) Middle
 (33) Right side
 (34) Other (specify):
 (35) On or in the lap of another occupant

Fourth Seat
 (41) Left side
 (42) Middle
 (43) Right side
 (44) Other (specify):
 (45) On or in the lap of another occupant

(97) In or on unenclosed area
 (98) Other seat (specify):
 (99) Unknown

11. Occupant's Posture 0
 (0) Normal posture

Abnormal posture
 (1) Kneeling or standing on seat
 (2) Lying on or across seat
 (3) Kneeling, standing or sitting in front of seat
 (4) Sitting sideways or turned to talk with another occupant or to look out a rear window
 (5) Sitting on a console
 (6) Lying back in a reclined seat position
 (7) Bracing with feet or hands on a surface in front of seat
 (8) Other abnormal posture (specify):
 (9) Unknown

EJECTION/ENTRAPMENT

12. Ejection 0

- (0) No ejection
- (1) Complete ejection
- (2) Partial ejection
- (3) Ejection, unknown degree
- (9) Unknown

15. Medium Status (Immediately Prior To Impact) 0

- (0) No ejection
- (1) Open
- (2) Closed
- (3) Integral structure
- (9) Unknown

13. Ejection Area 0

- (0) No ejection
- (1) Windshield
- (2) Left front
- (3) Right front
- (4) Left rear
- (5) Right rear
- (6) Rear
- (7) Roof
- (8) Other area (e.g., back of pickup, etc.)
(specify): _____
- (9) Unknown

16. Entrapment 0

- (NOTE: Entrapped means that part of the person was in the vehicle and mechanically restrained; jammed doors and immobilizing injuries by themselves are not sufficient to constitute entrapment.)
- (0) Not entrapped
 - (1) Entrapped
 - (9) Unknown

14. Ejection Medium 0

- (0) No ejection
- (1) Door/hatch/tailgate
- (2) Nonfixed roof structure
- (3) Fixed glazing
- (4) Nonfixed glazing (specify): _____
- (5) Integral structure
- (8) Other medium (specify): _____
- (9) Unknown

RESTRAINT SYSTEM EVALUATION

17. Manual (Active) Belt System Availability 4

- (0) None available
 (1) Belt removed/destroyed
 (2) Shoulder belt
 (3) Lap belt
 (4) Lap and shoulder belt
 (5) Belt available—type unknown

Integral Belt Partially Destroyed

- (6) Shoulder belt (lap belt destroyed/removed)
 (7) Lap belt (shoulder belt destroyed/removed)

(8) Other belt (specify): _____

(9) Unknown _____

18. Manual (Active) Belt System Use 04

- (00) None used, not available, or belt removed/destroyed
 (01) Inoperative (specify): _____

- (02) Shoulder belt
 (03) Lap belt
 (04) Lap and shoulder belt
 (05) Belt used—type unknown
 (08) Other belt used (specify): _____

(12) Shoulder belt used with child safety seat

(13) Lap belt used with child safety seat

(14) Lap and shoulder belt used with child safety seat

(15) Belt used with child safety seat—type unknown

(18) Other belt used with child safety seat (specify): _____

(99) Unknown if belt used _____

19. Proper Use of Manual (Active) Belts 1

- (0) None used or not available
 (1) Belt used properly
 (2) Belt used properly with child safety seat

Belt Used Improperly

- (3) Shoulder belt worn under arm
 (4) Shoulder belt worn behind back or seat
 (5) Belt worn around more than one person
 (6) Lap belt worn on abdomen
 (7) Lap belt or lap and shoulder belt used improperly with child safety seat (specify): _____

(8) Other improper use of manual belt system (specify): _____

(9) Unknown _____

20. Manual (Active) Belt Failure Modes During Accident 1

- (0) No manual belt used
 (1) No manual belt failure(s)
 (2) Torn webbing (stretched webbing not included)
 (3) Broken buckle or latchplate
 (4) Upper anchorage separated
 (5) Other anchorage separated (specify): _____

(6) Broken retractor _____

(7) Combination of above (specify): _____

(8) Other manual belt failure (specify): _____

(9) Unknown _____

21. Air Bag System Availability/Function 1

- (0) Not equipped/not available
 (1) Air bag

Non-functional

(2) Air bag disconnected (specify): _____

(3) Air bag not reinstalled _____

(9) Unknown _____

22. Air Bag System Deployment 1

- (0) Not equipped/not available
 (1) Air bag deployed during accident (as a result of impact)
 (2) Air bag deployed inadvertently just prior to accident
 (3) Air bag deployed, accident sequence undetermined
 (4) Nondeployed
 (5) Unknown if deployed
 (6) Air bag deployed as a result of a noncollision event during accident sequence (e.g., fire, explosion, electrical)
 (9) Unknown

23. Are There Indications of Air Bag System Failure? 1

- (0) Not equipped/not available
 (1) No
 (2) Yes (specify): _____

(9) Unknown _____

Note: See Variables 44 through 48 (Page 5) for Information on Automatic Belts

24. Police Reported Restraint Use 5

- (0) None used
 (1) Police did not indicate restraint use
 (2) Shoulder belt
 (3) Lap belt
 (4) Lap and shoulder belt
 (5) Belt used, type not specified
 (6) Child safety seat
 (7) Other or automatic restraint (specify): _____

(8) Restrained, type unknown _____

(9) Police indicated "unknown" _____

CALL
 PRICER
 SEE IV 3
 FORM 1

HEAD RESTRAINT AND SEAT EVALUATION

25. Head Restraint Type/Damage by Occupant at This Occupant Position

3

- (0) No head restraints
- (1) Integral—no damage
- (2) Integral—damaged during accident
- (3) Adjustable—no damage
- (4) Adjustable—damaged during accident
- (5) Add-on—no damage
- (6) Add-on—damaged during accident
- (8) Other (specify):

- (9) Unknown

26. Seat Type (this Occupant Position)

01

- (00) Occupant not seated or no seat
- (01) Bucket
- (02) Bucket with folding back
- (03) Bench
- (04) Bench with separate back cushions
- (05) Bench with folding back(s)
- (06) Split bench with separate back cushions
- (07) Split bench with folding back(s)
- (08) Pedestal (i.e., column supported)
- (09) Other seat type (specify):

- (10) Box mounted seat (i.e., van type)
- (99) Unknown

27. Seat Performance (this Occupant Position)

1

- (0) Occupant not seated or no seat
- (1) No seat performance failure(s)
- (2) Seat adjusters failed
- (3) Seat back folding locks or "seat back" failed (specify):

- (4) Seat track/anchors failed
- (5) Deformed by impact of occupant
- (6) Deformed by passenger compartment intrusion (specify):

- (7) Combination of above (specify):

- (8) Other (specify):

- (9) Unknown

CHILD SAFETY SEAT

28. Child Safety Seat Make/Model 000
 (000) No child safety seat
 Applicable codes are found in your NASS CDS
 Data Collection, Coding and Editing
 (950) Built-in child safety seat
 (997) Other make/model (specify):

 (998) Unknown make/model
 (999) Unknown if child safety seat used

29. Type of Child Safety Seat 0
 (0) No child safety seat
 (1) Infant seat
 (2) Toddler seat
 (3) Convertible seat
 (4) Booster seat
 (7) Other type child safety seat (specify):

 (8) Unknown child safety seat type
 (9) Unknown if child safety seat used

30. Child Safety Seat Orientation 00
 (00) No child safety seat

Designed for Rear Facing for This Age/Weight
 (01) Rear facing
 (02) Forward facing
 (08) Other orientation (specify):

 (09) Unknown orientation

Designed For Forward Facing for This Age/Weight
 (11) Rear facing
 (12) Forward facing
 (18) Other orientation (specify):

 (19) Unknown orientation

Unknown Design or Orientation For This Age/Weight, or Unknown Age/Weight
 (21) Rear facing
 (22) Forward facing
 (28) Other orientation (specify):

 (29) Unknown orientation

 (99) Unknown if child safety seat used

31. Child Safety Seat Harness Usage 00

 32. Child Safety Seat Shield Usage 00

 33. Child Safety Seat Tether Usage 00

Note: Options below applicable to Variables OA31-OA33.
 (00) No child safety seat

Not Designed With Harness/Shield/Tether
 (01) After market harness/shield/tether added, not used
 (02) After market harness/shield/tether used
 (03) Child safety seat used, but no after market harness/shield/tether added
 (09) Unknown if harness/shield/tether added or used

Designed With Harness/Shield/Tether
 (11) Harness/shield/tether not used
 (12) Harness/shield/tether used
 (19) Unknown if harness/shield/tether used

Unknown If Designed With Harness/Shield/Tether
 (21) Harness/shield/tether not used
 (22) Harness/shield/tether used
 (29) Unknown if harness/shield/tether used

 (99) Unknown if child safety seat used

INJURY CONSEQUENCES34. Injury Severity (Police Rating) 4

- (0) O - No injury
- (1) C - Possible injury
- (2) B - Nonincapacitating injury
- (3) A - Incapacitating injury
- (4) K - Killed
- (5) U - Injury, severity unknown
- (6) Died prior to accident
- (9) Unknown

35. Treatment - Mortality 1

- (0) No treatment
- (1) Fatal (*on scene*)
- (2) Fatal - ruled disease (specify):

Nonfatal

- (3) Hospitalization
- (4) Transported and released
- (5) Treatment at scene - nontransported
- (6) Treatment later
- (8) Treatment - other (specify):

- (9) Unknown

36. Type Of Medical Facility (for Initial Treatment) 0

- (0) Not treated at a medical facility
- (1) Trauma center
- (2) Hospital
- (3) Medical clinic
- (4) Physician's office
- (5) Treatment later at medical facility
- (8) Other (specify):

- (9) Unknown

37. Hospital Stay 00

- (00) Not Hospitalized
Code the number of days (up through 60)
that the occupant stayed in hospital.
- (61) 61 days or more
- (99) Unknown

38. Working Days Lost 62

- Code the number of days
(up through 60) that the occupant
lost from work due to the accident
- (00) No working days lost
- (61) 61 days or more
- (62) Fatally injured
- (97) Not working prior to accident
- (99) Unknown

STOP - GO TO VARIABLE 44 ON PAGE 7**VARIABLES 39 THROUGH 43 ARE
COMPLETED BY THE ZONE CENTER**39. Time to Death 01

- Code number of hours from time of
accident to time of death up through 24
hours. If time of death is greater than 24
hours, code number of days. (Note: 1 day =
31, 2 days = 32, ... n days = 30 + n up
through 30 days = 60)
- (00) Not fatal
- (96) Fatal - ruled disease
- (99) Unknown

40. 1st Medically Reported Cause of Death 0641. 2nd Medically Reported Cause of Death 0242. 3rd Medically Reported Cause of Death 04

- Code the Occupant Injury from line
number(s) for the medically reported
injury(s) which reportedly contributed to
this occupant's death
- (00) Not fatal or no additional causes
- (96) Mode of death given but specific
injuries are not linked to cause
of death. (specify):

(97) Other result (includes fatal ruled
disease) (specify):

(99) Unknown

43. Number of Recorded Injuries for
This Occupant 15

- Code the actual number of
injuries recorded for this occupant.
- (00) No recorded injuries
- (97) Injured, details unknown
- (99) Unknown if injured

AUTOMATIC BELT SYSTEM

44. Automatic (Passive) Belt System Availability/ Function 0

- (0) Not equipped/not available
- (1) 2 point automatic belts
- (2) 3 point automatic belts
- (3) Automatic belts - type unknown

Non-functional

- (4) Automatic belts destroyed or rendered inoperative
- (9) Unknown

45. Automatic (Passive) Belt System Use 0

- (0) Not equipped/not available/destroyed or rendered inoperative
- (1) Automatic belt in use
- (2) Automatic belt not in use (manually disconnected, motorized track inoperative) (specify):

- (3) Automatic belt use unknown
- (9) Unknown

46. Automatic (Passive) Belt System Type 0

- (0) Not equipped/not available
- (1) Non-motorized system
- (2) Motorized system
- (9) Unknown

47. Proper Use of Automatic (Passive) Belt System 0

- (0) Not equipped/not available/not used
- (1) Automatic belt used properly
- (2) Automatic belt used properly with child safety seat

Automatic Belt Used Improperly

- (3) Automatic shoulder belt worn under arm
- (4) Automatic shoulder belt worn behind back
- (5) Automatic belt worn around more than one person
- (6) Lap portion of automatic belt worn on abdomen
- (7) Automatic lap and shoulder belt or automatic shoulder belt used improperly with child safety seat (specify):

- (8) Other improper use of automatic belt system (specify):
- (9) Unknown

48. Automatic (Passive) Belt Failure Modes During Accident 0

- (0) Not equipped/not available/not in use
- (1) No automatic belt failure(s)
- (2) Torn webbing (stretched webbing not included)
- (3) Broken buckle or latchplate
- (4) Upper anchorage separated
- (5) Other anchorage separated (specify):

- (6) Broken retractor
- (7) Combination of above (specify):
- (8) Other automatic belt failure (specify):

- (9) Unknown

49. Seat Orientation (this Occupant Position) 1

- (0) Occupant not seated or no seat
- (1) Forward facing seat
- (2) Rear facing seat
- (3) Side facing seat (inward)
- (4) Side facing seat (outward)
- (8) Other (specify):

- (9) Unknown

Check the Primary Source Used In Determining Belt Use.

- Not equipped/not available/destroyed or rendered inoperative
- Vehicle inspection
- Official injury data
- Driver/occupant interview
- Other (specify):

- Unknown if belt used

ARE ALL APPLICABLE MEDICAL RECORDS INCLUDED WITH INITIAL SUBMISSION?

NO [] YES []

UPDATE CANDIDATE?

NO [] YES []

STOP - VARIABLES 50 THROUGH 53 ARE COMPLETED BY THE ZONE CENTER

TRAUMA DATA

50. Glasgow Coma Scale (GCS) Score 01
 (at Medical Facility)
 (00) Not injured
 (01) Injured - not treated at medical facility
 (02) No GCS Score at medical facility
 (03-15) Code the actual value of the initial GCS Score recorded at medical facility.
 (97) Injured, details unknown
 (99) Unknown if injured
51. Was the Occupant Given Blood? 1
 (1) No - blood not given
 (2) Yes - blood given
 (specify units): _____
 (9) Unknown if blood given
52. Arterial Blood Gases (ABG) - HCO₃ 01
 (00) Not injured
 (01) Injured. ABGs not measured or reported
 (02-50) Code the actual value of the HCO₃
 (96) ABGs reported, HCO₃ unknown
 (97) Injured, details unknown
 (99) Unknown if injured

BELT USE DETERMINATION

53. Primary Source of Belt Use Determination 1
 (0) Not equipped/not available/destroyed or rendered inoperative
 (1) Vehicle inspection
 (2) Official injury data
 (3) Driver/occupant interview
 (8) Other (specify): _____
 (9) Unknown if belt used



OCCUPANT INJURY FORM

1. Primary Sampling Unit Number <u>41</u>	3. Vehicle Number <u>01</u>
2. Case Number - Stratum <u>199A</u>	4. Occupant Number <u>01</u>

INJURY DATA

Record below the actual injuries sustained by this occupant that were identified from the official and unofficial data sources. Remember not to double count an injury just because it was identified from two different sources. If greater than ten injuries have been documented, encode the balance on the Occupant Injury Supplement.

brain

④

skull

jaw

loose teeth

Source of Injury Data	A.I.S. - 90							Injury Source	Injury Source Confidence Level	Direct/Indirect Injury	Occupant Area Intrusion Number	
	Body Region	Type of Anatomic Structure	Specific Anatomic Structure	Level of Injury	A.I.S. Severity	Aspect	Injury Source					
<i>Subarachnoid hemorrhage</i>	1st	5. <u>1</u>	6. <u>1</u>	7. <u>4</u>	8. <u>06</u>	9. <u>84</u>	10. <u>3</u>	11. <u>9</u>	12. <u>85</u>	13. <u>3</u>	14. <u>1</u>	15. <u>00</u>
<i>intracerebral hemorrhage</i>	2nd	16. <u>1</u>	17. <u>1</u>	18. <u>4</u>	19. <u>06</u>	20. <u>78</u>	21. <u>4</u>	22. <u>9</u>	23. <u>85</u>	24. <u>3</u>	25. <u>1</u>	26. <u>00</u>
<i>brain swelling</i>	3rd	27. <u>1</u>	28. <u>1</u>	29. <u>4</u>	30. <u>06</u>	31. <u>60</u>	32. <u>3</u>	33. <u>9</u>	34. <u>85</u>	35. <u>3</u>	36. <u>1</u>	37. <u>00</u>
<i>brain lacerations</i>	4th	38. <u>1</u>	39. <u>1</u>	40. <u>4</u>	41. <u>06</u>	42. <u>88</u>	43. <u>4</u>	44. <u>3</u>	45. <u>85</u>	46. <u>3</u>	47. <u>1</u>	48. <u>00</u>
<i>fr- frontal bone</i>	5th	49. <u>1</u>	50. <u>1</u>	51. <u>5</u>	52. <u>04</u>	53. <u>00</u>	54. <u>2</u>	55. <u>5</u>	56. <u>85</u>	57. <u>3</u>	58. <u>1</u>	59. <u>00</u>
<i>fr- base</i>	6th	60. <u>1</u>	61. <u>1</u>	62. <u>5</u>	63. <u>02</u>	64. <u>06</u>	65. <u>4</u>	66. <u>8</u>	67. <u>85</u>	68. <u>3</u>	69. <u>1</u>	70. <u>00</u>
<i>jaw fr</i>	7th	71. <u>1</u>	72. <u>2</u>	73. <u>5</u>	74. <u>06</u>	75. <u>10</u>	76. <u>2</u>	77. <u>9</u>	78. <u>65</u>	79. <u>3</u>	80. <u>1</u>	81. <u>01</u>
<i>loose teeth</i>	8th	82. <u>1</u>	83. <u>2</u>	84. <u>5</u>	85. <u>14</u>	86. <u>02</u>	87. <u>1</u>	88. <u>8</u>	89. <u>65</u>	90. <u>3</u>	91. <u>1</u>	92. <u>01</u>
<i>head contusion</i>	9th	93. <u>1</u>	94. <u>1</u>	95. <u>9</u>	96. <u>04</u>	97. <u>02</u>	98. <u>1</u>	99. <u>5</u>	100. <u>85</u>	101. <u>3</u>	102. <u>1</u>	103. <u>00</u>
<i>nose abrasions</i>	10th	104. <u>1</u>	105. <u>2</u>	106. <u>9</u>	107. <u>02</u>	108. <u>02</u>	109. <u>1</u>	110. <u>4</u>	111. <u>91</u>	112. <u>3</u>	113. <u>3</u>	114. <u>00</u>

OFFICIAL INJURY DATA — SOFT TISSUE INJURIES

Indicate the Location, Specific Anatomic Structure, Detail (size, depth, fracture type, head injury clinical signs and neurological deficits), and Source of all injuries indicated by official sources (or from PAR or other unofficial sources if medical records and interviewee data are unavailable.)

ALL INJURIES FROM AUTOPSY

SUPERFICIAL AND
PARTIAL THICKNESS ABRASIONS

DIER: NOSE,
CENTRAL TO (R) FOREHEAD,
AREA SUPERIOR +
LATERAL TO (R) EYE

(R) SKIN - 1007
FULL THICKNESS
LACERATION -
WITHIN THIS LAC.
FRAGMENTS OF
EX MANDIBLE ARE
APPARENT

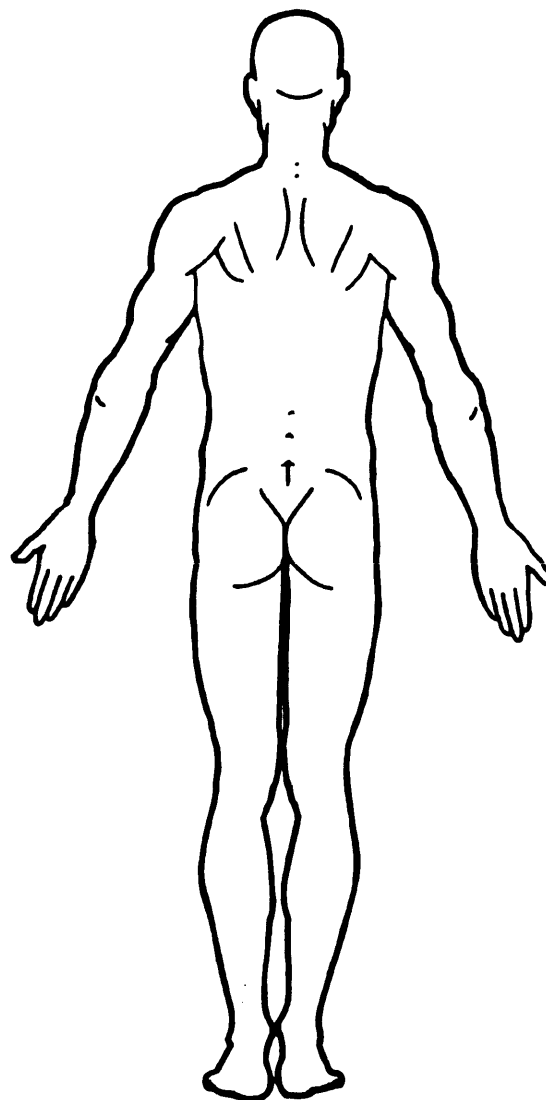
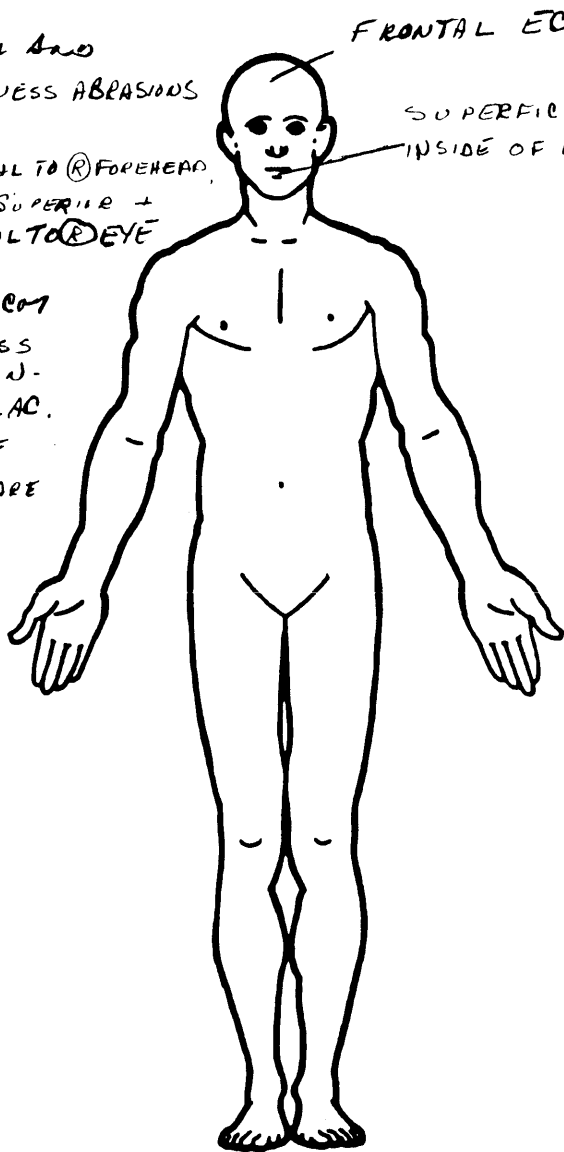

SOURCE OF INJURY DATA

OFFICIAL

- (1) Autopsy records with or without hospital/medical records
- (2) Hospital/medical records other than emergency room (e.g., discharge summary)
- (3) Emergency room records only (including associated X-rays or other lab reports)
- (4) Private physician, walk-in or emergency clinic

UNOFFICIAL

- (5) Lay coroner report
- (6) E.M.S. personnel
- (7) Interviewee
- (8) Other source (specify): _____
- (9) Police

INJURY SOURCE

FRONT

- (01) Windshield
- (02) Mirror
- (03) Sunvisor
- (04) Steering wheel rim
- (05) Steering wheel hub/spoke
- (06) Steering wheel (combination of codes 04 and 05)
- (07) Steering column, transmission selector lever, other attachment
- (08) Add on equipment (e.g., CB, tape deck, air conditioner)
- (09) Left instrument panel and below
- (10) Center instrument panel and below
- (11) Right instrument panel and below
- (12) Glove compartment door
- (13) Knee bolster
- (14) Windshield including one or more of the following: front header, A (A1/A2)-pillar, instrument panel, mirror, or steering assembly (driver side only)
- (15) Windshield including one or more of the following: front header, A (A1/A2)-pillar, instrument panel, or mirror (passenger side only)
- (16) Driver side air bag compartment cover
- (17) Passenger side air bag compartment cover
- (18) Windshield reinforced by exterior object (specify): _____
- (19) Other front object (specify): _____

LEFT SIDE

- (20) Left side interior surface, excluding hardware or armrests
- (21) Left side hardware or armrest
- (22) Left A (A1/A2)-pillar
- (23) Left B-pillar
- (24) Other left pillar (specify): _____

- (25) Left side window glass or frame
- (26) Left side window glass including one or more of the following: frame, window sill, A (A1/A2)-pillar, B-pillar, or roof side rail.
- (27) Other left side object (specify): _____
- (28) Left side window sill

RIGHT SIDE

- (30) Right side interior surface, excluding hardware or armrests
- (31) Right side hardware or armrest
- (32) Right A (A1/A2)-pillar
- (33) Right B-pillar
- (34) Other right pillar (specify): _____
- (35) Right side window glass or frame
- (36) Right side window glass including one or more of the following: frame, window sill, A (A1/A2)-pillar, B-pillar, or roof side rail.
- (37) Other right side object (specify): _____
- (38) Right side window sill

INTERIOR

- (40) Seat, back support
- (41) Belt restraint webbing/buckle
- (42) Belt restraint B-pillar or door frame attachment point
- (43) Other restraint system component (specify): _____
- (44) Head restraint system
- (45) Air bag (use codes "16" and "17" for injuries sustained from air bag compartment covers)
- (46) Other occupants (specify): _____
- (47) Interior loose objects
- (48) Child safety seat (specify): _____
- (49) Other interior object (specify): _____

ROOF

- (50) Front header
- (51) Rear header
- (52) Roof left side rail
- (53) Roof right side rail
- (54) Roof or convertible top

FLOOR

- (56) Floor (including toe pan)
- (57) Floor or console mounted transmission lever, including console
- (58) Parking brake handle
- (59) Foot controls including parking brake

REAR

- (60) Backlight (rear window)

- (61) Backlight storage rack, door, etc.
- (62) Other rear object (specify): _____

EXTERIOR of OCCUPANT'S VEHICLE

- (65) Hood
- (66) Outside hardware (e.g., outside mirror, antenna)
- (67) Other exterior surface or tires (specify): _____
- (68) Unknown exterior objects

EXTERIOR OF OTHER MOTOR VEHICLE

- (70) Front bumper
- (71) Hood edge
- (72) Other front of vehicle (specify): _____
- (73) Hood
- (74) Hood ornament
- (75) Windshield, roof rail, A-pillar
- (76) Side surface
- (77) Side mirrors
- (78) Other side protrusions (specify) _____

- (79) Rear surface
- (80) Undercarriage
- (81) Tires and wheels
- (82) Other exterior of other motor vehicle (specify): _____

- (83) Unknown exterior of other motor vehicle

OTHER VEHICLE OR OBJECT IN THE ENVIRONMENT

- (84) Ground
- (85) Other vehicle or object (specify) _____
- (86) Unknown vehicle or object

NONCONTACT INJURY

- (90) Fire in vehicle
- (91) Flying glass
- (92) Other noncontact injury source (specify): _____
- (93) Air bag exhaust gases
- (97) Injured, unknown source

INJURY SOURCE CONFIDENCE LEVEL

- (1) Certain
- (2) Probable
- (3) Possible
- (9) Unknown

DIRECT/INDIRECT INJURY

- (1) Direct contact injury
- (2) Indirect contact injury
- (3) Noncontact injury
- (7) Injured, unknown source

OCCUPANT INJURY CLASSIFICATION

Body Region

- (1) Head
- (2) Face
- (3) Neck
- (4) Thorax
- (5) Abdomen
- (6) Spine
- (7) Upper Extremity
- (8) Lower Extremity
- (9) Unspecified

Type of Anatomic Structure

- (1) Whole Area
- (2) Vessels
- (3) Nerves
- (4) Organs (includes muscles/ligaments)
- (5) Skeletal (includes joints)
- (6) Head - LOC
- (9) Skin

Specific Anatomic Structure

- Whole Area
- (02) Skin - Abrasion
 - (04) Skin - Contusion
 - (06) Skin - Laceration
 - (08) Skin - Avulsion
 - (10) Amputation
 - (20) Burn
 - (30) Crush
 - (40) Degloving
 - (50) Injury - NFS
 - (90) Trauma, other than mechanical

- Head - LOC
- (02) Length of LOC
 - (04, 06, 08) Level of Consciousness
 - (10) Concussion

Spine

- (02) Cervical
- (04) Thoracic
- (06) Lumbar

Vessels, Nerves, Organs, Bones, Joints are assigned consecutive two digit numbers beginning with 02

Level of Injury

Specific injuries are assigned consecutive two-digit numbers beginning with 02.

To the extent possible, within the organizational framework of the AIS, 00 is assigned to an injury NFS as to severity or where only one injury is given in the dictionary for that anatomic structure. 99 is assigned to any injury NFS as to lesion or severity.

Abbreviated Injury Scale

- (1) Minor injury
- (2) Moderate injury
- (3) Serious injury
- (4) Severe injury
- (5) Critical injury
- (6) Maximum (untreatable)
- (7) Injured, unknown severity

Aspect

- (1) Right
- (2) Left
- (3) Bilateral
- (4) Central
- (5) Anterior
- (6) Posterior
- (7) Superior
- (8) Inferior
- (9) Unknown
- (0) Whole region

OFFICIAL INJURY DATA — SKELETAL INJURIES

Restrained?

— No *NR*
 — Yes

Blood Alcohol Level (mg/dl)

BAL = *0*

0 drugs

Glasgow Coma Scale Score

GCSS = *dead at scene*

Units of Blood Given

Units = _____

Arterial Blood Gases

pH = _____

PO₂ = _____

PCO₂ = _____

HCO₃ = _____

Head at scene

Indicate the Location, Specific Anatomic Structure, Detail (size, depth, fracture type, head injury clinical signs and neurological deficits), and Source of all injuries indicated by official sources (or from PAR or other unofficial sources if medical records and interviewee data are unavailable.)

ALL INJURIES ARE FROM AUTOPSY

(R) FRONTAL BONE FX

FXs OF BOTH ORBITAL PLATES (BASE)

MULTIPLE FXs OF MANDIBLE WHICH HAVE DISLODGED SOME TEETH

FXs OF BOTH MIDDLE CRANIAL FOSSAE (BASE)

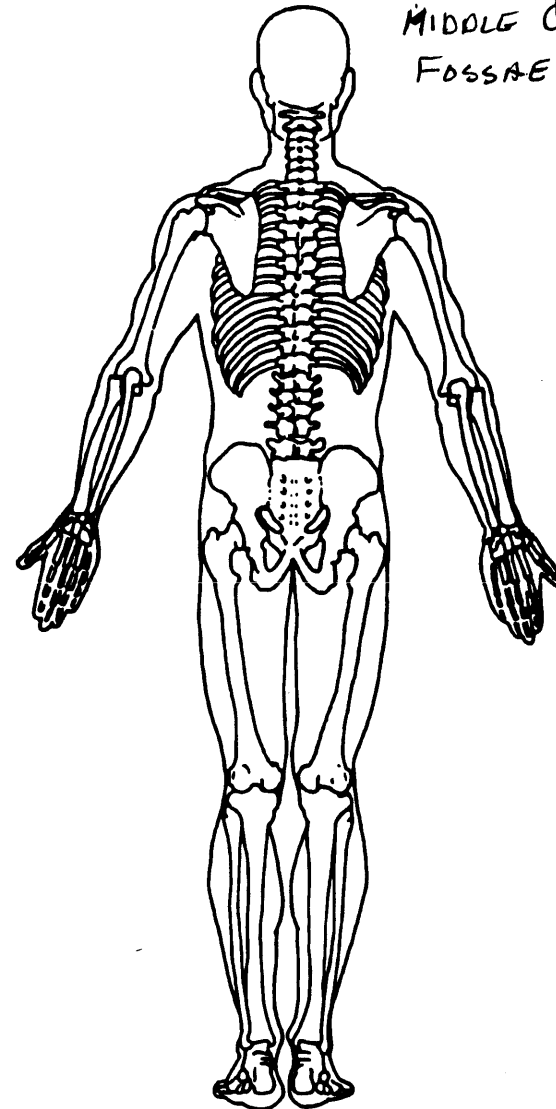
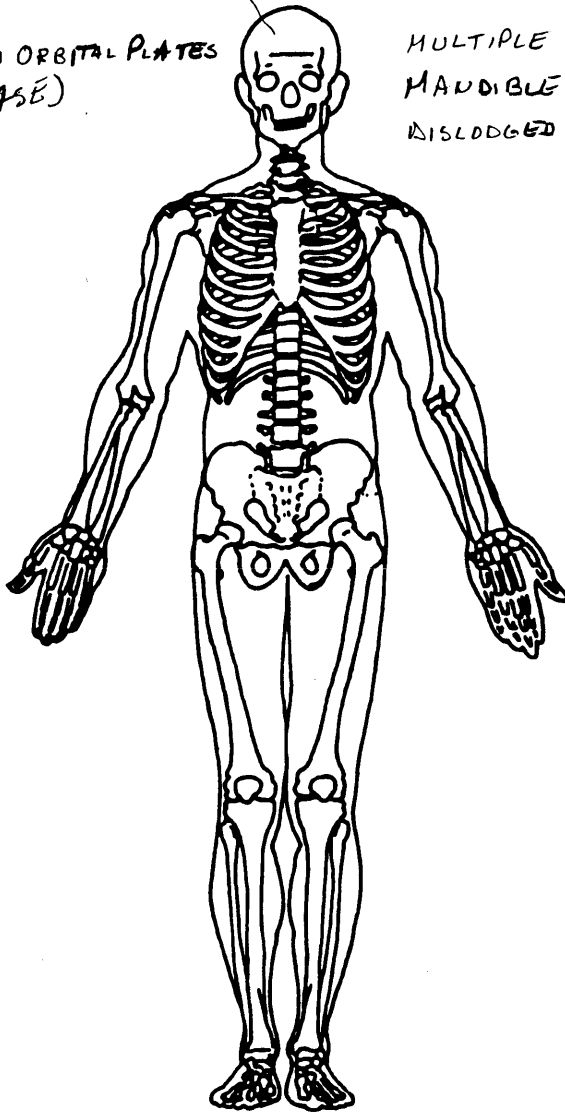

OFFICIAL INJURY DATA — INTERNAL INJURIES

Indicate the Location, Specific Anatomic Structure, Detail (size, depth, fracture type, head injury clinical signs and neurological deficits), and Source of all injuries indicated by official sources (or from PAR or other unofficial sources if medical records and interviewee data are unavailable.)

ALL INJURIES FROM AUTOPSY

BLOOD IS IN THE
SUBARACHNOID SPACE
INCLUDING THE
VENTRICULAR SYSTEM

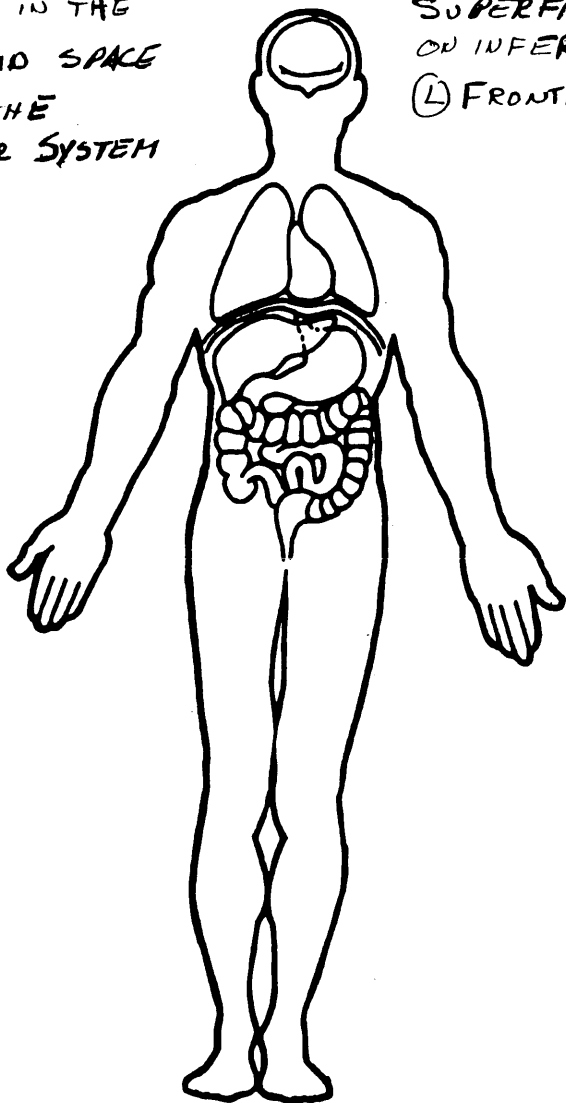

SUPERFICIAL LACERATIONS
ON INFERIOR PORTION OF
① FRONTAL LOBE

BRAIN APPEARS
DIFFUSELY
SWOLLEN —
BLOOD IS PRESENT
IN ALL MENINGEAL
COMPARTMENTS

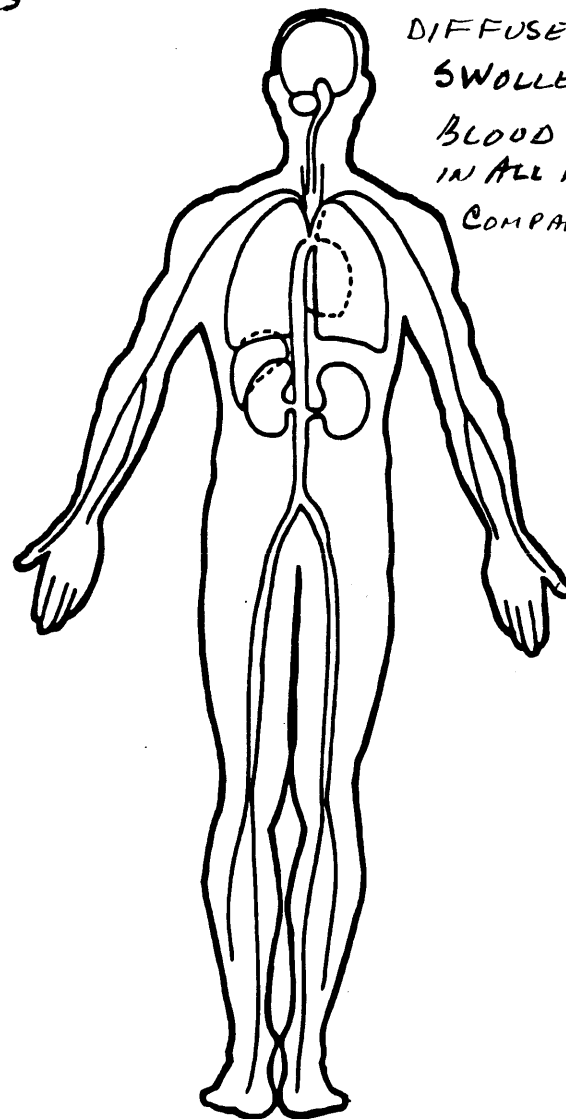

OCCUPANT RELATED

16. Driver Presence in Vehicle _____
 (0) Driver not present
 (1) Driver present
 (9) Unknown

17. Number of Occupants This Vehicle _____
 (00-96) Code actual number of occupants for this vehicle
 (97) 97 or more
 (99) Unknown

18. Number of Occupant Forms Submitted _____

24. Rollover _____
 (0) No rollover (no overturning)

Rollover (primarily about the longitudinal axis)
 (1) Rollover, 1 quarter turn only
 (2) Rollover, 2 quarter turns
 (3) Rollover, 3 quarter turns
 (4) Rollover, 4 or more quarter turns (specify): _____

(5) Rollover--end-over-end (i.e., primarily about the lateral axis)
 (9) Rollover (overturn), details unknown

VEHICLE WEIGHT ITEMS

19. Vehicle Curb Weight _____ 0
 Code weight to nearest 10 kilograms.
 (045) Less than 450 kilograms
 (610) 6,100 kilograms or more
 (999) Unknown

_____ lbs X .4536 = _____ kgs

Source: _____

20. Vehicle Cargo Weight _____ 0
 Code weight to nearest 10 kilograms.
 (000) Less than 5 kilograms
 (450) 4,500 kilograms or more
 (999) Unknown

_____ lbs X .4536 = _____ kgs

OVERRIDE/UNDERRIDE (THIS VEHICLE)

25. Front Override/Underride (this Vehicle) _____

26. Rear Override/Underride (this Vehicle) _____

(0) No override/underride, or not an end-to-end impact

Override (see specific CDC)
 (1) 1st CDC
 (2) 2nd CDC
 (3) Other not automated CDC (specify): _____

Underride (see specific CDC)
 (4) 1st CDC
 (5) 2nd CDC
 (6) Other not automated CDC (specify): _____

(7) Medium/heavy truck or bus override
 (9) Unknown

RECONSTRUCTION DATA

21. Towed Trailing Unit _____
 (0) No towed unit
 (1) Yes--towed trailing unit
 (9) Unknown

22. Documentation of Trajectory Data for This Vehicle _____
 (0) No
 (1) Yes

23. Post Collision Condition of Tree or Pole (For Highest Delta V) _____
 (0) Not collision (for highest delta V) with tree or pole
 (1) Not damaged
 (2) Cracked/sheared
 (3) Tilted < 45 degrees
 (4) Tilted ≥ 45 degrees
 (5) Uprooted tree
 (6) Separated pole from base
 (7) Pole replaced
 (8) Other (specify): _____
 (9) Unknown

HEADING ANGLE AT IMPACT FOR HIGHEST DELTA V

Values: (000)-(359) Code actual value
 (997) Noncollision
 (998) Impact with object
 (999) Unknown

27. Heading Angle For This Vehicle _____

28. Heading Angle For Other Vehicle _____

Category	Configuration	ACCIDENT TYPES (Includes Intent)									
I Single Driver	A Right Roadside Departure	01 DRIVE OFF ROAD	02 CONTROL/ TRACTION LOSS	03 AVOID COLLISION WITH VEH., PED., ANIM.	04 SPECIFICS OTHER	05 SPECIFICS UNKNOWN					
	B Left Roadside Departure	06 DRIVE OFF ROAD	07 CONTROL/ TRACTION LOSS	08 AVOID COLLISION WITH VEH., PED., ANIM.	09 SPECIFICS OTHER	10 SPECIFICS UNKNOWN					
	C Forward Impact	11 PARKED VEH.	12 STA. OBJECT	13 PEDESTRIAN/ ANIMAL	14 END DEPARTURE	15 SPECIFICS OTHER	16 SPECIFICS UNKNOWN				
II Same Trafficway Same Direction	D Rear-End	20 STOPPED 21, 22, 23	21, 22, 23	24 SLOWER 25, 26, 27	25, 26, 27	28 DECEL. 29, 30, 31	29, 30, 31	(EACH - 32) SPECIFICS OTHER	(EACH - 33) SPECIFICS UNKNOWN		
	E Forward Impact	34 CONTROL/ TRACTION LOSS	35 CONTROL/ TRACTION LOSS	36 CONTROL/ TRACTION LOSS	37 CONTROL/ TRACTION LOSS	38 AVOID COLLISION WITH VEH.	39 AVOID COLLISION WITH OBJECT	40 AVOID COLLISION WITH OBJECT	41 AVOID COLLISION WITH OBJECT	(EACH - 42) SPECIFICS OTHER	(EACH - 43) SPECIFICS UNKNOWN
	F Sideswipe Angle	44	45	46	47	48	49	(EACH - 48) SPECIFICS OTHER	(EACH - 49) SPECIFICS UNKNOWN		
III Same Trafficway Opposite Direction	G Head-On	50 LATERAL MOVE	51 LATERAL MOVE	(EACH - 52) SPECIFICS OTHER	(EACH - 53) SPECIFICS UNKNOWN						
	H Forward Impact	54 CONTROL/ TRACTION LOSS	55 CONTROL/ TRACTION LOSS	56 CONTROL/ TRACTION LOSS	57 CONTROL/ TRACTION LOSS	58 AVOID COLLISION WITH VEH.	59 AVOID COLLISION WITH OBJECT	60 AVOID COLLISION WITH OBJECT	61 AVOID COLLISION WITH OBJECT	(EACH - 62) SPECIFICS OTHER	(EACH - 63) SPECIFICS UNKNOWN
	I Sideswipe Angle	64 LATERAL MOVE	65 LATERAL MOVE	(EACH - 66) SPECIFICS OTHER	(EACH - 67) SPECIFICS UNKNOWN						
IV Change Trafficway Vehicle Turning	J Turn Across Path	68 INITIAL OPPOSITE DIRECTIONS	69 INITIAL OPPOSITE DIRECTIONS	70 INITIAL SAME DIRECTIONS	71 INITIAL SAME DIRECTIONS	72 INITIAL SAME DIRECTIONS	73 INITIAL SAME DIRECTIONS	(EACH - 74) SPECIFICS OTHER	(EACH - 75) SPECIFICS UNKNOWN		
	K Turn Into Path	76 TURN INTO SAME DIRECTION	77 TURN INTO SAME DIRECTION	78 TURN INTO SAME DIRECTION	79 TURN INTO SAME DIRECTION	80 TURN INTO OPPOSITE DIRECTIONS	81 TURN INTO OPPOSITE DIRECTIONS	82 TURN INTO OPPOSITE DIRECTIONS	(EACH - 84) SPECIFICS OTHER	(EACH - 85) SPECIFICS UNKNOWN	
V Intersecting Paths (Vehicle Damage)	L Straight Paths	87	88	89	90	(EACH - 90) SPECIFICS OTHER	(EACH - 91) SPECIFICS UNKNOWN				
VI Miscellaneous	M Backing Etc.	92 BACKING VEH.	93 OTHER VEH. OR OBJECT	96 Other Accident Type	98 Unknown Accident Type	00 No Impact					

OTHER DATA

56. Driver's Zip Code _____

- (00000) Driver not present
 (00001) Driver not a resident of U.S. or territories
 _____ Code actual 5-digit zip code
 (99999) Unknown

57. Driver's Race/Ethnic Origin 9

- (0) Driver not present
 (1) White (non-Hispanic)
 (2) Black (non-Hispanic)
 (3) White (Hispanic)
 (4) Black (Hispanic)
 (5) American Indian, Eskimo or Aleut
 (6) Asian or Pacific Islander
 (8) Other (specify): _____
 (9) Unknown

58. Vehicle Special Use (This Trip) 0

- (0) No special use
 (1) Taxi
 (2) Vehicle used as school bus
 (3) Vehicle used as other bus
 (4) Military
 (5) Police
 (6) Ambulance
 (7) Fire truck or car
 (8) Other (specify): _____
 (9) Unknown

61. Rollover Initiation Object Contacted _____

62. Location on Vehicle Where Initial Principal Tripping Force Is Applied _____

- (0) No rollover
 (1) Wheels/tires
 (2) Side plane
 (3) End plane
 (4) Undercarriage
 (5) Other location on vehicle (specify): _____
 (8) Non-contact rollover forces (specify): _____
 (9) Unknown

63. Direction of Initial Roll _____

- (0) No rollover
 (1) Roll right - primarily about the longitudinal axis
 (2) Roll left - primarily about the longitudinal axis
 (5) End-over-end (i.e., primarily about the lateral axis)
 (9) Unknown roll direction

ROLLOVER DATA

If GV07 (Body Type) \neq 1-49, leave GV59-GV63 blank.
 If GV24 (Rollover) = 0, then GV59-GV63 must equal 0.
 If GV24 = 9, then GV59-GV63 must equal 9.

59. Rollover Initiation Type _____

- (0) No rollover
 (1) Trip-over
 (2) Flip-over
 (3) Turn-over
 (4) Climb-over
 (5) Fall-over
 (6) Bounce-over
 (7) Collision with another vehicle
 (8) Other rollover initiation type specify): _____
 (9) Unknown rollover initiation type

60. Location of Rollover Initiation _____

- (0) No rollover
 (1) On roadway
 (2) On shoulder—paved
 (3) On shoulder—unpaved
 (4) On roadside or divided trafficway median
 (9) Unknown

PRECRASH DATA64. Pre-Event Movement (Prior to Recognition of Critical Event) 02

- (01) Going straight
 (02) Slowing or stopping in traffic lane
 (03) Starting in traffic lane
 (04) Stopped in traffic lane
 (05) Passing or overtaking another vehicle
 (06) Disabled or parked in travel lane
 (07) Leaving a parking position
 (08) Entering a parking position
 (09) Turning right
 (10) Turning left
 (11) Making a U-turn
 (12) Backing up (other than for parking position)
 (13) Negotiating a curve
 (14) Changing lanes
 (15) Merging
 (16) Successful avoidance maneuver to a previous critical event
 (97) Other (specify): _____
 (98) No driver present
 (99) Unknown

CODES FOR ROLLOVER INITIATION OBJECT CONTACTED

(00) No rollover
 (01-30) — Vehicle Number

Noncollision

(31) Turn-over — fall-over
 (33) Jackknife

Collision With Fixed Object

(41) Tree (\leq 10 cm in diameter)
 (42) Tree ($>$ 10 cm in diameter)
 (43) Shrubbery or bush
 (44) Embankment

(45) Breakaway pole or post (any diameter)

Nonbreakaway Pole or Post

(50) Pole or post (\leq 10 cm in diameter)
 (51) Pole or post ($>$ 10 cm but \leq 30 cm in diameter)
 (52) Pole or post ($>$ 30 cm in diameter)
 (53) Pole or post (diameter unknown)

(54) Concrete traffic barrier
 (55) Impact attenuator
 (56) Other traffic barrier (includes guardrail)
 (specify): _____

(57) Fence
 (58) Wall
 (59) Building
 (60) Ditch or culvert
 (61) Ground
 (62) Fire hydrant
 (63) Curb
 (64) Bridge
 (68) Other fixed object (specify):

(69) _____
 Unknown fixed object

Collision with Nonfixed Object

(71) Motor vehicle not in-transport
 (76) Animal
 (77) Train
 (78) Trailer, disconnected in transport
 (79) Object fell from vehicle in-transport
 (88) Other nonfixed object (specify):

(89) _____
 Unknown nonfixed object

(98) Other event (specify):

(99) _____
 Unknown event or object

PSU NUMBER	<u>41</u>
CASE NUMBER	<u>199A</u>
VEHICLE NUMBER	<u>02</u>

EXTERIOR VEHICLE FORM

THE FOLLOWING DATA IS NOT INCLUDED IN THIS CASE:

ENTIRE FORM

PAGE NUMBER (S) _____

PSU NUMBER

41

CASE NUMBER

199A

VEHICLE NUMBER

02

INTERIOR VEHICLE FORM

THE FOLLOWING DATA IS NOT INCLUDED IN THIS CASE:

ENTIRE FORM

PAGE NUMBER (S) _____

PSU NUMBER	<u>41</u>
CASE NUMBER	<u>199A</u>
VEHICLE NUMBER	<u>02</u>
OCCUPANT NUMBER	<u>01</u>

OCCUPANT ASSESSMENT FORM

THE FOLLOWING DATA IS NOT INCLUDED IN THIS CASE:

- ENTIRE FORM
- PAGE NUMBER (S) _____

PSU NUMBER	<u>41</u>
CASE NUMBER	<u>199A</u>
VEHICLE NUMBER	<u>02</u>
OCCUPANT NUMBER	<u>01</u>

OCCUPANT INJURY FORM

THE FOLLOWING DATA IS NOT INCLUDED IN THIS CASE:

ENTIRE FORM

PAGE NUMBER (S) _____

FORM NAME	NUMBER OF DOLLAR SIGNS	NUMBER OF LEVEL 1 ERRORS	NUMBER OF LEVEL 2 ERRORS	VERSION NUMBER CONSISTENT
Accident	0	0	0	N
General Vehicle	0	0	0	N
Vehicle Exterior	0	0	0	N
Vehicle Interior	0	0	0	N
Occupant Assesment	0	0	0	N
Occupant Interior	0	0	0	N
Total Inter Errors		0	0	
Total Case Errors	0	0	0	

PSU41
CASE 199A
CURRENT VERSION: 7.03

ERROR SUMMARY SCREEN

██████████ 95

FORM NAME	NUMBER OF DOLLAR SIGNS	NUMBER OF LEVEL 1 ERRORS	NUMBER OF LEVEL 2 ERRORS	VERSION NUMBER CONSISTENT
Accident	0	0	0	Y
General Vehicle	0	0	0	Y
Vehicle Exterior	0	0	0	Y
Vehicle Interior	0	0	0	Y
Occupant Assesment	0	0	0	Y
Occupant Interior	0	0	0	Y
Total Inter Errors		0	0	
Total Case Errors	0	0	0	



SLIDE INDEX

Primary Sampling Unit Number 4 1

Case Number—Stratum 1 9 9 A

Slide No.	Vehicle No.	Direction of Picture	Description of Slide Subject Matter
1-5	1 & 2	North	Approach V-1 and V-2
6-18	1		Exterior V-1
19	1		Close up pry marks left front door
20-29	1		Exterior V-1
30-58	1		Interior V-1



PSU 41-199A (1994) #1



PSU 41-199A (1994) #2



PSU 41-199A (1994) #3



PSU 41-199A (1994) #4



PSU 41-199A (1994) #5



PSU 41-199A (1994) #6



PSU 41-199A (1994) #7



PSU 41-199A (1994) #8

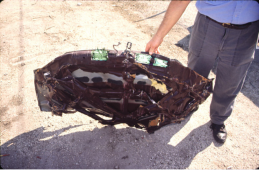

PSU 41-199A (1994) #9



PSU 41-199A (1994) #10



PSU 41-199A (1994) #11



PSU 41-199A (1994) #12



PSU 41-199A (1994) #13



FSU 41-199A (1994) #14



PSU 41-199A (1994) #15



PSU 41-199A (1994) #16



PSU 41-199A (1994) #17
Best Available



PSU 41-199A (1994) #18
Best Available



PSU 41-199A (1994) #19



PSU 41-199A (1994) #20



PSU 41-199A (1994) #21



FSU 41-199A (1994) #22



PSU 41-199A (1994) #23



PSU 41-199A (1994) #24



PSU 41-199A (1994) #25



PSU 41-199A (1994) #26



PSU 41-199A (1994) #27



PSU 41-199A (1994) #28
Best Available



PSU 41-199A (1994) #29



PSU 41-199A (1994) #30



PSU 41-199A (1994) #31



PSU 41-199A (1994) #32



PSU 41-199A (1994) #33



PSU 41-199A (1994) #34



PSU 41-199A (1994) #35



PSU 41-199A (1994) #36



PSU 41-199A (1994) #37



PSU 41-199A (1994) #38



PSU 41-199A (1994) #39



PSU 41-199A (1994) #40



PSU 41-199A (1994) #41



FSU 41-199A (1994) #42



PSU 41-199A (1994) #43

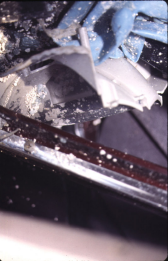

PSU 41-199A (1994) #44



**PSU 41-199A (1994) #45
Best Available**



PSU 41-199A (1994) #46



PSU 41-199A (1994) #47



PSU 41-199A (1994) #48



PSU 41-199A (1994) #49



PSU 41-199A (1994) #50



PSU 41-199A (1994) #61
Best Available



PSU 41-199A (1994) #52



PSU 41-199A (1994) #53



PSU 41-199A (1994) #54



PSU 41-199A (1994) #55



PSU 41-199A (1994) #56



PSU 41-199A (1994) #57



PSU 41-199A (1994) #58