



U.S. Department  
of Transportation

**National Highway  
Traffic Safety  
Administration**

400 Seventh Street, S.W.  
Washington, D.C. 20590

Dear Crash Data Researchers/Users:

Thank you for choosing crash data from the National Highway Traffic Safety Administration (NHTSA) for your research or other use. The information contained in this motor vehicle crash report is collected, maintained and distributed in accordance with Public Law 89-564. In accordance with this Public Law, NHTSA is required not to release any case information until completion of quality control procedures. These procedures include a review of the case material to extract all names, licenses and registration numbers, non-coded interview material, non-research related researcher comments in the margins, non-factual data, and the production number portion of the vehicle identification number (VIN).

If you requested NHTSA to query its database files in order to identify a specific crash, then that query was made using non-personal descriptors you provided for use in our search. This motor vehicle crash may have been identified from a data search and matches the general, non-personal descriptors you provided, but we cannot confirm that this is the specific crash report you requested.

If you have any questions with regard to the above procedures, please contact the Field Operations Branch, Crash Investigation Division, National Center for Statistics and Analysis at 202-366-4820. Again, please be advised that we cannot confirm that this is the case that you have specifically requested nor can we certify the information to be correct.

\*\*\* \*\*

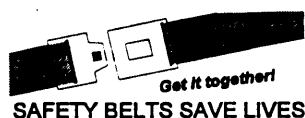

AUTO SAFETY HOTLINE  
(800) 424-9393  
Wash. D.C. Area 366-0123



# CASE SUMMARY

PSU 02 CASE NO. 140A TYPE OF ACCIDENT Minivan vs. Trees/Fire

## A. DESCRIPTION OF THE ACCIDENT SEQUENCE AND ACCIDENT PECULIARITIES

(Provide a summary of the accident sequence as well as any particular event of the accident that is noteworthy. Injury mechanism and vehicle crashworthiness is the focus, not driver culpability. Do not include any personal identifiers.)

SEE ATTACHED

## B. VEHICLE PROFILE(S)

Vehicle No.	Class of Vehicle	Year/Make/Model	Most Severe Damage Based on Vehicle Inspection		Component Failure
			Damage Plane	Severity Description	

DO NOT SANITIZE THIS FORM

### C. PERSON PROFILE(S)

Vehicle No.	Person Role	Seat Position	Restraint Use	Most Severe Injury (TO BE COMPLETED BY ZONE CENTER)			
				Body Region	Injury Type	AIS	Injury Source

**Body Region**

Abdomen  
 Ankle-foot  
 Arm (upper)  
 Back-thoracolumbar spine  
 Brain  
 Chest  
 Ears  
 Eye  
 Elbow  
 Face  
 Forearm  
 Head-skull  
 Heart  
 Kidneys  
 Knee  
 Leg (lower)  
 Liver  
 Lower limbs(s) (whole or unknown part)  
 Mouth  
 Neck-cervical spine  
 Nose

Pelvic-hip  
 Pulmonary-lungs  
 Shoulder  
 Spleen  
 Thigh  
 Thyroid, other endocrine gland  
 Upper limb(s) (whole or unknown part)  
 Vertebrae  
 Whole body  
 Wrist-hand

**Injury Type**

Abrasion  
 Amputation  
 Avulsion  
 Burn  
 Concussion  
 Contusion  
 Crush  
 Detachment, separation  
 Dislocation

Fracture  
 Fracture and dislocation  
 Laceration  
 Other  
 Perforation, puncture  
 Rupture  
 Sprain  
 Strain  
 Total severance, transection  
 Unknown

**Abbreviated Injury Scale**

- (1) Minor injury
- (2) Moderate injury
- (3) Serious injury
- (4) Severe injury
- (5) Critical injury
- (6) Maximum (untreatable)
- (7) Injured, unknown severity

**DO NOT SANITIZE THIS FORM**

PSU02

1995 Case Summary Form

CASE 140A

TYPE OF ACCIDENT: MINIVAN VS. TREES/FIRE

A. DESCRIPTION OF THE ACCIDENT SEQUENCE AND ACCIDENT PECULIARITIES

Vehicle #1 traveling west on two lane undivided roadway negotiating a curve to the left with a negative grade. Vehicle #1 drives off right side of roadway swiping 2 trees with right side and then striking a large tree with front of vehicle. Vehicle then catches fire and is destroyed. Vehicle #1 was towed due to damage. Operator was fatally injured.

PSU02

1995 Case Summary Form

CASE 140A

TYPE OF ACCIDENT: MINIVAN VS. TREES/FIRE

B. VEHICLE PROFILE(S)

V	e	h.	No	Class of Vehicle	Year/Make/ Model	Damage Plane	Severity Descr.	Component Failure
1		minivan		93 Chrysler Town and County	front	severe	<del>fire ?</del> unknown	

PSU02

1995 Case Summary Form

CASE 140A

TYPE OF ACCIDENT: MINIVAN VS. TREES/FIRE

C. PERSON PROFILE(S)

V e h. No	Person Role	Seat Positon	Restraint Use	Body Region	Injury Type	A	Injury Source
						I S	
1	driver	1/front	unknown	heart	laceration	6	steering wheel

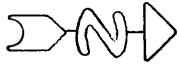

PSU 02 / CASE 140A

95 1:30 PM

89 KPH

CURVE LEFT / -5% GRADE

BIT / DRY

SCALE: 1/250

AP - Pol

AL

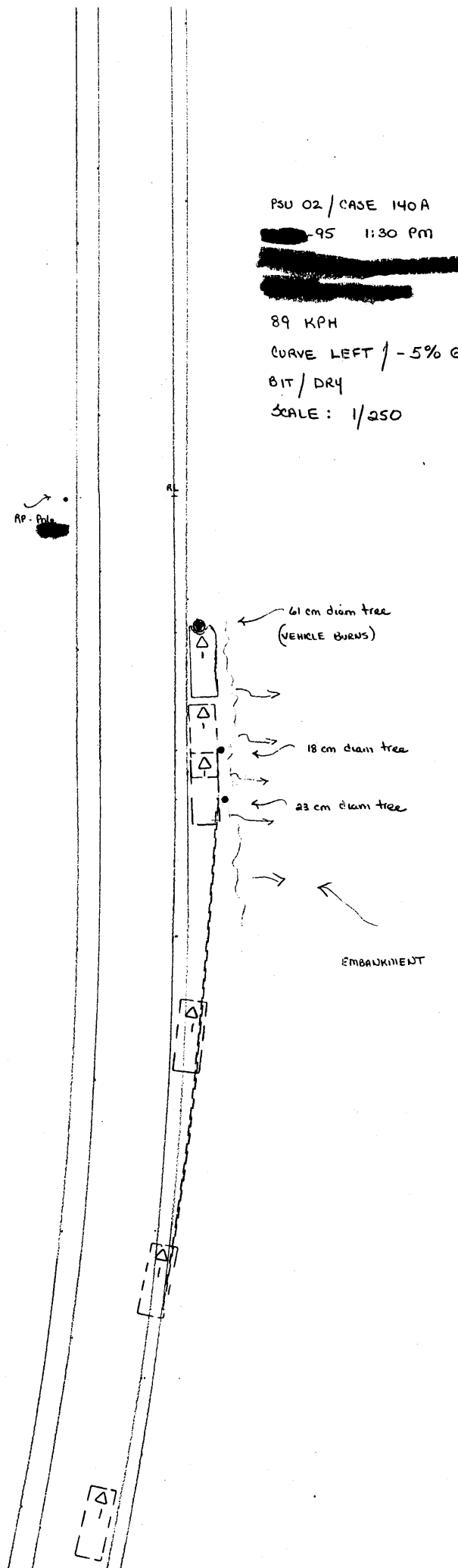

61 cm diam tree  
(VEHICLE BURNS)

18 cm diam tree

23 cm diam tree

EMBANKMENT



# ACCIDENT COLLISION MEASUREMENT TABLE

Primary Sampling Unit Number 02

Case Number—Stratum 140A

### ACCIDENT COLLISION DIAGRAM

Document the physical plant:

- \* all road/roadway delineation (e.g., curbs/edge lines, lane markings, median markings, pavement markings, parked vehicles, poles, signs, etc.)
- \* all traffic controls (e.g., speed limit)
- \* north arrow placed on diagram
- \* roadway surface type and condition of applicable roadways
- \* grade measurements for all applicable roadways and at location of rollover initiation
- \* roadway curvature

Document vehicle dynamics including:

- \* reference point and reference line relative to physical features present at the scene
- \* scaled documentation of all accident induced physical evidence
- \* scaled documentation of all roadside objects contacted
- \* scaled representations of the vehicle(s) at pre-impact, impact, and final rest based upon either:
  - a) physical evidence, or
  - b) reconstructed accident dynamics

CRASH DATA

	VEH. #1	VEH. #2	VEH. #3
Heading Angle	<u>270</u>	___	___
Surface Type	<u>BIT</u>	___	___
Surface Condition	<u>DRY</u>	___	___
Coefficient of Friction	<u>0.71</u>	___	___
Grade (v/h) Measurement (between impact and final rest)	<u>-2.5/48</u>	___	___
Grade (v/h) Measurement (at location of rollover initiation)	<u>NA</u>	___	___

Reference Point: POLE [REDACTED]

Reference line: North road edge

Item	Distance and Direction from Reference Point	Distance and Direction from Reference Line
24" diam tree	8.4E	1.5N
to	9.E	1.5N
7" diam tree	17.4E	2.9N
9" diam tree	20.7E	3.1N
poss track ends	20.7E	2.9N
" " @	30E	2.4N
" " @	40E	1.9N
" " @	50.E	1.2N
track leaves road	55.4E	0





# ACCIDENT FORM

## SPECIAL STUDIES - INDICATORS

1. Primary Sampling Unit Number 02  
2. Case Number - Stratum 140A

## IDENTIFICATION

3. Number of General Vehicle Forms Submitted 01  
4. Date of Accident (Month, Day, Year)      /      / 9 5  
5. Time of Accident 1330

Code reported military time of accident.

NOTE: Midnight = 2400  
Unknown = 9999

Check (✓) each special study (SS15-SS18 below) that has been completed; code 1 for the checked special studies and 0 for the special studies not checked.

- 6.  SS15 Administrative Use 0
- 7.  SS16 Pedestrian Crash Data Study 0  
*(Data for this special study available in a separate file.)*
- 8.  SS17 Impact Fires 1
- 9.  SS18 Unsafe Driver Actions 0
- 10.  SS19 \_\_\_\_\_ 0

## NUMBER OF EVENTS

11. Number of Recorded Events in This Accident 04

Code the number of events which occurred in this accident.

## ACCIDENT EVENTS

For each event that occurred in the accident, code the lowest numbered vehicle in the left columns and the other involved vehicle or object in the right columns.

Accident Event Sequence Number	Vehicle Number	Class Of Vehicle	General Area of Damage	Vehicle Number or Object Contacted	Class Of Vehicle	General Area of Damage
12. <u>0 1</u>	13. <u>01</u>	14. <u>20</u>	15. <u>R</u>	16. <u>42</u>	17. <u>00</u>	18. <u>0</u>
19. <u>0 2</u>	20. <u>01</u>	21. <u>20</u>	22. <u>R</u>	23. <u>42</u>	24. <u>00</u>	25. <u>0</u>
26. <u>0 3</u>	27. <u>01</u>	28. <u>20</u>	29. <u>F</u>	30. <u>42</u>	31. <u>00</u>	32. <u>0</u>
33. <u>0 4</u>	34. <u>01</u>	35. <u>20</u>	36. <u>N</u>	37. <u>33</u>	38. <u>00</u>	39. <u>N</u>
40. <u>0 5</u>	41. _____	42. _____	43. _____	44. _____	45. _____	46. _____

IF GREATER THAN FIVE EVENTS, CONTINUE CODING ON THE ACCIDENT EVENT SUPPLEMENT

### CODES FOR CLASS OF VEHICLE

- |  |  |
|--|--|
| <ul style="list-style-type: none"> <li>(00) Not a motor vehicle</li> <li>(01) Subcompact/mini (wheelbase &lt; 254 cm)</li> <li>(02) Compact (wheelbase ≥ 254 but &lt; 265 cm)</li> <li>(03) Intermediate (wheelbase ≥ 265 but &lt; 278 cm)</li> <li>(04) Full size (wheelbase ≥ 278 but &lt; 291 cm)</li> <li>(05) Largest (wheelbase ≥ 291 cm)</li> <li>(09) Unknown passenger car size</li> <li>(14) Compact utility vehicle</li> <li>(15) Large utility vehicle (≤ 4,500 kgs GVWR)</li> <li>(16) Utility station wagon (≤ 4,500 kgs GVWR)</li> <li>(19) Unknown utility type</li> <li>(20) Minivan (≤ 4,500 kgs GVWR)</li> <li>(21) Large van (≤ 4,500 kgs GVWR)</li> <li>(24) Van Based school bus (≤ 4,500 kgs GVWR)</li> <li>(28) Other van type (≤ 4,500 kgs GVWR)</li> <li>(29) Unknown van type (≤ 4,500 kgs GVWR)</li> <li>(30) Compact pickup truck (≤ 4,500 kgs GVWR)</li> </ul> | <ul style="list-style-type: none"> <li>(31) Large pickup truck (≤ 4,500 kgs GVWR)</li> <li>(38) Other pickup truck (≤ 4,500 kgs GVWR)</li> <li>(39) Unknown pickup truck type (≤ 4,500 kgs GVWR)</li> <li>(45) Other light truck (≤ 4,500 kgs GVWR)</li> <li>(48) Unknown light truck type (≤ 4,500 kgs GVWR)</li> <li>(49) Unknown light vehicle type</li> <li>(50) School bus (excludes van based)(&gt; 4,500 kgs GVWR)</li> <li>(58) Other bus (&gt; 4,500 kgs GVWR)</li> <li>(59) Unknown bus type</li> <li>(60) Truck (&gt; 4,500 kgs GVWR)</li> <li>(67) Tractor without trailer</li> <li>(68) Tractor-trailer(s)</li> <li>(78) Unknown medium/heavy truck type</li> <li>(79) Unknown light/medium/heavy truck type</li> <li>(80) Motored cycle</li> <li>(90) Other vehicle</li> <li>(99) Unknown</li> </ul> |
|--|--|

### CODES FOR GENERAL AREA OF DAMAGE (GAD)

- |   |  |   |   |
|---|--|---|---|
| CDS APPLICABLE<br>AND OTHER<br>VEHICLES | <ul style="list-style-type: none"> <li>(O) Not a motor vehicle</li> <li>(N) Noncollision</li> <li>(F) Front</li> </ul> | <ul style="list-style-type: none"> <li>(R) Right side</li> <li>(L) Left side</li> <li>(B) Back</li> </ul> | <ul style="list-style-type: none"> <li>(T) Top</li> <li>(U) Undercarriage</li> <li>(9) Unknown</li> </ul> |
|---|--|---|---|

- |                               |  |   |   |
|-------------------------------|--|---|---|
| TDC<br>APPLICABLE<br>VEHICLES | <ul style="list-style-type: none"> <li>(O) Not a motor vehicle</li> <li>(N) Noncollision</li> <li>(F) Front</li> <li>(R) Right side</li> </ul> | <ul style="list-style-type: none"> <li>(L) Left side</li> <li>(B) Back of unit with cargo area<br/>(rear of trailer or straight truck)</li> <li>(D) Back (rear of tractor)</li> </ul> | <ul style="list-style-type: none"> <li>(C) Rear of cab</li> <li>(V) Front of cargo area</li> <li>(T) Top</li> <li>(U) Undercarriage</li> <li>(9) Unknown</li> </ul> |
|-------------------------------|--|---|---|

### CODES FOR VEHICLE NUMBER OR OBJECT CONTACTED

- |   |  |
|---|--|
| <p>(01-30) — Vehicle Number</p> <p>Noncollision</p> <ul style="list-style-type: none"> <li>(31) Overturn — rollover (excludes end-over-end)</li> <li>(32) Rollover — end-over-end</li> <li>(33) Fire or explosion</li> <li>(34) Jackknife</li> <li>(35) Other intraunit damage (specify): _____</li> <li>(36) Noncollision injury</li> <li>(38) Other noncollision (specify): _____</li> <li>(39) Noncollision — details unknown</li> </ul> <p>Collision With Fixed Object</p> <ul style="list-style-type: none"> <li>(41) Tree (≤ 10 cm in diameter)</li> <li>(42) Tree (&gt; 10 cm in diameter)</li> <li>(43) Shrubbery or bush</li> <li>(44) Embankment</li> <li>(45) Breakaway pole or post (any diameter)</li> </ul> <p>Nonbreakaway Pole or Post</p> <ul style="list-style-type: none"> <li>(50) Pole or post (≤ 10 cm in diameter)</li> <li>(51) Pole or post (&gt; 10 cm but ≤ 30 cm in diameter)</li> <li>(52) Pole or post (&gt; 30 cm in diameter)</li> <li>(53) Pole or post (diameter unknown)</li> <li>(54) Concrete traffic barrier</li> <li>(55) Impact attenuator</li> <li>(56) Other traffic barrier (includes guardrail)<br/>(specify): _____</li> </ul> | <ul style="list-style-type: none"> <li>(57) Fence</li> <li>(58) Wall</li> <li>(59) Building</li> <li>(60) Ditch or culvert</li> <li>(61) Ground</li> <li>(62) Fire hydrant</li> <li>(63) Curb</li> <li>(64) Bridge</li> <li>(68) Other fixed object (specify): _____</li> <li>(69) Unknown fixed object</li> </ul> <p>Collision with Nonfixed Object</p> <ul style="list-style-type: none"> <li>(70) Passenger car, light truck, van, or other vehicle not in-transport</li> <li>(71) Medium/heavy truck or bus not in-transport</li> <li>(72) Pedestrian</li> <li>(73) Cyclist or cycle</li> <li>(74) Other nonmotorist or conveyance</li> <li>(75) Vehicle occupant</li> <li>(76) Animal</li> <li>(77) Train</li> <li>(78) Trailer, disconnected in transport</li> <li>(79) Object fell from vehicle in-transport</li> <li>(88) Other nonfixed object (specify): _____</li> <li>(89) Unknown nonfixed object</li> <li>(98) Other event (specify): _____</li> <li>(99) Unknown event or object</li> </ul> |
|---|--|

**PRECRASH ENVIRONMENTAL DATA**

19. Relation To Interchange Or Junction 0  
 (0) Non-interchange area and non-junction  
 (1) Interchange area related

*Non-Interchange junctions*

- (2) Intersection related  
 (3) Driveway, alley access related  
 (4) Other junction (specify) \_\_\_\_\_

(5) Unknown type of junction

(9) Unknown

20. Trafficway Flow 0  
 (0) Not physically divided (two way traffic)  
 (1) Divided trafficway-median strip without positive barrier  
 (2) Divided trafficway-median strip with positive barrier  
 (3) One way traffic  
 (9) Unknown

21. Number Of Travel Lanes 2  
 (1) One  
 (2) Two  
 (3) Three  
 (4) Four  
 (5) Five  
 (6) Six  
 (7) Seven or more  
 (9) Unknown

22. Roadway Alignment 3  
 (1) Straight  
 (2) Curve right  
 (3) Curve left  
 (9) Unknown

23. Roadway Profile 4  
 (1) Level  
 (2) Uphill grade (> 2%)  
 (3) Hill crest  
 (4) Downhill grade (> 2%)  
 (5) Sag  
 (9) Unknown

24. Roadway Surface Type 2  
 (1) Concrete  
 (2) Bituminous (asphalt)  
 (3) Brick or block  
 (4) Slag, gravel, or stone  
 (5) Dirt  
 (8) Other (specify): \_\_\_\_\_  
 (9) Unknown

25. Roadway Surface Condition 1  
 (1) Dry  
 (2) Wet  
 (3) Snow or slush  
 (4) Ice  
 (5) Sand, dirt, or oil  
 (8) Other (specify): \_\_\_\_\_  
 (9) Unknown

26. Light Conditions 1  
 (1) Daylight  
 (2) Dark  
 (3) Dark, but lighted  
 (4) Dawn  
 (5) Dusk  
 (9) Unknown

27. Atmospheric Conditions 0  
 (0) No adverse atmospheric-related driving conditions  
 (1) Rain  
 (2) Sleet/hail  
 (3) Snow  
 (4) Fog  
 (5) Rain and fog  
 (6) Sleet and fog  
 (7) Other (e.g., smog, smoke, blowing sand or dust, etc.) (specify): \_\_\_\_\_  
 (9) Unknown

28. Traffic Control Device 0  
 (0) No traffic control(s)  
 (1) Traffic control signal (not RR crossing)  
  
*Regulatory*  
 (2) Stop sign  
 (3) Yield sign  
 (4) School zone sign  
 (5) Other regulatory sign (specify): \_\_\_\_\_  
 (6) Warning sign (not RR crossing).  
 (7) Unknown sign  
 (8) Miscellaneous/other controls including RR controls (specify): \_\_\_\_\_  
 (9) Unknown

29. Traffic Control Device Functioning 0  
 (0) No traffic control device  
 (1) Traffic control device not functioning (specify): \_\_\_\_\_  
 (2) Traffic control device functioning properly  
 (9) Unknown

**OCCUPANT RELATED**

- 37. Driver Presence in Vehicle 1  
(0) Driver not present  
(1) Driver present  
(9) Unknown
- 38. Number of Occupants This Vehicle 01  
(00-96) Code actual number of occupants for this vehicle  
(97) 97 or more  
(99) Unknown
- 39. Number of Occupant Forms Submitted 01

**AIR BAG RELATED**

- 40. Is this an AOPS Vehicle? 1  
(0) No (includes unknown)  
(1) Yes - researcher determined  
(2) VIN determined air bag system  
(3) VIN determined automatic (passive) belts  
(4) VIN determined air bag and automatic (passive) belts
- 41. Air Bag(s) Deployment, First Seat Frontal 3  
(0) Not equipped or not available  
(1) No air bags deployed  
*Single Air Bag Vehicle*  
(2) Driver air bag deployed  
(3) Driver air bag, unknown if deployed  
*Multiple Air Bag Vehicle*  
(4) Driver side only deployed  
(5) Passenger side only deployed  
(6) Driver and passenger side deployed  
(7) Driver and passenger side unknown if deployed  
(8) Air bag(s) deployed, details unknown  
(9) Unknown
- 42. Air Bag(s) Deployment, Other Than First Seat Frontal 0  
(0) Not equipped with an "other" air bag  
(1) Deployed during accident (as a result of impact)  
(2) Deployed inadvertently just prior to accident  
(3) Deployed, details unknown  
(4) Deployed as a result of a noncollision event during accident sequence (e.g., fire, explosion, electrical)  
(5) Unknown if deployed  
(7) Nondeployed  
(9) Unknown

Specify type of "other" air bag present: \_\_\_\_\_

**VEHICLE WEIGHT ITEMS**

Vehicle Curb Weight 1,860  
Code weight to nearest 10 kilograms. 191  
(045) Less than 450 kilograms  
(610) 6,100 kilograms or more 1906  
(999) Unknown  
4,103 lbs X .4536 = 1,861 kgs

Source: 42035 [redacted]

(for 93 year)

- 44. Vehicle Cargo Weight 0,020  
Code weight to nearest 10 kilograms.  
(000) Less than 5 kilograms  
(450) 4,500 kilograms or more *tow hitch + camera + clothes*  
(999) Unknown  
33 lbs X .4536 = 15 kgs  
Source: inspection / interview

**ROLLOVER DATA**

- 45. Rollover 00  
(00) No rollover (no overturning)  
*Rollover (primarily about the longitudinal axis)*  
(01-16) Code the number of quarter turns  
(17) Rollover, 17 or more quarter turns (specify): \_\_\_\_\_  
(98) Rollover--end-over-end (i.e., primarily about the lateral axis)  
(99) Rollover (overturn), details unknown
- 46. Rollover Initiation Type 00  
(00) No rollover  
(01) Trip-over  
(02) Flip-over  
(03) Turn-over  
(04) Climb-over  
(05) Fall-over  
(06) Bounce-over  
(07) Collision with another vehicle  
(08) Other rollover initiation type specify): \_\_\_\_\_  
(98) Rollover--end-over-end  
(99) Unknown rollover initiation type
- 47. Location of Rollover Initiation 0  
(0) No rollover  
(1) On roadway  
(2) On shoulder—paved  
(3) On shoulder—unpaved  
(4) On roadside or divided trafficway median  
(8) Rollover--end-over-end  
(9) Unknown
- 48. Rollover Initiation Object Contacted 00  
(Note: Applicable codes on back of page)
- 49. Location on Vehicle Where Initial Principal Tripping Force Is Applied 0  
(0) No rollover  
(1) Wheels/tires  
(2) Side plane  
(3) End plane  
(4) Undercarriage  
(5) Other location on vehicle (specify): \_\_\_\_\_  
(6) Non-contact rollover forces (specify): \_\_\_\_\_  
(8) Rollover--end-over-end  
(9) Unknown

- 50. Direction of Initial Roll 0  
(0) No rollover  
(1) Roll right - primarily about the longitudinal axis  
(2) Roll left - primarily about the longitudinal axis  
(8) Rollover--end-over-end  
(9) Unknown roll direction

2/18/03  
100  
4203

NASS CODING MANUAL  
1st Edition, 1997

## CODES FOR ROLLOVER INITIATION OBJECT CONTACTED

- (00) No rollover
- (01-30) — Vehicle Number

### Noncollision

- (31) Turn-over — fall-over
- (32) No rollover impact initiation (end-over-end)
- (34) Jackknife

### Collision With Fixed Object

- (41) Tree ( $\leq 10$  cm in diameter)
- (42) Tree ( $> 10$  cm in diameter)
- (43) Shrubbery or bush
- (44) Embankment

- (45) Breakaway pole or post (any diameter)

### Nonbreakaway Pole or Post

- (50) Pole or post ( $\leq 10$  cm in diameter)
- (51) Pole or post ( $> 10$  cm but  $\leq 30$  cm in diameter)
- (52) Pole or post ( $> 30$  cm in diameter)
- (53) Pole or post (diameter unknown)

- (54) Concrete traffic barrier
- (55) Impact attenuator
- (56) Other traffic barrier (includes guardrail)  
(specify): \_\_\_\_\_

- (57) Fence
- (58) Wall
- (59) Building
- (60) Ditch or culvert
- (61) Ground
- (62) Fire hydrant
- (63) Curb
- (64) Bridge
- (68) Other fixed object (specify): \_\_\_\_\_

- (69) Unknown fixed object

### Collision with Nonfixed Object

- (70) Passenger car, light truck, van, or other vehicle not in-transport
- (71) Medium/heavy truck or bus not in-transport
- (76) Animal
- (77) Train
- (78) Trailer, disconnected in transport
- (79) Object fell from vehicle in-transport
- (88) Other nonfixed object (specify): \_\_\_\_\_

- (89) Unknown nonfixed object

- (98) Other event (specify): \_\_\_\_\_

- (99) Unknown event or object



# EXTERIOR VEHICLE FORM

1. Primary Sampling Unit Number <u>02</u>	3. Vehicle Number <u>01</u>
2. Case Number - Stratum <u>140A</u>	

## VEHICLE IDENTIFICATION

unable to get from vehicle - Police saw data for me

VIN 1C4BK54R3PX [REDACTED] Model Year 93

Vehicle Make (specify): CHRYSLER Vehicle Model (specify): TOWN + COUNTRY

## LOCATOR

Locate the end of the damage with respect to the vehicle longitudinal center line or bumper corner for end impacts or an undamaged axle for side impacts.

Specific Impact No.	Location of Direct Damage	Location of Field L	Location of Max Crush
3	49 starts 8 cm → center	entire front	C2
1+2	(R) side 251 starts 15 from door		

## CRUSH PROFILE IN CENTIMETERS

NOTES: Identify the plane at which the C-measurements are taken (e.g., at bumper, above bumper, at sill, above sill, etc.) and label adjustments (e.g., free space).

1190 Measure C1 to C6 from driver to passenger side in front or rear impacts and rear to front in side impacts.

Free space value is defined as the distance between the baseline and the original body contour taken at the individual C locations. This may include the following: bumper lead, bumper taper, side protrusion, side taper, etc. Record the value for each C-measurement and maximum crush.

Use as many lines/columns as necessary to describe each damage profile.

Specific Impact Number	Plane of Impact C-Measurements	Direct Damage		Field L	C <sub>1</sub>	C <sub>2</sub>	C <sub>3</sub>	C <sub>4</sub>	C <sub>5</sub>	C <sub>6</sub>	±D
		Width (CDC)	Max Crush								
3	frame	49	C2	106	51.5	63	61	57.5	33	19	
02	free				15	4	2	2	4	15	-32.5
13	fuel	49	59	106	36.5	59	59	55.5	29	4	-37.5
1	(R) side OVERLAPS	251	into roof rail SWIPE DAMAGE								
2	(R) side										

LOOKS LIKE BUMPER COVER - PLASTIC JUST MELTED

LOOK BUMPER TAPER

# ORIGINAL SPECIFICATIONS WORK SHEET

Wheelbase	<u>119.3</u>	inches	x 2.54	=	<u>303</u>	cm
Overall Length	<u>192.8</u>	inches	x 2.54	=	<u>490</u>	cm
Maximum Width	<u>72.0</u>	inches	x 2.54	=	<u>183</u>	cm
Curb Weight	<u>4,103</u>	pounds	x .4536	=	<u>1,861</u>	kg
Average Track	<u>61.0</u>	inches	x 2.54	=	<u>155</u>	cm
Front Overhang	<u>33.4</u>	inches	x 2.54	=	<u>85</u>	cm
Rear Overhang	<u>40.1</u>	inches	x 2.54	=	<u>102</u>	cm
Undeformed End Width	<u>62.0</u>	inches	x 2.54	=	<u>157</u>	cm
Engine Size: cyl./displ.	_____	cc	x .001	=	_____	L
	_____	CID	x .0164	=	<u>3.3</u>	L
	<u>V6</u>					

*4163 adapt  
100 lbs  
4203*



**VEHICLE DAMAGE SKETCH**

<p><b>TIRE - WHEEL DAMAGE</b></p> <p>a. Rotation physically restricted      b. Tire deflated</p> <p>RF <u>82</u>      RF <u>9</u>                  LF <u>91</u> <i>driven rearwards (wheel # 36)</i>      LF <u>9</u>                  RR <u>92</u>      RR <u>9</u>                  LR <u>92</u>      LR <u>9</u></p> <p>(1) Yes (2) No (8) NA (9) Unk.</p>	<p><b>ORIGINAL SPECIFICATIONS</b></p> <p>Wheelbase <u>303</u> cm                  Overall Length <u>490</u> cm                  Maximum Width <u>183</u> cm                  Curb Weight <u>1906-1860</u> kg                  Average Track <u>155</u> cm                  Front Overhang <u>85</u> cm                  Rear Overhang <u>102</u> cm                  Undeformed End Width <u>157</u> cm                  Engine Size: cyl./displ. <u>V6/3.3</u> L</p>	<p><b>WHEEL STEER ANGLES</b>                  (For locked front wheels or displaced rear axles only)</p> <p>RF ± <u>99</u> ° - 20                  LF ± <u>99</u> °                  RR ± <u>99</u> °                  LR ± <u>99</u> °                  Within ± 5 degrees</p>
<p><b>TYPE OF TRANSMISSION</b></p> <p><input type="checkbox"/> Manual      <input checked="" type="checkbox"/> Automatic</p> <p>END SHIFT ≥ 10 CM</p> <p><input type="checkbox"/> Yes      <input checked="" type="checkbox"/> No</p>		<p><b>DRIVE WHEELS</b></p> <p><input type="checkbox"/> FWD    <input type="checkbox"/> RWD    <input checked="" type="checkbox"/> 4WD</p>
		<p>Approximate Cargo Weight <u>10</u> kg</p>

**MEASUREMENTS IN CENTIMETERS**

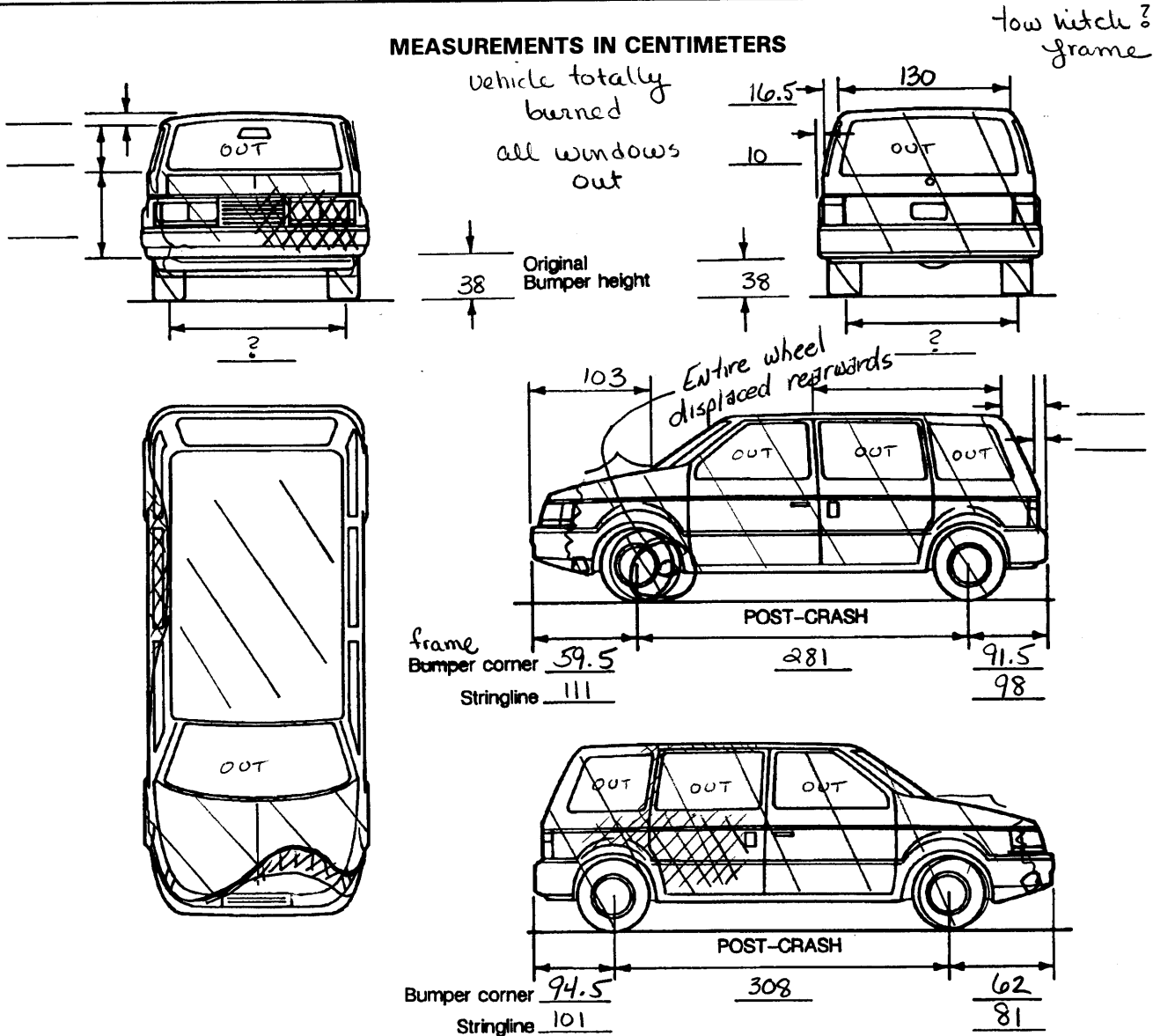

**NOTES:** Sketch new perimeter and cross hatch direct damage and single hatch induced damage on all views. Annotate observations which might be useful in reconstructing the accident (e.g., grass in tire bead, direction of striations, scuff on sidewalls, etc.). If pulling trailer, sketch type of trailer and damage received on the back of this page.

Annotate any damage caused by extrication such as component removal by torching, prying, or hydraulic shears.



**COLLISION DEFORMATION CLASSIFICATION**

HIGHEST DELTA "V"

Accident Event Sequence Number	Object Contacted	(1) (2) Direction of Force	(3) Deformation Location	(4) Longitudinal or Lateral Location	(5) Vertical or Lateral Location	(6) Type of Damage Distribution	(7) Deformation Extent
4. <u>03</u>	5. <u>42</u>	6. <u>12</u>	7. <u>F</u>	8. <u>Y</u>	9. <u>E</u>	10. <u>W</u>	11. <u>03</u>

Second Highest Delta "V"

12. <u>02</u>	13. <u>42</u>	14. <u>12</u>	15. <u>R</u>	16. <u>Z</u>	17. <u>A</u>	18. <u>S</u>	19. <u>03</u>
---------------	---------------	---------------	--------------	--------------	--------------	--------------	---------------

*COMBINED CDC for #1-#2 impacts*

*BASED UPON TREE HEIGHT CONTACT*

**CRUSH PROFILE IN CENTIMETERS**

The crush profile for the damage described in the CDC(s) above should be documented in the appropriate space below. (ALL MEASUREMENTS ARE IN CENTIMETERS.)

HIGHEST DELTA "V"

20. L	21. C <sub>1</sub>	C <sub>2</sub>	C <sub>3</sub>	C <sub>4</sub>	C <sub>5</sub>	C <sub>6</sub>	22. ±D
<u>157</u>	<u>037</u>	<u>059</u>	<u>059</u>	<u>056</u>	<u>029</u>	<u>004</u>	<u>+0033</u>

Second Highest Delta "V"

23. L	24. C <sub>1</sub>	C <sub>2</sub>	C <sub>3</sub>	C <sub>4</sub>	C <sub>5</sub>	C <sub>6</sub>	25. ±D
							<u>+</u>
							<u>-</u>

26. Undeformed End Width (Coded when highest severity impact is an end plane impact.) 157  
 Code to the nearest centimeter  
 (250) 250 centimeters or more  
 (998) No highest severity end plane impact  
 (999) Unknown

27. Direct Damage Width (For highest severity impact) 049  
 Code to the nearest centimeter  
 (250) 250 centimeters or more  
 (999) Unknown

28. Original Wheelbase 303  
 Code to the nearest centimeter  
 (650) 650 centimeters or more  
 (999) Unknown  
119.3 inches X 2.54 = 303 centimeters

29. Original Average Track Width 155  
 Code to the nearest centimeter  
 (185) 185 centimeters or more  
 (999) Unknown  
61.0 inches X 2.54 = 155 centimeters

**FUEL SYSTEM**

30. Are CDCs Documented but Not Coded on The Automated File? OX  
 (0) No *1st UNKNOWN COE*  
 (1) Yes
31. Researcher's Assessment of Vehicle Disposition 1  
 (0) Not towed due to vehicle damage  
 (1) Towed due to vehicle damage  
 (9) Unknown
32. Is This A Multi-Stage Manufactured Vehicle And/Or A Certified Altered Vehicle? 0  
 (0) No post manufacturer modifications  
 (1) Yes - post manufacturer modifications (specify): \_\_\_\_\_  
 \_\_\_\_\_  
 \_\_\_\_\_  
 (Include photograph of CERTIFICATION PLACARD in case report)  
 (9) Unknown if vehicle is modified

35. Location of Fuel Tank-1 Filler Cap 4  
0
36. Location of Fuel Tank-2 Filler Cap 0  
 (0) No fuel tank  
 (1) On back plane  
 (2) Aft of center of the rear wheels (rear axle) on left side plane  
 (3) Aft of center of the rear wheels (rear axle) on right side plane  
 (4) Forward of center of the rear wheels (rear axle) on left side plane  
 (5) Forward of center of the rear wheels (rear axle) on right side plane  
 (6) Over the center of the rear wheels (rear axle) on left side plane  
 (7) Over the center of the rear wheels (rear axle) on right side plane  
 (8) Other (specify): \_\_\_\_\_  
 (9) Unknown
37. Type of Fuel Tank-1 9  
0
38. Type of Fuel Tank-2 5  
 (0) No fuel tank (electrical vehicle)  
 (1) Metallic  
 (2) Non-metallic *gone* ✓?  
 (9) Unknown *YES - PER DEALER / BODY SHOP OPTIONAL*

**FIRE OCCURRENCE**

33. Fire Occurrence 2  
 (0) No fire  
 Yes, fire occurred  
 (1) Minor  
 (2) Major  
 (9) Unknown
34. Origin of Fire 4  
 (0) No fire  
 (1) Vehicle exterior (front, side, back, top)  
 (2) Exhaust system  
 (3) Fuel tank (and other fuel retention system parts) *?*  
 (4) Engine compartment ✓ *fuel injection system*  
 (5) Cargo/trunk compartment  
 (6) Instrument panel  
 (7) Passenger compartment area  
 (8) Other location (specify): \_\_\_\_\_  
 (9) Unknown

39. Location of Fuel Tank-1 5  
0
40. Location of Fuel Tank-2 0  
 (0) No fuel tank  
 (1) Aft of center of the rear wheels (rear axle) centered  
 (2) Aft of center of the rear wheels (rear axle) left side  
 (3) Aft of center of the rear wheels (rear axle) right side  
 (4) Forward of center of the rear wheels (rear axle) centered  
 (5) Forward of center of the rear wheels (rear axle) left side  
 (6) Forward of center of the rear wheels (rear axle) right side  
 (7) Over center of the rear wheels (rear axle)  
 (8) Other (specify): \_\_\_\_\_  
 (9) Unknown
41. Damage to Fuel Tank-1 9  
0
42. Damage to Fuel Tank-2 0  
 (0) No fuel tank  
 (1) No damage to fuel tank  
 (2) Deformed, no seam failure  
 (3) Deformed, with a seam failure  
 (4) Punctured  
 (5) Lacerated (ripped)  
 (6) Abraded (scraped)  
 (7) Filler neck separation from the fuel tank  
 (8) Other damage (specify): \_\_\_\_\_  
 (9) Unknown

43. Leakage Location of Fuel System-1 9  
 44. Leakage Location of Fuel System-2 0  
 (0) No fuel tank  
 (1) No fuel leakage  
*Primary Area Of Leakage*  
 (2) Tank  
 (3) Filler neck  
 (4) Cap  
 (5) Lines/pump/filter  
 (6) Vent/emission recovery  
 (8) Other (specify): \_\_\_\_\_  
 (9) Unknown

45. Fuel Type-1 01  
 46. Fuel Type-2 00

*Single Fuel Type*  
 (00) No fuel tank  
 (01) Gasoline  
 (02) Diesel  
 (03) CNG (Compressed Natural Gas)  
 (04) LPG (Liquid Petroleum Gas) also known as Propane  
 (05) LNG (Liquid Natural Gas)  
 (06) Methanol (M100 or M85)  
 (07) Ethanol (E100 or E85)  
 (08) Other (Hydrogen or others) (specify): \_\_\_\_\_

*Electric Powered or Electric/Solar Powered Vehicles*  
 (10) Lead Acid Battery  
 (11) Nickel-Iron Battery  
 (12) Nickel-Cadmium Battery  
 (13) Sodium Metal Chloride Battery  
 (14) Sodium Sulfur Battery  
 (18) Other (Specify): \_\_\_\_\_

(98) Other Hybrid (specify): \_\_\_\_\_  
 (99) Unknown fuel type

47. Is This Vehicle Equipped With More Than Two Fuel Tanks? 0  
 (0) No (one or two tanks only)  
*Yes - More Than Two Tanks*  
 (1) Yes -- no damage to any tank or filler cap and no fuel system leakage  
 (2) Yes -- no damage to any tank or filler cap but there is fuel system leakage (specify leakage location): \_\_\_\_\_  
 (3) Yes -- damage to an additional tank or filler cap and there is fuel system leakage (specify the following):  
 Type of tank \_\_\_\_\_  
 Tank location \_\_\_\_\_  
 Filler cap location \_\_\_\_\_  
 Tank damage \_\_\_\_\_  
 Location of leakage \_\_\_\_\_  
 Type of fuel \_\_\_\_\_  
 (9) Unknown if more than two tanks

**COMMENTS**

\_\_\_\_\_  
 \_\_\_\_\_  
 \_\_\_\_\_  
 \_\_\_\_\_  
 \_\_\_\_\_  
 \_\_\_\_\_  
 \_\_\_\_\_  
 \_\_\_\_\_  
 \_\_\_\_\_  
 \_\_\_\_\_

\*\*\* STOP: IF THE CDS APPLICABLE VEHICLE WAS NOT TOWED \*\*\*

(GV10=0)

DO NOT COMPLETE THE INTERIOR VEHICLE FORM.



# INTERIOR VEHICLE FORM

## GLAZING

1. Primary Sampling Unit Number 02  
 2. Case Number - Stratum 140A  
 3. Vehicle Number 01

## INTEGRITY

4. Passenger Compartment Integrity 99  
 (00) No integrity loss

Yes, Integrity Was Lost Through

- (01) Windshield
- (02) Door (side)
- (03) Door/hatch (back door)
- (04) Roof
- (05) Roof glass
- (06) Side window
- (07) Rear window (backlight)
- (08) Roof and roof glass
- (09) Windshield and door (side)
- (10) Windshield and roof
- (11) Side and rear window (side window and backlight)
- (12) Windshield and side window
- (13) Door and side window
- (98) Other combination of above (specify):

(99) Unknown

Door, Tailgate or Hatch Opening *opened to pull driver out by witness/nephew*  
 5. LF 3 6. RF 9 7. LR 0 8. RR 3 9. TG/H 1

- (0) No door/gate/hatch
- (1) Door/gate/hatch remained closed and operational
- (2) Door/gate/hatch came open during collision
- (3) Door/gate/hatch jammed shut
- (8) Other (specify):
- (9) Unknown

Damage/Failure Associated with Door, Tailgate or Hatch Opening in Collision. If IV05-IV09 ≠ 2, Then code 0

10. LF 0 11. RF 0 12. LR 0 13. RR 0 14. TG/H 0  
 (0) No door/gate/hatch or door not opened

Door, Tailgate or Hatch Came Open During Collision

- (1) Door operational (no damage)
- (2) Latch/striker failure due to damage
- (3) Hinge failure due to damage
- (4) Door structure failure due to damage
- (5) Door support (i.e., pillar, sill, roof side rail, etc.) failure due to damage
- (6) Latch/striker and hinge failure due to damage
- (8) Other failure (specify):

(9) Unknown

Type of Window/Windshield Glazing  
 15. WS 1 16. LF 9 17. RF 9 18. LR 9 19. RR 9  
 20. BL 9 21. Roof 0 22. Other 2 ← *Part of @ rear window in frame*

- (0) No glazing
- (1) AS-1 - Laminated - melted
- (2) AS-2 - Tempered *on dash*
- (3) AS-3 - Tempered-tinted (original)
- (4) AS-2 - Tempered-with after market tint
- (5) AS-3 - Tempered-tinted (with additional after market tint)
- (6) AS-14 - Glass/Plastic
- (7) Glazing removed prior to accident
- (8) Other (specify):
- (9) Unknown

Window Precrash Glazing Status

23. WS 1 24. LF 9 25. RF 9 26. LR 9 27. RR 9  
 28. BL 1 29. Roof 0 30. Other 9

- (0) No glazing
- (1) Fixed
- (2) Closed
- (3) Partially opened
- (4) Fully opened
- (7) Glazing removed prior to accident
- (9) Unknown

Glazing Damage from Impact Forces

31. WS 9 32. LF 9 33. RF 9 34. LR 9 35. RR 9  
 36. BL 9 37. Roof 0 38. Other 9

- (0) No glazing
- (1) No glazing damage from impact forces
- (2) Glazing in place and cracked from impact forces
- (3) Glazing in place and holed from impact forces
- (4) Glazing out-of-place (cracked or not) and not holed from impact forces
- (5) Glazing out-of-place and holed from impact forces
- (6) Glazing disintegrated from impact forces
- (7) Glazing removed prior to accident
- (9) Unknown if damaged

Glazing Damage from Occupant Contact

39. WS 9 40. LF 9 41. RF 9 42. LR 9 43. RR 9  
 44. BL 9 45. Roof 0 46. Other 9

- (0) No glazing
- (1) No occupant contact to glazing
- (2) Glazing contacted by occupant but no glazing damage
- (3) Glazing in place and cracked by occupant contact
- (4) Glazing in place and holed by occupant contact
- (5) Glazing out-of-place (cracked or not) by occupant contact and not holed by occupant contact
- (6) Glazing out-of-place by occupant contact and holed by occupant contact
- (7) Glazing removed prior to accident
- (8) Glazing disintegrated by occupant contact
- (9) Unknown if contacted by occupant

# INTRUSION WORKSHEET

Note: Sketch intruded areas

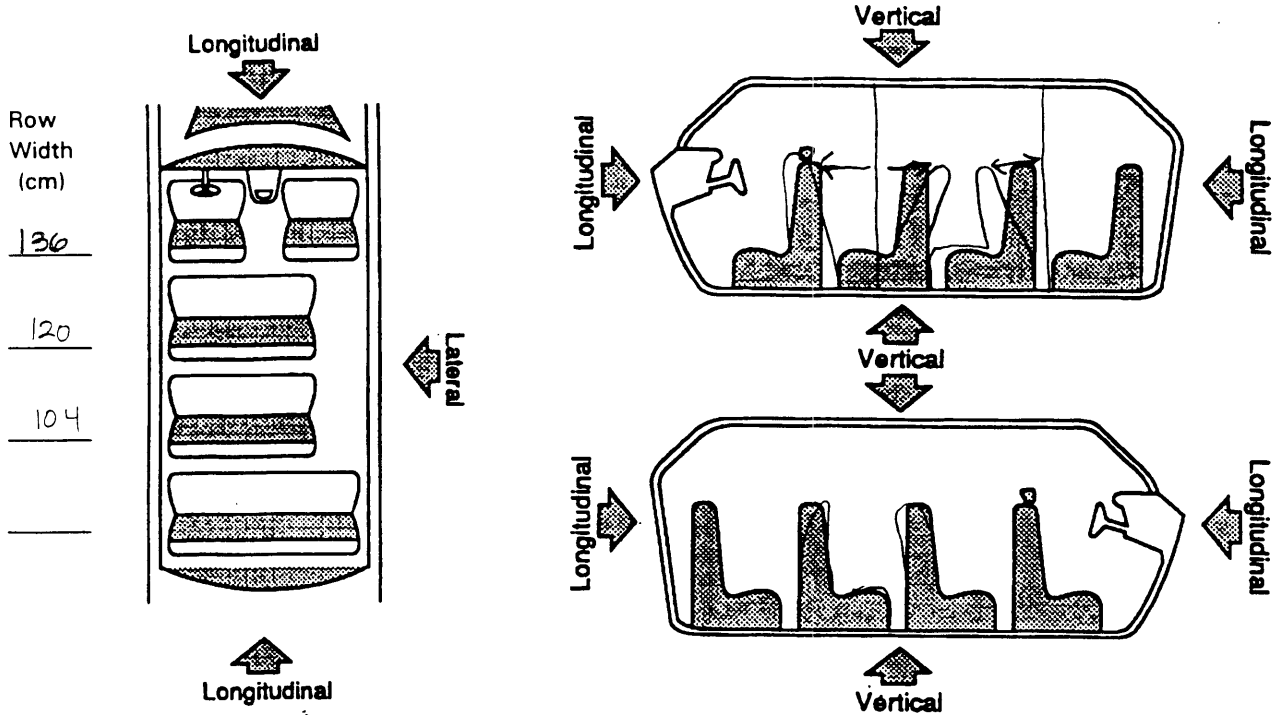

LOCATION OF INTRUSION	INTRUDED COMPONENT	(All Measurements Are In Centimeters)			DOMINANT CRUSH DIRECTION
		COMPARISON VALUE	INTRUDED VALUE	INTRUSION	
11	seat back (L)	0	30	30	long (3)
31	seat back 2 (L)	0	28	28	(4)
31	Seat back (3) (L)	0	48	48	(2)
32	" (3) (C)	0	22	22	(5)
31	cushion (3) (L)	0	55	55	(1)
32	" (3) (C)	0	19	19	(6)
33	" 3 R	0	8	8	v (7)

### OCCUPANT AREA INTRUSION

Note: If no intrusions, leave variables IV47-IV86 blank.

	Location of Intrusion	Intruding Component	Magnitude of Intrusion	Dominant Crush Direction
1st	47. <u>31</u>	48. <u>25</u>	49. <u>6</u>	50. <u>1</u>
2nd	51. <u>31</u>	52. <u>22</u>	53. <u>5</u>	54. <u>1</u>
3rd	55. <u>11</u>	56. <u>20</u>	57. <u>4</u>	58. <u>1</u>
4th	59. <u>31</u>	60. <u>21</u>	61. <u>3</u>	62. <u>1</u>
5th	63. <u>32</u>	64. <u>22</u>	65. <u>3</u>	66. <u>1</u>
6th	67. <u>32</u>	68. <u>25</u>	69. <u>3</u>	70. <u>1</u>
7th	71. <u>33</u>	72. <u>25</u>	73. <u>2</u>	74. <u>1</u>
8th	75. _____	76. _____	77. _____	78. _____
9th	79. _____	80. _____	81. _____	82. _____
10th	83. _____	84. _____	85. _____	86. _____

#### INTRUDING COMPONENT

##### *Interior Components*

- (01) Steering assembly
- (02) Instrument panel left
- (03) Instrument panel center
- (04) Instrument panel right
- (05) Toe pan
- (06) A (A1/A2)-pillar
- (07) B-pillar
- (08) C-pillar
- (09) D-pillar
- (10) Side panel - forward of the A1/A2-pillar
- (11) Door panel (side)
- (12) Side panel - rear of the B-pillar
- (13) Roof (or convertible top)
- (14) Roof side rail
- (15) Windshield
- (16) Windshield header
- (17) Window frame
- (18) Floor pan (includes sill)
- (19) Backlight header
- (20) Front seat back
- (21) Second seat back
- (22) Third seat back
- (23) Fourth seat back
- (24) Fifth seat back
- (25) Seat cushion
- (26) Back door/panel (e.g., tailgate)
- (27) Other interior component (specify): \_\_\_\_\_

##### *Exterior Components*

- (30) Hood
- (31) Outside surface of this vehicle (specify): \_\_\_\_\_
- (32) Other exterior object in the environment (specify): \_\_\_\_\_
- (33) Unknown exterior object
- (97) Catastrophic
- (98) Intrusion of unlisted component(s) (specify): \_\_\_\_\_
- (99) Unknown

#### LOCATION OF INTRUSION

- |  |   |
|--|---|
| <p><b>Front Seat</b></p> <ul style="list-style-type: none"> <li>(11) Left</li> <li>(12) Middle</li> <li>(13) Right</li> </ul> <p><b>Second Seat</b></p> <ul style="list-style-type: none"> <li>(21) Left</li> <li>(22) Middle</li> <li>(23) Right</li> </ul> <p><b>Third Seat</b></p> <ul style="list-style-type: none"> <li>(31) Left</li> <li>(32) Middle</li> <li>(33) Right</li> </ul> | <p><b>Fourth Seat</b></p> <ul style="list-style-type: none"> <li>(41) Left</li> <li>(42) Middle</li> <li>(43) Right</li> </ul> <p>(97) Catastrophic</p> <p>(98) Other enclosed area (specify) _____</p> <p>(99) Unknown</p> |
|--|---|

#### MAGNITUDE OF INTRUSION

- (1) ≥ 3 centimeters but < 8 centimeters
- (2) ≥ 8 centimeters but < 15 centimeters
- (3) ≥ 15 centimeters but < 30 centimeters
- (4) ≥ 30 centimeters but < 46 centimeters
- (5) ≥ 46 centimeters but < 61 centimeters
- (6) ≥ 61 centimeters
- (7) Catastrophic
- (9) Unknown

#### DOMINANT CRUSH DIRECTION

- (1) Vertical
- (2) Longitudinal
- (3) Lateral
- (7) Catastrophic
- (9) Unknown



# STEERING RIM/SPOKE DEFORMATION

(All Measurements Are in Centimeters)

COMPARISON VALUE	-	DAMAGE VALUE	=	DEFORMATION
top	0	2.0	=	2.0
bottom	0	2.5	=	2.5
	-		=	
	-		=	

Blank area for additional notes or data.

**STEERING COLUMN**

**INSTRUMENT PANEL**

87. Steering Column Type 9  
 (1) Fixed column  
 (2) Tilt column   
 (3) Telescoping column  
 (4) Tilt and telescoping column  
 (8) Other column type (specify): \_\_\_\_\_  
 (9) Unknown

88. Tilt Steering Column Adjustment 9  
 (0) No tilt steering column  
 (1) Full up  
 (2) Between full up and center  *dash melted*  
 (3) Center  
 (4) Between center and full down  
 (5) Full down  
 (9) Unknown

89. Telescoping Steering Column Adjustment 9  
 (0) No telescoping steering column  
 (1) Full back  
 (2) Between full back and midpoint  
 (3) Midpoint  
 (4) Between midpoint and full forward  
 (5) Full forward  
 (9) Unknown

90. Steering Rim/Spoke Deformation 03  
 Code actual measured  
 deformation to the nearest centimeter  
 (00) No steering rim deformation  
 (01-14) Actual measured value in centimeters  
 (15) 15 centimeters or more  
 (98) Observed deformation cannot be measured  
 (99) Unknown

91. Location of Steering Rim/Spoke Deformation 09  
 (00) No steering rim deformation

*Quarter Sections*

- (01) Section A
- (02) Section B
- (03) Section C
- (04) Section D



*Half Sections*

- (05) Upper half of rim/spoke
- (06) Lower half of rim/spoke
- (07) Left half of rim/spoke
- (08) Right half of rim/spoke
- (09) Complete steering wheel collapse
- (10) Undetermined location
- (99) Unknown

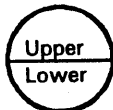

92. Odometer Reading 999,000  
 kilometers  
 Code to the nearest 1,000 kilometers  
 (000) No odometer  
 (001) Less than 1,500 kilometers  
 (500) 499,500 kilometers or more  
 (999) Unknown  
 \_\_\_\_\_ miles X 1.6093 = \_\_\_\_\_ kilometers

Source: \_\_\_\_\_

93. Instrument Panel Damage from Occupant Contact? 9  
 (0) No  
 (1) Yes  
 (9) Unknown

94. Type of Knee Bolster Covering 9  
 (0) No knee bolster  
 (1) Padded  
 (2) Rigid plastic  
 (8) Other (specify): \_\_\_\_\_  
 (9) Unknown

95. Knee Bolsters Deformed from Occupant Contact? 9  
 (0) No knee bolster  
 (1) No deformation  
 (2) Yes - deformation  
 (9) Unknown

96. Did Glove Compartment Door Open During Collision(s)? 9  
 (0) No glove compartment door  
 (1) No - door did not open  
 (2) Yes - door opened  
 (9) Unknown

97. Adaptive (Assistive) Driving Equipment 0  
 (0) No adaptive driving equipment  
 (1) Adaptive driving equipment installed (Check all that apply.)  
 Hand controls for braking/acceleration  
 Steering control devices (attached to OEM steering wheel)  
 Steering knob attached to steering wheel  
 Low effort power steering (unit or device)  
 Replacement steering wheel (i.e., reduced diameter)  
 Joy-stick steering controls  
 Wheelchair tie-downs  
 Modification to seat belts (specify): \_\_\_\_\_  
 Additional or relocated switches (specify): \_\_\_\_\_  
 Raised roof  
 Wall-mounted head rest (used behind wheelchair)  
 Other adaptive device (specify): \_\_\_\_\_

(9) Unknown

## VEHICLE INTERIOR SKETCHES

Note area of ejection/entrapment

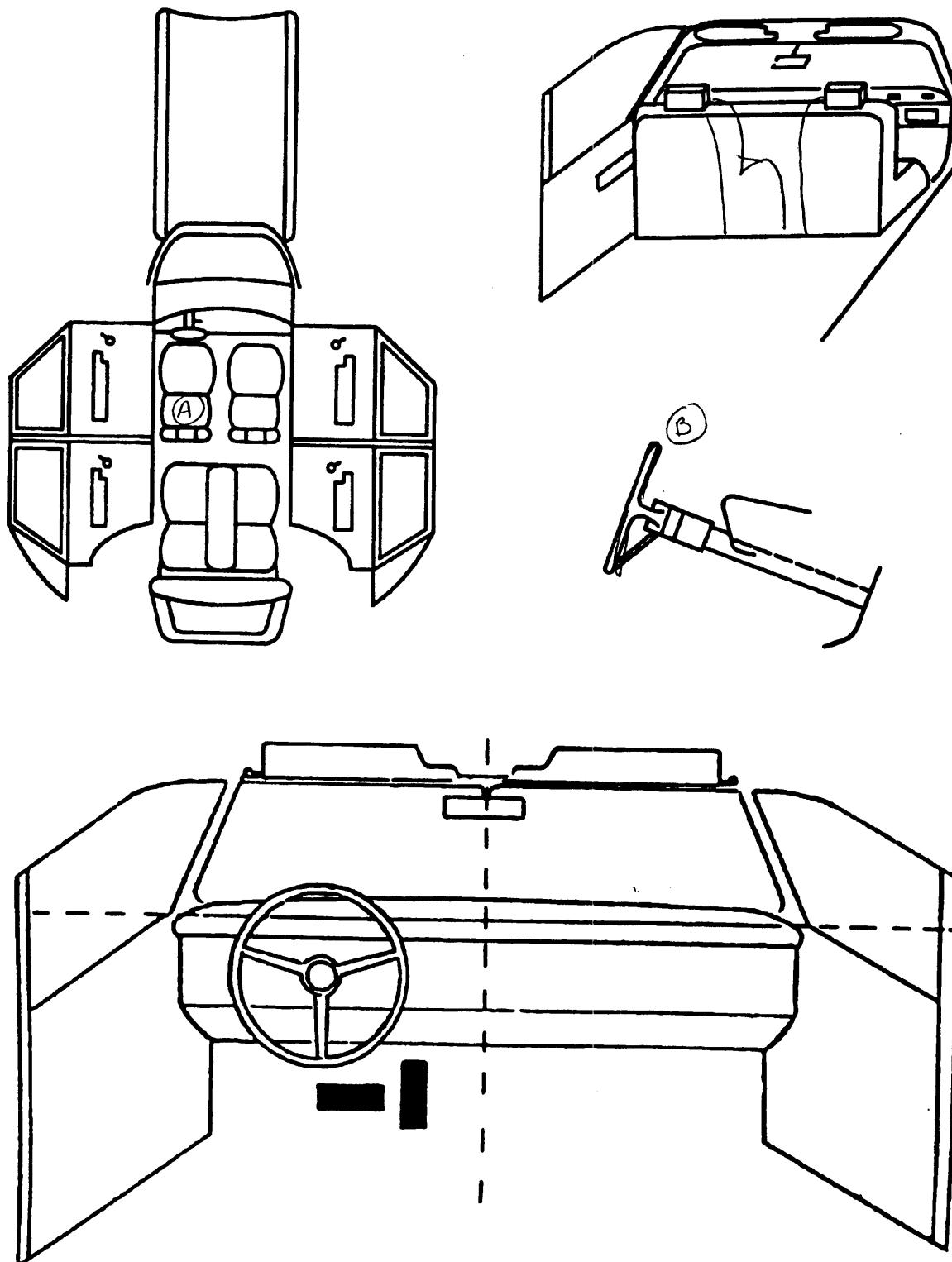

Sketch windshield contact(s) and the damaged area(s) on the instrument panel outline (e.g., radio, glove compartment, damage to instrument panel structure.  
Cross hatch contact points, draw spider webs or use other annotation as may be appropriate.  
Annotate the contacted area with a letter (begin with A) and list on the Points of Occupant Contact page.

**POINTS OF OCCUPANT CONTACT**

Contact	Interior Component Contacted	Occupant No. If Known	Body Region If Known	Supporting Physical Evidence	Confidence Level of Contact Point
A	151	01	back/neck	shifted backward	2
B	004	01	head/face	rim bent/broken off?	1
C					
D					
E				ENTIRE INTERIOR	
F				DESTROYED	
G				BY FIRE	
H					
I					
J					
K					
L					
M					
N					

**CODES FOR INTERIOR COMPONENTS**

- |  |  |   |  |
|--|--|---|--|
| <p><b>FRONT</b><br/>                 (001) Windshield<br/>                 (002) Mirror<br/>                 (003) Sunvisor<br/>                 (004) Steering wheel rim<br/>                 (005) Steering wheel hub/spoke<br/>                 (006) Steering wheel (combination of codes 004 and 005)<br/>                 (007) Steering column, transmission selector lever, other attachment<br/>                 (008) Cellular telephone or CB radio<br/>                 (009) Add on equipment (e.g., tape deck, air conditioner)<br/>                 (010) Left instrument panel and below<br/>                 (011) Center instrument panel and below<br/>                 (012) Right instrument panel and below<br/>                 (013) Glove compartment door<br/>                 (014) Knee bolster<br/>                 (015) Windshield including one or more of the following: front header, A (A1/A2)-pillar, instrument panel, mirror, or steering assembly (driver side only)<br/>                 (016) Windshield including one or more of the following: front header, A (A1/A2)-pillar, instrument panel, or mirror (passenger side only)<br/>                 (017) Windshield reinforced by exterior object, (specify): _____<br/>                 (019) Other front object (specify): _____</p> | <p><b>LEFT SIDE</b><br/>                 (051) Left side interior surface, excluding hardware or armrests<br/>                 (052) Left side hardware or armrest<br/>                 (053) Left A (A1/A2)-pillar<br/>                 (054) Left B-pillar<br/>                 (055) Other left pillar (specify): _____<br/>                 (056) Left side window glass<br/>                 (057) Left side window frame<br/>                 (058) Left side window sill<br/>                 (059) Left side window glass including one or more of the following: frame, window sill, A (A1/A2)-pillar, B-pillar, or roof side rail.<br/>                 (060) Other left side object (specify): _____</p> <p><b>RIGHT SIDE</b><br/>                 (101) Right side interior surface, excluding hardware or armrests<br/>                 (102) Right side hardware or armrest<br/>                 (103) Right A (A1/A2)-pillar<br/>                 (104) Right B-pillar<br/>                 (105) Other right pillar (specify): _____<br/>                 (106) Right side window glass<br/>                 (107) Right side window frame<br/>                 (108) Right side window sill<br/>                 (109) Right side window glass including one or more of the following: frame, window sill, A (A1/A2)-pillar, B-pillar, or roof side rail.<br/>                 (110) Other right side object (specify): _____</p> | <p><b>INTERIOR</b><br/>                 (151) Seat, back support<br/>                 (152) Belt restraint webbing/buckle<br/>                 (153) Belt restraint B-pillar or door frame attachment point<br/>                 (154) Other restraint system component (specify): _____<br/>                 (155) Head restraint system<br/>                 (160) Other occupants (specify): _____<br/>                 (161) Interior loose objects<br/>                 (162) Child safety seat (specify): _____<br/>                 (163) Other interior object (specify): _____</p> <p><b>AIR BAG</b><br/>                 (170) Air bag-driver side<br/>                 (175) Air bag compartment cover-driver side<br/>                 (180) Air bag-passenger side<br/>                 (185) Air bag compartment cover-passenger side<br/>                 (190) Other air bag (specify) _____<br/>                 (195) Other air bag compartment cover (specify) _____</p> <p><b>ROOF</b><br/>                 (201) Front header<br/>                 (202) Rear header<br/>                 (203) Roof left side rail<br/>                 (204) Roof right side rail<br/>                 (205) Roof or convertible top</p> <p><b>FLOOR</b><br/>                 (251) Floor (including toe pan)<br/>                 (252) Floor or console mounted transmission lever, including console<br/>                 (253) Parking brake handle<br/>                 (254) Foot controls including parking brake</p> | <p><b>REAR</b><br/>                 (301) Backlight (rear window)<br/>                 (302) Backlight storage rack, door, etc.<br/>                 (303) Other rear object (specify): _____</p> <p><b>ADAPTIVE (ASSISTIVE) DRIVING EQUIPMENT</b><br/>                 (401) Hand controls for braking/acceleration<br/>                 (402) Steering control devices (attached to OEM steering wheel)<br/>                 (403) Steering knob attached to steering wheel<br/>                 (405) Replacement steering wheel (i.e., reduced diameter)<br/>                 (406) Joy stick steering controls<br/>                 (407) Wheelchair tie-downs<br/>                 (408) Modification to seat belts, (specify): _____<br/>                 (409) Additional or relocated switches, (specify): _____<br/>                 (410) Raised roof<br/>                 (411) Wall mounted head rest (used behind wheel chair)<br/>                 (412) Other adaptive device (specify): _____</p> |
|--|--|---|--|

CONFIDENCE LEVEL OF CONTACT POINT	
(1)	Certain
(2)	Probable
(3)	Possible
(9)	Unknown

# MANUAL RESTRAINTS

**NOTES:** Encode the applicable data for each seat position in the vehicle. The attribute for the variable may be found below. Restraint systems should be assessed during the vehicle inspection then coded on the Occupant Assessment Form. If a Child safety seat is present, encode the data on the back of this page. If the vehicle has automatic restraints available, encode the appropriate data on the back of the previous page.

		Left	Center	Right
<b>FIRST</b>	Availability	4A	0	4A
	Evidence of usage	99	00	99
	Used in this crash?	99	00	00
	Proper Use	9	0	0
	Failure Modes	9	0	0
	Anchorage Adjustment	3	0	3
<b>SECOND</b>	Availability	4	0	4
	Evidence of usage	99	00	99
	Used in this crash?	00	00	00
	Proper Use	0	0	0
	Failure Modes	0	0	0
	Anchorage Adjustment	1	0	1
<b>OTHER</b>	Availability	4	9	4
	Evidence of usage	99	99	99
	Used in this crash?	00	00	00
	Proper Use	0	0	0
	Failure Modes	0	0	0
	Anchorage Adjustment	1	0	1

**Manual (Active) Belt System Availability**

- (0) None available
- (1) Belt removed/destroyed
- (2) Shoulder belt
- (3) Lap belt
- (4) Lap and shoulder belt
- (5) Belt available - type unknown

*Integral Belt Partially Destroyed*

- (6) Shoulder belt (lap belt destroyed/removed)
- (7) Lap belt (shoulder belt destroyed/removed)
- (8) Other belt (specify): \_\_\_\_\_

- (9) Unknown

**Manual (Active) Belt System Use**

- (00) None used, not available, or belt removed/destroyed
- (01) Inoperable (specify): \_\_\_\_\_

- (02) Shoulder belt
- (03) Lap belt
- (04) Lap and shoulder belt
- (05) Belt used - type unknown
- (08) Other belt used (specify): \_\_\_\_\_
- (12) Shoulder belt used with child safety seat
- (13) Lap belt used with child safety seat
- (14) Lap and shoulder belt used with child safety seat
- (15) Belt used with child safety seat - type unknown
- (18) Other belt used with child safety seat (specify): \_\_\_\_\_
- (99) Unknown if belt used

**Proper Use of Manual (Active) Belts**

- (0) None used or not available
- (1) Belt used properly
- (2) Belt used properly with child safety seat

*Belt Used Improperly*

- (3) Shoulder belt worn under arm
- (4) Shoulder belt worn behind back or seat
- (5) Belt worn around more than one person
- (6) Lap belt worn on abdomen
- (7) Lap belt or lap and shoulder belt used improperly with child safety seat (specify): \_\_\_\_\_
- (8) Other improper use of manual belt system (specify): \_\_\_\_\_
- (9) Unknown

**Manual (Active) Belt Failure Modes During Accident**

- (0) No manual belt used or not available
- (1) No manual belt failure(s)
- (2) Torn webbing (stretched webbing not included)
- (3) Broken buckle or latchplate
- (4) Upper anchorage separated
- (5) Other anchorage separated (specify): \_\_\_\_\_
- (6) Broken retractor
- (7) Combination of above (specify): \_\_\_\_\_
- (8) Other manual belt failure (specify): \_\_\_\_\_
- (9) Unknown

**Shoulder Belt Upper Anchorage Adjustment**

- (0) No shoulder belt
- (1) No upper anchorage adjustment for shoulder belt

*Adjustable shoulder Belt Upper Anchorage*

- (2) In full up position
- (3) In mid position
- (4) In full down position
- (5) Position unknown
- (9) Unknown if position has adjustable upper anchorage adjustment

### AUTOMATIC RESTRAINTS

NOTES: Encode the data for each applicable front seat position. The attribute for the variables may be found below. Restraint systems should be assessed during the vehicle inspection then coded on the Occupant Assessment Form.

#### AIR BAGS

		Left Front	Right Front	Other
F I R S T	Availability/Function	1 ?	N 9 N E 0	0
	Deployment	9	N 9 N E 0	0
	Failure	9	9 0	0

**Air Bag System Availability/Function**

- (0) Not equipped/not available
- (1) Air bag

*Non-functional*

- (2) Air bag disconnected (specify): \_\_\_\_\_

- (3) Air bag not reinstalled
- (9) Unknown

**Are There Indications of Air Bag System Failure? (This Occupant Position)**

- (0) Not equipped/not available
- (1) No
- (2) Yes (specify): \_\_\_\_\_
- (9) Unknown

**Frontal Air Bag System Deployment (This Occupant Position)**

- (0) Not equipped/not available
- (1) Deployed during accident (as a result of impact)
- (2) Deployed inadvertently just prior to accident
- (3) Deployed, accident sequence undetermined
- (4) Deployed as a result of a noncollision event during accident sequence (e.g., fire, explosion, electrical)
- (5) Unknown if deployed
- (7) Nondeployed
- (9) Unknown

**Air Bag(s) Deployment, Other Than First Seat Frontal (This Occupant Position)**

- (0) Not equipped with an "other" air bag
- (1) Deployed during accident (as a result of impact)
- (2) Deployed inadvertently just prior to accident
- (3) Deployed, details unknown
- (4) Deployed as a result of a noncollision event during accident sequence (e.g., fire, explosion, electrical)
- (5) Unknown if deployed
- (7) Nondeployed
- (9) Unknown

#### AUTOMATIC BELTS

		Left	Right
F I R S T	Availability/Function	0	0
	Use	0	0
	Type	0	0
	Proper Use	0	0
	Failure Modes	0	0

**Automatic (Passive) Belt System Availability/Function**

- (0) Not equipped/not available
- (1) 2 point automatic belts
- (2) 3 point automatic belts
- (3) Automatic belts - type unknown

*Non-functional*

- (4) Automatic belts destroyed or rendered inoperative
- (9) Unknown

**Automatic (Passive) Belt System Use**

- (0) Not equipped/not available/destroyed or rendered inoperative
- (1) Automatic belt in use
- (2) Automatic belt not in use (manually disconnected, motorized track inoperative)
- (3) Automatic belt use unknown
- (9) Unknown

**Automatic (Passive) Belt System Type**

- (0) Not equipped/not available
- (1) Non-motorized system
- (2) Motorized system
- (9) Unknown

**Proper Use of Automatic (Passive) Belt System**

- (0) Not equipped/not available/not used
- (1) Automatic belt used properly
- (2) Automatic belt used properly with child safety seat

*Automatic Belt Used Improperly*

- (3) Automatic shoulder belt worn under arm
- (4) Automatic shoulder belt worn behind back
- (5) Automatic belt worn around more than one person
- (6) Lap portion of automatic belt worn on abdomen
- (7) Automatic lap and shoulder belt or automatic shoulder belt used improperly with child safety seat (specify): \_\_\_\_\_
- (8) Other improper use of automatic belt system (specify): \_\_\_\_\_
- (9) Unknown

**Automatic (Passive) Belt Failure Modes During Accident**

- (0) Not equipped/not available/not in use
- (1) No automatic belt failure(s)
- (2) Torn webbing (stretched webbing not included)
- (3) Broken buckle or latchplate
- (4) Upper anchorage separated
- (5) Other anchorage separated (specify): \_\_\_\_\_
- (6) Broken retractor
- (7) Combination of above (specify): \_\_\_\_\_
- (8) Other automatic belt failure (specify): \_\_\_\_\_
- (9) Unknown

# FIRST SEAT FRONTAL AIR BAGS

NOTES: Encode the applicable data *for the driver and first seat passenger* in the vehicle. The attribute for the variable may be found below. Restraint systems should be assessed during the vehicle inspection then coded on the Occupant Assessment Form.

	Driver	Passenger
Type of air bag?	1	9
Flaps open at tear points?	8	9
Flaps damaged?	8	9
Air bag damaged?	98	99
Source of air bag damage	98	99
Air bag tethered?	8	9
Air bag have vent ports?	8	9
Other occupant contact air bag?	8	9
Occupant wearing eyewear?	8/9	0

**Type of Air Bag**

- (0) Not equipped/not available
- (1) Original manufacturer installed system
- (2) Retrofitted air bag
- (3) Replacement air bag
- (8) Unknown type of air bag
- (9) Unknown

**Did Air Bag Module Cover Flap(s) Open At Designated Tear Points?**

- (0) Not equipped/not available
- (1) No
- (2) Yes
- (3) Deployed, unknown if flap(s) opened at designated tear points
- (7) Not deployed
- (8) Unknown if deployed
- (9) Unknown

**Were Air Bag Module Cover Flap(s) Damaged?**

- (0) Not equipped/not available
- (1) No
- (2) Yes (specify): \_\_\_\_\_
- (3) Deployed, unknown if air bag module cover flap(s) damaged
- (7) Not deployed
- (8) Unknown if deployed
- (9) Unknown

**Was There Damage To The Air Bag?**

- (00) Not equipped/not available
- (01) Not damaged

*Yes - Air Bag Damage*

- (02) Ruptured
- (03) Cut
- (04) Torn
- (05) Holed
- (06) Burned
- (07) Abraded
- (88) Other damage (specify): \_\_\_\_\_

**Source of Air Bag Damage**

- (00) Not equipped/not available
- (01) Not damaged
- (02) Object worn by occupant, (specify): \_\_\_\_\_
- (03) Object carried by occupant, (specify): \_\_\_\_\_
- (04) Adaptive/assistive controls, (specify): \_\_\_\_\_
- (05) Fire in vehicle
- (06) Thermal burns
- (07) Rescue or emergency efforts
- (88) Other damage source (specify): \_\_\_\_\_
- (95) Damaged, unknown source
- (96) Deployed, unknown if damaged
- (97) Not deployed
- (98) Unknown if deployed
- (99) Unknown

**Was The Air Bag Tethered?**

- (0) Not equipped/not available
- (1) No
- (2) Yes (specify number of tether straps): \_\_\_\_\_
- (3) Deployed, unknown if tethered
- (7) Not deployed
- (8) Unknown if deployed
- (9) Unknown

**Did The Air Bag Have Vent Ports?**

- (0) Not equipped/not available
- (1) No
- (2) Yes (specify number of vent ports): \_\_\_\_\_
- (3) Deployed, unknown if vent ports present
- (7) Not deployed
- (8) Unknown if deployed
- (9) Unknown

**Was the Air Bag in this Occupant's Position Contacted by Another Occupant?**

- (0) Not equipped/not available
- (1) No
- (2) Yes (specify): \_\_\_\_\_
- (3) Deployed, unknown if other occupant contact to air bag
- (7) Not deployed
- (8) Unknown if deployed
- (9) Unknown

**Was This Occupant Wearing Eye-wear?**

- (0) Not equipped/not available
- (1) No
- (2) Eyeglasses/sunglasses
- (3) Contact lenses
- (4) Deployed, unknown if eyewear worn
- (7) Not deployed
- (8) Unknown if deployed
- (9) Unknown

**DRIVER AIR BAG DAMAGE AND CONTACT SKETCHES**

1. SKETCH DAMAGE AND CONTACT EVIDENCE ON DRIVER AIR BAG (Front)

*unknown  
if air bag  
deployed  
or if damaged.*

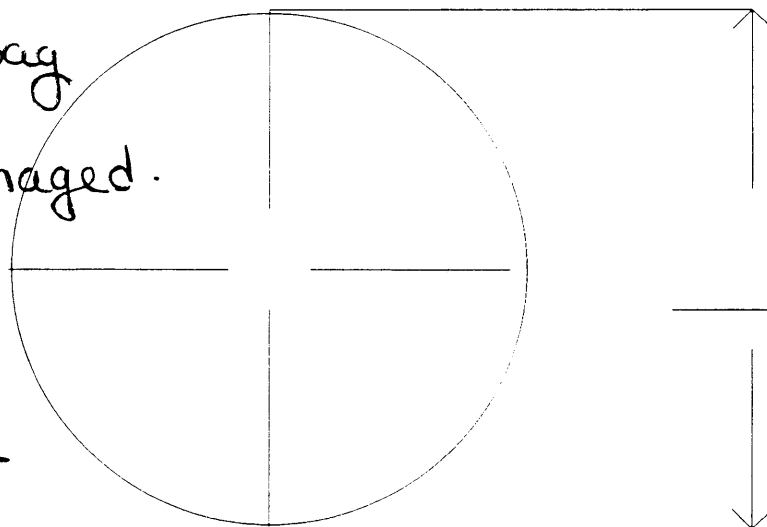

cm.

*destroyed by  
fire*

2. SKETCH DAMAGE AND CONTACT EVIDENCE ON DRIVER AIR BAG (Back)

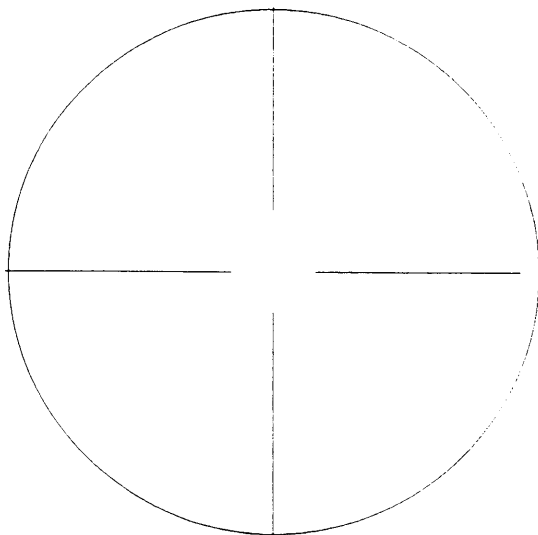



**DRIVER AIR BAG SKETCHES (Cont'd)**

3. DRIVER AIR BAG MODULE COVER FLAP SIZE (DOUBLE)

- a. Upper Flap                      b. Lower Flap  
width ( $W_u$ ) \_\_\_\_\_ width ( $W_l$ ) \_\_\_\_\_  
height ( $H_u$ ) \_\_\_\_\_ height ( $H_l$ ) \_\_\_\_\_

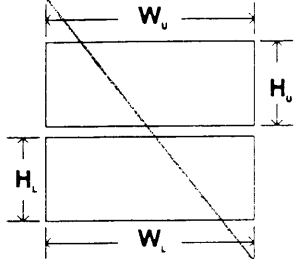

4. SKETCH OF OTHER TYPE OF AIR BAG MODULE FLAP AND SIZE

5. SKETCH OF OTHER TYPE OF AIR BAG VENT PORTS

6. SKETCH LOCATION OF CIRCULAR AIR BAG VENT PORTS

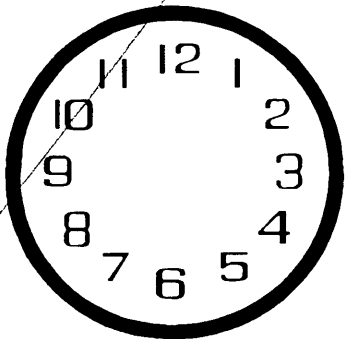

**PASSENGER AIR BAG DAMAGE AND CONTACT SKETCHES**

1. SKETCH DAMAGE AND CONTACT EVIDENCE ON PASSENGER AIR BAG (Front)

~~unknown if there is a passenger airbag~~  
NONE

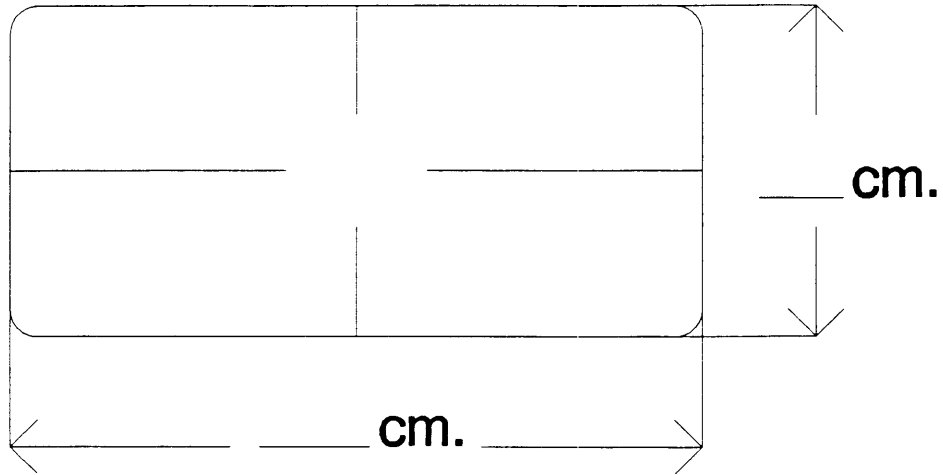

2. SKETCH DAMAGE AND CONTACT EVIDENCE ON PASSENGER AIR BAG (Back)

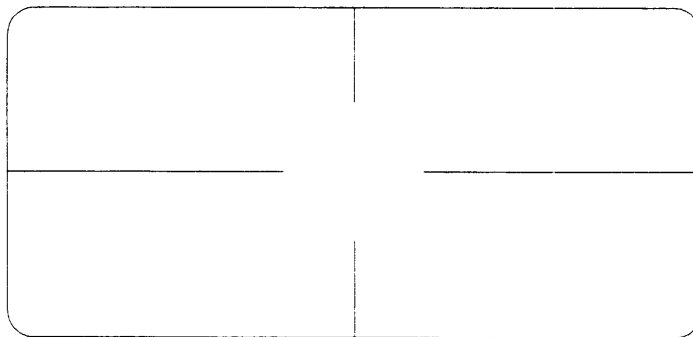

**PASSENGER AIR BAG SKETCHES (Cont'd)**

3. PASSENGER AIR BAG MODULE COVER FLAP SIZE (SINGLE)

a. Flap

width (W) \_\_\_\_\_

height (H) \_\_\_\_\_

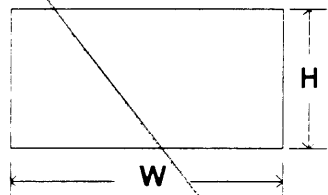

4. PASSENGER AIR BAG MODULE COVER FLAP SIZE (DOUBLE)

a. Upper Flap

b. Lower Flap

width ( $W_U$ ) \_\_\_\_\_

width ( $W_L$ ) \_\_\_\_\_

height ( $H_U$ ) \_\_\_\_\_

height ( $H_L$ ) \_\_\_\_\_

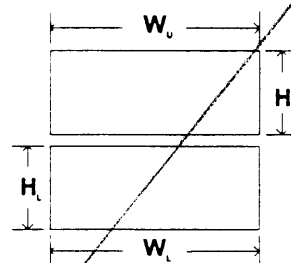

5. SKETCH OF OTHER TYPE OF AIR BAG MODULE FLAP AND SIZE

6. SKETCH OF OTHER TYPE OF AIR BAG VENT PORTS

7. SKETCH LOCATION OF RECTANGULAR AIR BAG VENT PORTS

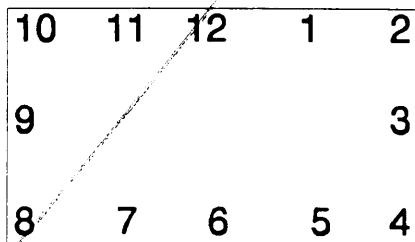

**"OTHER" AIR BAG DAMAGE AND CONTACT SKETCHES**

1. SKETCH DAMAGE AND CONTACT EVIDENCE ON "OTHER" AIR BAG (Front)

2. SKETCH DAMAGE AND CONTACT EVIDENCE ON "OTHER" AIR BAG (Back)

**"OTHER" AIR BAG SKETCHES (Cont'd)**

3. SKETCH AIR BAG MODULE FLAP AND SIZE OR OPENING FOR AIRBAG

4. SKETCH AIR BAG VENT PORTS

## HEAD RESTRAINTS/SEAT EVALUATION

**NOTES:** Encode the applicable data for each seat position in the vehicle. The attribute for these variables may be found at the bottom of the page. Head restraint type/damage and seat type/performance should be assessed during the vehicle inspection then coded on the Occupant Assessment Form.

		Left	Center	Right
<b>FIRST</b>	Head Restraint Type/Damage	9	0	9
	Seat Type	01	00	01
	Seat Performance	① 5	0	9
	Seat Orientation	1	0	1
	Seat Track Position	6	0	6
	Seat Back Incline Pre/Post Impact	99	00	23
<b>SECOND</b>	Head Restraint Type/Damage	9	0	9
	Seat Type	01	00	01
	Seat Performance	② 9	00	9
	Seat Orientation	1	0	1
	Seat Track Position	1	0	1
	Seat Back Incline Pre/Post Impact	99		99
<b>THIRD</b>	Head Restraint Type/Damage	0	0	0
	Seat Type	03	03	03
	Seat Performance	③* 9	9	9
	Seat Orientation	1	1	1
	Seat Track Position	01	01	01
	Seat Back Incline Pre/Post Impact	1	1	1
<b>OTHER</b>	Head Restraint Type/Damage			
	Seat Type			
	Seat Performance			
	Seat Orientation			
	Seat Track Position			
	Seat Back Incline Pre/Post Impact			

**DESCRIBE ANY INDICATION OF ABNORMAL OCCUPANT POSTURE  
(I.E., UNUSUAL OCCUPANT CONTACT PATTERN)**

③ shifted forward  
 ② ④ shifted rearward  
 ① ⑥ pushed forward

**HEAD RESTRAINTS/SEAT EVALUATION****Head Restraint Type/Damage by Occupant at This Occupant Position**

- (0) No head restraints
- (1) Integral — no damage
- (2) Integral — damaged during accident
- (3) Adjustable — no damage
- (4) Adjustable — damaged during accident
- (5) Add-on — no damage
- (6) Add-on — damaged during accident
- (8) Other  
Specify): \_\_\_\_\_
- (9) Unknown

**Seat Type (this Occupant Position)**

- (00) Occupant not seated or no seat
- (01) Bucket
- (02) Bucket with folding back
- (03) Bench
- (04) Bench with separate back cushions
- (05) Bench with folding back(s)
- (06) Split bench with separate back cushions
- (07) Split bench with folding back(s)
- (08) Pedestal (i.e., column supported)
- (09) Other seat type (specify): \_\_\_\_\_
- (10) Box mounted seat (i.e., van type)
- (99) Unknown

**Seat Performance (this Occupant Position)**

- (0) Occupant not seated or no seat
- (1) No seat performance failure(s)
- (2) Seat adjusters failed
- (3) Seat back folding locks or "seat back" failed (specify): \_\_\_\_\_
- (4) Seat tracks/anchors failed
- (5) Deformed by impact of occupant
- (6) Deformed by passenger compartment intrusion (specify): \_\_\_\_\_
- (7) Combination of above (specify): \_\_\_\_\_
- (8) Other (specify): \_\_\_\_\_
- (9) Unknown

**Seat Orientation (this Occupant Position)**

- (0) Occupant not seated or no seat
- (1) Forward facing seat
- (2) Rear facing seat
- (3) Side facing seat (inward)
- (4) Side facing seat (outward)
- (8) Other (specify): \_\_\_\_\_
- (9) Unknown

**Seat Track Adjusted Position Prior To Impact**

- (0) Occupant not seated or no seat
  - (1) Non-adjustable seat track
- Adjustable Seat Track*
- (2) Seat at forward most track position
  - (3) Seat between forward most and middle track positions
  - (4) Seat at middle track position
  - (5) Seat between middle and rear most track positions
  - (6) Seat at rear most track position
  - (9) Unknown

**Seat Back Incline Prior and Post Impact**

- (00) Occupant not seated or no seat
- (01) Not adjustable

*Upright prior to impact*

- (11) Moved to completely rearward position
- (12) Moved to rearward midrange position
- (13) Moved to slightly rearward position
- (14) Retained pre-impact position
- (15) Moved to slightly forward position
- (16) Moved to forward midrange position
- (17) Moved to completely forward position

*Slightly reclined prior to impact*

- (21) Moved to completely rearward position
- (22) Moved to rearward midrange position
- (23) Retained pre-impact position
- (24) Moved to upright position
- (25) Moved to slightly forward position
- (26) Moved to forward midrange position
- (27) Moved to completely forward position

*Completely reclined prior to impact*

- (31) Retained pre-impact position
- (32) Moved to rearward midrange position
- (33) Moved to slightly rearward position
- (34) Moved to upright position
- (35) Moved to slightly forward position
- (36) Moved to forward midrange position
- (37) Moved to completely forward position
- (99) Unknown

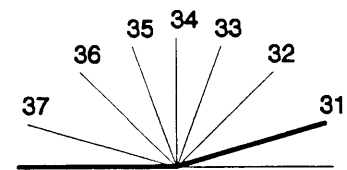
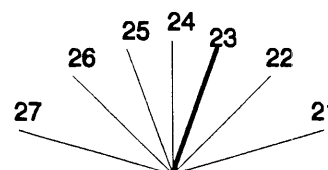
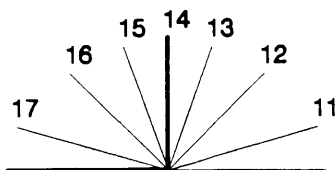
Coding diagrams for *Seat Back Incline Position Prior and Post Impact*

**DESCRIBE ANY INDICATION OF ABNORMAL OCCUPANT POSTURE  
(I.E., UNUSUAL OCCUPANT CONTACT PATTERN)**

## CHILD SAFETY SEAT FIELD ASSESSMENT

When a child safety seat is present enter the occupant's number in the first row and complete the column below the occupant's number using the codes listed below. Complete a column for each child safety seat present.

Occupant Number	NA					
1. Type of Child Safety Seat	0					
2. Child Safety Seat Orientation	00					
3. Child Safety Seat Harness Usage	00					
4. Child Safety Seat Shield Usage	00					
5. Child Safety Seat Tether Usage	00					
6. Child Safety Seat Make/Model	NA	Specify Below for Each Child Safety Seat				

1. Type of Child Safety Seat
  - (0) No child safety seat
  - (1) Infant seat
  - (2) Toddler seat
  - (3) Convertible seat
  - (4) Booster seat
  - (7) Other type child safety seat (specify):  
\_\_\_\_\_
  - (8) Unknown child safety seat type
  - (9) Unknown if child safety seat used
  
2. Child Safety Seat Orientation
  - (00) No child safety seat
  - Designed for Rear Facing for This Age/Weight
    - (01) Rear facing
    - (02) Forward facing
    - (08) Other orientation (specify):  
\_\_\_\_\_
    - (09) Unknown orientation
  - Designed for Forward Facing for This Age/Weight
    - (11) Rear facing
    - (12) Forward facing
    - (18) Other orientation (specify):  
\_\_\_\_\_
    - (19) Unknown orientation
  - Unknown Design or Orientation For This Age/Weight, or Unknown Age/Weight
    - (21) Rear facing
    - (22) Forward facing
    - (28) Other orientation (specify):  
\_\_\_\_\_
    - (29) Unknown orientation
  - (99) Unknown if child safety seat used
  
3. Child Safety Seat Harness Usage

4. Child Safety Seat Shield Usage
  
5. Child Safety Seat Tether Usage
  - Note: Options Below Are Used for Variables 3-5.
  - (00) No child safety seat
  - Not Designed with Harness/Shield/Tether
    - (01) After market harness/shield/tether added, not used
    - (02) After market harness/shield/tether used
    - (03) Child safety seat used, but no after market harness/shield/tether added
    - (09) Unknown if harness/shield/tether added or used
  - Designed With Harness/Shield/Tether
    - (11) Harness/shield/tether not used
    - (12) Harness/shield/tether used
    - (19) Unknown if harness/shield/tether used
  - Unknown If Designed With Harness/Shield/Tether
    - (21) Harness/shield/tether not used
    - (22) Harness/shield/tether used
    - (29) Unknown if harness/shield/tether used
  - (99) Unknown if child safety seat used
  
6. Child Safety Seat Make/Model
  - (Specify make/model and occupant number)
  - \_\_\_\_\_
  - \_\_\_\_\_
  - \_\_\_\_\_
  - \_\_\_\_\_



### EJECTION/ENTRAPMENT DATA

Complete the following if the researcher has any indication that an occupant was either ejected from or entrapped in the vehicle. Code the appropriate data on the Occupant Assessment Form.

**EJECTION**      No []      Yes [  ]

Describe indications of ejection and body parts involved in partial ejection(s):

---



---



---



---

Occupant Number						
Ejection						
(Note on Vehicle Interior Sketch) Ejection Area						
Ejection Medium						
Medium Status						

<p><b>Ejection</b></p> <p>(1) Complete ejection                  (2) Partial ejection                  (3) Ejection, Unknown degree                  (9) Unknown</p> <p><b>Ejection Area</b></p> <p>(1) Windshield                  (2) Left front                  (3) Right front                  (4) Left rear                  (5) Right rear                  (6) Rear</p>	<p>(7) Roof                  (8) Other area (e.g., back of pickup, etc.) (specify):                  _____                  (9) Unknown</p> <p><b>Ejection Medium</b></p> <p>(1) Door/hatch/tailgate                  (2) Nonfixed roof structure                  (3) Fixed glazing                  (4) Nonfixed glazing (specify):                  _____</p>	<p>(5) Integral structure                  (8) Other medium (specify):                  _____                  (9) Unknown</p> <p><b>Medium Status (Immediately Prior to Impact)</b></p> <p>(1) Open                  (2) Closed                  (3) Integral structure                  (9) Unknown</p>
--	--	---

**ENTRAPMENT**      No []      Yes [  ]

Describe entrapment mechanism: \_\_\_\_\_

---



---



---

Component(s): \_\_\_\_\_

(Note in vehicle interior diagram)



# OCCUPANT ASSESSMENT FORM

1. Primary Sampling Unit Number 02  
 2. Case Number - Stratum 140A  
 3. Vehicle Number 01  
 4. Occupant Number 01

## OCCUPANT'S CHARACTERISTICS

5. Occupant's Age 66  
 Code actual age at time of accident.  
 (00) Less than one year old (specify by month): \_\_\_\_\_  
 (97) 97 years and older  
 (99) Unknown

6. Occupant's Sex 1  
 (1) Male  
 (2) Female-not reported pregnant  
 (3) Female-pregnant-1st trimester(1st-3rd month)  
 (4) Female-pregnant-2nd trimester(4th-6th month)  
 (5) Female-pregnant-3rd trimester(7th-9th month)  
 (6) Female-pregnant-term unknown  
 (9) Unknown

7. Occupant's Height 168  
 Code actual height to the nearest centimeter.  
 (999) Unknown  
66 inches X 2.54 = 167.8 centimeters 093

8. Occupant's Weight 999  
 Code actual weight to the nearest kilogram.  
 (999)Unknown  
206 pounds X .4536 = 093 kilograms

9. Occupant's Role 1  
 (1) Driver  
 (2) Passenger  
 (9) Unknown

## OCCUPANT'S SEATING

10. Occupant's Seat Position 11  
*Front Seat*  
 (11) Left side  
 (12) Middle  
 (13) Right side  
 (14) Other (specify): \_\_\_\_\_  
 (15) On or in the lap of another occupant

*Second Seat*  
 (21) Left side  
 (22) Middle  
 (23) Right side  
 (24) Other (specify): \_\_\_\_\_  
 (25) On or in the lap of another occupant

*Third Seat*  
 (31) Left side  
 (32) Middle  
 (33) Right side  
 (34) Other (specify): \_\_\_\_\_  
 (35) On or in the lap of another occupant

*Fourth Seat*  
 (41) Left side  
 (42) Middle  
 (43) Right side  
 (44) Other (specify): \_\_\_\_\_  
 (45) On or in the lap of another occupant

(97) In or on unenclosed area  
 (98) Other seat (specify): \_\_\_\_\_  
 (99) Unknown

11. Occupant's Posture 9  
 (0) Normal posture

*Abnormal posture*  
 (1) Kneeling or standing on seat  
 (2) Lying on or across seat  
 (3) Kneeling, standing or sitting in front of seat  
 (4) Sitting sideways or turned to talk with another occupant or to look out a rear window  
 (5) Sitting on a console  
 (6) Lying back in a reclined seat position  
 (7) Bracing with feet or hands on a surface in front of seat  
 (8) Other abnormal posture (specify): \_\_\_\_\_  
 (9) Unknown

**EJECTION/ENTRAPMENT**

12. Ejection 0

- (0) No ejection
- (1) Complete ejection
- (2) Partial ejection
- (3) Ejection, unknown degree
- (9) Unknown

13. Ejection Area 0

- (0) No ejection
- (1) Windshield
- (2) Left front
- (3) Right front
- (4) Left rear
- (5) Right rear
- (6) Rear
- (7) Roof
- (8) Other area (e.g., back of pickup, etc.)  
(specify): \_\_\_\_\_
- (9) Unknown

14. Ejection Medium 0

- (0) No ejection
- (1) Door/hatch/tailgate
- (2) Nonfixed roof structure
- (3) Fixed glazing
- (4) Nonfixed glazing (specify): \_\_\_\_\_
- (5) Integral structure
- (8) Other medium (specify): \_\_\_\_\_
- (9) Unknown

15. Medium Status (Immediately Prior To Impact) 0

- (0) No ejection
- (1) Open
- (2) Closed
- (3) Integral structure
- (9) Unknown

16. Entrapment 0

- (0) Not entrapped/exit not inhibited
- (1) Entrapped/pinned - mechanically restrained
- (2) Could not exit vehicle due to jammed doors, fire, etc.  
(specify): \_\_\_\_\_
- (9) Unknown

17. Occupant Mobility 9

- (0) Occupant fatal before removed from vehicle
- (1) Removed from vehicle while unconscious or disoriented
- (2) Removed from vehicle due to injuries
- (3) Exited vehicle with some assistance
- (4) Exited vehicle under own power
- (5) Occupant fully ejected
- (9) Unknown

*Nephew pulled from car -  
unknown if he was  
still alive or not -  
drove to house to  
call for help.*

## BELT SYSTEM FUNCTION

18. Manual (Active) Belt System Availability 94

- (0) None available
- (1) Belt removed/destroyed
- (2) Shoulder belt
- (3) Lap belt
- (4) Lap and shoulder belt
- (5) Belt available—type unknown

*Integral Belt Partially Destroyed*

- (6) Shoulder belt (lap belt destroyed/removed)
- (7) Lap belt (shoulder belt destroyed/removed)
- (8) Other belt (specify):

(9) Unknown

19. Manual (Active) Belt System Use 99

- (00) None used, not available, or belt removed/destroyed
- (01) Inoperative (specify):

- (02) Shoulder belt
- (03) Lap belt
- (04) Lap and shoulder belt
- (05) Belt used—type unknown
- (08) Other belt used (specify):

- (12) Shoulder belt used with child safety seat
- (13) Lap belt used with child safety seat
- (14) Lap and shoulder belt used with child safety seat
- (15) Belt used with child safety seat—type unknown
- (18) Other belt used with child safety seat (specify):
- (99) Unknown if belt used

20. Proper Use of Manual (Active) Belts 9

- (0) None used or not available
- (1) Belt used properly
- (2) Belt used properly with child safety seat

*Belt Used Improperly*

- (3) Shoulder belt worn under arm
- (4) Shoulder belt worn behind back or seat
- (5) Belt worn around more than one person
- (6) Lap belt worn on abdomen
- (7) Lap belt or lap and shoulder belt used improperly with child safety seat (specify):

(8) Other improper use of manual belt system (specify):

(9) Unknown

21. Manual (Active) Belt Failure Modes During Accident 9

- (0) No manual belt used or not available
- (1) No manual belt failure(s)
- (2) Torn webbing (stretched webbing not included)
- (3) Broken buckle or latchplate
- (4) Upper anchorage separated
- (5) Other anchorage separated (specify):

(6) Broken retractor

(7) Combination of above (specify):

(8) Other manual belt failure (specify):

(9) Unknown

22. Shoulder Belt Upper Anchorage Adjustment 3

- (0) No shoulder belt
- (1) No upper anchorage adjustment for shoulder belt

*Adjustable shoulder Belt Upper Anchorage* See slides

- (2) In full up position
- (3) In mid position
- (4) In full down position
- (5) Position unknown
- (9) Unknown if position has adjustable upper anchorage adjustment

23. Automatic (Passive) Belt System Availability/Function 0

- (0) Not equipped/not available
- (1) 2 point automatic belts
- (2) 3 point automatic belts
- (3) Automatic belts - type unknown

*Non-functional*

- (4) Automatic belts destroyed or rendered inoperative
- (9) Unknown

24. Automatic (Passive) Belt System Use 0

- (0) Not equipped/not available/destroyed or rendered inoperative
- (1) Automatic belt in use
- (2) Automatic belt not in use (manually disconnected, motorized track inoperative) (specify):
- (3) Automatic belt use unknown
- (9) Unknown

25. Automatic (Passive) Belt System Type 0

- (0) Not equipped/not available
- (1) Non-motorized system
- (2) Motorized system
- (9) Unknown

26. Proper Use of Automatic (Passive) Belt System 0

- (0) Not equipped/not available/not used
- (1) Automatic belt used properly
- (2) Automatic belt used properly with child safety seat

*Automatic Belt Used Improperly*

- (3) Automatic shoulder belt worn under arm
- (4) Automatic shoulder belt worn behind back
- (5) Automatic belt worn around more than one person
- (6) Lap portion of automatic belt worn on abdomen
- (7) Automatic lap and shoulder belt or automatic shoulder belt used improperly with child safety seat (specify):

(8) Other improper use of automatic belt system (specify):

(9) Unknown

27. Automatic (Passive) Belt Failure Modes During Accident 0

- (0) Not equipped/not available/not in use
- (1) No automatic belt failure(s)
- (2) Torn webbing (stretched webbing not included)
- (3) Broken buckle or latchplate
- (4) Upper anchorage separated
- (5) Other anchorage separated (specify):

(6) Broken retractor

(7) Combination of above (specify):

(8) Other automatic belt failure (specify):

(9) Unknown

POLICE REPORTED RESTRAINT USE	AIR BAG SYSTEM FUNCTION
<p>28. Police Reported Belt Use <span style="float: right; border-bottom: 1px solid black; width: 30px; text-align: center;">0</span></p> <p>(0) None used                      (1) Police did not indicate belt use                      (2) Shoulder belt                      (3) Lap belt                      (4) Lap and shoulder belt                      (5) Belt used, type not specified                      (6) Child safety seat                      (7) Automatic belt                      (8) Other type belt, (specify):                      _____                      (9) Police indicated "unknown"</p>	<p>30. Frontal Air Bag System Availability/Function (This Occupant Position) <span style="float: right; border-bottom: 1px solid black; width: 30px; text-align: center;">1</span></p> <p>(0) Not equipped/not available                      (1) Air bag</p> <p><i>Non-functional</i>                      (2) Air bag disconnected (specify):                      _____                      (3) Air bag not reinstalled                      (9) Unknown</p>
<p>29. Police Reported Air Bag Availability/Function <span style="float: right; border-bottom: 1px solid black; width: 30px; text-align: center;">0</span></p> <p>(0) No air bag available                      (1) Police did not indicate air bag availability/function                      (2) Deployed                      (3) Not deployed                      (4) Unknown if deployed                      (9) Police indicated "unknown"</p>	<p>31. Frontal Air Bag System Deployment (This Occupant Position) <span style="float: right; border-bottom: 1px solid black; width: 30px; text-align: center;">5</span></p> <p>(0) Not equipped/not available                      (1) Deployed during accident (as a result of impact)                      (2) Deployed inadvertently just prior to accident                      (3) Deployed, details unknown                      (4) Deployed as a result of a noncollision event during accident sequence (e.g., fire, explosion, electrical)                      (5) Unknown if deployed                      (7) Nondeployed                      (9) Unknown</p>
<p>Check the Primary Source Used In Determining Belt Use.</p> <p><input type="checkbox"/> Not equipped/not available/destroyed or rendered inoperative  <input type="checkbox"/> Vehicle inspection  <input type="checkbox"/> Official injury data  <input type="checkbox"/> Driver/occupant interview  <input type="checkbox"/> Other (specify):                      _____  <input checked="" type="checkbox"/> Unknown if belt used                      _____                      _____                      _____</p>	<p>32. Other Than First Seat Frontal Air Bag Availability/Function (This Occupant Position) <span style="float: right; border-bottom: 1px solid black; width: 30px; text-align: center;">0</span></p> <p>(0) Not equipped/not available                      (1) Air bag</p> <p><i>Non-functional</i>                      (2) Air bag disconnected (specify):                      _____                      (3) Air bag not reinstalled                      (9) Unknown</p> <p><i>Specify type of "other" air bag present:</i>                      _____</p>
	<p>33. Air Bag(s) Deployment, Other Than First Seat Frontal (This Occupant Position) <span style="float: right; border-bottom: 1px solid black; width: 30px; text-align: center;">0</span></p> <p>(0) Not equipped with an "other" air bag                      (1) Deployed during accident (as a result of impact)                      (2) Deployed inadvertently just prior to accident                      (3) Deployed, details unknown                      (4) Deployed as a result of a noncollision event during accident sequence (e.g., fire, explosion, electrical)                      (5) Unknown if deployed                      (7) Nondeployed                      (9) Unknown</p>
	<p>34. Are There Indications of Air Bag System Failure? (This Occupant Position) <span style="float: right; border-bottom: 1px solid black; width: 30px; text-align: center;">9</span></p> <p>(0) Not equipped/not available                      (1) No                      (2) Yes (specify):                      _____                      (9) Unknown</p>

## FIRST SEAT FRONTAL AIR BAG SYSTEM EVALUATION

35. Had Vehicle Been in Previous Accident(s)? 9

- (0) Not equipped/not available  
 (1) No previous accidents

Yes

- (2) Previous accident(s) without deployment(s)  
 (3) One previous accident with deployment  
 (4) More than one previous accident with at least one deployment  
 (8) Previous accidents, unknown deployment status  
 (9) Unknown

36. Type of Air Bag 9X

- (0) Not equipped/not available  
 (1) Original manufacturer installed system  
 (2) Retrofitted air bag  
 (3) Replacement air bag  
 (8) Unknown type of air bag  
 (9) Unknown

37. Had Any Prior Maintenance/Service Been Performed On This Air Bag System? 9X

- (0) Not equipped/not available  
 (1) No prior maintenance  
 (2) Yes, prior maintenance (specify): \_\_\_\_\_

(9) Unknown

38. Air Bag Deployment Accident Event Sequence Number 98

- (00) Not equipped/not available  
 \_\_\_\_\_ Code the accident event sequence number that initiated the air bag deployment  
 (96) Deployed, unknown event  
 (97) Not deployed  
 (98) Unknown if deployed  
 (99) Unknown

39. CDC For Air Bag Deployment Impact 8

- (0) Not equipped/not available  
 (1) Highest delta V  
 (2) Second highest delta V  
 (3) Other non-coded delta V (specify): \_\_\_\_\_

- (6) Deployed, unknown event  
 (7) Not deployed  
 (8) Unknown if deployed  
 (9) Unknown

40. Longitudinal Component of Delta V For Air Bag + 998

Deployment Impact

(\_000) Not equipped/not available  
*Code the value of the delta V for the impact that initiated the air bag deployment*

- (\_996) Deployment, unknown longitudinal Delta V  
 (\_997) Not deployed  
 (\_998) Unknown if deployed  
 (\_999) Unknown

41. Did Air Bag Module Cover Flap(s) Open At Designated Tear Points? 8

- (0) Not equipped/not available  
 (1) No  
 (2) Yes  
 (3) Deployed, unknown if flap(s) opened at designated tear points  
 (7) Not deployed  
 (8) Unknown if deployed  
 (9) Unknown

42. Were Air Bag Module Cover Flap(s) Damaged? 8

- (0) Not equipped/not available  
 (1) No  
 (2) Yes (specify): \_\_\_\_\_  
 (3) Deployed, unknown if air bag module cover flap(s) damaged  
 (7) Not deployed  
 (8) Unknown if deployed  
 (9) Unknown

43. Was There Damage To The Air Bag? 98

- (00) Not equipped/not available  
 (01) Not damaged

Yes - Air Bag Damage

- (02) Ruptured  
 (03) Cut  
 (04) Torn  
 (05) Holed  
 (06) Burned  
 (07) Abraded  
 (88) Other damage (specify): \_\_\_\_\_

- (95) Damaged, details unknown  
 (96) Deployed, unknown if damaged  
 (97) Not deployed  
 (98) Unknown if deployed  
 (99) Unknown

**FIRST SEAT FRONTAL AIR BAG SYSTEM  
EVALUATION** *continued***HEAD RESTRAINT AND SEAT EVALUATION**

44. Source of Air Bag Damage 98  
 (00) Not equipped/not available  
 (01) Not damaged  
 (02) Object worn by occupant, (specify):  
 \_\_\_\_\_  
 (03) Object carried by occupant, (specify):  
 \_\_\_\_\_  
 (04) Adaptive/assistive controls, (specify):  
 \_\_\_\_\_  
 (05) Fire in vehicle  
 (06) Thermal burns  
 (07) Rescue or emergency efforts  
 (88) Other damage source (specify):  
 \_\_\_\_\_  
 (95) Damaged, unknown source  
 (96) Deployed, unknown if damaged  
 (97) Not deployed  
 (98) Unknown if deployed  
 (99) Unknown
45. Was The Air Bag Tethered? 8  
 (0) Not equipped/not available  
 (1) No  
 (2) Yes (specify number of tether straps):  
 \_\_\_\_\_  
 (3) Deployed, unknown if tethered  
 (7) Not deployed  
 (8) Unknown if deployed  
 (9) Unknown
46. Did The Air Bag Have Vent Ports? 8  
 (0) Not equipped/not available  
 (1) No  
 (2) Yes (specify number of vent ports):  
 \_\_\_\_\_  
 (3) Deployed, unknown if vent ports present  
 (7) Not deployed  
 (8) Unknown if deployed  
 (9) Unknown
47. Was the Air Bag in this Occupant's Position Contacted by Another Occupant? 8  
 (0) Not equipped/not available  
 (1) No ✓  
 (2) Yes (specify):  
 \_\_\_\_\_  
 (3) Deployed, unknown if other occupant contact to air bag  
 (7) Not deployed  
 (8) Unknown if deployed  
 (9) Unknown
48. Was This Occupant Wearing Eye-wear? 8  
 (0) Not equipped/not available  
 (1) No  
 (2) Eyeglasses/sunglasses ✓  
 (3) Contact lenses  
 (4) Deployed, unknown if eyewear worn  
 (7) Not deployed  
 (8) Unknown if deployed  
 (9) Unknown

49. Head Restraint Type/Damage by Occupant at This Occupant Position 9  
 (0) No head restraints  
 (1) Integral—no damage  
 (2) Integral—damaged during accident  
 (3) Adjustable—no damage  
 (4) Adjustable—damaged during accident  
 (5) Add-on—no damage  
 (6) Add-on—damaged during accident  
 (8) Other (specify):  
 \_\_\_\_\_  
 (9) Unknown
50. Seat Type (this Occupant Position) 01  
 (00) Occupant not seated or no seat  
 (01) Bucket  
 (02) Bucket with folding back  
 (03) Bench  
 (04) Bench with separate back cushions  
 (05) Bench with folding back(s)  
 (06) Split bench with separate back cushions  
 (07) Split bench with folding back(s)  
 (08) Pedestal (i.e., column supported)  
 (09) Box mounted seat (i.e., van type)  
 (10) Other seat type (specify):  
 \_\_\_\_\_  
 (99) Unknown
51. Seat Orientation (this Occupant Position) 1  
 (0) Occupant not seated or no seat  
 (1) Forward facing seat  
 (2) Rear facing seat  
 (3) Side facing seat (inward)  
 (4) Side facing seat (outward)  
 (8) Other (specify):  
 \_\_\_\_\_  
 (9) Unknown
52. Seat Track Adjusted Position Prior To Impact 6  
 (0) Occupant not seated or no seat  
 (1) Non-adjustable seat track
- Adjustable Seat Track*  
 (2) Seat at forward most track position  
 (3) Seat between forward most and middle track positions  
 (4) Seat at middle track position  
 (5) Seat between middle and rear most track positions  
 (6) Seat at rear most track position  
 (9) Unknown

**HEAD RESTRAINT AND SEAT EVALUATION** *continued*53. Seat Back Incline Prior and Post Impact 99

- (00) Occupant not seated or no seat  
 (01) Not adjustable

*Upright prior to impact*

- (11) Moved to completely rearward position  
 (12) Moved to rearward midrange position  
 (13) Moved to slightly rearward position  
 (14) Retained pre-impact position  
 (15) Moved to slightly forward position  
 (16) Moved to forward midrange position  
 (17) Moved to completely forward position

*Slightly reclined prior to impact*

- (21) Moved to completely rearward position  
 (22) Moved to rearward midrange position  
 (23) Retained pre-impact position  
 (24) Moved to upright position  
 (25) Moved to slightly forward position  
 (26) Moved to forward midrange position  
 (27) Moved to completely forward position

*Completely reclined prior to impact*

- (31) Retained pre-impact position  
 (32) Moved to rearward midrange position  
 (33) Moved to slightly rearward position  
 (34) Moved to upright position  
 (35) Moved to slightly forward position  
 (36) Moved to forward midrange position  
 (37) Moved to completely forward position

(99) Unknown

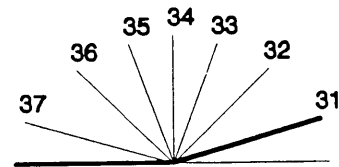
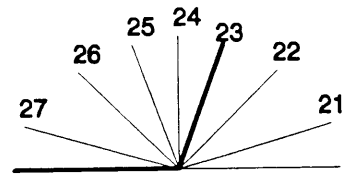
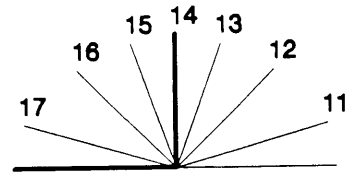
54. Seat Performance (this Occupant Position) 5

- (0) Occupant not seated or no seat  
 (1) No seat performance failure(s)  
 (2) Seat adjusters failed  
 (3) Seat back folding locks or "seat back" failed (specify): \_\_\_\_\_  
 (4) Seat track/anchors failed  
 (5) Deformed by impact of occupant  
 (6) Deformed by passenger compartment intrusion, (specify): \_\_\_\_\_  
 (7) Combination of above (specify): \_\_\_\_\_  
 (8) Other (specify): \_\_\_\_\_  
 (9) Unknown



## CHILD SAFETY SEAT

55. Child Safety Seat Make/Model 0 0 0  
 (000) No child safety seat  
 Applicable codes are found in your NASS CDS  
 Data Collection, Coding and Editing  
 (950) Built-in child safety seat  
 (997) Other make/model (specify):  
 \_\_\_\_\_  
 (998) Unknown make/model  
 (999) Unknown if child safety seat used

56. Type of Child Safety Seat 0  
 (0) No child safety seat  
 (1) Infant seat  
 (2) Toddler seat  
 (3) Convertible seat  
 (4) Booster seat - with shield  
 (5) Booster seat - without shield  
 (7) Other type child safety seat (specify):  
 \_\_\_\_\_  
 (8) Unknown child safety seat type  
 (9) Unknown if child safety seat used

57. Child Safety Seat Orientation 0 0  
 (00) No child safety seat  
  
*Designed for Rear Facing for This Age/Weight*  
 (01) Rear facing  
 (02) Forward facing  
 (08) Other orientation (specify):  
 \_\_\_\_\_  
 (09) Unknown orientation  
  
*Designed For Forward Facing for This Age/Weight*  
 (11) Rear facing  
 (12) Forward facing  
 (18) Other orientation (specify):  
 \_\_\_\_\_  
 (19) Unknown orientation  
  
*Unknown Design or Orientation For This  
 Age/Weight, or Unknown Age/Weight*  
 (21) Rear facing  
 (22) Forward facing  
 (28) Other orientation (specify):  
 \_\_\_\_\_  
 (29) Unknown orientation  
  
 (99) Unknown if child safety seat used

58. Child Safety Seat Harness Usage 0 0

59. Child Safety Seat Shield Usage 0 0

60. Child Safety Seat Tether Usage 0 0

Note: Options below applicable to  
 Variables OA58-OA60.

(00) No child safety seat

*Not Designed With Harness/Shield/Tether*

(01) After market harness/shield/tether  
 added, not used

(02) After market harness/shield/tether used

(03) Child safety seat used, but no after market  
 harness/shield/tether added

(09) Unknown if harness/shield/tether  
 added or used

*Designed With Harness/Shield/Tether*

(11) Harness/shield/tether not used

(12) Harness/shield/tether used

(19) Unknown if harness/shield/tether used

*Unknown If Designed With Harness/Shield/Tether*

(21) Harness/shield/tether not used

(22) Harness/shield/tether used

(29) Unknown if harness/shield/tether used

(99) Unknown if child safety seat used

**INJURY CONSEQUENCES**61. Injury Severity (Police Rating) 4

- (0) O - No injury
- (1) C - Possible injury
- (2) B - Nonincapacitating injury
- (3) A - Incapacitating injury
- (4) K - Killed
- (5) U - Injury, severity unknown
- (6) Died prior to accident
- (9) Unknown

62. Treatment - Mortality 1

- (0) No treatment
- (1) Fatal
- (2) Fatal - ruled disease (specify):  
\_\_\_\_\_

*Nonfatal*

- (3) Hospitalization
- (4) Transported and released
- (5) Treatment at scene - nontransported
- (6) Treatment later
- (7) Treatment - other (specify):  
\_\_\_\_\_
- (8) Transported to a medical facility-unknown if treated
- (9) Unknown

63. Type Of Medical Facility (for Initial Treatment) 0

- (0) Not treated at a medical facility
- (1) Trauma center
- (2) Hospital
- (3) Medical clinic
- (4) Physician's office
- (5) Treatment later at medical facility
- (8) Other (specify):  
\_\_\_\_\_
- (9) Unknown

64. Hospital Stay 00

- (00) Not Hospitalized  
\_\_\_\_\_ Code the number of days (up through 60)  
that the occupant stayed in hospital.
- (61) 61 days or more
- (99) Unknown

65. Working Days Lost 62

- \_\_\_\_\_ Code the number of days  
(up through 60) that the occupant  
lost from work due to the accident
- (00) No working days lost
- (61) 61 days or more
- (62) Fatally injured
- (97) Not working prior to accident
- (99) Unknown

**STOP WORK HERE****VARIABLES 66-74****TO BE CODED BY THE ZONE CENTER**

**TO BE CODED BY THE ZONE CENTER****INJURY CONSEQUENCES****TRAUMA DATA**

66. Time to Death 01  
 \_\_\_\_\_ Code number of hours from time of accident to time of death up through 24 hours. If time of death is greater than 24 hours, code number of days. (Note: 1 day = 31, 2 days = 32, ... n days = 30 + n up through 30 days = 60)  
 (00) Not fatal  
 (96) Fatal - ruled disease  
 (99) Unknown

67. 1st Medically Reported Cause of Death 06

68. 2nd Medically Reported Cause of Death 60

69. 3rd Medically Reported Cause of Death 60

\_\_\_\_\_ Code the Occupant Injury from line number(s) for the medically reported injury(s) which reportedly contributed to this occupant's death  
 (00) Not fatal or no additional causes  
 (96) Mode of death given but specific injuries are not linked to cause of death. (specify):

(97) Other result (includes fatal ruled disease) (specify):

(99) Unknown

70. Number of Recorded Injuries for This Occupant 09

\_\_\_\_\_ Code the actual number of injuries recorded for this occupant.  
 (00) No recorded injuries  
 (97) Injured, details unknown  
 (99) Unknown if injured

71. Glasgow Coma Scale (GCS) Score 01  
 (at Medical Facility)  
 (00) Not injured  
 (01) Injured - not treated at medical facility  
 (02) No GCS Score at medical facility  
 (03-15) Code the actual value of the initial GCS Score recorded at medical facility.  
 (97) Injured, details unknown  
 (99) Unknown if injured

72. Was the Occupant Given Blood? 1  
 (1) No - blood not given  
 (2) Yes - blood given (specify units): \_\_\_\_\_  
 (9) Unknown if blood given

73. Arterial Blood Gases (ABG) - HCO<sub>3</sub> 01  
 (00) Not injured  
 (01) Injured, ABGs not measured or reported  
 (02-50) Code the actual value of the HCO<sub>3</sub>  
 (96) ABGs reported, HCO<sub>3</sub> unknown  
 (97) Injured, details unknown  
 (99) Unknown if injured

**BELT USE DETERMINATION**

74. Primary Source of Belt Use Determination 9  
 (0) Not equipped/not available/destroyed or rendered inoperative  
 (1) Vehicle inspection  
 (2) Official injury data  
 (3) Driver/occupant interview  
 (8) Other (specify): \_\_\_\_\_  
 (9) Unknown if belt used



# OCCUPANT INJURY FORM

1. Primary Sampling Unit Number <u>02</u>	3. Vehicle Number <u>01</u>
2. Case Number - Stratum <u>140 A</u>	4. Occupant Number <u>01</u>

## INJURY DATA

Record below the actual injuries sustained by this occupant that were identified from the official and unofficial data sources. Remember not to double count an injury just because it was identified from two different sources. If greater than ten injuries have been documented, encode the balance on the Occupant Injury Supplement.

Source of Injury Data	A.I.S. - 90						Injury Source	Injury Source Confidence Level	Direct/ Indirect Injury	Occupant Area Intrusion Number		
	Body Region	Type of Anatomic Structure	Specific Anatomic Structure	Level of Injury	A.I.S. Severity	Aspect						
<i>① face abr</i>	1st	5. <u>1</u>	6. <u>2</u>	7. <u>9</u>	8. <u>02</u>	9. <u>02</u>	10. <u>1</u>	11. <u>2</u>	12. <u>004</u>	13. <u>3</u>	14. <u>1</u>	15. <u>00</u>
<i>lip abe</i>	2nd	16. <u>1</u>	17. <u>2</u>	18. <u>9</u>	19. <u>02</u>	20. <u>02</u>	21. <u>1</u>	22. <u>8</u>	23. <u>004</u>	24. <u>3</u>	25. <u>1</u>	26. <u>00</u>
<i>subdural hem</i>	3rd	27. <u>1</u>	28. <u>1</u>	29. <u>4</u>	30. <u>06</u>	31. <u>52</u>	32. <u>4</u>	33. <u>2</u>	34. <u>004</u>	35. <u>3</u>	36. <u>1</u>	37. <u>0</u>
<i>skt ft</i>	4th	38. <u>1</u>	39. <u>4</u>	40. <u>5</u>	41. <u>02</u>	42. <u>32</u>	43. <u>4</u>	44. <u>3</u>	45. <u>006</u>	46. <u>2</u>	47. <u>1</u>	48. <u>00</u>
<i>pericardium lac</i>	5th	49. <u>1</u>	50. <u>4</u>	51. <u>4</u>	52. <u>16</u>	53. <u>02</u>	54. <u>2</u>	55. <u>4</u>	56. <u>006</u>	57. <u>2</u>	58. <u>1</u>	59. <u>00</u>
<i>heart fac</i>	6th	60. <u>4</u>	61. <u>4</u>	62. <u>4</u>	63. <u>10</u>	64. <u>16</u>	65. <u>6</u>	66. <u>4</u>	67. <u>006</u>	68. <u>2</u>	69. <u>1</u>	70. <u>00</u>
<i>liver lac</i>	7th	71. <u>1</u>	72. <u>5</u>	73. <u>4</u>	74. <u>18</u>	75. <u>26</u>	76. <u>4</u>	77. <u>1</u>	78. <u>006</u>	79. <u>2</u>	80. <u>1</u>	81. <u>00</u>
<i>T2 thoracic br</i>	8th	82. <u>1</u>	83. <u>6</u>	84. <u>5</u>	85. <u>04</u>	86. <u>16</u>	87. <u>2</u>	88. <u>7</u>	89. <u>006</u>	90. <u>2</u>	91. <u>2</u>	92. <u>00</u>
<i>T3 br</i>	9th	93. <u>1</u>	94. <u>6</u>	95. <u>5</u>	96. <u>04</u>	97. <u>16</u>	98. <u>2</u>	99. <u>7</u>	100. <u>006</u>	101. <u>2</u>	102. <u>2</u>	103. <u>00</u>
	10th	104. <u>  </u>	105. <u>  </u>	106. <u>  </u>	107. <u>  </u>	108. <u>  </u>	109. <u>  </u>	110. <u>  </u>	111. <u>  </u>	112. <u>  </u>	113. <u>  </u>	114. <u>  </u>



**OCCUPANT INJURY CLASSIFICATION**

Body Region	Specific Anatomic Structure	Level of Injury	Aspect
(1) Head (2) Face (3) Neck (4) Thorax (5) Abdomen (6) Spine (7) Upper Extremity (8) Lower Extremity (9) Unspecified	<u>Vessels, Nerves, Organs.</u> <u>Bones, Joints</u> are assigned consecutive two digit numbers beginning with 02.  The exceptions to this rule apply to:	Specific injuries are assigned consecutive two-digit numbers beginning with 02.  To the extent possible, within the organizational framework of the AIS, 00 is assigned to an injury NFS as to severity or where only one injury is given in the dictionary for that anatomic structure. 99 is assigned to any injury NFS as to lesion or severity.	(1) Right (2) Left (3) Bilateral (4) Central (5) Anterior (6) Posterior (7) Superior (8) Inferior (9) Unknown (0) Whole region
<b>Type of Anatomic Structure</b>	<u>Whole Area</u> (02) Skin - Abrasion (04) Skin - Contusion (06) Skin - Laceration (08) Skin - Avulsion (10) Amputation (20) Burn (30) Crush (40) Degloving (50) Injury - NFS (90) Trauma, other than mechanical  <u>Head - LOC</u> (02) Length of LOC  (04) Level (06) of (08) Consciousness  (10) Concussion  <u>Spine</u> (02) Cervical (04) Thoracic (06) Lumbar	<b>Abbreviated Injury Scale</b>  (1) Minor Injury (2) Moderate Injury (3) Serious Injury (4) Severe Injury (5) Critical Injury (6) Maximum (untreatable) (7) Injured, unknown severity	

SOURCE OF INJURY DATA	INJURY SOURCE CONFIDENCE LEVEL	DIRECT/INDIRECT INJURY
<u>OFFICIAL RECORDS</u> (1) Autopsy records with or without hospital/medical records (2) Hospital/medical records other than emergency room (e.g., discharge summary) (3) Emergency room records only (including associated X-rays or other lab reports) (4) Private physician, walk-in or emergency clinic  <u>UNOFFICIAL RECORDS</u> (5) Lay coroner report (6) E.M.S. personnel (7) Interviewee (8) Other source (specify): _____ (9) Police	(1) Certain (2) Probable (3) Possible (9) Unknown	(1) Direct contact injury (2) Indirect contact injury (3) Noncontact injury (7) Injured, unknown source

## INJURY SOURCES

### FRONT

- (001) Windshield
- (002) Mirror
- (003) Sunvisor
- (004) Steering wheel rim
- (005) Steering wheel hub/spoke
- (006) Steering wheel (combination of codes 004 and 005)
- (007) Steering column, transmission selector lever, other attachment
- (008) Cellular telephone or CB radio
- (009) Add on equipment (e.g., tape deck, air conditioner)
- (010) Left instrument panel and below
- (011) Center instrument panel and below
- (012) Right instrument panel and below
- (013) Glove compartment door
- (014) Knee bolster
- (015) Windshield including one or more of the following: front header, A (A1/A2)-pillar, instrument panel, mirror, or steering assembly (driver side only)
- (016) Windshield including one or more of the following: front header, A (A1/A2)-pillar, instrument panel, or mirror (passenger side only)
- (017) Windshield reinforced by exterior object (specify):

(019) Other front object (specify): \_\_\_\_\_

### LEFT SIDE

- (051) Left side interior surface, excluding hardware or armrests
- (052) Left side hardware or armrest
- (053) Left A (A1/A2)-pillar
- (054) Left B-pillar
- (055) Other left pillar (specify): \_\_\_\_\_
- (056) Left side window glass
- (057) Left side window frame
- (058) Left side window sill
- (059) Left side window glass including one or more of the following: frame, window sill, A (A1/A2)-pillar, B-pillar, or roof side rail.
- (060) Other left side object (specify): \_\_\_\_\_

### RIGHT SIDE

- (101) Right side interior surface, excluding hardware or armrests

- (102) Right side hardware or armrest
- (103) Right A (A1/A2)-pillar
- (104) Right B-pillar
- (105) Other right pillar (specify): \_\_\_\_\_
- (106) Right side window glass
- (107) Right side window frame
- (108) Right side window sill
- (109) Right side window glass including one or more of the following: frame, window sill, A (A1/A2)-pillar, B-pillar, or roof side rail.
- (110) Other right side object (specify): \_\_\_\_\_

### INTERIOR

- (151) Seat, back support
- (152) Belt restraint webbing/buckle
- (153) Belt restraint B-pillar or door frame attachment point
- (154) Other restraint system component (specify): \_\_\_\_\_
- (155) Head restraint system
- (160) Other occupants (specify): \_\_\_\_\_
- (161) Interior loose objects
- (162) Child safety seat (specify): \_\_\_\_\_
- (163) Other interior object (specify): \_\_\_\_\_

### AIR BAG

- (170) Air bag-driver side
- (171) Air bag-driver side and eyewear
- (172) Air bag-driver side and jewelry
- (173) Air bag-driver side and object held
- (174) Air bag-driver side and object in mouth
- (175) Air bag compartment cover-driver side
- (176) Air bag compartment cover-driver side and eyewear
- (177) Air bag compartment cover-driver side and jewelry
- (178) Air bag compartment cover-driver side and object held
- (179) Air bag compartment cover-driver side and object in mouth
- (180) Air bag-passenger side
- (181) Air bag-passenger side and eyewear
- (182) Air bag-passenger side and jewelry

- (183) Air bag-passenger side and object held
- (184) Air bag-passenger side and object in mouth
- (185) Air bag compartment cover-passenger side
- (186) Air bag compartment cover-passenger side and eyewear
- (187) Air bag compartment cover-passenger side and jewelry
- (188) Air bag compartment cover-passenger side and object held
- (189) Air bag compartment cover-passenger side and object in mouth
- (190) Other air bag (specify): \_\_\_\_\_

- (195) Other air bag compartment cover (specify): \_\_\_\_\_

### ROOF

- (201) Front header
  - (202) Rear header
  - (203) Roof left side rail
  - (204) Roof right side rail
  - (205) Roof or convertible top
- FLOOR**
- (251) Floor (including toe pan)
  - (252) Floor or console mounted transmission lever, including console
  - (253) Parking brake handle
  - (254) Foot controls including parking brake

### REAR

- (301) Backlight (rear window)
- (302) Backlight storage rack, door, etc.
- (303) Other rear object (specify): \_\_\_\_\_

### ADAPTIVE (ASSISTIVE) DRIVING EQUIPMENT

- (401) Hand controls for braking/acceleration
- (402) Steering control devices (attached to OEM steering wheel)
- (403) Steering knob attached to steering wheel
- (405) Replacement steering wheel (i.e., reduced diameter)
- (406) Joy stick steering controls
- (407) Wheelchair tie-downs
- (408) Modification to seat belts, (specify): \_\_\_\_\_
- (409) Additional or relocated switches, (specify): \_\_\_\_\_

(410) Raised roof

- (411) Wall mounted head rest (used behind wheel chair)
- (412) Other adaptive device (specify): \_\_\_\_\_

### EXTERIOR OF OCCUPANT'S VEHICLE

- (451) Hood
- (452) Outside hardware (e.g., outside mirror, antenna)
- (453) Other exterior surface or tires (specify): \_\_\_\_\_
- (454) Unknown exterior objects

### EXTERIOR OF OTHER MOTOR VEHICLE

- (501) Front bumper
- (502) Hood edge
- (503) Other front of vehicle (specify): \_\_\_\_\_
- (504) Hood
- (505) Hood ornament
- (506) Windshield, roof rail, A-pillar
- (507) Side surface
- (508) Side mirrors
- (509) Other side protrusions (specify): \_\_\_\_\_
- (510) Rear surface
- (511) Undercarriage
- (512) Tires and wheels
- (513) Other exterior of other motor vehicle (specify): \_\_\_\_\_
- (514) Unknown exterior of other motor vehicle

### OTHER VEHICLE OR OBJECT IN THE ENVIRONMENT

- (598) Other vehicle or object (specify): \_\_\_\_\_
- (599) Unknown vehicle or object

### NONCONTACT INJURY

- (601) Fire in vehicle
- (602) Flying glass
- (603) Other noncontact injury source (specify): \_\_\_\_\_
- (604) Air bag exhaust gases
- (697) Injured, unknown source

# OFFICIAL INJURY DATA — SOFT TISSUE INJURIES

Indicate the Location, Specific Anatomic Structure, Detail (size, depth, fracture type, head injury clinical signs and neurological deficits), and Source of all injuries indicated by official sources (or from PAR or other unofficial sources if medical records and interviewee data are unavailable.)

ALL INJURIES FROM AUTOPSY

ABRASION  
BETWEEN (L) EYE + (L) EAR

(L) LOWER LIP - 1CM ABRASION

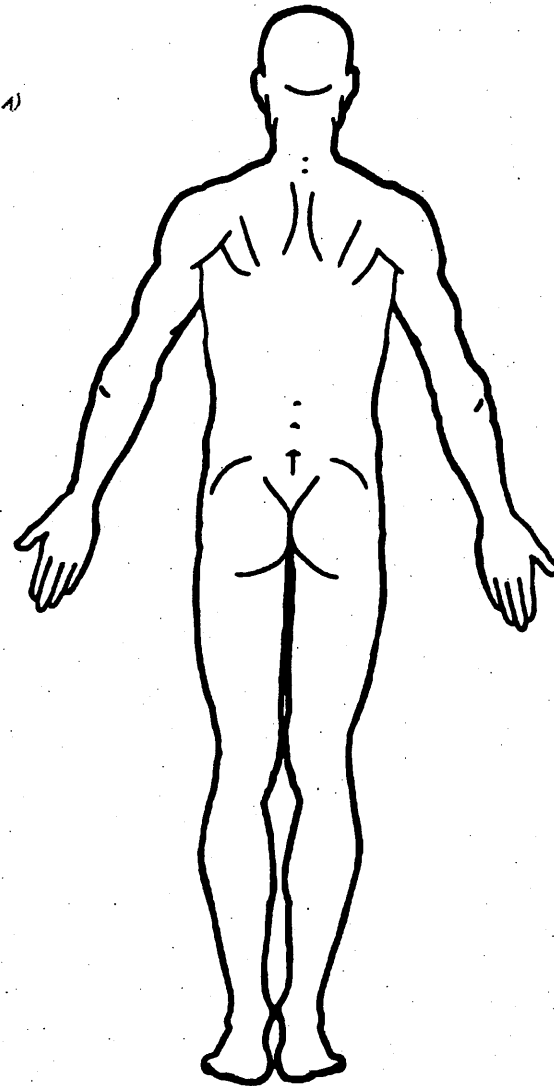
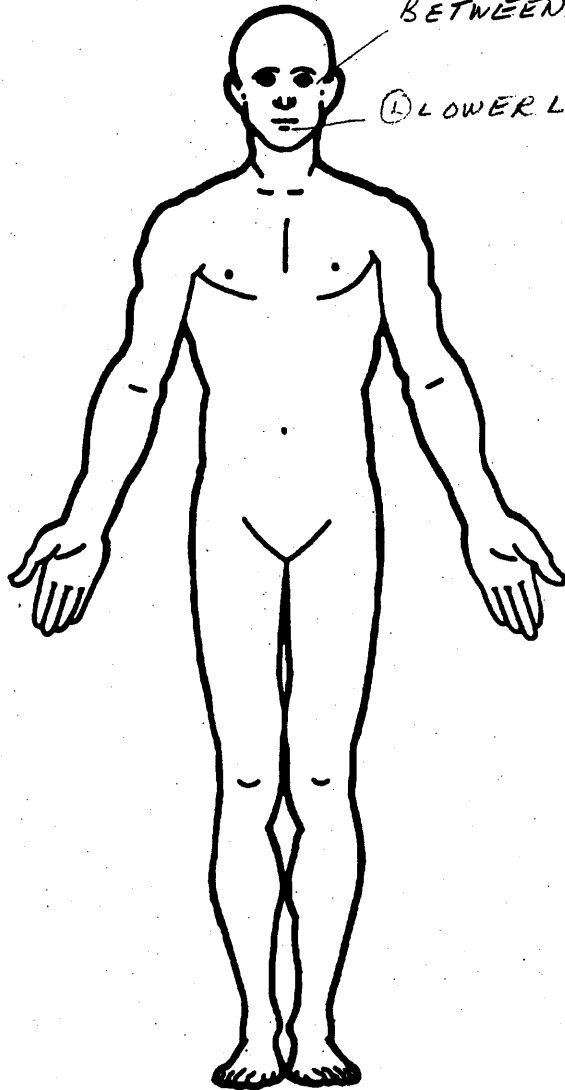



# OFFICIAL INJURY DATA — SKELETAL INJURIES

Restrained?

— No *NR*  
 — Yes

Blood Alcohol Level (mg/dl)

BAL = *0*

*0* drugs

Glasgow Coma Scale Score

GCSS = *dead at scene*

Units of Blood Given

Units = \_\_\_\_\_

Arterial Blood Gases

pH = \_\_\_\_\_

PO<sub>2</sub> = \_\_\_\_\_

PCO<sub>2</sub> = \_\_\_\_\_

HCO<sub>3</sub> = \_\_\_\_\_

*dead at scene*

Indicate the Location, Specific Anatomic Structure, Detail (size, depth, fracture type, head injury clinical signs and neurological deficits), and Source of all injuries indicated by official sources (or from PAR or other unofficial sources if medical records and interviewee data are unavailable.)

*ALL INJURIES FROM AUTOPSY*

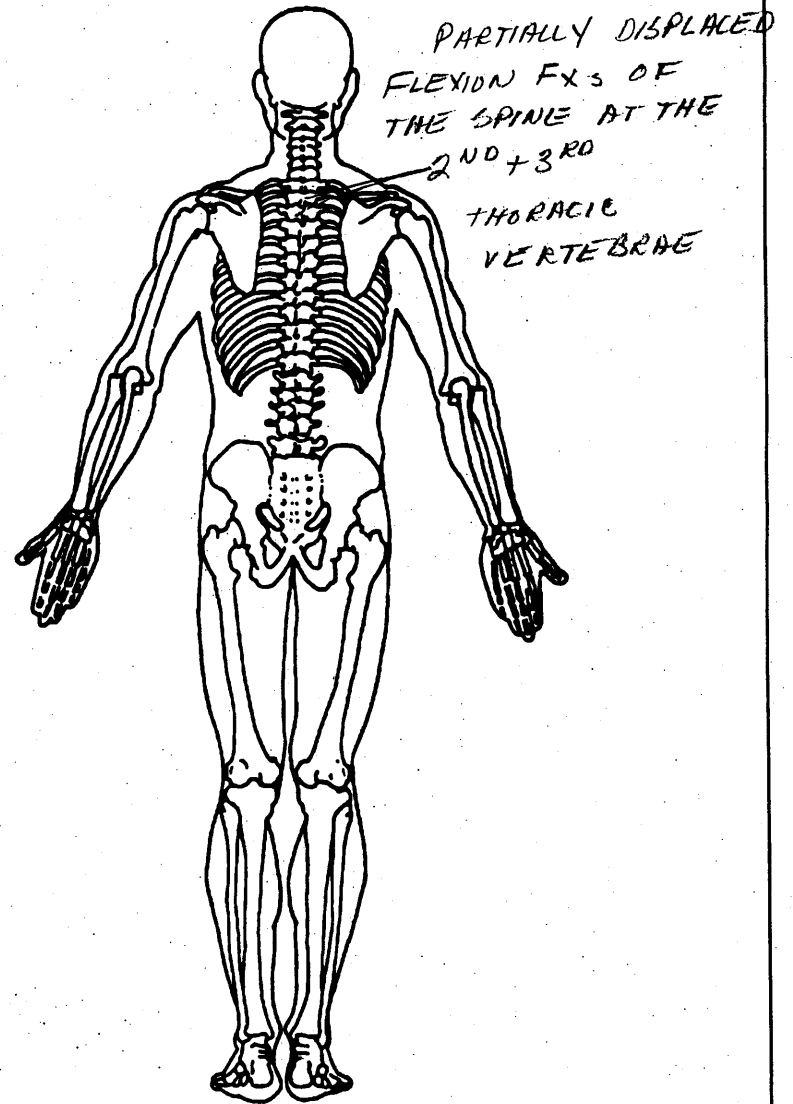
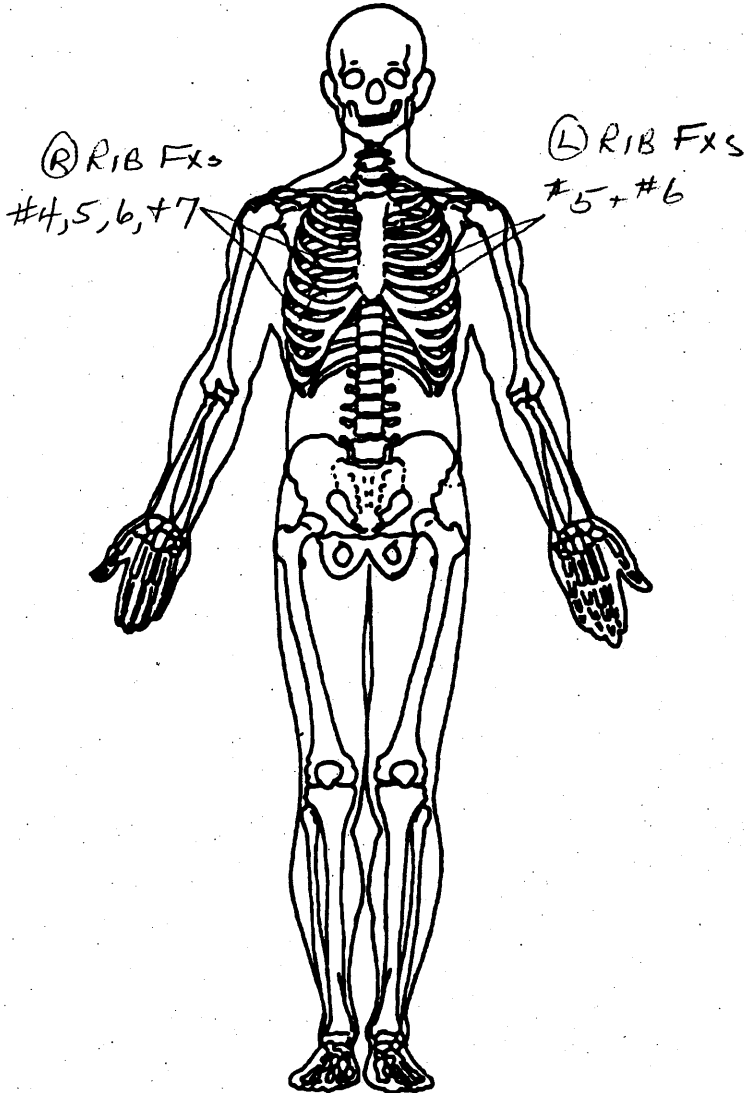

# OFFICIAL INJURY DATA — INTERNAL INJURIES

Indicate the Location, Specific Anatomic Structure, Detail (size, depth, fracture type, head injury clinical signs and neurological deficits), and Source of all injuries indicated by official sources (or from PAR or other unofficial sources if medical records and interviewee data are unavailable.)

ALL INJURIES FROM AUTOPSY

1000 OF FLUID BLOOD IS PRESENT  
OVER (L) CEREBRAL HEMISPHERE  
BELOW THE DURA

(R) HEMOTHORAX  
HEART: SEVERAL  
LACERATIONS:  
PERICARDIUM  
3 LACERATIONS

INFERIOR  
VENA CAVA  
LACERATION

(R) VENTRICLE  
LACERATION  
(R) ATRIAL  
LACERATION

LIVER IS  
MASSIVELY LACERATED  
ON BOTH UPPER + LOWER  
SURFACES WITH  
IRREGULAR TEARS UP TO  
8 CM DEEP IN THE  
LIVER

2000  
HEMOPERITONEUM

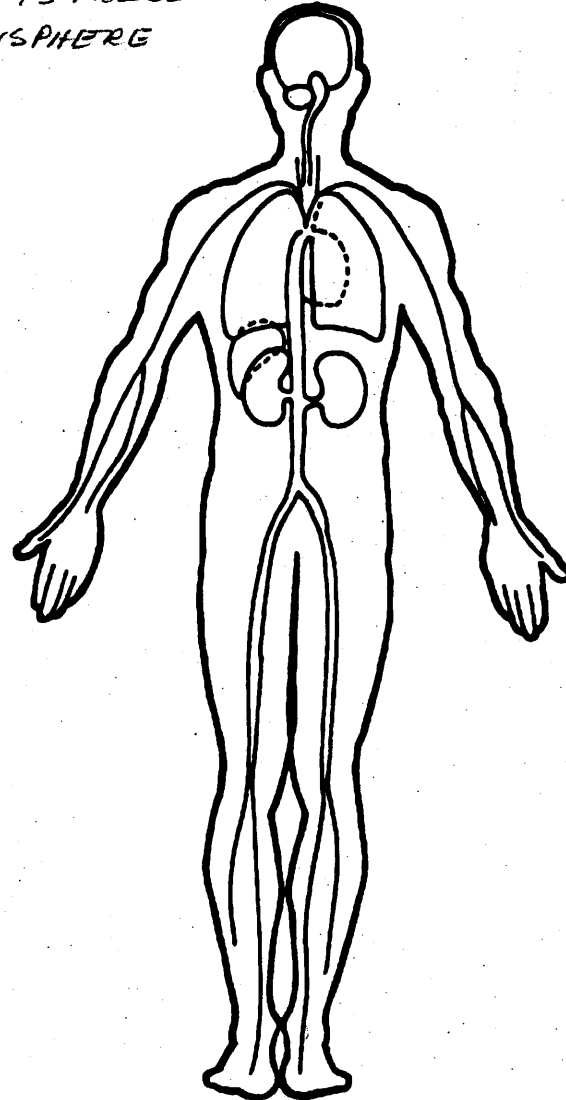
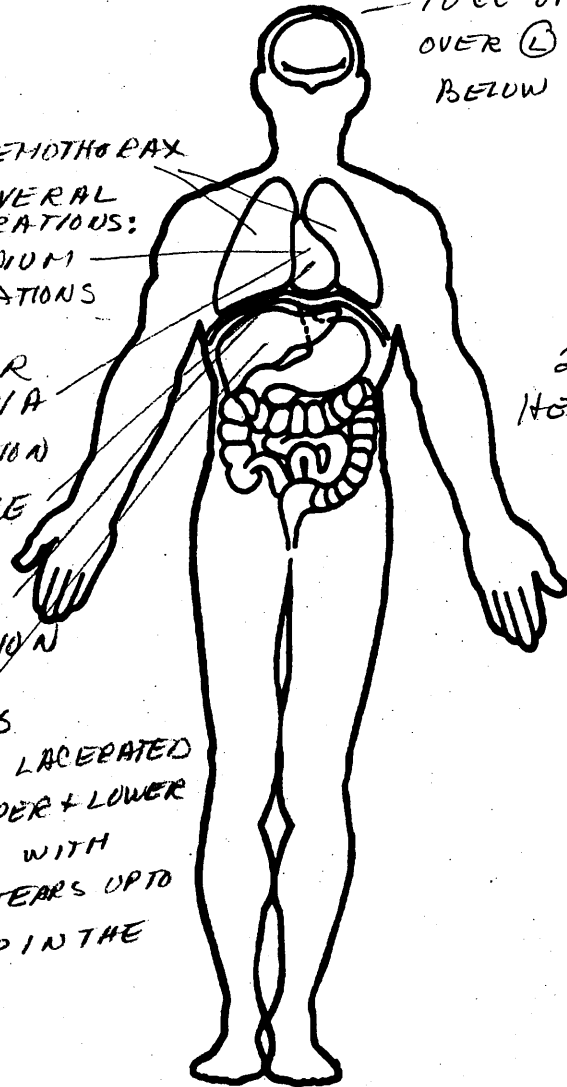



# CRASHPC PROGRAM SUMMARY

(All Measurements In Metric)

Identifying Title <u>02</u> Primary Sampling Unit	<u>140A</u> Case No.-Stratum	<u>03</u> Accident Event Sequence No.	<u>███ ███ 95</u> Date (Month, day, year) of Run
---	---------------------------------	--	---

CRASHPC Vehicle Identification	Vehicle 1 <u>1993</u> Year	<u>CHRYSLER</u> Make	<u>TOWN + COUNTRY</u> Model	<u>1</u> NASS Veh. No.
	Vehicle 2		<u>BARRIER</u>	<u>11</u>

## GENERAL INFORMATION

VEHICLE 1		VEHICLE 2	
Size	<u>5</u>	Size	<u>11</u>
Weight	<u>1995</u> kg	Weight	
$\frac{1906}{\text{Curb}} + \frac{74}{\text{Occupant(s)}} + \frac{15}{\text{Cargo}} = 1950$			
CDC	<u>12 F Y E W 3</u>	CDC	
PDOF (-180 to +180)	$\pm$ <u>010</u> °	PDOF (-180 to +180)	$\pm$ _____ °
Stiffness	<u>7</u>	Stiffness	

## SCENE INFORMATION

Rest and Impact Positions <input type="checkbox"/> No, <i>Go To Damage Information</i> <input type="checkbox"/> Yes			
VEHICLE 1		VEHICLE 2	
Rest Position	X _____ m	Rest Position	X _____ m
	Y _____ m		Y _____ m
	PSI _____ °		PSI _____ °
Impact Position	X _____ m	Impact Position	X _____ m
	Y _____ m		Y _____ m
	PSI _____ °		PSI _____ °
Slip Angle(-180 to +180)	_____ °	Slip Angle (-180 to +180)	_____ °

## VEHICLE MOTION

Sustained Contact <input type="checkbox"/> No <input type="checkbox"/> Yes			
VEHICLE 1		VEHICLE 2	
Vehicle Rotation	<input type="checkbox"/> No <input type="checkbox"/> Yes	Vehicle Rotation	<input type="checkbox"/> No <input type="checkbox"/> Yes
Rotation Stop Before Rest	<input type="checkbox"/> No <input type="checkbox"/> Yes	Rotation Stop Before Rest	<input type="checkbox"/> No <input type="checkbox"/> Yes
End of Rotation Position	X _____ m	End of Rotation Position	X _____ m
	Y _____ m		Y _____ m
	PSI _____ °		PSI _____ °
Curved Path	<input type="checkbox"/> No <input type="checkbox"/> Yes	Curved Path	<input type="checkbox"/> No <input type="checkbox"/> Yes
Point on Path	X _____ m Y _____ m	Point on Path	X _____ m Y _____ m
Rotation Direction	<input type="checkbox"/> None <input type="checkbox"/> CW <input type="checkbox"/> CCW	Rotation Direction	<input type="checkbox"/> None <input type="checkbox"/> CW <input type="checkbox"/> CCW
Rotation >360°	<input type="checkbox"/> No <input type="checkbox"/> Yes	Rotation >360°	<input type="checkbox"/> No <input type="checkbox"/> Yes

National Accident Sampling System-Crashworthiness Data System: CRASHPC Program Summary

**FRICITION INFORMATION**

Coefficient of Friction \_\_\_\_\_  
 Rolling Resistance Option \_\_\_\_\_

Vehicle 1 Rolling Resistance  
 LF \_\_\_\_\_ RF \_\_\_\_\_  
 LR \_\_\_\_\_ RR \_\_\_\_\_

Vehicle 2 Rolling Resistance  
 LF \_\_\_\_\_ RF \_\_\_\_\_  
 LR \_\_\_\_\_ RR \_\_\_\_\_

**TRAJECTORY INFORMATION**

Trajectory Data [ ] No [ ] Yes  
 If No, Go To Damage Information

Vehicle 1 Steer Angles  
 LF \_\_\_\_\_ ° RF \_\_\_\_\_ °  
 LR \_\_\_\_\_ ° RR \_\_\_\_\_ °

Vehicle 2 Steer Angles  
 LF \_\_\_\_\_ ° RF \_\_\_\_\_ °  
 LR \_\_\_\_\_ ° RR \_\_\_\_\_ °

Terrain Boundary [ ] No [ ] Yes

First Point  
 X \_\_\_\_\_ m Y \_\_\_\_\_ m

Second Point  
 X \_\_\_\_\_ m Y \_\_\_\_\_ m

Secondary Coefficient of Friction \_\_\_\_\_

**DAMAGE INFORMATION**

VEHICLE 1

Damage Length L 157 cm

Crush Depths  
 C<sub>1</sub> 36.5 cm  
 C<sub>2</sub> 59 cm  
 C<sub>3</sub> 59 cm  
 C<sub>4</sub> 55.5 cm  
 C<sub>5</sub> 29 cm  
 C<sub>6</sub> 4 cm

Damage Offset D ⊖ 32.5 cm

VEHICLE 2

Damage Length L \_\_\_\_\_ cm

Crush Depths  
 C<sub>1</sub> \_\_\_\_\_ cm  
 C<sub>2</sub> \_\_\_\_\_ cm  
 C<sub>3</sub> \_\_\_\_\_ cm  
 C<sub>4</sub> \_\_\_\_\_ cm  
 C<sub>5</sub> \_\_\_\_\_ cm  
 C<sub>6</sub> \_\_\_\_\_ cm

Damage Offset D ± \_\_\_\_\_ cm

**IF THIS COMMON IMPACT WAS WITH A MOTOR VEHICLE NOT IN TRANSPORT, FILL IN THE INFORMATION BELOW.**

Model Year: \_\_\_\_\_  
 Make: \_\_\_\_\_  
 Model: \_\_\_\_\_  
 VIN: \_\_\_\_\_

The Weight, CDC, Scene Data and Damage Information for this vehicle should be recorded above.

Complete and ATTACH the appropriate vehicle damage sketch and dimensions to the Form.

INPUT      CALCULATE      TRAJECTORY      OUTPUT      GRAPHICS      EXIT

SUMMARY OF CRASHPC RESULTS USING DAMAGE

---

02 140a arr

SPEED CHANGE  
(DAMAGE)

VEHICLE #1

TOTAL	46 KPH ( 29 MPH)
LONGITUDINAL	-46 KPH ( -28 MPH)
LATITUDINAL	-8 KPH ( -5 MPH)
PDOF ANGLE	10 DEGREES
ENERGY DISSIPATED =	211988 JOULES ( 156333 FT-LB)

VEHICLE #2

TOTAL	0 KPH ( 0 MPH)
LONGITUDINAL	0 KPH ( 0 MPH)
LATITUDINAL	0 KPH ( 0 MPH)
PDOF ANGLE	0 DEGREES
ENERGY DISSIPATED =	0 JOULES ( 0 FT-LB)

PRESS ANY KEY TO CONTINUE

INPUT      CALCULATE      TRAJECTORY      OUTPUT      GRAPHICS      EXIT

DAMAGE DATA

BEST AVAILABLE COPY

	VEHICLE #1	VEHICLE #2
SIZE CATEGORY	5	11
STIFFNESS CATEGORY	7	0
VEHICLE WEIGHT	1995 KGS ( 4398 LBS)	***** KGS (2204586 LBS) *
CDC	12FYEW3	BARRIER
PDOF ANGLE	10 DEGREES	0 DEGREES *
CRUSH LENGTH	157 CM. ( 62 IN.)	0 CM. ( 0 IN.) *
C1	37 CM. ( 15 IN.)	0 CM. ( 0 IN.) *
C2	59 CM. ( 23 IN.)	0 CM. ( 0 IN.) *
C3	59 CM. ( 23 IN.)	0 CM. ( 0 IN.) *
C4	56 CM. ( 22 IN.)	0 CM. ( 0 IN.) *
C5	29 CM. ( 11 IN.)	0 CM. ( 0 IN.) *
C6	4 CM. ( 2 IN.)	0 CM. ( 0 IN.) *
D	-32 CM. ( -13 IN.)	0 CM. ( 0 IN.) *
D'	-44 CM. ( -17 IN.)	0 CM. ( 0 IN.) *

(\* INDICATES DEFAULT VALUE)  
PRESS ANY KEY TO CONTINUE

INPUT	CALCULATE	TRAJECTORY	OUTPUT	GRAPHICS	EXIT
-------	-----------	------------	--------	----------	------

DIMENSIONS AND INERTIAL PROPERTIES

	VEHICLE #1	VEHICLE #2
CG TO FRONT AXLE	142 CM. ( 56 IN.)	127 CM. ( 50 IN.)
CG TO REAR AXLE	160 CM. ( 63 IN.)	127 CM. ( 50 IN.)
TRACK	162 CM. ( 64 IN.)	127 CM. ( 50 IN.)
CG TO FRONT OF VEH	259 CM. ( 102 IN.)	127 CM. ( 50 IN.)
CG TO REAR OF VEH	-310 CM. (-122 IN.)	-127 CM. ( -50 IN.)
CG TO SIDE OF VEH	101 CM. ( 40 IN.)	127 CM. ( 50 IN.)
MOMENT OF INERTIA	20956 KGS ( 46200 LBS)	***** KGS (***** LBS)
VEHICLE MASS	5 KGS ( 11 LBS)	2600 KGS ( 5732 LBS)

PRESS ANY KEY TO CONTINUE

Printing Picture:

CRASH

BEST AVAILABLE COPY

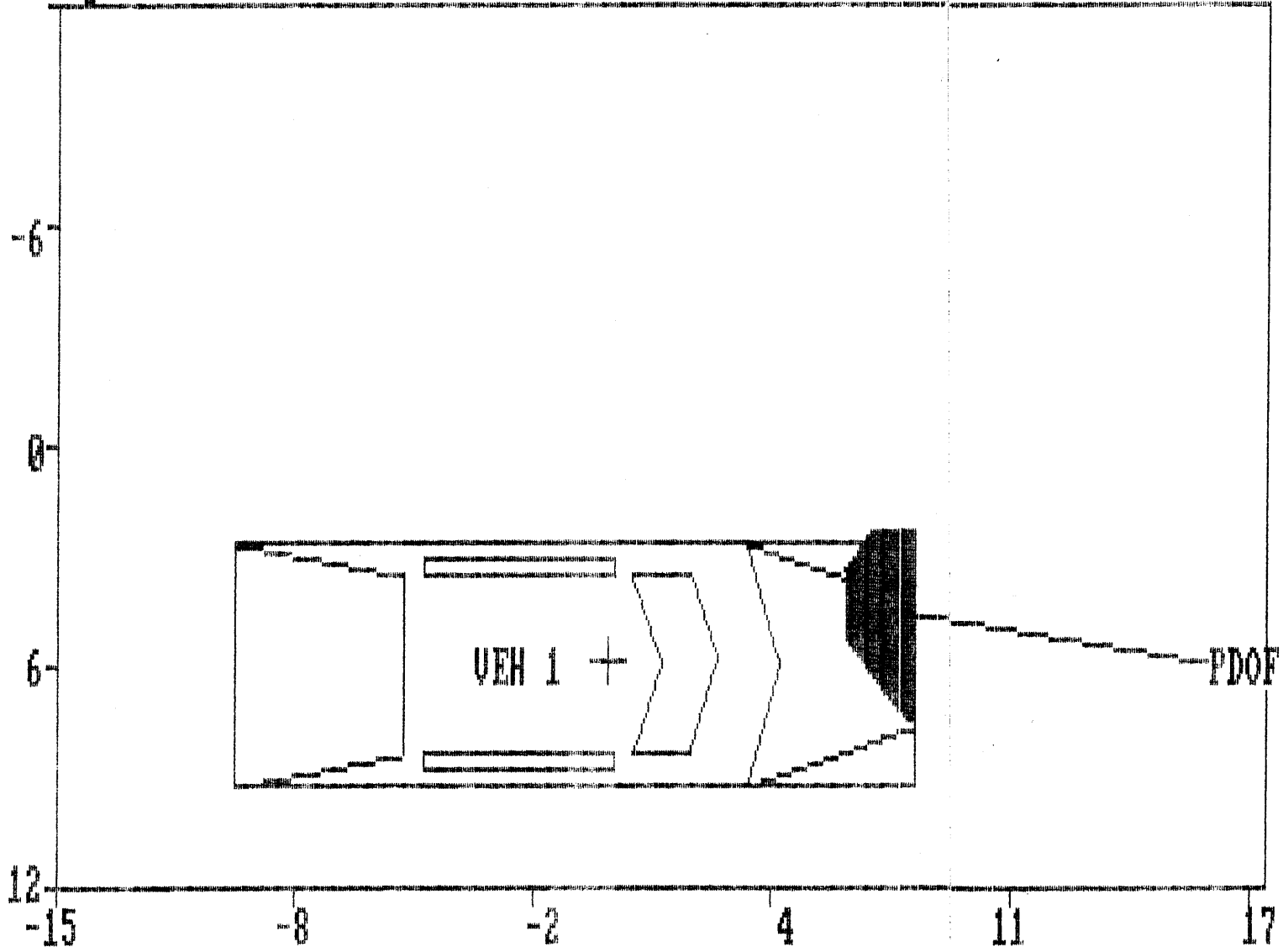

DAMAGE DESCRIPTION

SUMMARY OF CRASHPC RESULTS USING DAMAGE

-----  
P02 CASE 140A - VEHICLE #1 - BARRIER -- BUCHNER

SPEED CHANGE  
(DAMAGE)

VEHICLE #1

TOTAL 47 KPH ( 29 MPH)  
LONGITUDINAL -46 KPH ( -29 MPH)  
LATITUDINAL -8 KPH ( -5 MPH)  
PDOF ANGLE 10 DEGREES  
ENERGY DISSIPATED = 210785 JOULES ( 155446 FT-LB)

VEHICLE #2

TOTAL 0 KPH ( 0 MPH)  
LONGITUDINAL 0 KPH ( 0 MPH)  
LATITUDINAL 0 KPH ( 0 MPH)  
PDOF ANGLE 0 DEGREES  
ENERGY DISSIPATED = 0 JOULES ( 0 FT-LB)



DAMAGE DATA  
-----

VEHICLE #1

VEHICLE #2

SIZE CATEGORY	5	11
STIFFNESS CATEGORY	7	0
VEHICLE WEIGHT	1950 KGS ( 4299 LBS)	***** KGS (2204586 LBS) *
CDC	12FYEW3	BARRIER
PDOF ANGLE	10 DEGREES	0 DEGREES *
CRUSH LENGTH	157 CM. ( 62 IN.)	0 CM. ( 0 IN.) *
C1	37 CM. ( 14 IN.)	0 CM. ( 0 IN.) *
C2	59 CM. ( 23 IN.)	0 CM. ( 0 IN.) *
C3	59 CM. ( 23 IN.)	0 CM. ( 0 IN.) *
C4	55 CM. ( 22 IN.)	0 CM. ( 0 IN.) *
C5	29 CM. ( 11 IN.)	0 CM. ( 0 IN.) *
C6	4 CM. ( 2 IN.)	0 CM. ( 0 IN.) *
D	-32 CM. ( -13 IN.)	0 CM. ( 0 IN.) *
D'	-44 CM. ( -17 IN.)	0 CM. ( 0 IN.) *

(\* INDICATES DEFAULT VALUE)

DIMENSIONS AND INERTIAL PROPERTIES

---

VEHICLE #1

VEHICLE #2

CG TO FRONT AXLE	142 CM. ( 56 IN.)	127 CM. ( 50 IN.)
CG TO REAR AXLE	160 CM. ( 63 IN.)	127 CM. ( 50 IN.)
TRACK	162 CM. ( 64 IN.)	127 CM. ( 50 IN.)
CG TO FRONT OF VEH	259 CM. ( 102 IN.)	127 CM. ( 50 IN.)
CG TO REAR OF VEH	-310 CM. (-122 IN.)	-127 CM. ( -50 IN.)
CG TO SIDE OF VEH	101 CM. ( 40 IN.)	127 CM. ( 50 IN.)
MOMENT OF INERTIA	20484 KGS ( 45158 LBS)	***** KGS (***** LBS)
VEHICLE MASS	5 KGS ( 11 LBS)	2600 KGS ( 5732 LBS)

Printing Picture:

CRASH

-6

0

6

12

-15

DAMAGE DE

-8

-2

4

11

17

SCRIPTION

VEH 1 +

PDOF

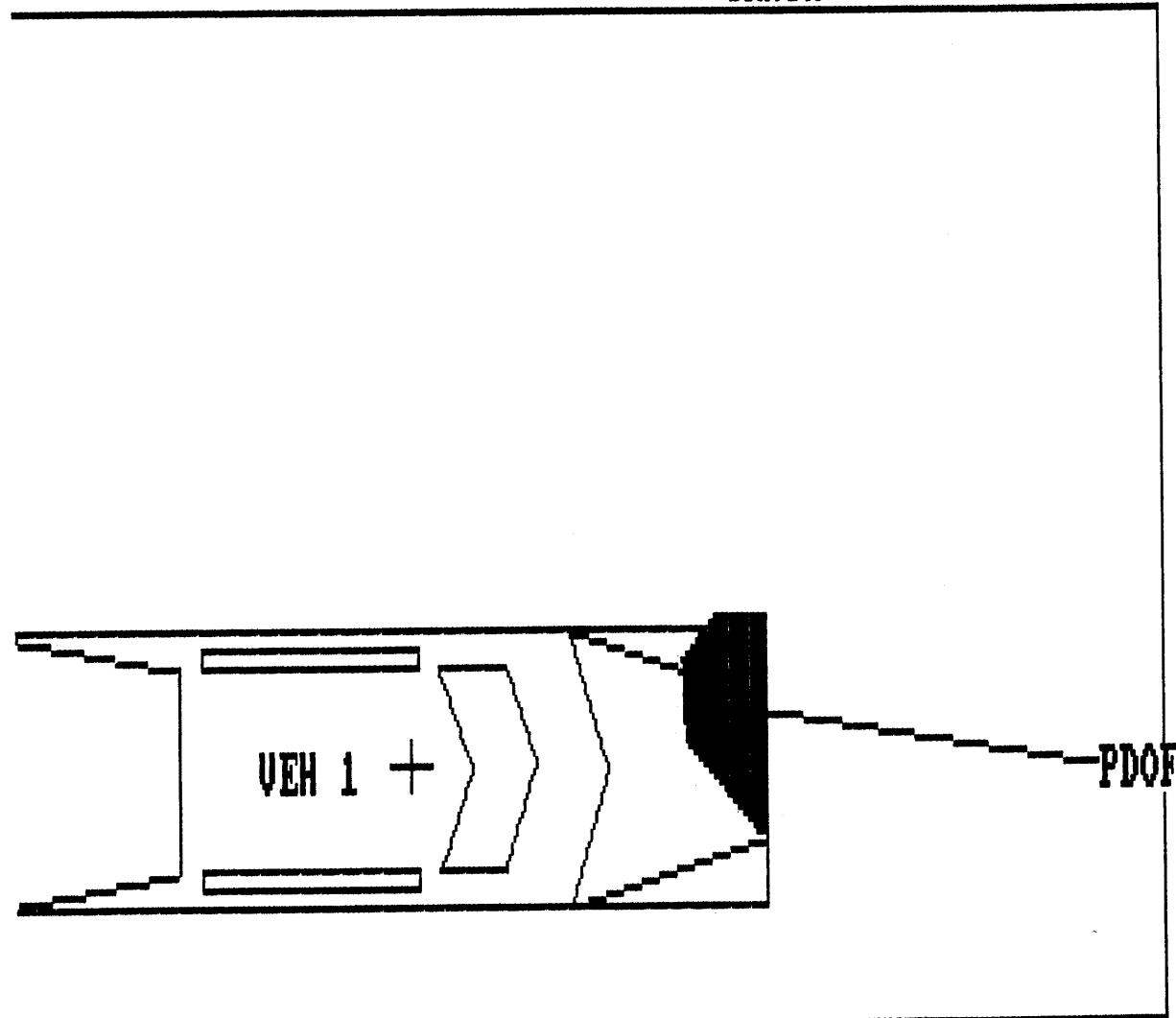

02140A00000011 958.0500000000000113300010004 95 95 96 95024520000  
00182000004462605 0301  
02140A00010012 958.0510000000000120R42000  
02140A00020012 958.0510000000000120R42000  
02140A00030012 958.0510000000000120F42000  
02140A00040012 958.0510000000000120N3300N  
02140A01000021 8.05 0000000009306441201046K54R3PX 1999089900011  
0234211000991413991401  
02140A01000022 8.05 00000000010101130191002000000000099899801101046-046-00  
82119998104602  
02140A01000031 8.05 000000000034212FYEW03024212RZAS03157037059059056029004-  
030 15704930315511024409050909001000  
02140A01000041 8.05 00000000099390310000019999902199991099999990999999909  
02140A01000042 8.05 0000000000312561312251112041312131322231322531332521  
999030999999990  
02140A01010051 8.05 0000000006611680931119000009999993000000015009999988 99  
88898988888901169950000000000041000620106000009011019  
02140A01010161 8.05 0000000001290202120043100  
02140A01010261 8.05 0000000001290202180043100  
02140A01010361 8.05 0000000001140652420043100  
02140A01010461 8.05 0000000001450232430062100  
02140A01010561 8.05 0000000001441602240062100  
02140A01010661 8.05 0000000001441016640062100  
~~02140A01010761 8.05 0000000001541826410062100~~  
02140A01010861 8.05 0000000001650416270062200  
02140A01010961 8.05 0000000001650416270062200  
02140A00000066 8.05 000000000MINIVAN VS. TREES/FIRE  
02140A00000171 8.05 000000000 Vehicle #1 traveling west on two lane und  
ivided roadway negotiating  
02140A00000271 8.05 000000000 a curve to the left with a negative grade. V  
ehicle #1 drives off right  
02140A00000371 8.05 000000000 side of roadway swiping 2 trees with right si  
de and then striking a large  
02140A00000471 8.05 000000000 tree with front of vehicle. Vehicle then cat  
ches fire and is destroyed.  
02140A00000571 8.05 000000000 Vehicle #1 was towed due to damage. Operator  
was fatally injured.  
02140A00000181 8.05 0000000001 minivan 93 Chrysler  
02140A00000281 8.05 000000000 Town and County front  
severe fire ?  
02140A00000381 8.05 000000000  
unknown  
02140A00000191 8.05 0000000001 driver 1/front unknown heart 1  
aceration 6 steering wheel  
02140A9999999900100000000000000000000000000000000  
000000000000002

EXTERIOR VEHICLE Vehicle: 1

INTRA ERRORS

EE1211 2 \*\*\*\*\* THIS IS A SPECIAL INTEREST CASE FOR NHTSA \*\*\*\*\*  
EE1212 \*\*\*\*\* THIS CASE SHOWS A VEHICLE FIRE. \*\*\*\*\*  
EE1213 FIRE OCCURRENCE EV33 equals 1 or 2.

BEST AVAILABLE COPY

OCCUPANT ASSESSMENT Vehicle: 1 Occupant: 1

INTRA ERRORS

HH0191 2 If OCCUPANT POSITION OA10 equals 11 or 13 and AUTOMATIC BELT  
HH0192 AVAILABILITY OA23 does not equal 2, then MANUAL BELT  
HH0193 AVAILABILITY OA18 should equal 3 or 4.

INTER ERRORS

GH0961 2 If TYPE OF INSPECTION GV67 equals 2 or 3, then SOURCE OF BELT  
GH0962 USE OA74 should equal 1. GV=01 OA=01  
EH0011 2 If TREATMENT OA62 equals 1, then 1st DEFORMATION EXTENT EV11  
EH0012 should be greater than 03. GV=01 OA=01

PSU02 -----ERROR SUMMARY SCREEN----- 96  
CASE 140A  
CURRENT VERSION: 8.05

FORM NAME	NUMBER OF DOLLAR SIGNS	NUMBER OF LEVEL 1 ERRORS	NUMBER OF LEVEL 2 ERRORS	VERSION NUMBER CONSISTENT
Accident	0	0	0	Y
General Vehicle	0	0	0	Y
Vehicle Exterior	0	0	1	Y
Vehicle Interior	0	0	0	Y
Occupant Assessment	0	0	1	Y
Occupant Injury	0	0	0	Y
Total Inter Errors		0	2	
Total Case Errors	0	0	4	







PSU 02-140A (1995) #1  
Best Available





PSU 02-140A (1995) #2  
Best Available



PSU 02-140A (1995) #3  
Best Available



PSU 02-140A (1995) #4  
Best Available



PSU 02-140A (1995) #5  
Best Available



PSU 02-140A (1995) #6  
Best Available



PSU 02-140A (1995) #7  
Best Available



PSU 02-140A (1995) #8  
Best Available



PSU 02-140A (1995) #9  
Best Available





PSU 02-140A (1995) #10  
Best Available



PSU 02-140A (1995) #11  
Best Available



PSU 02-140A (1995) #12  
Best Available



PSU 02-140A (1985) #13  
Best Available



PSU 02-140A (1995) #14  
Best Available



PSU 02-140A (1995) #15  
Best Available



**PSU 02-140A (1995) #16**  
**Best Available**



PSU 02-140A (1995) #17  
Best Available





PSU 02-140A (1995) #18  
Best Available



PSU 02-140A (1995) #19  
Best Available



PSU 02-140A (1995) #20  
Best Available



PSU 02-140A (1995) #21  
Best Available



PSU 02-140A (1995) #22  
Best Available



PSU 02-140A (1995) #23



PSU 02-140A (1995) #24



PSU 02-140A (1995) #25





PSU 02-140A (1995) #26



PSU 02-140A (1995) #27

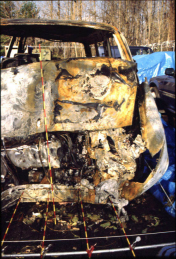

PSU 02-140A (1995) #28



PSU 02-140A (1995) #29



PSU 02-140A (1995) #30



PSU 02-140A (1995) #31



PSU 02-140A (1995) #32



PSU 02-140A (1995) #33





PSU 02-140A (1995) #34



PSU 02-140A (1995) #35



PSU 02-140A (1995) #38



PSU 02-140A (1995) #37



PSU 02-140A (1995) #38



PSU 02-140A (1995) #39



PSU 02-140A (1995) #40



FSU 02-140A (1995) #41





PSU 02-140A (1995) #42



PSU 02-140A (1995) #43



PSU 02-140A (1985) #44  
Best Available



PSU 02-140A (1995) #45



PSU 02-140A (1995) #46



PSU 02-140A (1995) #47



PSU 02-140A (1995) #48



PSU 02-140A (1995) #49





PSU 02-140A (1995) #50



PSU 02-140A (1995) #51  
Best Available



PSU 02-140A, (1995) #52  
Best Available



PSU 02-140A (1995) #63  
Best Available



PSU 02-140A (1995) #54  
Best Available



PSU 02-140A (1995) #55



PSU 02-140A (1995) #56



PSU 02-140A (1995) #57





PSU 02-140A (1995) #58



PSU 02-140A (1995) #59



PSU 02-140A (1995) #60



PSU 02-140A (1995) #61



PSU 02-140A (1995) #62



PSU 02-140A (1995) #63



PSU 02-140A (1995) #64



PSU 02-140A (1995) #65





PSU 02-140A (1995) #66



PSU 02-140A (1995) #67



PSU 02-140A (1995) #68



PSU 02-140A (1995) #69



PSU 02-140A (1995) #70



PSU 02-140A (1995) #71



PSU 02-140A (1995) #72



PSU 02-140A (1995) #73





PSU 02-140A (1995) #74



PSU 02-140A (1995) #75



PSU 02-140A (1995) #78



PSU 02-140A (1995) #77



PSU 02-140A (1995) #78



PSU 02-140A (1995) #79



PSU 02-140A (1995) #80



PSU 02-140A (1995) #81





PSU 02-140A (1995) #82



PSU 02-140A (1995) #83  
Best Available



PSU 02-140A (1995) #84



PSU 02-140A (1995) #85



PSU 02-140A (1995) #86



**PSU 02-140A (1995) #87**  
**Best Available**



PSU 02-140A (1995) #88



PSU 02-140A (1995) #89





PSU 02-140A (1995) #90



PSU 02-140A (1995) #91



PSU 02-140A (1995) #92



PSU 02-140A (1995) #93



PSU 02-140A (1995) #94



PSU 02-140A (1995) #95  
Best Available



PSU 02-140A (1995) #96

Best Available



PSU 02-140A (1995) #97





PSU 02-140A (1995) #98



**PSU 02-140A (1995) #99**



PSU 02-140A (1995) #100