



U.S. Department
of Transportation

**National Highway
Traffic Safety
Administration**

400 Seventh Street, S.W.
Washington, D.C. 20590

Dear Crash Data Researchers/Users:

Thank you for choosing crash data from the National Highway Traffic Safety Administration (NHTSA) for your research or other use. The information contained in this motor vehicle crash report is collected, maintained and distributed in accordance with Public Law 89-564. In accordance with this Public Law, NHTSA is required not to release any case information until completion of quality control procedures. These procedures include a review of the case material to extract all names, licenses and registration numbers, non-coded interview material, non-research related researcher comments in the margins, non-factual data, and the production number portion of the vehicle identification number (VIN).

If you requested NHTSA to query its database files in order to identify a specific crash, then that query was made using non-personal descriptors you provided for use in our search. This motor vehicle crash may have been identified from a data search and matches the general, non-personal descriptors you provided, but we cannot confirm that this is the specific crash report you requested.

If you have any questions with regard to the above procedures, please contact the Field Operations Branch, Crash Investigation Division, National Center for Statistics and Analysis at 202-366-4820. Again, please be advised that we cannot confirm that this is the case that you have specifically requested nor can we certify the information to be correct.

*** **



AUTO SAFETY HOTLINE
(800) 424-9393
Wash. D.C. Area 366-0123



CASE SUMMARY

PSU 04 CASE NO. 0291A TYPE OF ACCIDENT car - ran off road

A. DESCRIPTION OF THE ACCIDENT SEQUENCE AND ACCIDENT PECULIARITIES

(Provide a summary of the accident sequence as well as any particular event of the accident that is noteworthy. Injury mechanism and vehicle crashworthiness is the focus, not driver culpability. Do not include any personal identifiers.)

V, was traveling east on a 2 lane divided roadway, negotiating a left turn. V, ran off the right road side, then re-entered the road. V, again ran off the right road side impacting its front with a pole. V, rotated clockwise, then rolled over 1 time (4 quarters); ejecting the driver and coming to final rest on its wheels.

B. VEHICLE PROFILE(S)

Vehicle No.	Class of Vehicle	Year/Make/Model	Most Severe Damage Based on Vehicle Inspection		Component Failure
			Damage Plane	Severity Description	
01	subcompact	1993 Dodge Shadow	Front	severe	RF seat back . door latch failure

DO NOT SANITIZE THIS FORM

C. PERSON PROFILE(S)

Vehicle No.	Person Role	Seat Position	Restraint Use	Most Severe Injury (TO BE COMPLETED BY ZONE CENTER)			
				Body Region	Injury Type	AIS	Injury Source
01	Driver	left front	None	brain	lacerations	4	roof

Body Region

Abdomen
 Ankle-foot
 Arm (upper)
 Back-thoracolumbar spine
 Brain
 Chest
 Ears
 Eye
 Elbow
 Face
 Forearm
 Head-skull
 Heart
 Kidneys
 Knee
 Leg (lower)
 Liver
 Lower limb(s) (whole or unknown part)
 Mouth
 Neck-cervical spine
 Nose

Pelvic-hip
 Pulmonary-lungs
 Shoulder
 Spleen
 Thigh
 Thyroid, other endocrine gland
 Upper limb(s) (whole or unknown part)
 Vertebrae
 Whole body
 Wrist-hand

Injury Type

Abrasion
 Amputation
 Avulsion
 Burn
 Concussion
 Contusion
 Crush
 Detachment, separation
 Dislocation

Fracture
 Fracture and dislocation
 Laceration
 Other
 Perforation, puncture
 Rupture
 Sprain
 Strain
 Total severance, transection
 Unknown

Abbreviated Injury Scale

- (1) Minor injury
- (2) Moderate injury
- (3) Serious injury
- (4) Severe injury
- (5) Critical injury
- (6) Maximum (untreatable)
- (7) Injured, unknown severity

DO NOT SANITIZE THIS FORM

RECEIVED [blacked out] 1995

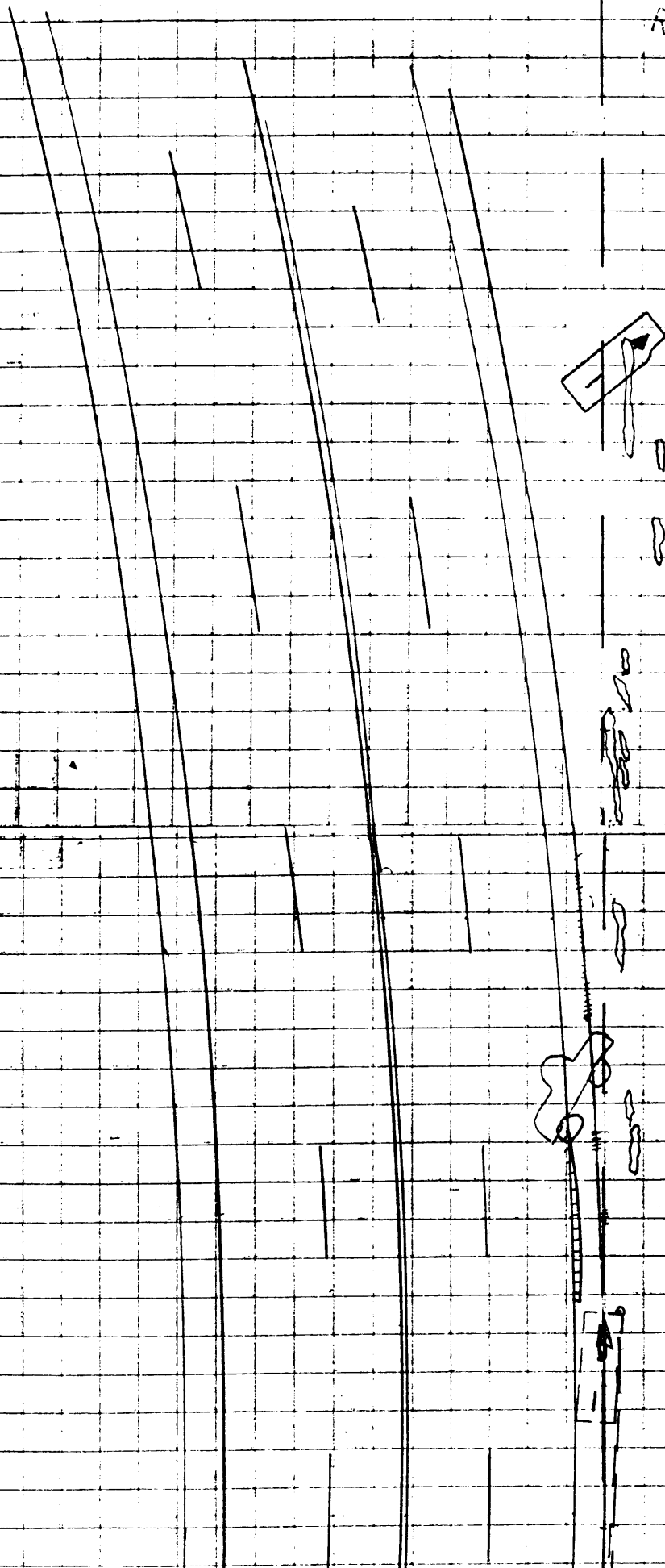

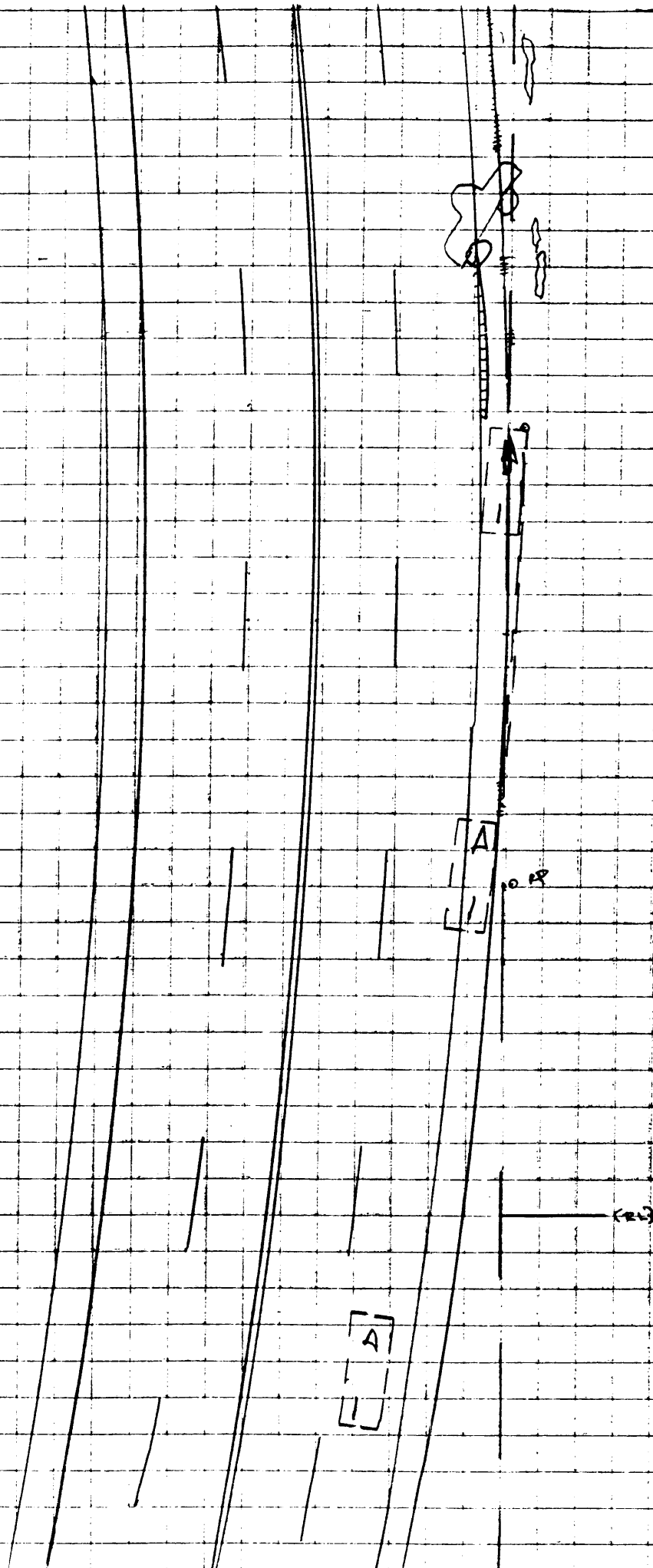



ACCIDENT COLLISION DIAGRAM

PSU No. 04

Case Number—Stratum 029 A

Indicate
North

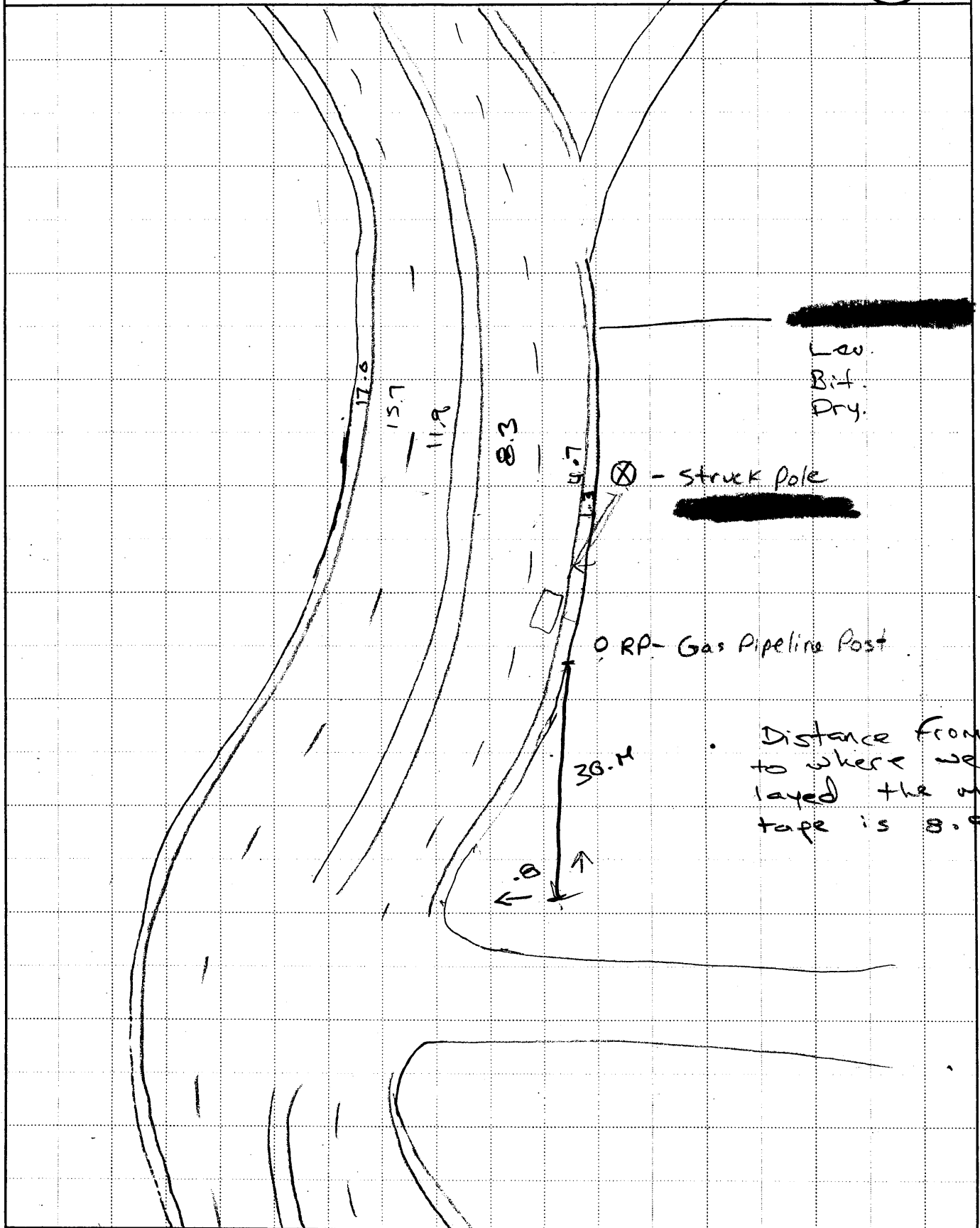



ACCIDENT COLLISION MEASUREMENT TABLE

Primary Sampling Unit Number 04

Case Number - Stratum 029A

ACCIDENT COLLISION DIAGRAM

Document the physical plant:

- all road/roadway delineation (e.g., curbs/edge lines, lane markings, median markings, pavement markings, parked vehicles, poles, signs, etc.)
- all traffic controls (e.g., speed limit)
- north arrow placed on diagram
- roadway surface type and condition of applicable roadways
- grade measurements for all applicable roadways and at location of rollover initiation
- roadway curvature

Document vehicle dynamics including:

- reference point and reference line relative to physical features present at the scene
- scaled documentation of all accident induced physical evidence
- scaled documentation of all roadside objects contacted
- scaled representations of the vehicle(s) at pre-impact, impact, and final rest based upon either:
 - a) physical evidence; or
 - b) reconstructed accident dynamics

CRASH DATA

	VEH. #1	VEH. #2	VEH. #3
Heading Angle	<u>160°</u>	—	—
Surface Type	<u>Bit</u>	—	—
Surface Condition	<u>Dry</u>	—	—
Coefficient of Friction	<u>.7</u>	—	—
Grade (v/h) Measurement (between impact and final rest)	<u>Lev.</u>	—	—
Grade (v/h) Measurement (at location of rollover initiation)	<u>Lev.</u>	—	—

Reference Point: Gas Pipeline
Marker Post

Reference line: South curb edge

Item	Distance and Direction from Reference Point	Distance and Direction from Reference Line
Struck Curb Beg.	2.9 E	0
Struck Curb End	4.3 E	0
Ⓡ tire path to pole Beg.	4.6 E	0
" Mid	10.8 E	.4 S
" End	18.7 E	.6 S
Gouge in curb Beg.	17.9 E	0
Gouge in curb End	19.3 E	0
Struck Pole	19.7 E	.6 S
Paint transfer to curb	23.5 E 22.8 E	0
Gouge 1 Beg. Ⓡ	25.2 E	1.2 S
" End Ⓡ	27.5 E	1.2 S
Gouge 2 Beg. Ⓡ	27.5 E	.9 S
" End Ⓡ	28.9 E	.9 S

Item	Distance and Direction from Reference Point	Distance and Direction from Reference Line
Scraping on curb beg	32.1 E	0
" " " end	38.2 E	0
(LR) Yaw mark Beg	20.1 E	1.1 N
(LR) Yaw mark End	27.5 E	1.2 N
Gauge 3 Beg.	33.9 E	.8 S
" " End	37.4 E	.8 S
Gauge 4 Beg.	39.9 E	.7 S
Gauge 4 End	44.5 E	0
Gauge 5 Beg	41.7 E	1.0 S
" 5 End	43.1 E	.8 S
" 6 Beg	43.6 E	.7 S
" 6 End	44.5 E	.7 S
" 7 Beg.	44.6 E	.5 S
" 7 End	46.1 E	.5 S
" 8 Beg.	46.3 E	1.0 S
" 8 End	47.2 E	1.0 S
" 9 Beg	51.3 E	2.5 S
" 9 End	53.1 E	2.5 S
" 10 Beg	55.2 E	2.6 S
" 10 End	56.4	2.6 S
RP	0	.4 S
Mid pt on yaw (LR)	25.2 E	1.4 N
transfer on curb beg.	26.6 E	0
" " end.	27.2 E	0
Gauge 11 Beg	55.6 E	1.3 S
" 11 end	60.3 E	1.3 S

on road
off curb

off curb

off curb



ACCIDENT FORM

1. Primary Sampling Unit Number 04
 2. Case Number - Stratum 029A

IDENTIFICATION

3. Number of General Vehicle Forms Submitted 01
 4. Date of Accident (Month, Day, Year) [REDACTED] / [REDACTED] / 9 5
 5. Time of Accident 0348
 Code reported military time of accident.
 NOTE: Midnight = 2400
 Unknown = 9999

SPECIAL STUDIES - INDICATORS

Check (✓) each special study (SS15-SS18 below) that has been completed; code 1 for the checked special studies and 0 for the special studies not checked.

6. 0 SS15 Administrative Use
 7. 0 SS16 Pedestrian Crash Data Study
(Data for this special study available in a separate file.)
 8. 0 SS17 Impact Fires
 9. 0 SS18 Unsafe Driver Actions
 10. 0 SS19 _____

NUMBER OF EVENTS

11. Number of Recorded Events in This Accident 02
 Code the number of events which occurred in this accident.

ACCIDENT EVENTS

For each event that occurred in the accident, code the lowest numbered vehicle in the left columns and the other involved vehicle or object in the right columns.

Accident Event Sequence Number	Vehicle Number	Class Of Vehicle	General Area of Damage	Vehicle Number or Object Contacted	Class Of Vehicle	General Area of Damage
12. <u>0 1</u>	13. <u>01</u>	14. <u>01</u>	15. <u>F</u>	16. <u>52</u>	17. <u>00</u>	18. <u>0</u>
19. <u>0 2</u>	20. <u>01</u>	21. <u>01</u>	22. <u>I</u>	23. <u>31</u>	24. <u>00</u>	25. <u>N</u>
26. <u>0 3</u>	27. _____	28. _____	29. _____	30. _____	31. _____	32. _____
33. <u>0 4</u>	34. _____	35. _____	36. _____	37. _____	38. _____	39. _____
40. <u>0 5</u>	41. _____	42. _____	43. _____	44. _____	45. _____	46. _____

IF GREATER THAN FIVE EVENTS, CONTINUE CODING ON THE ACCIDENT EVENT SUPPLEMENT

CODES FOR CLASS OF VEHICLE

- | | |
|--|--|
| <ul style="list-style-type: none"> (00) Not a motor vehicle (01) Subcompact/mini (wheelbase < 254 cm) (02) Compact (wheelbase ≥ 254 but < 265 cm) (03) Intermediate (wheelbase ≥ 265 but < 278 cm) (04) Full size (wheelbase ≥ 278 but < 291 cm) (05) Largest (wheelbase ≥ 291 cm) (09) Unknown passenger car size (14) Compact utility vehicle (15) Large utility vehicle (≤ 4,500 kgs GVWR) (16) Utility station wagon (≤ 4,500 kgs GVWR) (19) Unknown utility type (20) Minivan (≤ 4,500 kgs GVWR) (21) Large van (≤ 4,500 kgs GVWR) (24) Van Based school bus (≤ 4,500 kgs GVWR) (28) Other van type (≤ 4,500 kgs GVWR) (29) Unknown van type (≤ 4,500 kgs GVWR) (30) Compact pickup truck (≤ 4,500 kgs GVWR) | <ul style="list-style-type: none"> (31) Large pickup truck (≤ 4,500 kgs GVWR) (38) Other pickup truck (≤ 4,500 kgs GVWR) (39) Unknown pickup truck type (≤ 4,500 kgs GVWR) (45) Other light truck (≤ 4,500 kgs GVWR) (48) Unknown light truck type (≤ 4,500 kgs GVWR) (49) Unknown light vehicle type (50) School bus (excludes van based)(> 4,500 kgs GVWR) (58) Other bus (> 4,500 kgs GVWR) (59) Unknown bus type (60) Truck (> 4,500 kgs GVWR) (67) Tractor without trailer (68) Tractor-trailer(s) (78) Unknown medium/heavy truck type (79) Unknown light/medium/heavy truck type (80) Motored cycle (90) Other vehicle (99) Unknown |
|--|--|

CODES FOR GENERAL AREA OF DAMAGE (GAD)

- | | | | |
|--|--|---|---|
| CDS APPLICABLE AND OTHER VEHICLES | <ul style="list-style-type: none"> (O) Not a motor vehicle (N) Noncollision (F) Front | <ul style="list-style-type: none"> (R) Right side (L) Left side (B) Back | <ul style="list-style-type: none"> (T) Top (U) Undercarriage (9) Unknown |
| TDC APPLICABLE VEHICLES | <ul style="list-style-type: none"> (O) Not a motor vehicle (N) Noncollision (F) Front (R) Right side | <ul style="list-style-type: none"> (L) Left side (B) Back of unit with cargo area (rear of trailer or straight truck) (D) Back (rear of tractor) | <ul style="list-style-type: none"> (C) Rear of cab (V) Front of cargo area (T) Top (U) Undercarriage (9) Unknown |

CODES FOR VEHICLE NUMBER OR OBJECT CONTACTED

- | | |
|--|---|
| <p>(01-30) – Vehicle Number</p> <p>Noncollision</p> <ul style="list-style-type: none"> (31) Overturn – rollover (excludes end-over-end) (32) Rollover – end-over-end (33) Fire or explosion (34) Jackknife (35) Other intraunit damage (specify): _____ (36) Noncollision injury (38) Other noncollision (specify): _____ (39) Noncollision – details unknown <p>Collision With Fixed Object</p> <ul style="list-style-type: none"> (41) Tree (≤ 10 cm in diameter) (42) Tree (> 10 cm in diameter) (43) Shrubbery or bush (44) Embankment (45) Breakaway pole or post (any diameter) <p>Nonbreakaway Pole or Post</p> <ul style="list-style-type: none"> (50) Pole or post (≤ 10 cm in diameter) (51) Pole or post (> 10 cm but ≤ 30 cm in diameter) (52) Pole or post (> 30 cm in diameter) (53) Pole or post (diameter unknown) (54) Concrete traffic barrier (55) Impact attenuator (56) Other traffic barrier (includes guardrail) (specify): _____ | <ul style="list-style-type: none"> (57) Fence (58) Wall (59) Building (60) Ditch or culvert (61) Ground (62) Fire hydrant (63) Curb (64) Bridge (68) Other fixed object (specify): _____ (69) Unknown fixed object <p>Collision with Nonfixed Object</p> <ul style="list-style-type: none"> (70) Passenger car, light truck, van, or other vehicle not in-transport (71) Medium/heavy truck or bus not in-transport (72) Pedestrian (73) Cyclist or cycle (74) Other nonmotorist or conveyance (75) Vehicle occupant (76) Animal (77) Train (78) Trailer, disconnected in transport (79) Object fell from vehicle in-transport (88) Other nonfixed object (specify): _____ (89) Unknown nonfixed object (98) Other event (specify): _____ (99) Unknown event or object |
|--|---|

PRECRASH ENVIRONMENTAL DATA

19. Relation To Interchange Or Junction 0
 (0) Non-interchange area and non-junction
 (1) Interchange area related

Non-Interchange junctions

- (2) Intersection related
- (3) Driveway, alley access related
- (4) Other junction (specify)

(5) _____

(9) Unknown

20. Trafficway Flow 0
 (0) Not physically divided (two way traffic)
 (1) Divided trafficway-median strip without positive barrier
 (2) Divided trafficway-median strip with positive barrier
 (3) One way traffic
 (9) Unknown

21. Number Of Travel Lanes 4
 (1) One
 (2) Two
 (3) Three
 (4) Four
 (5) Five
 (6) Six
 (7) Seven or more
 (9) Unknown

22. Roadway Alignment 3
 (1) Straight
 (2) Curve right
 (3) Curve left
 (9) Unknown

23. Roadway Profile 1
 (1) Level
 (2) Uphill grade (> 2%)
 (3) Hill crest
 (4) Downhill grade (> 2%)
 (5) Sag
 (9) Unknown

24. Roadway Surface Type 2
 (1) Concrete
 (2) Bituminous (asphalt)
 (3) Brick or block
 (4) Slag, gravel, or stone
 (5) Dirt
 (8) Other (specify): _____
 (9) Unknown

25. Roadway Surface Condition 1
 (1) Dry
 (2) Wet
 (3) Snow or slush
 (4) Ice
 (5) Sand, dirt, or oil
 (8) Other (specify): _____
 (9) Unknown

26. Light Conditions 3
 (1) Daylight
 (2) Dark
 (3) Dark, but lighted
 (4) Dawn
 (5) Dusk
 (9) Unknown

27. Atmospheric Conditions 0
 (0) No adverse atmospheric-related driving conditions
 (1) Rain
 (2) Sleet/hail
 (3) Snow
 (4) Fog
 (5) Rain and fog
 (6) Sleet and fog
 (7) Other (e.g., smog, smoke, blowing sand or dust, etc.) (specify): _____
 (9) Unknown

28. Traffic Control Device 0
 (0) No traffic control(s)
 (1) Traffic control signal (not RR crossing)

Regulatory
 (2) Stop sign
 (3) Yield sign
 (4) School zone sign
 (5) Other regulatory sign (specify): _____
 (6) Warning sign (not RR crossing)
 (7) Unknown sign
 (8) Miscellaneous/other controls including RR controls (specify): _____
 (9) Unknown

29. Traffic Control Device Functioning 0
 (0) No traffic control device
 (1) Traffic control device not functioning (specify): _____
 (2) Traffic control device functioning properly
 (9) Unknown

OCCUPANT RELATED

- 37. Driver Presence in Vehicle 1
 (0) Driver not present
 (1) Driver present
 (9) Unknown
- 38. Number of Occupants This Vehicle 01
 (00-96) Code actual number of occupants for this vehicle
 (97) 97 or more
 (99) Unknown
- 39. Number of Occupant Forms Submitted 01

AIR BAG RELATED

- 40. Is this an AOPS Vehicle? 1
 (0) No (includes unknown)
 (1) Yes - researcher determined
 (2) VIN determined air bag system
 (3) VIN determined automatic (passive) belts
 (4) VIN determined air bag and automatic (passive) belts
- 41. Air Bag(s) Deployment, First Seat Frontal 2
 (0) Not equipped or not available
 (1) No air bags deployed
Single Air Bag Vehicle
 (2) Driver air bag deployed
 (3) Driver air bag, unknown if deployed
Multiple Air Bag Vehicle
 (4) Driver side only deployed
 (5) Passenger side only deployed
 (6) Driver and passenger side deployed
 (7) Driver and passenger side unknown if deployed
 (8) Air bag(s) deployed, details unknown
 (9) Unknown
- 42. Air Bag(s) Deployment, Other Than First Seat Frontal 0
 (0) Not equipped with an "other" air bag
 (1) Deployed during accident (as a result of impact)
 (2) Deployed inadvertently just prior to accident
 (3) Deployed, details unknown
 (4) Deployed as a result of a noncollision event during accident sequence (e.g., fire, explosion, electrical)
 (5) Unknown if deployed
 (7) Nondeployed
 (9) Unknown

Specify type of "other" air bag present: _____

VEHICLE WEIGHT ITEMS

- 43. Vehicle Curb Weight 1,190
 Code weight to nearest 10 kilograms.
 (045) Less than 450 kilograms
 (610) 6,100 kilograms or more
 (999) Unknown
2613 lbs X .4536 = 1,185 kgs
 Source: _____

- 44. Vehicle Cargo Weight 0,000
 Code weight to nearest 10 kilograms.
 (000) Less than 5 kilograms
 (450) 4,500 kilograms or more
 (999) Unknown
 _____ lbs X .4536 = _____ kgs
 Source: _____

ROLLOVER DATA

- 45. Rollover 04
 (00) No rollover (no overturning)
Rollover (primarily about the longitudinal axis)
 (01-16) Code the number of quarter turns
 (17) Rollover, 17 or more quarter turns (specify): _____
 (98) Rollover--end-over-end (i.e., primarily about the lateral axis)
 (99) Rollover (overturn), details unknown
- 46. Rollover Initiation Type 06
 (00) No rollover
 (01) Trip-over
 (02) Flip-over
 (03) Turn-over
 (04) Climb-over
 (05) Fall-over
 (06) Bounce-over
 (07) Collision with another vehicle
 (08) Other rollover initiation type specify): _____
 (98) Rollover--end-over-end
 (99) Unknown rollover initiation type
- 47. Location of Rollover Initiation 4
 (0) No rollover
 (1) On roadway
 (2) On shoulder—paved
 (3) On shoulder—unpaved
 (4) On roadside or divided trafficway median
 (8) Rollover--end-over-end
 (9) Unknown
- 48. Rollover Initiation Object Contacted 52
 (Note: Applicable codes on back of page)
- 49. Location on Vehicle Where Initial Principal Tripping Force Is Applied 3
 (0) No rollover
 (1) Wheels/tires
 (2) Side plane
 (3) End plane
 (4) Undercarriage
 (5) Other location on vehicle (specify): _____
 (6) Non-contact rollover forces (specify): _____
 (8) Rollover--end-over-end
 (9) Unknown
- 50. Direction of Initial Roll 2
 (0) No rollover
 (1) Roll right - primarily about the longitudinal axis
 (2) Roll left - primarily about the longitudinal axis
 (8) Rollover--end-over-end
 (9) Unknown roll direction

CODES FOR ROLLOVER INITIATION OBJECT CONTACTED

- (00) No rollover
- (01-30) — Vehicle Number

Noncollision

- (31) Turn-over — fall-over
- (32) No rollover impact initiation (end-over-end)
- (34) Jackknife

Collision With Fixed Object

- (41) Tree (≤ 10 cm in diameter)
- (42) Tree (> 10 cm in diameter)
- (43) Shrubbery or bush
- (44) Embankment

- (45) Breakaway pole or post (any diameter)

Nonbreakaway Pole or Post

- (50) Pole or post (≤ 10 cm in diameter)
- (51) Pole or post (> 10 cm but ≤ 30 cm in diameter)
- (52) Pole or post (> 30 cm in diameter)
- (53) Pole or post (diameter unknown)

- (54) Concrete traffic barrier
- (55) Impact attenuator
- (56) Other traffic barrier (includes guardrail)
(specify): _____

- (57) Fence
- (58) Wall
- (59) Building
- (60) Ditch or culvert
- (61) Ground
- (62) Fire hydrant
- (63) Curb
- (64) Bridge
- (68) Other fixed object (specify): _____

- (69) Unknown fixed object _____

Collision with Nonfixed Object

- (70) Passenger car, light truck, van, or other vehicle not in-transport
- (71) Medium/heavy truck or bus not in-transport
- (76) Animal
- (77) Train
- (78) Trailer, disconnected in transport
- (79) Object fell from vehicle in-transport
- (88) Other nonfixed object (specify): _____

- (89) Unknown nonfixed object _____

- (98) Other event (specify): _____

- (99) Unknown event or object _____



EXTERIOR VEHICLE FORM

1. Primary Sampling Unit Number <u>04</u>	3. Vehicle Number <u>01</u>
2. Case Number - Stratum <u>029A</u>	

VEHICLE IDENTIFICATION

VIN 1B3XP6437PN ~~XXXXXXXXXX~~ Model Year 93
 Vehicle Make (specify): Dodge Vehicle Model (specify): Shadow ES

LOCATOR

Locate the end of the damage with respect to the vehicle longitudinal center line or bumper corner for end impacts or an undamaged axle for side impacts.

Specific Impact No.	Location of Direct Damage	Location of Field L	Location of Max Crush
1	Beg @ C-5 runs 21.0	RAD support corner to RAD support corner	@ C-6

CRUSH PROFILE IN CENTIMETERS

NOTES: Identify the plane at which the C-measurements are taken (e.g., at bumper, above bumper, at sill, above sill, etc.) and label adjustments (e.g., free space).

Measure C1 to C6 from driver to passenger side in front or rear impacts and rear to front in side impacts.

Free space value is defined as the distance between the baseline and the original body contour taken at the individual C locations. This may include the following: bumper lead, bumper taper, side protrusion, side taper, etc. Record the value for each C-measurement and maximum crush.

Use as many lines/columns as necessary to describe each damage profile.

Specific Impact Number	Plane of Impact C-Measurements	Direct Damage		Field L	C ₁	C ₂	C ₃	C ₄	C ₅	C ₆	±D
		Width (CDC)	Max Crush								
1	RADIATOR SUPPORT	21.0	111.0	106.0	39.5	42.0	48.0	58.5	78.0	111.0	+54
-	Free space	-	22.0	-	22.0	4.0	3.0	3.0	11.0	22.0	-
-	Actual	21.0	106.0	106.0							+54
-	Bumper difference		11		11	11	11	11	11	11	
-	ACTUAL	21.0	78.0	106.0	6.5	20	34	34.5	56	78	+54
meas. taken out / used for bumper equivalent (rem) - taken @ radiator support - if OAT may not be correct due to rear bumper deformation.											

ORIGINAL SPECIFICATIONS WORK SHEET

Wheelbase	<u>97.2</u>	inches	x 2.54	=	<u>247</u>	cm
Overall Length	<u>171.9</u>	inches	x 2.54	=	<u>437</u>	cm
Maximum Width	<u>67.3</u>	inches	x 2.54	=	<u>171</u>	cm
Curb Weight	<u>2,613</u>	pounds	x .4536	=	<u>1,185</u>	kg
Average Track	<u>57.4</u>	inches	x 2.54	=	<u>146</u>	cm
Front Overhang	_____	inches	x 2.54	=	_____	cm
Rear Overhang	_____	inches	x 2.54	=	_____	cm
Undeformed End Width	_____	inches	x 2.54	=	_____	cm
Engine Size: cyl./displ.	_____	cc	x .001	=	<u>3.0</u>	L
	_____	CID	x .0164	=	<u>3.0</u>	L
					<u>6 cyl.</u>	

VEHICLE DAMAGE SKETCH

<p>TIRE—WHEEL DAMAGE</p> <p>a. Rotation physically restricted b. Tire deflated</p> <p>RF <u>1</u> RF <u>1</u> LF <u>2</u> LF <u>1</u> RR <u>2</u> RR <u>2</u> LR <u>2</u> LR <u>1</u></p> <p>(1) Yes (2) No (8) NA (9) Unk.</p>	<p>ORIGINAL SPECIFICATIONS</p> <p>Wheelbase <u>247</u> cm Overall Length <u>437</u> cm Maximum Width <u>171</u> cm Curb Weight <u>1185</u> kg Average Track <u>146</u> cm Front Overhang _____ cm Rear Overhang _____ cm Undeformed End Width <u>170</u> cm Engine Size: cyl./displ. <u>3.0/6 cyl</u> L</p>	<p>WHEEL STEER ANGLES (For locked front wheels or displaced rear axles only)</p> <p>RF <u>30</u> ° LF ± _____ ° RR ± _____ ° LR ± _____ °</p> <p>Within ± 5 degrees</p>
<p>TYPE OF TRANSMISSION</p> <p><input checked="" type="checkbox"/> Manual <input type="checkbox"/> Automatic</p> <p>END SHIFT ≥ 10 CM</p> <p><input type="checkbox"/> Yes <input checked="" type="checkbox"/> No</p>	<p>DRIVE WHEELS</p> <p><input checked="" type="checkbox"/> FWD <input type="checkbox"/> RWD <input type="checkbox"/> 4WD</p> <p>Approximate Cargo Weight <u>0</u> INSP kg</p>	

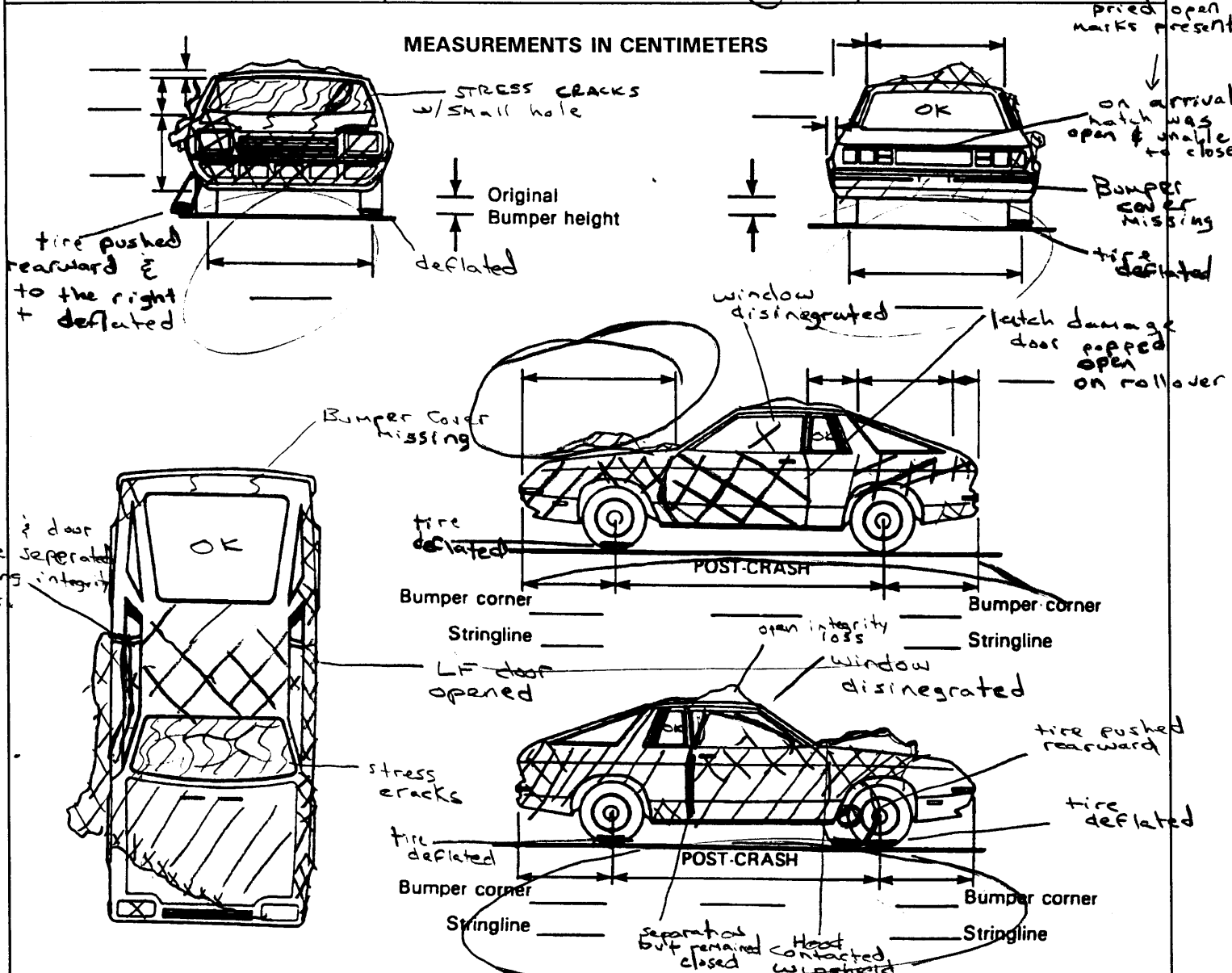

NOTES: Sketch new perimeter and cross hatch direct damage and single hatch induced damage on all views. Annotate observations which might be useful in reconstructing the accident (e.g., grass in tire bead, direction of striations, scuff on sidewalls, etc.). If pulling trailer, sketch type of trailer and damage received on the back of this page.

Annotate any damage caused by extrication such as component removal by torching, prying, or hydraulic shears.

COLLISION DEFORMATION CLASSIFICATION

HIGHEST DELTA "V"

Accident Event Sequence Number	Object Contacted	(1) (2) Direction of Force	(3) Deformation Location	(4) Longitudinal or Lateral Location	(5) Vertical or Lateral Location	(6) Type of Damage Distribution	(7) Deformation Extent
4. <u>01</u>	5. <u>B2</u>	6. <u>12</u>	7. <u>F</u>	8. <u>R</u>	9. <u>E</u>	10. <u>E</u>	11. <u>04</u>

Second Highest Delta "V"

12. <u>02</u>	13. <u>31</u>	14. <u>00</u>	15. <u>T</u>	16. <u>D</u>	17. <u>D</u>	18. <u>0</u>	19. <u>01</u>
---------------	---------------	---------------	--------------	--------------	--------------	--------------	---------------

CRUSH PROFILE IN CENTIMETERS

The crush profile for the damage described in the CDC(s) above should be documented in the appropriate space below. (ALL MEASUREMENTS ARE IN CENTIMETERS.)

HIGHEST DELTA "V"

20. L	21. C ₁	C ₂	C ₃	C ₄	C ₅	C ₆	22. ±D
<u>N/A - insufficient measurements</u>							<u>+</u>
							<u>-</u>

Second Highest Delta "V"

23. L	24. C ₁	C ₂	C ₃	C ₄	C ₅	C ₆	25. ±D
<u>N/A - insufficient</u>							<u>+</u>
							<u>-</u>

26. Undeformed End Width
(Coded when highest severity impact is an end plane impact.) 120
 _____ Code to the nearest centimeter
 (250) 250 centimeters or more
 (998) No highest severity end plane impact
 (999) Unknown

27. Direct Damage Width
(For highest severity impact) 021
 _____ Code to the nearest centimeter
 (250) 250 centimeters or more
 (999) Unknown

28. Original Wheelbase 247
 _____ Code to the nearest centimeter
 (650) 650 centimeters or more
 (999) Unknown
 _____ inches X 2.54 = _____ centimeters

29. Original Average Track Width 146
 _____ Code to the nearest centimeter
 (185) 185 centimeters or more
 (999) Unknown
 _____ inches X 2.54 = _____ centimeters

		FUEL SYSTEM	
<p>30. Are CDCs Documented but Not Coded on The Automated File? (0) No (1) Yes</p>	1	<p>35. Location of Fuel Tank-1 Filler Cap</p>	3
<p>31. Researcher's Assessment of Vehicle Disposition (0) Not towed due to vehicle damage (1) Towed due to vehicle damage (9) Unknown</p>	1	<p>36. Location of Fuel Tank-2 Filler Cap (0) No fuel tank (1) On back plane (2) Aft of center of the rear wheels (rear axle) on left side plane (3) Aft of center of the rear wheels (rear axle) on right side plane (4) Forward of center of the rear wheels (rear axle) on left side plane (5) Forward of center of the rear wheels (rear axle) on right side plane (6) Over the center of the rear wheels (rear axle) on left side plane (7) Over the center of the rear wheels (rear axle) on right side plane (8) Other (specify): _____ (9) Unknown</p>	10
<p>32. Is This A Multi-Stage Manufactured Vehicle And/Or A Certified Altered Vehicle? (0) No post manufacturer modifications (1) Yes - post manufacturer modifications (specify): _____ _____ _____ (Include photograph of CERTIFICATION PLACARD in case report) (9) Unknown if vehicle is modified</p>	0	<p>37. Type of Fuel Tank-1</p>	1
FIRE OCCURRENCE		<p>38. Type of Fuel Tank-2 (0) No fuel tank (electrical vehicle) (1) Metallic (2) Non-metallic (9) Unknown</p>	0
<p>33. Fire Occurrence (0) No fire Yes, fire occurred (1) Minor (2) Major (9) Unknown</p>	0	<p>39. Location of Fuel Tank-1</p>	4
<p>34. Origin of Fire (0) No fire (1) Vehicle exterior (front, side, back, top) (2) Exhaust system (3) Fuel tank (and other fuel retention system parts) (4) Engine compartment (5) Cargo/trunk compartment (6) Instrument panel (7) Passenger compartment area (8) Other location (specify): _____ (9) Unknown</p>	0	<p>40. Location of Fuel Tank-2 (0) No fuel tank (1) Aft of center of the rear wheels (rear axle) centered (2) Aft of center of the rear wheels (rear axle) left side (3) Aft of center of the rear wheels (rear axle) right side (4) Forward of center of the rear wheels (rear axle) centered (5) Forward of center of the rear wheels (rear axle) left side (6) Forward of center of the rear wheels (rear axle) right side (7) Over center of the rear wheels (rear axle) (8) Other (specify): _____ (9) Unknown</p>	10
		<p>41. Damage to Fuel Tank-1</p>	1
		<p>42. Damage to Fuel Tank-2 (0) No fuel tank (1) No damage to fuel tank (2) Deformed, no seam failure (3) Deformed, with a seam failure (4) Punctured (5) Lacerated (ripped) (6) Abraded (scraped) (7) Filler neck separation from the fuel tank (8) Other damage (specify): _____ (9) Unknown</p>	0

43. Leakage Location of Fuel System-1 1

44. Leakage Location of Fuel System-2 0

(0) No fuel tank
 (1) No fuel leakage

Primary Area Of Leakage

(2) Tank
 (3) Filler neck
 (4) Cap
 (5) Lines/pump/filter
 (6) Vent/emission recovery
 (8) Other (specify): _____
 (9) Unknown

45. Fuel Type-1 01

46. Fuel Type-2 00

Single Fuel Type

(00) No fuel tank
 (01) Gasoline
 (02) Diesel
 (03) CNG (Compressed Natural Gas)
 (04) LPG (Liquid Petroleum Gas) also known as Propane
 (05) LNG (Liquid Natural Gas)
 (06) Methanol (M100 or M85)
 (07) Ethanol (E100 or E85)
 (08) Other (Hydrogen or others) (specify): _____

Electric Powered or Electric/Solar Powered Vehicles

(10) Lead Acid Battery
 (11) Nickel-Iron Battery
 (12) Nickel-Cadmium Battery
 (13) Sodium Metal Chloride Battery
 (14) Sodium Sulfur Battery
 (18) Other (Specify): _____

(98) Other Hybrid (specify): _____

(99) Unknown fuel type

47. Is This Vehicle Equipped With More Than Two Fuel Tanks? 0

(0) No (one or two tanks only)

Yes - More Than Two Tanks

(1) Yes -- no damage to any tank or filler cap and no fuel system leakage

(2) Yes -- no damage to any tank or filler cap but there is fuel system leakage (specify leakage location): _____

(3) Yes -- damage to an additional tank or filler cap and there is fuel system leakage (specify the following):
 Type of tank _____
 Tank location _____
 Filler cap location _____
 Tank damage _____
 Location of leakage _____
 Type of fuel _____

(9) Unknown if more than two tanks

COMMENTS

*** STOP: IF THE CDS APPLICABLE VEHICLE WAS NOT TOWED ***

(GV10=0)

DO NOT COMPLETE THE INTERIOR VEHICLE FORM.



INTERIOR VEHICLE FORM

1. Primary Sampling Unit Number 04
 2. Case Number - Stratum 029A
 3. Vehicle Number 01

INTEGRITY

4. Passenger Compartment Integrity 98
 (00) No integrity loss

Yes, Integrity Was Lost Through

- (01) Windshield
- (02) Door (side)
- (03) Door/hatch (back door)
- (04) Roof
- (05) Roof glass
- (06) Side window
- (07) Rear window (backlight)
- (08) Roof and roof glass
- (09) Windshield and door (side)
- (10) Windshield and roof
- (11) Side and rear window (side window and backlight)
- (12) Windshield and side window
- (13) Door and side window
- (98) Other combination of above (specify):
 door + side window door + side win.
- (99) Unknown

Door, Tailgate or Hatch Opening

5. LF 2 6. RF 9 7. LR 0 8. RR 0 9. TG/H 1

- (0) No door/gate/hatch
- (1) Door/gate/hatch remained closed and operational
- (2) Door/gate/hatch came open during collision
- (3) Door/gate/hatch jammed shut
- (8) Other (specify):
- (9) Unknown

Damage/Failure Associated with Door, Tailgate or Hatch Opening in Collision. If IV05-IV09 ≠ 2, Then code 0

10. LF 2 11. RF 0 12. LR 0 13. RR 0 14. TG/H 0

- (0) No door/gate/hatch or door not opened

Door, Tailgate or Hatch Came Open During Collision

- (1) Door operational (no damage)
- (2) Latch/striker failure due to damage
- (3) Hinge failure due to damage
- (4) Door structure failure due to damage
- (5) Door support (i.e., pillar, sill, roof side rail, etc.) failure due to damage
- (6) Latch/striker and hinge failure due to damage
- (8) Other failure (specify):
- (9) Unknown

GLAZING

Type of Window/Windshield Glazing

15. WS 1 16. LF 2 17. RF 2 18. LR 2 19. RR 2
 20. BL 2 21. Roof 0 22. Other 0

- (0) No glazing
- (1) AS-1 - Laminated
- (2) AS-2 - Tempered
- (3) AS-3 - Tempered-tinted (original)
- (4) AS-2 - Tempered-with after market tint
- (5) AS-3 - Tempered-tinted (with additional after market tint)
- (6) AS-14 - Glass/Plastic
- (7) Glazing removed prior to accident
- (8) Other (specify):
- (9) Unknown

Window Precrash Glazing Status

23. WS 1 24. LF 2 25. RF 2 26. LR 1 27. RR 1
 28. BL 1 29. Roof 0 30. Other 0

- (0) No glazing
- (1) Fixed
- (2) Closed
- (3) Partially opened
- (4) Fully opened
- (7) Glazing removed prior to accident
- (9) Unknown

Glazing Damage from Impact Forces

31. WS 2 32. LF 6 33. RF 6 34. LR 1 35. RR 1
 36. BL 1 37. Roof 0 38. Other 0

- (0) No glazing
- (1) No glazing damage from impact forces
- (2) Glazing in place and cracked from impact forces
- (3) Glazing in place and holed from impact forces
- (4) Glazing out-of-place (cracked or not) and not holed from impact forces
- (5) Glazing out-of-place and holed from impact forces
- (6) Glazing disintegrated from impact forces
- (7) Glazing removed prior to accident
- (9) Unknown if damaged

Glazing Damage from Occupant Contact

39. WS 1 40. LF 1 41. RF 1 42. LR 1 43. RR 1
 44. BL 1 45. Roof 0 46. Other 0

- (0) No glazing
- (1) No occupant contact to glazing
- (2) Glazing contacted by occupant but no glazing damage
- (3) Glazing in place and cracked by occupant contact
- (4) Glazing in place and holed by occupant contact
- (5) Glazing out-of-place (cracked or not) by occupant contact and not holed by occupant contact
- (6) Glazing out-of-place by occupant contact and holed by occupant contact
- (7) Glazing removed prior to accident
- (8) Glazing disintegrated by occupant contact
- (9) Unknown if contacted by occupant

INTRUSION WORKSHEET

Note: Sketch intruded areas

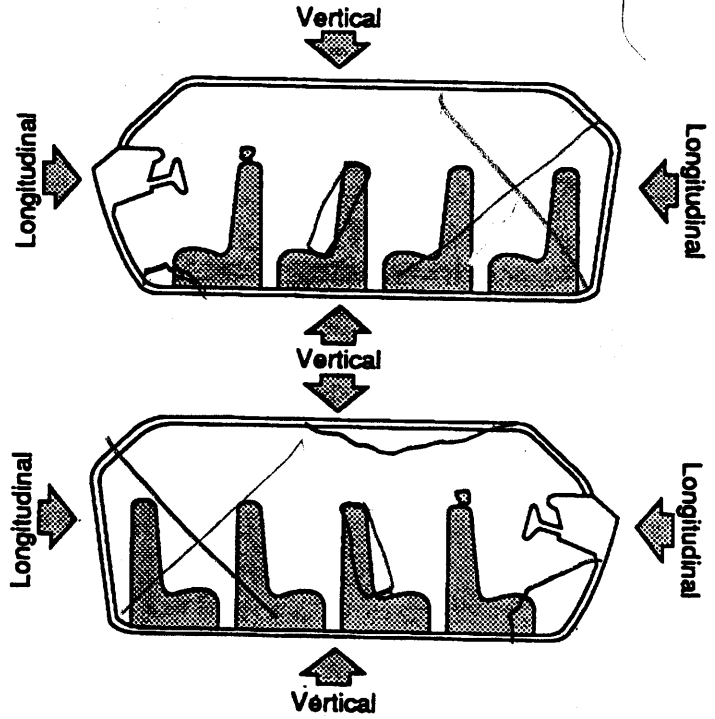
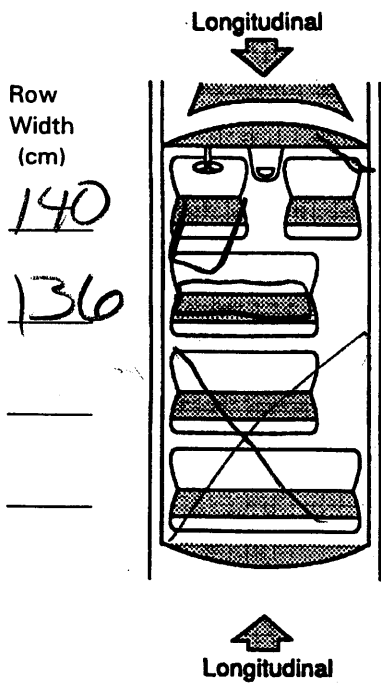

LOCATION OF INTRUSION	INTRUDED COMPONENT	(All Measurements Are In Centimeters)			DOMINANT CRUSH DIRECTION
		COMPARISON VALUE	INTRUDED VALUE	INTRUSION	
21	Driver Seat Back	76	46	30 ✓	long
21	Seat Back	-	-	15 ✓	long
22	Seat Back	-	-	19 ✓	Long
23	Seat Back	-	-	21 ✓	Long
12	Roof	38	33	5 ✓	vert
13	Roof	38	30	8 ✓	vert
23	Roof	38	35	3	vert
12	Transaxle Hump	21	17	4 ✓	vert
13	Toe Pan	50	15	35 ✓	long
13	Kick Panel	60	36	24 ✓	Lat
13	Glove Door	-	-	6	Long
13	Door Panel	68	57	11 ✓	Lat
		-	-	=	
11	Floor Pan	-	-	3	vert
		-	-	=	

Back Seat

OCCUPANT AREA INTRUSION

Note: If no intrusions, leave variables IV47-IV86 blank.

	Location of Intrusion	Intruding Component	Magnitude of Intrusion	Dominant Crush Direction
1st	47. <u>13</u>	48. <u>05</u>	49. <u>4</u>	50. <u>2</u>
2nd	51. <u>21</u>	52. <u>20</u>	53. <u>4</u>	54. <u>2</u>
3rd	55. <u>13</u>	56. <u>10</u>	57. <u>3</u>	58. <u>3</u>
4th	59. <u>23</u>	60. <u>24</u>	61. <u>3</u>	62. <u>2</u>
5th	63. <u>22</u>	64. <u>21</u>	65. <u>3</u>	66. <u>2</u>
6th	67. <u>21</u>	68. <u>21</u>	69. <u>3</u>	70. <u>2</u>
7th	71. <u>13</u>	72. <u>11</u>	73. <u>2</u>	74. <u>3</u>
8th	75. <u>13</u>	76. <u>13</u>	77. <u>2</u>	78. <u>1</u>
9th	79. <u>12</u>	80. <u>13</u>	81. <u>1</u>	82. <u>1</u>
10th	83. <u>12</u>	84. <u>27</u>	85. <u>1</u>	86. <u>1</u>

INTRUDING COMPONENT

Interior Components

- (01) Steering assembly
- (02) Instrument panel left
- (03) Instrument panel center
- (04) Instrument panel right
- (05) Toe pan
- (06) A (A1/A2)-pillar
- (07) B-pillar
- (08) C-pillar
- (09) D-pillar
- (10) Side panel - forward of the A1/A2-pillar
- (11) Door panel (side)
- (12) Side panel - rear of the B-pillar
- (13) Roof (or convertible top)
- (14) Roof side rail
- (15) Windshield
- (16) Windshield header
- (17) Window frame
- (18) Floor pan (includes sill)
- (19) Backlight header
- (20) Front seat back
- (21) Second seat back
- (22) Third seat back
- (23) Fourth seat back
- (24) Fifth seat back
- (25) Seat cushion
- (26) Back door/panel (e.g., tailgate)
- (27) Other interior component (specify):

TRANSAXLE hump

Exterior Components

- (30) Hood
- (31) Outside surface of this vehicle (specify):
- (32) Other exterior object in the environment (specify):
- (33) Unknown exterior object
- (97) Catastrophic
- (98) Intrusion of unlisted component(s) (specify):
- (99) Unknown

LOCATION OF INTRUSION

- | | |
|--|---|
| <p>Front Seat</p> <ul style="list-style-type: none"> (11) Left (12) Middle (13) Right <p>Second Seat</p> <ul style="list-style-type: none"> (21) Left (22) Middle (23) Right <p>Third Seat</p> <ul style="list-style-type: none"> (31) Left (32) Middle (33) Right | <p>Fourth Seat</p> <ul style="list-style-type: none"> (41) Left (42) Middle (43) Right <p>(97) Catastrophic</p> <p>(98) Other enclosed area (specify)</p> <p>(99) Unknown</p> |
|--|---|

MAGNITUDE OF INTRUSION

- (1) ≥ 3 centimeters but < 8 centimeters
- (2) ≥ 8 centimeters but < 15 centimeters
- (3) ≥ 15 centimeters but < 30 centimeters
- (4) ≥ 30 centimeters but < 46 centimeters
- (5) ≥ 46 centimeters but < 61 centimeters
- (6) ≥ 61 centimeters
- (7) Catastrophic
- (9) Unknown

DOMINANT CRUSH DIRECTION

- (1) Vertical
- (2) Longitudinal
- (3) Lateral
- (7) Catastrophic
- (9) Unknown

STEERING RIM/SPOKE DEFORMATION

(All Measurements Are in Centimeters)

COMPARISON VALUE	—	DAMAGE VALUE	=	DEFORMATION
------------------	---	--------------	---	-------------

	—		=	
--	---	--	---	--



	—		=	
--	---	--	---	--

	—		=	
--	---	--	---	--

	—		=	
--	---	--	---	--

STEERING COLUMN

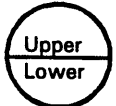
INSTRUMENT PANEL

87. Steering Column Type 2
 (1) Fixed column
 (2) Tilt column
 (3) Telescoping column
 (4) Tilt and telescoping column
 (8) Other column type (specify): _____
 (9) Unknown
88. Tilt Steering Column Adjustment 1
 (0) No tilt steering column
 (1) Full up
 (2) Between full up and center
 (3) Center
 (4) Between center and full down
 (5) Full down
 (9) Unknown
89. Telescoping Steering Column Adjustment 0
 (0) No telescoping steering column
 (1) Full back
 (2) Between full back and midpoint
 (3) Midpoint
 (4) Between midpoint and full forward
 (5) Full forward
 (9) Unknown
90. Steering Rim/Spoke Deformation 00
 Code actual measured
 deformation to the nearest centimeter
 (00) No steering rim deformation
 (01-14) Actual measured value in centimeters
 (15) 15 centimeters or more
 (98) Observed deformation cannot be measured
 (99) Unknown
91. Location of Steering Rim/Spoke Deformation 00
 (00) No steering rim deformation
- Quarter Sections*
 (01) Section A
 (02) Section B
 (03) Section C
 (04) Section D
- 
- Half Sections*
 (05) Upper half of rim/spoke
 (06) Lower half of rim/spoke
 (07) Left half of rim/spoke
 (08) Right half of rim/spoke
- 
- 
- (09) Complete steering wheel collapse
 (10) Undetermined location
 (99) Unknown

92. Odometer Reading + 37,000
 kilometers
 Code to the nearest 1,000 kilometers
 (000) No odometer
 (001) Less than 1,500 kilometers
 (500) 499,500 kilometers or more
 (999) Unknown
85,000 miles X 1.6093 = 136,791 kilometers
 Source: _____
93. Instrument Panel Damage from Occupant Contact? 1
 (0) No
 (1) Yes
 (9) Unknown
94. Type of Knee Bolster Covering 2
 (0) No knee bolster
 (1) Padded
 (2) Rigid plastic
 (8) Other (specify): _____
 (9) Unknown
95. Knee Bolsters Deformed from Occupant Contact? 1
 (0) No knee bolster
 (1) No deformation
 (2) Yes - deformation
 (9) Unknown
96. Did Glove Compartment Door Open During Collision(s)? 2
 (0) No glove compartment door
 (1) No - door did not open
 (2) Yes - door opened
 (9) Unknown
97. Adaptive (Assistive) Driving Equipment 0
 (0) No adaptive driving equipment
 (1) Adaptive driving equipment installed (Check all that apply.)
 Hand controls for braking/acceleration
 Steering control devices (attached to OEM steering wheel)
 Steering knob attached to steering wheel
 Low effort power steering (unit or device)
 Replacement steering wheel (i.e., reduced diameter)
 Joy-stick steering controls
 Wheelchair tie-downs
 Modification to seat belts (specify): _____
 Additional or relocated switches (specify): _____
 Raised roof
 Wall-mounted head rest (used behind wheelchair)
 Other adaptive device (specify): _____
 (9) Unknown

VEHICLE INTERIOR SKETCHES

Note area of ejection/entrapment

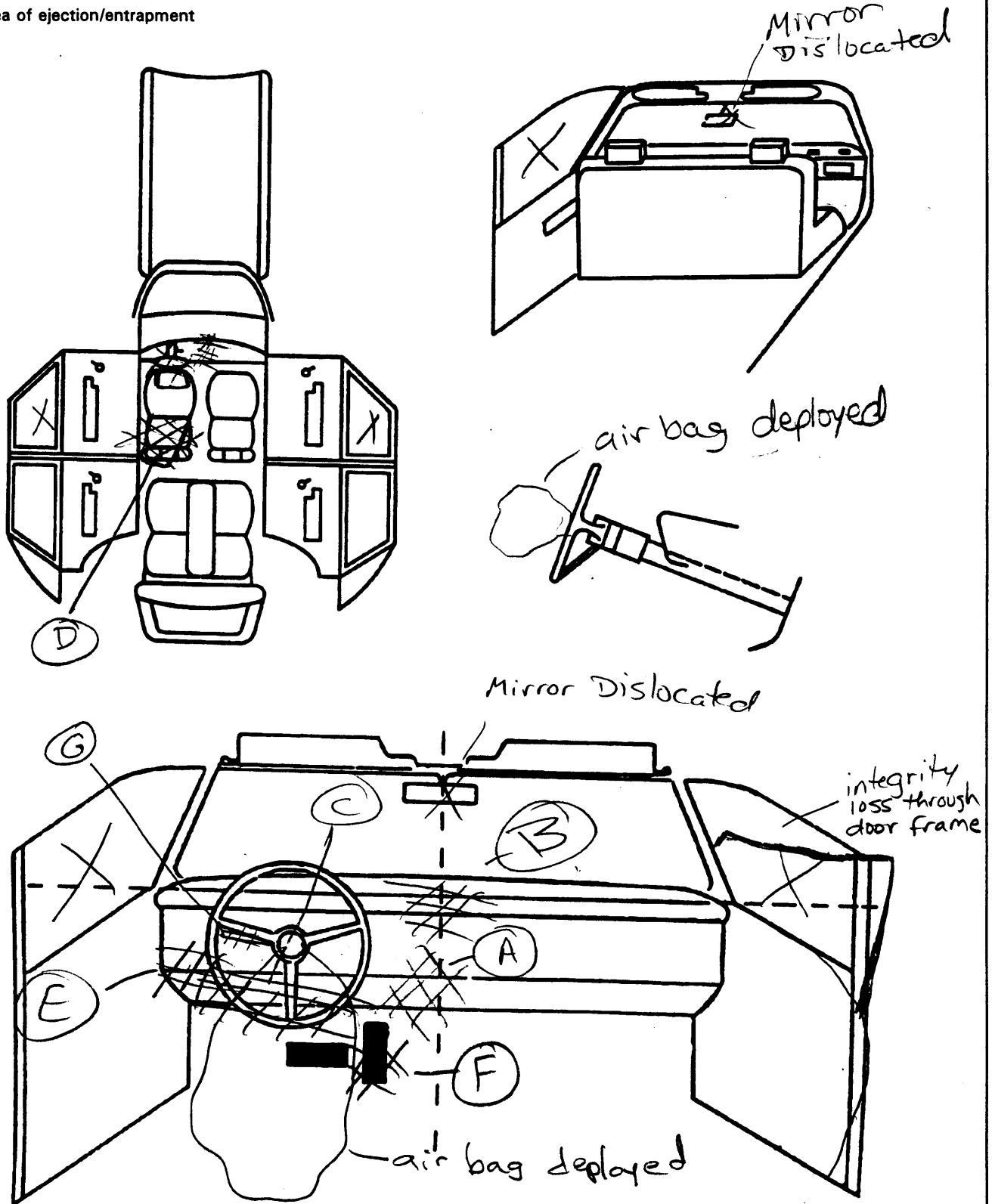

Sketch windshield contact(s) and the damaged area(s) on the instrument panel outline (e.g., radio, glove compartment, damage to instrument panel structure).
 Cross hatch contact points, draw spider webs or use other annotation as may be appropriate.
 Annotate the contacted area with a letter (begin with A) and list on the Points of Occupant Contact page.

POINTS OF OCCUPANT CONTACT

Contact	Interior Component Contacted	Occupant No. If Known	Body Region If Known	Supporting Physical Evidence	Confidence Level of Contact Point
A	011	1	Knee	Cracked, deformed, blood transfer	1
B	011	1	Arm	Cracked, deformed	1
C	007	1	Legs Lower torso	bent upward & to left	2
D	151	1	back	Seat bent back & right	2
E	010	1	Knee	Scratched, cracked	2
F	254	1	Foot	Accelerator pedal bent	2
G	007	1	Hand/Arm	Turn signal lever broken off	2
H					
I					
J					
K					
L					
M					
N					

CODES FOR INTERIOR COMPONENTS

FRONT

- (001) Windshield
- (002) Mirror
- (003) Sunvisor
- (004) Steering wheel rim
- (005) Steering wheel hub/spoke
- (006) Steering wheel (combination of codes 004 and 005)
- (007) Steering column, transmission selector lever, other attachment
- (008) Cellular telephone or CB radio
- (009) Add on equipment (e.g., tape deck, air conditioner)
- (010) Left instrument panel and below
- (011) Center instrument panel and below
- (012) Right instrument panel and below
- (013) Glove compartment door
- (014) Knee bolster
- (015) Windshield including one or more of the following: front header, A (A1/A2)-pillar, instrument panel, mirror, or steering assembly (driver side only)
- (016) Windshield including one or more of the following: front header, A (A1/A2)-pillar, instrument panel, or mirror (passenger side only)
- (017) Windshield reinforced by exterior object, (specify): _____
- (019) Other front object (specify): _____

LEFT SIDE

- (051) Left side interior surface, excluding hardware or armrests
- (052) Left side hardware or armrest
- (053) Left A (A1/A2)-pillar
- (054) Left B-pillar
- (055) Other left pillar (specify): _____
- (056) Left side window glass
- (057) Left side window frame
- (058) Left side window sill
- (059) Left side window glass including one or more of the following: frame, window sill, A (A1/A2)-pillar, B-pillar, or roof side rail.
- (060) Other left side object (specify): _____
- RIGHT SIDE**
- (101) Right side interior surface, excluding hardware or armrests
- (102) Right side hardware or armrest
- (103) Right A (A1/A2)-pillar
- (104) Right B-pillar
- (105) Other right pillar (specify): _____
- (106) Right side window glass
- (107) Right side window frame
- (108) Right side window sill
- (109) Right side window glass including one or more of the following: frame, window sill, A (A1/A2)-pillar, B-pillar, or roof side rail.
- (110) Other right side object (specify): _____

INTERIOR

- (151) Seat, back support
- (152) Belt restraint webbing/buckle
- (153) Belt restraint B-pillar or door frame attachment point
- (154) Other restraint system component (specify): _____
- (155) Head restraint system
- (160) Other occupants (specify): _____
- (161) Interior loose objects
- (162) Child safety seat (specify): _____
- (163) Other interior object (specify): _____

AIR BAG

- (170) Air bag-driver side
- (175) Air bag compartment cover-driver side
- (180) Air bag-passenger side
- (185) Air bag compartment cover-passenger side
- (190) Other air bag (specify) _____
- (195) Other air bag compartment cover (specify) _____

ROOF

- (201) Front header
- (202) Rear header
- (203) Roof left side rail
- (204) Roof right side rail
- (205) Roof or convertible top

FLOOR

- (251) Floor (including toe pan)
- (252) Floor or console mounted transmission lever, including console
- (253) Parking brake handle
- (254) Foot controls including parking brake

REAR

- (301) Backlight (rear window)
- (302) Backlight storage rack, door, etc.
- (303) Other rear object (specify): _____

ADAPTIVE (ASSISTIVE) DRIVING EQUIPMENT

- (401) Hand controls for braking/acceleration
- (402) Steering control devices (attached to OEM steering wheel)
- (403) Steering knob attached to steering wheel
- (405) Replacement steering wheel (i.e., reduced diameter)
- (406) Joy stick steering controls
- (407) Wheelchair tie-downs
- (408) Modification to seat belts, (specify): _____
- (409) Additional or relocated switches, (specify): _____
- (410) Raised roof
- (411) Wall mounted head rest (used behind wheel chair)
- (412) Other adaptive device (specify): _____

CONFIDENCE LEVEL OF CONTACT POINT

- (1) Certain
- (2) Probable
- (3) Possible
- (9) Unknown

MANUAL RESTRAINTS

NOTES: Encode the applicable data for each seat position in the vehicle. The attribute for the variable may be found below. Restraint systems should be assessed during the vehicle inspection then coded on the Occupant Assessment Form. If a Child safety seat is present, encode the data on the back of this page. If the vehicle has automatic restraints available, encode the appropriate data on the back of the previous page.

		Left	Center	Right
FIRST	Availability	4	/	4
	Evidence of usage	OO	/	OO
	Used in this crash?	OO	/	OO
	Proper Use	O	/	O
	Failure Modes	O	/	O
	Anchorage Adjustment	1	/	1
SECOND	Availability	4	/	4
	Evidence of usage	OO	/	OO
	Used in this crash?	OO	/	OO
	Proper Use	O	/	O
	Failure Modes	O	/	O
	Anchorage Adjustment	1	/	1
OTHER	Availability	/	/	/
	Evidence of usage	/	/	/
	Used in this crash?	/	/	/
	Proper Use	/	/	/
	Failure Modes	/	/	/
	Anchorage Adjustment	/	/	/

Manual (Active) Belt System Availability

- (0) None available
- (1) Belt removed/destroyed
- (2) Shoulder belt
- (3) Lap belt
- (4) Lap and shoulder belt
- (5) Belt available - type unknown

Integral Belt Partially Destroyed

- (6) Shoulder belt (lap belt destroyed/removed)
- (7) Lap belt (shoulder belt destroyed/removed)
- (8) Other belt (specify): _____
- (9) Unknown

Manual (Active) Belt System Use

- (00) None used, not available, or belt removed/destroyed
- (01) Inoperable (specify): _____
- (02) Shoulder belt
- (03) Lap belt
- (04) Lap and shoulder belt
- (05) Belt used - type unknown
- (08) Other belt used (specify): _____
- (12) Shoulder belt used with child safety seat
- (13) Lap belt used with child safety seat
- (14) Lap and shoulder belt used with child safety seat
- (15) Belt used with child safety seat - type unknown
- (18) Other belt used with child safety seat (specify): _____
- (99) Unknown if belt used

Proper Use of Manual (Active) Belts

- (0) None used or not available
- (1) Belt used properly
- (2) Belt used properly with child safety seat

Belt Used Improperly

- (3) Shoulder belt worn under arm
- (4) Shoulder belt worn behind back or seat
- (5) Belt worn around more than one person
- (6) Lap belt worn on abdomen
- (7) Lap belt or lap and shoulder belt used improperly with child safety seat (specify): _____
- (8) Other improper use of manual belt system (specify): _____
- (9) Unknown

Manual (Active) Belt Failure Modes During Accident

- (0) No manual belt used or not available
- (1) No manual belt failure(s)
- (2) Torn webbing (stretched webbing not included)
- (3) Broken buckle or latchplate
- (4) Upper anchorage separated
- (5) Other anchorage separated (specify): _____
- (6) Broken retractor
- (7) Combination of above (specify): _____
- (8) Other manual belt failure (specify): _____
- (9) Unknown

Shoulder Belt Upper Anchorage Adjustment

- (0) No shoulder belt
- (1) No upper anchorage adjustment for shoulder belt

Adjustable shoulder Belt Upper Anchorage

- (2) In full up position
- (3) In mid position
- (4) In full down position
- (5) Position unknown
- (9) Unknown if position has adjustable upper anchorage adjustment

AUTOMATIC RESTRAINTS

NOTES: Encode the data for each applicable front seat position. The attribute for the variables may be found below. Restraint systems should be assessed during the vehicle inspection then coded on the Occupant Assessment Form.

AIR BAGS

		Left Front	Right Front	Other
F I R S T	Availability/Function		○	○
	Deployment		○	○
	Failure		○	○

Air Bag System Availability/Function

- (0) Not equipped/not available
- (1) Air bag

Non-functional

- (2) Air bag disconnected (specify): _____
- (3) Air bag not reinstalled
- (9) Unknown

Are There Indications of Air Bag System Failure? (This Occupant Position)

- (0) Not equipped/not available
- (1) No
- (2) Yes (specify): _____
- (9) Unknown

Frontal Air Bag System Deployment (This Occupant Position)

- (0) Not equipped/not available
- (1) Deployed during accident (as a result of impact)
- (2) Deployed inadvertently just prior to accident
- (3) Deployed, accident sequence undetermined
- (4) Deployed as a result of a noncollision event during accident sequence (e.g., fire, explosion, electrical)
- (5) Unknown if deployed
- (7) Nondeployed
- (9) Unknown

Air Bag(s) Deployment, Other Than First Seat Frontal (This Occupant Position)

- (0) Not equipped with an "other" air bag
- (1) Deployed during accident (as a result of impact)
- (2) Deployed inadvertently just prior to accident
- (3) Deployed, details unknown
- (4) Deployed as a result of a noncollision event during accident sequence (e.g., fire, explosion, electrical)
- (5) Unknown if deployed
- (7) Nondeployed
- (9) Unknown

AUTOMATIC BELTS

		Left	Right
F I R S T	Availability/Function	○	○
	Use	○	○
	Type	○	○
	Proper Use	○	○
	Failure Modes	○	○

Automatic (Passive) Belt System Availability/Function

- (0) Not equipped/not available
- (1) 2 point automatic belts
- (2) 3 point automatic belts
- (3) Automatic belts - type unknown

Non-functional

- (4) Automatic belts destroyed or rendered inoperative
- (9) Unknown

Automatic (Passive) Belt System Use

- (0) Not equipped/not available/destroyed or rendered inoperative
- (1) Automatic belt in use
- (2) Automatic belt not in use (manually disconnected, motorized track inoperative)
- (3) Automatic belt use unknown
- (9) Unknown

Automatic (Passive) Belt System Type

- (0) Not equipped/not available
- (1) Non-motorized system
- (2) Motorized system
- (9) Unknown

Proper Use of Automatic (Passive) Belt System

- (0) Not equipped/not available/not used
- (1) Automatic belt used properly
- (2) Automatic belt used properly with child safety seat

Automatic Belt Used Improperly

- (3) Automatic shoulder belt worn under arm
- (4) Automatic shoulder belt worn behind back
- (5) Automatic belt worn around more than one person
- (6) Lap portion of automatic belt worn on abdomen
- (7) Automatic lap and shoulder belt or automatic shoulder belt used improperly with child safety seat (specify): _____
- (8) Other improper use of automatic belt system (specify): _____
- (9) Unknown

Automatic (Passive) Belt Failure Modes During Accident

- (0) Not equipped/not available/not in use
- (1) No automatic belt failure(s)
- (2) Torn webbing (stretched webbing not included)
- (3) Broken buckle or latchplate
- (4) Upper anchorage separated
- (5) Other anchorage separated (specify): _____
- (6) Broken retractor
- (7) Combination of above (specify): _____
- (8) Other automatic belt failure (specify): _____
- (9) Unknown

FIRST SEAT FRONTAL AIR BAGS

NOTES: Encode the applicable data *for the driver and first seat passenger* in the vehicle. The attribute for the variable may be found below. Restraint systems should be assessed during the vehicle inspection then coded on the Occupant Assessment Form.

	Driver	Passenger
Type of air bag?	1	0
Flaps open at tear points?	2	0
Flaps damaged?	1	0
Air bag damaged?	001	000
Source of air bag damage	01	000
Air bag tethered?	2	0
Air bag have vent ports?	2	0
Other occupant contact air bag?	1	0
Occupant wearing eyewear?	4	0

Type of Air Bag

- (0) Not equipped/not available
- (1) Original manufacturer installed system
- (2) Retrofitted air bag
- (3) Replacement air bag
- (8) Unknown type of air bag
- (9) Unknown

Did Air Bag Module Cover Flap(s) Open At Designated Tear Points?

- (0) Not equipped/not available
- (1) No
- (2) Yes
- (3) Deployed, unknown if flap(s) opened at designated tear points
- (7) Not deployed
- (8) Unknown if deployed
- (9) Unknown

Were Air Bag Module Cover Flap(s) Damaged?

- (0) Not equipped/not available
- (1) No
- (2) Yes (specify): _____
- (3) Deployed, unknown if air bag module cover flap(s) damaged
- (7) Not deployed
- (8) Unknown if deployed
- (9) Unknown

Was There Damage To The Air Bag?

- (00) Not equipped/not available
- (01) Not damaged
- Yes - Air Bag Damage*
- (02) Ruptured
- (03) Cut
- (04) Torn
- (05) Holed
- (06) Burned
- (07) Abraded
- (88) Other damage (specify): _____
- (95) Damaged, details unknown
- (96) Deployed, unknown if damaged
- (97) Not deployed
- (98) Unknown if deployed
- (99) Unknown

Source of Air Bag Damage

- (00) Not equipped/not available
- (01) Not damaged
- (02) Object worn by occupant, (specify): _____
- (03) Object carried by occupant, (specify): _____
- (04) Adaptive/assistive controls, (specify): _____
- (05) Fire in vehicle
- (06) Thermal burns
- (07) Rescue or emergency efforts
- (88) Other damage source (specify): _____
- (95) Damaged, unknown source
- (96) Deployed, unknown if damaged
- (97) Not deployed
- (98) Unknown if deployed
- (99) Unknown

Was The Air Bag Tethered?

- (0) Not equipped/not available
- (1) No
- (2) Yes (specify number of tether straps): 2
- (3) Deployed, unknown if tethered
- (7) Not deployed
- (8) Unknown if deployed
- (9) Unknown

Did The Air Bag Have Vent Ports?

- (0) Not equipped/not available
- (1) No
- (2) Yes (specify number of vent ports): 2
- (3) Deployed, unknown if vent ports present
- (7) Not deployed
- (8) Unknown if deployed
- (9) Unknown

Was the Air Bag in this Occupant's Position Contacted by Another Occupant?

- (0) Not equipped/not available
- (1) No
- (2) Yes (specify): _____
- (3) Deployed, unknown if other occupant contact to air bag
- (7) Not deployed
- (8) Unknown if deployed
- (9) Unknown

Was This Occupant Wearing Eye-wear?

- (0) Not equipped/not available
- (1) No
- (2) Eyeglasses/sunglasses
- (3) Contact lenses
- (4) Deployed, unknown if eyewear worn
- (7) Not deployed
- (8) Unknown if deployed
- (9) Unknown

DRIVER AIR BAG DAMAGE AND CONTACT SKETCHES

1. SKETCH DAMAGE AND CONTACT EVIDENCE ON DRIVER AIR BAG (Front)

*No
Damage*

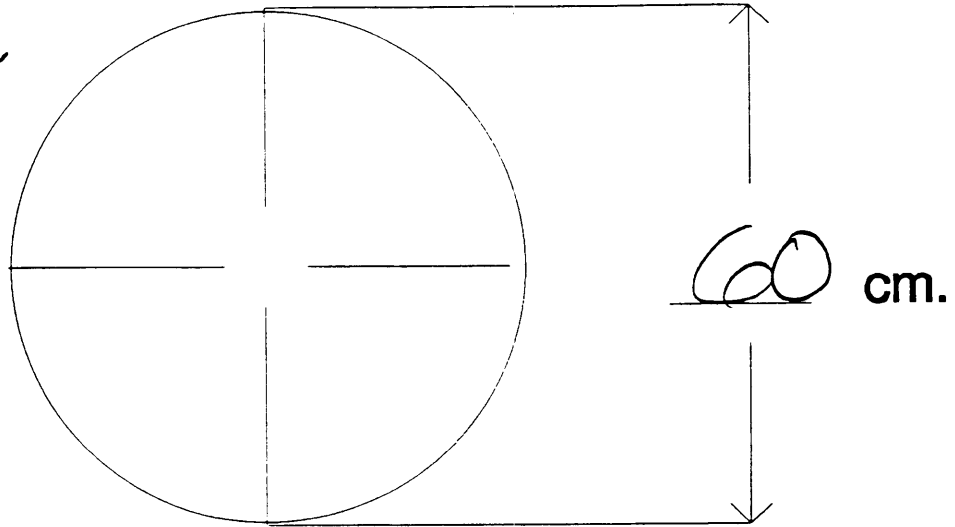

2. SKETCH DAMAGE AND CONTACT EVIDENCE ON DRIVER AIR BAG (Back)

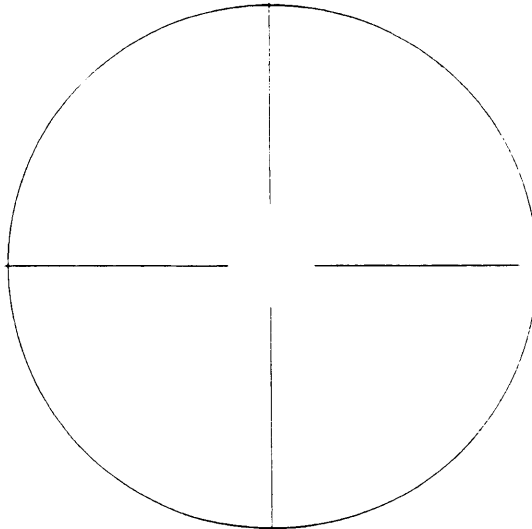

DRIVER AIR BAG SKETCHES (Cont'd)

3. DRIVER AIR BAG MODULE COVER FLAP SIZE (DOUBLE)

a. Upper Flap

width (W_u) 17

height (H_u) 7

b. Lower Flap

width (W_l) 17

height (H_l) 6

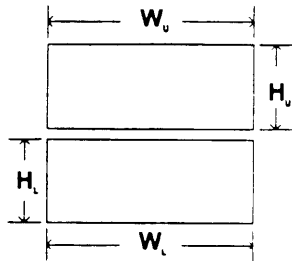

4. SKETCH OF OTHER TYPE OF AIR BAG MODULE FLAP AND SIZE

5. SKETCH OF OTHER TYPE OF AIR BAG VENT PORTS

6. SKETCH LOCATION OF CIRCULAR AIR BAG VENT PORTS

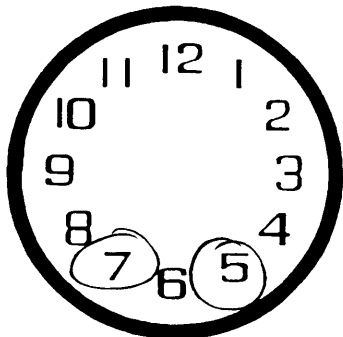

PASSENGER AIR BAG DAMAGE AND CONTACT SKETCHES

1. SKETCH DAMAGE AND CONTACT EVIDENCE ON PASSENGER AIR BAG (Front)

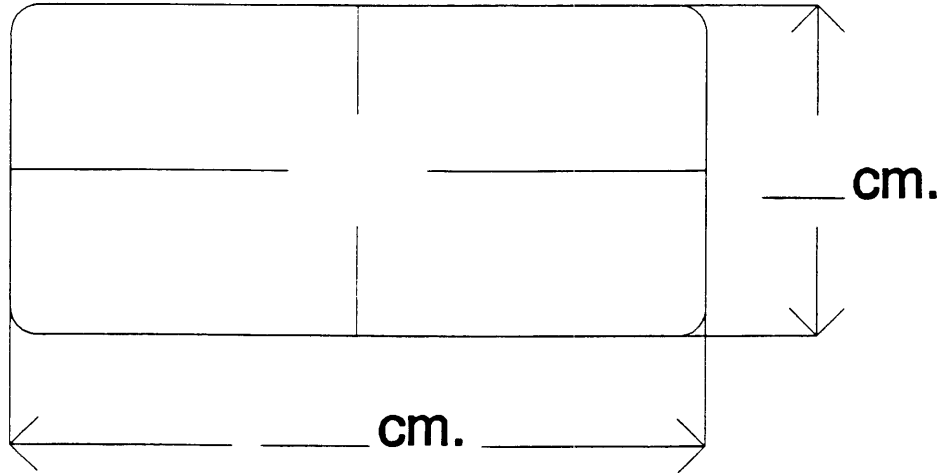

2. SKETCH DAMAGE AND CONTACT EVIDENCE ON PASSENGER AIR BAG (Back)

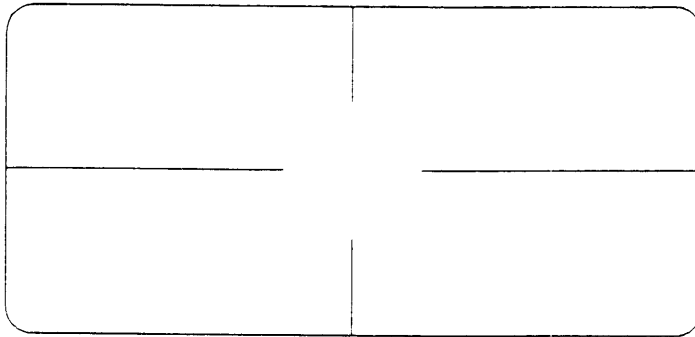

PASSENGER AIR BAG SKETCHES (Cont'd)

3. PASSENGER AIR BAG MODULE COVER FLAP SIZE (SINGLE)

a. Flap

width (W) _____

height (H) _____

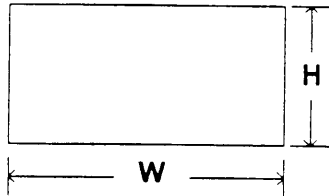

4. PASSENGER AIR BAG MODULE COVER FLAP SIZE (DOUBLE)

a. Upper Flap

b. Lower Flap

width (W_U) _____

width (W_L) _____

height (H_U) _____

height (H_L) _____

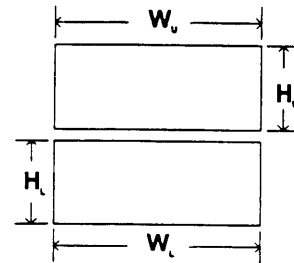

5. SKETCH OF OTHER TYPE OF AIR BAG MODULE FLAP AND SIZE

6. SKETCH OF OTHER TYPE OF AIR BAG VENT PORTS

7. SKETCH LOCATION OF RECTANGULAR AIR BAG VENT PORTS

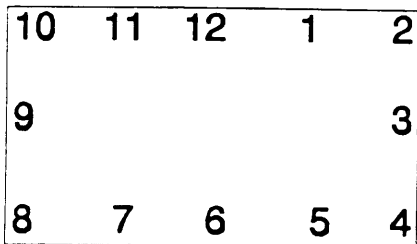

"OTHER" AIR BAG DAMAGE AND CONTACT SKETCHES

1. SKETCH DAMAGE AND CONTACT EVIDENCE ON "OTHER" AIR BAG (Front)

2. SKETCH DAMAGE AND CONTACT EVIDENCE ON "OTHER" AIR BAG (Back)

"OTHER" AIR BAG SKETCHES (Cont'd)

3. SKETCH AIR BAG MODULE FLAP AND SIZE OR OPENING FOR AIRBAG

4. SKETCH AIR BAG VENT PORTS

HEAD RESTRAINTS/SEAT EVALUATION

NOTES: Encode the applicable data for each seat position in the vehicle. The attribute for these variables may be found at the bottom of the page. Head restraint type/damage and seat type/performance should be assessed during the vehicle inspection then coded on the Occupant Assessment Form.

		Left	Center	Right
F I R S T	Head Restraint Type/Damage	3	Center	3
	Seat Type	02		02
	Seat Performance	7		
	Seat Orientation	1		1
	Seat Track Position	4		3
	Seat Back Incline Pre/Post Impact	23/21		23/25
S E C O N D	Head Restraint Type/Damage	0	Center	0
	Seat Type	05		05
	Seat Performance	3		3
	Seat Orientation	1		1
	Seat Track Position	1		1
	Seat Back Incline Pre/Post Impact	23/22		23/22
T H I R D	Head Restraint Type/Damage		Center	
	Seat Type			
	Seat Performance			
	Seat Orientation			
	Seat Track Position			
	Seat Back Incline Pre/Post Impact			
O T H E R	Head Restraint Type/Damage		Center	
	Seat Type			
	Seat Performance			
	Seat Orientation			
	Seat Track Position			
	Seat Back Incline Pre/Post Impact			

**DESCRIBE ANY INDICATION OF ABNORMAL OCCUPANT POSTURE
(I.E., UNUSUAL OCCUPANT CONTACT PATTERN)**

HEAD RESTRAINTS/SEAT EVALUATION

Head Restraint Type/Damage by Occupant at This Occupant Position

- (0) No head restraints
- (1) Integral — no damage
- (2) Integral — damaged during accident
- (3) Adjustable — no damage
- (4) Adjustable — damaged during accident
- (5) Add-on — no damage
- (6) Add-on — damaged during accident
- (8) Other
Specify: _____
- (9) Unknown

Seat Type (this Occupant Position)

- (00) Occupant not seated or no seat
- (01) Bucket
- (02) Bucket with folding back
- (03) Bench
- (04) Bench with separate back cushions
- (05) Bench with folding back(s)
- (06) Split bench with separate back cushions
- (07) Split bench with folding back(s)
- (08) Pedestal (i.e., column supported)
- (09) Other seat type (specify): _____
- (10) Box mounted seat (i.e., van type)
- (99) Unknown

Seat Performance (this Occupant Position)

- (0) Occupant not seated or no seat
- (1) No seat performance failure(s)
- (2) Seat adjusters failed
- (3) Seat back folding locks or "seat back" failed (specify): _____
- (4) Seat tracks/anchors failed
- (5) Deformed by impact of occupant
- (6) Deformed by passenger compartment intrusion (specify): _____
- (7) Combination of above (specify): Seat back & deformation
- (8) Other (specify): _____
- (9) Unknown

Seat Orientation (this Occupant Position)

- (0) Occupant not seated or no seat
- (1) Forward facing seat
- (2) Rear facing seat
- (3) Side facing seat (inward)
- (4) Side facing seat (outward)
- (8) Other (specify): _____
- (9) Unknown

Seat Track Adjusted Position Prior To Impact

- (0) Occupant not seated or no seat
- (1) Non-adjustable seat track
- Adjustable Seat Track*
- (2) Seat at forward most track position
- (3) Seat between forward most and middle track positions
- (4) Seat at middle track position
- (5) Seat between middle and rear most track positions
- (6) Seat at rear most track position
- (9) Unknown

Seat Back Incline Prior and Post Impact

- (00) Occupant not seated or no seat
- (01) Not adjustable

Upright prior to impact

- (11) Moved to completely rearward position
- (12) Moved to rearward midrange position
- (13) Moved to slightly rearward position
- (14) Retained pre-impact position
- (15) Moved to slightly forward position
- (16) Moved to forward midrange position
- (17) Moved to completely forward position

Slightly reclined prior to impact

- (21) Moved to completely rearward position
- (22) Moved to rearward midrange position
- (23) Retained pre-impact position
- (24) Moved to upright position
- (25) Moved to slightly forward position
- (26) Moved to forward midrange position
- (27) Moved to completely forward position

Completely reclined prior to impact

- (31) Retained pre-impact position
- (32) Moved to rearward midrange position
- (33) Moved to slightly rearward position
- (34) Moved to upright position
- (35) Moved to slightly forward position
- (36) Moved to forward midrange position
- (37) Moved to completely forward position
- (99) Unknown

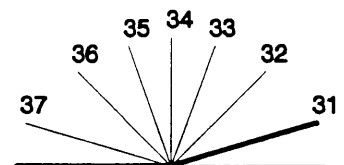
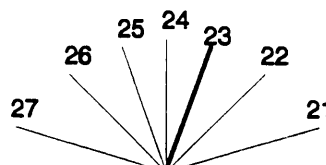
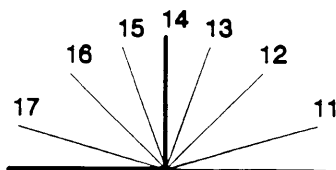

Coding diagrams for *Seat Back Incline Position Prior and Post Impact*

**DESCRIBE ANY INDICATION OF ABNORMAL OCCUPANT POSTURE
(I.E., UNUSUAL OCCUPANT CONTACT PATTERN)**

CHILD SAFETY SEAT FIELD ASSESSMENT

When a child safety seat is present enter the occupant's number in the first row and complete the column below the occupant's number using the codes listed below. Complete a column for each child safety seat present.

Occupant Number						
1. Type of Child Safety Seat						
2. Child Safety Seat Orientation						
3. Child Safety Seat Harness Usage						
4. Child Safety Seat Shield Usage						
5. Child Safety Seat Tether Usage						
6. Child Safety Seat Make/Model	Specify Below for Each Child Safety Seat					

<p>1. Type of Child Safety Seat</p> <p>(0) No child safety seat (1) Infant seat (2) Toddler seat (3) Convertible seat (4) Booster seat (7) Other type child safety seat (specify): _____ (8) Unknown child safety seat type (9) Unknown if child safety seat used</p> <p>2. Child Safety Seat Orientation</p> <p>(00) No child safety seat</p> <p>Designed for Rear Facing for This Age/Weight (01) Rear facing (02) Forward facing (08) Other orientation (specify): _____ (09) Unknown orientation</p> <p>Designed for Forward Facing for This Age/Weight (11) Rear facing (12) Forward facing (18) Other orientation (specify): _____ (19) Unknown orientation</p> <p>Unknown Design or Orientation For This Age/Weight, or Unknown Age/Weight (21) Rear facing (22) Forward facing (28) Other orientation (specify): _____ (29) Unknown orientation</p> <p>(99) Unknown if child safety seat used</p> <p>3. Child Safety Seat Harness Usage</p>	<p>4. Child Safety Seat Shield Usage</p> <p>5. Child Safety Seat Tether Usage Note: Options Below Are Used for Variables 3-5. (00) No child safety seat</p> <p>Not Designed with Harness/Shield/Tether (01) After market harness/shield/tether added, not used (02) After market harness/shield/tether used (03) Child safety seat used, but no after market harness/shield/tether added (09) Unknown if harness/shield/tether added or used</p> <p>Designed With Harness/Shield/Tether (11) Harness/shield/tether not used (12) Harness/shield/tether used (19) Unknown if harness/shield/tether used</p> <p>Unknown If Designed With Harness/Shield/Tether (21) Harness/shield/tether not used (22) Harness/shield/tether used (29) Unknown if harness/shield/tether used</p> <p>(99) Unknown if child safety seat used</p> <p>6. Child Safety Seat Make/Model (Specify make/model and occupant number)</p> <p>_____</p> <p>_____</p> <p>_____</p> <p>_____</p>
---	---

EJECTION/ENTRAPMENT DATA

Complete the following if the researcher has any indication that an occupant was either ejected from or entrapped in the vehicle. Code the appropriate data on the Occupant Assessment Form.

EJECTION No [] Yes [X]

Describe indications of ejection and body parts involved in partial ejection(s):

Full ejection. On inspection LF door was closed and wired shut. After untying wire door still remained shut. Once we opened the door it would not close. Evidence indicates ejection through LF door. LF side glazing also disintegrated. It is possible ejection could of been through glazing

Occupant Number	01						
Ejection	1						
(Note on Vehicle Interior Sketch) Ejection Area	2						
Ejection Medium	1						
Medium Status	2						

Ejection

- (1) Complete ejection
- (2) Partial ejection
- (3) Ejection, Unknown degree
- (9) Unknown

Ejection Area

- (1) Windshield
- (2) Left front
- (3) Right front
- (4) Left rear
- (5) Right rear
- (6) Rear

(7) Roof

(8) Other area (e.g., back of pickup, etc.) (specify):

(9) Unknown

Ejection Medium

- (1) Door/hatch/tailgate
- (2) Nonfixed roof structure
- (3) Fixed glazing
- (4) Nonfixed glazing (specify):

(5) Integral structure

(8) Other medium (specify):

(9) Unknown

Medium Status (Immediately Prior to Impact)

- (1) Open
- (2) Closed
- (3) Integral structure
- (9) Unknown

ENTRAPMENT No [X] Yes []

Describe entrapment mechanism: _____

Component(s): _____

(Note in vehicle interior diagram)



OCCUPANT ASSESSMENT FORM

1. Primary Sampling Unit Number 04
 2. Case Number - Stratum 029A
 3. Vehicle Number 01
 4. Occupant Number 01

OCCUPANT'S CHARACTERISTICS

5. Occupant's Age 25
 Code actual age at time of accident.
 (00) Less than one year old (specify by month): _____
 (97) 97 years and older _____
 (99) Unknown _____

6. Occupant's Sex 1
 (1) Male
 (2) Female-not reported pregnant
 (3) Female-pregnant-1st trimester(1st-3rd month)
 (4) Female-pregnant-2nd trimester(4th-6th month)
 (5) Female-pregnant-3rd trimester(7th-9th month)
 (6) Female-pregnant-term unknown
 (9) Unknown

7. Occupant's Height 147
152
 Code actual height to the nearest centimeter.
 (999) Unknown
5860 inches X 2.54 = 147 ^{autopsy} centimeters

8. Occupant's Weight 109
 Code actual weight to the nearest kilogram.
 (999)Unknown
240 pounds X .4536 = 109 kilograms

9. Occupant's Role 1
 (1) Driver
 (2) Passenger
 (9) Unknown

OCCUPANT'S SEATING

10. Occupant's Seat Position 11
Front Seat
 (11) Left side
 (12) Middle
 (13) Right side
 (14) Other (specify): _____
 (15) On or in the lap of another occupant

Second Seat
 (21) Left side
 (22) Middle
 (23) Right side
 (24) Other (specify): _____
 (25) On or in the lap of another occupant

Third Seat
 (31) Left side
 (32) Middle
 (33) Right side
 (34) Other (specify): _____
 (35) On or in the lap of another occupant

Fourth Seat
 (41) Left side
 (42) Middle
 (43) Right side
 (44) Other (specify): _____
 (45) On or in the lap of another occupant

(97) In or on unenclosed area
 (98) Other seat (specify): _____
 (99) Unknown

11. Occupant's Posture 9
 (0) Normal posture

Abnormal posture
 (1) Kneeling or standing on seat
 (2) Lying on or across seat
 (3) Kneeling, standing or sitting in front of seat
 (4) Sitting sideways or turned to talk with another occupant or to look out a rear window
 (5) Sitting on a console
 (6) Lying back in a reclined seat position
 (7) Bracing with feet or hands on a surface in front of seat
 (8) Other abnormal posture (specify): _____
 (9) Unknown

EJECTION/ENTRAPMENT

12. Ejection

1

- (0) No ejection
- (1) Complete ejection
- (2) Partial ejection
- (3) Ejection, unknown degree
- (9) Unknown

15. Medium Status (Immediately Prior To Impact)

2

- (0) No ejection
- (1) Open
- (2) Closed
- (3) Integral structure
- (9) Unknown

13. Ejection Area

2

- (0) No ejection
- (1) Windshield
- (2) Left front
- (3) Right front
- (4) Left rear
- (5) Right rear
- (6) Rear
- (7) Roof
- (8) Other area (e.g., back of pickup, etc.)
(specify): _____
- (9) Unknown

16. Entrapment

0

- (0) Not entrapped/exit not inhibited
- (1) Entrapped/pinned - mechanically restrained
- (2) Could not exit vehicle due to jammed doors, fire, etc.
(specify): _____
- (9) Unknown

14. Ejection Medium

4

- (0) No ejection
- (1) Door/hatch/tailgate
- (2) Nonfixed roof structure
- (3) Fixed glazing
- (4) Nonfixed glazing (specify):
LF WINDOW
- (5) Integral structure
- (8) Other medium (specify): _____
- (9) Unknown

17. Occupant Mobility

5

- (0) Occupant fatal before removed from vehicle
- (1) Removed from vehicle while unconscious or disoriented
- (2) Removed from vehicle due to injuries
- (3) Exited vehicle with some assistance
- (4) Exited vehicle under own power
- (5) Occupant fully ejected
- (9) Unknown

BELT SYSTEM FUNCTION

18. Manual (Active) Belt System Availability 4

- (0) None available
- (1) Belt removed/destroyed
- (2) Shoulder belt
- (3) Lap belt
- (4) Lap and shoulder belt
- (5) Belt available—type unknown

Integral Belt Partially Destroyed

- (6) Shoulder belt (lap belt destroyed/removed)
- (7) Lap belt (shoulder belt destroyed/removed)
- (8) Other belt (specify): _____

(9) Unknown _____

19. Manual (Active) Belt System Use 0 0

- (00) None used, not available, or belt removed/destroyed
- (01) Inoperative (specify): _____

- (02) Shoulder belt
- (03) Lap belt
- (04) Lap and shoulder belt
- (05) Belt used—type unknown
- (08) Other belt used (specify): _____

- (12) Shoulder belt used with child safety seat
- (13) Lap belt used with child safety seat
- (14) Lap and shoulder belt used with child safety seat
- (15) Belt used with child safety seat—type unknown
- (18) Other belt used with child safety seat (specify): _____
- (99) Unknown if belt used

20. Proper Use of Manual (Active) Belts 0

- (0) None used or not available
- (1) Belt used properly
- (2) Belt used properly with child safety seat

Belt Used Improperly

- (3) Shoulder belt worn under arm
- (4) Shoulder belt worn behind back or seat
- (5) Belt worn around more than one person
- (6) Lap belt worn on abdomen
- (7) Lap belt or lap and shoulder belt used improperly with child safety seat (specify): _____

(8) Other improper use of manual belt system (specify): _____

(9) Unknown _____

21. Manual (Active) Belt Failure Modes During Accident 0

- (0) No manual belt used or not available
- (1) No manual belt failure(s)
- (2) Torn webbing (stretched webbing not included)
- (3) Broken buckle or latchplate
- (4) Upper anchorage separated
- (5) Other anchorage separated (specify): _____

(6) Broken retractor _____
(7) Combination of above (specify): _____

(8) Other manual belt failure (specify): _____

(9) Unknown _____

22. Shoulder Belt Upper Anchorage Adjustment 1

- (0) No shoulder belt
- (1) No upper anchorage adjustment for shoulder belt

Adjustable shoulder Belt Upper Anchorage

- (2) In full up position
- (3) In mid position
- (4) In full down position
- (5) Position unknown
- (9) Unknown if position has adjustable upper anchorage adjustment

23. Automatic (Passive) Belt System Availability/Function 0

- (0) Not equipped/not available
- (1) 2 point automatic belts
- (2) 3 point automatic belts
- (3) Automatic belts - type unknown

Non-functional

- (4) Automatic belts destroyed or rendered inoperative
- (9) Unknown

24. Automatic (Passive) Belt System Use 0

- (0) Not equipped/not available/destroyed or rendered inoperative
- (1) Automatic belt in use
- (2) Automatic belt not in use (manually disconnected, motorized track inoperative) (specify): _____
- (3) Automatic belt use unknown
- (9) Unknown

25. Automatic (Passive) Belt System Type 0

- (0) Not equipped/not available
- (1) Non-motorized system
- (2) Motorized system
- (9) Unknown

26. Proper Use of Automatic (Passive) Belt System 0

- (0) Not equipped/not available/not used
- (1) Automatic belt used properly
- (2) Automatic belt used properly with child safety seat

Automatic Belt Used Improperly

- (3) Automatic shoulder belt worn under arm
- (4) Automatic shoulder belt worn behind back
- (5) Automatic belt worn around more than one person
- (6) Lap portion of automatic belt worn on abdomen
- (7) Automatic lap and shoulder belt or automatic shoulder belt used improperly with child safety seat (specify): _____

(8) Other improper use of automatic belt system (specify): _____

(9) Unknown _____

27. Automatic (Passive) Belt Failure Modes During Accident 0

- (0) Not equipped/not available/not in use
- (1) No automatic belt failure(s)
- (2) Torn webbing (stretched webbing not included)
- (3) Broken buckle or latchplate
- (4) Upper anchorage separated
- (5) Other anchorage separated (specify): _____

(6) Broken retractor _____
(7) Combination of above (specify): _____

(8) Other automatic belt failure (specify): _____

(9) Unknown _____

POLICE REPORTED RESTRAINT USE

AIR BAG SYSTEM FUNCTION

28. Police Reported Belt Use 0
- (0) None used
 - (1) Police did not indicate belt use
 - (2) Shoulder belt
 - (3) Lap belt
 - (4) Lap and shoulder belt
 - (5) Belt used, type not specified
 - (6) Child safety seat
 - (7) Automatic belt
 - (8) Other type belt, (specify): _____
 - (9) Police indicated "unknown" _____

29. Police Reported Air Bag Availability/Function 1
- (0) No air bag available
 - (1) Police did not indicate air bag availability/function
 - (2) Deployed
 - (3) Not deployed
 - (4) Unknown if deployed
 - (9) Police indicated "unknown"

Check the Primary Source Used In Determining Belt Use.

- Not equipped/not available/destroyed or rendered inoperative
- Vehicle inspection
- Official injury data
- Driver/occupant interview
- Other (specify): _____
- Unknown if belt used _____

Driver fully ejected
from car

30. Frontal Air Bag System Availability/Function (This Occupant Position) 1
- (0) Not equipped/not available
 - (1) Air bag
- Non-functional*
- (2) Air bag disconnected (specify): _____
 - (3) Air bag not reinstalled _____
 - (9) Unknown

31. Frontal Air Bag System Deployment (This Occupant Position) 1
- (0) Not equipped/not available
 - (1) Deployed during accident (as a result of impact)
 - (2) Deployed inadvertently just prior to accident
 - (3) Deployed, details unknown
 - (4) Deployed as a result of a noncollision event during accident sequence (e.g., fire, explosion, electrical)
 - (5) Unknown if deployed
 - (7) Nondeployed
 - (9) Unknown

32. Other Than First Seat Frontal Air Bag Availability/Function (This Occupant Position) 0
- (0) Not equipped/not available
 - (1) Air bag
- Non-functional*
- (2) Air bag disconnected (specify): _____
 - (3) Air bag not reinstalled _____
 - (9) Unknown
- Specify type of "other" air bag present:*
- _____

33. Air Bag(s) Deployment, Other Than First Seat Frontal (This Occupant Position) 0
- (0) Not equipped with an "other" air bag
 - (1) Deployed during accident (as a result of impact)
 - (2) Deployed inadvertently just prior to accident
 - (3) Deployed, details unknown
 - (4) Deployed as a result of a noncollision event during accident sequence (e.g., fire, explosion, electrical)
 - (5) Unknown if deployed
 - (7) Nondeployed
 - (9) Unknown

34. Are There Indications of Air Bag System Failure? (This Occupant Position) 1
- (0) Not equipped/not available
 - (1) No
 - (2) Yes (specify): _____
 - (9) Unknown _____

FIRST SEAT FRONTAL AIR BAG SYSTEM EVALUATION

35. Had Vehicle Been in Previous Accident(s)? 1

- (0) Not equipped/not available
 (1) No previous accidents

Yes

- (2) Previous accident(s) without deployment(s)
 (3) One previous accident with deployment
 (4) More than one previous accident with at least one deployment
 (8) Previous accidents, unknown deployment status
 (9) Unknown

36. Type of Air Bag 1

- (0) Not equipped/not available
 (1) Original manufacturer installed system
 (2) Retrofitted air bag
 (3) Replacement air bag
 (8) Unknown type of air bag
 (9) Unknown

37. Had Any Prior Maintenance/Service Been Performed On This Air Bag System? 1

- (0) Not equipped/not available
 (1) No prior maintenance
 (2) Yes, prior maintenance (specify): _____
 (9) Unknown

38. Air Bag Deployment Accident Event Sequence Number 01

- (00) Not equipped/not available
 _____ Code the accident event sequence number that initiated the air bag deployment
 (96) Deployed, unknown event
 (97) Not deployed
 (98) Unknown if deployed
 (99) Unknown

39. CDC For Air Bag Deployment Impact 1

- (0) Not equipped/not available
 (1) Highest delta V
 (2) Second highest delta V
 (3) Other non-coded delta V (specify): _____
 (6) Deployed, unknown event
 (7) Not deployed
 (8) Unknown if deployed
 (9) Unknown

40. Longitudinal Component of Delta V For Air Bag Deployment Impact + 996

- (_000) Not equipped/not available
Code the value of the delta V for the impact that initiated the air bag deployment
 (_996) Deployment, unknown longitudinal Delta V
 (_997) Not deployed
 (_998) Unknown if deployed
 (_999) Unknown

41. Did Air Bag Module Cover Flap(s) Open At Designated Tear Points? 2

- (0) Not equipped/not available
 (1) No
 (2) Yes
 (3) Deployed, unknown if flap(s) opened at designated tear points
 (7) Not deployed
 (8) Unknown if deployed
 (9) Unknown

42. Were Air Bag Module Cover Flap(s) Damaged? 1

- (0) Not equipped/not available
 (1) No
 (2) Yes (specify): _____
 (3) Deployed, unknown if air bag module cover flap(s) damaged
 (7) Not deployed
 (8) Unknown if deployed
 (9) Unknown

43. Was There Damage To The Air Bag? 01

- (00) Not equipped/not available
 (01) Not damaged

Yes - Air Bag Damage

- (02) Ruptured
 (03) Cut
 (04) Torn
 (05) Holed
 (06) Burned
 (07) Abraded
 (88) Other damage (specify): _____
 (95) Damaged, details unknown
 (96) Deployed, unknown if damaged
 (97) Not deployed
 (98) Unknown if deployed
 (99) Unknown

**FIRST SEAT FRONTAL AIR BAG SYSTEM
EVALUATION** *continued***HEAD RESTRAINT AND SEAT EVALUATION**

44. Source of Air Bag Damage 01
 (00) Not equipped/not available
 (01) Not damaged
 (02) Object worn by occupant, (specify):

 (03) Object carried by occupant, (specify):

 (04) Adaptive/assistive controls, (specify):

 (05) Fire in vehicle
 (06) Thermal burns
 (07) Rescue or emergency efforts
 (08) Other damage source (specify):

 (95) Damaged, unknown source
 (96) Deployed, unknown if damaged
 (97) Not deployed
 (98) Unknown if deployed
 (99) Unknown
45. Was The Air Bag Tethered? 2
 (0) Not equipped/not available
 (1) No
 (2) Yes (specify number of tether straps):
two
 (3) Deployed, unknown if tethered
 (7) Not deployed
 (8) Unknown if deployed
 (9) Unknown
46. Did The Air Bag Have Vent Ports? 2
 (0) Not equipped/not available
 (1) No
 (2) Yes (specify number of vent ports):
two
 (3) Deployed, unknown if vent ports present
 (7) Not deployed
 (8) Unknown if deployed
 (9) Unknown
47. Was the Air Bag in this Occupant's Position Contacted by Another Occupant? 1
 (0) Not equipped/not available
 (1) No
 (2) Yes (specify):

 (3) Deployed, unknown if other occupant contact to air bag
 (7) Not deployed
 (8) Unknown if deployed
 (9) Unknown
48. Was This Occupant Wearing Eye-wear? 1
 (0) Not equipped/not available
 (1) No
 (2) Eyeglasses/sunglasses
 (3) Contact lenses
 (4) Deployed, unknown if eyewear worn
 (7) Not deployed
 (8) Unknown if deployed
 (9) Unknown

49. Head Restraint Type/Damage by Occupant at This Occupant Position 3
 (0) No head restraints
 (1) Integral—no damage
 (2) Integral—damaged during accident
 (3) Adjustable—no damage
 (4) Adjustable—damaged during accident
 (5) Add-on—no damage
 (6) Add-on—damaged during accident
 (8) Other (specify):

 (9) Unknown
50. Seat Type (this Occupant Position) 02
 (00) Occupant not seated or no seat
 (01) Bucket
 (02) Bucket with folding back
 (03) Bench
 (04) Bench with separate back cushions
 (05) Bench with folding back(s)
 (06) Split bench with separate back cushions
 (07) Split bench with folding back(s)
 (08) Pedestal (i.e., column supported)
 (09) Box mounted seat (i.e., van type)
 (10) Other seat type (specify):

 (99) Unknown
51. Seat Orientation (this Occupant Position) 1
 (0) Occupant not seated or no seat
 (1) Forward facing seat
 (2) Rear facing seat
 (3) Side facing seat (inward)
 (4) Side facing seat (outward)
 (8) Other (specify):

 (9) Unknown
52. Seat Track Adjusted Position Prior To Impact 4
 (0) Occupant not seated or no seat
 (1) Non-adjustable seat track

Adjustable Seat Track
 (2) Seat at forward most track position
 (3) Seat between forward most and middle track positions
 (4) Seat at middle track position
 (5) Seat between middle and rear most track positions
 (6) Seat at rear most track position
 (9) Unknown

HEAD RESTRAINT AND SEAT EVALUATION *continued*53. Seat Back Incline Prior and Post Impact 21

- (00) Occupant not seated or no seat
 (01) Not adjustable

Upright prior to impact

- (11) Moved to completely rearward position
 (12) Moved to rearward midrange position
 (13) Moved to slightly rearward position
 (14) Retained pre-impact position
 (15) Moved to slightly forward position
 (16) Moved to forward midrange position
 (17) Moved to completely forward position

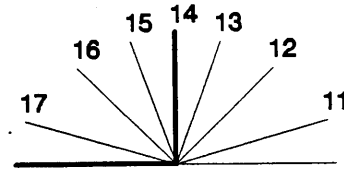
*Slightly reclined prior to impact*

- (21) Moved to completely rearward position
 (22) Moved to rearward midrange position
 (23) Retained pre-impact position
 (24) Moved to upright position
 (25) Moved to slightly forward position
 (26) Moved to forward midrange position
 (27) Moved to completely forward position

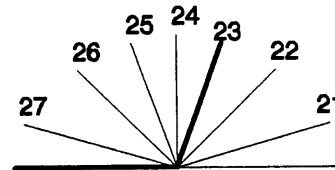
*Completely reclined prior to impact*

- (31) Retained pre-impact position
 (32) Moved to rearward midrange position
 (33) Moved to slightly rearward position
 (34) Moved to upright position
 (35) Moved to slightly forward position
 (36) Moved to forward midrange position
 (37) Moved to completely forward position

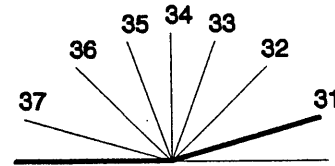

(99) Unknown

54. Seat Performance (this Occupant Position) 7

- (0) Occupant not seated or no seat
 (1) No seat performance failure(s)
 (2) Seat adjusters failed
 (3) Seat back folding locks or "seat back" failed
 (specify): _____
 (4) Seat track/anchors failed
 (5) Deformed by impact of occupant
 (6) Deformed by passenger compartment intrusion, (specify): _____
 (7) Combination of above (specify):
Seat back failure + deformation (3+6)
 (8) Other (specify): _____
 (9) Unknown

CHILD SAFETY SEAT

55. Child Safety Seat Make/Model 000

(000) No child safety seat

Applicable codes are found in your NASS CDS
Data Collection, Coding and Editing

(950) Built-in child safety seat

(997) Other make/model (specify):

(998) Unknown make/model

(999) Unknown if child safety seat used

56. Type of Child Safety Seat 0

(0) No child safety seat

(1) Infant seat

(2) Toddler seat

(3) Convertible seat

(4) Booster seat - with shield

(5) Booster seat - without shield

(7) Other type child safety seat (specify):

(8) Unknown child safety seat type

(9) Unknown if child safety seat used

57. Child Safety Seat Orientation 00

(00) No child safety seat

Designed for Rear Facing for This Age/Weight

(01) Rear facing

(02) Forward facing

(08) Other orientation (specify):

(09) Unknown orientation

Designed For Forward Facing for This Age/Weight

(11) Rear facing

(12) Forward facing

(18) Other orientation (specify):

(19) Unknown orientation

*Unknown Design or Orientation For This
Age/Weight, or Unknown Age/Weight*

(21) Rear facing

(22) Forward facing

(28) Other orientation (specify):

(29) Unknown orientation

(99) Unknown if child safety seat used

58. Child Safety Seat Harness Usage 0059. Child Safety Seat Shield Usage 0060. Child Safety Seat Tether Usage 00Note: Options below applicable to
Variables OA58-OA60.

(00) No child safety seat

Not Designed With Harness/Shield/Tether(01) After market harness/shield/tether
added, not used

(02) After market harness/shield/tether used

(03) Child safety seat used, but no after market
harness/shield/tether added(09) Unknown if harness/shield/tether
added or used*Designed With Harness/Shield/Tether*

(11) Harness/shield/tether not used

(12) Harness/shield/tether used

(19) Unknown if harness/shield/tether used

Unknown If Designed With Harness/Shield/Tether

(21) Harness/shield/tether not used

(22) Harness/shield/tether used

(29) Unknown if harness/shield/tether used

(99) Unknown if child safety seat used

INJURY CONSEQUENCES61. Injury Severity (Police Rating) 4

- (0) O - No injury
- (1) C - Possible injury
- (2) B - Nonincapacitating injury
- (3) A - Incapacitating injury
- (4) K - Killed
- (5) U - Injury, severity unknown
- (6) Died prior to accident
- (9) Unknown

62. Treatment - Mortality 1

- (0) No treatment
- (1) Fatal
- (2) Fatal - ruled disease (specify):

Nonfatal

- (3) Hospitalization
- (4) Transported and released
- (5) Treatment at scene - nontransported
- (6) Treatment later
- (7) Treatment - other (specify):

- (8) Transported to a medical facility-unknown if treated
- (9) Unknown

63. Type Of Medical Facility (for Initial Treatment) 0

- (0) Not treated at a medical facility
- (1) Trauma center
- (2) Hospital
- (3) Medical clinic
- (4) Physician's office
- (5) Treatment later at medical facility
- (8) Other (specify):

- (9) Unknown

64. Hospital Stay 00

- (00) Not Hospitalized
- _____ Code the number of days (up through 60) that the occupant stayed in hospital.
- (61) 61 days or more
- (99) Unknown

65. Working Days Lost 62

- _____ Code the number of days (up through 60) that the occupant lost from work due to the accident
- (00) No working days lost
- (61) 61 days or more
- (62) Fatally injured
- (97) Not working prior to accident
- (99) Unknown

STOP WORK HERE**VARIABLES 66-74****TO BE CODED BY THE ZONE CENTER**

TO BE CODED BY THE ZONE CENTER**INJURY CONSEQUENCES****TRAUMA DATA**66. Time to Death 01

Code number of hours from time of accident to time of death up through 24 hours. If time of death is greater than 24 hours, code number of days. (Note: 1 day = 31, 2 days = 32, ... n days = 30 + n up through 30 days = 60)

- (00) Not fatal
(96) Fatal - ruled disease
(99) Unknown

67. 1st Medically Reported Cause of Death 0168. 2nd Medically Reported Cause of Death 0069. 3rd Medically Reported Cause of Death 00

Code the Occupant Injury from line number(s) for the medically reported injury(s) which reportedly contributed to this occupant's death

- (00) Not fatal or no additional causes
(96) Mode of death given but specific injuries are not linked to cause of death. (specify):

(97) Other result (includes fatal ruled disease) (specify):

(99) Unknown

70. Number of Recorded Injuries for This Occupant 15

Code the actual number of injuries recorded for this occupant.

- (00) No recorded injuries
(97) Injured, details unknown
(99) Unknown if injured

71. Glasgow Coma Scale (GCS) Score (at Medical Facility) 01

- (00) Not injured
(01) Injured - not treated at medical facility
(02) No GCS Score at medical facility
(03-15) Code the actual value of the initial GCS Score recorded at medical facility.
(97) Injured, details unknown
(99) Unknown if injured

72. Was the Occupant Given Blood? 1

- (1) No - blood not given
(2) Yes - blood given
(specify units):
(9) Unknown if blood given

73. Arterial Blood Gases (ABG) - HCO₃ 01

- (00) Not injured
(01) Injured, ABGs not measured or reported
(02-50) Code the actual value of the HCO₃
(96) ABGs reported, HCO₃ unknown
(97) Injured, details unknown
(99) Unknown if injured

BELT USE DETERMINATION74. Primary Source of Belt Use Determination 1

- (0) Not equipped/not available/destroyed or rendered inoperative
(1) Vehicle inspection
(2) Official injury data
(3) Driver/occupant interview
(8) Other (specify):
(9) Unknown if belt used



OCCUPANT INJURY FORM

1. Primary Sampling Unit Number	<u>04</u>	3. Vehicle Number	<u>01</u>
2. Case Number - Stratum	<u>029A</u>	4. Occupant Number	<u>01</u>

INJURY DATA

Record below the actual injuries sustained by this occupant that were identified from the official and unofficial data sources. Remember not to double count an injury just because it was identified from two different sources. If greater than ten injuries have been documented, encode the balance on the Occupant Injury Supplement.

Source of Injury Data	A.I.S. - 90						Injury Source	Injury Confidence Level	Direct/Indirect Injury	Occupant Area Intrusion Number	
	Body Region	Type of Anatomic Structure	Specific Anatomic Structure	Level of Injury	A.I.S. Severity	Aspect					
<i>Brain</i> ① <i>loc</i> 1st	5. <u>1</u>	6. <u>1</u>	7. <u>4</u>	8. <u>06</u>	9. <u>88</u>	10. <u>4</u>	11. <u>1</u>	12. <u>453</u>	13. <u>3</u>	14. <u>1</u>	15. <u>00</u>
<i>cerebellum</i> ② <i>subarachnoid hemorrhage</i> 2nd	16. <u>1</u>	17. <u>1</u>	18. <u>4</u>	19. <u>04</u>	20. <u>66</u>	21. <u>3</u>	22. <u>6</u>	23. <u>453</u>	24. <u>3</u>	25. <u>1</u>	26. <u>00</u>
<i>subdural hemorrhage</i> ③ 3rd	27. <u>1</u>	28. <u>1</u>	29. <u>4</u>	30. <u>06</u>	31. <u>50</u>	32. <u>4</u>	33. <u>1</u>	34. <u>453</u>	35. <u>3</u>	36. <u>1</u>	37. <u>00</u>
<i>epidural hemorrhage</i> ④ 4th	38. <u>1</u>	39. <u>1</u>	40. <u>4</u>	41. <u>06</u>	42. <u>30</u>	43. <u>4</u>	44. <u>1</u>	45. <u>453</u>	46. <u>3</u>	47. <u>1</u>	48. <u>00</u>
<i>skull fl</i> ⑤ 5th	49. <u>1</u>	50. <u>1</u>	51. <u>5</u>	52. <u>04</u>	53. <u>04</u>	54. <u>3</u>	55. <u>1</u>	56. <u>453</u>	57. <u>3</u>	58. <u>1</u>	59. <u>00</u>
<i>loc</i> ⑥ <i>lung</i> 6th	60. <u>1</u>	61. <u>4</u>	62. <u>4</u>	63. <u>14</u>	64. <u>30</u>	65. <u>3</u>	66. <u>1</u>	67. <u>0113</u>	68. <u>3</u>	69. <u>1</u>	70. <u>00</u>
<i>scalp</i> ⑦ <i>loc</i> 7th	71. <u>1</u>	72. <u>1</u>	73. <u>9</u>	74. <u>06</u>	75. <u>00</u>	76. <u>1</u>	77. <u>1</u>	78. <u>453</u>	79. <u>3</u>	80. <u>1</u>	81. <u>00</u>
<i>scalp</i> ⑧ <i>abr</i> 8th	82. <u>1</u>	83. <u>1</u>	84. <u>9</u>	85. <u>02</u>	86. <u>02</u>	87. <u>1</u>	88. <u>1</u>	89. <u>453</u>	90. <u>3</u>	91. <u>1</u>	92. <u>00</u>
<i>face</i> ⑨ <i>loc</i> 9th	93. <u>1</u>	94. <u>2</u>	95. <u>9</u>	96. <u>06</u>	97. <u>00</u>	98. <u>1</u>	99. <u>1</u>	100. <u>453</u>	101. <u>3</u>	102. <u>1</u>	103. <u>00</u>
<i>face</i> ⑩ <i>abr</i> 10th	104. <u>1</u>	105. <u>2</u>	106. <u>9</u>	107. <u>02</u>	108. <u>02</u>	109. <u>1</u>	110. <u>1</u>	111. <u>453</u>	112. <u>3</u>	113. <u>1</u>	114. <u>00</u>

OCCUPANT INJURY CLASSIFICATION

Body Region	Specific Anatomic Structure	Level of Injury	Aspect
(1) Head (2) Face (3) Neck (4) Thorax (5) Abdomen (6) Spine (7) Upper Extremity (8) Lower Extremity (9) Unspecified	<u>Vessels, Nerves, Organs.</u> <u>Bones, Joints</u> are assigned consecutive two digit numbers beginning with 02. The exceptions to this rule apply to:	Specific injuries are assigned consecutive two-digit numbers beginning with 02. To the extent possible, within the organizational framework of the AIS, 00 is assigned to an injury NFS as to severity or where only one injury is given in the dictionary for that anatomic structure. 99 is assigned to any injury NFS as to lesion or severity.	(1) Right (2) Left (3) Bilateral (4) Central (5) Anterior (6) Posterior (7) Superior (8) Inferior (9) Unknown (0) Whole region
Type of Anatomic Structure	<u>Whole Area</u> (02) Skin - Abrasion (04) Skin - Contusion (06) Skin - Laceration (08) Skin - Avulsion (10) Amputation (20) Burn (30) Crush (40) Degloving (50) Injury - NFS (90) Trauma, other than mechanical <u>Head - LOC</u> (02) Length of LOC (04) Level (06) of (08) Consciousness (10) Concussion <u>Spine</u> (02) Cervical (04) Thoracic (06) Lumbar	Abbreviated Injury Scale (1) Minor Injury (2) Moderate Injury (3) Serious Injury (4) Severe Injury (5) Critical Injury (6) Maximum (untreatable) (7) Injured, unknown severity	

SOURCE OF INJURY DATA

INJURY SOURCE

DIRECT/INDIRECT INJURY

OFFICIAL RECORDS

- (1) Autopsy records with or without hospital/medical records
- (2) Hospital/medical records other than emergency room (e.g., discharge summary)
- (3) Emergency room records only (including associated X-rays or other lab reports)
- (4) Private physician, walk-in or emergency clinic

UNOFFICIAL RECORDS

- (5) Lay coroner report
- (6) E.M.S. personnel
- (7) Interviewee
- (8) Other source (specify): _____
- (9) Police

CONFIDENCE LEVEL

- (1) Certain
- (2) Probable
- (3) Possible
- (9) Unknown

- (1) Direct contact injury
- (2) Indirect contact injury
- (3) Noncontact injury
- (7) Injured, unknown source

INJURY SOURCES

FRONT

- (001) Windshield
- (002) Mirror
- (003) Sunvisor
- (004) Steering wheel rim
- (005) Steering wheel hub/spoke
- (006) Steering wheel (combination of codes 004 and 005)
- (007) Steering column, transmission selector lever, other attachment
- (008) Cellular telephone or CB radio
- (009) Add on equipment (e.g., tape deck, air conditioner)
- (010) Left instrument panel and below
- (011) Center instrument panel and below
- (012) Right instrument panel and below
- (013) Glove compartment door
- (014) Knee bolster
- (015) Windshield including one or more of the following: front header, A (A1/A2)-pillar, instrument panel, mirror, or steering assembly (driver side only)
- (016) Windshield including one or more of the following: front header, A (A1/A2)-pillar, instrument panel, or mirror (passenger side only)
- (017) Windshield reinforced by exterior object (specify):

- (019) Other front object (specify):

LEFT SIDE

- (051) Left side interior surface, excluding hardware or armrests
- (052) Left side hardware or armrest
- (053) Left A (A1/A2)-pillar
- (054) Left B-pillar
- (055) Other left pillar (specify):

- (056) Left side window glass
- (057) Left side window frame
- (058) Left side window sill
- (059) Left side window glass including one or more of the following: frame, window sill, A (A1/A2)-pillar, B-pillar, or roof side rail.
- (060) Other left side object (specify):

RIGHT SIDE

- (101) Right side interior surface, excluding hardware or armrests

- (102) Right side hardware or armrest
- (103) Right A (A1/A2)-pillar
- (104) Right B-pillar
- (105) Other right pillar (specify):

- (106) Right side window glass
- (107) Right side window frame
- (108) Right side window sill
- (109) Right side window glass including one or more of the following: frame, window sill, A (A1/A2)-pillar, B-pillar, or roof side rail.
- (110) Other right side object (specify):

INTERIOR

- (151) Seat, back support
- (152) Belt restraint webbing/buckle
- (153) Belt restraint B-pillar or door frame attachment point
- (154) Other restraint system component (specify):

- (155) Head restraint system
- (160) Other occupants (specify):

- (161) Interior loose objects
- (162) Child safety seat (specify):

- (163) Other interior object (specify):

AIR BAG

- (170) Air bag-driver side
- (171) Air bag-driver side and eyewear
- (172) Air bag-driver side and jewelry
- (173) Air bag-driver side and object held
- (174) Air bag-driver side and object in mouth
- (175) Air bag compartment cover-driver side
- (176) Air bag compartment cover-driver side and eyewear
- (177) Air bag compartment cover-driver side and jewelry
- (178) Air bag compartment cover-driver side and object held
- (179) Air bag compartment cover-driver side and object in mouth
- (180) Air bag-passenger side
- (181) Air bag-passenger side and eyewear
- (182) Air bag-passenger side and jewelry

- (183) Air bag-passenger side and object held
- (184) Air bag-passenger side and object in mouth
- (185) Air bag compartment cover-passenger side
- (186) Air bag compartment cover-passenger side and eyewear
- (187) Air bag compartment cover-passenger side and jewelry
- (188) Air bag compartment cover-passenger side and object held
- (189) Air bag compartment cover-passenger side and object in mouth
- (190) Other air bag (specify)

- (195) Other air bag compartment cover (specify)

- (195) Other air bag compartment cover (specify)

ROOF

- (201) Front header
- (202) Rear header
- (203) Roof left side rail
- (204) Roof right side rail
- (205) Roof or convertible top

FLOOR

- (251) Floor (including toe pan)
- (252) Floor or console mounted transmission lever, including console
- (253) Parking brake handle
- (254) Foot controls including parking brake

REAR

- (301) Backlight (rear window)
- (302) Backlight storage rack, door, etc.
- (303) Other rear object (specify):

ADAPTIVE (ASSISTIVE) DRIVING EQUIPMENT

- (401) Hand controls for braking/acceleration
- (402) Steering control devices (attached to OEM steering wheel)
- (403) Steering knob attached to steering wheel
- (405) Replacement steering wheel (i.e., reduced diameter)
- (406) Joy stick steering controls
- (407) Wheelchair tie-downs
- (408) Modification to seat belts, (specify):

- (409) Additional or relocated switches, (specify):

- (410) Raised roof

- (411) Wall mounted head rest (used behind wheel chair)
- (412) Other adaptive device (specify):

EXTERIOR OF OCCUPANT'S VEHICLE

- (451) Hood
- (452) Outside hardware (e.g., outside mirror, antenna)
- (453) Other exterior surface or tires (specify):
Disappearing roof.

- (454) Unknown exterior objects

EXTERIOR OF OTHER MOTOR VEHICLE

- (501) Front bumper
- (502) Hood edge
- (503) Other front of vehicle (specify):

- (504) Hood
- (505) Hood ornament
- (506) Windshield, roof rail, A-pillar
- (507) Side surface
- (508) Side mirrors
- (509) Other side protrusions (specify):

- (510) Rear surface
- (511) Undercarriage
- (512) Tires and wheels
- (513) Other exterior of other motor vehicle (specify):

- (514) Unknown exterior of other motor vehicle

OTHER VEHICLE OR OBJECT IN THE ENVIRONMENT

- (551) Ground
- (598) Other vehicle or object (specify):

- (599) Unknown vehicle or object

NONCONTACT INJURY

- (601) Fire in vehicle
- (602) Flying glass
- (603) Other noncontact injury source (specify):

- (604) Air bag exhaust gases
- (697) Injured, unknown source

OFFICIAL INJURY DATA — SOFT TISSUE INJURIES

Indicate the Location, Specific Anatomic Structure, Detail (size, depth, fracture type, head injury clinical signs and neurological deficits), and Source of all injuries indicated by official sources (or from PAR or other unofficial sources if medical records and interviewee data are unavailable.)

ALL INJURIES FROM AUTOPSY

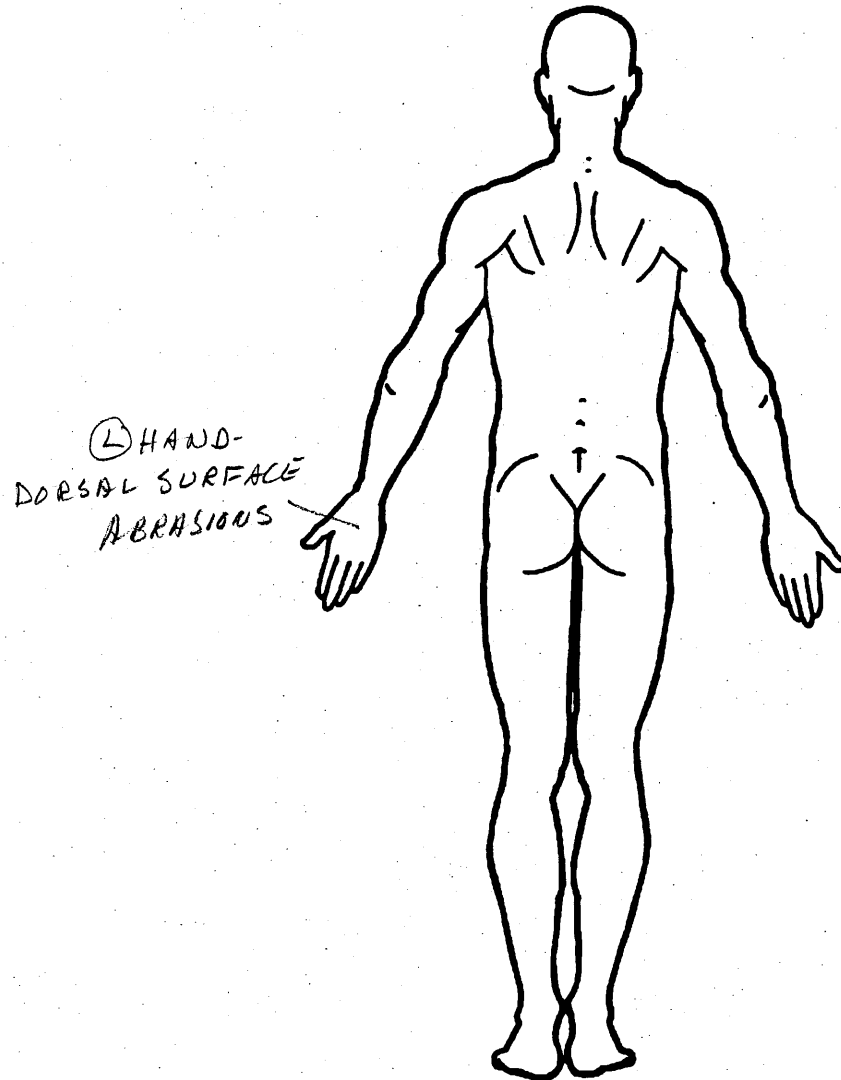
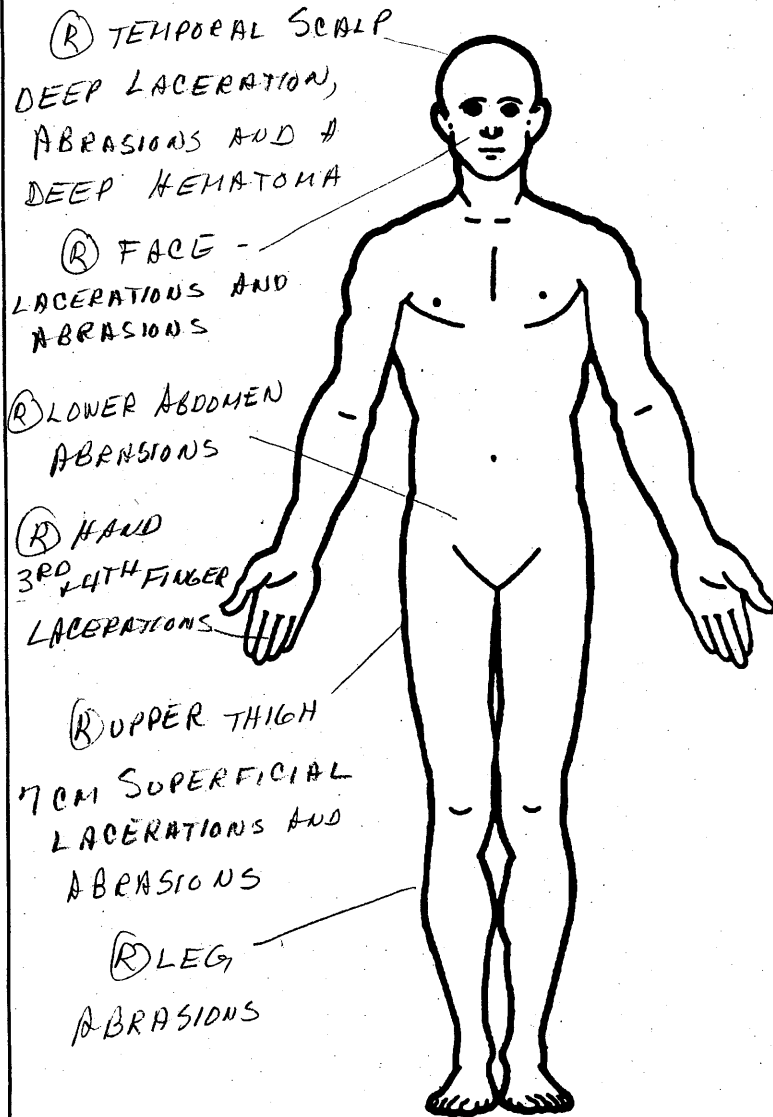

OFFICIAL INJURY DATA — SKELETAL INJURIES

Restrained?

No

Yes

Blood Alcohol Level (mg/dl)

BAL = 0.83

⊕ Cocaine

Glasgow Coma Scale Score

GCSS = DDA

Units of Blood Given

Units = DDA

Arterial Blood Gases

pH =

PO₂ =

PCO₂ =

HCO₃ =

DDA

Indicate the Location, Specific Anatomic Structure, Detail (size, depth, fracture type, head injury clinical signs and neurological deficits), and Source of all injuries indicated by official sources (or from PAR or other unofficial sources if medical records and interviewee data are unavailable.)

ALL INJURIES FROM AUTOPSY

SKULL SHOWS MULTIPLE AND EXTENSIVE FRACTURES, SOME OF WHICH APPEAR TO BE DEPRESSED ESPECIALLY (R) PARIETAL AREA

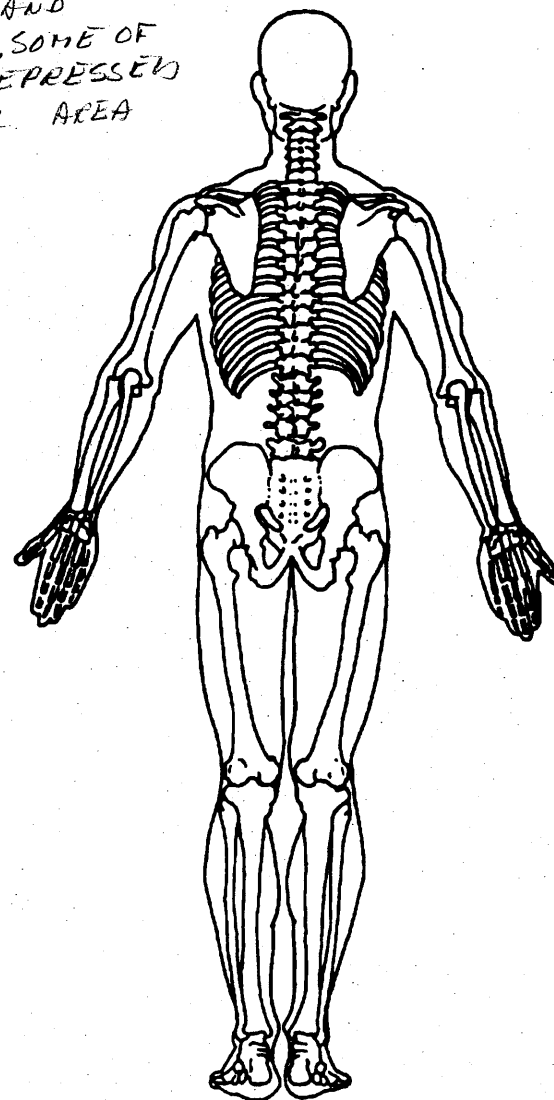
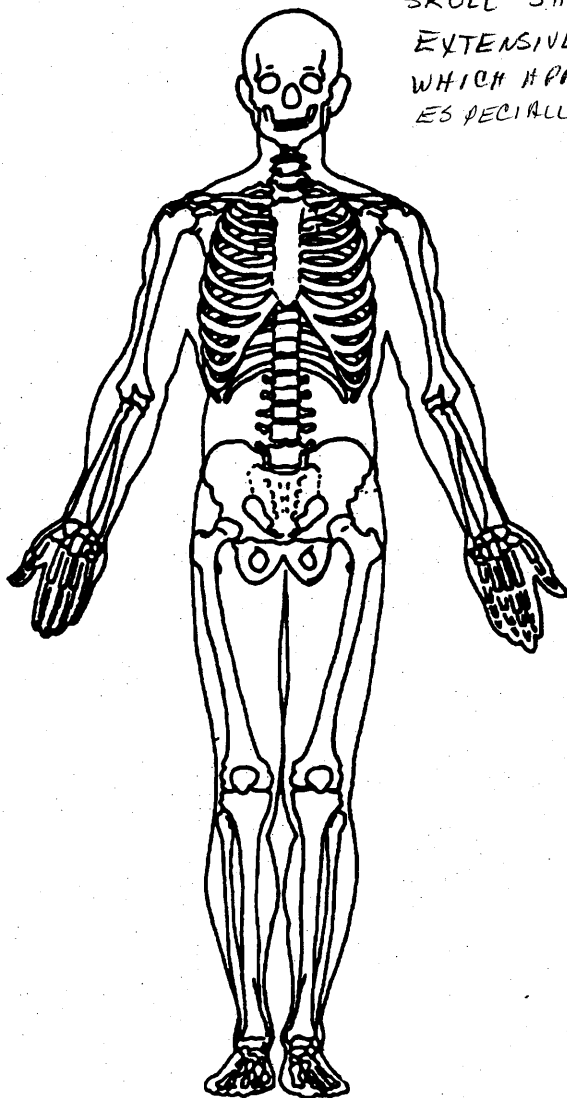

OFFICIAL INJURY DATA — INTERNAL INJURIES

Indicate the Location, Specific Anatomic Structure, Detail (size, depth, fracture type, head injury clinical signs and neurological deficits), and Source of all injuries indicated by official sources (or from PAR or other unofficial sources if medical records and interviewee data are unavailable.)

ALL INJURIES FROM AUTOPSY

Ⓡ TEMPORO-PARIETAL
LOBE OF BRAIN -
EXTENSIVE LACERATIONS

EPIDURAL AND SUBDURAL
HEMORRHAGE ALONG
FRACTURED BONES

CEREBELLUM SHOWS
A MODERATE DEGREE OF
SUBARACHNOID HEMORRHAGE

Ⓡ LUNG SHOWS
LACERATIONS AT THE
HILAR AREA OF LOWER
LOBE

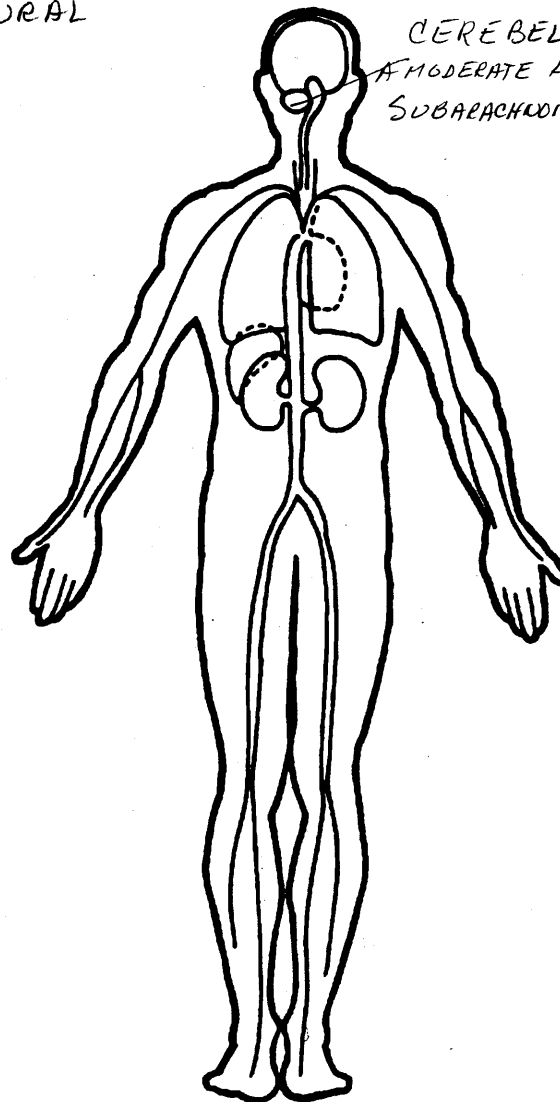
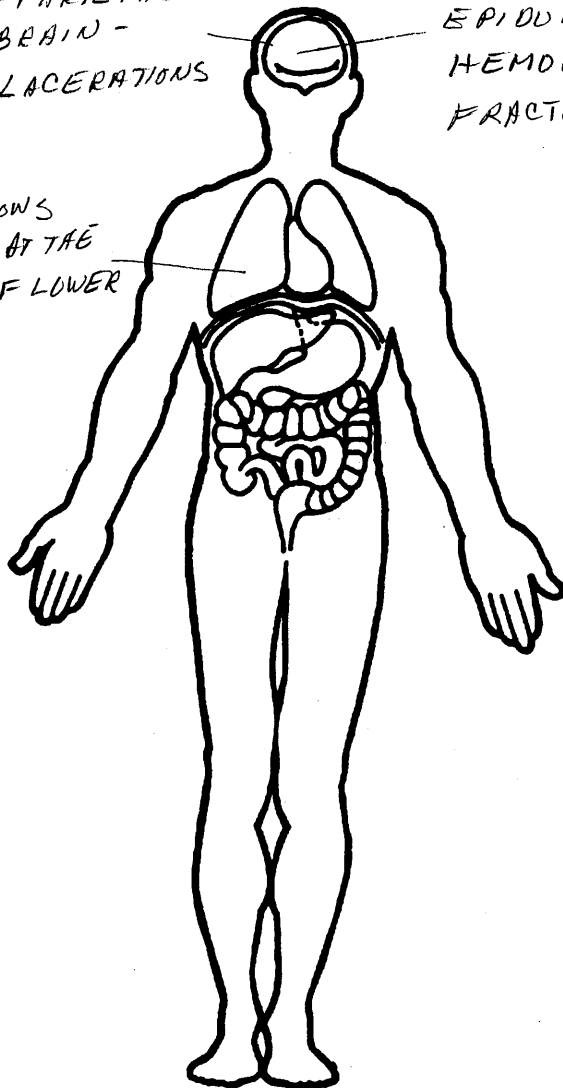



UPDATE FORM

1. Primary Sampling Unit Number 04

2. Case Number - Stratum 029A

3. Vehicle Number 01

4. Occupant Number 01

RECEIVED [REDACTED] 1995

Driver or Occupant Name: _____

Address: _____

Other Information: _____

(Sanitize this section prior to Update submission.)

STATUS OF OCCUPANT INFORMATION

	INITIAL SUBMISSION	UPDATED INFORMATION
OAL08. Date Official Medical Data Requested	[REDACTED]	<u>195</u>
OAL09. Date Official Medical Data Obtained	[REDACTED]	<u>195</u>
OAL16. Injury Treatment Status	<u>02</u>	<u>02</u>
OAL17. Injury Information		
<u>Official</u>		
a. Autopsy (invasive examination)	<u>B 08</u>	<u>11</u>
b. Post-ER medical record which includes information about death based on non-invasive examination	<u>B</u>	---
c. Admission record/summary or admission/discharge face sheet	<u>B</u>	---
d. Discharge summary	<u>B</u>	---
e. Operative report	<u>B</u>	---
f. Radiographic record(s) (X-ray, CT scan)	<u>B</u>	---
g. History and physical examination and/or consultation records	<u>B</u>	---
h. Emergency room records (includes nurses' notes)	<u>B</u>	---
j. Private physician	<u>B</u>	---
<u>Unofficial</u>		
k. Lay coroner	<u>B</u>	---
l. EMS record	<u>B</u>	---
m. Interviewee	<u>B</u>	---
n. Other source (specify):	<u>B</u>	<u>B</u>
o. Police report	<u>B</u>	<u>B</u>

	INITIAL SUBMISSION	UPDATED INFORMATION
OAL18. Medical Facility Code	<u>01</u>	<u>01</u>
GV14. Alcohol Test Results For Driver	<u>99</u>	<u>97</u>
GV16. Other Drug Specimen Test Type For Driver	<u>9</u>	<u>3</u>
OA05. Occupant's Age	<u>25</u>	<u>25</u>
OA06. Occupant's Sex	<u>1</u>	<u>1</u>
OA07. Occupant's Height	<u>999</u>	<u>999</u>
OA08. Occupant's Weight	<u>999</u>	<u>240</u>
OA61. Treatment-Mortality	<u>1</u>	<u>1</u>
OA62. Type of Medical Facility (for Initial Treatment)	<u>2</u>	<u>2</u>
OA63. Hospital Stay	<u>00</u>	<u>00</u>



CRASHPC PROGRAM SUMMARY

(All Measurements in Metric)

NATIONAL ACCIDENT SAMPLING SYSTEM
CRASHWORTHINESS DATA SYSTEM

Identifying Title <u>04</u> Primary Sampling Unit	<u>029A</u> Case No.-Stratum	<u>01</u> Accident Event Sequence No.	<u>071895</u> Date (Month, day, year) of Run
---	---------------------------------	--	---

CRASHPC Vehicle Identification				
Vehicle 1	<u>1993</u>	<u>Dodge</u>	<u>Shadow</u>	<u>1</u>
Vehicle 2				
	Year	Make	Model	NASS Veh. No.

GENERAL INFORMATION

	VEHICLE 1	VEHICLE 2
Size	<u>2</u>	<u>11</u>
Weight	<u>185</u> + <u>109</u> + <u>—</u> = <u>1294</u> kg	<u>—</u> + <u>—</u> + <u>—</u> = <u>—</u> kg
	Curb Occupant(s) Cargo	Curb Occupant(s) Cargo
CDC	<u>12 FREE4</u>	<u>—</u>
PDOF (-180 to +180)	<u>010</u> °	<u>+</u> <u>—</u> °
Stiffness	<u>9</u>	<u>—</u>

SCENE INFORMATION

Rest and Impact Positions No, **Go To Damage Information** Yes

	VEHICLE 1	VEHICLE 2
Rest Position	X <u>—</u> m Y <u>—</u> m PSI <u>—</u> °	X <u>—</u> m Y <u>—</u> m PSI <u>—</u> °
Impact Position	X <u>—</u> m Y <u>—</u> m PSI <u>—</u> °	X <u>—</u> m Y <u>—</u> m PSI <u>—</u> °
Slip Angle(-180 to +180)	<u>—</u> °	<u>—</u> °

VEHICLE MOTION

Sustained Contact No Yes

	VEHICLE 1	VEHICLE 2
Vehicle Rotation	<input type="checkbox"/> No <input type="checkbox"/> Yes	<input type="checkbox"/> No <input type="checkbox"/> Yes
Rotation Stop Before Rest	<input type="checkbox"/> No <input type="checkbox"/> Yes	<input type="checkbox"/> No <input type="checkbox"/> Yes
End of Rotation Position	X <u>—</u> m Y <u>—</u> m PSI <u>—</u> °	X <u>—</u> m Y <u>—</u> m PSI <u>—</u> °
Curved Path	<input type="checkbox"/> No <input type="checkbox"/> Yes	<input type="checkbox"/> No <input type="checkbox"/> Yes
Point on Path	X <u>—</u> m Y <u>—</u> m	X <u>—</u> m Y <u>—</u> m
Rotation Direction	<input type="checkbox"/> None <input type="checkbox"/> CW <input type="checkbox"/> CCW	<input type="checkbox"/> None <input type="checkbox"/> CW <input type="checkbox"/> CCW
Rotation >360°	<input type="checkbox"/> No <input type="checkbox"/> Yes	<input type="checkbox"/> No <input type="checkbox"/> Yes

FRICITION INFORMATION

TRAJECTORY INFORMATION

Coefficient of Friction _____
 Rolling Resistance Option _____

Vehicle 1 Rolling Resistance

LF _____ RF _____
 LR _____ RR _____

Vehicle 2 Rolling Resistance

LF _____ RF _____
 LR _____ RR _____

Trajectory Data No Yes
 If No, Go To Damage Information

Vehicle 1 Steer Angles

LF _____ ° RF _____ °
 LR _____ ° RR _____ °

Vehicle 2 Steer Angles

LF _____ ° RF _____ °
 LR _____ ° RR _____ °

Terrain Boundary No Yes

First Point

X _____ m Y _____ m

Second Point

X _____ m Y _____ m

Secondary Coefficient of Friction _____

DAMAGE INFORMATION

VEHICLE 1

VEHICLE 2

Damage Length L 106 cm

Damage Length L _____ cm

Crush Depths C₁ 007 cm
 C₂ 020 cm
 C₃ 037 cm
 C₄ 035 cm
 C₅ 056 cm
 C₆ 078 cm

Crush Depths C₁ _____ cm
 C₂ _____ cm
 C₃ _____ cm
 C₄ _____ cm
 C₅ _____ cm
 C₆ _____ cm

Damage Offset D 054 cm

Damage Offset D [±] _____ cm

IF THIS COMMON IMPACT WAS WITH A MOTOR VEHICLE NOT IN TRANSPORT, FILL IN THE INFORMATION BELOW.

Model Year: _____
 Make: _____
 Model: _____
 VIN: _____

The Weight, CDC, Scene Data and Damage Information for this vehicle should be recorded above.

Complete and ATTACH the appropriate vehicle damage sketch and dimensions to the Form.

SUMMARY OF CRASHPC RESULTS USING DAMAGE

04029A barrier

SPEED CHANGE
(DAMAGE)

VEHICLE #1

TOTAL	34 KPH (21 MPH)
LONGITUDINAL	-33 KPH (-21 MPH)
LATITUDINAL	-6 KPH (-4 MPH)
PDOF ANGLE	10 DEGREES
ENERGY DISSIPATED =	60708 JOULES (44770 FT-LB)

VEHICLE #2

TOTAL	0 KPH (0 MPH)
LONGITUDINAL	0 KPH (0 MPH)
LATITUDINAL	0 KPH (0 MPH)
PDOF ANGLE	0 DEGREES
ENERGY DISSIPATED =	0 JOULES (0 FT-LB)

DAMAGE DATA

	VEHICLE #1	VEHICLE #2
SIZE CATEGORY	2	11
STIFFNESS CATEGORY	9	0
VEHICLE WEIGHT	1294 KGS (2853 LBS)	***** KGS (2204586 LBS) *
CDC	12FREE4	BARRIER
PDOF ANGLE	10 DEGREES	0 DEGREES *
CRUSH LENGTH	106 CM. (42 IN.)	0 CM. (0 IN.) *
C1	7 CM. (3 IN.)	0 CM. (0 IN.) *
C2	20 CM. (8 IN.)	0 CM. (0 IN.) *
C3	34 CM. (13 IN.)	0 CM. (0 IN.) *
C4	35 CM. (14 IN.)	0 CM. (0 IN.) *
C5	56 CM. (22 IN.)	0 CM. (0 IN.) *
C6	78 CM. (31 IN.)	0 CM. (0 IN.) *
D	54 CM. (21 IN.)	0 CM. (0 IN.) *
D'	69 CM. (27 IN.)	0 CM. (0 IN.) *

(* INDICATES DEFAULT VALUE)

DIMENSIONS AND INERTIAL PROPERTIES

	VEHICLE #1	VEHICLE #2
CG TO FRONT AXLE	118 CM. (46 IN.)	127 CM. (50 IN.)
CG TO REAR AXLE	127 CM. (50 IN.)	127 CM. (50 IN.)
TRACK	139 CM. (55 IN.)	127 CM. (50 IN.)
CG TO FRONT OF VEH	212 CM. (83 IN.)	127 CM. (50 IN.)
CG TO REAR OF VEH	-233 CM. (-92 IN.)	-127 CM. (-50 IN.)
CG TO SIDE OF VEH	85 CM. (34 IN.)	127 CM. (50 IN.)
MOMENT OF INERTIA	9929 KGS (21889 LBS)	***** KGS (***** LBS)
VEHICLE MASS	3 KGS (7 LBS)	2600 KGS (5732 LBS)

Printing Picture:

CRASH

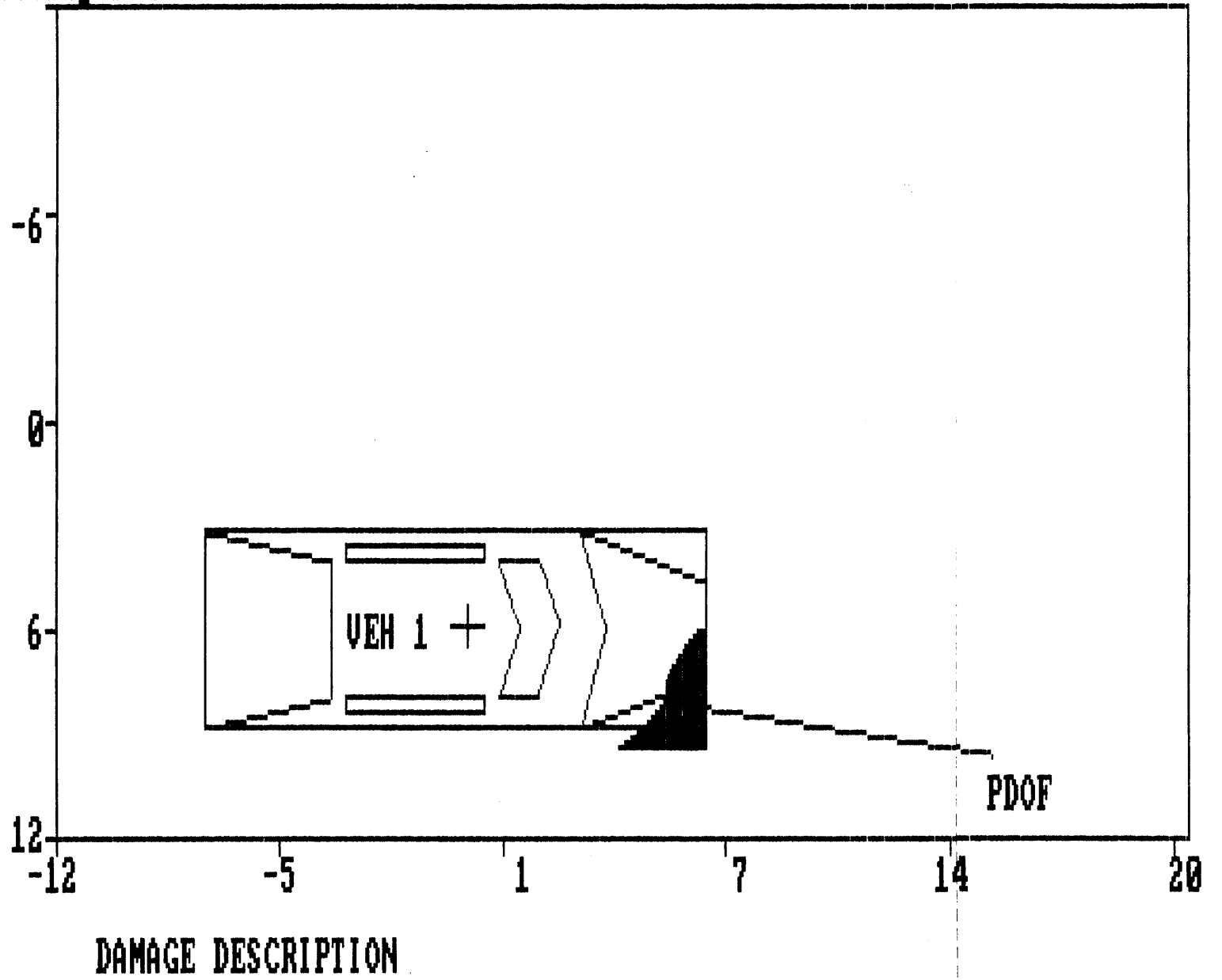

INTRA ERRORS

GG0191 2 If ALCOHOL TEST GV14 equals 05-49, then REPORTED ALCOHOL
 GG0192 PRESENCE GV13 should equal 1.

GG0421 2 If ROLLOVER GV45 equals 01-17 or 98, then BASIS FOR DELTA V GV58
 GG0422 should equal 04-10.

INTERIOR VEHICLE Vehicle: 1

INTRA ERRORS

CC0531 2 ***** THIS CASE SHOWS A DOOR OR HATCH OR GATE OPENING *****
 CC0532 ***** CHECK YOUR DATA AND IF CORRECT, NOTIFY YOUR ZONE *****
 CC0533 DOOR LEFT FRONT IV05 equals 2 or IV06 equals 2 or IV07 equals 2
 CC0534 or IV08 equals 2 or IV09 equals 2.

OCCUPANT ASSESSMENT Vehicle: 1 Occupant: 1

INTRA ERRORS

HH1271 2 ***** THIS CASE SHOWS EJECTION WITH RESTRAINT USAGE. *****
 HH1272 ***** CHECK YOUR DATA AND IF CORRECT, NOTIFY YOUR ZONE *****
 HH1273 EJECTION OA12 is equal to 1-3 and ((MANUAL BELT USE OA19 does
 HH1274 not equal 00, 01 or 99) or
 HH1275 (FRONTAL AIR BAG SYSTEM DEPLOYMENT OA31 does not equal 0, 7 or
 HH1276 9) or (AUTOMATIC BELT USE OA24 does not equal 0, 2 or 9)).

PSU04
 CASE 029A
 CURRENT VERSION: 8.04

ERROR SUMMARY SCREEN

795

FORM NAME	NUMBER OF DOLLAR SIGNS	NUMBER OF LEVEL 1 ERRORS	NUMBER OF LEVEL 2 ERRORS	VERSION NUMBER CONSISTENT
Accident	0	0	0	Y
General Vehicle	0	0	2	Y
Vehicle Exterior	0	0	0	Y
Vehicle Interior	0	0	1	Y
Occupant Assessment	0	0	1	Y
Occupant Injury	0	0	0	Y
Total Inter Errors		0	0	
Total Case Errors	0	0	4	



PSU 04-029A (1995) #1



PSU 04-029A (1995) #2



PSU 04-029A (1995) #3



PSU 04-029A (1995) #4



PSU 04-029A (1995) #5



PSU 04-029A (1995) #6



PSU 04-029A (1995) #7



PSU 04-029A (1995) #8



PSU 04-029A (1995) #9



PSU 04-029A (1995) #10



PSU 04-029A (1995) #11



PSU 04-029A (1995) #12



PSU 04-029A (1995) #13



PSU 04-029A (1995) #14



PSU 04-029A (1995) #15



PSU 04-029A (1995) #16



PSU 04-029A (1995) #17



PSU 04-029A (1995) #18



PSU 04-029A (1995) #19



PSU 04-029A (1995) #20



PSU 04-029A (1995) #21



PSU 04-029A (1995) #22



PSU 04-029A (1995) #23



PSU 04-029A (1995) #24



PSU 04-029A (1995) #25



PSU 04-029A (1995) #26



PSU 04-029A (1995) #27



PSU 04-029A (1995) #28



PSU 04-029A (1995) #29



PSU 04-029A (1995) #30



PSU 04-029A (1995) #31



PSU 04-029A (1995) #32



PSU 04-029A (1995) #33
Best Available



PSU 04-029A (1995) #34



PSU 04-029A (1995) #35



PSU 04-029A (1995) #36



PSU 04-029A (1995) #37
Best Available



PSU 04-029A (1995) #38
Best Available



PSU 04-029A (1995) #39
Best Available



PSU 04-029A (1995) #40



PSU 04-029A (1995) #41



PSU 04-029A (1995) #42



PSU 04-029A (1995) #43



PSU 04-029A (1995) #44



PSU 04-029A (1995) #45



PSU 04-029A (1995) #46



PSU 04-029A (1995) #47
Best Available



PSU 04-029A (1995) #48
Best Available



PSU 04-029A (1995) #49
Best Available



PSU 04-029A (1985) #50
Best Available



PSU 04-029A (1995) #51

Best Available



PSU 04-029A (1995) #52
Best Available



PSU 04-029A (1995) #53
Best Available



PSU 04-029A (1995) #54
Best Available



PSU 04-029A (1995) #55
Best Available



PSU 04-029A (1995) #56
Best Available



PSU 04-020A (1995) #57
Best Available



PSU 04-029A (1995) #58



PSU 04-029A (1995) #69
Best Available



PSU 04-029A (1995) #60
Best Available



PSU 04-029A (1995) #61
Best Available



PSU 04-029A (1995) #62



PSU 04-029A (1996) #63
Best Available



PSU 04-029A (1995) #64
Best Available



PSU 04-029A (1995) #65
Best Available



PSU 04-029A (1995) #66



PSU 04-029A (1995) #67



PSU 04-029A (1995) #68



PSU 04-029A (1995) #69



PSU 04-029A (1995) #70
Best Available



PSU 04-029A (1995) #71



PSU 04-029A (1995) #72



PSU 04-029A (1995) #73



PSU 04-029A (1995) #74



PSU 04-029A (1995) #75
Best Available



FSU 04-029A (1995) #76



PSU 04-029A (1995) #77



PSU 04-029A (1995) #78



PSU 04-029A (1995) #79



PSU 04-029A (1995) #80