



U.S. Department
of Transportation

**National Highway
Traffic Safety
Administration**

400 Seventh Street, S.W.
Washington, D.C. 20590

Dear Crash Data Researchers/Users:

Thank you for choosing crash data from the National Highway Traffic Safety Administration (NHTSA) for your research or other use. The information contained in this motor vehicle crash report is collected, maintained and distributed in accordance with Public Law 89-564. In accordance with this Public Law, NHTSA is required not to release any case information until completion of quality control procedures. These procedures include a review of the case material to extract all names, licenses and registration numbers, non-coded interview material, non-research related researcher comments in the margins, non-factual data, and the production number portion of the vehicle identification number (VIN).

If you requested NHTSA to query its database files in order to identify a specific crash, then that query was made using non-personal descriptors you provided for use in our search. This motor vehicle crash may have been identified from a data search and matches the general, non-personal descriptors you provided, but we cannot confirm that this is the specific crash report you requested.

If you have any questions with regard to the above procedures, please contact the Field Operations Branch, Crash Investigation Division, National Center for Statistics and Analysis at 202-366-4820. Again, please be advised that we cannot confirm that this is the case that you have specifically requested nor can we certify the information to be correct.

*** **



AUTO SAFETY HOTLINE
(800) 424-9393
Wash. D.C. Area 366-0123



CASE SUMMARY

PSU 48 CASE NO. 140A TYPE OF ACCIDENT _____

A. DESCRIPTION OF THE ACCIDENT SEQUENCE AND ACCIDENT PECULIARITIES

(Provide a summary of the accident sequence as well as any particular event of the accident that is noteworthy. Injury mechanism and vehicle crashworthiness is the focus, not driver culpability. Do not include any personal identifiers.)

SEE ATTACHED

B. VEHICLE PROFILE(S)

Vehicle No.	Class of Vehicle	Year/Make/Model	Most Severe Damage Based on Vehicle Inspection		Component Failure
			Damage Plane	Severity Description	

DO NOT SANITIZE THIS FORM

C. PERSON PROFILE(S)

Vehicle No.	Person Role	Seat Position	Restraint Use	Most Severe Injury (TO BE COMPLETED BY ZONE CENTER)			
				Body Region	Injury Type	AIS	Injury Source

Body Region

Abdomen
 Ankle-foot
 Arm (upper)
 Back-thoracolumbar spine
 Brain
 Chest
 Ears
 Eye
 Elbow
 Face
 Forearm
 Head-skull
 Heart
 Kidneys
 Knee
 Leg (lower)
 Liver
 Lower limbs(s) (whole or unknown part)
 Mouth
 Neck-cervical spine
 Nose

Pelvic-hip

Pulmonary-lungs
 Shoulder
 Spleen
 Thigh
 Thyroid, other endocrine gland
 Upper limb(s) (whole or unknown part)
 Vertebrae
 Whole body
 Wrist-hand

Injury Type

Abrasion
 Amputation
 Avulsion
 Burn
 Concussion
 Contusion
 Crush
 Detachment, separation
 Dislocation

Fracture

Fracture and dislocation
 Laceration
 Other
 Perforation, puncture
 Rupture
 Sprain
 Strain
 Total severance, transection
 Unknown

Abbreviated Injury Scale

- (1) Minor injury
- (2) Moderate injury
- (3) Serious injury
- (4) Severe injury
- (5) Critical injury
- (6) Maximum (untreatable)
- (7) Injured, unknown severity

DO NOT SANITIZE THIS FORM

PSU48

1996 Case Summary Form

CASE 140A

TYPE OF ACCIDENT: CAR-RAN OFF ROAD

A. DESCRIPTION OF THE ACCIDENT SEQUENCE AND ACCIDENT PECULIARITIES

V1 WAS TRAVELING SOUTH ON A FOUR-LANE INTERSTATE ROADWAY. WHILE NEGOTIATING A LEFT HAND CURVE V1 TRAVELED OFF THE RIGHT SIDE OF THE ROAD. V1 STRUCK A DITCH WITH ITS FRONT THEN STRUCK SEVERAL TREES WITH ITS FRONT. THE FRONT LEFT QUARTER PANEL STRUCK A LARGE TREE AND THEN ROTATED CLOCKWISE 90 DEGREES TO FINAL REST. THE DRIVER WITH A DEPLOYED AIRBAG WAS FATALLY INJURED. V1 WAS TOWED FROM THE SCENE DUE TO DAMAGE.

01

PSU48

1996 Case Summary Form

CASE 140A

TYPE OF ACCIDENT: CAR-RAN OFF ROAD

B. VEHICLE PROFILE(S)

V e h. No	Class of Vehicle	Year/Make/ Model	Most Severe Damage Based on Vehicle Inspection		Component Failure
			Damage Plane	Severity Descr.	
1 01	SUBCOMPACT	96/TOYOTA/COROLLA	LEFT	SEVERE	NONE

PSU48

1996 Case Summary Form

CASE 140A

TYPE OF ACCIDENT: CAR-RAN OFF ROAD

C. PERSON PROFILE(S)

Most Severe Injury
(TO BE COMPLETED BY ZONE CENTER)

V e h. No	Person Role	Seat Positon	Restraint Use	Body Region	Injury Type	A	
						I S	Injury Source
1	DR	FL	AIRBAG NO BELTS	BRAIN	HEMORRHAGE 3		WINDSHIELD HEADER

0

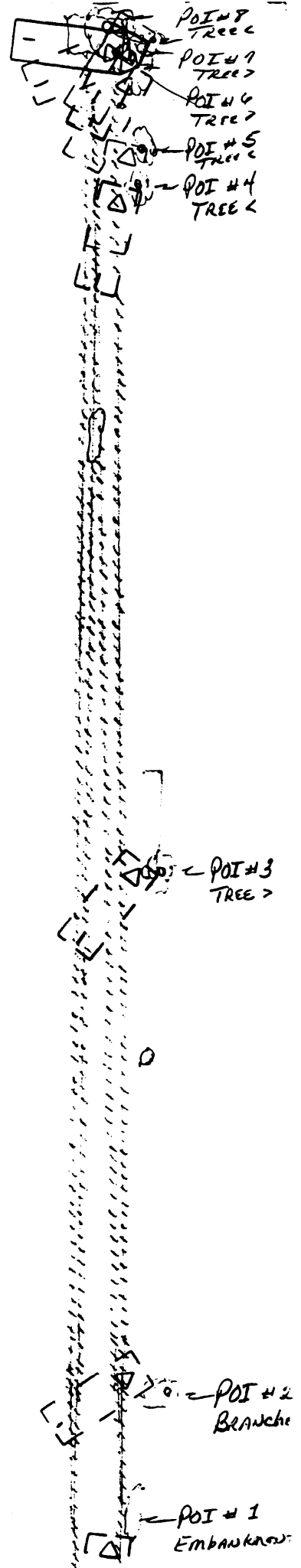

R.P.

R.b.

dry Asphalt

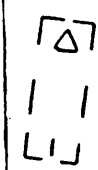
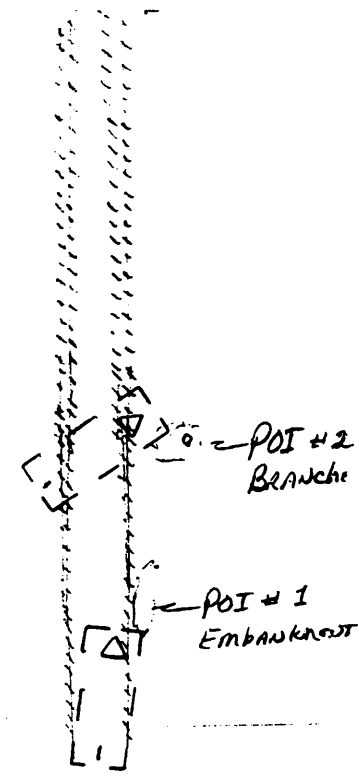

SCALE: 1/250
 P48-140A

R.P.

3 of 3

Dry Asphalt

SCALE: 1/250
P48-140A

70
MPH

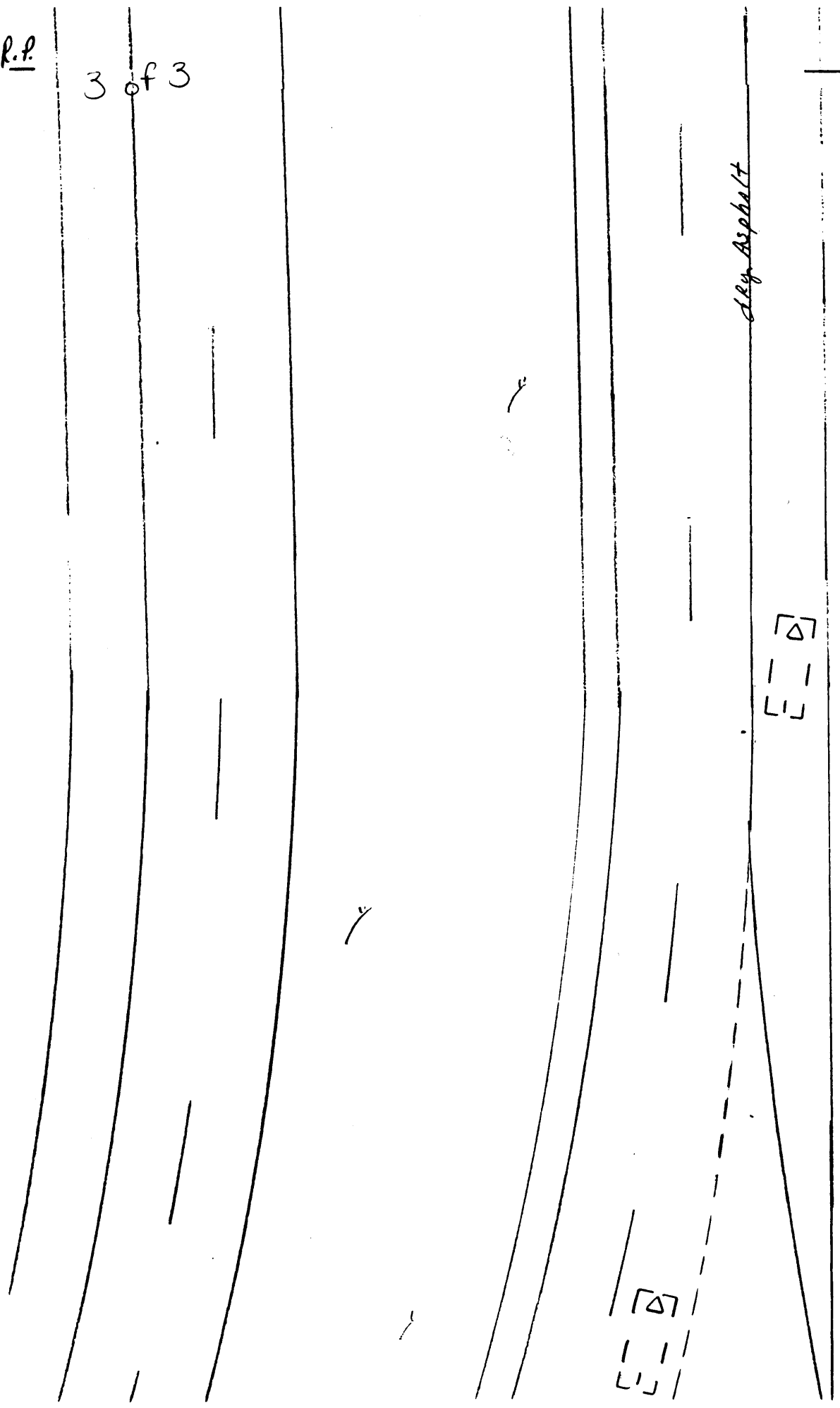



ACCIDENT COLLISION DIAGRAM

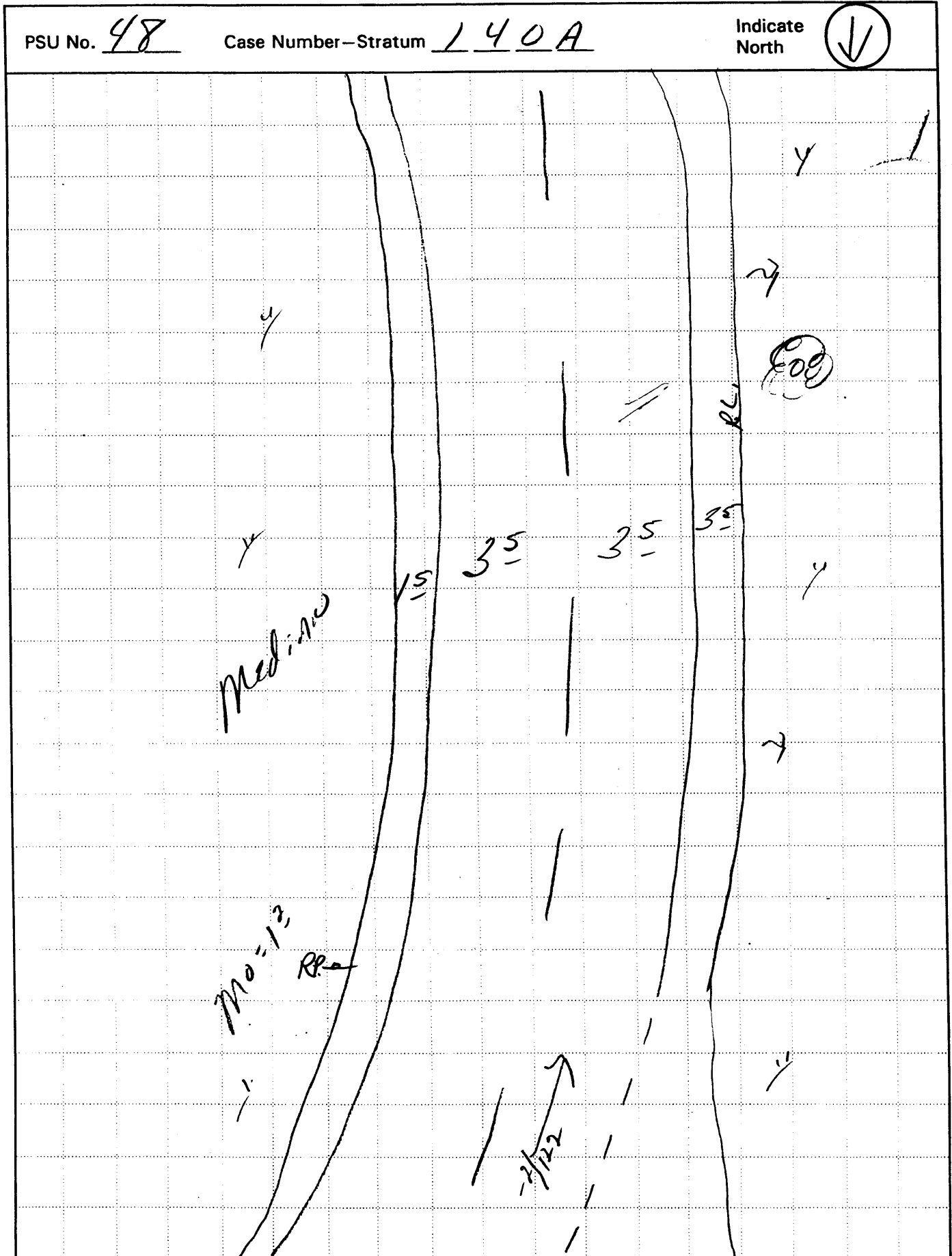



ACCIDENT COLLISION MEASUREMENT TABLE

Primary Sampling Unit Number 48

Case Number - Stratum 140A

ACCIDENT COLLISION DIAGRAM

Document the physical plant:

- all road/roadway delineation (e.g., curbs/edge lines, lane markings, median markings, pavement markings, parked vehicles, poles, signs, etc.)
- all traffic controls (e.g., signs/signals, etc.)
- north arrow placed on diagram
- roadway surface type and condition of applicable roadways
- grade measurements for all applicable roadways and at location of rollover initiation
- roadway curvature (include measurement of precrash superelevation for each vehicle if applicable)

Document vehicle dynamics including:

- reference point and reference line relative to physical features present at the scene
- scaled documentation of all accident induced physical evidence
- scaled documentation of all roadside objects contacted
- scaled representations of the vehicle(s) at pre-impact, impact, and final rest based upon either:
 - a) physical evidence, or
 - b) reconstructed accident dynamics

CRASH DATA

	VEH. #1	VEH. #2	VEH. #3
Heading Angle	<u>180</u>	---	---
Surface Type	<u>Asphalt</u>	---	---
Surface Condition	<u>dry</u>	---	---
Coefficient of Friction	<u>.60</u>	---	---
Grade (v/h) Measurement (between impact and final rest)	<u>+7/122</u>	---	---
Grade (v/h) Measurement (at location of rollover initiation)	---	---	---
Grade (v/h) Measurement (at pre-crash location)	<u>-2/122</u>	---	---

Reference Point: Exit sign
on East Road Edge

Reference line: West Road Edge
(Paved Shoulder)

Item	Distance and Direction from Reference Point	Distance and Direction from Reference Line

Over

Item	Distance and Direction from Reference Point	Distance and Direction from Reference Line
	5	W
LF tire mark beg	54	38
RF " beg	54	59
Gouge #1	10°-123	63-70
Tree #1 < (branches)	163	75
Gouge #2	30°-31°	72-73
Uplotted tree #2 >	39°	80
Ground scraping	38°-43°	75-82
Gouge #3	57°-59°	53-57
Loc. LF tire	165	43
Loc. RF tire	165	63
LR tire beg	165	40
RR tire beg	165	52
LF & RR Join	649	52
RF Ends	742	68
LF & RR Ends	722	52
LR Ends	740	52
Tree #3 <	682	72
Tree #4 <	702	79
Tree #5 > down	742	70
Tree #6 < down	751	81
Tree #7 > largest	752	64
Ground scraping	742-762	48-73
Side glass	722	68



ACCIDENT FORM

1. Primary Sampling Unit Number 48
2. Case Number - Stratum 140A

IDENTIFICATION

3. Number of General Vehicle Forms Submitted 01
4. Date of Accident (Month, Day, Year) 9 6
5. Time of Accident 0230
Code reported military time of accident.
NOTE: Midnight = 2400
Unknown = 9999

SPECIAL STUDIES - INDICATORS

Check (✓) each special study (SS15-SS18 below) that has been completed; code 1 for the checked special studies and 0 for the special studies not checked.

6. 0 SS15 Administrative Use 0
7. 0 SS16 Pedestrian Crash Data Study 0
(Data for this special study available in a separate file.)
8. 0 SS17 Impact Fires 0
9. 0 SS18 Unsafe Driver Actions 0
10. 0 SS19 Run Off Road 0

NUMBER OF EVENTS

11. Number of Recorded Events in This Accident 08
Code the number of events which occurred in this accident.

ACCIDENT EVENTS

For each event that occurred in the accident, code the lowest numbered vehicle in the left columns and the other involved vehicle or object in the right columns.

Accident Event Sequence Number	Vehicle Number	Class Of Vehicle	General Area of Damage	Vehicle Number or Object Contacted	Class Of Vehicle	General Area of Damage
12. <u>0 1</u>	13. <u>01</u>	14. <u>01</u>	15. <u>F</u>	16. <u>44</u>	17. <u>00</u>	18. <u>0</u>
19. <u>0 2</u>	20. <u>01</u>	21. <u>01</u>	22. <u>F</u>	23. <u>41</u>	24. <u>00</u>	25. <u>0</u>
26. <u>0 3</u>	27. <u>01</u>	28. <u>01</u>	29. <u>F</u>	30. <u>42</u>	31. <u>00</u>	32. <u>0</u>
33. <u>0 4</u>	34. <u>01</u>	35. <u>01</u>	36. <u>F</u>	37. <u>41</u>	38. <u>00</u>	39. <u>0</u>
40. <u>0 5</u>	41. <u>01</u>	42. <u>01</u>	43. <u>F</u>	44. <u>41</u>	45. <u>00</u>	46. <u>0</u>

IF GREATER THAN FIVE EVENTS, CONTINUE CODING ON THE ACCIDENT EVENT SUPPLEMENT

CODES FOR CLASS OF VEHICLE

- | | |
|--|---|
| (00) Not a motor vehicle
(01) Subcompact/mini (wheelbase < 254 cm)
(02) Compact (wheelbase ≥ 254 but < 265 cm)
(03) Intermediate (wheelbase ≥ 265 but < 278 cm)
(04) Full size (wheelbase ≥ 278 but < 291 cm)
(05) Largest (wheelbase ≥ 291 cm)
(09) Unknown passenger car size
(14) Compact utility vehicle
(15) Large utility vehicle (≤ 4,536 kgs GVWR)
(16) Utility station wagon (≤ 4,536 kgs GVWR)
(19) Unknown utility type
(20) Minivan (≤ 4,536 kgs GVWR)
(21) Large van (≤ 4,536 kgs GVWR)
(24) Van Based school bus (≤ 4,536 kgs GVWR)
(28) Other van type (≤ 4,536 kgs GVWR)
(29) Unknown van type (≤ 4,536 kgs GVWR)
(30) Compact pickup truck (≤ 4,536 kgs GVWR) | (31) Large pickup truck (≤ 4,536 kgs GVWR)
(38) Other pickup truck (≤ 4,536 kgs GVWR)
(39) Unknown pickup truck type (≤ 4,536 kgs GVWR)
(45) Other light truck (≤ 4,536 kgs GVWR)
(48) Unknown light truck type (≤ 4,536 kgs GVWR)
(49) Unknown light vehicle type
(50) School bus (excludes van based)(> 4,536 kgs GVWR)
(58) Other bus (> 4,536 kgs GVWR)
(59) Unknown bus type
(60) Truck (> 4,536 kgs GVWR)
(67) Tractor without trailer
(68) Tractor-trailer(s)
(78) Unknown medium/heavy truck type
(79) Unknown light/medium/heavy truck type
(80) Motored cycle
(90) Other vehicle
(99) Unknown |
|--|---|

CODES FOR GENERAL AREA OF DAMAGE (GAD)

- | | | | |
|---|--|---|---|
| CDS APPLICABLE
AND OTHER
VEHICLES | (O) Not a motor vehicle
(N) Noncollision
(F) Front | (R) Right side
(L) Left side
(B) Back | (T) Top
(U) Undercarriage
(9) Unknown |
|---|--|---|---|

- | | | | |
|-------------------------------|--|--|---|
| TDC
APPLICABLE
VEHICLES | (O) Not a motor vehicle
(N) Noncollision
(F) Front
(R) Right side | (L) Left side
(B) Back of unit with cargo area
(rear of trailer or straight truck)
(D) Back (rear of tractor) | (C) Rear of cab
(V) Front of cargo area
(T) Top
(U) Undercarriage
(9) Unknown |
|-------------------------------|--|--|---|

CODES FOR VEHICLE NUMBER OR OBJECT CONTACTED

- | | |
|---|---|
| (01-30) – Vehicle Number

Noncollision
(31) Overturn – rollover (excludes end-over-end)
(32) Rollover – end-over-end
(33) Fire or explosion
(34) Jackknife
(35) Other intraunit damage (specify):

(36) Noncollision injury
(38) Other noncollision (specify):

(39) Noncollision – details unknown

Collision With Fixed Object
(41) Tree (≤ 10 cm in diameter)
(42) Tree (> 10 cm in diameter)
(43) Shrubbery or bush
(44) Embankment
(45) Breakaway pole or post (any diameter)

Nonbreakaway Pole or Post
(50) Pole or post (≤ 10 cm in diameter)
(51) Pole or post (> 10 cm but ≤ 30 cm in diameter)
(52) Pole or post (> 30 cm in diameter)
(53) Pole or post (diameter unknown)

(54) Concrete traffic barrier
(55) Impact attenuator
(56) Other traffic barrier (includes guardrail)
(specify): _____ | (57) Fence
(58) Wall
(59) Building
(60) Ditch or culvert
(61) Ground
(62) Fire hydrant
(63) Curb
(64) Bridge
(68) Other fixed object (specify):

(69) Unknown fixed object

Collision with Nonfixed Object
(70) Passenger car, light truck, van, or other vehicle
not in-transport
(71) Medium/heavy truck or bus not in-transport
(72) Pedestrian
(73) Cyclist or cycle
(74) Other nonmotorist or conveyance

(75) Vehicle occupant
(76) Animal
(77) Train
(78) Trailer, disconnected in transport
(79) Object fell from vehicle in-transport
(88) Other nonfixed object (specify):

(89) Unknown nonfixed object

(98) Other event (specify):

(99) Unknown event or object |
|---|---|

National Accident Sampling System-Crashworthiness Data System: Accident Form

ACCIDENT EVENTS SUPPLEMENT

1. Primary Sampling Unit Number 48

2. Case Number—Stratum 140A

Accident Event Sequence Number	Vehicle Number	Class Of Vehicle	General Area of Damage	Vehicle Number or Object Contacted	Class Of Vehicle	General Area of Damage
47. <u>0 6</u>	48. <u>01</u>	49. <u>01</u>	50. <u>F</u>	51. <u>42</u>	52. <u>00</u>	53. <u>0</u>
54. <u>0 7</u>	55. <u>01</u>	56. <u>01</u>	57. <u>L</u>	58. <u>42</u>	59. <u>00</u>	60. <u>0</u>
61. <u>0 8</u>	62. <u>01</u>	63. <u>01</u>	64. <u>R</u>	65. <u>41</u>	66. <u>00</u>	67. <u>0</u>
68. <u>0 9</u>	69. _____	70. _____	71. _____	72. _____	73. _____	74. _____
75. <u>1 0</u>	76. _____	77. _____	78. _____	79. _____	80. _____	81. _____
82. <u>1 1</u>	83. _____	84. _____	85. _____	86. _____	87. _____	88. _____
89. <u>1 2</u>	90. _____	91. _____	92. _____	93. _____	94. _____	95. _____
96. <u>1 3</u>	97. _____	98. _____	99. _____	100. _____	101. _____	102. _____
103. <u>1 4</u>	104. _____	105. _____	106. _____	107. _____	108. _____	109. _____
110. <u>1 5</u>	111. _____	112. _____	113. _____	114. _____	115. _____	116. _____
117. <u>1 6</u>	118. _____	119. _____	120. _____	121. _____	122. _____	123. _____
124. <u>1 7</u>	125. _____	126. _____	127. _____	128. _____	129. _____	130. _____
131. <u>1 8</u>	132. _____	133. _____	134. _____	135. _____	136. _____	137. _____
138. <u>1 9</u>	139. _____	140. _____	141. _____	142. _____	143. _____	144. _____
145. <u>2 0</u>	146. _____	147. _____	148. _____	149. _____	150. _____	151. _____



GENERAL VEHICLE FORM

1. Primary Sampling Unit Number 48
 2. Case Number - Stratum 140A
 3. Vehicle Number 01

12. Speed Limit 113
 (000) No statutory limit
 Code posted or statutory speed limit in kmph
 (999) Unknown
70 mph X 1.6093 = 112.6 kmph

VEHICLE IDENTIFICATION

4. Vehicle Model Year 46
 Code the last two digits of the model year
 (99) Unknown
 5. Vehicle Make (specify): 49
Toyota
 Applicable codes are found in your
 NASS Data Collection, Coding and
 Editing Manual.
 (99) Unknown
 6. Vehicle Model (specify): 032
Corolla
 Applicable codes are found in your
 NASS Data Collection, Coding and
 Editing Manual.
 (999) Unknown

13. Police Reported Alcohol Presence For Driver 0
 (0) No alcohol present
 (1) Yes alcohol present
 (7) Not reported
 (8) No driver present
 (9) Unknown

14. Alcohol Test Result For Driver 96
 Code actual value (decimal implied
 before first digit—0.xx)
 (95) Test refused
 (96) None given
 (97) AC test performed, results unknown
 (98) No driver present
 (99) Unknown

Source: PAR

7. Body Type 04
 Note: Applicable codes may be found on
 the back of this page.
 8. Vehicle Identification Number
1NXBA02E3TZ 
 1 2 3 4 5 6 7 8 9 10 11 12 13 14 15 16 17
 Left justify; Slash zeros and letter Z (0 and Z)
 No VIN—Code all zeros
 Unknown—Code all nines

15. Police Reported Other Drug Presence For Driver 0
 (0) No other drug(s) present
 (1) Yes other drug(s) present
 (7) Not reported
 (8) No driver present
 (9) Unknown

9. Vehicle Special Use (This Trip) 0
 (0) No special use
 (1) Taxi
 (2) Vehicle used as school bus
 (3) Vehicle used as other bus
 (4) Military
 (5) Police
 (6) Ambulance
 (7) Fire truck or car
 (8) Other (specify): _____
 (9) Unknown

16. Other Drug Specimen Test Result For Driver 0
 (0) No specimen test given
 (1) Drug(s) not found in specimen
 (2) Drug(s) found in specimen, (specify): _____
 (3) Specimen test given, results unknown or not
 obtained
 (8) No driver present
 (9) Unknown if specimen test given

17. Driver's Zip Code 
 (00001) Driver not a resident of U.S. or territories
 _____ Code actual 5-digit zip code
 (99998) No driver present
 (99999) Unknown

OFFICIAL RECORDS

10. Police Reported Vehicle Disposition 1
 (0) Not towed due to vehicle damage
 (1) Towed due to vehicle damage
 (9) Unknown
 11. Police Reported Travel Speed 113
 Code to the nearest kmph (NOTE: 000 means
 less than 0.5 kmph)
 (160) 159.5 kmph and above
 (999) Unknown
70 mph X 1.6093 = 112.6 kmph

18. Driver's Race/Ethnic Origin 2
 (1) White (non-Hispanic)
 (2) Black (non-Hispanic)
 (3) White (Hispanic)
 (4) Black (Hispanic)
 (5) American Indian, Eskimo or Aleut
 (6) Asian or Pacific Islander
 (7) Other (specify): _____
 (8) No driver present
 (9) Unknown

CODES FOR BODY TYPE

CDS APPLICABLE VEHICLES

Automobiles

- (01) Convertible (excludes sun-roof, t-bar)
- (02) 2-door sedan, hardtop, coupe
- (03) 3-door/2-door hatchback
- (04) 4-door sedan, hardtop
- (05) 5-door/4-door hatchback
- (06) Station wagon (excluding van and truck based)
- (07) Hatchback, number of doors unknown
- (08) Other automobile type (specify): _____
- (09) Unknown automobile type

Automobile Derivatives

- (10) Auto based pickup (includes El Camino, Caballero, Ranchero, Brat, and Rabbit pickup)
- (11) Auto based panel (cargo station wagon, auto based ambulance/hearse)
- (12) Large limousine - more than four side doors or stretched chassis
- (13) Three-wheel automobile or automobile derivative

Utility Vehicles ($\leq 4,536$ kgs GVWR)

- (14) Compact utility (Jeep CJ-2 - CJ-7, Scrambler, Golden Eagle, Renegade, Laredo, Wrangler, Cherokee [84 and after], Dispatcher, Raider, Bronco II, Bronco [76 and before], Explorer, S-10 Blazer, Geo Tracker, Bravada, S-15 Jimmy, Thing, Pathfinder, Trooper, Trooper II, Rodeo, Amigo, Navajo, 4-Runner, Montero, Passport, Samurai, Sidekick, Rocky)
- (15) Large utility (includes Jeep Cherokee [83 and before], Ramcharger, Trailduster, Bronco-fullsize [78 and after], fullsize Blazer, fullsize Jimmy, Hummer, Landcruiser, Rover, Scout, Yukon)
- (16) Utility station wagon (Chevy Suburban, GMC Suburban, Travelall, Grand Wagoneer, includes suburban limousine)
- (19) Utility, unknown body type

Van Based Light Trucks ($\leq 4,536$ kgs GVWR)

- (20) Minivan (Town and Country, Caravan, Grand Caravan, Voyager, Grand Voyager, Mini-Ram, Vista, Aerostar, Windstar, Villager, Lumina APV, Trans Sport, Silhouette, Astro, Safari, Toyota Van, Toyota Minivan, Previa, Nissan Minivan, Quest, Mitsubishi Minivan, Expo Wagon, Vanagon/Camper.)
- (21) Large van (B150-B350, Sportsman, Royal, Maxiwagon, Ram, Tradesman, Voyager [83 and before], E150-E350, Econoline, Clubwagon, Chateau, G10-G30, Chevy Van, Beauville, Sport Van, G15-G35, Rally Van, Vandura.)
- (22) Step van or walk-in van ($\leq 4,536$ kgs GVWR)
- (23) Van based motorhome ($\leq 4,536$ kgs GVWR)
- (24) Van based school bus ($\leq 4,536$ kgs GVWR)
- (25) Van based other bus ($\leq 4,536$ kgs GVWR)
- (28) Other van type (Hi-Cube Van, Kary) (specify): _____
- (29) Unknown van type

Light Conventional Trucks (Pickup style cab, $\leq 4,536$ kgs GVWR)

- (30) Compact pickup (D50, Colt P/U, Ram 50, Dakota, Arrow Pickup [foreign], Ranger, Courier, S-10, T-10, LUV, S-15, T-15, Sonoma, Datsun/Nissan Pickup, P'up, Mazda Pickup, Toyota Pickup, Mitsubishi Pickup)
- (31) Large Pickup (Jeep Pickup, Comanche, Ram Pickup, D100-D350, W100-W350, F100-F350, C10-C35, K10-K35, R10-R35, V10-V35, Silverado, Sierra, R100-R500, T100)
- (32) Pickup with slide-in camper
- (33) Convertible pickup
- (39) Unknown pickup style light conventional truck type

Other Light Trucks ($\leq 4,536$ kgs GVWR)

- (40) Cab chassis based (includes rescue vehicles, light stake, dump, and tow truck)
- (41) Truck based panel
- (42) Light truck based motorhome (chassis mounted)
- (45) Other light conventional truck type
- (48) Unknown light truck type
- (49) Unknown light vehicle type (automobile, utility, van, or light truck)

OTHER VEHICLES

Buses (Excludes Van Based)

- (50) School bus (designed to carry students, not cross country or transit)
- (58) Other bus type (e.g., transit, intercity, bus based motorhome) (specify): _____
- (59) Unknown bus type

Medium/Heavy Trucks ($> 4,536$ kgs GVWR)

- (60) Step van ($> 4,536$ kgs GVWR)
- (61) Single unit straight truck ($4,536$ kgs $<$ GVWR $\leq 8,845$ kgs)
- (62) Single unit straight truck ($8,845$ kgs $<$ GVWR $\leq 11,793$ kgs)
- (63) Single unit straight truck ($> 11,793$ kgs GVWR)
- (64) Single unit straight truck, GVWR unknown
- (65) Medium/heavy truck based motorhome
- (67) Truck-tractor with no cargo trailer
- (68) Truck-tractor pulling one trailer
- (69) Truck-tractor pulling two or more trailers
- (70) Truck-tractor (unknown if pulling trailer)
- (78) Unknown medium/heavy truck type
- (79) Unknown truck type (light/medium/heavy)

Motored Cycles (Does Not Include All-Terrain Vehicles/Cycles)

- (80) Motorcycle
- (81) Moped (motorized bicycle)
- (82) Three-wheel motorcycle or moped
- (88) Other motored cycle (minibike, motorscooter) (specify): _____
- (89) Unknown motored cycle type

Other Vehicles

- (90) ATV (All-Terrain Vehicle) and ATC (All-Terrain Cycle)
- (91) Snowmobile
- (92) Farm equipment other than trucks
- (93) Construction equipment other than trucks
- (97) Other vehicle type
- (99) Unknown body type

PRECRASH ENVIRONMENTAL DATA

<p>19. Relation To Interchange Or Junction <u>0</u></p> <p>(0) Non-interchange area and non-junction (1) Interchange area related</p> <p><i>Non-Interchange junctions</i></p> <p>(2) Intersection related (3) Driveway, alley access related (4) Other junction (specify) _____</p> <p>(5) _____ Unknown type of junction</p> <p>(9) Unknown</p>	<p>25. Roadway Surface Condition <u>1</u></p> <p>(1) Dry (2) Wet (3) Snow or slush (4) Ice (5) Sand, dirt, or oil (8) Other (specify): _____ (9) Unknown</p>
<p>20. Trafficway Flow <u>1</u></p> <p>(0) Not physically divided (two way traffic) (1) Divided trafficway-median strip without positive barrier (2) Divided trafficway-median strip with positive barrier (3) One way traffic (9) Unknown</p>	<p>26. Light Conditions <u>2</u></p> <p>(1) Daylight (2) Dark (3) Dark, but lighted (4) Dawn (5) Dusk (9) Unknown</p>
<p>21. Number Of Travel Lanes <u>2</u></p> <p>(1) One (2) Two (3) Three (4) Four (5) Five (6) Six (7) Seven or more (9) Unknown</p>	<p>27. Atmospheric Conditions <u>0</u></p> <p>(0) No adverse atmospheric-related driving conditions (1) Rain (2) Sleet/hail (3) Snow (4) Fog (5) Rain and fog (6) Sleet and fog (7) Other (e.g., smog, smoke, blowing sand or dust, etc.) (specify): _____ (9) Unknown</p>
<p>22. Roadway Alignment <u>3</u></p> <p>(1) Straight (2) Curve right (3) Curve left (9) Unknown</p>	<p>28. Traffic Control Device <u>0</u></p> <p>(0) No traffic control(s) (1) Traffic control signal (not RR crossing)</p> <p><i>Regulatory</i></p> <p>(2) Stop sign (3) Yield sign (4) School zone sign (5) Other regulatory sign (specify): _____</p>
<p>23. Roadway Profile <u>1</u></p> <p>(1) Level (2) Uphill grade (> 2%) (3) Hill crest (4) Downhill grade (> 2%) (5) Sag (9) Unknown</p>	<p>(6) Warning sign (not RR crossing) (7) Unknown sign (8) Miscellaneous/other controls including RR controls (specify): _____ (9) Unknown</p>
<p>24. Roadway Surface Type <u>2</u></p> <p>(1) Concrete (2) Bituminous (asphalt) (3) Brick or block (4) Slag, gravel, or stone (5) Dirt (8) Other (specify): _____ (9) Unknown</p>	<p>29. Traffic Control Device Functioning <u>0</u></p> <p>(0) No traffic control device (1) Traffic control device not functioning (specify): _____ (2) Traffic control device functioning properly (9) Unknown</p>

PRECRASH DRIVER RELATED DATA

30. Driver's Distraction/Inattention To Driving 99
(Prior To Recognition Of Critical Event)
- (00) No driver present
(01) Attentive or not distracted
(02) Looked but did not see
- Distractions*
- (03) By other occupant(s), (specify): _____
- (04) By moving object in vehicle (specify): _____
- (05) While talking or listening to cellular phone (specify location and type of phone): _____
- (06) While dialing cellular phone (specify location and type of phone): _____
- (07) While adjusting climate controls
(08) While adjusting radio, cassette, CD (specify): _____
- (09) While using other device/controls integral to vehicle (specify): _____
- (10) While using or reaching for device/object brought into vehicle (specify): _____
- (11) Sleepy or fell asleep
(12) Distracted by outside person, object, or event (specify): _____
- (13) Eating or drinking
(14) Smoking related
(97) Distracted/inattentive, details unknown
(98) Other, distraction (specify): _____
- (99) Unknown
31. Pre-Event Movement (Prior to Recognition of Critical Event) 14
- (00) No driver present
(01) Going straight
(02) Decelerating in traffic lane
(03) Accelerating in traffic lane
(04) Starting in traffic lane
(05) Stopped in traffic lane
(06) Passing or overtaking another vehicle
(07) Disabled or parked in travel lane
(08) Leaving a parking position
(09) Entering a parking position
(10) Turning right
(11) Turning left
(12) Making a U-turn
(13) Backing up (other than for parking position)
(14) Negotiating a curve
(15) Changing lanes
(16) Merging
(17) Successful avoidance maneuver to a previous critical event
(97) Other (specify): _____
(99) Unknown
32. Critical Precrash Event 13
- THIS VEHICLE LOSS OF CONTROL DUE TO:**
- (01) Blow out or flat tire
(02) Stalled engine
(03) Disabling vehicle failure (e.g., wheel fell off) (specify): _____
- (04) Non-disabling vehicle problem (e.g., hood flew up) (specify): _____
- (05) Poor road conditions (puddle, pot hole, ice, etc.) (specify): _____
- (06) Traveling too fast for conditions
(08) Other cause of control loss (specify): _____
- (09) Unknown cause of control loss

THIS VEHICLE TRAVELLING

- (10) Over the lane line on left side of travel lane
(11) Over the lane line on right side of travel lane
(12) Off the edge of the road on the left side
(13) Off the edge of the road on the right side
(14) End departure
(15) Turning left at intersection
(16) Turning right at intersection
(17) Crossing over (passing through) intersection
(18) This vehicle decelerating
(19) Unknown travel direction

OTHER MOTOR VEHICLE IN LANE

- (50) Other vehicle stopped
(51) Traveling in same direction with lower steady speed
(52) Traveling in same direction while decelerating
(53) Traveling in same direction with higher speed
(54) Traveling in opposite direction
(55) In crossover
(56) Backing
(59) Unknown travel direction of other motor vehicle in lane

OTHER MOTOR VEHICLE ENCROACHING INTO LANE

- (60) From adjacent lane (same direction)—over left lane line
(61) From adjacent lane (same direction)—over right lane line
(62) From opposite direction—over left lane line
(63) From opposite direction—over right lane line
(64) From parking lane
(65) From crossing street, turning into same direction
(66) From crossing street, across path
(67) From crossing street, turning into opposite direction
(68) From crossing street, intended path not known
(70) From driveway, turning into same direction
(71) From driveway, across path
(72) From driveway, turning into opposite direction
(73) From driveway, intended path not known
(74) From entrance to limited access highway
(78) Encroachment by other vehicle—details unknown

PEDESTRIAN, PEDALCYCLIST, OR OTHER NONMOTORIST

- (80) Pedestrian in roadway
(81) Pedestrian approaching roadway
(82) Pedestrian—unknown location
(83) Pedalcyclist or other nonmotorist in roadway (specify): _____
- (84) Pedalcyclist or other nonmotorist approaching roadway, (specify): _____
- (85) Pedalcyclist or other nonmotorist—unknown location (specify): _____

OBJECT OR ANIMAL

- (87) Animal in roadway
(88) Animal approaching roadway
(89) Animal—unknown location
(90) Object in roadway
(91) Object approaching roadway
(92) Object—unknown location
(98) Other critical precrash event (specify): _____
- (99) Unknown

33. Attempted Avoidance Maneuver 99

- (00) No driver present
- (01) No avoidance maneuver
- (02) Braking (no lockup)
- (03) Braking (lockup)
- (04) Braking (lockup unknown)
- (05) Releasing brakes
- (06) Steering left
- (07) Steering right
- (08) Braking and steering left
- (09) Braking and steering right
- (10) Accelerating
- (11) Accelerating and steering left
- (12) Accelerating and steering right
- (98) Other action (specify):

(99) Unknown

34. Pre-Impact Stability 1

- (0) No driver present
- (1) Tracking
- (2) Skidding longitudinally—rotation less than 30 degrees
- (3) Skidding laterally—clockwise rotation
- (4) Skidding laterally—counterclockwise rotation
- (7) Other vehicle loss-of-control (specify):

(9) Pre-crash stability unknown

35. Pre-Impact Location 4

- (0) No driver present
- (1) Stayed in original travel lane
- (2) Stayed on roadway but left original travel lane
- (3) Stayed on roadway, not known if left original travel lane
- (4) Departed roadway
- (5) Remained off roadway
- (6) Returned to roadway
- (7) Entered roadway
- (9) Unknown

36. Accident Type 01

(Note: Applicable codes on back of this page)

(00) No impact

Code the number of the diagram that best describes the accident circumstance

(98) Other accident type (specify):

(99) Unknown

STOP HERE IF GV07 DOES NOT EQUAL 01 - 49

Category	Configuration	ACCIDENT TYPES (Includes Intent)						
I. Single Driver	A. Right Roadside Departure	01 DRIVE OFF ROAD	02 CONTROL/ TRACTION LOSS	03 AVOID COLLISION WITH VEH., PED., ANIM.	04 SPECIFICS OTHER	05 SPECIFICS UNKNOWN		
	B. Left Roadside Departure	06 DRIVE OFF ROAD	07 CONTROL/ TRACTION LOSS	08 AVOID COLLISION WITH VEH., PED., ANIM.	09 SPECIFICS OTHER	10 SPECIFICS UNKNOWN		
	C. Forward Impact	11 PARKED VEH.	12 STA. OBJECT	13 PEDESTRIAN/ ANIMAL	14 END DEPARTURE	15 SPECIFICS OTHER	16 SPECIFICS UNKNOWN	
II Same Trafficway Same Direction	D. Rear-End	20 STOPPED 21, 22, 23	22 SLOWER 25, 26, 27	24 DECCEL. 29, 30, 31	26 AVOID COLLISION WITH VEH.	28 AVOID COLLISION WITH OBJECT	(EACH • 32) SPECIFICS OTHER	(EACH • 33) SPECIFICS UNKNOWN
	E. Forward Impact	34 CONTROL/ TRACTION LOSS	36 CONTROL/ TRACTION LOSS	38 AVOID COLLISION WITH VEH.	40 AVOID COLLISION WITH OBJECT	(EACH • 42) SPECIFICS OTHER	(EACH • 43) SPECIFICS UNKNOWN	
	F. Sideswipe Angle	44 45	46 45 47	(EACH • 48) SPECIFICS OTHER	(EACH • 49) SPECIFICS UNKNOWN			
III Same Trafficway Opposite Direction	G. Head-On	50 LATERAL MOVE	51 (EACH • 52) SPECIFICS OTHER	(EACH • 53) SPECIFICS UNKNOWN				
	H. Forward Impact	54 CONTROL/ TRACTION LOSS	56 CONTROL/ TRACTION LOSS	58 AVOID COLLISION WITH VEH.	60 AVOID COLLISION WITH OBJECT	(EACH • 62) SPECIFICS OTHER	(EACH • 63) SPECIFICS UNKNOWN	
	I. Sideswipe Angle	64 LATERAL MOVE	65 (EACH • 66) SPECIFICS OTHER	(EACH • 67) SPECIFICS UNKNOWN				
IV. Change Trafficway Vehicle Turning	J. Turn Across Path	68 INITIAL OPPOSITE DIRECTIONS	71 INITIAL SAME DIRECTIONS	73 72	(EACH • 74) SPECIFICS OTHER	(EACH • 75) SPECIFICS UNKNOWN		
	K. Turn Into Path	77 76	79 78	81 80	83 82	(EACH • 84) SPECIFICS OTHER	(EACH • 85) SPECIFICS UNKNOWN	
V. Intersecting Paths (Vehicle Damage)	L. Straight Paths	87 86	88 89	(EACH • 90) SPECIFICS OTHER	(EACH • 91) SPECIFICS UNKNOWN			
VI. Miscellaneous	M. Backing Etc.	92 BACKING VEH.	93 OTHER VEH. OR OBJECT	98 Other Accident Type	99 Unknown Accident Type	00 No Impact		

OCCUPANT RELATED

37. Driver Presence in Vehicle 1
 (0) Driver not present
 (1) Driver present
 (9) Unknown
38. Number of Occupants This Vehicle 01
 (00-96) Code actual number of occupants for this vehicle
 (97) 97 or more
 (99) Unknown
39. Number of Occupant Forms Submitted 01

AIR BAG RELATED

40. Is this an AOPS Vehicle? 1
 (0) No (includes unknown)
 (1) Yes - researcher determined
 (2) VIN determined air bag system
 (3) VIN determined automatic (passive) belts
 (4) VIN determined air bag and automatic (passive) belts
41. Air Bag(s) Deployment, First Seat Frontal 6
 (0) Not equipped or not available
 (1) No air bags deployed
Single Air Bag Vehicle
 (2) Driver air bag deployed
 (3) Driver air bag, unknown if deployed
Multiple Air Bag Vehicle
 (4) Driver side only deployed
 (5) Passenger side only deployed
 (6) Driver and passenger side deployed
 (7) Driver and passenger side unknown if deployed
 (8) Air bag(s) deployed, details unknown
 (9) Unknown
42. Air Bag(s) Deployment, Other Than First Seat Frontal 0
 (0) Not equipped with an "other" air bag
 (1) Deployed during accident (as a result of impact)
 (2) Deployed inadvertently just prior to accident
 (3) Deployed, details unknown
 (4) Deployed as a result of a noncollision event during accident sequence (e.g., fire, explosion, electrical)
 (5) Unknown if deployed
 (7) Nondeployed
 (9) Unknown
- Specify type of "other" air bag present: _____

VEHICLE WEIGHT ITEMS

43. Vehicle Curb Weight 1,050
 Code weight to nearest 10 kilograms.
 (045) Less than 454 kilograms
 (612) 6,124 kilograms or more
 (999) Unknown
2,315 lbs X .4536 = 1,050 kgs
 Source: _____

44. Vehicle Cargo Weight 0,010
 Code weight to nearest 10 kilograms.
 (000) Less than 5 kilograms
 (454) 4,536 kilograms or more
 (999) Unknown
25 lbs X .4536 = 11.3 kgs
 Source: _____

ROLLOVER DATA

45. Rollover 00
 (00) No rollover (no overturning)
Rollover (primarily about the longitudinal axis)
 (01-16) Code the number of quarter turns Rollover, 17 or more quarter turns (specify): _____
 (17) Rollover, 17 or more quarter turns (specify): _____
 (98) Rollover--end-over-end (i.e., primarily about the lateral axis)
 (99) Rollover (overturn), details unknown
46. Rollover Initiation Type 00
 (00) No rollover
 (01) Trip-over
 (02) Flip-over
 (03) Turn-over
 (04) Climb-over
 (05) Fall-over
 (06) Bounce-over
 (07) Collision with another vehicle
 (08) Other rollover initiation type specify): _____
 (98) Rollover--end-over-end
 (99) Unknown rollover initiation type
47. Location of Rollover Initiation 0
 (0) No rollover
 (1) On roadway
 (2) On shoulder--paved
 (3) On shoulder--unpaved
 (4) On roadside or divided trafficway median
 (8) Rollover--end-over-end
 (9) Unknown
48. Rollover Initiation Object Contacted 00
 (Note: Applicable codes on back of page)
49. Location on Vehicle Where Initial Principal Tripping Force Is Applied 0
 (0) No rollover
 (1) Wheels/tires
 (2) Side plane
 (3) End plane
 (4) Undercarriage
 (5) Other location on vehicle (specify): _____
 (6) Non-contact rollover forces (specify): _____
 (8) Rollover--end-over-end
 (9) Unknown
50. Direction of Initial Roll 0
 (0) No rollover
 (1) Roll right - primarily about the longitudinal axis
 (2) Roll left - primarily about the longitudinal axis
 (8) Rollover--end-over-end
 (9) Unknown roll direction

CODES FOR ROLLOVER INITIATION OBJECT CONTACTED

- (00) No rollover
- (01-30) — Vehicle Number

Noncollision

- (31) Turn-over — fall-over
- (32) No rollover impact initiation (end-over-end)
- (34) Jackknife

Collision With Fixed Object

- (41) Tree (\leq 10 cm in diameter)
- (42) Tree ($>$ 10 cm in diameter)
- (43) Shrubbery or bush
- (44) Embankment

- (45) Breakaway pole or post (any diameter)

Nonbreakaway Pole or Post

- (50) Pole or post (\leq 10 cm in diameter)
- (51) Pole or post ($>$ 10 cm but \leq 30 cm in diameter)
- (52) Pole or post ($>$ 30 cm in diameter)
- (53) Pole or post (diameter unknown)

- (54) Concrete traffic barrier
- (55) Impact attenuator
- (56) Other traffic barrier (includes guardrail)
(specify): _____

- (57) Fence
- (58) Wall
- (59) Building
- (60) Ditch or culvert
- (61) Ground
- (62) Fire hydrant
- (63) Curb
- (64) Bridge
- (68) Other fixed object (specify): _____

- (69) Unknown fixed object _____

Collision with Nonfixed Object

- (70) Passenger car, light truck, van, or other vehicle not in-transport
- (71) Medium/heavy truck or bus not in-transport
- (76) Animal
- (77) Train
- (78) Trailer, disconnected in transport
- (79) Object fell from vehicle in-transport
- (88) Other nonfixed object (specify): _____

- (89) Unknown nonfixed object _____

- (98) Other event (specify): _____

- (99) Unknown event or object _____

VERRIDE/UNDERRIDE (THIS VEHICLE)

ACCIDENT RECONSTRUCTION PROGRAMS
HIGHEST DELTA V

- 51. Front Override/Underride (this Vehicle) 0
- 52. Rear Override/Underride (this Vehicle) 0
 - (0) No override/underride, or not an end-to-end impact between two CDS applicable vehicles, and no medium/heavy truck or bus underride
 - Override (see specific CDC)*
[Between 2 CDS applicable vehicles (Bodytype, GV07 = 1-49)]
 - (1) 1st CDC
 - (2) 2nd CDC
 - (3) Other not automated CDC (specify):

 - Underride (see specific CDC)*
[Between 2 CDS applicable vehicles (Bodytype, GV07 = 1-49)]
 - (4) 1st CDC
 - (5) 2nd CDC
 - (6) Other not automated CDC (specify):

 - (7) Medium/heavy truck or bus override (of any configuration)
 - (9) Unknown

- 58. Basis for Total (Resultant) Delta V (highest) 01
 - (00) No vehicle inspection
 - Delta V Calculated*
 - (01) Reconstruction program-damage only routine
 - (02) Reconstruction program-damage and trajectory routine
 - (03) Missing vehicle algorithm
 - Delta V Not Calculated*
 - (04) At least one vehicle (which may be this vehicle) is beyond the scope of an acceptable reconstruction program, regardless of collision conditions.

All vehicles within scope (CDC applicable) of reconstruction program but one of the collision conditions is beyond the scope of the reconstruction program or other acceptable reconstruction technique, regardless of adequacy of damage data.

HEADING ANGLE AT IMPACT FOR HIGHEST DELTA V

Values: (000)-(359) Code actual value
(996) Non-horizontal impact
(997) Noncollision
(998) Impact with object
(999) Unknown

- 53. Heading Angle For This Vehicle 998
- 54. Heading Angle For Other Vehicle 998

- (05) Rollover
- (06) Other non-horizontal forces
- (07) Sideswipe type damage
- (08) Severe override
- (09) Yielding object
- (10) Overlapping damage
- (11) All vehicle and collision conditions are within scope of one of the acceptable reconstruction programs, but there is insufficient data available, (specify):

RECONSTRUCTION DATA

- 55. Towed Trailing Unit 0
 - (0) No towed unit
 - (1) Yes—towed trailing unit
 - (9) Unknown
- 56. Documentation of Trajectory Data for This Vehicle 1
 - (0) No
 - (1) Yes
- 57. Post Collision Condition of Tree or Pole (For Highest Delta V) 1
 - (0) Not collision (for highest delta V) with tree or pole
 - (1) Not damaged
 - (2) Cracked/sheared
 - (3) Tilted < 45 degrees
 - (4) Tilted ≥ 45 degrees
 - (5) Uprooted tree
 - (6) Separated pole from base
 - (7) Pole replaced
 - (8) Other (specify):

 - (9) Unknown

(98) Other, (specify): _____

COMPUTER GENERATED CRASH SEVERITY

59. Total Delta V Highest 056

56 Nearest kmph (highest)

999 Nearest kmph (secondary)

(NOTE: 000 means less than 0.5 kmph)
(160) 159.5 kmph and above
(999) Unknown

63. Impact Speed Highest 998

998 Nearest kmph (highest)

999 Nearest kmph (secondary)

(NOTE: 000 means less than 0.5 kmph)
(160) 159.5 kmph and above
(998) Trajectory algorithm not run
(999) Unknown

60. Longitudinal Component of Delta V Highest +0049

-49 Nearest kmph (highest)

999 Nearest kmph (secondary)

(NOTE: 000 means greater than -0.5 kmph and less than +0.5 kmph)
(±160) ±159.5 kmph and above
(999) Unknown

61. Lateral Component of Delta V Highest ⊕ -028

28 Nearest kmph (highest)

999 Nearest kmph (secondary)

(NOTE: 000 means greater than -0.5 kmph and less than +0.5 kmph)
(±160) ±159.5 kmph and above
(999) Unknown

62. Energy Absorption Highest 143.400

143382 Nearest 100 joules (highest)

999 Nearest 100 joules (secondary)

(NOTE: 0000 means less than 50 joules)
(9997) 999,650 joules or more
(9999) Unknown

DELTA V CONFIDENCE LEVEL

64. Confidence In Reconstruction Program Results (For Highest Delta V) 4 X

- (0) No reconstruction
(1) Collision fits model - results appear reasonable
(2) Collision fits model - results appear high
(3) Collision fits model - results appear low
(4) Borderline reconstruction - results appear reasonable

OTHER SPEED ESTIMATE

65. Barrier Equivalent Speed Highest 056

56.2 Nearest kmph (highest)

999 Nearest kmph (secondary)

(NOTE: 000 means less than 0.5 kmph)
(160) 159.5 kmph and above
(999) Unknown

ESTIMATED DELTA V	INSPECTION TYPE
<p>66. Estimated Highest Delta V (Researcher Determined) 0</p> <p>(0) Reconstruction Delta V coded</p> <p><i>Estimated Delta V</i></p> <p>(1) Less than 10 kmph (2) ≥ 10 kmph but < 25 kmph (3) ≥ 25 kmph but < 40 kmph (4) ≥ 40 kmph but < 55 kmph (5) ≥ 55 kmph</p> <p><i>Other estimates of damage severity</i></p> <p>(6) Minor (7) Moderate (8) Severe</p> <p>(9) Unknown</p>	<p>67. Type of Vehicle Inspection 3</p> <p>(0) No inspection (1) Vehicle fully repaired-no damage evident (2) Partial inspection (specify): _____ (3) Complete inspection</p> <hr/> <p style="text-align: center;">DELTA V EVENT NUMBER</p> <p>68. Delta V Event Number 07</p> <p>_____ Code the accident event sequence number that resulted in the Delta V that has been coded above for this vehicle</p> <p>(99) Unknown</p>

*** IF THE CDS APPLICABLE VEHICLE WAS NOT INSPECTED (I.E., GV67 = 0), ***

DO NOT COMPLETE THE EXTERIOR AND INTERIOR VEHICLE FORMS

*** IF GV07 DOES NOT EQUAL 01-49, DO NOT COMPLETE ***

THE EXTERIOR VEHICLE, INTERIOR VEHICLE,
 OCCUPANT ASSESSMENT, AND OCCUPANT INJURY FORMS.



EXTERIOR VEHICLE FORM

1. Primary Sampling Unit Number <u>48</u>	3. Vehicle Number <u>01</u>
2. Case Number - Stratum <u>140A</u>	

VEHICLE IDENTIFICATION

VIN 1NXBA02E3T2 XXXXXXXXXX Model Year 96
 Vehicle Make (specify): Toyota Vehicle Model (specify): Corolla

LOCATOR

Locate the end of the damage with respect to the vehicle's damaged center point or bumper corner for end impacts or an undamaged axle for side impacts.

Specific Impact No.	Location of Direct Damage	Location of Field L	Location of Max Crush
01-06	Entire front bumper	Entire front bumper	C1
07	Ends 122 forward LR axle	Ends 127 forward LR axle	C3
08	Ends 24cm forward RF axle		

CRUSH PROFILE IN CENTIMETERS

NOTES: Identify the plane at which the C-measurements are taken (e.g., at bumper, above bumper, at sill, above sill, etc.) and label adjustments (e.g., free space).

Measure C1 to C6 from driver to passenger side in front or rear impacts and rear to front in side impacts.

210 when measured on right undamaged side

Free space value is defined as the distance between the baseline and the original body contour taken at the individual C locations. This may include the following: bumper lead, bumper taper, side protrusion, side taper, etc. Record the value for each C-measurement and maximum crush.

Use as many lines/columns as necessary to describe each damage profile.

Specific Impact Number	Plane of Impact C-Measurements	Direct Damage		Field L	C ₁	C ₂	C ₃	C ₄	C ₅	C ₆	±D
		Width (CDC)	Max Crush								
01-06	front bumper	95	106	62	106	68	47	29	14	4	
	COVER Adj.		-1		-1	-1	-1	-1	-1	-1	
	S/L Adj.		+27		+27	127	127	127	127	+27	
	Free space		-7		-7	-2	0	0	-2	-7	
	Actual crush	95	125	62	125	92	73	55	40	23	
07	left side	92	78	87	61	74	77	76	67	24	
	Free space		-5		-5	-5	-5	-5	-5	-5	
	Actual crush	92	73	87	56	69	73	71	62	19	+110.5
08	rights side	7	2	No C's taken due to shift to right front quarter panel							

Front bumper cover scrapped
 CW locks in salvage yard.
 Resealable closure of direct panel protruding
 C's taken high due to door panel protruding

LF pulled around
 from left side impact
 NOT actually crush

ORIGINAL SPECIFICATIONS WORK SHEET

Wheelbase	<u>97.0</u>	inches	x	2.54	=	<u>246.3</u>	cm
Overall Length	<u>172.0</u>	inches	x	2.54	=	<u>436.8</u>	cm
Maximum Width	<u>66.3</u>	inches	x	2.54	=	<u>168.4</u>	cm
Curb Weight	<u>2,315</u>	pounds	x	.4536	=	<u>1,050.0</u>	kg
Average Track	<u>57.3</u>	inches	x	2.54	=	<u>145.5</u>	cm
Front Overhang	_____	inches	x	2.54	=	_____	cm
Rear Overhang	_____	inches	x	2.54	=	_____	cm
Undeformed End Width	_____	inches	x	2.54	=	_____	cm
Engine Size: cyl./displ.	_____	cc	x	.001	=	_____	L
	_____	CID	x	.0164	=	_____	L

4 cyl. 1.4

VEHICLE DAMAGE SKETCH

<p>TIRE - WHEEL DAMAGE</p> <p>a. Rotation physically restricted</p> <p>RF <u>2</u> LF <u>1</u> RR <u>2</u> LR <u>2</u></p> <p>b. Tire deflated</p> <p>RF <u>1</u> LF <u>1</u> RR <u>2</u> LR <u>2</u></p> <p>(1) Yes (2) No (8) NA (9) Unk.</p>	<p>ORIGINAL SPECIFICATIONS</p> <p>Wheelbase <u>246</u> cm</p> <p>Overall Length <u>437</u> cm</p> <p>Maximum Width <u>168</u> cm</p> <p>Curb Weight <u>1050</u> kg</p> <p>Average Track <u>146</u> cm</p> <p>Front Overhang <u>88</u> cm</p> <p>Rear Overhang <u>106</u> cm</p> <p>Undeformed End Width <u>144</u> cm</p> <p>Engine Size: cyl./displ. <u>4cyl. 1.6</u> L</p>	<p>WHEEL STEER ANGLES (For locked front wheels or displaced rear axles only)</p> <p>RF ± <u> </u> ° LF ± <u>10</u> ° RR ± <u> </u> ° LR ± <u> </u> °</p> <p>Within ± 5 degrees</p> <hr/> <p>DRIVE WHEELS</p> <p><input checked="" type="checkbox"/> FWD <input type="checkbox"/> RWD <input type="checkbox"/> 4WD</p> <hr/> <p>Approximate Cargo Weight <u> </u> kg</p>
<p>TYPE OF TRANSMISSION</p> <p><input type="checkbox"/> Manual <input checked="" type="checkbox"/> Automatic</p> <p>END SHIFT ≥ 10 CM</p> <p><input checked="" type="checkbox"/> Yes <input type="checkbox"/> No</p>		

MEASUREMENTS IN CENTIMETERS

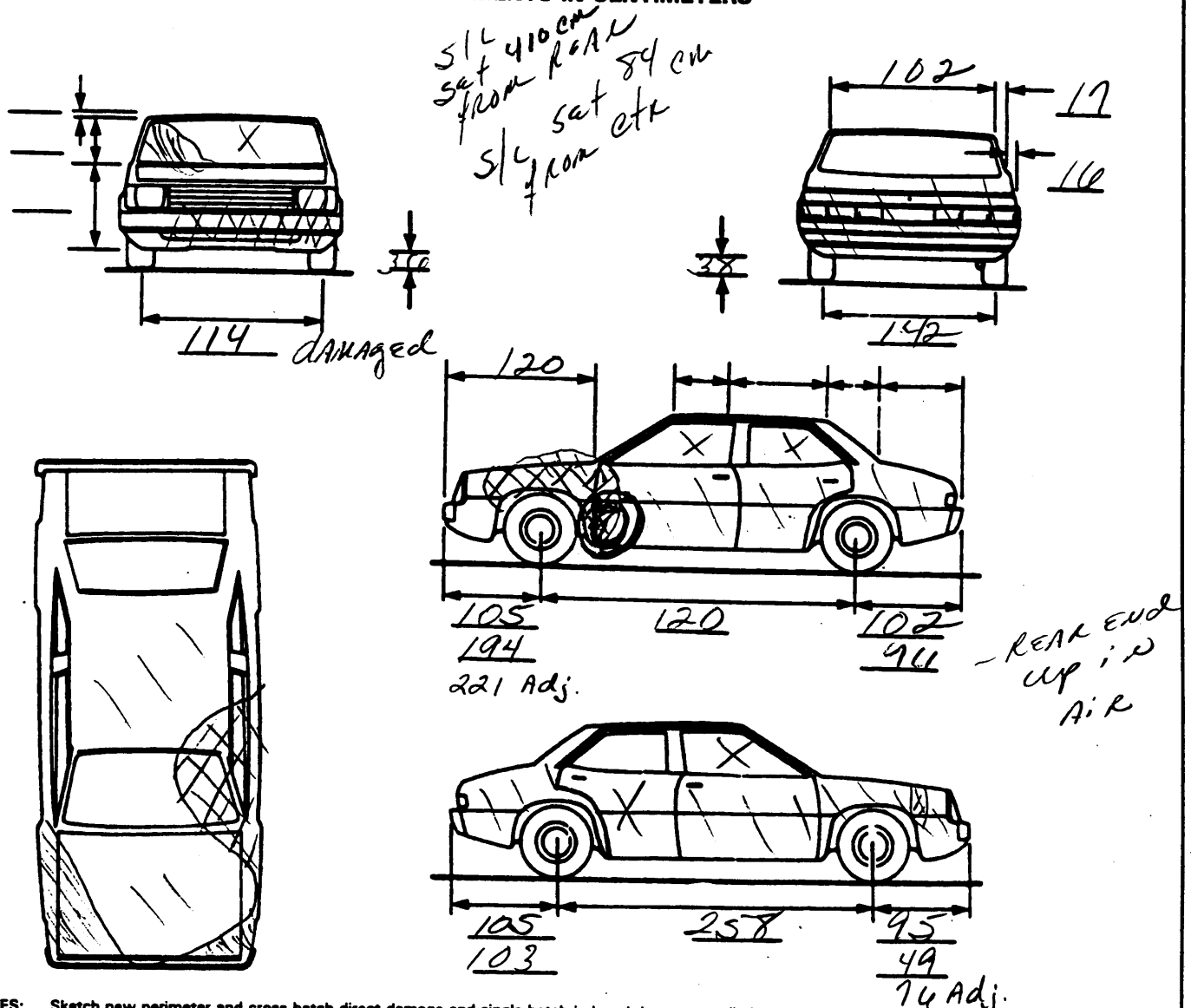

NOTES: Sketch new perimeter and cross hatch direct damage and single hatch induced damage on all views. Annotate observations which might be useful in reconstructing the accident (e.g., grass in tire bead, direction of striations, scuff on sidewalls, etc.). If pulling trailer, sketch type of trailer and damage received on the back of this page.

Annotate any damage caused by extrication such as component removal by torching, prying, or hydraulic shears.

COLLISION DEFORMATION CLASSIFICATION

HIGHEST DELTA "V"

Accident Event Sequence Number	Object Contacted	(1) (2) Direction of Force	(3) Deformation Location	(4) Longitudinal or Lateral Location	(5) Vertical or Lateral Location	(6) Type of Damage Distribution	(7) Deformation Extent
4. <u>07</u>	5. <u>42</u>	6. <u>11</u>	7. <u>L</u>	8. <u>Y</u>	9. <u>A</u>	10. <u>W</u>	11. <u>05</u>

Second Highest Delta "V"

12. <u>03</u>	13. <u>42</u>	14. <u>99</u>	15. <u>9</u>	16. <u>9</u>	17. <u>9</u>	18. <u>9</u>	19. <u>99</u>
---------------	---------------	---------------	--------------	--------------	--------------	--------------	---------------

CRUSH PROFILE IN CENTIMETERS

The crush profile for the damage described in the CDC(s) above should be documented in the appropriate space below. (ALL MEASUREMENTS ARE IN CENTIMETERS.)

HIGHEST DELTA "V"

20. L	21. C ₁	C ₂	C ₃	C ₄	C ₅	C ₆	22. ±D
<u>087</u>	<u>056</u>	<u>049</u>	<u>073</u>	<u>071</u>	<u>062</u>	<u>019</u>	<u>111</u>

Second Highest Delta "V"

23. L	24. C ₁	C ₂	C ₃	C ₄	C ₅	C ₆	25. ±D
---	---	---	---	---	---	---	---

26. Undeformed End Width
(Coded when highest severity impact is an end plane impact.) 998
 _____ Code to the nearest centimeter
 (250) 250 centimeters or more
 (998) No highest severity end plane impact
 (999) Unknown

27. Direct Damage Width
(For highest severity impact) 092
 _____ Code to the nearest centimeter
 (250) 250 centimeters or more
 (999) Unknown

28. Original Wheelbase 246
 _____ Code to the nearest centimeter
 (650) 650 centimeters or more
 (999) Unknown
970 inches X 2.54 = 246.3 centimeters

29. Original Average Track Width 142
 _____ Code to the nearest centimeter
 (185) 185 centimeters or more
 (999) Unknown
 _____ inches X 2.54 = _____ centimeters

FUEL SYSTEM

30. Are CDCs Documented
but Not Coded on The
Automated File?

- (0) No
(1) Yes

1

31. Researcher's Assessment of Vehicle
Disposition

- (0) Not towed due to vehicle damage
(1) Towed due to vehicle damage
(9) Unknown

1

32. Is This A Multi-Stage Manufactured Vehicle
And/Or A Certified Altered Vehicle?

- (0) No post manufacturer modifications
(1) Yes - post manufacturer modifications
(specify): _____

0

(Include photograph of CERTIFICATION
PLACARD in case report)

- (9) Unknown if vehicle is modified

FIRE OCCURRENCE

33. Fire Occurrence
(0) No fire

Yes, fire occurred

- (1) Minor
(2) Major
(9) Unknown

0

34. Origin of Fire

- (0) No fire
(1) Vehicle exterior (front, side, back, top)
(2) Exhaust system
(3) Fuel tank (and other fuel retention
system parts)
(4) Engine compartment
(5) Cargo/trunk compartment
(6) Instrument panel
(7) Passenger compartment area
(8) Other location (specify): _____

0

- (9) Unknown

35. Location of Fuel Tank-1 Filler Cap

2

36. Location of Fuel Tank-2 Filler Cap

0

- (0) No fuel tank
(1) On back plane
(2) Aft of center of the rear wheels (rear axle)
on left side plane
(3) Aft of center of the rear wheels (rear axle)
on right side plane
(4) Forward of center of the rear wheels (rear
axle) on left side plane
(5) Forward of center of the rear wheels (rear
axle) on right side plane
(6) Over the center of the rear wheels (rear
axle) on left side plane
(7) Over the center of the rear wheels (rear
axle) on right side plane
(8) Other (specify): _____
(9) Unknown

37. Type of Fuel Tank-1

1

38. Type of Fuel Tank-2

0

- (0) No fuel tank (electrical vehicle)
(1) Metallic
(2) Non-metallic
(9) Unknown

39. Location of Fuel Tank-1

4

40. Location of Fuel Tank-2

0

- (0) No fuel tank
(1) Aft of center of the rear wheels (rear axle)
centered
(2) Aft of center of the rear wheels (rear axle)
left side
(3) Aft of center of the rear wheels (rear axle)
right side
(4) Forward of center of the rear wheels (rear
axle) centered
(5) Forward of center of the rear wheels (rear
axle) left side
(6) Forward of center of the rear wheels (rear
axle) right side
(7) Over center of the rear wheels (rear axle)
(8) Other (specify): _____
(9) Unknown

41. Damage to Fuel Tank-1

1

42. Damage to Fuel Tank-2

0

- (0) No fuel tank
(1) No damage to fuel tank
(2) Deformed, no seam failure
(3) Deformed, with a seam failure
(4) Punctured
(5) Lacerated (ripped)
(6) Abraded (scraped)
(7) Filler neck separation from the fuel tank
(8) Other damage (specify): _____
(9) Unknown

43. Leakage Location of Fuel System-1 1

44. Leakage Location of Fuel System-2 0

(0) No fuel tank
(1) No fuel leakage

Primary Area Of Leakage

(2) Tank
(3) Filler neck
(4) Cap
(5) Lines/pump/filter
(6) Vent/emission recovery
(8) Other (specify): _____
(9) Unknown

45. Fuel Type-1 01

46. Fuel Type-2 00

Single Fuel Type

(00) No fuel tank
(01) Gasoline
(02) Diesel
(03) CNG (Compressed Natural Gas)
(04) LPG (Liquid Petroleum Gas) also known as Propane
(05) LNG (Liquid Natural Gas)
(06) Methanol (M100 or M85)
(07) Ethanol (E100 or E85)
(08) Other (Hydrogen or others) (specify): _____

Electric Powered or Electric/Solar Powered Vehicles

(10) Lead Acid Battery
(11) Nickel-Iron Battery
(12) Nickel-Cadmium Battery
(13) Sodium Metal Chloride Battery
(14) Sodium Sulfur Battery
(18) Other (Specify): _____

(98) Other Hybrid (specify): _____

(99) Unknown fuel type

47. Is This Vehicle Equipped With More Than Two Fuel Tanks? 0

(0) No (one or two tanks only)

Yes - More Than Two Tanks

(1) Yes -- no damage to any tank or filler cap and no fuel system leakage

(2) Yes -- no damage to any tank or filler cap but there is fuel system leakage (specify leakage location): _____

(3) Yes -- damage to an additional tank or filler cap and there is fuel system leakage (specify the following):

Type of tank _____
Tank location _____
Filler cap location _____
Tank damage _____
Location of leakage _____
Type of fuel _____

(9) Unknown if more than two tanks

COMMENTS

*** STOP: IF THE CDS APPLICABLE VEHICLE WAS NOT TOWED ***

(GV10=0)

DO NOT COMPLETE THE INTERIOR VEHICLE FORM.



INTERIOR VEHICLE FORM

1. Primary Sampling Unit Number 48
 2. Case Number - Stratum 140A
 3. Vehicle Number 01

INTEGRITY

4. Passenger Compartment Integrity 12
 (00) No integrity loss

Yes, Integrity Was Lost Through

- (01) Windshield
- (02) Door (side)
- (03) Door/hatch (back door)
- (04) Roof
- (05) Roof glass
- (06) Side window
- (07) Rear window (backlight)
- (08) Roof and roof glass
- (09) Windshield and door (side)
- (10) Windshield and roof
- (11) Side and rear window (side window and backlight)
- (12) Windshield and side window
- (13) Door and side window
- (98) Other combination of above (specify):

(99) Unknown

*RR door
& B Pillar
removed
by rescue*

Door, Tailgate or Hatch Opening

5. LF 3 6. RF 9 7. LR 3 8. RR 9 9. TG/H 0

- (0) No door/gate/hatch
- (1) Door/gate/hatch remained closed and operational
- (2) Door/gate/hatch came open during collision
- (3) Door/gate/hatch jammed shut
- (8) Other (specify):
- (9) Unknown

Damage/Failure Associated with Door, Tailgate or Hatch Opening in Collision. If IV05-IV09 ≠ 2, Then code Ø

10. LF 0 11. RF 0 12. LR 0 13. RR 0 14. TG/H 0

- (0) No door/gate/hatch or door not opened

Door, Tailgate or Hatch Came Open During Collision

- (1) Door operational (no damage)
- (2) Latch/striker failure due to damage
- (3) Hinge failure due to damage
- (4) Door structure failure due to damage
- (5) Door support (i.e., pillar, sill, roof side rail, etc.) failure due to damage
- (6) Latch/striker and hinge failure due to damage
- (8) Other failure (specify):

(9) Unknown

GLAZING

Type of Window/Windshield Glazing

15. WS 1 16. LF 2 17. RF 2 18. LR 2 19. RR 2

20. BL 2 21. Roof 0 22. Other 2

- (0) No glazing
- (1) AS-1 - Laminated
- (2) AS-2 - Tempered
- (3) AS-3 - Tempered-tinted (original)
- (4) AS-2 - Tempered-with after market tint
- (5) AS-3 - Tempered-tinted (with additional after market tint)
- (6) AS-14 - Glass/Plastic
- (7) Glazing removed prior to accident
- (8) Other (specify):
- (9) Unknown

Window Precrash Glazing Status

23. WS 1 24. LF 2 25. RF 2 26. LR 2 27. RR 2

28. BL 1 29. Roof 0 30. Other 1

- (0) No glazing
- (1) Fixed
- (2) Closed
- (3) Partially opened
- (4) Fully opened
- (7) Glazing removed prior to accident
- (9) Unknown

Glazing Damage from Impact Forces

31. WS 2 32. LF 6 33. RF 6 34. LR 6 35. RR 6

36. BL 1 37. Roof 0 38. Other 6

- (0) No glazing
- (1) No glazing damage from impact forces
- (2) Glazing in place and cracked from impact forces
- (3) Glazing in place and holed from impact forces
- (4) Glazing out-of-place (cracked or not) and not holed from impact forces
- (5) Glazing out-of-place and holed from impact forces
- (6) Glazing disintegrated from impact forces
- (7) Glazing removed prior to accident
- (9) Unknown if damaged

Glazing Damage from Occupant Contact

39. WS 1 40. LF 1 41. RF 1 42. LR 1 43. RR 1

44. BL 1 45. Roof 0 46. Other 1

- (0) No glazing
- (1) No occupant contact to glazing
- (2) Glazing contacted by occupant but no glazing damage
- (3) Glazing in place and cracked by occupant contact
- (4) Glazing in place and holed by occupant contact
- (5) Glazing out-of-place (cracked or not) by occupant contact and not holed by occupant contact
- (6) Glazing out-of-place by occupant contact and holed by occupant contact
- (7) Glazing removed prior to accident
- (8) Glazing disintegrated by occupant contact
- (9) Unknown if contacted by occupant

INTRUSION WORKSHEET

NOTE: SKETCH INTRUDED AREAS

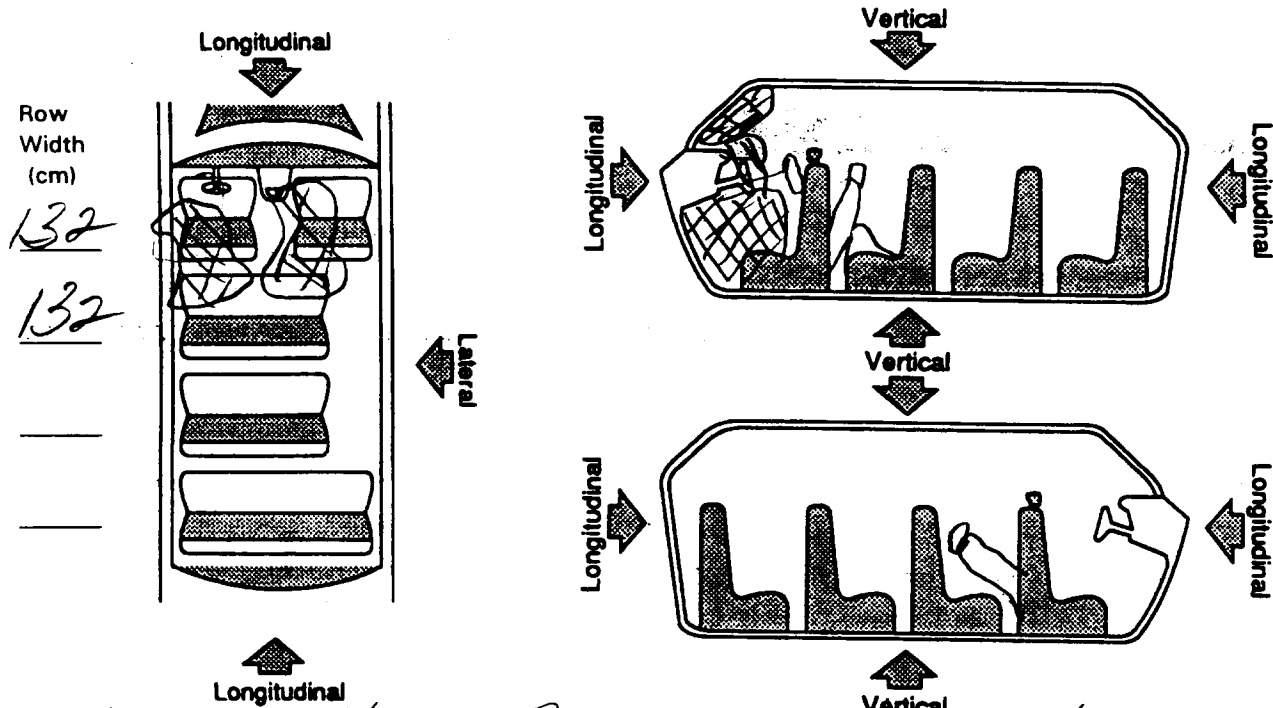

LONG MEAS. TAKEN FROM C. PILLAR

LOCATION OF INTRUSION	INTRUDED COMPONENT	(All Measurements Are in Centimeters)			DOMINANT CRUSH DIRECTION
		COMPARISON VALUE	INTRUDED VALUE	INTRUSION	
11	Steering wheel	163	62	= 101 ③	LONG
}	inst. panel	171	66	= 105 ②	
	toe pan	200	91	= 109 ①	
	front header	140	78	= 62 ⑤	
	Roof	137	78	= 59 ⑦	
	11/12	door panel	0	50	
12	inst. panel	171	100	= 71 ④	LONG
}	front header	140	87	= 53 ⑧	
	Roof	137	84	= 51 ⑨	
23	RF seatback	92	53	= 39	}
21	LF seatback	92	30	= 62 ⑥	
	SEAT CUSHION	27	41	= 14	
22	"	27	40	= 13	}
23	"	27	33	= 6	
13	inst. panel	171	137	= 34	LONG

12 toe pan Document no more than the 15 most severe intrusions 52 ⑨

178 126

OCCUPANT AREA INTRUSION

Note: If no intrusions, leave variables IV47-IV86 blank.

INTRUDING COMPONENT

	Location of Intrusion	Intruding Component	Magnitude of Intrusion	Dominant Crush Direction
1st	47. <u>11</u>	48. <u>05</u>	49. <u>6</u>	50. <u>2</u>
2nd	51. <u>11</u>	52. <u>02</u>	53. <u>6</u>	54. <u>2</u>
3rd	55. <u>11</u>	56. <u>01</u>	57. <u>6</u>	58. <u>2</u>
4th	59. <u>12</u>	60. <u>03</u>	61. <u>6</u>	62. <u>2</u>
5th	63. <u>11</u>	64. <u>16</u>	65. <u>6</u>	66. <u>2</u>
6th	67. <u>21</u>	68. <u>20</u>	69. <u>6</u>	70. <u>2</u>
7th	71. <u>11</u>	72. <u>13</u>	73. <u>5</u>	74. <u>2</u>
8th	75. <u>12</u>	76. <u>16</u>	77. <u>5</u>	78. <u>2</u>
9th	79. <u>12</u>	80. <u>05</u>	81. <u>5</u>	82. <u>2</u>
10th	83. <u>12</u>	84. <u>13</u>	85. <u>5</u>	86. <u>2</u>

Interior Components

- (01) Steering assembly
- (02) Instrument panel left
- (03) Instrument panel center
- (04) Instrument panel right
- (05) Toe pan
- (06) A (A1/A2)-pillar
- (07) B-pillar
- (08) C-pillar
- (09) D-pillar
- (10) Side panel - forward of the A1/A2-pillar
- (11) Door panel (side)
- (12) Side panel - rear of the B-pillar
- (13) Roof (or convertible top)
- (14) Roof side rail
- (15) Windshield
- (16) Windshield header
- (17) Window frame
- (18) Floor pan (includes sill)
- (19) Backlight header
- (20) Front seat back
- (21) Second seat back
- (22) Third seat back
- (23) Fourth seat back
- (24) Fifth seat back
- (25) Seat cushion
- (26) Back door/panel (e.g., tailgate)
- (27) Other interior component (specify): _____

Exterior Components

- (30) Hood
- (31) Outside surface of this vehicle (specify): _____
- (32) Other exterior object in the environment (specify): _____
- (33) Unknown exterior object
- (97) Catastrophic
- (98) Intrusion of unlisted component(s) (specify): _____
- (99) Unknown

LOCATION OF INTRUSION

Front Seat
 (11) Left
 (12) Middle
 (13) Right

Second Seat
 (21) Left
 (22) Middle
 (23) Right

Third Seat
 (31) Left
 (32) Middle
 (33) Right

Fourth Seat
 (41) Left
 (42) Middle
 (43) Right

(97) Catastrophic
 (98) Other enclosed area (specify) _____

(99) Unknown _____

MAGNITUDE OF INTRUSION

- (1) ≥ 3 centimeters but < 8 centimeters
- (2) ≥ 8 centimeters but < 15 centimeters
- (3) ≥ 15 centimeters but < 30 centimeters
- (4) ≥ 30 centimeters but < 46 centimeters
- (5) ≥ 46 centimeters but < 61 centimeters
- (6) ≥ 61 centimeters
- (7) Catastrophic
- (9) Unknown

DOMINANT CRUSH DIRECTION

- (1) Vertical
- (2) Longitudinal
- (3) Lateral
- (7) Catastrophic
- (9) Unknown

STEERING RIM/SPOKE DEFORMATION

(All Measurements Are in Centimeters)

COMPARISON VALUE — DAMAGE VALUE = DEFORMATION

—

=

—

=

—

=

—

=

STEERING COLUMN

INSTRUMENT PANEL

87. Steering Column Type 1
 (1) Fixed column
 (2) Tilt column
 (3) Telescoping column
 (4) Tilt and telescoping column
 (8) Other column type (specify): _____
 (9) Unknown

88. Tilt Steering Column Adjustment 0
 (0) No tilt steering column
 (1) Full up
 (2) Between full up and center
 (3) Center
 (4) Between center and full down
 (5) Full down
 (9) Unknown

89. Telescoping Steering Column Adjustment 0
 (0) No telescoping steering column
 (1) Full back
 (2) Between full back and midpoint
 (3) Midpoint
 (4) Between midpoint and full forward
 (5) Full forward
 (9) Unknown

90. Steering Rim/Spoke Deformation 02
 Code actual measured
 deformation to the nearest centimeter
 (00) No steering rim deformation
 (01-14) Actual measured value in centimeters
 (15) 15 centimeters or more
 (98) Observed deformation cannot be measured
 (99) Unknown

91. Location of Steering Rim/Spoke Deformation 07
 (00) No steering rim deformation

Quarter Sections

- (01) Section A
- (02) Section B
- (03) Section C
- (04) Section D



Half Sections

- (05) Upper half of rim/spoke
- (06) Lower half of rim/spoke
- (07) Left half of rim/spoke
- (08) Right half of rim/spoke

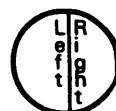
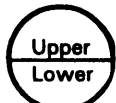

- (09) Complete steering wheel collapse
- (10) Undetermined location
- (99) Unknown

92. Odometer Reading 030,000
 _____ kilometers
 Code to the nearest 1,000 kilometers
 (000) No odometer
 (001) Less than 1,500 kilometers
 (500) 499,500 kilometers or more
 (999) Unknown
18519 miles x 1.6093 = 29803 kilometers

Source: _____

93. Instrument Panel Damage from Occupant Contact? 9
 (0) No
 (1) Yes
 (9) Unknown

94. Type of Knee Bolster Covering 2
 (0) No knee bolster
 (1) Padded
 (2) Rigid plastic
 (8) Other (specify): _____
 (9) Unknown

95. Knee Bolsters Deformed from Occupant Contact? 9
 (0) No knee bolster
 (1) No deformation
 (2) Yes - deformation
 (9) Unknown

96. Did Glove Compartment Door Open During Collision(s)? 2
 (0) No glove compartment door
 (1) No - door did not open
 (2) Yes - door opened
 (9) Unknown

97. Adaptive (Assistive) Driving Equipment 0
 (0) No adaptive driving equipment
 (1) Adaptive driving equipment installed (Check all that apply.)
 Hand controls for braking/acceleration
 Steering control devices (attached to OEM steering wheel)
 Steering knob attached to steering wheel
 Low effort power steering (unit or device)
 Replacement steering wheel (i.e., reduced diameter)
 Joy-stick steering controls
 Wheelchair tie-downs
 Modification to seat belts (specify): _____

Additional or relocated switches (specify): _____

- Raised roof
- Wall-mounted head rest (used behind wheelchair)
- Other adaptive device (specify): _____

(9) Unknown

VEHICLE INTERIOR SKETCHES

Note area of ejection/entrapment

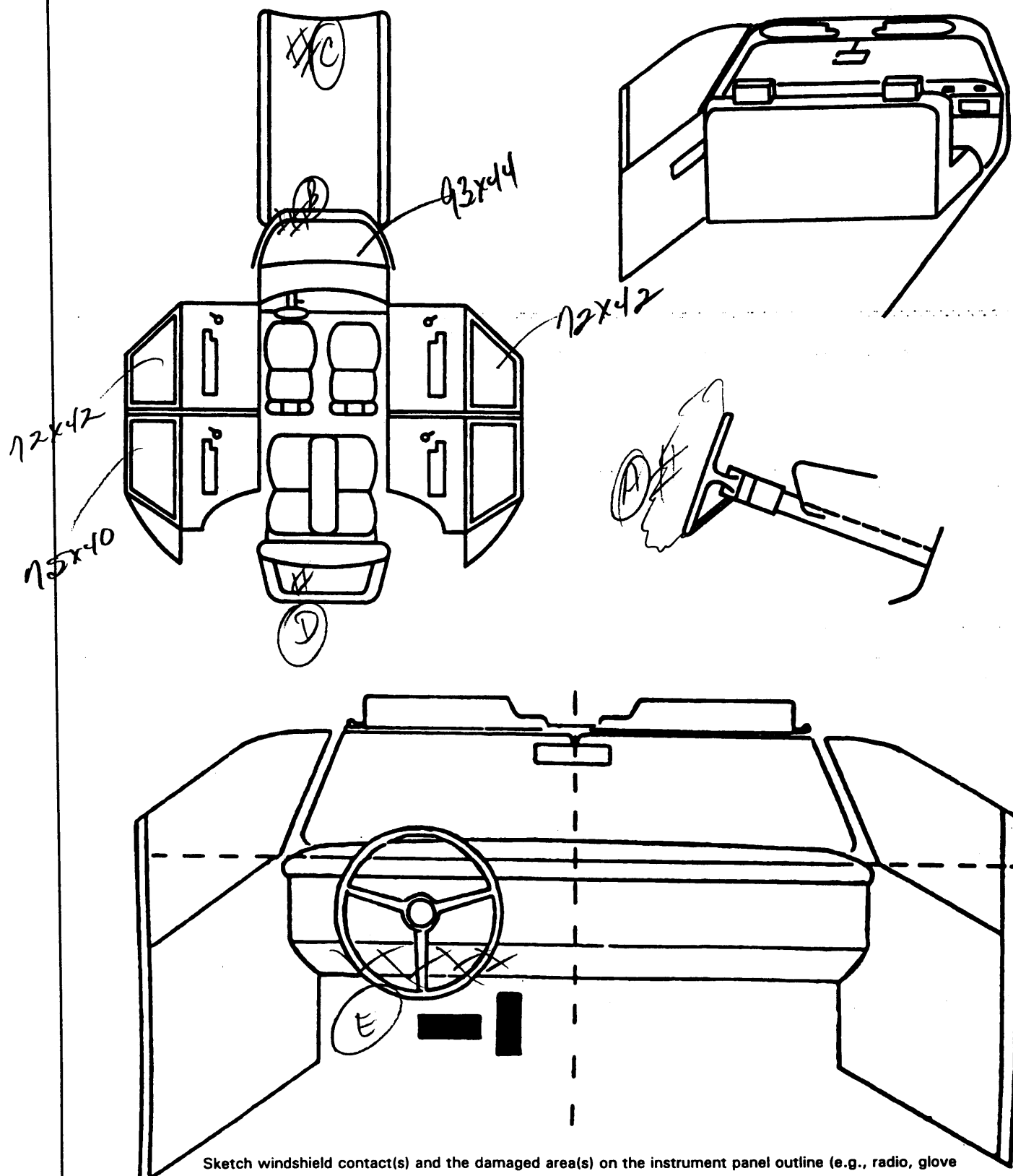

Sketch windshield contact(s) and the damaged area(s) on the instrument panel outline (e.g., radio, glove compartment, damage to instrument panel structure).
Cross hatch contact points, draw spider webs or use other annotation as may be appropriate.
Annotate the contacted area with a letter (begin with A) and list on the Points of Occupant Contact page.

POINTS OF OCCUPANT CONTACT

Contact	Interior Component Contacted	Occupant No. If Known	Body Region If Known	Supporting Physical Evidence	Confidence Level of Contact Point
A	170	1	face	blood	1
B	201	1	head	black scuffs + TEARS	1
C	205	1	head	blood + fluids	1
D	301	1	head	SPLATTERS	2
E	010	1	legs	INTRUSION	2
F					
G					
H					
I					
J					
K					
L					
M					
N					

CODES FOR INTERIOR COMPONENTS

- | | | | |
|---|--|---|--|
| <p>FRONT
 (001) Windshield
 (002) Mirror
 (003) Sunvisor
 (004) Steering wheel rim
 (005) Steering wheel hub/spoke
 (006) Steering wheel (combination of codes 004 and 005)
 (007) Steering column, transmission selector lever, other attachment
 (008) Cellular telephone or CB radio
 (009) Add on equipment (e.g., tapedeck, air conditioner)
 (010) Left instrument panel and below
 (011) Center instrument panel and below
 (012) Right instrument panel and below
 (013) Glove compartment door
 (014) Knee bolster
 (015) Windshield including one or more of the following: front header, A (A1/A2)-pillar, instrument panel, mirror, or steering assembly (driver side only)
 (016) Windshield including one or more of the following: front header, A (A1/A2)-pillar, instrument panel, or mirror (passenger side only)
 (017) Windshield reinforced by exterior object, (specify): _____
 (019) Other front object (specify): _____</p> | <p>LEFT SIDE
 (051) Left side interior surface, excluding hardware or armrests
 (052) Left side hardware or armrest
 (053) Left A (A1/A2)-pillar
 (054) Left B-pillar
 (055) Other left pillar (specify): _____
 (056) Left side window glass
 (057) Left side window frame
 (058) Left side window sill
 (059) Left side window glass including one or more of the following: frame, window sill, A (A1/A2)-pillar, B-pillar, or roof side rail.
 (060) Other left side object (specify): _____</p> <p>RIGHT SIDE
 (101) Right side interior surface, excluding hardware or armrests
 (102) Right side hardware or armrest
 (103) Right A (A1/A2)-pillar
 (104) Right B-pillar
 (105) Other right pillar (specify): _____
 (106) Right side window glass
 (107) Right side window frame
 (108) Right side window sill
 (109) Right side window glass including one or more of the following: frame, window sill, A (A1/A2)-pillar, B-pillar, or roof side rail.
 (110) Other right side object (specify): _____</p> | <p>INTERIOR
 (151) Seat, back support
 (152) Belt restraint webbing/buckle
 (153) Belt restraint B-pillar or door frame attachment point
 (154) Other restraint system component (specify): _____
 (155) Head restraint system
 (160) Other occupants (specify): _____
 (161) Interior loose objects
 (162) Child safety seat (specify): _____
 (163) Other interior object (specify): _____</p> <p>AIR BAG
 (170) Air bag-driver side
 (175) Air bag compartment cover-driver side
 (180) Air bag-passenger side
 (185) Air bag compartment cover-passenger side
 (190) Other air bag (specify) _____
 (195) Other air bag compartment cover (specify) _____</p> <p>ROOF
 (201) Front header
 (202) Rear header
 (203) Roof left side rail
 (204) Roof right side rail
 (205) Roof or convertible top</p> <p>FLOOR
 (251) Floor (including toe pan)
 (252) Floor or console mounted transmission lever, including console
 (253) Parking brake handle
 (254) Foot controls including parking brake</p> | <p>REAR
 (301) Backlight (rear window)
 (302) Backlight storage rack, door, etc.
 (303) Other rear object (specify): _____</p> <p>ADAPTIVE (ASSISTIVE) DRIVING EQUIPMENT
 (401) Hand controls for braking/acceleration
 (402) Steering control devices (attached to OEM steering wheel)
 (403) Steering knob attached to steering wheel
 (405) Replacement steering wheel (i.e., reduced diameter)
 (406) Joy stick steering controls
 (407) Wheelchair tie-downs
 (408) Modification to seat belts, (specify): _____
 (409) Additional or relocated switches, (specify): _____
 (410) Raised roof
 (411) Wall mounted head rest (used behind wheel chair)
 (412) Other adaptive device (specify): _____</p> |
|---|--|---|--|

CONFIDENCE LEVEL OF CONTACT POINT	
(1)	Certain
(2)	Probable
(3)	Possible
(9)	Unknown

MANUAL RESTRAINTS

NOTES: Encode the applicable data for each seat position in the vehicle. The attribute for the variable may be found below. Restraint systems should be assessed during the vehicle inspection then coded on the Occupant Assessment Form.

If a child safety seat is present, encode the data on the back of this page 11.

If the vehicle has automatic restraints available, encode the appropriate data on page 6.

		Left	Center	Right
FIRST	A-Availability	4	/	4
	B-Evidence of usage	4	/	4
	C-Used in this crash?	4	/	0
	D-Proper Use	4	/	0
	E-Failure Modes	4	/	4
	F-Anchorage Adjustment	4	/	4
SECOND	A-Availability	00	3	00
	B-Evidence of usage	00	00	00
	C-Used in this crash?	0	0	0
	D-Proper Use	0	0	0
	E-Failure Modes	0	0	0
	F-Anchorage Adjustment	1	0	1
OTHER	A-Availability			
	B-Evidence of usage			
	C-Used in this crash?			
	D-Proper Use			
	E-Failure Modes			
	F-Anchorage Adjustment			

- | | | |
|---|---|--|
| <p>A-Manual (Active) Belt System Availability</p> <ul style="list-style-type: none"> (0) None available (1) Belt removed/destroyed (2) Shoulder belt (3) Lap belt (4) Lap and shoulder belt (5) Belt available - type unknown <p><i>Integral Belt Partially Destroyed</i></p> <ul style="list-style-type: none"> (6) Shoulder belt (lap belt destroyed/removed) (7) Lap belt (shoulder belt destroyed/removed) (8) Other belt (specify): _____ (9) Unknown <p>B/C-Manual (Active) Belt System Use</p> <ul style="list-style-type: none"> (00) None used, not available, or belt removed/destroyed (01) Inoperable (specify): _____ (02) Shoulder belt (03) Lap belt (04) Lap and shoulder belt (05) Belt used - type unknown (08) Other belt used (specify): _____ (12) Shoulder belt used with child safety seat (13) Lap belt used with child safety seat (14) Lap and shoulder belt used with child safety seat (15) Belt used with child safety seat - type unknown (18) Other belt used with child safety seat (specify): _____ (99) Unknown if belt used | <p>D-Proper Use of Manual (Active) Belts</p> <ul style="list-style-type: none"> (0) None used or not available (1) Belt used properly (2) Belt used properly with child safety seat <p><i>Belt Used Improperly</i></p> <ul style="list-style-type: none"> (3) Shoulder belt worn under arm (4) Shoulder belt worn behind back or seat (5) Belt worn around more than one person (6) Lap belt worn on abdomen (7) Lap belt or lap and shoulder belt used improperly with child safety seat (specify): _____ (8) Other improper use of manual belt system (specify): _____ (9) Unknown <p>E-Manual (Active) Belt Failure Modes During Accident</p> <ul style="list-style-type: none"> (0) No manual belt used or not available (1) No manual belt failure(s) (2) Torn webbing (stretched webbing not included) (3) Broken buckle or latchplate (4) Upper anchorage separated (5) Other anchorage separated (specify): _____ (6) Broken retractor (7) Combination of above (specify): _____ (8) Other manual belt failure (specify): _____ (9) Unknown | <p>F-Shoulder Belt Upper Anchorage Adjustment</p> <ul style="list-style-type: none"> (0) No shoulder belt (1) No upper anchorage adjustment for shoulder belt <p><i>Adjustable shoulder Belt Upper Anchorage</i></p> <ul style="list-style-type: none"> (2) In full up position (3) In mid position (4) In full down position (5) Position unknown (9) Unknown if position has adjustable upper anchorage adjustment |
|---|---|--|

Both 'B' PILLARS
cut off.
Both front
seat belts cut
from 'B' PILLARS.

AUTOMATIC RESTRAINTS

NOTES: Encode the data for each applicable front seat position. The attribute for the variables may be found below. Restraint systems should be assessed during the vehicle inspection then coded on the Occupant Assessment Form.

AIR BAGS

		Frontal Air Bags--Left Front	Frontal Air Bags-Right Front	Other Air Bag
F I R S T	Availability/Function	/	/	0
	Deployment	/	/	
	Failure	/	/	

- | | | |
|--|---|--|
| <p>Air Bag System Availability/Function
 (0) Not equipped/not available
 (1) Air bag

 <i>Non-functional</i>
 (2) Air bag disconnected (specify): _____
 (3) Air bag not reinstalled
 (9) Unknown</p> | <p>Air Bag System Deployment (This Occupant Position)
 (0) Not equipped/not available
 (1) Deployed during accident (as a result of impact)
 (2) Deployed inadvertently just prior to accident
 (3) Deployed, accident sequence undetermined
 (4) Deployed as a result of a noncollision event during accident sequence (e.g., fire, explosion, electrical)
 (5) Unknown if deployed
 (7) Nondeployed
 (9) Unknown</p> | <p>Are There Indications of Air Bag System Failure? (This Occupant Position)
 (0) Not equipped/not available
 (1) No
 (2) Yes (specify): _____
 (9) Unknown</p> |
|--|---|--|

AUTOMATIC BELTS

		Left	Right
F I R S T	A-Availability/Function	0	0
	B-Use		
	C-Type		
	D-Proper Use		
	E-Failure Modes		

- | | | |
|---|--|---|
| <p>A-Automatic (Passive) Belt System Availability/Function
 (0) Not equipped/not available
 (1) 2 point automatic belts
 (2) 3 point automatic belts
 (3) Automatic belts - type unknown

 <i>Non-functional</i>
 (4) Automatic belts destroyed or rendered inoperative
 (9) Unknown</p> | <p>D-Proper Use of Automatic (Passive) Belt System
 (0) Not equipped/not available/not used
 (1) Automatic belt used properly
 (2) Automatic belt used properly with child safety seat

 <i>Automatic Belt Used Improperly</i>
 (3) Automatic shoulder belt worn under arm
 (4) Automatic shoulder belt worn behind back
 (5) Automatic belt worn around more than one person
 (6) Lap portion of automatic belt worn on abdomen
 (7) Automatic lap and shoulder belt or

 automatic shoulder belt used improperly with child safety seat (specify): _____
 (8) Other improper use of automatic belt system (specify): _____
 (9) Unknown</p> | <p>E-Automatic (Passive) Belt Failure Modes During Accident
 (0) Not equipped/not available/not in use
 (1) No automatic belt failure(s)
 (2) Torn webbing (stretched webbing not included)
 (3) Broken buckle or latchplate
 (4) Upper anchorage separated
 (5) Other anchorage separated (specify): _____
 (6) Broken retractor
 (7) Combination of above (specify): _____
 (8) Other automatic belt failure (specify): _____
 (9) Unknown</p> |
| <p>B-Automatic (Passive) Belt System Use
 (0) Not equipped/not available/destroyed or rendered inoperative
 (1) Automatic belt in use
 (2) Automatic belt not in use (manually disconnected, motorized track inoperative)
 (3) Automatic belt use unknown
 (9) Unknown</p> | | |
| <p>C-Automatic (Passive) Belt System Type
 (0) Not equipped/not available
 (1) Non-motorized system
 (2) Motorized system
 (9) Unknown</p> | | |

FIRST SEAT FRONTAL AIR BAGS

NOTES: Encode the applicable data *for the driver and first seat passenger* in the vehicle. The attribute for the variable may be found below. Restraint systems should be assessed during the vehicle inspection then coded on the Occupant Assessment Form.

	Driver	Passenger
A-Type of air bag?	1	1
B-Flaps open at tear points?	2	2
C-Flaps damaged?	1	1
D-Air bag damaged?	01	01
E-Source of air bag damage	01	01
F-Air bag tethered?	2	1
G-Air bag have vent ports?	2	2
H-Other occupant contact air bag?	1	1
I-Occupant wearing eyewear?	9	9

A-Type of Air Bag

- (0) Not equipped/not available
- (1) Original manufacturer installed system
- (2) Retrofitted air bag
- (3) Replacement air bag
- (8) Unknown type of air bag
- (9) Unknown

B-Did Air Bag Module Cover Flap(s) Open At Designated Tear Points?

- (0) Not equipped/not available
- (1) No
- (2) Yes
- (3) Deployed, unknown if flap(s) opened at designated tear points
- (7) Not deployed
- (8) Unknown if deployed
- (9) Unknown

C-Were Air Bag Module Cover Flap(s) Damaged?

- (0) Not equipped/not available
- (1) No
- (2) Yes (specify): _____
- (3) Deployed, unknown if air bag module cover flap(s) damaged
- (7) Not deployed
- (8) Unknown if deployed
- (9) Unknown

D-Was There Damage To The Air Bag?

- (00) Not equipped/not available
- (01) Not damaged

Yes - Air Bag Damage

- (02) Ruptured
- (03) Cut
- (04) Torn
- (05) Holed
- (06) Burned
- (07) Abraded
- (88) Other damage (specify): _____

- (95) Damaged, details unknown
- (96) Deployed, unknown if damaged
- (97) Not deployed
- (98) Unknown if deployed
- (99) Unknown

E-Source of Air Bag Damage

- (00) Not equipped/not available
- (01) Not damaged
- (02) Object worn by occupant, (specify): _____
- (03) Object carried by occupant, (specify): _____
- (04) Adaptive/assistive controls, (specify): _____
- (05) Fire in vehicle
- (06) Thermal burns
- (07) Rescue or emergency efforts
- (88) Other damage source (specify): _____

- (95) Damaged, unknown source
- (96) Deployed, unknown if damaged
- (97) Not deployed
- (98) Unknown if deployed
- (99) Unknown

F-Was The Air Bag Tethered?

- (0) Not equipped/not available
- (1) No
- (2) Yes (specify number of tether straps): 210
- (3) Deployed, unknown if tethered
- (7) Not deployed
- (8) Unknown if deployed
- (9) Unknown

G-Did The Air Bag Have Vent Ports?

- (0) Not equipped/not available
- (1) No
- (2) Yes (specify number of vent ports): 212
- (3) Deployed, unknown if vent ports present
- (7) Not deployed
- (8) Unknown if deployed
- (9) Unknown

H-Was the Air Bag in this Occupant's Position Contacted by Another Occupant?

- (0) Not equipped/not available
- (1) No
- (2) Yes (specify): _____
- (3) Deployed, unknown if other occupant contact to air bag
- (7) Not deployed
- (8) Unknown if deployed
- (9) Unknown

I-Was This Occupant Wearing Eye-wear?

- (0) Not equipped/not available
- (1) No
- (2) Eyeglasses/sunglasses
- (3) Contact lenses
- (4) Deployed, unknown if eyewear worn
- (7) Not deployed
- (8) Unknown if deployed
- (9) Unknown

DRIVER AIR BAG DAMAGE AND CONTACT SKETCHES

1. SKETCH DAMAGE AND CONTACT EVIDENCE ON DRIVER AIR BAG (Front)

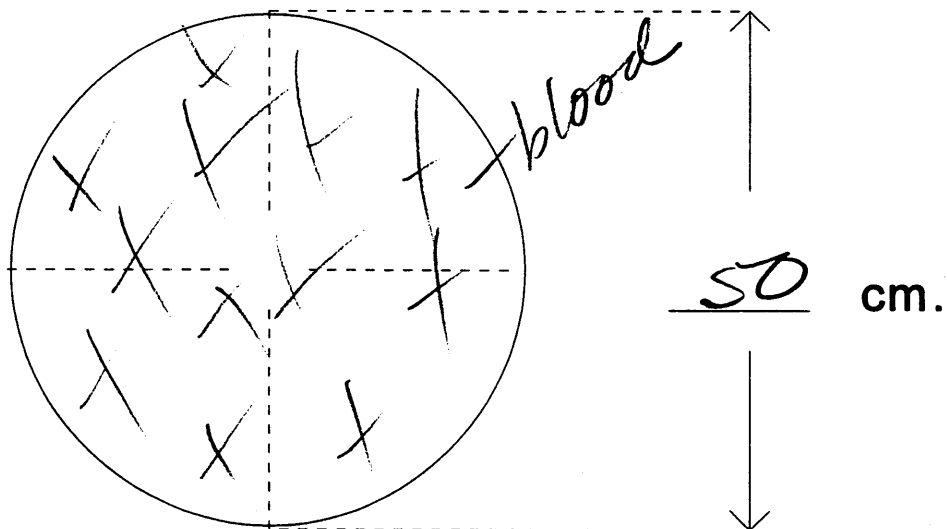

2. SKETCH DAMAGE AND CONTACT EVIDENCE ON DRIVER AIR BAG (Back)

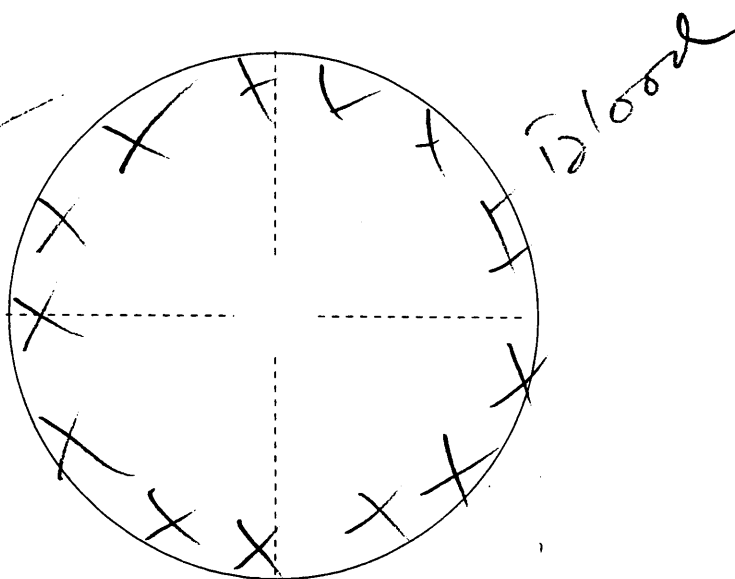

DRIVER AIR BAG SKETCHES (Cont'd)

3. DRIVER AIR BAG MODULE COVER FLAP SIZE (SINGLE)

width (W_U) _____ width (W_L) _____
 height (H) _____

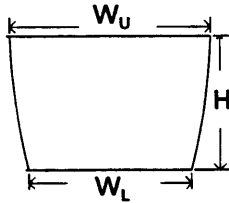

4. DRIVER AIR BAG MODULE COVER FLAP SIZE (DOUBLE)

a. Upper Flap

b. Lower Flap

width (W_U) 14 width (W_L) 14
 height (H_U) 8 height (H_L) 8

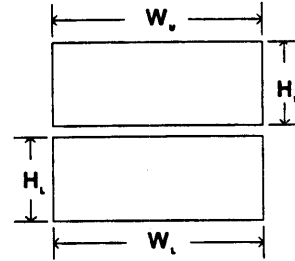

5. SKETCH OF OTHER TYPE OF AIR BAG MODULE FLAP AND SIZE

6. SKETCH OF OTHER TYPE OF AIR BAG VENT PORTS

7. SKETCH LOCATION OF CIRCULAR AIR BAG VENT PORTS

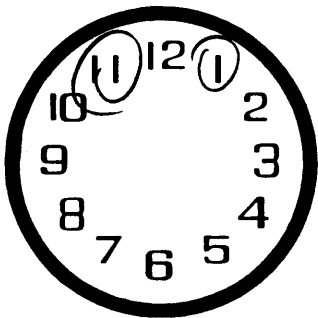

PASSENGER AIR BAG DAMAGE AND CONTACT SKETCHES

1. SKETCH DAMAGE AND CONTACT EVIDENCE ON PASSENGER AIR BAG (Front)

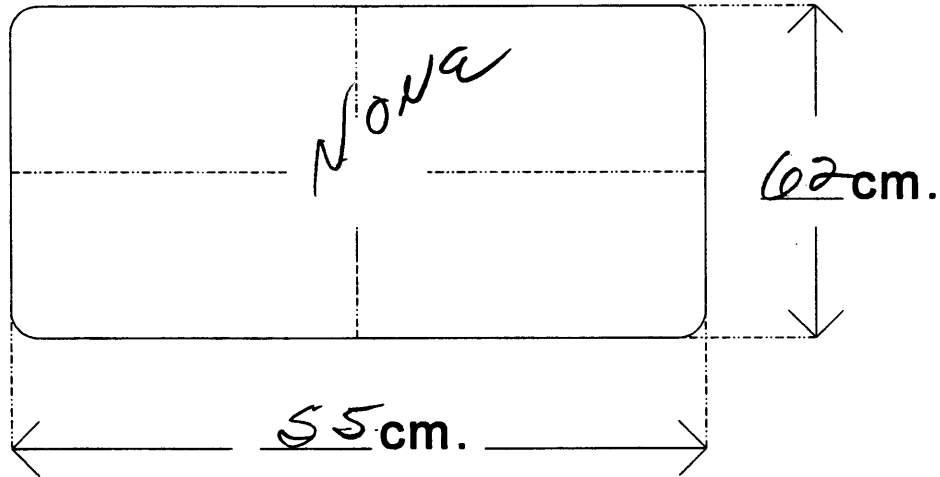

2. SKETCH DAMAGE AND CONTACT EVIDENCE ON PASSENGER AIR BAG (Back)

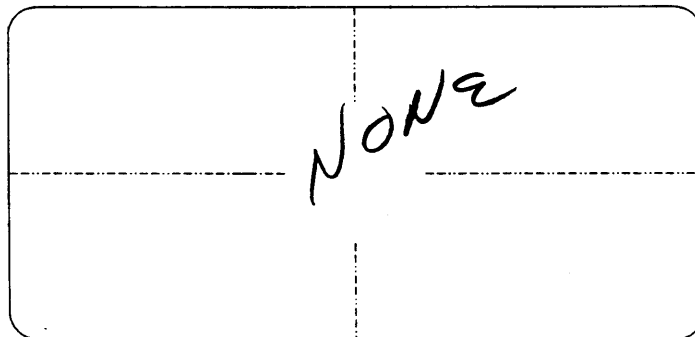

PASSENGER AIR BAG SKETCHES (Cont'd)

3. PASSENGER AIR BAG MODULE COVER FLAP SIZE (SINGLE)

width (W) 35
 height (H) 14

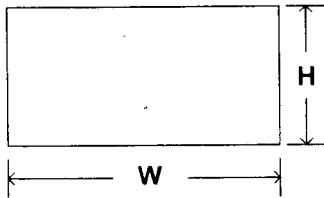

4. PASSENGER AIR BAG MODULE COVER FLAP SIZE (DOUBLE)

a. Upper Flap b. Lower Flap
 width (W_u) _____ width (W_l) _____
 height (H_u) _____ height (H_l) _____

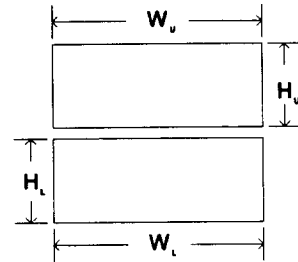

5. SKETCH OF OTHER TYPE OF AIR BAG MODULE FLAP AND SIZE

6. SKETCH OF OTHER TYPE OF AIR BAG VENT PORTS

7. SKETCH LOCATION OF RECTANGULAR AIR BAG VENT PORTS

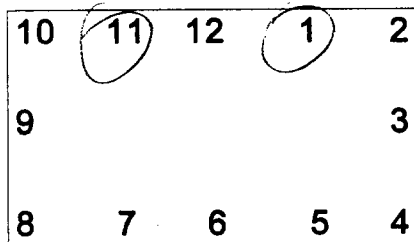

"OTHER" AIR BAG DAMAGE AND CONTACT SKETCHES

1. SKETCH DAMAGE AND CONTACT EVIDENCE ON "OTHER" AIR BAG (Front)

2. SKETCH DAMAGE AND CONTACT EVIDENCE ON "OTHER" AIR BAG (Back)

"OTHER" AIR BAG SKETCHES (Cont'd)

3. SKETCH AIR BAG MODULE FLAP AND SIZE OR OPENING FOR AIRBAG

4. SKETCH AIR BAG VENT PORTS

HEAD RESTRAINTS/SEAT EVALUATION

NOTES: Encode the applicable data for each seat position in the vehicle.. The attribute for these variables may be found on the next page. Head restraint type/damage and seat type/performance should be assessed during the vehicle inspection then coded on the Occupant Assessment Form.

		Left	Center	Right
FIRST	A-Head Restraint Type/Damage	3	/	3
	B-Seat Type	01		01
	C-Seat Orientation	1		1
	D-Seat Track Position	9		9
	E-Seat Back Incline Pre/Post Impact	99		99
	F-Seat Performance	6		6
SECOND	A-Head Restraint Type/Damage	0	0	0
	B-Seat Type	03	03	03
	C-Seat Orientation	1	1	1
	D-Seat Track Position	1	1	1
	E-Seat Back Incline Pre/Post Impact	01	01	01
	F-Seat Performance	6	6	6
THIRD	A-Head Restraint Type/Damage			
	B-Seat Type			
	C-Seat Orientation			
	D-Seat Track Position			
	E-Seat Back Incline Pre/Post Impact			
	F-Seat Performance			
OTHER	A-Head Restraint Type/Damage			
	B-Seat Type			
	C-Seat Orientation			
	D-Seat Track Position			
	E-Seat Back Incline Pre/Post Impact			
	F-Seat Performance			

**DESCRIBE ANY INDICATION OF ABNORMAL OCCUPANT POSTURE
(I.E., UNUSUAL OCCUPANT CONTACT PATTERN)**

None

HEAD RESTRAINTS/SEAT EVALUATION

A-Head Restraint Type/Damage by Occupant at This Occupant Position

- (0) No head restraints
- (1) Integral — no damage
- (2) Integral — damaged during accident
- (3) Adjustable — no damage
- (4) Adjustable — damaged during accident
- (5) Add-on — no damage
- (6) Add-on — damaged during accident
- (8) Other
- Specify: _____
- (9) Unknown

E-Seat Back Incline Prior and Post Impact

- (00) Occupant not seated or no seat
- (01) Not adjustable

Upright prior to impact

- (11) Moved to completely rearward position
- (12) Moved to rearward midrange position
- (13) Moved to slightly rearward position
- (14) Retained pre-impact position
- (15) Moved to slightly forward position
- (16) Moved to forward midrange position
- (17) Moved to completely forward position

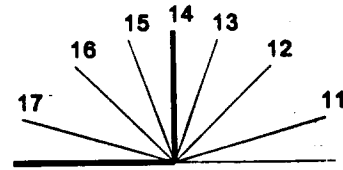

Slightly reclined prior to impact

- (21) Moved to completely rearward position
- (22) Moved to rearward midrange position
- (23) Retained pre-impact position
- (24) Moved to upright position
- (25) Moved to slightly forward position
- (26) Moved to forward midrange position
- (27) Moved to completely forward position

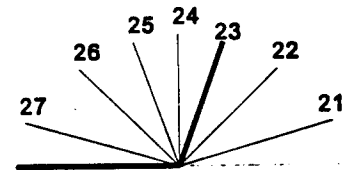

Completely reclined prior to impact

- (31) Retained pre-impact position
- (32) Moved to rearward midrange position
- (33) Moved to slightly rearward position
- (34) Moved to upright position
- (35) Moved to slightly forward position
- (36) Moved to forward midrange position
- (37) Moved to completely forward position

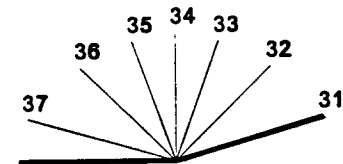

Coding diagrams for *Seat Back Incline Position Prior and Post Impact*

B-Seat Type (this Occupant Position)

- (00) Occupant not seated or no seat
- (01) Bucket
- (02) Bucket with folding back
- (03) Bench
- (04) Bench with separate back cushions
- (05) Bench with folding back(s)
- (06) Split bench with separate back cushions
- (07) Split bench with folding back(s)
- (08) Pedestal (i.e., column supported)
- (09) Box mounted seat (i.e., van type)
- (10) Other seat type (specify): _____
- (99) Unknown

C-Seat Orientation (this Occupant Position)

- (0) Occupant not seated or no seat
- (1) Forward facing seat
- (2) Rear facing seat
- (3) Side facing seat (inward)
- (4) Side facing seat (outward)
- (8) Other (specify): _____
- (9) Unknown

F-Seat Performance (this Occupant Position)

- (0) Occupant not seated or no seat
- (1) No seat performance failure(s)
- (2) Seat adjusters failed
- (3) Seat back folding locks or "seat back" failed (specify): _____
- (4) Seat tracks/anchors failed
- (5) Deformed by impact of occupant
- (6) Deformed by passenger compartment intrusion (specify): TO LEFT & REARWARD
- (7) Combination of above (specify): _____
- (8) Other (specify): _____
- (9) Unknown

DESCRIBE ANY INDICATION OF

ABNORMAL OCCUPANT POSTURE

(I.E., UNUSUAL OCCUPANT

CONTACT PATTERN)

D-Seat Track Adjusted Position Prior To Impact

- (0) Occupant not seated or no seat
 - (1) Non-adjustable seat track
- Adjustable Seat Track*
- (2) Seat at forward most track position
 - (3) Seat between forward most and middle track positions
 - (4) Seat at middle track position
 - (5) Seat between middle and rear most track positions
 - (6) Seat at rear most track position
 - (9) Unknown

*REAR CUSHIONS
pushed upward*

CHILD SAFETY SEAT FIELD ASSESSMENT

When a child safety seat is present enter the occupant's number in the first row and complete the column below the occupant's number using the codes listed below. Complete a column for each child safety seat present.

Occupant Number						
1. Type of Child Safety Seat						
2. Child Safety Seat Orientation						
3. Child Safety Seat Harness Usage		N/A				
4. Child Safety Seat Shield Usage						
5. Child Safety Seat Tether Usage						
6. Child Safety Seat Make/Model	Specify Below for Each Child Safety Seat					

1. Type of Child Safety Seat

- (0) No child safety seat
- (1) Infant seat
- (2) Toddler seat
- (3) Convertible seat
- (4) Booster seat
- (7) Other type child safety seat (specify):

- (8) Unknown child safety seat type
- (9) Unknown if child safety seat used

2. Child Safety Seat Orientation

- (00) No child safety seat
- Designed for Rear Facing for This Age/Weight
- (01) Rear facing
- (02) Forward facing
- (08) Other orientation (specify):

- (09) Unknown orientation

- Designed for Forward Facing for This Age/Weight
- (11) Rear facing
- (12) Forward facing
- (18) Other orientation (specify):

- (19) Unknown orientation

- Unknown Design or Orientation For This Age/Weight, or Unknown Age/Weight
- (21) Rear facing
- (22) Forward facing
- (28) Other orientation (specify):

- (29) Unknown orientation
- (99) Unknown if child safety seat used

3. Child Safety Seat Harness Usage

4. Child Safety Seat Shield Usage

- 5. Child Safety Seat Tether Usage**
Note: Options Below Are Used for Variables 3-5.
- (00) No child safety seat

- Not Designed with Harness/Shield/Tether
- (01) After market harness/shield/tether added, not used
- (02) After market harness/shield/tether used
- (03) Child safety seat used, but no after market harness/shield/tether added
- (09) Unknown if harness/shield/tether added or used

- Designed With Harness/Shield/Tether
- (11) Harness/shield/tether not used
- (12) Harness/shield/tether used
- (19) Unknown if harness/shield/tether used

- Unknown If Designed With Harness/Shield/Tether
- (21) Harness/shield/tether not used
- (22) Harness/shield/tether used
- (29) Unknown if harness/shield/tether used

- (99) Unknown if child safety seat used

6. Child Safety Seat Make/Model
(Specify make/model and occupant number)

EJECTION/ENTRAPMENT DATA

Complete the following if the researcher has any indication that an occupant was either ejected from or entrapped in the vehicle. Code the appropriate data on the Occupant Assessment Form.

EJECTION No Yes

Describe indications of ejection and body parts involved in partial ejection(s):

Occupant Number						
Ejection						
(Note on Vehicle Interior Sketch) Ejection Area						
Ejection Medium						
Medium Status						

Ejection

- (1) Complete ejection
- (2) Partial ejection
- (3) Ejection, Unknown degree
- (9) Unknown

Ejection Area

- (1) Windshield
- (2) Left front
- (3) Right front
- (4) Left rear
- (5) Right rear
- (6) Rear

- (7) Roof
- (8) Other area (e.g., back of pickup, etc.) (specify): _____
- (9) Unknown

Ejection Medium

- (1) Door/hatch/tailgate
- (2) Nonfixed roof structure
- (3) Fixed glazing
- (4) Nonfixed glazing (specify): _____

- (5) Integral structure
- (8) Other medium (specify): _____
- (9) Unknown

Medium Status (Immediately Prior to Impact)

- (1) Open
- (2) Closed
- (3) Integral structure
- (9) Unknown

ENTRAPMENT No Yes

Describe entrapment mechanism: _____

INSTRUMENT PANEL + STEERING COLUMN IN FUSION.

Component(s): _____

(Note on vehicle interior sketch)



OCCUPANT ASSESSMENT FORM

1. Primary Sampling Unit Number 48
 2. Case Number - Stratum 140A
 3. Vehicle Number 01
 4. Occupant Number 01

OCCUPANT'S CHARACTERISTICS

5. Occupant's Age 51
 Code actual age at time of accident.
 (00) Less than one year old (specify by month): _____
 (97) 97 years and older
 (99) Unknown

6. Occupant's Sex 2
 (1) Male
 (2) Female-not reported pregnant
 (3) Female-pregnant-1st trimester(1st-3rd month)
 (4) Female-pregnant-2nd trimester(4th-6th month)
 (5) Female-pregnant-3rd trimester(7th-9th month)
 (6) Female-pregnant-term unknown
 (9) Unknown

7. Occupant's Height 152
 Code actual height to the nearest centimeter.
 (999) Unknown
60 inches X 2.54 = 152.4 centimeters

8. Occupant's Weight 102
 Code actual weight to the nearest kilogram.
 (999) Unknown
225 pounds X .4536 = 102 kilograms

9. Occupant's Role 1
 (1) Driver
 (2) Passenger
 (9) Unknown

OCCUPANT'S SEATING

10. Occupant's Seat Position 11
Front Seat
 (11) Left side
 (12) Middle
 (13) Right side
 (14) Other (specify): _____
 (15) On or in the lap of another occupant

Second Seat
 (21) Left side
 (22) Middle
 (23) Right side
 (24) Other (specify): _____
 (25) On or in the lap of another occupant

Third Seat
 (31) Left side
 (32) Middle
 (33) Right side
 (34) Other (specify): _____
 (35) On or in the lap of another occupant

Fourth Seat
 (41) Left side
 (42) Middle
 (43) Right side
 (44) Other (specify): _____
 (45) On or in the lap of another occupant

(97) In or on unenclosed area
 (98) Other seat (specify): _____
 (99) Unknown

11. Occupant's Posture 9
 (0) Normal posture

Abnormal posture
 (1) Kneeling or standing on seat
 (2) Lying on or across seat
 (3) Kneeling, standing or sitting in front of seat
 (4) Sitting sideways or turned to talk with another occupant or to look out a rear window
 (5) Sitting on a console
 (6) Lying back in a reclined seat position
 (7) Bracing with feet or hands on a surface in front of seat
 (8) Other abnormal posture (specify): _____
 (9) Unknown

EJECTION/ENTRAPMENT

12. Ejection 0

- (0) No ejection
- (1) Complete ejection
- (2) Partial ejection
- (3) Ejection, unknown degree
- (9) Unknown

13. Ejection Area 0

- (0) No ejection
- (1) Windshield
- (2) Left front
- (3) Right front
- (4) Left rear
- (5) Right rear
- (6) Rear
- (7) Roof
- (8) Other area (e.g., back of pickup, etc.)
(specify): _____
- (9) Unknown

14. Ejection Medium 0

- (0) No ejection
- (1) Door/hatch/tailgate
- (2) Nonfixed roof structure
- (3) Fixed glazing
- (4) Nonfixed glazing (specify): _____
- (5) Integral structure
- (8) Other medium (specify): _____
- (9) Unknown

15. Medium Status (Immediately Prior To Impact) 0

- (0) No ejection
- (1) Open
- (2) Closed
- (3) Integral structure
- (9) Unknown

16. Entrapment 1

- (0) Not entrapped/exit not inhibited
- (1) Entrapped/pinned - mechanically restrained
- (2) Could not exit vehicle due to jammed doors, fire, etc.
(specify): _____
- (9) Unknown

17. Occupant Mobility 0

- (0) Occupant fatal before removed from vehicle
- (1) Removed from vehicle while unconscious or not oriented to time or place
- (2) Removed from vehicle due to perceived serious injuries
- (3) Exited vehicle with some assistance
- (4) Exited vehicle under own power
- (5) Occupant fully ejected
- (8) Removed from vehicle for other reasons
(specify): _____
- (9) Unknown

BELT SYSTEM FUNCTION

18. Manual (Active) Belt System Availability 4

- (0) None available
- (1) Belt removed/destroyed
- (2) Shoulder belt
- (3) Lap belt
- (4) Lap and shoulder belt
- (5) Belt available—type unknown

Integral Belt Partially Destroyed

- (6) Shoulder belt (lap belt destroyed/removed)
- (7) Lap belt (shoulder belt destroyed/removed)
- (8) Other belt (specify): 04

(9) Unknown 0019. Manual (Active) Belt System Use 00

- (00) None used, not available, or belt removed/destroyed
- (01) Inoperative (specify): 00

- (02) Shoulder belt
- (03) Lap belt
- (04) Lap and shoulder belt
- (05) Belt used—type unknown
- (08) Other belt used (specify):

- (12) Shoulder belt used with child safety seat
- (13) Lap belt used with child safety seat
- (14) Lap and shoulder belt used with child safety seat
- (15) Belt used with child safety seat—type unknown
- (18) Other belt used with child safety seat (specify):
- (99) Unknown if belt used

20. Proper Use of Manual (Active) Belts 1

- (0) None used or not available
- (1) Belt used properly
- (2) Belt used properly with child safety seat

Belt Used Improperly

- (3) Shoulder belt worn under arm
- (4) Shoulder belt worn behind back or seat
- (5) Belt worn around more than one person
- (6) Lap belt worn on abdomen
- (7) Lap belt or lap and shoulder belt used improperly with child safety seat (specify):

(8) Other improper use of manual belt system (specify): 1(9) Unknown 0021. Manual (Active) Belt Failure Modes During Accident 00

- (0) No manual belt used or not available
- (1) No manual belt failure(s)
- (2) Torn webbing (stretched webbing not included)
- (3) Broken buckle or latchplate
- (4) Upper anchorage separated
- (5) Other anchorage separated (specify):

(6) Broken retractor

(7) Combination of above (specify):

(8) Other manual belt failure (specify):

(9) Unknown

22. Manual Shoulder Belt Upper Anchorage Adjustment 1

- (0) No manual shoulder belt
- (1) No upper anchorage adjustment for manual shoulder belt

Adjustable shoulder Belt Upper Anchorage

- (2) In full up position
- (3) In mid position
- (4) In full down position
- (5) Position unknown
- (9) Unknown if position has adjustable upper anchorage adjustment

23. Automatic (Passive) Belt System Availability/Function 0

- (0) Not equipped/not available
- (1) 2 point automatic belts
- (2) 3 point automatic belts
- (3) Automatic belts - type unknown

Non-functional

- (4) Automatic belts destroyed or rendered inoperative
- (9) Unknown

24. Automatic (Passive) Belt System Use 0

- (0) Not equipped/not available/destroyed or rendered inoperative
- (1) Automatic belt in use
- (2) Automatic belt not in use (manually disconnected, motorized track inoperative) (specify):
- (3) Automatic belt use unknown
- (9) Unknown

25. Automatic (Passive) Belt System Type 0

- (0) Not equipped/not available
- (1) Non-motorized system
- (2) Motorized system
- (9) Unknown

26. Proper Use of Automatic (Passive) Belt System 0

- (0) Not equipped/not available/not used
- (1) Automatic belt used properly
- (2) Automatic belt used properly with child safety seat

Automatic Belt Used Improperly

- (3) Automatic shoulder belt worn under arm
- (4) Automatic shoulder belt worn behind back
- (5) Automatic belt worn around more than one person
- (6) Lap portion of automatic belt worn on abdomen
- (7) Automatic lap and shoulder belt or

automatic shoulder belt used improperly with child safety seat (specify):

(8) Other improper use of automatic belt system (specify):

(9) Unknown

27. Automatic (Passive) Belt Failure Modes During Accident 0

- (0) Not equipped/not available/not in use
- (1) No automatic belt failure(s)
- (2) Torn webbing (stretched webbing not included)
- (3) Broken buckle or latchplate
- (4) Upper anchorage separated
- (5) Other anchorage separated (specify):

(6) Broken retractor

(7) Combination of above (specify):

(8) Other automatic belt failure (specify):

(9) Unknown

POLICE REPORTED RESTRAINT USE

AIR BAG SYSTEM FUNCTION

28. Police Reported Belt Use 5
- (0) None used
 - (1) Police did not indicate belt use
 - (2) Shoulder belt
 - (3) Lap belt
 - (4) Lap and shoulder belt
 - (5) Belt used, type not specified
 - (6) Child safety seat
 - (7) Automatic belt
 - (8) Other type belt, (specify):

(9) Police indicated "unknown"

29. Police Reported Air Bag Availability/Function 2
- (0) No air bag available
 - (1) Police did not indicate air bag availability/function
 - (2) Deployed
 - (3) Not deployed
 - (4) Unknown if deployed
 - (9) Police indicated "unknown"

Check the Primary Source Used In Determining Belt Use.

- Vehicle inspection
- Official injury data
- Driver/occupant interview
- Other (specify):

Unknown if belt used

30. Frontal Air Bag System Availability/Function (This Occupant Position) 1
- (0) Not equipped/not available
 - (1) Air bag
- Non-functional*
- (2) Air bag disconnected (specify):
 - (3) Air bag not reinstalled
 - (9) Unknown

31. Frontal Air Bag System Deployment (This Occupant Position) 1
- (0) Not equipped/not available
 - (1) Deployed during accident (as a result of impact)
 - (2) Deployed inadvertently just prior to accident
 - (3) Deployed, details unknown
 - (4) Deployed as a result of a noncollision event during accident sequence (e.g., fire, explosion, electrical)
 - (5) Unknown if deployed
 - (7) Nondeployed
 - (9) Unknown

32. Other Than First Seat Frontal Air Bag Availability/Function (This Occupant Position) 0
- (0) Not equipped/not available
 - (1) Air bag

Non-functional

- (2) Air bag disconnected (specify):

- (3) Air bag not reinstalled
- (9) Unknown

Specify type of "other" air bag present:

33. Air Bag(s) Deployment, Other Than First Seat Frontal (This Occupant Position) 0
- (0) Not equipped with an "other" air bag
 - (1) Deployed during accident (as a result of impact)
 - (2) Deployed inadvertently just prior to accident
 - (3) Deployed, details unknown
 - (4) Deployed as a result of a noncollision event during accident sequence (e.g., fire, explosion, electrical)
 - (5) Unknown if deployed
 - (7) Nondeployed
 - (9) Unknown

34. Are There Indications of Air Bag System Failure? (This Occupant Position) 1
- (0) Not equipped/not available
 - (1) No
 - (2) Yes (specify):
 - (9) Unknown

FIRST SEAT FRONTAL AIR BAG SYSTEM EVALUATION

35. Had Vehicle Been in Previous Accident(s)? 1
 (0) Not equipped/not available
 (1) No previous accidents
 Yes
 (2) Previous accident(s) without deployment(s)
 (3) One previous accident with deployment
 (4) More than one previous accident with at least one deployment
 (8) Previous accidents, unknown deployment status
 (9) Unknown
36. Type of Air Bag 1
 (0) Not equipped/not available
 (1) Original manufacturer installed system
 (2) Retrofitted air bag
 (3) Replacement air bag
 (8) Unknown type of air bag
 (9) Unknown
37. Had Any Prior Maintenance/Service Been Performed On This Air Bag System? 1
 (0) Not equipped/not available
 (1) No prior maintenance
 (2) Yes, prior maintenance (specify): _____
 (9) Unknown
38. Air Bag Deployment Accident Event Sequence Number 96
 (00) Not equipped/not available
 _____ Code the accident event sequence number that initiated the air bag deployment
 (96) Deployed, unknown event
 (97) Not deployed
 (98) Unknown if deployed
 (99) Unknown
39. CDC For Air Bag Deployment Impact 4
 (0) Not equipped/not available
 (1) Highest delta V
 (2) Second highest delta V
 (3) Other non-coded delta V (specify): _____
 (6) Deployed, unknown event
 (7) Not deployed
 (8) Unknown if deployed
 (9) Unknown
40. Longitudinal Component of Delta V For Air Bag Deployment Impact + 996
 (000) Not equipped/not available
Code the value of the delta V for the impact that initiated the air bag deployment
 (_996) Deployment, unknown longitudinal Delta V
 (_997) Not deployed
 (_998) Unknown if deployed
 (_999) Unknown
41. Did Air Bag Module Cover Flap(s) Open At Designated Tear Points? 2
 (0) Not equipped/not available
 (1) No
 (2) Yes
 (3) Deployed, unknown if flap(s) opened at designated tear points
 (7) Not deployed
 (8) Unknown if deployed
 (9) Unknown
42. Were Air Bag Module Cover Flap(s) Damaged? 1
 (0) Not equipped/not available
 (1) No
 (2) Yes (specify): _____
 (3) Deployed, unknown if air bag module cover flap(s) damaged
 (7) Not deployed
 (8) Unknown if deployed
 (9) Unknown
43. Was There Damage To The Air Bag? 01
 (00) Not equipped/not available
 (01) Not damaged
 Yes - Air Bag Damage
 (02) Ruptured
 (03) Cut
 (04) Torn
 (05) Holed
 (06) Burned
 (07) Abraded
 (88) Other damage (specify): _____
 (95) Damaged, details unknown
 (96) Deployed, unknown if damaged
 (97) Not deployed
 (98) Unknown if deployed
 (99) Unknown

FIRST SEAT FRONTAL AIR BAG SYSTEM
EVALUATION *continued*

44. Source of Air Bag Damage 01
 (00) Not equipped/not available
 (01) Not damaged
 (02) Object worn by occupant, (specify):

 (03) Object carried by occupant, (specify):

 (04) Adaptive/assistive controls, (specify):

 (05) Fire in vehicle
 (06) Thermal burns
 (07) Rescue or emergency efforts
 (88) Other damage source (specify):

 (95) Damaged, unknown source
 (96) Deployed, unknown if damaged
 (97) Not deployed
 (98) Unknown if deployed
 (99) Unknown
45. Was The Air Bag Tethered? 2
 (0) Not equipped/not available
 (1) No
 (2) Yes (specify number of tether straps):
2
 (3) Deployed, unknown if tethered
 (7) Not deployed
 (8) Unknown if deployed
 (9) Unknown
46. Did The Air Bag Have Vent Ports? 2
 (0) Not equipped/not available
 (1) No
 (2) Yes (specify number of vent ports):
2
 (3) Deployed, unknown if vent ports present
 (7) Not deployed
 (8) Unknown if deployed
 (9) Unknown
47. Was the Air Bag in this Occupant's Position Contacted by Another Occupant? 1
 (0) Not equipped/not available
 (1) No
 (2) Yes (specify):

 (3) Deployed, unknown if other occupant contact to air bag
 (7) Not deployed
 (8) Unknown if deployed
 (9) Unknown
48. Was This Occupant Wearing Eye-wear? 1
 (0) Not air bag equipped/air bag not available
 (1) No
 (2) Eyeglasses/sunglasses
 (3) Contact lenses
 (4) Deployed, unknown if eyewear worn
 (7) Not deployed
 (8) Unknown if deployed
 (9) Unknown

HEAD RESTRAINT AND SEAT EVALUATION

49. Head Restraint Type/Damage by Occupant at This Occupant Position 3
 (0) No head restraints
 (1) Integral—no damage
 (2) Integral—damaged during accident
 (3) Adjustable—no damage
 (4) Adjustable—damaged during accident
 (5) Add-on—no damage
 (6) Add-on—damaged during accident
 (8) Other (specify):

 (9) Unknown
50. Seat Type (this Occupant Position) 01
 (00) Occupant not seated or no seat
 (01) Bucket
 (02) Bucket with folding back
 (03) Bench
 (04) Bench with separate back cushions
 (05) Bench with folding back(s)
 (06) Split bench with separate back cushions
 (07) Split bench with folding back(s)
 (08) Pedestal (i.e., column supported)
 (09) Box mounted seat (i.e., van type)
 (10) Other seat type (specify):

 (99) Unknown
51. Seat Orientation (this Occupant Position) 1
 (0) Occupant not seated or no seat
 (1) Forward facing seat
 (2) Rear facing seat
 (3) Side facing seat (inward)
 (4) Side facing seat (outward)
 (8) Other (specify):

 (9) Unknown
52. Seat Track Adjusted Position Prior To Impact 9
 (0) Occupant not seated or no seat
 (1) Non-adjustable seat track
Adjustable Seat Track
 (2) Seat at forward most track position
 (3) Seat between forward most and middle track positions
 (4) Seat at middle track position
 (5) Seat between middle and rear most track positions
 (6) Seat at rear most track position
 (9) Unknown

HEAD RESTRAINT AND SEAT EVALUATION *continued*

53. Seat Back Incline Prior and Post Impact 99
 (00) Occupant not seated or no seat
 (01) Not adjustable

Upright prior to impact

- (11) Moved to completely rearward position
- (12) Moved to rearward midrange position
- (13) Moved to slightly rearward position
- (14) Retained pre-impact position
- (15) Moved to slightly forward position
- (16) Moved to forward midrange position
- (17) Moved to completely forward position

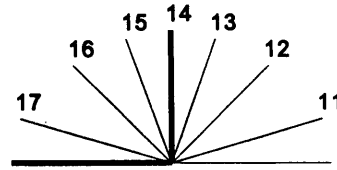

Slightly reclined prior to impact

- (21) Moved to completely rearward position
- (22) Moved to rearward midrange position
- (23) Retained pre-impact position
- (24) Moved to upright position
- (25) Moved to slightly forward position
- (26) Moved to forward midrange position
- (27) Moved to completely forward position

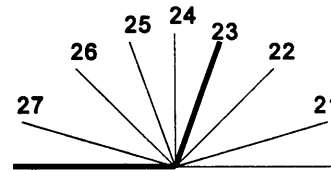

Completely reclined prior to impact

- (31) Retained pre-impact position
- (32) Moved to rearward midrange position
- (33) Moved to slightly rearward position
- (34) Moved to upright position
- (35) Moved to slightly forward position
- (36) Moved to forward midrange position
- (37) Moved to completely forward position
- (99) Unknown

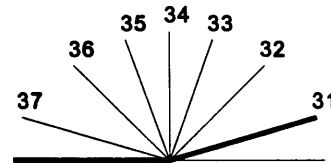

54. Seat Performance (this Occupant Position) 6

- (0) Occupant not seated or no seat
- (1) No seat performance failure(s)
- (2) Seat adjusters failed
- (3) Seat back folding locks or "seat back" failed (specify): _____
- (4) Seat track/anchors failed
- (5) Deformed by impact of occupant
- (6) Deformed by passenger compartment intrusion, (specify): to left & REARWARD
- (7) Combination of above (specify): _____
- (8) Other (specify): _____
- (9) Unknown

CHILD SAFETY SEAT

55. Child Safety Seat Make/Model 000
 (000) No child safety seat
 Applicable codes are found in your NASS CDS
 Data Collection, Coding and Editing
 (950) Built-in child safety seat
 (997) Other make/model (specify):

 (998) Unknown make/model
 (999) Unknown if child safety seat used

56. Type of Child Safety Seat 0
 (0) No child safety seat
 (1) Infant seat
 (2) Toddler seat
 (3) Convertible seat
 (4) Booster seat - with shield
 (5) Booster seat - without shield
 (7) Other type child safety seat (specify):

 (8) Unknown child safety seat type
 (9) Unknown if child safety seat used

57. Child Safety Seat Orientation 00
 (00) No child safety seat

Designed for Rear Facing for This Age/Weight
 (01) Rear facing
 (02) Forward facing
 (08) Other orientation (specify):

 (09) Unknown orientation

Designed For Forward Facing for This Age/Weight
 (11) Rear facing
 (12) Forward facing
 (18) Other orientation (specify):

 (19) Unknown orientation

*Unknown Design or Orientation For This
 Age/Weight, or Unknown Age/Weight*
 (21) Rear facing
 (22) Forward facing
 (28) Other orientation (specify):

 (29) Unknown orientation

(99) Unknown if child safety seat used

58. Child Safety Seat Harness Usage 00

59. Child Safety Seat Shield Usage 00

60. Child Safety Seat Tether Usage 00

Note: Options below applicable to
 Variables OA58-OA60.

(00) No child safety seat

Not Designed With Harness/Shield/Tether

(01) After market harness/shield/tether
 added, not used

(02) After market harness/shield/tether used

(03) Child safety seat used, but no after market
 harness/shield/tether added

(09) Unknown if harness/shield/tether
 added or used

Designed With Harness/Shield/Tether

(11) Harness/shield/tether not used

(12) Harness/shield/tether used

(19) Unknown if harness/shield/tether used

Unknown If Designed With Harness/Shield/Tether

(21) Harness/shield/tether not used

(22) Harness/shield/tether used

(29) Unknown if harness/shield/tether used

(99) Unknown if child safety seat used

INJURY CONSEQUENCES

61. Injury Severity (Police Rating) 4

- (0) O - No injury
- (1) C - Possible injury
- (2) B - Nonincapacitating injury
- (3) A - Incapacitating injury
- (4) K - Killed
- (5) U - Injury, severity unknown
- (6) Died prior to accident
- (9) Unknown

62. Treatment - Mortality 1

- (0) No treatment
- (1) Fatal
- (2) Fatal - ruled disease (specify):

Nonfatal

- (3) Hospitalization
- (4) Transported and released
- (5) Treatment at scene - nontransported
- (6) Treatment later
- (7) Treatment - other (specify):

- (8) Transported to a medical facility-unknown if treated
- (9) Unknown

63. Type Of Medical Facility (for Initial Treatment) 0

- (0) Not treated at a medical facility
- (1) Trauma center
- (2) Hospital
- (3) Medical clinic
- (4) Physician's office
- (5) Treatment later at medical facility
- (8) Other (specify):

(9) Unknown

64. Hospital Stay 00

- (00) Not Hospitalized
- _____ Code the number of days (up through 60) that the occupant stayed in hospital.
- (61) 61 days or more
- (99) Unknown

65. Working Days Lost 62

- _____ Code the number of days (up through 60) that the occupant lost from work due to the accident
- (00) No working days lost
- (61) 61 days or more
- (62) Fatally injured
- (97) Not working prior to accident
- (99) Unknown

EMERGENCY RESPONSE INFORMATION

EMS Notification

- (1) Not notified ROAD VEHICLE
- (2) Notified
- (9) Unknown AIR VEHICLE

EMS Notification Time (first unit)
(9999) Unknown

ROAD VEHICLE

AIR VEHICLE

EMS Arrival Time (first unit)
(9998) EMS cancelled or did not arrive
(9999) Unknown

ROAD VEHICLE

AIR VEHICLE

EMS Departure Time To Treatment Facility (transporting unit)
(9997) EMS arrived, provided treatment, but did not transport
(9998) EMS arrived, but was not used
(9999) Unknown

ROAD VEHICLE

AIR VEHICLE

EMS Arrival Time At Treatment Facility
(9999) Unknown

ROAD VEHICLE

AIR VEHICLE

EMS Type

- (01) Fire department FIRST UNIT TRANSPORTING UNIT
- (02) Rescue squad
- (03) Police department ROAD VEHICLE
- (04) Trauma unit
- (05) Disaster unit AIR VEHICLE
- (06) Ambulance service unit
- (07) Hospital
- (08) Mortuaries/funeral homes
- (98) Other, specify: _____
- (99) Unknown

EMS Care

- (01) No care administered ON-SCENE DURING TRANSPORT
- (02) First aid
- (03) Resuscitation ROAD VEHICLE
- (04) CPR
- (05) Emergency cardiac care AIR VEHICLE
- (06) Life support system monitoring (blood pressure, pulse rate, respiration, EKG)
- (07) Emergency burn care
- (08) Combination of above, specify: _____
- (98) Other, specify: _____
- (99) Unknown

STOP WORK HERE VARIABLES 66-74 TO BE CODED BY THE ZONE CENTER

TO BE CODED BY THE ZONE CENTER**INJURY CONSEQUENCES****TRAUMA DATA**

66. Time to Death 01
 Code number of hours from time of accident to time of death up through 24 hours. If time of death is greater than 24 hours, code number of days. (Note: 1 day = 31, 2 days = 32, ... n days = 30 + n up through 30 days = 60)
 (00) Not fatal
 (96) Fatal - ruled disease
 (99) Unknown

67. 1st Medically Reported Cause of Death 96

68. 2nd Medically Reported Cause of Death 00

69. 3rd Medically Reported Cause of Death 00
 Code the Occupant Injury from line number(s) for the medically reported injury(s) which reportedly contributed to this occupant's death

(00) Not fatal or no additional causes

(96) Mode of death given but specific injuries are not linked to cause of death. (specify):

(97) Other result (includes fatal ruled disease) (specify): multiple blunt trauma

(99) Unknown

70. Number of Recorded Injuries for This Occupant 13

Code the actual number of injuries recorded for this occupant.

(00) No recorded injuries

(97) Injured, details unknown

(99) Unknown if injured

71. Glasgow Coma Scale (GCS) Score 01
 (at Medical Facility)
 (00) Not injured
 (01) Injured - not treated at medical facility
 (02) No GCS Score at medical facility
 (03-15) Code the actual value of the initial GCS Score recorded at medical facility.
 (97) Injured, details unknown
 (99) Unknown if injured

72. Was the Occupant Given Blood? 1

(1) No - blood not given

(2) Yes - blood given

(specify units): _____

(9) Unknown if blood given

73. Arterial Blood Gases (ABG) - HCO₃ 01

(00) Not injured

(01) Injured, ABGs not measured or reported

(02-50) Code the actual value of the HCO₃

(96) ABGs reported, HCO₃ unknown

(97) Injured, details unknown

(99) Unknown if injured

BELT USE DETERMINATION

74. Primary Source of Belt Use Determination 1
 (0) Not equipped/not available/destroyed or rendered inoperative

(1) Vehicle inspection

(2) Official injury data

(3) Driver/occupant interview

(8) Other (specify): _____

(9) Unknown if belt used



OCCUPANT INJURY FORM

1. Primary Sampling Unit Number <u>48</u>	3. Vehicle Number <u>01</u>
2. Case Number - Stratum <u>140A</u>	4. Occupant Number <u>01</u>

INJURY DATA

Record below the actual injuries sustained by this occupant that were identified from the official and unofficial data sources. Remember not to double count an injury just because it was identified from two different sources. If greater than ten injuries have been documented, encode the balance on the Occupant Injury Supplement.

	A.I.S. - 90										Injury Source Confidence Level	Direct/Indirect Injury	Occupant Area Intrusion Number
	Source of Injury Data	Body Region	Type of Anatomic Structure	Specific Anatomic Structure	Level of Injury	A.I.S. Severity	Aspect	Injury Source					
1st	5. <u>1</u>	6. <u>1</u>	7. <u>4</u>	8. <u>06</u>	9. <u>84</u>	10. <u>3</u>	11. <u>9</u>	12. <u>201</u>	13. <u>3</u>	14. <u>1</u>	15. <u>00</u>		
2nd	16. <u>1</u>	17. <u>4</u>	18. <u>4</u>	19. <u>22</u>	20. <u>02</u>	21. <u>3</u>	22. <u>1</u>	23. <u>010</u>	24. <u>3</u>	25. <u>1</u>	26. <u>02</u>		
3rd	27. <u>1</u>	28. <u>7</u>	29. <u>5</u>	30. <u>28</u>	31. <u>04</u>	32. <u>3</u>	33. <u>1</u>	34. <u>010</u>	35. <u>2</u>	36. <u>1</u>	37. <u>02</u>		
4th	38. <u>1</u>	39. <u>7</u>	40. <u>5</u>	41. <u>32</u>	42. <u>04</u>	43. <u>3</u>	44. <u>1</u>	45. <u>010</u>	46. <u>2</u>	47. <u>1</u>	48. <u>02</u>		
5th	49. <u>1</u>	50. <u>8</u>	51. <u>5</u>	52. <u>18</u>	53. <u>14</u>	54. <u>3</u>	55. <u>2</u>	56. <u>014</u>	57. <u>1</u>	58. <u>1</u>	59. <u>02</u>		
6th	60. <u>1</u>	61. <u>8</u>	62. <u>5</u>	63. <u>20</u>	64. <u>00</u>	65. <u>2</u>	66. <u>2</u>	67. <u>251</u>	68. <u>1</u>	69. <u>1</u>	70. <u>01</u>		
7th	71. <u>1</u>	72. <u>8</u>	73. <u>5</u>	74. <u>08</u>	75. <u>06</u>	76. <u>2</u>	77. <u>2</u>	78. <u>251</u>	79. <u>1</u>	80. <u>1</u>	81. <u>01</u>		
8th	82. <u>1</u>	83. <u>4</u>	84. <u>9</u>	85. <u>02</u>	86. <u>02</u>	87. <u>1</u>	88. <u>0</u>	89. <u>152</u>	90. <u>3</u>	91. <u>1</u>	92. <u>00</u>		
9th	93. <u>1</u>	94. <u>5</u>	95. <u>9</u>	96. <u>02</u>	97. <u>02</u>	98. <u>1</u>	99. <u>0</u>	100. <u>170</u>	101. <u>2</u>	102. <u>1</u>	103. <u>00</u>		
10th	104. <u>1</u>	105. <u>5</u>	106. <u>9</u>	107. <u>06</u>	108. <u>02</u>	109. <u>1</u>	110. <u>8</u>	111. <u>010</u>	112. <u>2</u>	113. <u>1</u>	114. <u>02</u>		

OCCUPANT INJURY CLASSIFICATION

Body Region	Specific Anatomic Structure	Level of Injury	Aspect
(1) Head		Specific injuries are assigned consecutive two-digit numbers beginning with 02. To the extent possible, within the organizational framework of the AIS, 00 is assigned to an injury NFS as to severity or where only one injury is given in the dictionary for that anatomic structure. 99 is assigned to any injury NFS as to lesion or severity.	(1) Right
(2) Face			(2) Left
(3) Neck			(3) Bilateral
(4) Thorax			(4) Central
(5) Abdomen			(5) Anterior
(6) Spine			(6) Posterior
(7) Upper Extremity			(7) Superior
(8) Lower Extremity			(8) Inferior
(9) Unspecified			(9) Unknown
			(0) Whole region
Type of Anatomic Structure	<u>Whole Area</u>		
(1) Whole Area	(02) Skin - Abrasion		
(2) Vessels	(04) Skin - Contusion		
(3) Nerves	(06) Skin - Laceration		
(4) Organs (includes Muscles/ligaments)	(08) Skin - Avulsion		
(5) Skeletal (includes joints)	(10) Amputation		
(6) Head - LOC	(20) Burn		
(9) Skin	(30) Crush		
	(40) Degloving		
	(50) Injury - NFS		
	(90) Trauma, other than mechanical		
	<u>Head - LOC</u>		
	(02) Length of LOC		
	(04) Level		
	(06) of		
	(08) Consciousness		
	(10) Concussion		
	<u>Spine</u>		
	(02) Cervical		
	(04) Thoracic		
	(06) Lumbar		
		Abbreviated Injury Scale	
		(1) Minor Injury	
		(2) Moderate Injury	
		(3) Serious Injury	
		(4) Severe Injury	
		(5) Critical Injury	
		(6) Maximum (untreatable)	
		(7) Injured, unknown severity	

SOURCE OF INJURY DATA	INJURY SOURCE CONFIDENCE LEVEL	DIRECT/INDIRECT INJURY
<u>OFFICIAL RECORDS</u> (1) Autopsy records with or without hospital/medical records (2) Hospital/medical records other than emergency room (e.g., discharge summary) (3) Emergency room records only (including associated X-rays or other lab reports) (4) Private physician, walk-in or emergency clinic <u>UNOFFICIAL RECORDS</u> (5) Lay coroner report (6) E.M.S. personnel (7) Interviewee (8) Other source (specify): _____ (9) Police	(1) Certain (2) Probable (3) Possible (9) Unknown	(1) Direct contact injury (2) Indirect contact injury (3) Noncontact injury (7) Injured, unknown source

INJURY SOURCES

FRONT

- (001) Windshield
- (002) Mirror
- (003) Sunvisor
- (004) Steering wheel rim
- (005) Steering wheel hub/spoke
- (006) Steering wheel (combination of codes 004 and 005)
- (007) Steering column, transmission selector lever, other attachment
- (008) Cellular telephone or CB radio
- (009) Add on equipment (e.g., tape deck, air conditioner)
- (010) Left instrument panel and below
- (011) Center instrument panel and below
- (012) Right instrument panel and below
- (013) Glove compartment door
- (014) Knee bolster
- (015) Windshield including one or more of the following: front header, A (A1/A2)-pillar, instrument panel, mirror, or steering assembly (driver side only)
- (016) Windshield including one or more of the following: front header, A (A1/A2)-pillar, instrument panel, or mirror (passenger side only)
- (017) Windshield reinforced by exterior object (specify): _____
- (019) Other front object (specify): _____

LEFT SIDE

- (051) Left side interior surface, excluding hardware or armrests
- (052) Left side hardware or armrest
- (053) Left A (A1/A2)-pillar
- (054) Left B-pillar
- (055) Other left pillar (specify): _____
- (056) Left side window glass
- (057) Left side window frame
- (058) Left side window sill
- (059) Left side window glass including one or more of the following: frame, window sill, A (A1/A2)-pillar, B-pillar, or roof side rail.
- (060) Other left side object (specify): _____

RIGHT SIDE

- (101) Right side interior surface, excluding hardware or armrests

- (102) Right side hardware or armrest
- (103) Right A (A1/A2)-pillar
- (104) Right B-pillar
- (105) Other right pillar (specify): _____
- (106) Right side window glass
- (107) Right side window frame
- (108) Right side window sill
- (109) Right side window glass including one or more of the following: frame, window sill, A (A1/A2)-pillar, B-pillar, or roof side rail.
- (110) Other right side object (specify): _____

INTERIOR

- (151) Seat, back support
- (152) Belt restraint webbing/buckle
- (153) Belt restraint B-pillar or door frame attachment point
- (154) Other restraint system component (specify): _____
- (155) Head restraint system
- (160) Other occupants (specify): _____
- (161) Interior loose objects
- (162) Child safety seat (specify): _____
- (163) Other interior object (specify): _____

AIR BAG

- (170) Air bag-driver side
- (171) Air bag-driver side and eyewear
- (172) Air bag-driver side and jewelry
- (173) Air bag-driver side and object held
- (174) Air bag-driver side and object in mouth
- (175) Air bag compartment cover-driver side
- (176) Air bag compartment cover-driver side and eyewear
- (177) Air bag compartment cover-driver side and jewelry
- (178) Air bag compartment cover-driver side and object held
- (179) Air bag compartment cover-driver side and object in mouth
- (180) Air bag-passenger side
- (181) Air bag-passenger side and eyewear
- (182) Air bag-passenger side and jewelry

- (183) Air bag-passenger side and object held
- (184) Air bag-passenger side and object in mouth
- (185) Air bag compartment cover-passenger side
- (186) Air bag compartment cover-passenger side and eyewear
- (187) Air bag compartment cover-passenger side and jewelry
- (188) Air bag compartment cover-passenger side and object held
- (189) Air bag compartment cover-passenger side and object in mouth
- (190) Other air bag (specify) _____
- (195) Other air bag compartment cover (specify) _____

ROOF

- (201) Front header
- (202) Rear header
- (203) Roof left side rail
- (204) Roof right side rail
- (205) Roof or convertible top
- (251) Floor (including toe pan)
- (252) Floor or console mounted transmission lever, including console
- (253) Parking brake handle
- (254) Foot controls including parking brake

FLOOR

- (251) Floor (including toe pan)
- (252) Floor or console mounted transmission lever, including console
- (253) Parking brake handle
- (254) Foot controls including parking brake

REAR

- (301) Backlight (rear window)
- (302) Backlight storage rack, door, etc.
- (303) Other rear object (specify): _____

ADAPTIVE (ASSISTIVE) DRIVING EQUIPMENT

- (401) Hand controls for braking/acceleration
- (402) Steering control devices (attached to OEM steering wheel)
- (403) Steering knob attached to steering wheel
- (405) Replacement steering wheel (i.e., reduced diameter)
- (406) Joy stick steering controls
- (407) Wheelchair tie-downs
- (408) Modification to seat belts, (specify): _____
- (409) Additional or relocated switches, (specify): _____
- (410) Raised roof

- (411) Wall mounted head rest (used behind wheel chair)
- (412) Other adaptive device (specify): _____

EXTERIOR OF OCCUPANT'S VEHICLE

- (451) Hood
- (452) Outside hardware (e.g., outside mirror, antenna)
- (453) Other exterior surface or tires (specify): _____
- (454) Unknown exterior objects

EXTERIOR OF OTHER MOTOR VEHICLE

- (501) Front bumper
- (502) Hood edge
- (503) Other front of vehicle (specify): _____
- (504) Hood
- (505) Hood ornament
- (506) Windshield, roof rail, A-pillar
- (507) Side surface
- (508) Side mirrors
- (509) Other side protrusions (specify): _____
- (510) Rear surface
- (511) Undercarriage
- (512) Tires and wheels
- (513) Other exterior of other motor vehicle (specify): _____
- (514) Unknown exterior of other motor vehicle

OTHER VEHICLE OR OBJECT IN THE ENVIRONMENT

- (551) Ground
- (598) Other vehicle or object (specify): _____
- (599) Unknown vehicle or object

NONCONTACT INJURY

- (601) Fire in vehicle
- (602) Flying glass
- (603) Other noncontact injury source (specify): _____
- (604) Air bag exhaust gases
- (697) Injured, unknown source

OFFICIAL INJURY DATA — SOFT TISSUE INJURIES

Restrained?

No
 Yes

Blood Alcohol Level (mg/dl)

BAL = 0
 + sertraline
 + nortriptyline

Glasgow Coma Scale Score

GCSS = NA

Units of Blood Given

Units = 0

Arterial Blood Gases

pH = —
 PO₂ = —
 PCO₂ = —
 HCO₃ = —

Indicate the Location, Specific Anatomic Structure, Detail (size, depth, fracture type, head injury clinical signs and neurological deficits), and Source of all injuries indicated by official sources (or from PAR or other unofficial sources if medical records and interviewee data are unavailable.)

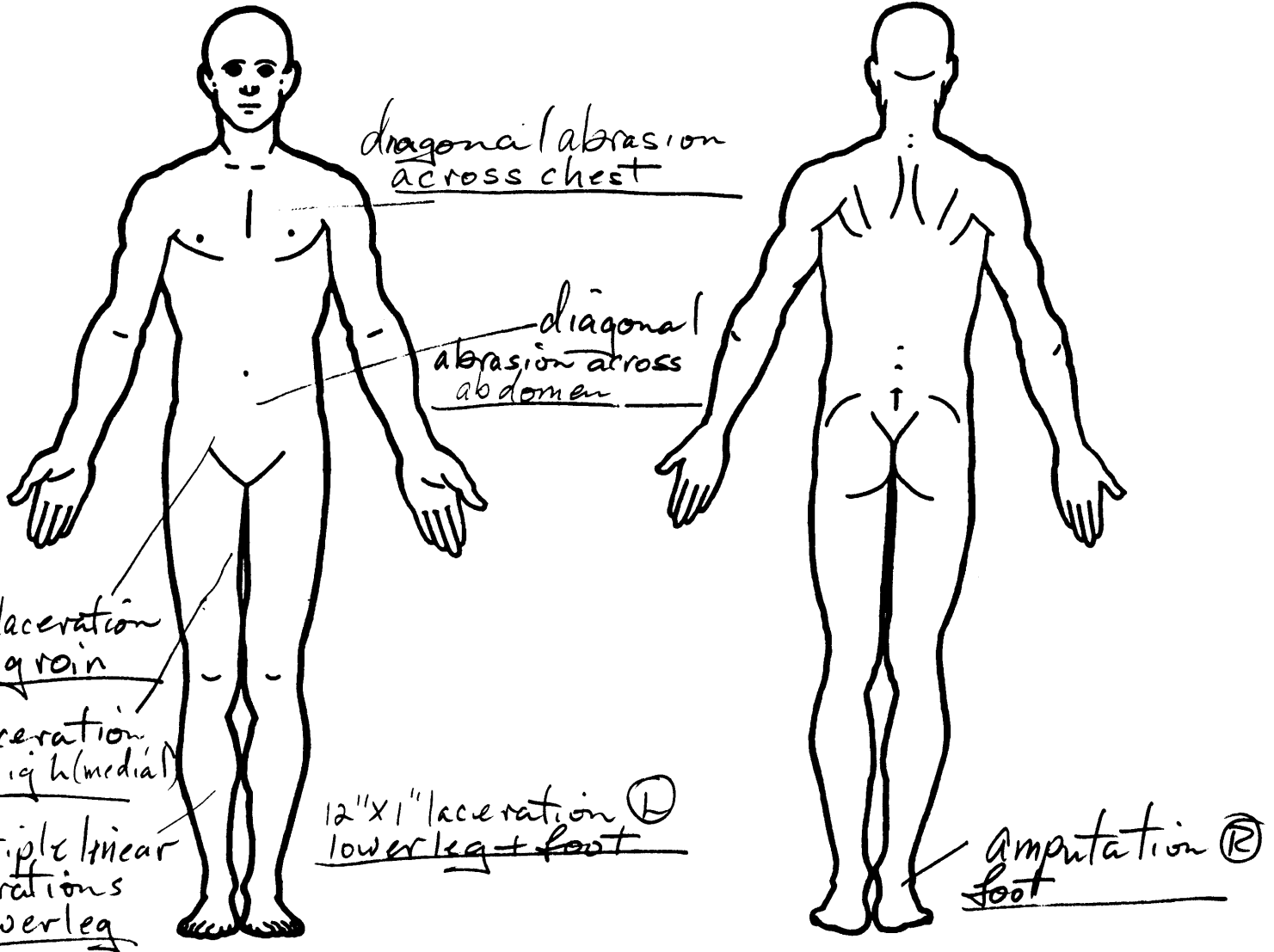

OFFICIAL INJURY DATA — SKELETAL INJURIES

Indicate the Location, Specific Anatomic Structure, Detail (size, depth, fracture type, head injury clinical signs and neurological deficits), and Source of all injuries indicated by official sources (or from PAR or other unofficial sources if medical records and interviewee data are unavailable.)

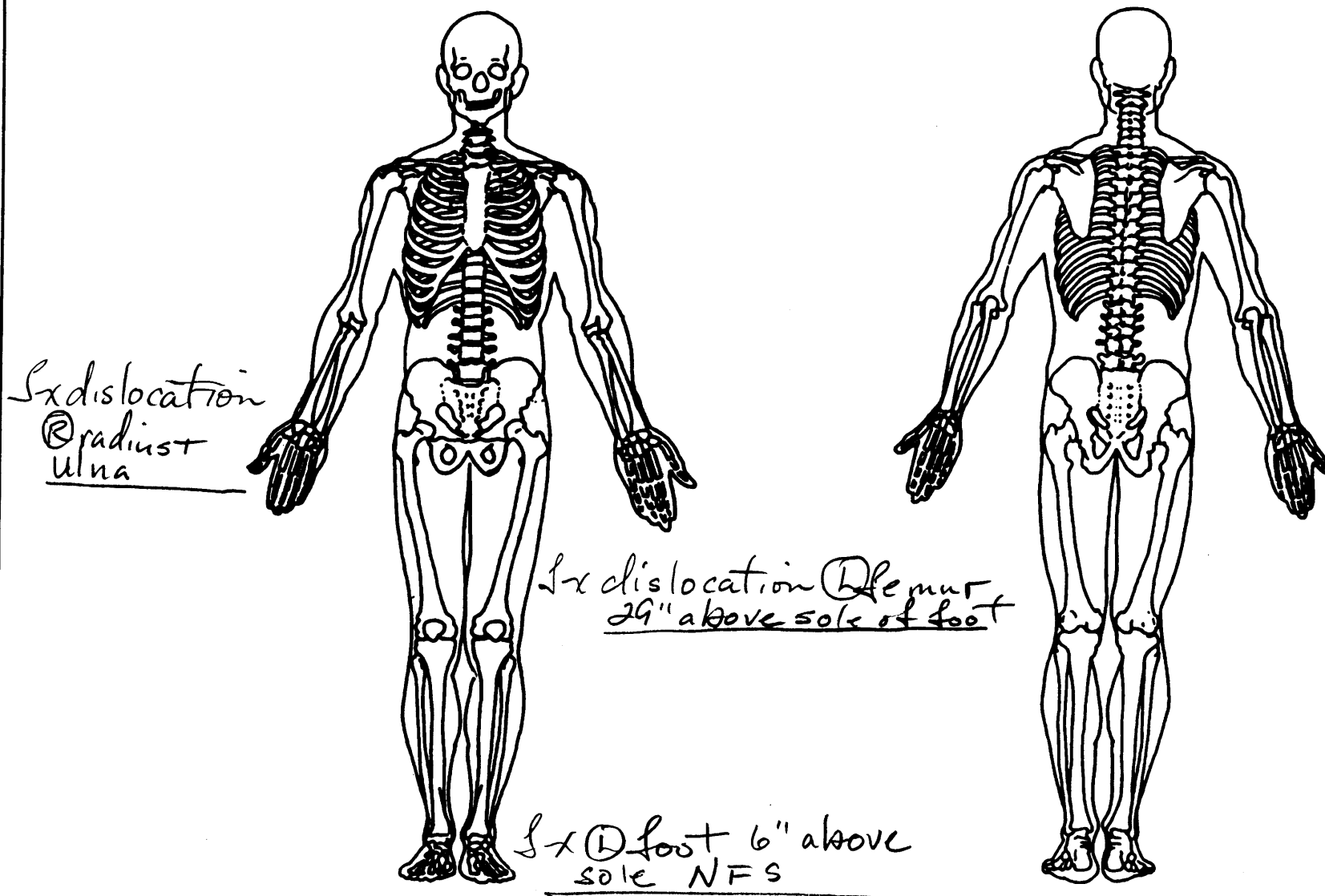

OFFICIAL INJURY DATA – INTERNAL INJURIES

Indicate the Location, Specific Anatomic Structure, Detail (size, depth, fracture type, head injury clinical signs and neurological deficits), and Source of all injuries indicated by official sources (or from PAR or other unofficial sources if medical records and interviewee data are unavailable.)

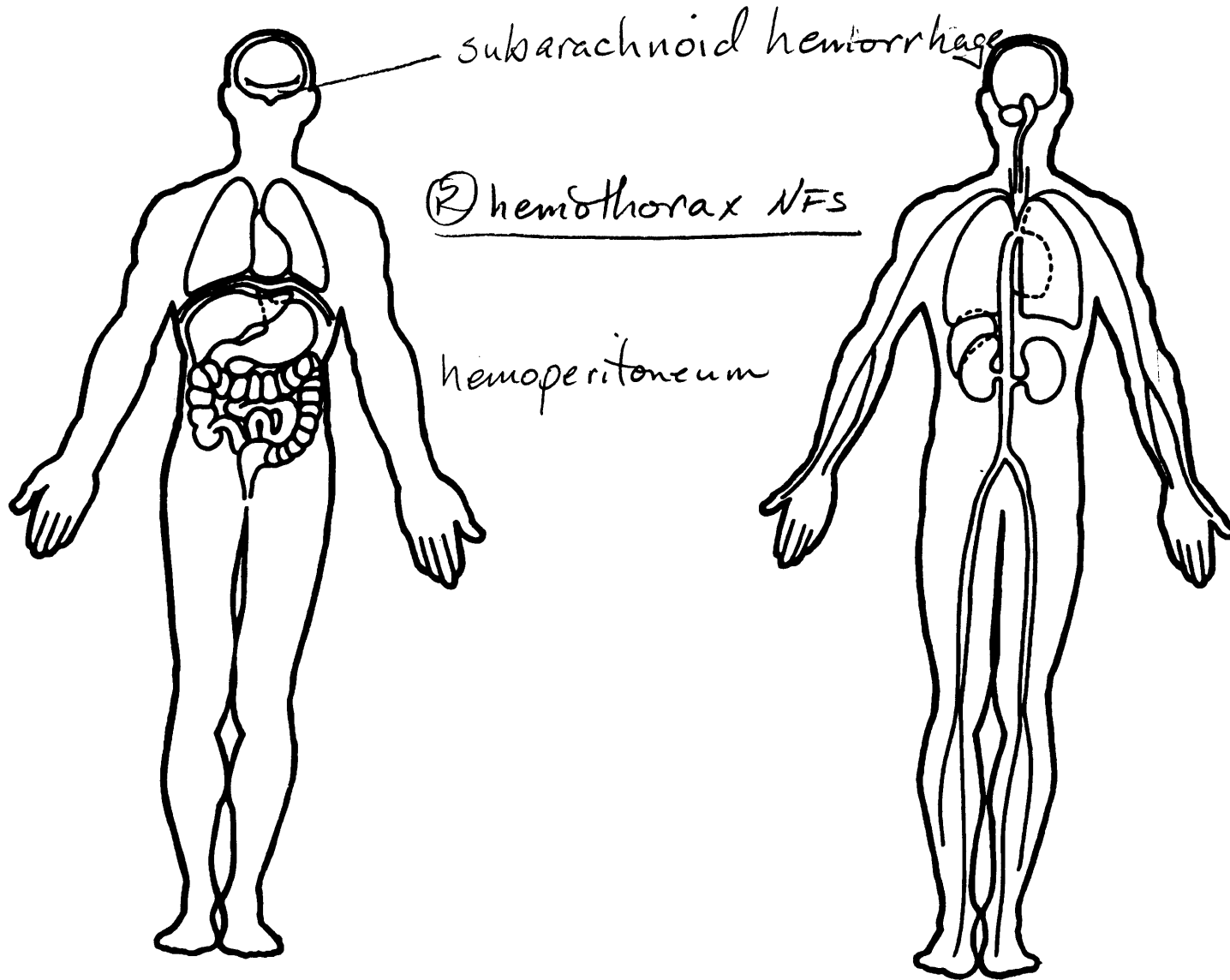



SMASH PROGRAM SUMMARY

(All Measurements In Metric)

NATIONAL ACCIDENT SAMPLING SYSTEM
CRASHWORTHINESS DATA SYSTEM

Identifying Title

48

Primary Sampling Unit

140A

Case No.-Stratum

07

Accident Event Sequence No.

[REDACTED] 96

Date (Month, day, year) of Run

GENERAL INFORMATION

VEHICLE 1

VEHICLE 2

NASS Vehicle Number

01

NASS Vehicle Number

Year

1990

Year

Make

Toyota

Make

Model

Corolla

Model

Body Style

45

Body Style

CDC

11LYAWS

CDC

Damaged Side

Damaged Side

PDOF

30 °

PDOF

± _____ °

Heading Angle

± 180 °

Heading Angle

± _____ °

VEHICLE SPECIFICATIONS

VEHICLE 1

VEHICLE 2

Wheelbase

246 cm

Wheelbase

_____ cm

Overall Length

437 cm

Overall Length

_____ cm

Overall Width

168 cm

Overall Width

_____ cm

Weight

$\frac{1050}{\text{Curb}} + \frac{102}{\text{Occupant(s)}} + \frac{11}{\text{Cargo}} = \underline{1163}$ kg

Weight

_____ + _____ + _____ = _____ kg

Engine Displacement

1.6 L

Engine Displacement

_____ L

Drive System

FWD

Drive System

Size

2

Size

Stiffness

2

Stiffness

DAMAGE INFORMATION

VEHICLE 1

VEHICLE 2

Damage known?

Y

Damage known?

Damage Length

87 cm

Damage Length

_____ cm

Damage Offset

111 cm

Damage Offset

± _____ cm

Crush Depth:

C1 56 cm

Crush Depth:

C1 _____ cm

C2 69 cm

C2 _____ cm

C3 73 cm

C3 _____ cm

C4 71 cm

C4 _____ cm

C5 62 cm

C5 _____ cm

C6 19 cm

C6 _____ cm

SCENE INFORMATION

Rest and Impact Positions: [] No [] Yes

	VEHICLE 1		VEHICLE 2		
Rest	X	_____ m	Rest	X	_____ m
Position	Y	_____ m	Position	Y	_____ m
	PSI	_____ °		PSI	_____ °
Impact	X	_____ m	Impact	X	_____ m
Position	Y	_____ m	Position	Y	_____ m
	PSI	_____ °		PSI	_____ °
Slip Angle (-180 to +180)		_____ °	Slip Angle (-180 to +180)		_____ °

VEHICLE MOTION

Sustained Contact: [] No [] Yes

Sustained Contact: [] No [] Yes

	VEHICLE 1		VEHICLE 2				
Vehicle Rotation	[] No	[] Yes	Vehicle Rotation	[] No	[] Yes		
Rotation Stop Before Rest	[] No	[] Yes	Rotation Stop Before Rest	[] No	[] Yes		
End of Rotation	X	_____ m	End of Rotation	X	_____ m		
Position	Y	_____ m	Position	Y	_____ m		
	PSI	_____ °		PSI	_____ °		
Curved Path	[] No	[] Yes	Curved Path	[] No	[] Yes		
Point on Path	X	_____ m	Point on Path	X	_____ m		
	Y	_____ m		Y	_____ m		
Rotation Direction	[] None	[] CW	[] CCW	Rotation Direction	[] None	[] CW	[] CCW
Rotation >360°	[] No	[] Yes		Rotation >360°	[] No	[] Yes	

FRICTION INFORMATION

Coefficient of Friction _____

Rolling Resistance Option 1

Vehicle 1 Rolling Resistance	Vehicle 2 Rolling Resistance
LF _____ RF _____	LF _____ RF _____
LR _____ RR _____	LR _____ RR _____

IF THIS COMMON IMPACT WAS WITH A CDS VEHICLE NOT IN TRANSPORT, FILL IN THE INFORMATION BELOW.

Model Year: _____

Make: _____

Model: _____

VIN: _____

The Weight, CDC, Scene Data and Damage Information for this vehicle should be recorded above.

Complete and ATTACH the appropriate damage sketch and dimensions to the form.



P 48 140A EVENT 7

Speed Change
(Damage)

Vehicle #1

Total 56 km/h (35 mph)
 Longitudinal -49 km/h (-30 mph)
 Latitudinal 28 km/h (17 mph)
 PDOF Angle -30 °
 Energy Dissipated = 143382 Joules (105739 Ft-Lb)
 Barrier Equivalent Speed = 56.2 km/h (34.9 mph)
 Calculated using size and stiffness categories.

Vehicle #2

Total 0 km/h (0 mph)
 Longitudinal 0 km/h (0 mph)
 Latitudinal 0 km/h (0 mph)
 PDOF Angle 0 °
 Energy Dissipated = 0 Joules (0 Ft-Lb)
 Barrier Equivalent Speed = 0.0 km/h (0.0 mph)
 Calculated using size and stiffness categories.

General Information

	Vehicle #1	Vehicle #2
Year	1996	1900
Make	TOYOTA	
Model	COROLLA	
CDC	11LYAW5	BARRIER
Side Damaged	L	
PODF Angle	-30 °	0 °
Heading Angle	180 °	0 °

Calculation method:	Size and Stiffness	Size and Stiffness
Size Category	2	11
Stiffness Category	2	11
Vehicle Weight	1163 kgs (2564 lbs)	453592 kgs (999999 lbs)

Damage Information

Vehicle Damage Known	Vehicle #1	Vehicle #2
	Yes	Yes
Crush Length	87.0 cm (34 in)	0.0 cm (0 in)
C1	56.0 cm (22 in)	0.0 cm (0 in)
C2	69.0 cm (27 in)	0.0 cm (0 in)
C3	73.0 cm (29 in)	0.0 cm (0 in)
C4	71.0 cm (28 in)	0.0 cm (0 in)
C5	62.0 cm (24 in)	0.0 cm (0 in)
C6	19.0 cm (7 in)	0.0 cm (0 in)
D	111.0 cm (44 in)	0.0 cm (0 in)
D'	108.1 cm (43 in)	0.0 cm (0 in)

Vehicle Dimensions

	Vehicle #1	Vehicle #2
Length	437.0 cm (172 in)	0.0 cm (0 in)
Width	168.0 cm (66 in)	0.0 cm (0 in)
Wheelbase	246.0 cm (97 in)	254.0 cm (100 in)
Weight	1163 kgs (2564 lbs)	453592 kgs (999999 lbs)
CG to Front of Veh	211.6 cm (83 in)	127.0 cm (50 in)
Engine Displacement	1.6 liters	0.0 liters
Moment of Inertia	200651 kgs (17760 lbs)	29375740821 kgs (2600101632 lbs)
Vehicle Mass	1163 kgs (6.7 lb-s ² /in)	453515 kgs (2600.1 lb-s ² /in)

1996 TOYOTA COROLLA

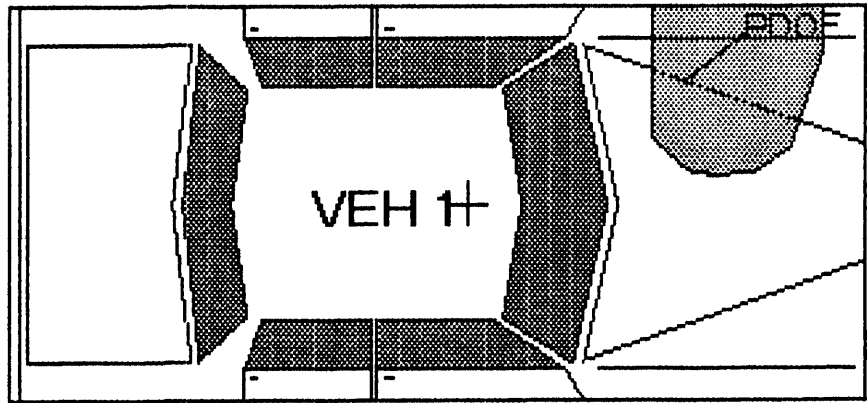

FORM NAME	NUMBER OF DOLLAR SIGNS	NUMBER OF LEVEL 1 ERRORS	NUMBER OF LEVEL 2 ERRORS	VERSION NUMBER CONSISTENT
Accident	0	0	0	Y
General Vehicle	0	0	0	Y
Vehicle Exterior	0	0	0	Y
Vehicle Interior	0	0	0	Y
Occupant Assessment	0	0	0	Y
Occupant Injury	0	0	0	Y
Total Inter Errors		0	0	
Total Case Errors	0	0	0	

0



SLIDE INDEX

Primary Sampling Unit Number 4 8

Case Number—Stratum 1 4 0 A

Slide No.	Vehicle No.	Direction of Picture	Description of Slide Subject Matter
1-5	1	S	Path of travel as V1 leaves road.
6-25	1	S	Continued path as V1 travels through grass and bushes, striking several small trees.
26-28	1	S	Continued path to POI with large tree.
29-31	1	SW/W	V1 rotates clockwise around tree to final rest.
32	1	N	Lookback from final rest.
33	1	N	Lookback from POI with tree.
34-40	1	N	Opposite path of travel.
41-76	1		Exterior.
77-107	1		Interior.



PSU 48-140A (1996) #1



PSU 48-140A (1996) #2



PSU 48-140A (1996) #3



PSU 48-140A (1996) #4



PSU 48-140A (1996) #5



PSU 48-140A (1996) #6



PSU 48-140A (1996) #7



PSU 48-140A (1996) #8



FSU 46-140A (1996) #9



PSU 48-140A (1996) #10



PSU 48-140A (1996) #11



PSU 48-140A (1996) #12



PSU 48-140A (1996) #13



PSU 48-140A (1996) #14



PSU 48-140A (1996) #15



PSU 48-140A (1996) #16



PSU 48-140A (1996) #17



PSU 48-140A (1996) #18



PSU 48-140A (1996) #19



PSU 48-140A (1996) #20
Best Available



PSU 48-140A (1996) #21
Best Available



PSU 48-140A (1996) #22



PSU 48-140A (1996) #23

Best Available



PSU 48-140A (1996) #24
Best Available



PSU 48-140A (1996) #25



PSU 48-140A (1996) #26
Best Available



PSU 48-140A (1998) #27
Best Available



PSU 48-140A (1996) #28
Best Available



PSU 48-140A (1996) #29
Best Available



PSU 48-140A (1998) #30
Best Available



PSU 48-140A (1996) #31
Best Available



PSU 48-140A (1996) #32
Best Available



PSU 48-140A (1998) #33
Best Available



PSU 48-140A (1998) #34



PSU 48-140A (1996) #35



PSU 48-140A (1996) #36



PSU 48-140A (1996) #37



PSU 48-140A (1996) #38



PSU 48-140A (1996) #39



PSU 48-140A (1996) #40



PSU 48-140A (1996) #41



PSU 48-140A (1996) #42



PSU 48-140A (1996) #43



PSU 48-140A (1996) #44



PSU 48-140A (1996) #45
Best Available



PSU 48-140A (1996) #48
Best Available



**PSA 48-140A (1998) #47
Best Available**



PSU 48-140A (1996) #48
Best Available



FSU 48-140A (1996) #49
Best Available



PSU 48-140A (1996) #50
Best Available



PSU 48-140A (1996) #51



PSU 48-140A (1996) #52
Best Available



**PSU 48-140A (1996) #53
Best Available**



PSU 48-140A (1996) #54
Best Available



PSU 48-140A (1996) #55
Best Available



PSU 48-140A (1996) #56
Best Available



PSU 48-140A (1996) #57
Best Available



PSU 48-140A (1996) #58
Best Available



PSJ 48-140A (1996) #69
Best Available



PSU 48-140A (1998) #60
Best Available



PSU 48-140A (1996) #61



PSU 48-140A (1996) #62



PSU 48-140A (1996) #63



PSU 48-140A (1996) #64



PSU 48-140A(1996) #65



PSU 48-140A (1996) #66



PSU 48-140A (1998) #67
Best Available



PSU 48-140A (1996) #68
Best Available



PSU 48-140A (1996) #69
Best Available



PSU 48-140A (1996) #70
Best Available



PSU 48-140A (1996) #71
Best Available



PSU 48-140A (1998) #72



PSU 48-140A (1996) #73



PSU 48-140A (1996) #74
Best Available



PSU 48-140A (1996) #75
Best Available



PSU 48-140A (1995) #76
Best Available



FSU 48-140A (1998) #77



PSU 48-140A (1986) #78



PSU 48-140A (1986) #79



PSU 48-140A (1996) #80
Best Available



PSU 48-140A (1996) #81
Best Available



PSU 48-140A (1996) #82
Best Available



PSU 48-140A (1996) #83
Best Available



PSU 48-140A (1996) #84
Best Available



PSU 48-140A (1996) #85



PSU 48-140A (1996) #86



PSU 48-140A (1996) #87
Best Available



PSU 48-140A (1996) #88
Best Available



PSU 46-140A (1996) #89
Best Available



PSU 48-140A (1996) #90
Best Available



PSU 48-140A (1996) #91



PSU 48-140A (1998) #92



PSU 48-140A (1996) #93



PSU 48-140A (1996) #94



PSU 48-140A (1996) #95



PSU 48-140A (1996) #96
Best Available



PSU 48-140A (1996) #97
Best Available



PSU 48-140A (1996) #96



PSU 48-140A (1996) #99



PSU 4B-140A (1996) #100



PSU 48-140A (1986) #101



PSU 48-140A (1996) #102
Best Available



PSU 48-140A (1986) #103



PSU 48-140A (1996) #104
Best Available



PSU 48-140A (1996) #105
Best Available



FSU 48-140A (1996) #106
Best Available



PSU 48-140A (1998) #107
Best Available