

Facilities for the Future of Science

A Twenty-Year Outlook

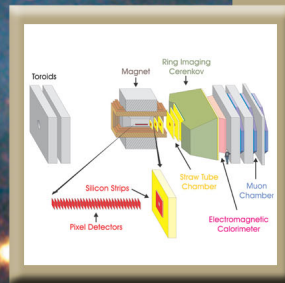
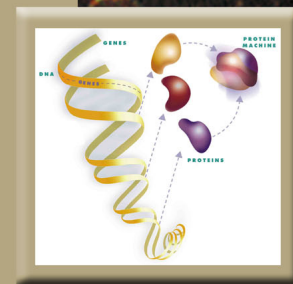
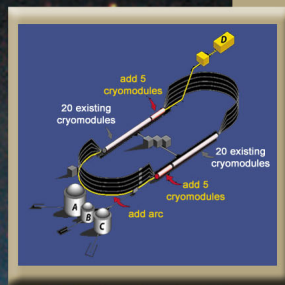
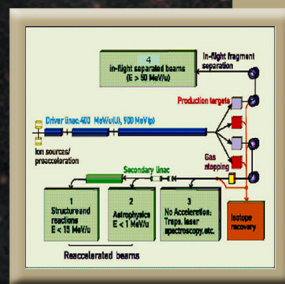
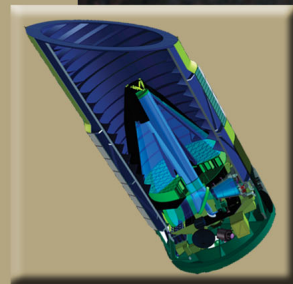
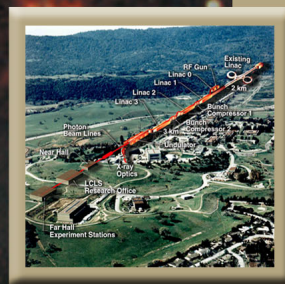
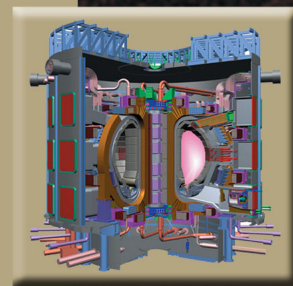

**Office of
Science**

U.S. DEPARTMENT OF ENERGY

Facilities for the Future of Science:

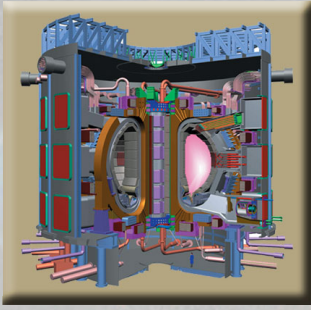

ITER



UltraScale Scientific Computing Capability



Joint Dark Energy Mission



Linac Coherent Light Source



Protein Production and Tags

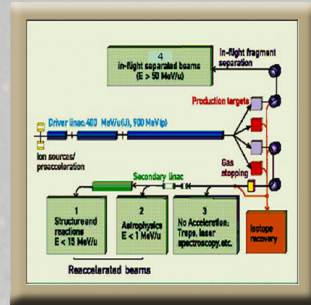

Rare Isotope Accelerator

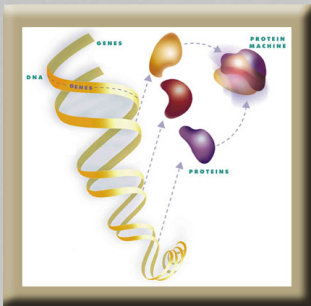

Characterization and Imaging Molecular Machines

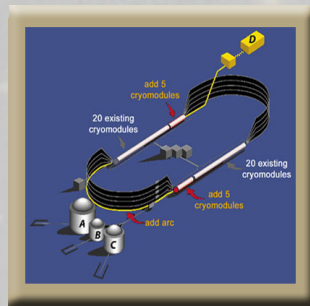

CEBAF 12 GeV Upgrade



ESnet Upgrade



NERSC Upgrade



Transmission Electron Achromatic Microscope

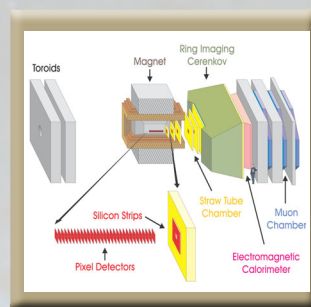

BTev



Linear Collider



Analysis and Modeling of Cellular Systems

A Twenty-Year Outlook



Spallation Neutron Source
2-4 MW Upgrade



Spallation Neutron Source
Second Target Station

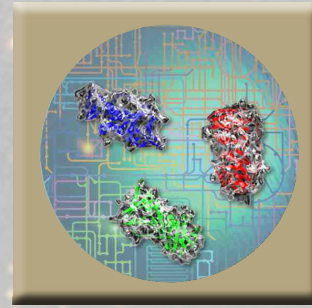

Whole Proteome Analysis

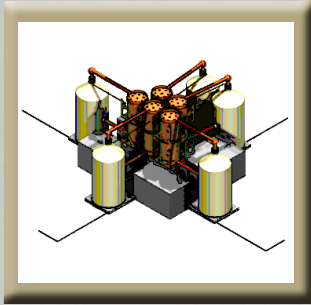

Double Beta Decay
Underground Detector

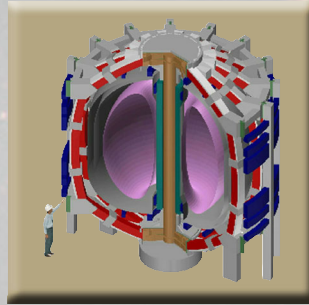

Next-Step Spherical Torus



RHIC II



National Synchrotron
Light Source Upgrade

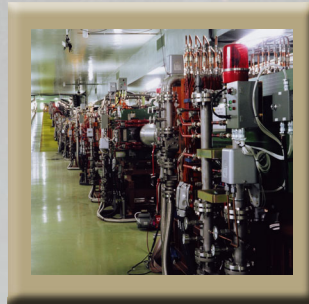

Super Neutrino Beam

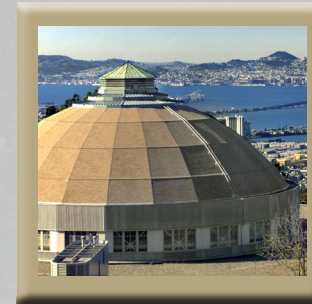

Advanced Light Source Upgrade



Advanced Photon
Source Upgrade

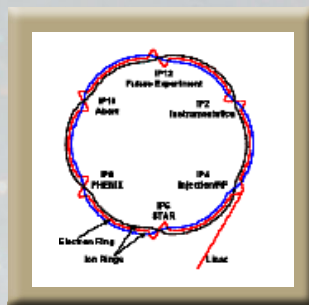

eRHIC

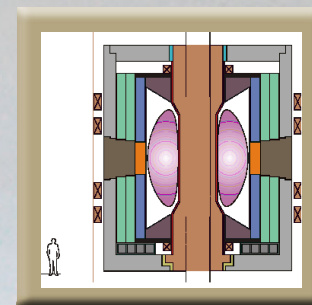

Fusion Energy Contingency



HFIR Second Cold Source
and Guide Hall

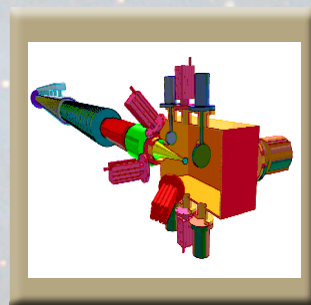

Integrated Beam Experiment

Facilities for the Future of Science: A Twenty-Year Outlook

Contents

A Message from the Secretary	3
Steward of the World’s Finest Suite of Scientific Facilities and Instruments	5
Introduction	8
Prioritization Process	9
A Benchmark for the Future	10
The Twenty-Year Facilities Outlook—A Prioritized List	11
Facility Summaries	14
Near-Term Priorities	14
Priority: 1 ITER	14
Priority: 2 UltraScale Scientific Computing Capability (USSCC)	15
Priority: Tie for 3 Joint Dark Energy Mission (JDEM)	16
Linac Coherent Light Source (LCLS)	16
Protein Production and Tags	17
Rare Isotope Accelerator (RIA)	18
Priority: Tie for 7 Characterization and Imaging of Molecular Machines	19
Continuous Electron Beam Accelerator Facility (CEBAF) 12 GeV Upgrade	20
Energy Sciences Network (ESnet) Upgrade	20
National Energy Research Scientific Computing Center (NERSC) Upgrade	21
Transmission Electron Achromatic Microscope (TEAM)	22
Priority: 12 BTeV	23
Mid-Term Priorities	24
Priority: 13 Linear Collider	24
Priority: Tie for 14 Analysis and Modeling of Cellular Systems	24
Spallation Neutron Source (SNS) 2-4MW Upgrade	25
Spallation Neutron Source (SNS) Second Target Station	26
Whole Proteome Analysis	27
Priority: Tie for 18 Double Beta Decay Underground Detector	27
Next-Step Spherical Torus (NSST) Experiment	28
Relativistic Heavy Ion Collider (RHIC) II	29
Far-Term Priorities	30
Priority: Tie for 21 National Synchrotron Light Source (NSLS) Upgrade	30
Super Neutrino Beam	30
Priority: Tie for 23 Advanced Light Source (ALS) Upgrade	31
Advanced Photon Source (APS) Upgrade	32
eRHIC	32
Fusion Energy Contingency	33
High-Flux Isotope Reactor (HFIR) Second Cold Source and Guide Hall	34
Integrated Beam Experiment (IBX)	35
Appendix: Sample Charge Letter to Advisory Committees	36
Office of Science Advisory Committees	38
About DOE’s Office of Science	42
Office of Science Contacts	43

A Message from the Secretary

Throughout its history, the Department of Energy's Office of Science has designed, constructed, and operated many of the Nation's most advanced, large-scale research and development user facilities, of importance to all areas of science. These state-of-the-art facilities are shared with the science community worldwide and contain technologies and instrumentation that are available nowhere else. Each year, these facilities are used by more than 18,000 researchers from universities, other government agencies, private industry, and foreign nations.

Located at national laboratories and universities around the country, these facilities include the world's first linear collider, synchrotron light sources, the superconducting Tevatron high-energy particle accelerator, the Relativistic Heavy Ion Collider, neutron scattering facilities, a Tokamak fusion test reactor, supercomputers, and high-speed computer networks.

In Congressional testimony he presented in July 2003, Dr. Hermann A. Grunder, Director of the Argonne National Laboratory, explained the importance of these Department of Energy facilities:

These user facilities provide resources ... that speed up experiments by orders of magnitude and open up otherwise inaccessible facets of nature to scientific inquiry. Many of the important discoveries made in the physical sciences in the second half of the twentieth century were made at—or were made possible by—user facilities. Moreover, most of these user facilities, which were justified and built to serve one scientific field in the physical sciences, have made significant contributions to knowledge and technology in many other fields, including biology and medicine.



"These Department of Energy facilities are used by more than 18,000 researchers from universities, other government agencies, private industry, and foreign nations."

*—Secretary of Energy
Spencer Abraham*

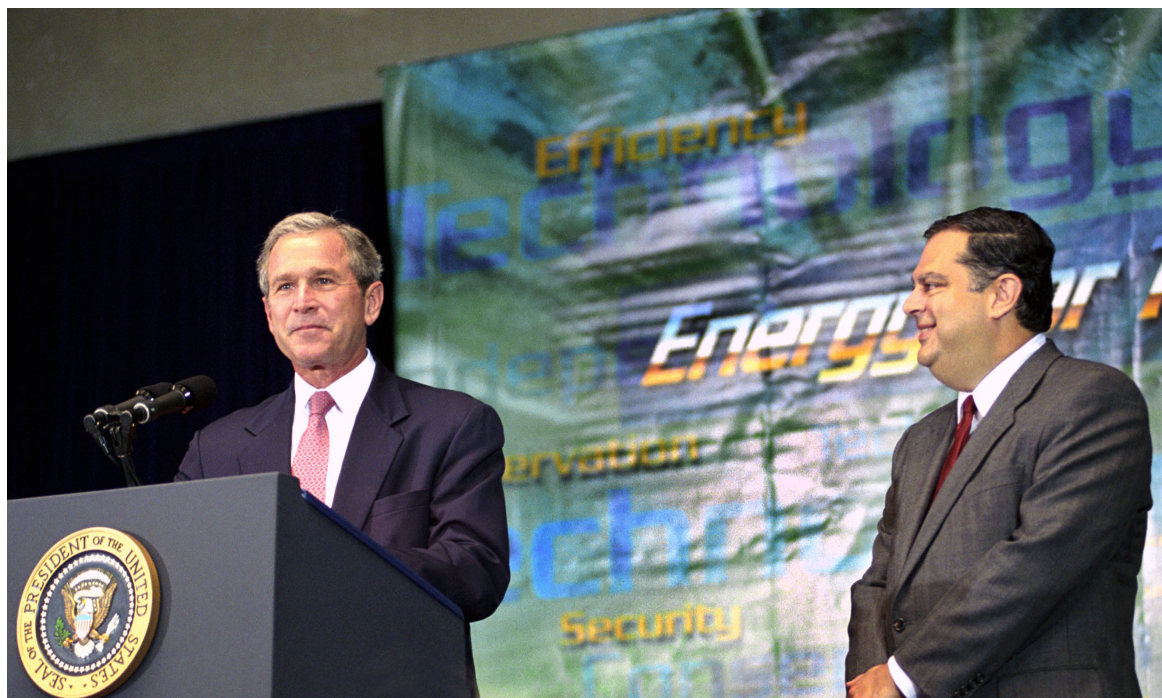



The Spallation Neutron Source, currently being built at Oak Ridge National Laboratory, will provide the most intense pulsed neutron beams in the world for scientific research and industrial development. Construction will be completed in 2006.

“These additional world-class DOE Office of Science user facilities and upgrades to current facilities will lead to more world-class science, which will lead to further world-class R&D, which will lead to greater technological innovation and many other advances, which will lead to continued U.S. economic competitiveness.”

—Secretary of Energy
Spencer Abraham

Today, for example, the Department of Energy is building the Spallation Neutron Source (SNS), in Oak Ridge, Tennessee. When the SNS is completed in 2006, the facility may yield such advances as lubricants for tomorrow’s more efficient car engines; superconducting wires and stronger magnets that will lower power costs; and stronger, lighter materials for improved products.

But the SNS also is the last, large-scale Department of Energy user facility under construction. And that raises the question that *Facilities for the Future of Science: A Twenty-Year Outlook* addresses: What facilities are needed next for scientific discovery?

The process we have followed to produce this document has been transparent and interdisciplinary. It anticipates the large-scale facilities that scientists will require across all fields of science supported by the Department of Energy over the next two decades, and it is informed by the counsel of the six

Office of Science Advisory Committees. I am confident that the Department of Energy, the scientific community, the American public, and the world will reap enormous benefits when the 28 new user facilities identified finally are constructed and in operation.

Estimates are that fully half of the growth in the U.S. economy in the last 50 years was due to Federal funding of scientific and technological innovation. American taxpayers have received great value for their investment in the basic research sponsored by DOE’s Office of Science and other Federal science agencies.

As the steward of America’s national laboratories, the Department of Energy has a special responsibility to plan for and propose Office of Science investments for the future that will serve to advance the national, energy, and economic security of the United States.

These additional world-class Office of Science user facilities and upgrades to current facilities will lead to more world-class science, which will lead to further world-class R&D, which will lead to greater technological innovation and many other advances, which will lead to continued U.S. economic competitiveness.

That is why I am proud to present *Facilities for the Future of Science: A Twenty-Year Outlook*.

Spencer Abraham
Secretary of Energy
November 2003

Steward of the World's Finest Suite of Scientific Facilities and Instruments

The Department of Energy's Office of Science is heir to the revolutionary work of Albert Einstein, Enrico Fermi, and E. O. Lawrence.

DOE Science makes history every day because we sustain their tradition of innovative basic scientific research that improves people's lives.

We manage 10 of America's national laboratories, the backbone of American science. We also build and operate the world's finest suite of scientific facilities and instruments that researchers depend on to extend the frontiers of science. (Our current major user facilities are listed below and at the bottom of the next two pages.)

At these facilities and laboratories—and at universities in virtually every state—DOE's Office of Science supports basic research in such diverse fields as materials sciences, chemistry, high energy and nuclear physics, fusion energy, biology, advanced computation, and environmental sciences.

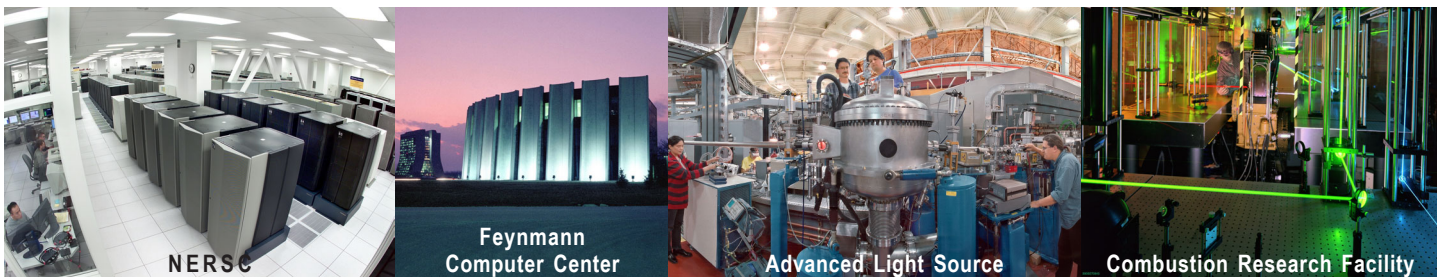
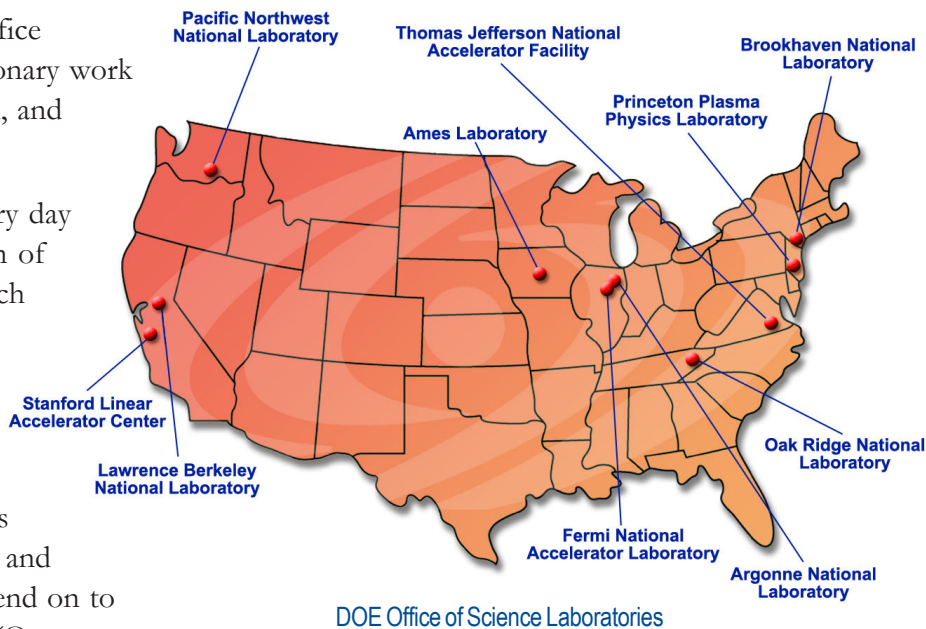

DOE Office of Science User Facilities

The following is a list of the current major user facilities maintained and operated by DOE's Office of Science. The facilities are listed by program offices.

For more information about all these facilities, please go to the Office of Science website, www.science.doe.gov, and choose "National Labs and User Facilities" on the top navigation bar.

Advanced Scientific Computing Research

- ♦ Energy Sciences Network (ESnet)
- ♦ National Energy Research Scientific Computing (NERSC) Center

Basic Energy Sciences Synchrotron Radiation Light Sources

- ♦ National Synchrotron Light Source (NSLS)
- ♦ Stanford Synchrotron Radiation Laboratory (SSRL)

- ♦ Advanced Light Source (ALS)
- ♦ Advanced Photon Source (APS)

High-Flux Neutron Sources

- ♦ High Flux Isotope Reactor (HFIR) Center for Neutron Scattering
- ♦ Intense Pulsed Neutron Source (IPNS)
- ♦ Manuel Lujan Jr. Neutron Scattering Center

DOE's Office of Science maintains our Nation's scientific infrastructure and ensures U.S. world leadership across a broad range of scientific disciplines. The Office of Science funds basic research in support of the Department's missions of national, economic, and energy security, scientific and technological innovation, and environmental clean up.

Over the years, DOE Office of Science research investments have yielded a wealth of dividends.

Since the 1940s, DOE has supported the work of more than 70 Nobel Prize winners, testimony to the high quality and impact of the work we underwrite.

Research funded by DOE's Office of Science also has produced many key scientific breakthroughs and contributed to our Nation's well-being.



DOE's Office of Science:

- ◆ Sponsored research leading to Nobel Prize-winning insights into the fundamental nature of matter and energy—and the discovery of a new form of carbon that is spurring a revolution in carbon chemistry;
- ◆ Initiated the Human Genome Project and developed DNA sequencing and computational technologies that made it possible to finish the “book of life” in April 2003;
- ◆ Launched the Climate Change Research Program;
- ◆ Enhanced national and homeland security by developing several technologies that detect nuclear weapons, explosives, narcotics, and chemical and biological agents; and
- ◆ Helped develop new tools for the non-invasive diagnosis and treatment of disease, including PET scans, MRIs and nuclear medicine cancer therapies.

Virtually all these advances and benefits have been made possible by the DOE Office of Science's major user facilities.

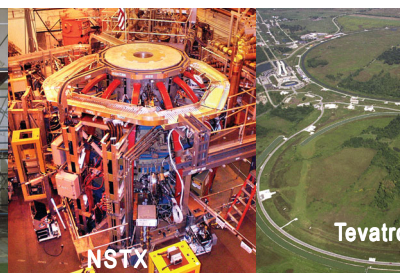
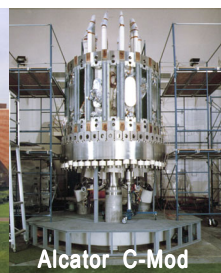
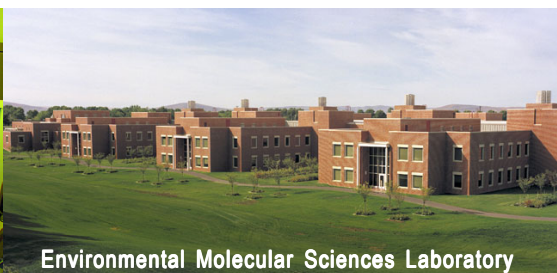

Electron Beam Microcharacterization Centers

- ◆ Center for Microanalysis of Materials (CMM)
- ◆ Electron Microscopy Center (EMC) for Materials Research
- ◆ National Center for Electron Microscopy (NCEM)
- ◆ Shared Research Equipment (SHaRE) Program

Specialized Single-Purpose Centers

- ◆ Combustion Research Facility (CRF)
- ◆ Materials Preparation Center (MPC)
- ◆ James R. Macdonald Laboratory (JMRL)
- ◆ Pulse Radiolysis Facility

Biological and Environmental Research

- ◆ William R. Wiley Environmental Molecular Sciences Laboratory (EMSL)
- ◆ Joint Genome Institute (JGI)
- ◆ Atmospheric Radiation Measurement (ARM)
- ◆ Free Air CO₂ Enrichment (FACE)
- ◆ Structural Biology Center (SBC)

Today DOE's Office of Science is pursuing several important and promising research opportunities:

- ♦ Restoring U.S. leadership in scientific computation;
- ♦ Helping to train a scientifically literate workforce for the 21st Century;
- ♦ Pioneering nanoscale science, the study of matter at the atomic scale;
- ♦ Employing genetic techniques to harness microbes that can eat pollution, create hydrogen, and absorb carbon dioxide;
- ♦ Working to solve the mysteries of "dark energy," apparently responsible for the astounding recent finding that the expansion of the universe is accelerating;
- ♦ Promoting the availability of fusion power—and representing the U.S. in the ITER talks to pursue the promise of fusion as an inexhaustible, safe, and environmentally attractive energy source; and
- ♦ Using advances in materials sciences to help blind people regain sight with an artificial retina—technology that may be adapted to help persons with spinal cord injuries, Parkinson's disease, deafness, and almost any disease associated with the body's electrical system.

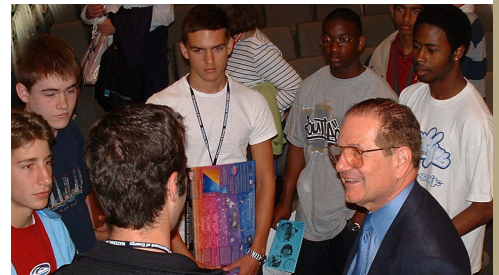
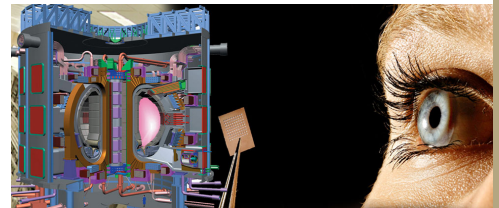
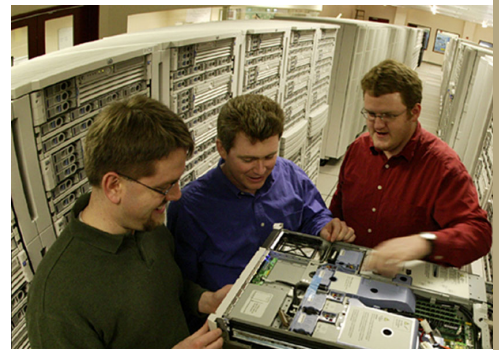

Working at DOE's labs and using our world-class facilities, men and women with extraordinary talent and dedication have done great science leading to great public benefits.

Investments in new and upgraded scientific facilities and instruments will continue to pay off for us all.



Fusion Energy Sciences

- ♦ DIII-D Tokamak Facility
- ♦ Alcator C-Mod
- ♦ National Spherical Torus Experiment (NSTX)

High Energy Physics

- ♦ Tevatron Collider
- ♦ Main Injector
- ♦ Booster Neutrino Experiment (BooNE)

- ♦ Neutrinos at the Main Injector (NuMI)
- ♦ B-Factory
- ♦ Next Linear Collider Test Accelerator (NLCTA)
- ♦ Final Focus Test Beam (FFTB)
- ♦ Accelerator Test Facility (ATF)

Nuclear Physics

- ♦ Relativistic Heavy Ion Collider (RHIC)
- ♦ Continuous Electron Beam Accelerator Facility (CEBAF)

- ♦ Bates Linear Accelerator Center
- ♦ Holifield Radioactive Ion Beam Facility (HRIBF)
- ♦ Argonne Tandem Linear Accelerator System (ATLAS)
- ♦ Triangle Universities Nuclear Laboratory (TUNL)
- ♦ Texas A&M Cyclotron Institute
- ♦ University of Washington Tandem Van de Graaff
- ♦ The Yale University Tandem Van de Graaff

Introduction

There can be no doubt that a modern and effective research infrastructure is critical to maintaining U.S. leadership in science and engineering. New tools have opened vast research frontiers and fueled technological innovation in fields such as biotechnology, nanotechnology, and communications. The degree to which infrastructure is regarded as central to experimental research is indicated by the number of Nobel Prizes awarded for the development of new instrument technology. During the past twenty years, eight Nobel prizes in physics were awarded for technologies such as the electron and scanning tunneling microscope, laser and neutron spectroscopy, particle detectors, and the integrated circuit.

— National Science Board, December 2002

The health and vitality of U.S. science and technology depends upon the availability of the most advanced research facilities. The U.S. Department of Energy (DOE) leads the world in the conception, design, construction, and operation of these large-scale devices. These machines have enabled U.S. researchers to make some of history's important scientific discoveries, with spin-off technological advances leading to entirely new industries.

More than 18,000 researchers and their students from universities, other government agencies (including National Science Foundation and National Institutes of Health), private industry, and abroad use DOE facilities each year. Almost half (49 percent) are scientists from universities, 21 percent are from DOE laboratories, another 21 percent are from foreign research institutions, 5 percent are from industry, and 2 percent are from other U.S. Government agencies. These users are both growing in number and diversifying. Light sources, giant machines that serve as "microscopes" allowing scientists to investigate materials at the atomic level, for example, were until very recently the province of chemical and materials science specialists. Today, these facilities support a full spectrum of scientific endeavor, serving 20 times as many users from the life sciences community as they did in 1990, representing a full 40 percent of the total user community at these facilities.

The opportunities available to U.S. scientists from some of our most powerful large-scale facilities arose from a plan developed by Dr. Alvin W. Trivelpiece, who led DOE's science office from 1981 to 1987. The last facility resulting from that plan, the Spallation Neutron Source, will be finished in 2006, some 20 years after its introduction.

DOE has picked up where the Trivelpiece plan left off by issuing a *Facilities for the Future of Science: A Twenty-Year Outlook* that provides a prioritized list of major scientific facilities for the next 20 years. The *Twenty-Year Outlook* benefitted from discussions with the White House Office of Science and Technology Policy, the Office



Klystron Gallery at the Office of Science's Stanford Linear Accelerator Center (SLAC):

The world's largest electron accelerator and one of the longest buildings on Earth.

of Management and Budget, and members of Congress, and from the assistance of the U.S. scientific community as represented through the Office of Science Advisory Committees.

The breadth of science supported by the Office of Science is as large as science itself, spanning high energy and nuclear physics, condensed matter science, fusion energy, biology and environmental science, and advanced scientific computation. Choosing major facilities is one of the most important activities of the DOE's Office of Science. It requires prioritization across fields of science, a difficult and unusual process. The set of facilities must be phased to conform to scientific opportunities, and to a responsible funding strategy. The largest facilities will be international in character, requiring both planning and funding from other countries and organizations, together with the U.S.

Prioritization Process

The DOE's Office of Science began to prioritize future major facilities in the fall of 2002. The Associate Directors of the Office of Science⁽¹⁾ were asked to list major facilities required for world scientific leadership in their respective programs out to 2023. In order to impose some fiscal discipline on this exercise, each Associate Director was given a funding "envelope" under which they were to include their estimated research budgets as well as the major facility planning, construction, and operating costs.⁽²⁾

Forty-six facilities were identified and phased to conform to perceived scientific opportunities over this 20-year period. Internal hearings were held, with each Associate Director describing the nature of the recommended facilities, together with the scientific rationale behind their choices. This process was completed in December 2002.

The program prioritizations by the Associate Directors were then submitted in mid-January 2003 to the respective program's Advisory Committee, with a request for an analysis of the relative scientific opportunities associated with each of the facilities proposed by their respective Associate Director, and with any additions they felt important that may have been omitted (a sample Advisory Committee charge letter is attached as Appendix A). In some cases, the Committees were requested specifically to work together to capture the interdisciplinary needs that might be missed if a Committee focused too narrowly on its own traditional discipline. The Office of Science Advisory Committees are chartered to bring to each program the full breadth of perspectives of the U.S. scientific community. Of the 118 people that sit on these Advisory Committees, 64 percent are from universities, 15 percent from DOE laboratories, 10 percent from industry, 3 percent from other government agencies, and 8 percent from other types of institutions.

(1) The Office of Science has an Associate Director for each of its scientific programs: Advanced Scientific Computing Research, Biological and Environmental Research, Basic Energy Sciences, Fusion Energy Sciences, High Energy Physics, and Nuclear Physics.

(2) These envelopes were constructed from the "Biggert Bill" authorization levels for the Office of Science for FY 2004 through FY 2008 (since replaced by H.R. 6 and S. 14), and then a four percent increase in authorization level each subsequent year until 2023. The Office of Science understands that construction of the facilities listed within the envelopes will depend on many factors, including funding being available as needed with all technology hurdles surmounted as planned. Nevertheless, the envelopes, and the facilities listed within them, are consistent with a far-reaching vision of how and when the Office of Science could contribute to DOE's missions and the Nation.

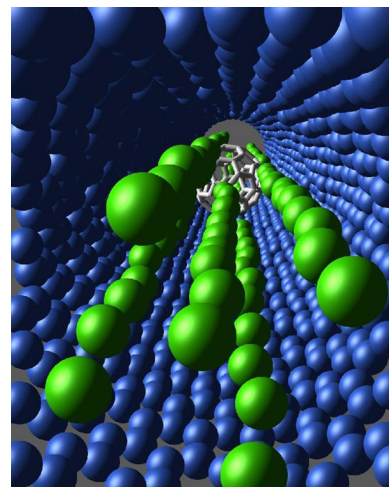

Nanomachines: Computer simulation of a buckyball piston. The Basic Energy Sciences program applies some of its facilities to the challenges of science at the nanoscale.

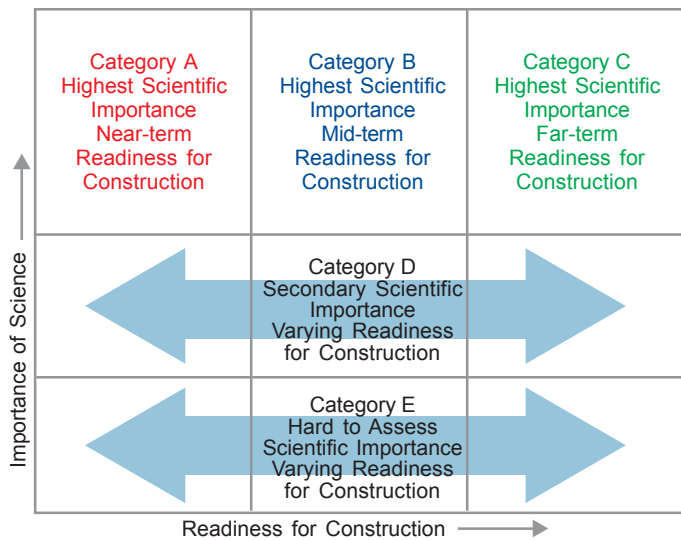

Office of Science Facilities Matrix

The Advisory Committees recommended 53 major facilities for construction, and assessed each according to two criteria: scientific importance and readiness for construction. Against the first criteria, the Committees divided their facilities into three categories: highest scientific importance, secondary scientific importance, and hard-to-assess scientific importance. The Committees also categorized the facilities into “near-term,” “mid-term,” and “far-term” according to their readiness for construction.

The results were plotted in a matrix illustrated at left. “Highest scientific importance” was divided into categories A, B, and C, depending upon readiness for construction. “Secondary scientific importance” was labeled as category D, and “hard-to assess scientific importance” as category E.

With this input from the Advisory Committees, the challenge remained to prioritize the facilities across scientific disciplines⁽³⁾. The Director of the Office of Science addressed this challenge by prioritizing the 53 facilities according to his assessment of their scientific promise and their fit with the Department’s missions. The costs associated with the Office of Science’s base research programs and the other responsibilities were added, and the entirety was made to fit under an aggressive funding envelope (see footnote 2) extended through 2023. Twenty-eight projects qualified.

A Benchmark for the Future

The *Facilities for the Future of Science: A Twenty-Year Outlook* represents a snapshot—the DOE Office of Science’s best guess today at how the future of science and the need for scientific facilities will unfold over the next two decades. We know, however, that science changes. Discoveries will alter the course of research and so the facilities needed in the future.

For this reason, the *Facilities for the Future of Science: A Twenty-Year Outlook* should be assessed periodically in light of the evolving state of science and technology. The *Twenty-Year Outlook* will also serve as a benchmark, enabling an evaluation of facilities proposed in the future against those on this list. Future revisions should maintain the funding envelope used to guide this list, enforcing fiscal discipline upon discussions and requiring the elimination of facilities in order to accommodate more important or exciting prospects.

(3) While prioritizing scientific programs and/or facilities within disciplines can be difficult, it is done regularly throughout the Federal Government and by numerous scientific and technical advisory committees. Prioritizing openly across disciplines, however, is notoriously difficult and has been done rarely. Physicist William Brinkman recently testified before the House Committee on Science to the effect that while such prioritizations are possible, they are necessarily based on intuition and therefore subjective. David Goldston, staff director for the Committee, responded that the Committee understood this and it was the reason that the Committee wanted “someone else” to do the prioritization.

The DOE's Office of Science recognizes that the breadth and scope of the vision encompassed by these 28 facilities reflects a most aggressive and optimistic view of the future of the Office. Nevertheless, we believe that it is necessary to have and discuss such a vision. Despite the many uncertainties, it is important for organizations to have a clear understanding of their goals and a path toward reaching those goals.

As stewards of the public's dollars, it is our responsibility to announce candidly how we would propose to spend those resources in the future. The public also has a right to expect that its government makes its decisions on such important and costly investments as future scientific facilities in the open with a transparent process. The *Facilities for the Future of Science: A Twenty-Year Outlook* offers such a vision of the future, and it does so by openly announcing the hard choices that need to be made to sustain science.

The Secretary of Energy Advisory Board's Task Force on the Future of Science Programs at the Department of Energy, which was chaired by Dr. Charles M. Vest, President of the Massachusetts Institute of Technology, praised the idea of a 20-year DOE Office of Science facilities plan in a report issued in the fall of 2003:

We believe that the 20-year vision of future scientific facilities currently being developed in the Office of Science is outstanding and could have a far-reaching, positive effect on the Nation's leadership in science.

The Twenty-Year Facilities Outlook—A Prioritized List

Of the 53 facilities initially proposed by the Advisory Committees, 28 made the list of most important facilities that will be needed over the next 20 years to support the Nation's research needs in areas that have been the traditional responsibility of the DOE.

The 28 facilities are listed by priority on the following pages. Some are noted individually; however others, for which the advice of the Advisory Committees was insufficient to discriminate among relative priority, are presented in "bands." In addition, the facilities are roughly grouped into near-term priorities, mid-term priorities, and far-term priorities (and color-coded red, blue, and green, respectively) according to the anticipated R&D timeframe of the scientific opportunities they would address. Thus, for example, the Linear Collider is the first priority among the mid-term facilities.

Each facility listing is accompanied by a "peak of cost profile," which indicates the onset, years of peak construction expenditure, and completion of the facility. Because many of the facilities are still in early stages of conceptualization, the timing of their construction and completion is subject to the myriad considerations that come into play when moving forward with a new facility. Furthermore, it should be remembered that construction of these cost profiles was guided by an ideal funding scenario (see footnote 2).

Summaries and illustrations of the 28 facilities are provided on the following pages.



Harvesting Hydrogen from Microalgae: DOE's Office of Science, working in partnership with the Office of Energy Efficiency, has unlocked the secret to increasing the hydrogen yield of a certain type of green microalgae that shows promise of producing hydrogen cheaply, easily, and cleanly.

Facilities for the Future of Science: A Twenty-Year Outlook

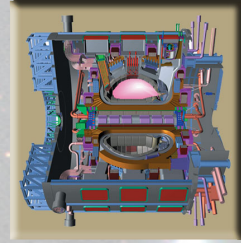

ITER



UltraScale Scientific Computing Capability



Joint Dark Energy Mission



Spallation Neutron Source 2-4 MW Upgrade

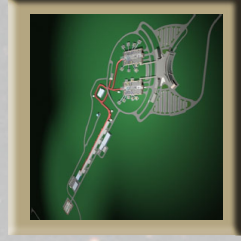

Spallation Neutron Source Second Target Station

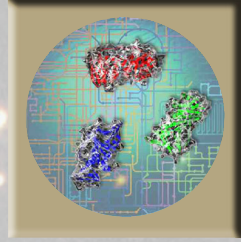

Whole Proteome Analysis



Linac Coherent Light Source

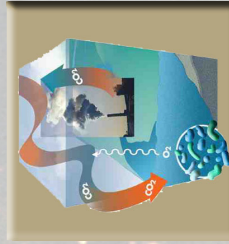

Protein Production and Tags

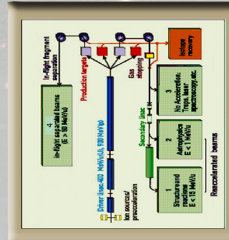

Rare Isotope Accelerator

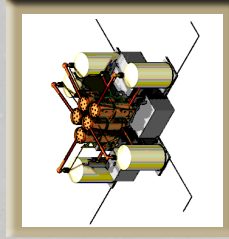

Double Beta Decay Underground Detector

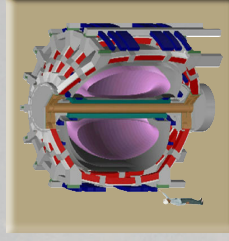

Next-Step Spherical Torus



RHIC-II

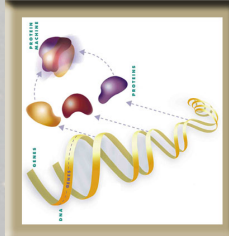

Characterization and Imaging Molecular Machines

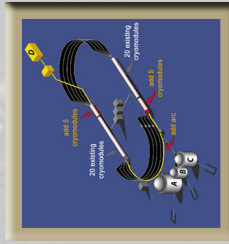

CEBAF 12 GeV Upgrade

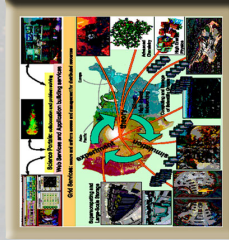

ESnet Upgrade



National Synchrotron Light Source Upgrade



Super Neutrino Beam



Advanced Light Source Upgrade

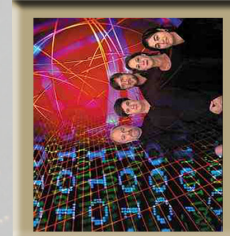

NERSC Upgrade

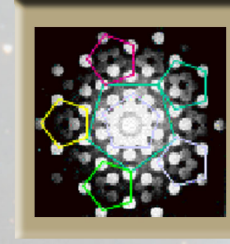

Transmission Electron Achromatic Microscope

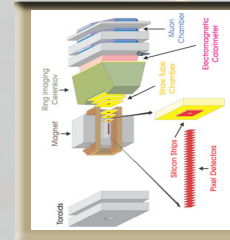

BTeV



Advanced Photon Source Upgrade

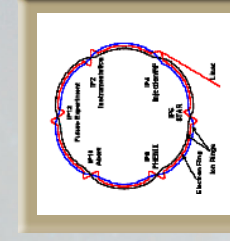

eRHIC

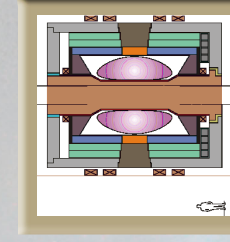

Fusion Energy Contingency

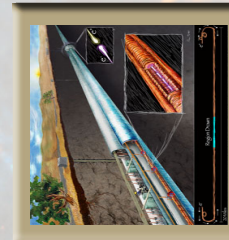

Linear Collider

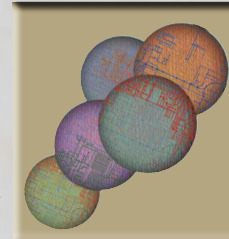

Analysis and Modeling of Cellular Systems

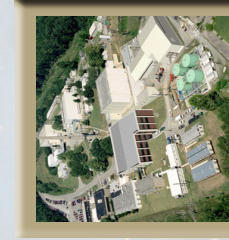

HFIR Second Cold Source and Guide Hall

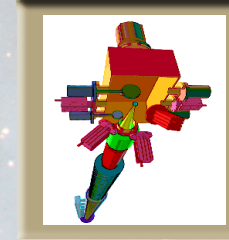

Integrated Beam Experiment

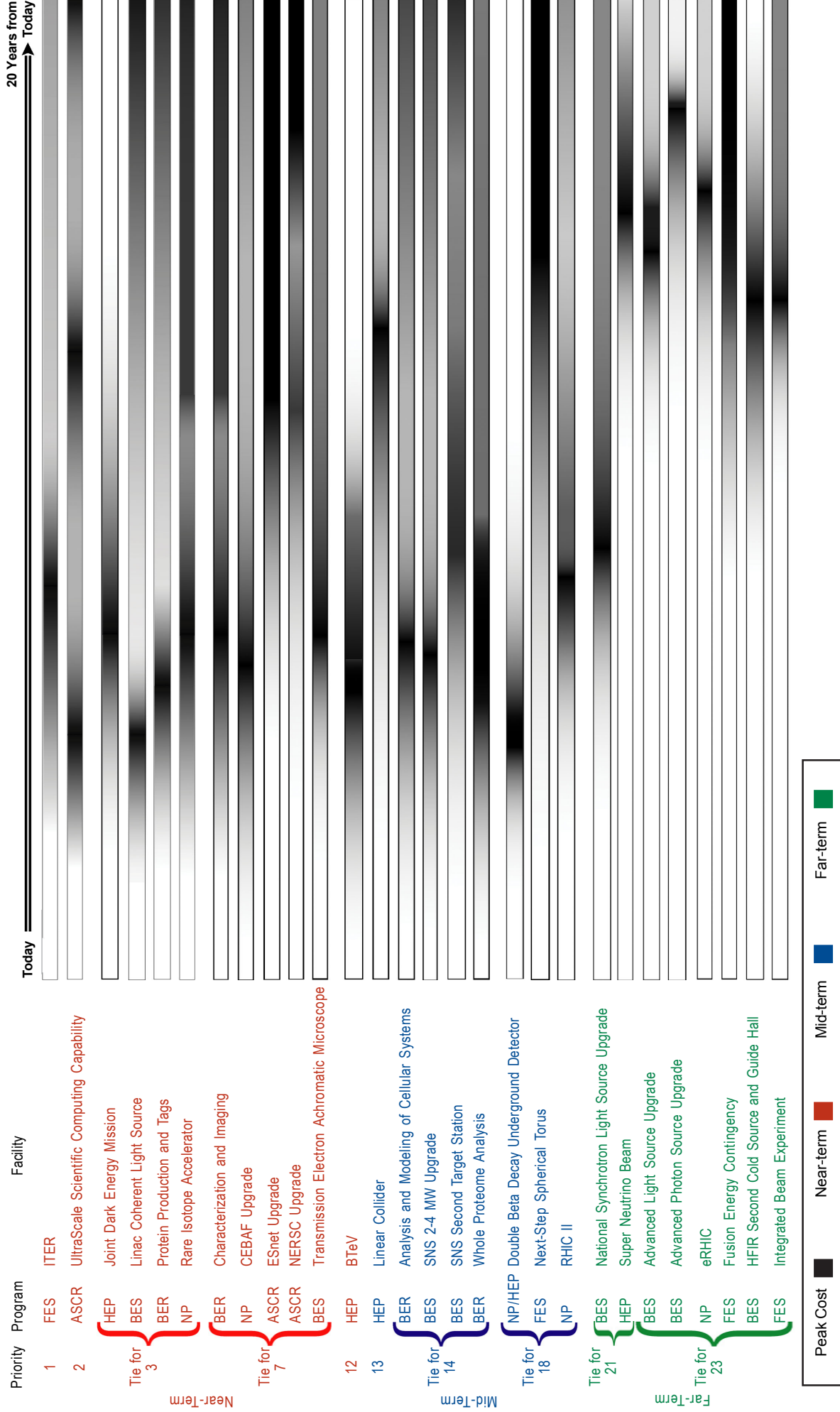

Programs:
 ASCR = Advanced Scientific Computing Research
 BES = Basic Energy Sciences
 BER = Biological and Environmental Research
 FES = Fusion Energy Sciences
 HEP = High Energy Physics
 NP = Nuclear Physics

Facility Summaries

Near-Term Priorities

Priority: 1 ITER

The Facility: ITER is an international collaboration to build the first fusion science experiment capable of producing a self-sustaining fusion reaction, called a “burning plasma.” It is the next essential and critical step on the path toward demonstrating the scientific and technological feasibility of fusion energy.

Background: Fusion is the power source of the sun and the stars. It occurs when the lightest atom, hydrogen, is heated to very high temperatures forming a special gas called “plasma.” In this plasma, hydrogen atoms combine, or “fuse,” to form a heavier atom, helium. In the process of fusing, some matter is converted directly into large amounts of energy. The ability to contain this reaction, and harness the energy from it, are among the important goals of fusion research.

What’s New: Recent advances in computer modeling and in our understanding of the physics of fusion give us confidence that we can now build ITER successfully. The unique features of the facility will be its ability to operate for

long durations (hundreds of seconds and possibly several thousands) and at power levels (around 500 MW) sufficient to demonstrate the physics of the burning plasma in a power-plant-like environment. ITER will also serve as a test-bed for additional fusion power-plant technologies.

Applications: ITER is the next big step toward making fusion energy a reality. Fusion energy is particularly attractive as a future energy source because it is environmentally benign (it produces no air pollution and no carbon dioxide, and it does not create long-lived radioactive waste); its fuels are easily extracted from ordinary water and from lithium, an abundant element; and it can be generated on demand and in sufficient capacity to power large cities and industries.

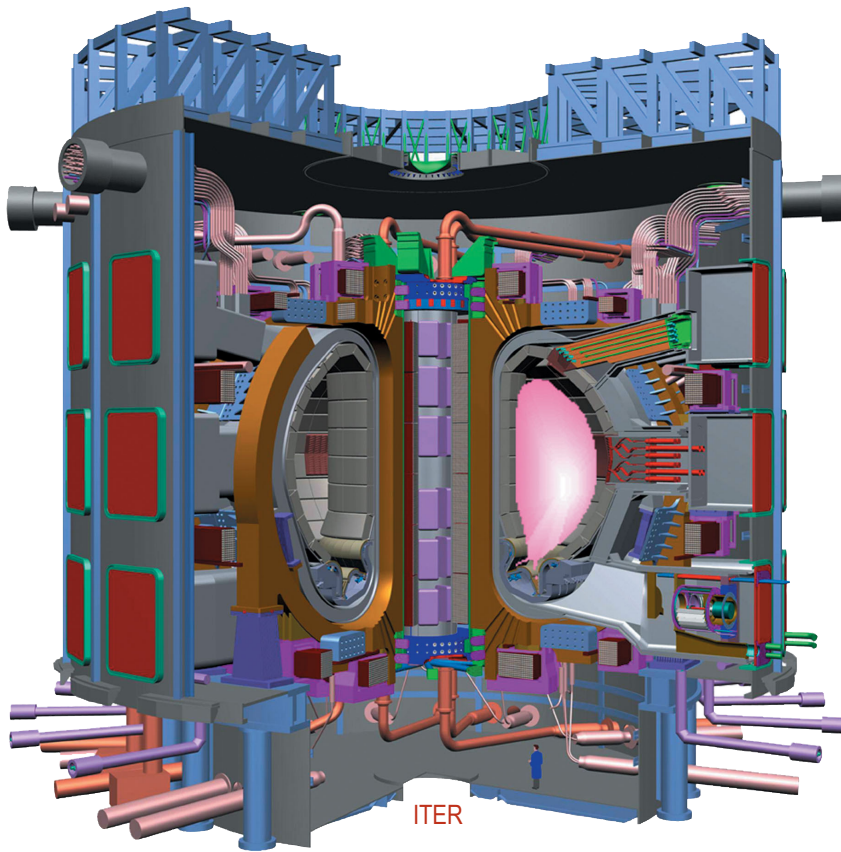

Priority: 2 UltraScale Scientific Computing Capability (USSCC)

The Facility: The USSCC, located at multiple sites, will increase by a factor of 100 the computing capability available to support open (as opposed to classified) scientific research—reducing from years to days the time required to simulate complex systems, such as the chemistry of a combustion engine, or weather and climate—and providing much finer resolution.

Background: Recently, with the start-up of its new supercomputer known as the Earth Simulator, the Japanese introduced the world to a new era in scientific computation. The Earth Simulator has the computing power of the 20 fastest U.S. computers combined and a peak speed of 40 teraflops—three times faster than the theoretical peak performance of any U.S. machine.

What's New: The USSCC will involve long-term relationships with U.S. computer vendors and an integrated program of hardware and software investments designed to optimize computer performance for scientific and commercial problems by creating a better balance of memory size, processor speed, and interconnection rates. Most existing supercomputers have been designed with the consumer market in mind; USSCC's new configurations will build on accomplishments of the Earth Simulator to develop computing capability specifically designed for science and industrial applications. These facilities will operate like Office of Science light sources: available to all, subject to proposal peer review.

Applications: The computing capability represented by the USSCC could have a significant economic impact, on the order of billions of dollars, on commercial product design, development, and marketing. Currently, many U.S. industries are forced to build prototypes for new designs that are expensive and cause significant manufacturing delays. USSCC's speed and capabilities would allow for "virtual prototypes," which would greatly shorten time to market and save significant investment costs. As an example, consider the comparison between manufactured prototyping and simulations for General Electric's jet engines: what currently takes GE several years and millions of dollars in design, re-design, and manufacturing of prototypes could be accomplished in less than a day on a machine like the USSCC. General Motors, in another example, also saves hundreds of millions of dollars using its in-house computing capability, but believes that it cannot meet the steady demand for safer, more fuel-efficient, and cleaner cars, without substantial increases in computing capabilities that will not be achieved through existing computer architectures and technologies.

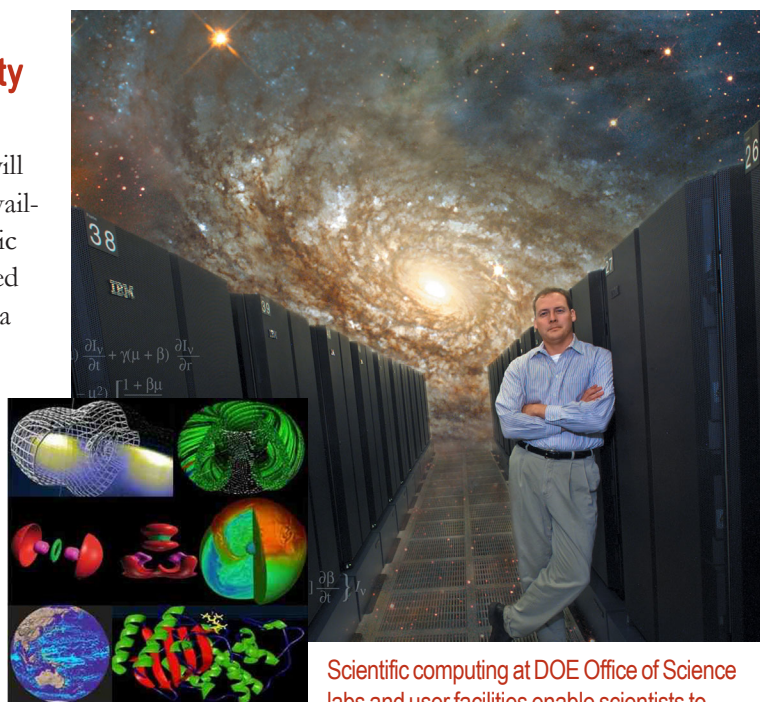

Scientific computing at DOE Office of Science labs and user facilities enable scientists to use quantum calculations to understand the combustion process, model thermal reactions, analyze climate change data, reveal chemical mechanisms of catalysts, and study the collapse of a supernova.

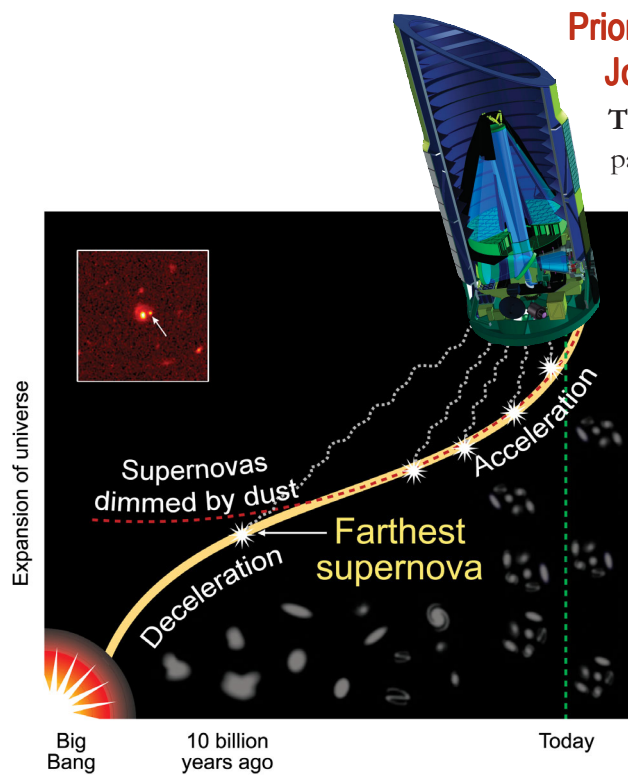

The Joint Dark Energy Mission's space-based probe will study the accelerating universe.

Priority: Tie for 3

Joint Dark Energy Mission (JDEM)

The Facility: JDEM is a space-based probe, developed in partnership with NASA, designed to help understand the recently discovered mysterious “dark energy” which makes up more than 70 percent of the universe, and evidently causes its accelerating expansion.

Background: A slowing expansion of the universe following the Big Bang—like the ripples from a pebble hitting the water slowing as they move out—was widely predicted by physicists. Beginning in the 1990’s, scientists set out to measure this deceleration by using ground-based observations of a class of supernova explosions which can serve as a benchmark (or “standard candles”) on which to base their measurements. To world-wide surprise, they found that rather than slowing, the expansion of the universe is speeding up. This discovery suggested the existence of a previously unknown energy, now called “dark energy,” pushing space apart. The accelerating expansion of the universe was deemed “Breakthrough of the Year” by *Science* magazine in 1998.

What’s New: JDEM will be the first dedicated space-based tool for the study of the accelerating universe. By being above the atmosphere and capable of viewing a wide angle of the sky, it will be able to collect and analyze information on the largest number of supernovas yet identified, over a wide range of distances, and thus “see” a far longer period in the evolution of the universe. It is designed to measure precisely the history of the accelerations and decelerations of the expansion of the universe from the current epoch back to approximately 10 billion years ago, when the universe was only one third its present age.

Applications: The evidence for cosmic acceleration is shaking the foundations of fundamental physics. Further study will address profound issues at the heart of both cosmology and high energy physics and will be essential for our understanding of the physical laws and contents of the universe.

Priority: Tie for 3

Linac Coherent Light Source (LCLS)

The Facility: The LCLS will provide laser-like radiation 10 billion times greater in power and brightness than any existing x-ray light source, enabling the study of matter and chemical reactions at speeds and levels of detail well beyond what is currently possible.

Background: X-rays are used to examine all kinds of materials, from our bones and heart, to petroleum products, to high explosives and the components of nuclear weapons. However, there are substantial limitations to these existing x-rays: we can only create images of those molecules that can be grown into crystals (which eliminates many proteins, for example), and we cannot measure changes in molecules as they take place—in the tens and hundreds of

femtoseconds—which is the very heart of chemistry.

What's New: The LCLS will be the world's first x-ray-free electron laser operating in the 1.5-15 angstrom range. It will have properties vastly exceeding current synchrotron sources in three key areas: peak brightness (10 billion times greater than current synchrotrons), coherence (complete, rather than the limited spatial coherence currently available), and short pulse duration (at least 100 times shorter than is currently available). With the LCLS, we will be able to image complex protein structures from single molecules, create real-time images of chemical reactions, and much more.

Applications: The leap in x-ray source capabilities provided by the LCLS will open entirely new realms of scientific endeavor in the chemical, materials, and biological sciences. Existing synchrotron light sources have been used for a very diverse array of applications: to determine the structures of thousands of proteins to help understand our living world, to provide petroleum companies with information about the three-dimensional properties of molecules in their manufacturing processes to increase efficiency, and to develop magnetic media with more storage capacity.

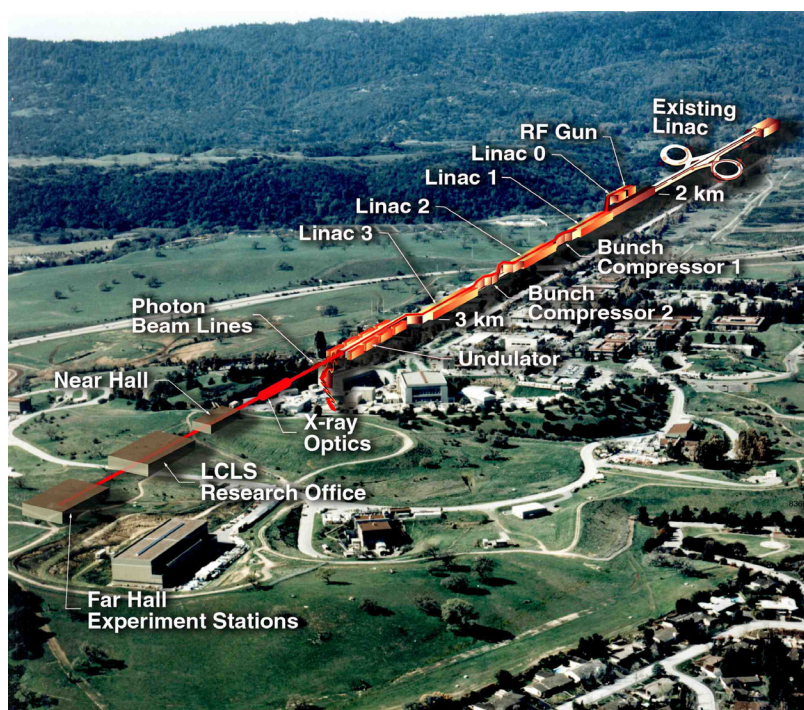

The Linac Coherent Light Source will be the world's first x-ray-free electron laser, opening new realms of scientific research in chemical, materials, and biological sciences.

Priority: Tie for 3 Protein Production and Tags

The Facility: The Protein Production and Tags facility will use highly automated processes to mass-produce and characterize tens of thousands of proteins per year, create “tags” to identify these proteins, and make these products available to researchers nationwide.

Background: The deluge of data and related technologies generated by the Human Genome Project and other genomic research is creating a broad array of commercial and scientific opportunities. The next bottleneck in turning this information into practical solutions for energy, medical, environmental, and other challenges is the lack of ready access to the thousands of proteins coded for by DNA. Researchers from across the country



Protein Production Facility

Facility for Production and Characterization of Proteins and Molecular Tags

Proteins perform most of the work of the cell. This facility will

- use highly automated processes to mass-produce and characterize proteins directly from microbial genome data.
- create protein-specific molecular tags to identify, capture, and monitor the proteins from living systems.

Accelerating the Pace of Discovery for DOE Mission Applications

Clean, abundant energy



Increase biological sources of fuels (e.g., hydrogen)

Climate stabilization

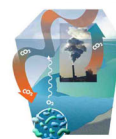

Reduce net CO₂ atmospheric emissions to counter global warming

Environmental cleanup



Save billions of dollars in toxic waste cleanup and disposal

and from many different government agencies will benefit from the development of a reliable, inexpensive, high-quality technique for making these materials for their experiments.

What's New: This biological research facility will be the first of its kind. It will develop highly automated processes to mass-produce and characterize proteins directly from microbial genome data and create affinity reagents (chemical “tags”) to identify, capture, and monitor the proteins from living systems. Given that each microbe makes several thousand proteins, and thousands of microbes need to be studied, researchers need the ability to produce and characterize tens of thousands of proteins and nearly one hundred thousand “tags” per year. Using current methods, doing this for even a single microbe is virtually impossible.

Applications: Understanding exactly how microbes perform specialized functions is central to applying the recent spectacular advances in biology and genetics to DOE’s missions: for example, to harness microbes to eat radioactively contaminated waste, create hydrogen for a new energy source, and absorb carbon dioxide. The possibilities are tremendous. In the future, we may see communities of microbes absorbing the pollutants from the smokestacks of coal fired power plants—making coal as clean a fuel source as hydropower.

Priority: Tie for 3 Rare Isotope Accelerator (RIA)

The Facility: The Rare Isotope Accelerator (RIA) will be the world’s most powerful research facility dedicated to producing and exploring new rare isotopes that are not found naturally on earth.

Background: Physicists study how isotopes (versions of atoms with different numbers of neutrons in their nucleus) decay to understand how everything from the cosmos to the atom was formed. Most isotopes exist

for months, days, or hours and are accessible to study with existing machines. “Rare” isotopes, however, live for only thousandths of a second, but are central to the origin of the chemical elements, fuel the stars, and energize our sun to sustain life on Earth.

What's New: RIA will involve the development of new accelerator technology to create beams of unstable (rare) isotopes that are 10 to 100 times more powerful than those available today. It will have the capability to specify, control, and vary precisely the number of protons and neutrons in atomic nuclei, and thus study not only the properties of individual nuclei, but also the evolution of these properties across the nuclear chart.

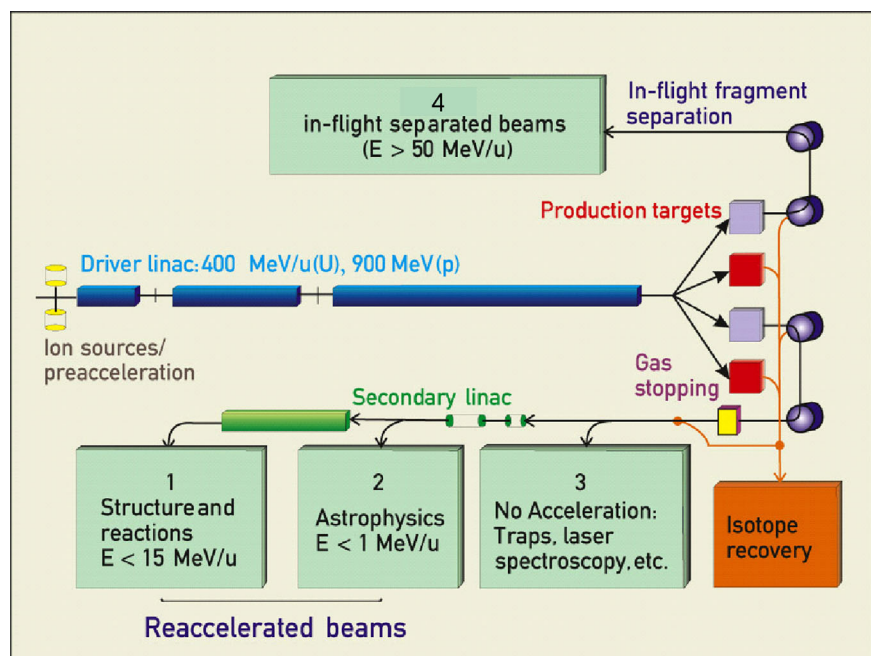

Isotope Accelerator Concept

Applications: Construction of RIA will establish U.S. leadership in this scientific arena. It will allow physicists to explore the structure and forces that make up the nucleus of atoms; learn how the chemical elements that make up the world around us were created; test current theories about the fundamental structure of matter; improve our ability to model the explosions of nuclear weapons, and play a role in developing new nuclear medicines and techniques. One of every three hospitalized patients in the U.S., for example, undergoes a procedure involving nuclear medicine—spin-offs of earlier government investments in nuclear physics.

Priority: Tie for 7 Characterization and Imaging of Molecular Machines

The Facility: The facility for Characterization and Imaging of Molecular Machines will build on capabilities provided by the Protein Production and Tags facility to provide researchers with the ability to isolate, characterize, and create images of the thousands of molecular machines that perform the essential functions inside a cell.

Background: Cells, including microbes, function by combining proteins and other molecules into “molecular machines.” Currently, only a handful of these molecular machines have been isolated or characterized. Providing the research community with the means to learn how these machines function will be critical to our ability to use microbes to address many environmental, energy, and national security needs.

What’s New: This biological user facility will provide the research community with the world’s largest assembly of sophisticated analytic and imaging instrumentation, combined with state-of-the-art computational tools, to enable users to isolate, identify, characterize, and image the molecular machines present in selected microbes under highly controlled conditions. The facility’s high-throughput capabilities will analyze thousands of molecular machines in the time it now takes to do a few.

Applications: The success of the Human Genome Project taught us that achieving great economies of scale, such as those represented by this facility, vastly reduces the cost of research and therefore makes the field accessible to hundreds of researchers for whom it would otherwise be too expensive or cumbersome. This, as has also been demonstrated, dramatically increases the pace of scientific discovery and the rate at which practical use is made of these discoveries.



Molecular Machines Facility

Facility for Characterization and Imaging of Molecular Machines

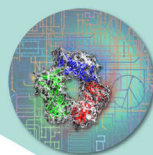

Proteins often work together as highly organized machines to perform the tasks of a living cell. This facility will

- isolate, identify, and characterize thousands of such molecular machines from microbes.
- develop the ability to image component proteins within complexes and to validate the presence of the complexes within cells.

Accelerating the Pace of Discovery for DOE Mission Applications

Clean, abundant energy



Increase biological sources of fuels (e.g., hydrogen)

Climate stabilization

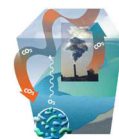

Reduce net CO₂ atmospheric emissions to counter global warming

Environmental cleanup



Save billions of dollars in toxic waste cleanup and disposal

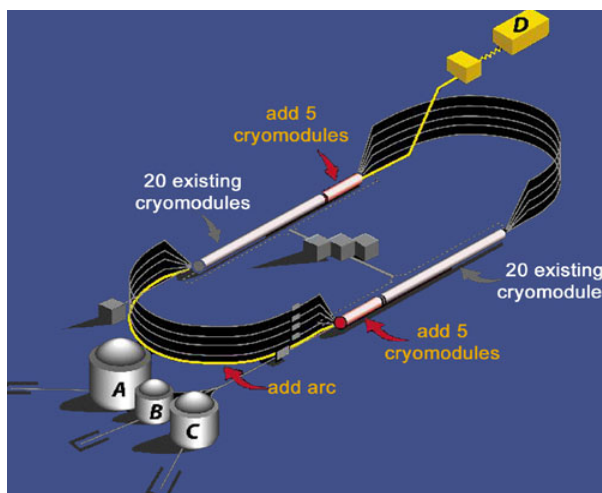

The Continuous Electron Beam Accelerator Facility upgrade will double the energy of its electron beam and add advanced computing power to provide much more precise data on the structure of protons and neutrons.

Priority: Tie for 7 Continuous Electron Beam Accelerator Facility (CEBAF) 12 GeV Upgrade

The Facility: The upgrade to the Continuous Electron Beam Accelerator Facility (CEBAF) at Thomas Jefferson Laboratory is a cost-effective way to double the energy of the existing beam, and thus provide the capability to study the structure of protons and neutrons in the atom with much greater precision than is currently possible.

Background: “Quarks” are the particles that unite to form protons and neutrons, which, with electrons, combine to form the atoms that make up all the matter that we are familiar with. As yet, scientists are unable to explain the properties of these entities—why, for example, we do not seem to be able to “see” individual quarks in isolation (they change their natures when separated from each other) or understand the

full range of possibilities of how quarks can combine together to make up matter.

What’s New: The CEBAF Upgrade will take advantage of recent advances in computing power, combined with a doubling of the existing energy of the electron beam, to create a 12 giga-volt electron beam capable of providing much more precise data on the structure of protons and neutrons. Specifically, the upgrade will enable scientists to address one of the great mysteries of modern physics – the mechanism that “confines” quarks together. New supercomputing studies indicate that force fields called “flux-tubes” may be responsible, and that exciting these should lead to the creation of never-before-seen particles.

Applications: The CEBAF Upgrade will provide a world-class, unique facility for the study of the largely unexplored frontier in our understanding of the composition of nuclear matter, thus maintaining U.S. leadership in this scientific arena. Spin-off applications of the knowledge gained at this facility may include such diverse technologies as vastly more effective MRIs, allowing doctors to create images of patients’ lungs as they breathe, and free-electron lasers, currently being studied by the Navy as long-range, portable weapons systems for ships.

Priority: Tie for 7 Energy Sciences Network (ESnet) Upgrade

The Facility: The ESnet upgrade will enhance the network services available to support SC researchers and laboratories and maintain their access to all major DOE research facilities and computing resources, as well as fast inter-connections to more than 100 other networks.

Background: The Energy Sciences Network, or ESnet, provides a high-speed, effective, and reliable communications network infrastructure that enables thousands of Department of Energy, university and industry scientists and collaborators worldwide to make effective use of unique DOE research

facilities and computing resources, independent of time and geographic location. User demand to ESnet has grown by a factor of more than 10,000 since its inception in the mid 1980s—a 100 percent increase every year since 1990.

What's New: Future projections suggest sustained annual growth curves of upwards of 300 percent per year as research becomes more computing-intensive. The ESnet upgrade will include the purchase, lease, and management of equipment, communication lines, services, and other components necessary to keep pace with this demand.

Applications: ESnet brings the power and capabilities of all of DOE's scientific facilities to scientists' desktops—allowing researchers to access premier experimental tools from the comfort of their own offices. It also greatly increases the number of researchers that can gain access to DOE facilities, speeding the pace of scientific discovery and making optimal use of our Federal investment.

Priority: Tie for 7 National Energy Research Scientific Computing Center (NERSC) Upgrade

The Facility: This upgrade will ensure that NERSC, DOE's premier scientific computing facility for unclassified research, continues to provide high-performance computing resources to support the requirements of scientific discovery.

Background: NERSC provides high-performance computing tools and expertise that enable computational science on a grand scale: it supports large, interdisciplinary teams of researchers to attack fundamental problems in science and engineering that require massive calculations and have broad scientific and economic impact. NERSC will continue to provide the core scientific computing needed by the research community, and that will complement the “grand challenge” approach pursued under the UltraScale Scientific Computing Capability.

What's New: The NERSC upgrade will use grid technology to deploy a capability designed to meet the needs of an integrated science environment combining experiment, simulation, and theory by facilitating access to computing and data resources, as well as to large DOE experimental instruments. NERSC will concentrate its resources on supporting scientific challenge teams, with the goal of bridging the software gap between currently achievable and peak performance on the new terascale platforms.

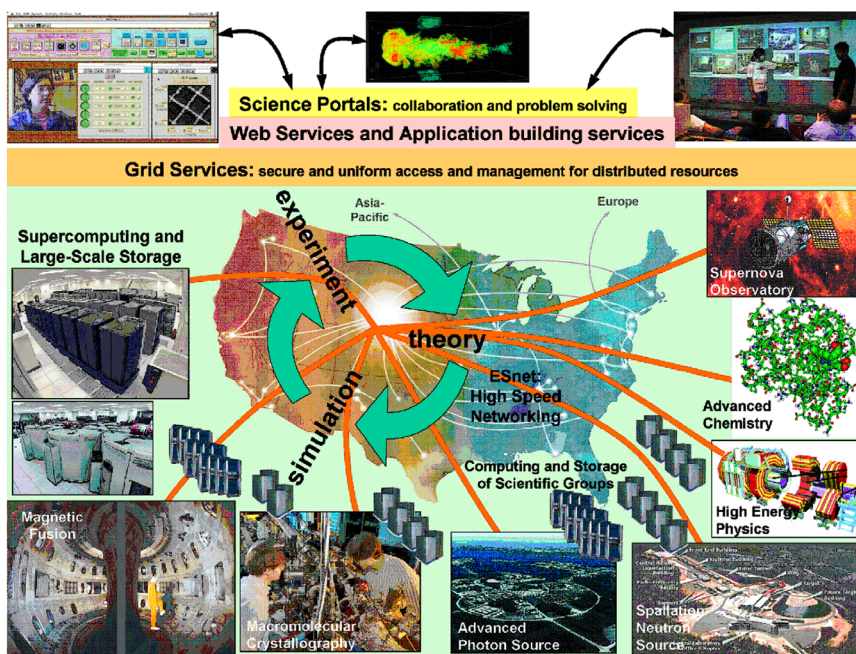

The Energy Sciences Network (ESnet) upgrade will enhance existing network services and add fast interconnections to 100 other networks.



The NERSC upgrade will use grid technology to meet the expanding needs of an integrated science environment.

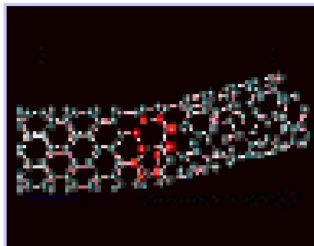
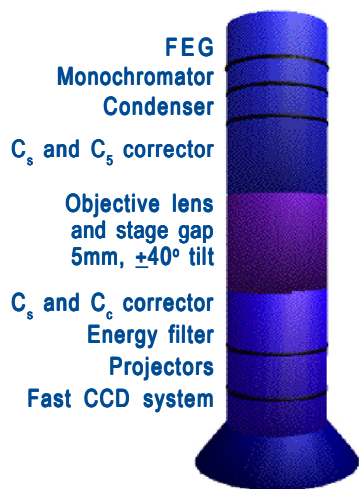

New materials: Nanotubes

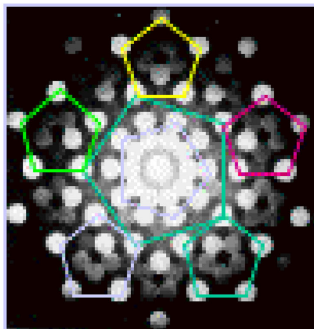

Phase transformations:
Quasicrystals

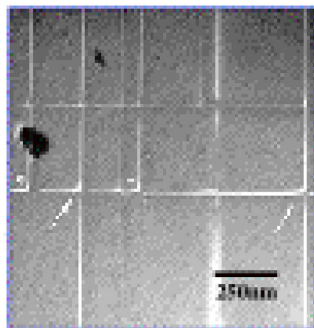

Defects: Strength of crystals

The Transmission Electron Achromatic Microscope (top) will allow scientists to study the formation, growth, and defects of materials (as shown in the examples).

Applications: Over the last 25 years, NERSC has built an outstanding reputation for providing both high-end computer systems and comprehensive scientific client services to more than 2000 scientists from DOE laboratories and major U.S. universities each year. These researchers are using NERSC capabilities to further an amazing variety of scientific inquiries—from the discovery of the accelerating universe; to work on custom-designed catalysts for application in pollution prevention technologies, fuel cells, and industrial processes to more accurate climate models that take into account feedback effects of climate change on the absorption of carbon by the ocean and the land masses.

Priority: Tie for 7 Transmission Electron Achromatic Microscope (TEAM)

The Facility: TEAM will be the first of a new generation of electron microscopes that, by correcting for distortions in focus inherent to all current electron microscopes, will give much clearer images and allow the use of much larger experimental chambers.

Background: Electron microscopes are used to see finer details of the inner structure of materials than are accessible with ordinary light microscopes. However, existing electron microscopes are limited because they suffer from inherent aberrations which diminish the resolution of the image. One of these limitations is that only very small samples can be used, which precludes using the microscope to study how materials evolve or respond in changing environments.

What's New: TEAM will be the first of a new generation of intermediate-voltage electron microscopes capable of developing a much more fundamental understanding of materials by achieving resolution near 0.05 microns. TEAM will provide the U.S. with world-class electron microscopy capability, and very high-resolution imaging.

Applications: The TEAM microscope will allow scientists to study how atoms combine to form materials, how materials grow, and how they respond to a variety of external factors. These constitute many of the most practical things that we need to know about materials, and will improve designs for everything from better, lighter, more efficient automobiles, to stronger buildings and new ways of harvesting energy.

Priority: 12 BTeV

The Facility: BTeV (“B-particle physics at the Tevatron”) is an experiment designed to use the Tevatron proton-antiproton collider at the Fermi National Accelerator Laboratory (currently the world’s most powerful accelerator) to make very precise measurements of several aspects of fundamental particle behavior that may help explain why so little antimatter exists in the universe.

Background: At some point very, very early in the evolution of the universe the initial quantities of matter and anti-matter became lopsided, or “asymmetrical,” resulting in the matter-based universe we now know. One of the best ways to study this phenomenon is by making precise measurements of very infrequent events—in this case rarely observed decay patterns of certain types of subatomic particles from a family called “B-particles.” Because these events are so extremely rare, many, many B-particles must be created to capture enough information for a single experiment.

What’s New: BTeV will use state-of-the-art detector technologies and the very high particle production rates at Fermilab’s Tevatron to obtain the large samples of B-particles needed to make the necessary measurements. Measurements from existing electron accelerators can account for approximately 1 percent of the “asymmetry” needed to explain what we observe in the cosmos; BTeV will provide a new and unique tool with which to search for sources of the other 99 percent.

Applications: Understanding why and how the universe became asymmetrical between matter and anti-matter is one of the most outstanding, fundamental questions in the study of elementary particle physics today, and has profound implications for understanding how the whole universe evolved from its simple initial state to the complex patterns we see today.

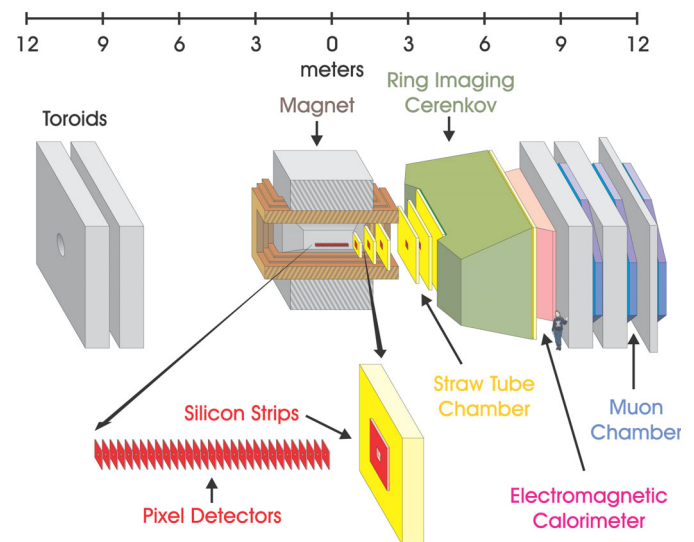

The BTeV detector will use the Tevatron collider at Fermi National Accelerator Laboratory to make precise measurements of fundamental particle behavior, which may help explain why there is so little antimatter in the universe.

Mid-Term Priorities

Priority: 13 Linear Collider

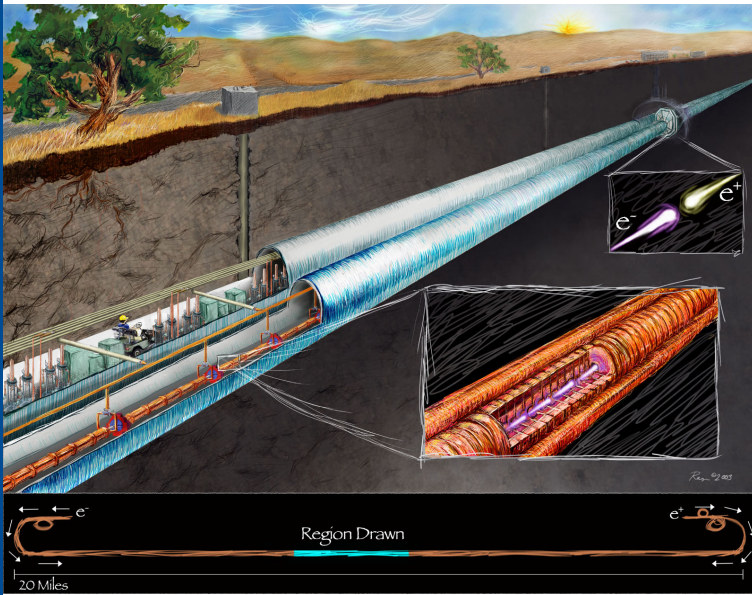

The Linear Collider is designed to extend the study of particle physics.

The Facility: The Linear Collider will allow physicists to make the world's most precise measurements of nature's most fundamental particles and forces at energies comparable to those of the Large Hadron Collider (LHC) now under construction in Switzerland.

Background: The Standard Model of particle physics, developed over the last 50 years and recognized as one of *the* great scientific achievements, has been tremendously effective in predicting the behavior of all the interactions of subatomic particles except those due to gravity, and in describing the varieties of particles that combine to make everyday matter. The next step—incorporating a theory of gravity and understanding why fundamental particles have mass—will require particle accelerators that function at the trillion-electron volt (“TeV”) level.

What's New: The LHC now under construction at CERN in Switzerland will open exploration of the TeV energy level. The Linear Collider, also to be an international effort, will distinguish itself by its ability to perform unique, precise measurements at this energy because it will collide individual fundamental particles rather than complex clusters of particles. The precision afforded by the Linear Collider will enable new phenomena discovered at the LHC to be more fully explored, in addition to providing its own discoveries.

Applications: High-energy physics has always been a frontier discipline in science, driving technological innovation (the World Wide Web was created to share data from accelerator experiments, as an example) and pushing the limits of what we know in the disparate but interconnected worlds of cosmology and elementary particles. The Linear Collider could be considered the high-tech equivalent of a frontier outpost at the edge of a new world.

Priority: Tie for 14 Analysis and Modeling of Cellular Systems

The Facility: The facility for Analysis and Modeling of Cellular Systems will combine advanced computational, analytical, and experimental capabilities to study how multi-cellular systems, including microbial communities, function at the molecular level.

Background: Microbes are the most abundant form of life on earth. They have adapted to extreme conditions—thriving, for example, in highly

radioactive and toxic environments or in extreme heat. This offers clues about how to use these microbes to address practical problems such as the clean-up of contaminated land or water. However, microbes in nature do not act as individuals, but rather as part of complex communities, so we need to study these communities as a whole.

What's New: New capabilities provided by this facility will include (1) controlled experimental systems for microbial community growth; (2) efficient processes for analysis and/or characterization of microbial community function; (3) sophisticated tools for studying the interactions and/or communication of microbial community members; (4) computational tools for complex microbial community modeling.

Applications: Microbial communities offer tremendous potential to address DOE needs in environmental remediation and energy production in entirely new and more effective ways. In the past, microbes have been used to produce nontoxic chemicals and enzymes to reduce the cost and improve the efficiency of industrial processes; microbial enzymes have been used to bleach paper pulp, stone wash denim, remove lipstick from glassware, break down starch in brewing and coagulate milk protein for cheese production. New applications include the use of microbial communities to digest radioactive waste and to create hydrogen, a clean fuel for a new economy.

Priority: Tie for 14 Spallation Neutron Source (SNS) 2-4MW Upgrade

The Facility: The SNS upgrade will more than double its power, enabling the addition of approximately 20 to 24 more instruments and doubling the number of researchers who can use the facility.

Background: Because of their special properties, neutrons have unique applications as probes in many fields of science and technology. For example, virtually everything we know about the fundamental structure of magnetic materials—which lie at the



Cellular Systems Facility

Facility for Analysis and Modeling of Cellular Systems

This facility will incorporate a new generation of instruments and computational techniques to monitor the machines and processes of living cells within microbial communities in their natural environments. Analyzing these dynamic and complex cellular activities as they occur within living systems will reveal how these processes are orchestrated by the genome.

Accelerating the Pace of Discovery for DOE Mission Applications

Clean, abundant energy



Increase biological sources of fuels (e.g., hydrogen)

Climate stabilization



Reduce net CO₂ atmospheric emissions to counter global warming

Environmental cleanup



Save billions of dollars in toxic waste cleanup and disposal

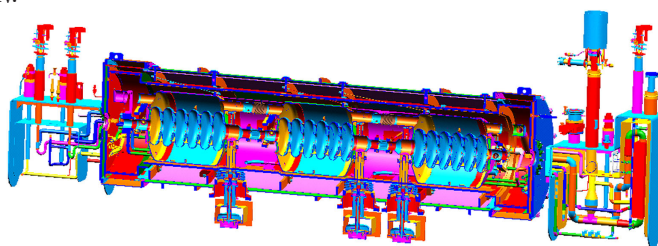

SNS Power Upgrade: The linac tunnel is sized for 9 additional “cryomodules” (top). Augmenting Klystron Gallery is required (bottom).

heart of today's motors, generators, telecommunications, video, and audio technologies—has been learned through neutron scattering.

What's New: The SNS, the most powerful neutron source in the world, was designed from the outset to accommodate a power upgrade that would support a second neutron beam, target station, and associated suite of instruments. Increasing the SNS power level from 1 MW to 2-4 MW will increase the range of materials for which measurements using a single pulse becomes feasible, and will enable the future construction and operation of a second target station specifically designed to study soft matter, such as polymers and biological material.

Applications: As the needs of our high-technology society have advanced, so have our demands for stronger, lighter, and cheaper materials. More than ever, x-ray and neutron sources are used to understand and “engineer” such materials at the atomic level. Jets, credit cards, pocket calculators, compact discs, computer disks, magnetic recording tapes, shatter-proof windshields, and satellite weather information for forecasts have all been improved by neutron-scattering research.

Priority: Tie for 14 Spallation Neutron Source (SNS) Second Target Station

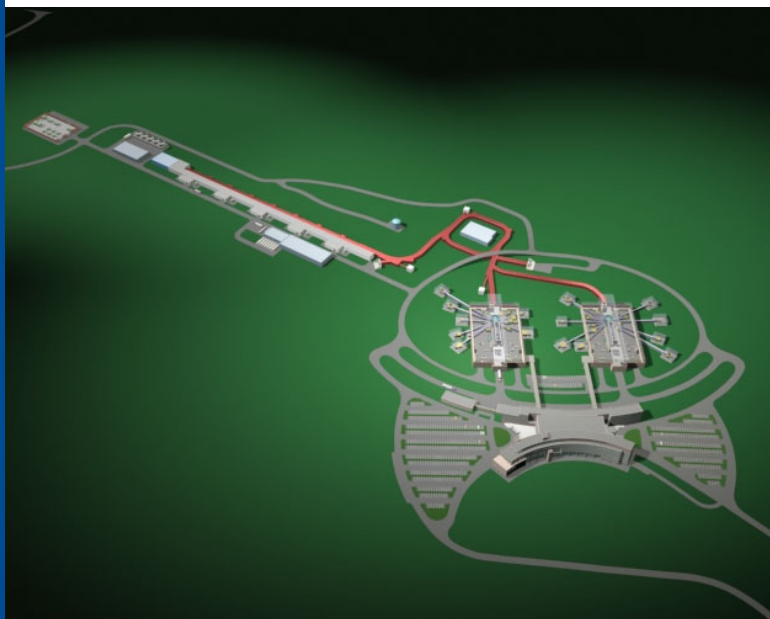

The SNS was designed from the outset to allow operations with two target stations. At the present pace, all of the High Power Target Station (HPTS) beamlines will be allocated by approximately 2006 and built out by 2013.

The Facility: The second target station at the SNS will provide a long wavelength neutron source optimized for the study of large structures such as polymers, and biological materials including cell walls and membranes.

Background: Neutrons are non-destructive highly penetrating probes useful for studying the structure of many types of materials. Unlike x-rays, these uncharged particles are especially sensitive to hydrogen and other light atoms that are major components of biological materials. Slower, so-called “cold neutrons” are particularly well-suited to the study of biological matter because their wavelengths are comparable to the size of proteins and other important biological molecules.

What's New: When completed in 2006, the SNS will be ten times more powerful than the best spallation neutron source now in existence. The design of the SNS provided for the construction of two

differently optimized target stations. The high frequency (60-Hz) target station now under construction is optimized for experiments in condensed matter physics, materials sciences, magnetic materials, and engineering. The second target station will operate at a significantly lower frequency (10 Hz) that will enable studies of fundamental neutron physics, chemical spectroscopy, protein folding dynamics, and polymer dynamics, among many other topics.

Applications: Growing numbers of industrial and university researchers are using neutron sources for the development of everything from fiber and

composite materials to the creation of microscopic machines, to improvements in high-capacity magnetic data storage. The “cold neutron research” enabled by the SNS second target station will support major discoveries in earth sciences, environmental chemistry, catalysis science, structural biology, and the design of pharmaceuticals for diagnosis and cure of major diseases.

Priority: Tie for 14 Whole Proteome Analysis

The Facility: The Whole Proteome Analysis facility will provide researchers with the ability to investigate how microbes adapt to changes in their environment by turning certain portions of their genome “on” and “off.”

Background: The entire complement of proteins a microbe makes under different environmental conditions is called its proteome. A microbe does not make all the proteins encoded in its genome all the time; rather it makes only the set required at a given moment—to reproduce, for example, or survive in contaminated environments. By knowing which part of a microbe’s proteome is “turned on” in certain conditions, scientists can learn how to best use them to address practical needs.

What’s New: Currently, there is no way to determine in a reasonable amount of time what part of a microbe’s genome becomes active in different conditions and environments. Because this facility will be able to generate thousands of measurements for broad classes of microbes under many different conditions, it will enable scientists to do in a few days what would otherwise take many months, and it will transform how scientists are able to study microbes as complete biological systems.

Applications: The applications of microbial biotechnology cross boundaries from medicine and food to energy and environmental resources. Just as the technology and resources developed by the Human Genome Project are already having a major impact on the U.S. economy (sales of DNA-based products and technologies in the biotechnology industry are projected to exceed \$45 billion by 2009), this new capability will open the door to the study of the practical applications of microbes—another potentially huge industry—and a source of solutions to environmental and energy challenges.

Priority: Tie for 18 Double Beta Decay Underground Detector

The Facility: The underground double beta decay detector will enable measurements of individual neutrino mass and determination of whether the neutrino and its anti-particle are identical.

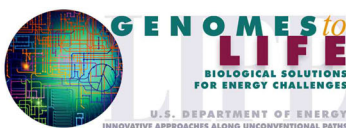

Proteomics Facility

Facility for Whole Proteome Analysis

The full complement of proteins encoded in a cell’s genome is its proteome. This facility will characterize the proteins expressed by microbes under controlled conditions. This is an essential step for determining the interactions and functions of individual proteins and sets of proteins.

Accelerating the Pace of Discovery for DOE Mission Applications

Clean, abundant energy



Increase biological sources of fuels (e.g., hydrogen)

Climate stabilization

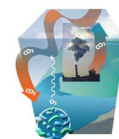

Reduce net CO₂ atmospheric emissions to counter global warming

Environmental cleanup



Save billions of dollars in toxic waste cleanup and disposal

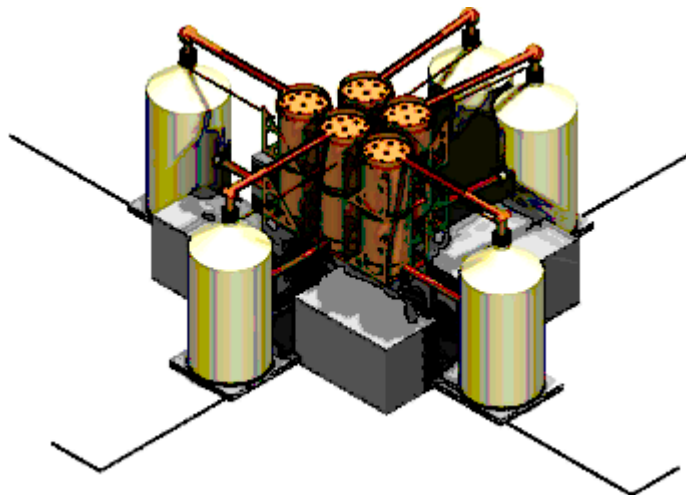

Artist's conception of one particular neutrino-less double beta decay experiment—the Majorana.

more sensitive than any previous such facility, allowing physicists to measure individual neutrino masses and determine whether the neutrino and its anti-particle are identical. If they are found to be identical, it will be clear evidence that some portions of our most fundamental theories of physics are inadequate.

Applications: Recent studies in Japan and Canada have provided clear evidence that neutrinos have mass. This significant discovery contradicts some predictions of the Standard Model of physics (the name given to the current theory of fundamental particles and how they interact). The predicted abundance of neutrinos in the universe and the discovery that they have mass implies that cosmic neutrinos account for as much mass as do stars. Knowing neutrino masses will provide clues to where to look for evidence that the basic forces of the universe become unified in a single force; help explain how neutrinos shaped the evolution of the universe; and give insight into how the elements in the periodic table were made inside stars and supernovas.

Priority: Tie for 18 Next-Step Spherical Torus (NSST) Experiment

The Facility: The NSST will be designed to test the spherical torus, an innovative concept for magnetically confining a fusion reaction, in an experiment large enough to understand how it would perform in a self-sustaining fusion reaction.

Background: One approach to creating energy from fusion—long sought as an abundant, environmentally benign energy source—depends on being able to create a container that will confine the fusion fuel and maintain it at very high temperatures (hundreds of millions of degrees). Magnetic fields are used to trap the superheated fuel in the center of the container so that it cannot touch the walls and cool off. The efficiency of the fusion reaction is related to the shape of the container; the early donut-shaped tokamak may be evolving toward the more elongated and spherical torus.

What's New: The spherical torus has recently emerged as the most promising concept for confining a self-sustaining fusion reaction, or “burning plasma.” Two proof-of-principle level

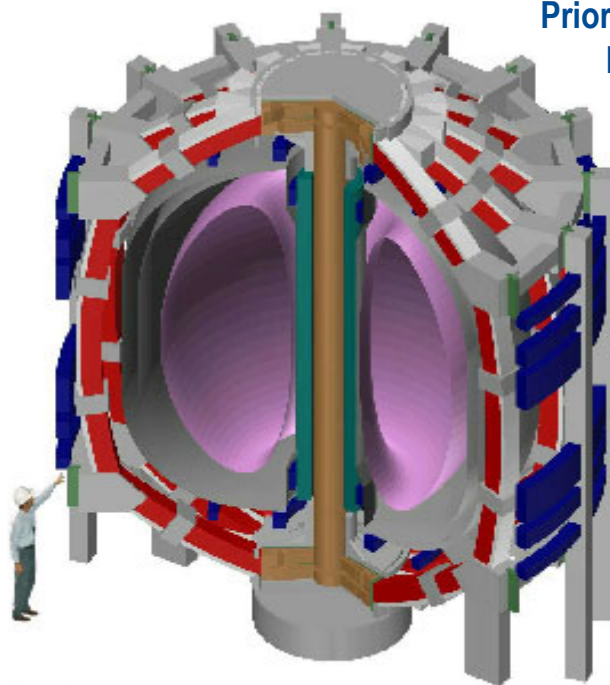

The NSST experiment will test the performance of the spherical torus in a self-sustaining fusion reaction.

experiments, the National Spherical Torus Experiment at Princeton Plasma Physics Laboratory and the Mega Ampere Spherical Tokamak at Culham, England, have produced excellent research results in small-scale experiments. If progress continues as anticipated, it will justify testing the spherical torus in experiments large enough to simulate near-fusion physics, just short of the burning plasma.

Applications: This experiment will contribute substantially to our understanding of the physics of fusion reactions, and will provide the data needed for the design and construction of future fusion energy plants, including those that will follow in the footsteps of ITER.

**Priority: Tie for 18
RHIC II**

The Facility: This upgrade will provide a 10-fold increase in the luminosity (collision rate) of the Relativistic Heavy Ion Collider (RHIC), enabling scientists to create and study atomic particle collision events that happen only rarely, and to explore states of matter believed to have existed during the first moments after the Big Bang.

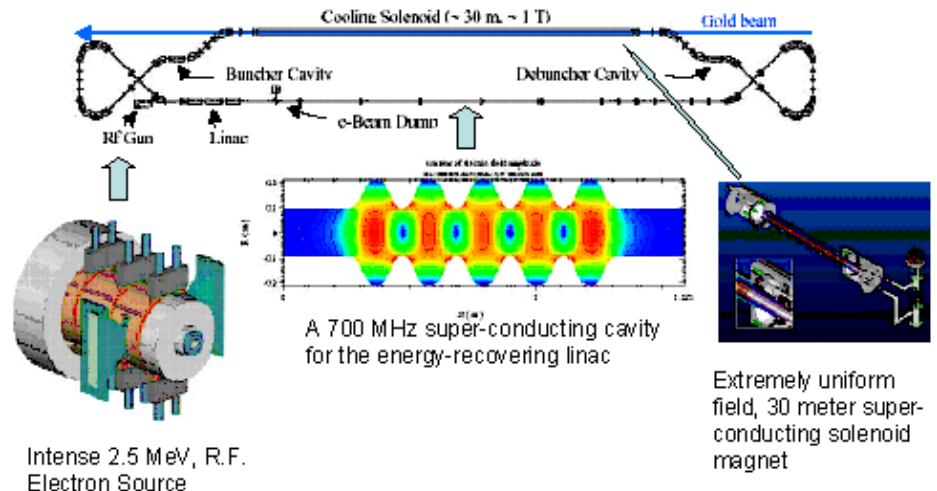

The RHIC II electron cooling system will enable RHIC to increase its collision rate 10-fold and maintain this collision rate for long periods of time.

Background: At the first moments of the creation of the universe all the most fundamental particles that make up matter may have existed in a very hot, diffuse and dissolved state called quark-gluon plasma. From this, it is believed that the universe underwent changes analogous to what happens when steam cools to liquid water, and then cools into solid ice. No researchers have yet demonstrated they have created quark-gluon plasma, but scientists at RHIC believe they are closing in on this important discovery. RHIC is designed to recreate a bit of the quark-gluon plasma by colliding heavy ions, such as gold.

What's New: New electron cooling techniques will enable RHIC II to increase its collision rate 10-fold and maintain this collision rate for far longer periods of time, thus enabling scientists to collect 10 years' worth of experimental data in a single year. Ultimately, research at RHIC II may allow scientists to characterize the phase changes of nuclear matter in terms analogous to those used to describe the behavior of every day matter (temperature and pressure). This would be an extraordinary step forward in our understanding of the relationship between the most fundamental constituents of matter and the matter that we see in the world around us.

Applications: Every day each of us relies on modern technology developed from a basic understanding of the microscopic structure and properties of matter. Examples include personal computers based on state-of-the-art electronics; medical tools that image, help diagnose, and treat disease without surgery; and telecommunications technology that allow us to talk to friends and colleagues around the world from a device smaller than the size of a human hand.

Far-Term Priorities

Priority: Tie for 21 National Synchrotron Light Source Complex Upgrade - NSLS II

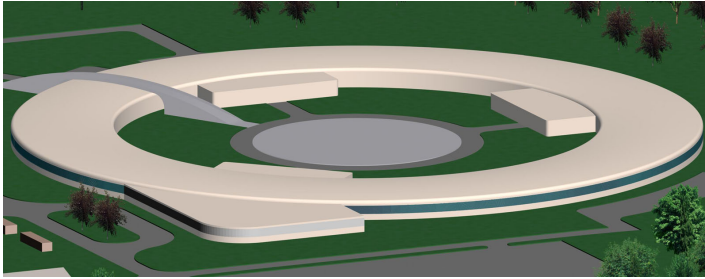

The NSLS II, the first of the next generation synchrotrons, will be brighter, more stable, easier to use, and will accommodate many new types of experiments.

The Facility: The NSLS upgrade will create and install the next generation design for a synchrotron light source storage ring notable for its flexibility to accommodate radically new types of experimental capabilities.

Background: Synchrotrons produce light by accelerating electrons into circular paths called storage rings. As the electrons turn, photons (little packets) of light are given off and travel down pipes called beamlines to work areas where scientists run their

experiments. When this light is aimed at the very small sample under investigation, a complex image of the sample's interaction with light is created on a detector. This image is sent to a computer, which is used to analyze the sample's molecular structure and properties.

What's New: The NSLS Upgrade will be the first of the next generation of synchrotrons. The new design will include a 3-GeV, 500 mA highly optimized storage ring and a broad range of enhanced capabilities: higher average continuous brightness, extreme stability, easy tunability, higher peak brightness, and ultrashort pulses.

Applications: The NSLS at Brookhaven National Laboratory serves 2500 national laboratory, industrial, and academic users per year—a full 40 percent of the total user community for DOE synchrotrons—and is an essential scientific tool for scientists and scientific institutions throughout the northeastern U.S. and beyond. The NSLS facility was designed in the late 1970s; for the research of its formidable user community to continue to flourish, the NSLS must be updated and so continue to provide world-class capabilities.

Priority: Tie for 21 Super Neutrino Beam

The Facility: The Super Neutrino Beam will allow more comprehensive studies of neutrino properties by producing a neutrino beam 10 times more intense than those available with current accelerators.

Background: Neutrinos are the most poorly understood of the elementary particles but may be the most important for answering fundamental questions ranging from why there is any matter in the universe at all, to how all particles and forces in the universe “unify” into a simple picture. Because neutrinos rarely interact with matter (many billions pass through each of us every second), the ability to generate controlled beams containing large numbers of neutrinos greatly increases the ability to study them.

What's New: The Super Neutrino Beam will be powered by a new, megawatt class “proton driver” which will be able to provide an intense, well-controlled neutrino beam—with 10 times more neutrinos per second than are available from any existing facility—to detectors hundreds or thousands of miles distant.

Applications: The 2002 Nobel Prize in physics was shared by two scientists—one American and one Japanese—for their path-breaking measurements of solar and atmospheric neutrinos. Their research strongly suggested that neutrinos have mass and oscillate among three types as they travel through space. These oscillations have recently been confirmed, and the properties and behavior of neutrinos are now ripe for measurement. The results will have profound implications for our understanding of the fundamental properties of matter and the evolution of the early universe.

Priority: Tie for 23 Advanced Light Source Upgrade

The Facility: The ALS upgrade will allow the facility to expand to accommodate new instruments to explore the traditionally difficult spectral region at the border between optics and electronics (called the “terahertz-gap”), and remain a preeminent scientific tool for the U.S. research community.

Background: The ALS at Lawrence Berkeley National Laboratory is one of the world's brightest sources of soft X-rays (ideal for probing the secrets of matter at the level of individual atoms) and ultraviolet light. It supports more than 2000 scientists each year. However, since it began operation a decade ago, light source technology has evolved significantly; substantial improvements in brightness and current will be required to maintain the ALS as the preeminent research tool that it is.

What's New: The upgrade provides for the installation of a full complement of power boosters (called insertion devices, or “undulators” and “wigglers”) in the ALS storage ring; the replacement of three sectors of conventional bend magnets with superconducting bend magnets; and full instrumentation of the insertion devices and superbend beamlines. This will increase the brightness of the ALS in the soft x-ray region 10 to 100 times, and also extend the high energy range of the facility to between 10-keV and 20-keV.

Applications: Research at the ALS will be applicable to an exceptionally wide range of areas—from semiconductors to

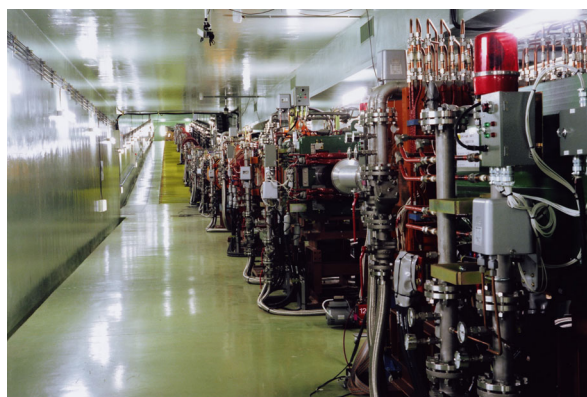

The Super Neutrino Beam will provide 10 times more neutrinos per second than any existing facility—to detectors hundreds or thousands of miles away. This new facility will build on current experiments such as the KEK to Kamiokande (K2K) long baseline neutrino oscillation experiment in Japan, shown above, which sends neutrinos along a beamline from KEK (High Energy Accelerator Research Organization) to the Super Kamiokande detector 250 km (~155 miles) away.



The ALS upgrade will increase its brightness by 10 to 100 times and also extend the high energy range of the facility, making it applicable to an even broader range of research areas such as semiconductors, magnetic materials for computer storage, molecular-scale combustion reactions, and pharmaceutical drug development.

magnetic materials used in computer storage disks, to molecules undergoing rapid reactions in combustion and other industrially important processes, to structures within biological cells that determine how well drugs can fight disease-causing agents such as viruses.

Priority: Tie for 23 Advanced Photon Source (APS) Upgrade



The APS upgrade will greatly enhance the brilliance and power of the facility to enable scientists to study very small sample crystals—important for nanoscience research.

The Facility: The Advanced Photon Source (APS) upgrade will create a “super storage ring” of electrons that will greatly enhance the brilliance of the facility, increasing the power of the device and enabling scientists to work on very small sample crystals. Small samples are important: many current experiments are limited by the fact that the subject materials will not grow into large enough crystals for study.

Background: The APS at Argonne National Laboratory was commissioned in 1996. It currently provides the brightest x-ray beams available in the Western Hemisphere for a wide range of research from materials science to structural biology. The 1,104-meter circumference storage ring of the APS, which is large enough to house a baseball park in its center, produces, accelerates, and stores a beam of

subatomic particles that is the source of the x-ray beams that feed numerous experimental stations. The APS will support more than 4000 users on 70 beamlines.

What’s New: This eventual APS upgrade will replace and upgrade major components of the accelerator to further increase performance in the hard x-ray region of the spectrum, most notably x-ray photon correlation spectroscopy, coherent imaging, inelastic scattering, and x-ray nanoprobe microscopes. The upgrade will be necessary to keep the APS among the best of the hard x-ray facilities, and ensure that its performance and scientific output continue to be ground-breaking.

Applications: Using high-brilliance x-ray beams from the APS, members of the international synchrotron-radiation research community have achieved major advances in basic and applied research in the fields of materials science; biological science; physics; chemistry; environmental, geophysical, and planetary science; archeology; and innovative x-ray instrumentation.

Priority: Tie for 23 eRHIC

The Facility: An electron accelerator ring added to the existing Relativistic Heavy Ion Collider (RHIC) would create the world’s first electron-heavy ion collider (eRHIC). The facility will enable scientists to learn things about the structure of protons, and the subatomic particles that bind them, that they could learn in no other way.

Background: Current theory holds that atoms are composed of protons and neutrons, which in turn are composed of particles called quarks, held together by gluons. Both quarks and gluons are little understood. While most existing and contemplated nuclear physics facilities are designed for the study of quarks, eRHIC is intended to create and study gluons, which bind subatomic particles.

What's New: The addition of a polarized electron source and 10 GeV energy electron ring to the current RHIC facility will enable eRHIC to create enormous numbers of gluons—in effect a saturated “gluonic” state of matter—giving scientists a unique opportunity and approach to probe the substructure of particles.

Applications: Einstein’s famous equation, $E=mc^2$, predicts that small amounts of mass can be transformed into large amounts of energy, and that the reverse is also possible. Although we have demonstrated this prediction and its practical applications (nuclear weapons, among other things, are based on this principle), the truth is that we do not yet understand *how* the process works—the underlying mechanisms by which mass is transformed into energy and vice versa. eRHIC will allow scientists to tackle this very fundamental question in physics.

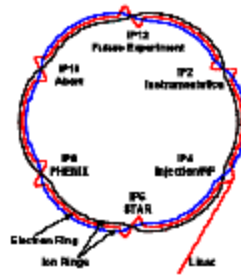

Schematic layout of the injection linac, electron ring and the two ion rings. "Ring-Ring" Option



Schematic of electron-proton/ion collider based on the recirculating "linac-on-ring" concept.

Adding an electron accelerator ring to the existing RHIC at Brookhaven National Laboratory will create eRHIC, the world’s first electron-heavy ion collider, which in turn will create enormous numbers of gluons for scientists to study.

Priority: Tie for 23 Fusion Energy Contingency

The Facility: The fusion energy contingency includes funds set aside in anticipation of a successful outcome of the ITER project. If ITER construction and operation goes forward as planned, additional facilities to develop and test power plant components and materials will be needed to complete the process of making fusion energy a viable commercial energy resource by mid-century.

Background: Neutrons created during the course of fusion reactions interact with the metals used to build the current generation of fusion containment devices, causing brittleness, swelling and deformation, and induced radioactivity. Some steel alloys have been identified that appear to be less susceptible to the induced radioactivity, but how they will hold up in a power plant is unknown. This is but one of the materials and component design challenges that must be addressed before fusion is a commercial energy source.

What's New: To be determined as ITER progresses.

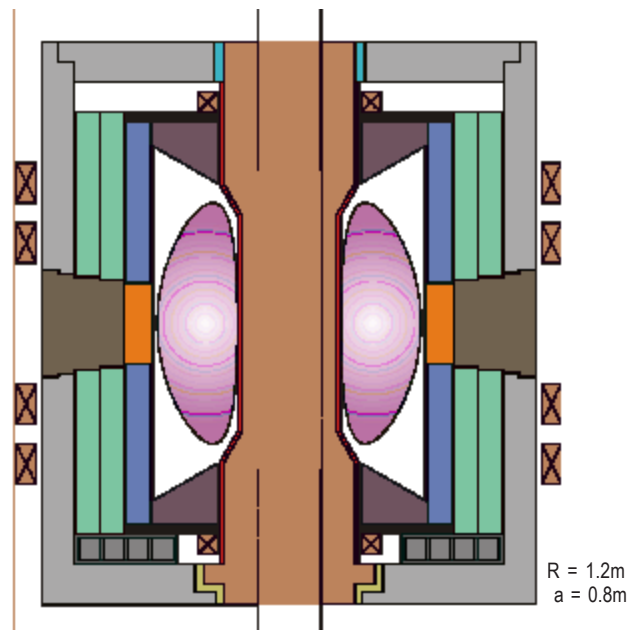

The Component Test Facility will qualify materials and components for use in fusion demos.

Applications: Research facilities supported by the fusion energy contingency will have immediate, practical application in making the first generation of fusion power plants a reality.

Priority: Tie for 23 High-Flux Isotope Reactor (HFIR) Second Cold Source and Guide Hall

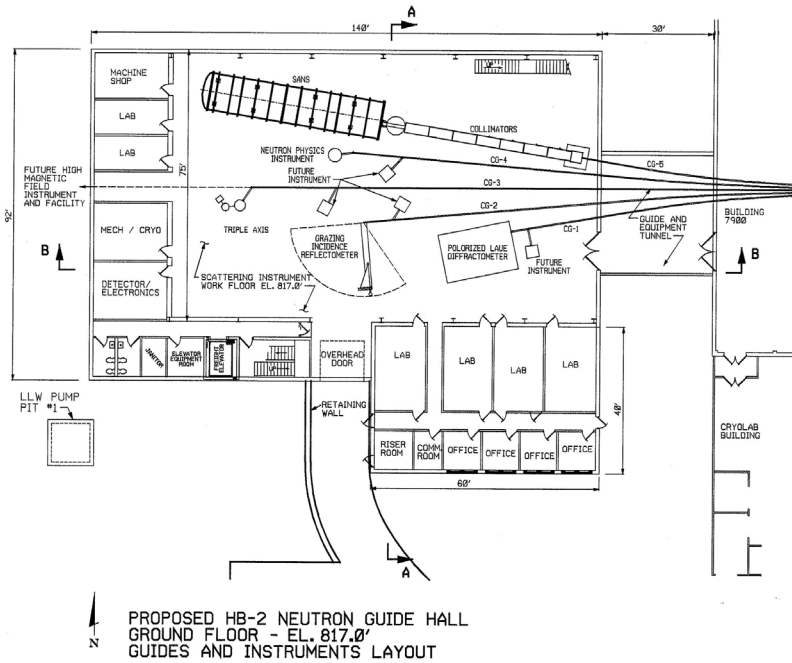

The High Flux Isotope Reactor at Oak Ridge National Laboratory has been one of the world's most powerful research reactors since 1966. This illustration is a floor plan (top) and artist's conception of the HFIR Guide Hall (bottom).

The Facility: Construction of the cold source and guide hall at HFIR will complete the facility, more than doubling its capabilities, and accommodating new instruments that will position HFIR among the world's premiere research facilities for the analysis of large structures (e.g., proteins) and new materials only available in small quantities.

Background: A major direction in neutron scattering research is the study of large-scale structures and dynamics typical of soft materials, biological systems, and self-organized electronic and magnetic phenomena—all of which are more effectively studied using so-called “cold neutrons.” Europe has five such sources, most of which are over-subscribed, and is constructing two more. The U.S. currently has only one cold guide hall in operation, with another moderate power source nearing completion at HFIR.

What's New: The second cold source and guide hall will take advantage of the large diameter and high brightness of the HB-2 beam port at HFIR to develop the world's most intense cold neutron facility. It will include a new guide hall, an initial suite of five instruments (up to 10 eventually), and user offices and support space. These additions will complement the proposed Long Wavelength Target Station at the Spallation Neutron Source and provide the world's foremost cold neutron research capability.

Applications: The resulting impact on science would be enormous: it will allow for the study of new materials only available in small quantities, such as correlated systems (e.g., superconductors),

nano-fabricated specimens (e.g., ultra-thin films), biological samples, pharmaceuticals, and weakly scattering systems (e.g., dilute bio-solutions). Currently available facilities are simply inadequate to address these and many other issues in materials and biological science.

Priority: Tie for 23 Integrated Beam Experiment (IBX)

The Facility: The IBX will be an intermediate-scale experiment to understand how to generate and transmit the focused, high energy ion beam needed to power an inertial fusion energy reaction.

Background: To explore the feasibility of economical fusion power plants, the Department of Energy is pursuing two alternative approaches to creating fusion energy. One involves confining the reaction with magnetic fields (as would be done at ITER); the other uses a very focused, high-energy pulse of radiation to compress and ignite a small capsule of fusion fuel. This second approach is called inertial fusion energy.

What's New: The IBX will involve the design and construction of a linear accelerator, superconducting quadrupole magnets, and focusing system that can generate very stable and intense ion beams, accelerate and compress them, guide them to travel in parallel without interacting, and yet be able to focus them on a very small fuel target. Understanding how best to integrate the design factors to create such a beam is the major goal of the IBX.

Applications: The scientific research in IBX, coupled with research from the DOE National Nuclear Security Administration's National Ignition Facility, will provide new insight into the possible advantages of using inertial fusion energy techniques as an alternative to magnetic confinement to generate fusion energy.

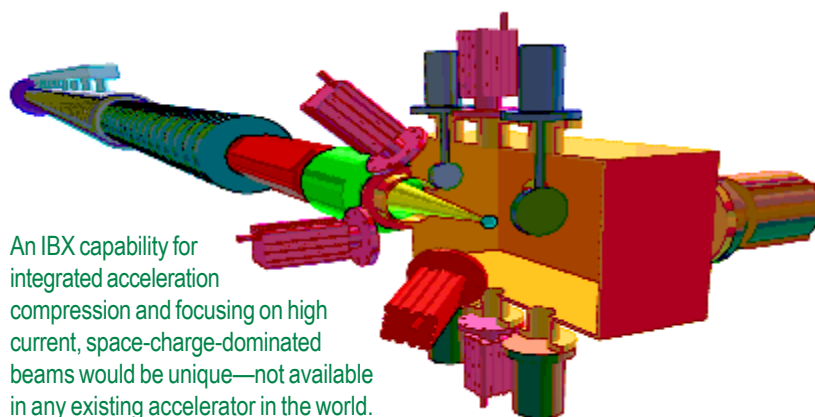

Appendix

Sample Charge Letter to Advisory Committees

December 18, 2002

Dr. Keith O. Hodgson
Director
Stanford Synchrotron Radiation Laboratory
Department of Chemistry
Stanford University
Stanford, CA 94305

Dear Dr. Hodgson:

For more than a half-century, the Department of Energy's Office of Science has envisioned, designed, constructed, and operated many of the premiere scientific research facilities in the world. More than 17,000 researchers and their students from universities, other government agencies, private industry, and from abroad use Office of Science facilities each year—and this number is growing. For example, the light sources built and operated by DOE now serve more than three times the total number of users, and twenty times as many users from the life sciences, as they did in 1990.

Creating these facilities for the benefit of science is at the core of our mission and is part of our unique contribution to our Nation's scientific strength. It is important that we continue to do what we do best: build facilities that create institutional capacity for strengthening multidisciplinary science, provide world class research tools that attract the best minds, create new capabilities for exploring the frontiers of the natural and physical sciences, and stimulate scientific discovery through computer simulation of complex systems.

To this end, I am asking all the Office of Science's Advisory Committees to join me in taking a new look at our scientific horizon, and to discuss with me what new or upgraded facilities will best serve our purposes over a timeframe of the next twenty years. More specifically, I charge the committees to establish a subcommittee to:

- A. Consider what new or upgraded facilities in your discipline will be necessary to position the Office of Biological and Environmental Research at the forefront of scientific discovery. Please start by reviewing the attached list of facilities, assembled by Dr. Aristides Patrinos and his team, subtracting or adding as you feel appropriate, with prudence as to cost and timeframe. For this exercise please consider only facilities/upgrades requiring a minimum investment of \$50 million.

- B. Provide me with a report that discusses each of these facilities in terms of two criteria:
1. The *importance of the science* that the facility would support. Please consider, for example: the extent to which the proposed facility would answer the most important scientific questions; whether there are other ways or other facilities that would be able to answer these questions; whether the facility would contribute to many or few areas of research; whether construction of the facility will create new synergies within a field or among fields of research; and what level of demand exists within the scientific community for the facility. In your report, please categorize the facilities in three tiers, such as “absolutely central,” “important,” and “don’t know enough yet,” according to the potential importance of their contribution. Please do not rank order the facilities.
 2. The *readiness* of the facility for construction. Please think about questions such as: whether the concept of the facility has been formally studied in any way; the level of confidence that the technical challenges involved in building the facility can be met; the sufficiency of R&D performed to date to assure technical feasibility of the facility; and the extent to which the cost to build and operate the facility is understood. Group the facilities into three tiers according to their readiness, using categories such as “ready to initiate construction,” “significant scientific/engineering challenges to resolve before initiating construction,” and “mission and technical requirements not yet fully defined.”

Many additional criteria, such as expected funding levels, are important when considering a possible portfolio of future facilities; however for the moment I ask that you focus your thoughts on the two criteria discussed above.

I look forward to hearing your findings and discussing these with you in the future. I would appreciate at least a preliminary report by March, 2003.

Sincerely,

Dr. Raymond L. Orbach
Director
Office of Science

DOE Office of Science Advisory Committees (as of February/March 2003)

Following are the rosters of the DOE Office of Science's six program offices' advisory committees as they were constituted when, as requested, they recommended major facilities for construction to the Director of the Office of Science early in 2003:

Advanced Scientific Computing Advisory Committee (ASCAC)

Chair:

Dr. Margaret H. Wright
Computer Science Department
Courant Institute of Mathematical
Sciences
New York University
New York, NY

Co-Chair:

Dr. John W. D. Connolly
Center for Computational Sciences
University of Kentucky
Lexington, KY

Dr. Jill P. Dahlburg
Naval Research Laboratory
Washington, DC

Dr. Roscoe C. Giles
Associate Professor
Center for Computational Science
Boston University
Boston, MA

Ms. Helene E. Kulsrud
Center for Communications
Research
Princeton, NJ

Dr. William A. Lester, Jr.
Department of Chemistry
University of California, Berkeley
Berkeley, CA

Dr. Juan Mesa
Computing Research Division
Lawrence Berkeley National
Laboratory
Berkeley, CA

Dr. Gregory J. McRae
Massachusetts Institute of
Technology
Department of Chemical
Engineering
Cambridge, MA

Dr. Karen R. Sollins
Massachusetts Institute of
Technology
Cambridge, MA

Dr. Ellen B. Stechel
Ford Motor Company
Powertrain Operations and Engine
Engineering
Dearborn, MI

Dr. Stephen Wolff
Cisco Systems
Washington, DC

Basic Energy Sciences Advisory Committee (BESAC)

Chair:

Dr. Geraldine L. Richmond
Department of Chemistry
University of Oregon
Eugene, OR

Vice Chair:

Dr. Mostafa El-Sayed
Director, Laser Dynamics
Laboratory
School of Chemistry and
Biochemistry
Georgia Institute of Technology
Atlanta, GA

Vice Chair:

Dr. C. Bradley Moore
Vice President for Research and
Professor of Chemistry
Ohio State University
Columbus, OH

Dr. Nora Berrah
Department of Physics
Western Michigan University
Kalamazoo, MI

Dr. Collin Broholm
Department of Physics and
Astronomy
Johns Hopkins University
Baltimore, MD

Dr. Philip Bucksbaum
Department of Physics
University of Michigan
Ann Arbor, MI

Dr. Patricia Dove
Department of Geological Sciences
Virginia Polytechnic Institute and
State University
Blacksburg, VA

Dr. George Flynn
Higgins Professor
Department of Chemistry
Columbia University
New York, NY

Dr. Wayne Goodman
Department of Chemistry
Texas A&M University
College Station, TX

Dr. Laura Greene
Department of Physics
University of Illinois
Urbana, IL

Dr. Eric Isaacs
Director, Semiconductor Physics
Research
Bell Laboratories
Lucent Technologies
Murray Hill, NJ

Dr. John C. Hemminger
Professor of Chemistry
Department of Chemistry
University of California, Irvine
Irvine, CA

Dr. Anthony Johnson
Department of Physics
New Jersey Institute of Technology
Newark, NJ

Dr. Walter Kohn
Department of Physics
University of California, Santa
Barbara
Santa Barbara, CA

Dr. Gabrielle Long
Ceramics Division
National Institute of Standards and
Technology
Gaithersburg, MD

Dr. Anne Mayes
Professor of Polymer Physics
Massachusetts Institute of
Technology
Cambridge, MA

Dr. William McCurdy, Jr.
Lawrence Berkeley National
Laboratory
Berkeley, CA

Dr. Daniel Morse
Molecular Genetics and
Biochemistry
University of California, Santa
Barbara
Santa Barbara, CA

Dr. Martin Moskovits
Dean, Mathematical, Life and
Physical Sciences
College of Letters and Sciences
University of California, Santa
Barbara
Santa Barbara, CA

Dr. Cherry Murray
Bell Laboratories
Lucent Technologies
Murray Hill, NJ

Dr. Ward Plummer
Distinguished Professor of Physics
University of Tennessee
Knoxville, TN

Dr. John Richards
Professor of Organic Chemistry
California Institute of Technology
Pasadena, CA

Dr. Richard Smalley
Department of Chemistry
Rice University
Houston, TX

Dr. Joachim Stohr
Deputy Director
Stanford Synchrotron Radiation
Laboratory
Stanford, CA

Dr. Samuel Stupp
Materials Science and Engineering
and Chemistry
Northwestern University
Evanston, IL 60208

Dr. Kathleen Taylor
Birmingham, MI

Dr. Rudolf Tromp
IBM Research Division
Thomas J. Watson Research Center
Yorktown Heights, NY

Dr. R. Stanley Williams
HP Fellow and Director
Quantum Science Research
Hewlett-Packard Laboratories
Palo Alto, CA

Dr. Mary J. Wirth
C. Eugene Bennett Professor
Department of Chemistry and
Biochemistry
University of Delaware
Newark, DE

Biological and Environmental Research Advisory Committee (BERAC)

Chair:

Dr. Keith O. Hodgson
Director, Stanford Synchrotron
Radiation Laboratory
Department of Chemistry
Stanford University
Stanford, CA

Dr. S. James Adelstein
Harvard Medical School
Boston, MA

Dr. John F. Ahearne
Sigma Xi, The Scientific Research
Society
Research Triangle Park, NC

Dr. Eugene W. Bierly
Director for Education and
Research
American Geophysical Union
Washington, DC

Dr. Michelle S. Broido
Associate Vice Chancellor for Basic
Biomedical Research and
Director, Office of Research,
Health Sciences
University of Pittsburgh
Pittsburgh, PA

Dr. David R. Burgess
Department of Biology
Boston College
Chestnut Hill, MA

Dr. Carlos J. Bustamante
Department of Molecular and Cell
Biology and Department of
Physics
University of California, Berkeley
Berkeley, CA

Dr. Charles DeLisi
College of Engineering
Boston University
Boston, MA

Mr. Robert W. Fri
Bethesda, MD

Dr. Raymond F. Gesteland
Department of Human Genetics
University of Utah
Salt Lake City, UT

Dr. Jonathan Greer
Department of Structural Biology
Abbott Laboratories
Abbott Park, IL

Dr. Richard E. Hallgren
Executive Director
American Meteorological Society
Washington, DC

Dr. Willard W. Harrison
Professor of Chemistry
University of Florida
Gainesville, FL

Dr. Leroy E. Hood
President, Institute for Systems
Biology
Seattle, WA

Steven M. Larson, M.D.
Chief, Nuclear Medicine Service
Memorial Sloan-Kettering Cancer
Center
New York, NY

Roger O. McClellan, DVM
Advisor, Toxicology and Human
Health Risk Analysis
Albuquerque, NM

Dr. Jill P. Mesirov
Whitehead Institute
Massachusetts Institute of
Technology
Center for Genome Research
Cambridge, MA

Dr. James W. Mitchell
Director, Materials and Ecology
Research
Bell Laboratories
Lucent Technologies
Murray Hill, NJ

Dr. Louis F. Pitelka
Director and Professor
Appalachian Laboratory
Frostburg, MD

Dr. Janet L. Smith
Department of Biological Sciences
Purdue University
West Lafayette, IN

Dr. Lisa Stubbs
Human Genome Center
Lawrence Livermore National
Laboratory
Livermore, CA

Dr. James M. Tiedje
Director, The Center for Microbial
Ecology
Michigan State University
East Lansing, MI

Nora D. Volkow, M.D.
Medical Department
Brookhaven National Laboratory
Upton, NY

Dr. Warren M. Washington
National Center for Atmospheric
Research
Boulder, CO

Dr. Barbara J. Wold
Division of Biology
California Institute of Technology
Pasadena, CA

Fusion Energy Sciences Advisory Committee

Chair:

Dr. Richard D. Hazeltine
Institute for Fusion Studies
University of Texas at Austin
Austin, TX

Vice Chair:

Dr. Charles C. Baker
Virtual Laboratory for Technology
University of California, San Diego
La Jolla, CA

Dr. Riccardo Betti
Department of Physics and
Astronomy
University of Rochester
Rochester, NY

Dr. Jill P. Dahlburg
Fusion Group
General Atomics
San Diego, CA

Dr. Jeffrey P. Freidberg
Plasma Science and Fusion Center
Massachusetts Institute of
Technology
Cambridge, MA

Dr. Martin J. Greenwald
Plasma Science and Fusion Center
Massachusetts Institute of
Technology
Cambridge, MA

Dr. Joseph J. Hoagland
Public Power Institute
Tennessee Valley Authority
Muscle Shoals, AL

Dr. Joseph A. Johnson, III
Florida A&M University
Tallahassee, FL

Dr. Rulon K. Linford
Office of the President
University of California
Oakland, CA

Dr. Kathryn McCarthy
Idaho National Engineering and
Environmental Laboratory
Fusion Safety Program
Bechtel B&W Idaho, LLC
Idaho Falls, ID

Dr. George Morales
Physics and Astronomy Department
University of California, Los
Angeles
Los Angeles, CA

Dr. Gerald A. Navratil
Department of Applied Physics
Columbia University
New York, NY

Dr. Cynthia K. Phillips
Princeton Plasma Physics
Laboratory
Princeton, NJ

Dr. Marshall N. Rosenbluth
(deceased September 28, 2003)
General Atomics
Fusion Group
San Diego, CA

Dr. Ned R. Sauthoff
Princeton Plasma Physics
Laboratory
Princeton, NJ

Dr. John Sheffield
Joint Institute for Energy and
Environment
Knoxville, TN

Dr. Edward Thomas, Jr.
Auburn University
Physics Department
Auburn University
Auburn, AL

High Energy Physics Advisory Panel

Chair:

Dr. Frederick J. Gilman
Department of Physics
Carnegie Mellon University
Pittsburgh, PA

Dr. Paul R. Avery
Department of Physics
University of Florida
Gainesville, FL

Dr. Jonathan A. Bagger
Department of Physics and
Astronomy
Johns Hopkins University
Baltimore, MD

Dr. Keith Baker
Physics Department
Hampton University
Hampton, VA

Dr. Joel Butler
Particle Physics Division
Fermi National Accelerator
Laboratory
Batavia, IL

Dr. Ronald C. Davidson
Astrophysical Sciences Program in
Plasma Physics
Princeton University and Deputy
Director of Theory Group
Princeton Plasma Physics
Laboratory
Princeton, NJ

Dr. David G. Hitlin
Lauritsen Laboratory
California Institute of Technology
Pasadena, CA

Dr. Young-Kee Kim
Department of Physics
University of Chicago
Chicago, IL

Dr. Paul G. Langacker
Department of Physics and
Astronomy
University of Pennsylvania
Philadelphia, PA

Dr. Angel M. Lopez
Physics Department
University of Puerto Rico
Mayaguez, Puerto Rico

Dr. Vera G. Luth
Stanford Linear Accelerator Center
Stanford, CA

Dr. Rene Ong
Department of Physics and
Astronomy
University of California, Los
Angeles
Los Angeles, CA

Dr. J. Ritchie Patterson
Newman Laboratory
Cornell University
Ithaca, NY

Dr. Stephen G. Peggs
Collider-Accelerator Department
Brookhaven National Laboratory
Upton, NY

Dr. Natalie A. Roe
Department of Physics
Lawrence Berkeley National
Laboratory
Berkeley, CA

Dr. Randal Ruchti
Department of Physics
University of Notre Dame
Notre Dame, IN

Dr. John T. Seeman
Stanford Linear Accelerator Center
Stanford, CA

Dr. Stanley G. Wojcicki
Department of Physics
Stanford University
Stanford, CA

**NSF/DOE Nuclear Science Advisory
Committee (NSAC)**

Chair:

Dr. Richard F. Casten
A.W. Wright Nuclear Structure Lab
Yale University
New Haven, CT

Dr. Ricardo Alarcon
Department of Physics and
Astronomy
Arizona State University
Tempe, AZ

Dr. Jolie A. Cizewski
Department of Physics and
Astronomy
Rutgers University
Piscataway, NJ

Dr. Kees W. de Jager
Thomas Jefferson National
Accelerator Facility
Newport News, VA

Dr. Stuart Freedman
Department of Physics
University of California, Berkeley
Berkeley, CA

Dr. Alejandro Garcia
Department of Physics
University of Washington
Seattle, WA

Dr. Charles Glashauser
Physics Division
Argonne National Laboratory
Argonne, IL

Dr. Robert V. F. Janssens
Physics Division
Argonne National Laboratory
Argonne, IL

Dr. Krishna S. Kumar
Nuclear Physics Group
Department of Physics and
Astronomy
University of Massachusetts
Amherst, MA

Dr. June Matthews
Laboratory for Nuclear Science
Massachusetts Institute of
Technology
Cambridge, MA

Dr. Larry D. McLerran
Physics Department, Nuclear
Theory
Brookhaven National Laboratory
Upton, NY

Dr. Alice C. Mignerey
Department of Chemistry
University of Maryland
College Park, MD

Dr. Joel M. Moss
Los Alamos National Laboratory
Los Alamos, NM

Dr. Witold Nazarewicz
Department of Physics and
Astronomy
University of Tennessee
Knoxville, TN

Dr. Vijay R. Panharipande
Department of Physics
University of Illinois
Urbana, IL

Dr. Winston Roberts
Department of Physics
Old Dominion University
Norfolk, VA

Dr. Richard K. Seto
Department of Physics
University of California, Riverside
Riverside, CA

Bradley M. Sherrill
National Superconducting
Cyclotron Lab
Michigan State University
East Lansing, MI

Dr. Suresh C. Srivastava
Medical Department
Brookhaven National Laboratory
Upton, NY

About DOE's Office of Science

The U.S. Department of Energy's Office of Science is the single largest supporter of basic research in the physical sciences in the United States, providing more than 40 percent of total funding for this vital area of national importance. It oversees—and is the principal Federal funding agency of—the Nation's research programs in high-energy physics, nuclear physics, and fusion energy sciences.

The Office of Science sponsors fundamental research programs in basic energy sciences, biological and environmental sciences, and computational science. In addition, the Office of Science is the Federal Government's largest single funder of materials and chemical sciences, and it supports unique and vital parts of U.S. research in climate change, geophysics, genomics, life sciences, and science education.

The Office of Science manages this research portfolio through six interdisciplinary program offices: Advanced Scientific Computing Research, Basic Energy Sciences, Biological and Environmental Research, Fusion Energy Sciences, High Energy Physics, and Nuclear Physics. In addition, the Office of Science sponsors a range of science education initiatives through its Workforce Development for Teachers and Scientists program.



Thomas Jefferson National Accelerator Facility

The Office of Science makes extensive use of peer review and Federal advisory committees to develop general directions for research investments, to identify priorities, and to determine the very best scientific proposals to support.

The Office of Science also manages 10 world-class laboratories, which often are called the “crown jewels” of our national research infrastructure. The national laboratory system, created over a half-century ago, is the most comprehensive research system of its kind in the world.

Five are multi-program facilities: Argonne National Laboratory, Brookhaven National Laboratory, Lawrence Berkeley National Laboratory, Oak Ridge National Laboratory, and Pacific Northwest National Laboratory. The other five are single-program national laboratories: Ames Laboratory, Fermi National Accelerator

Laboratory, Thomas Jefferson National Accelerator Facility, Princeton Plasma Physics Laboratory, and Stanford Linear Accelerator Center.

The Office of Science oversees the construction and operation of some of the Nation's most advanced R&D user facilities, located at national laboratories and universities. These include particle and nuclear physics accelerators, synchrotron light sources, neutron scattering facilities, supercomputers and high-speed computer networks. Each year these facilities are used by more than 18,000 researchers from universities, other government agencies, and private industry.

The Office of Science is a principal supporter of graduate students and postdoctoral researchers early in their careers. About 50 percent of its research funding goes to support research at 250 colleges, universities, and institutes nationwide.

The Office of Science also reaches out to America's youth in grades K-12 and their teachers to help improve students' knowledge of science and mathematics and their understanding of global energy and environmental challenges.

To attract and encourage students to choose an education in the sciences and engineering, the Office of Science also supports the National Science Bowl, an educational competition for high school students involving all branches of science. Each year, over 12,000 students participate in the contest, and some 300 finalists typically prepare for months to attend the national event in Washington, D.C.



Brookhaven National Laboratory's Relativistic Heavy Ion Collider

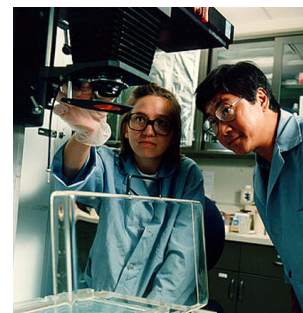

Microbiologists at the Pacific Northwest National Laboratory

Office of Science Contacts

Dr. Raymond L. Orbach, Director
Office of Science, U.S. Department of Energy
SC-1, Forrestal Building
1000 Independence Avenue, S.W.
Washington, D.C. 20585-1290
Phone: 202-586-5430 Fax: 202-586-4120
ray.orbach@science.doe.gov
www.science.doe.gov

Dr. James F. Decker, Principal Deputy Director
Office of Science, U.S. Department of Energy
SC-1, Forrestal Building
1000 Independence Avenue, S.W.
Washington, DC 20585-1290
202-586-5434 Fax: 202-586-4120
james.decker@science.doe.gov

Dr. Milton D. Johnson, Deputy Director
for Operations
Office of Science, U.S. Department of Energy
SC-1, Forrestal Building
1000 Independence Avenue, S.W.
Washington, DC 20585-1290
202-586-5440 Fax: 202-586-4120
milton.johnson@science.doe.gov

Program Offices

Advanced Scientific Computing Research

Dr. C. Edward Oliver, Associate Director
Office of Science, U.S. Department of Energy
SC-30, Germantown Building
1000 Independence Avenue, S.W.
Washington, DC 20585-1290
301-903-7486 Fax: 301-903-4846
ed.oliver@science.doe.gov
www.sc.doe.gov/ascr

Basic Energy Sciences

Dr. Patricia M. Dehmer, Associate Director
Office of Science, U.S. Department of Energy
SC-10, Germantown Building
1000 Independence Avenue, S.W.
Washington, DC 20585-1290
301-903-3081 Fax: 301-903-6594
patricia.dehmer@science.doe.gov
www.sc.doe.gov/bes

Biological and Environmental Research

Dr. Ari Patrinos, Associate Director
Office of Science, U.S. Department of Energy
SC-70, Germantown Building
1000 Independence Avenue, S.W.
Washington, DC 20585-1290
301-903-3251 Fax: 301-903-5051
ari.patrinos@science.doe.gov
www.sc.doe.gov/ober/
ober_top.html

Fusion Energy Sciences

Dr. Anne Davies, Associate Director
Office of Science, U.S. Department of Energy
SC-50, Germantown Building
1000 Independence Avenue, S.W.
Washington, DC 20585-1290
301-903-4941 Fax: 301-903-8584
anne.davies@science.doe.gov
www.ofes.science.doe.gov

High Energy Physics

Dr. Robin Staffin, Associate Director
Office of Science, U.S. Department of Energy
SC-20, Germantown Building
1000 Independence Avenue, S.W.
Washington, DC 20585-1290
301-903-3624 Fax: 301-903-5079
robin.staffin@science.doe.gov
<http://doe-hep.hep.net/home.html>

Nuclear Physics

Dr. Dennis G. Kovar, Associate Director
Office of Science, U.S. Department of Energy
SC-23, Germantown Building
1000 Independence Avenue, S.W.
Washington, DC 20585-1290
301-903-3613 Fax: 301-903-3833
dennis.kovar@science.doe.gov
<http://www.sc.doe.gov/production/henp/np/>

Workforce Development for Teachers and Scientists

Dr. Peter Faletra, Assistant Director
Office of Science, U.S. Department of Energy
SC-1, Forrestal Building
1000 Independence Avenue, S.W.
Washington, DC 20585-1290
202-586-6549 Fax: 202-586-8054
peter.faletra@science.doe.gov
www.scied.science.doe.gov

Facilities for the Future of Science:

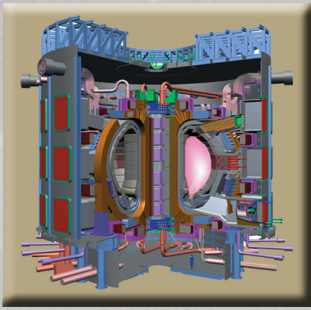

ITER



UltraScale Scientific Computing Capability



Joint Dark Energy Mission



Linac Coherent Light Source



Protein Production and Tags

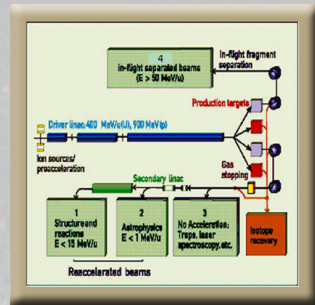

Rare Isotope Accelerator

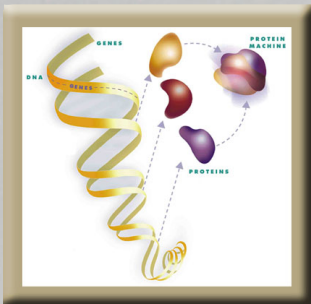

Characterization and Imaging Molecular Machines

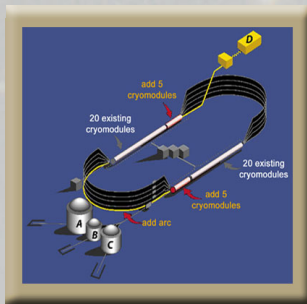

CEBAF 12 GeV Upgrade



ESnet Upgrade



NERSC Upgrade



Transmission Electron Achromatic Microscope

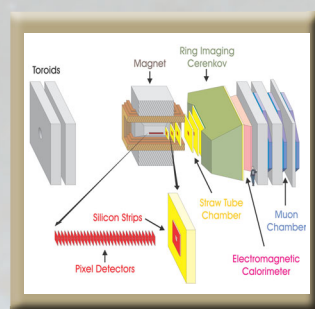

BTev



Linear Collider



Analysis and Modeling of Cellular Systems

A Twenty-Year Outlook



Spallation Neutron Source
2-4 MW Upgrade



Spallation Neutron Source
Second Target Station

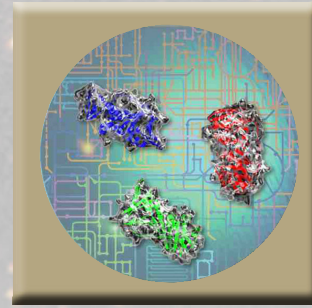

Whole Proteome Analysis

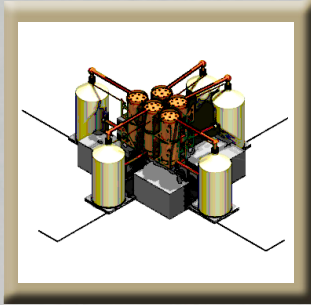

Double Beta Decay
Underground Detector

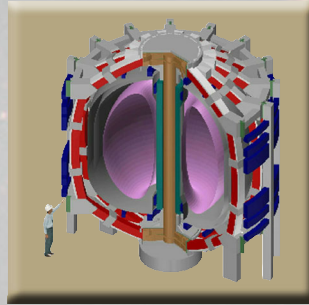

Next-Step Spherical Torus



RHIC II



National Synchrotron
Light Source Upgrade

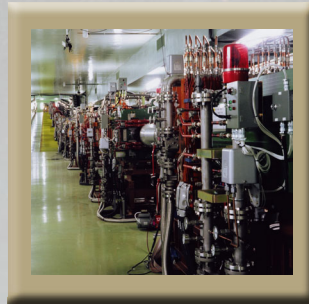

Super Neutrino Beam



Advanced Light Source Upgrade



Advanced Photon
Source Upgrade

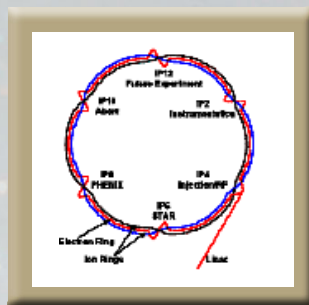

eRHIC

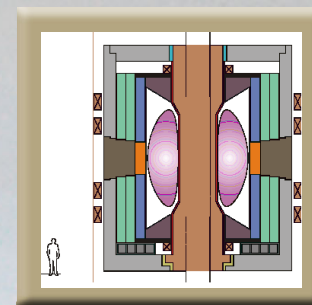

Fusion Energy Contingency



HFIR Second Cold Source
and Guide Hall

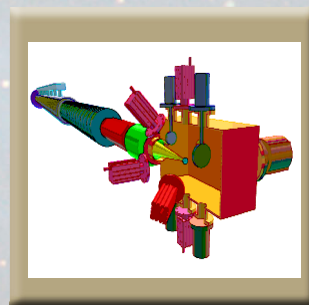

Integrated Beam Experiment

These facilities and upgrades will revolutionize science—and society. They are needed to extend the frontiers of science, to pursue opportunities of enormous importance, and to maintain U.S. science primacy in the world. Investment in these facilities will yield extraordinary scientific breakthroughs—and vital societal and economic benefits.

—Secretary of Energy Spencer Abraham