



The contents of this report are not to be used for advertising, publication, or promotional purposes. Citation of trade names does not constitute an official endorsement or approval of the use of such commercial products.



PRINTED ON RECYCLED PAPER

# **User's Guide to the CE-QUAL-ICM Three-Dimensional Eutrophication Model**

## **Release Version 1.0**

by Carl F. Cerco, Thomas Cole

U.S. Army Corps of Engineers  
Waterways Experiment Station  
3909 Halls Ferry Road  
Vicksburg, MS 39180-6199

Final report

Approved for public release; distribution is unlimited



**US Army Corps  
of Engineers**  
Waterways Experiment  
Station

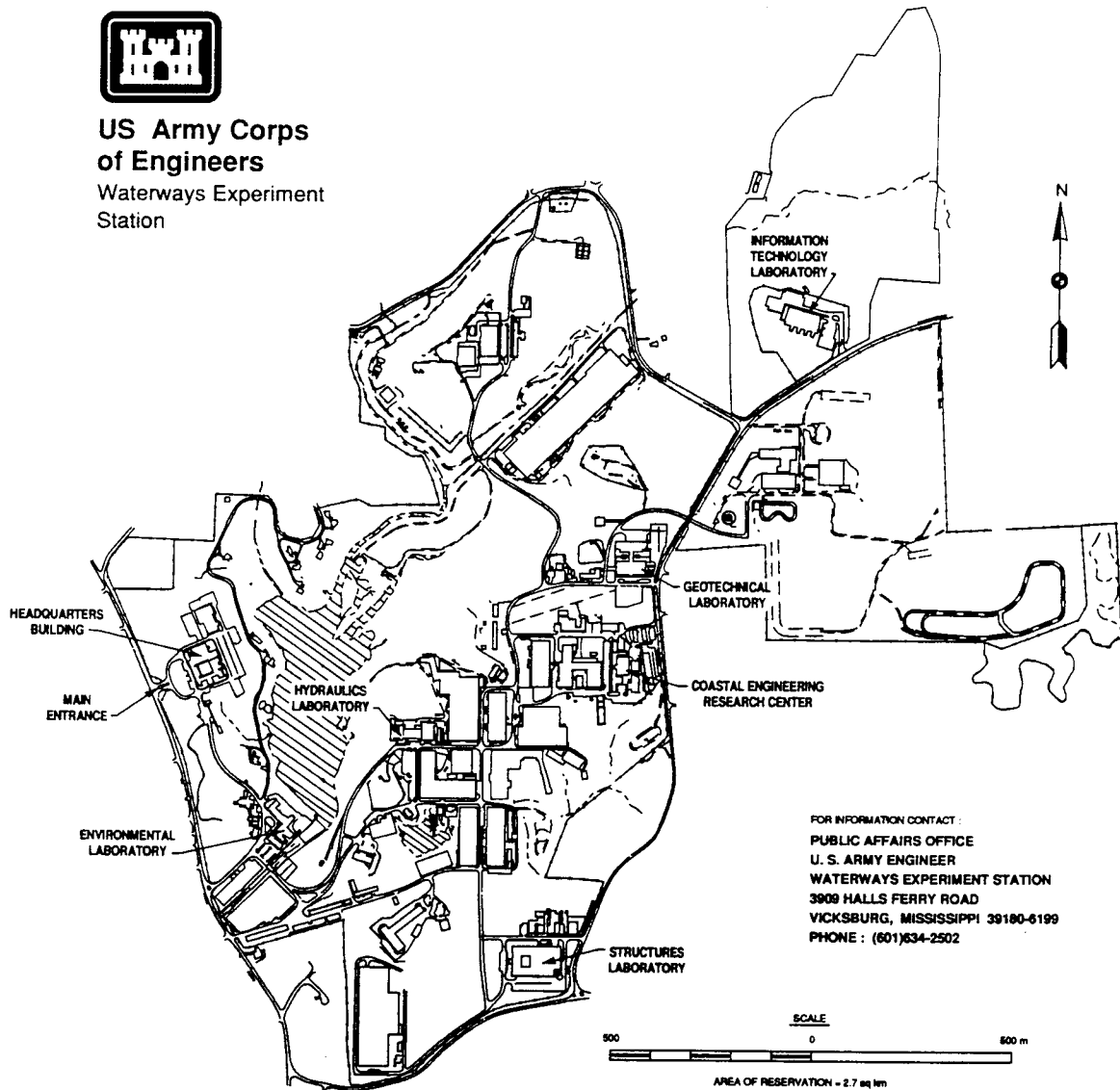

FOR INFORMATION CONTACT:  
PUBLIC AFFAIRS OFFICE  
U. S. ARMY ENGINEER  
WATERWAYS EXPERIMENT STATION  
3909 HALLS FERRY ROAD  
VICKSBURG, MISSISSIPPI 39180-6199  
PHONE: (601)634-2502

### **Waterways Experiment Station Cataloging-in-Publication Data**

Cerco, Carl F.

User's guide to the CE-QUAL-ICM three-dimensional eutrophication model : release version 1.0 / by Carl F. Cerco, Thomas Cole ; prepared for U.S. Army Corps of Engineers.

316 p. : ill. ; 28 cm. -- (Technical report ; EL-95-15)

Includes bibliographic references.

1. Eutrophication -- Mathematical models. 2. Water quality -- Mathematical models. 3. CE-QUAL-ICM (Computer program) I. Cole, Thomas. II. United States. Army. Corps of Engineers. III. U.S. Army Engineer Waterways Experiment Station. IV. Environmental Laboratory (U.S. Army Engineer Waterways Experiment Station) V. Title. VI. Series: Technical report (U.S. Army Engineer Waterways Experiment Station) ; EL-95-15.

TA7 W34 no.EL-95-15

# Contents

---

Preface . . . . .	vi
1—Introduction . . . . .	1-1
Model Features . . . . .	1-1
Model Limitations . . . . .	1-2
Model Structure . . . . .	1-2
Model Programs and Subprograms . . . . .	1-2
Model Input Files . . . . .	1-6
Model Output Files . . . . .	1-9
2—Conservation-of-Mass Equation . . . . .	2-1
Model Grid . . . . .	2-1
Conservation-of-Mass Equation . . . . .	2-3
Discretization of the Conservation Equation . . . . .	2-3
Water Quality Model Time Step . . . . .	2-9
Boundary Conditions . . . . .	2-11
3—Eutrophication Kinetics . . . . .	3-1
Introduction . . . . .	3-1
Algae . . . . .	3-4
Organic Carbon . . . . .	3-22
Phosphorus . . . . .	3-27
Nitrogen . . . . .	3-37
Silica . . . . .	3-44
Chemical Oxygen Demand . . . . .	3-47
Dissolved Oxygen . . . . .	3-48
Total Active Metal . . . . .	3-50
Salinity . . . . .	3-53
Temperature . . . . .	3-53
Glossary . . . . .	3-54
4—Sediment-Water Interactions . . . . .	4-1
User-Specified Fluxes . . . . .	4-1
Predictive Sediment Submodel . . . . .	4-5

5—Kinetics Parameter Evaluation . . . . .	5-1
Algae . . . . .	5-1
Hydrolysis and Mineralization Rates . . . . .	5-15
Detrital Settling Rates . . . . .	5-17
Nitrification . . . . .	5-18
Chemical Oxygen Demand . . . . .	5-18
Particulate Biogenic Silica . . . . .	5-19
Reaeration . . . . .	5-20
Total Active Metal . . . . .	5-20
6—Sediment Parameter Evaluation . . . . .	6-1
User-Specified Fluxes . . . . .	6-1
Predictive Sediment Submodel . . . . .	6-2
7—Control File . . . . .	7-1
8—INCLUDE File . . . . .	8-1
9—Map File . . . . .	9-1
10—Geometry File . . . . .	10-1
11—Initial Conditions File . . . . .	11-1
12—Algal Growth Rate File . . . . .	12-1
13—Settling Velocity File . . . . .	13-1
14—Meteorologic Input File . . . . .	14-1
15—External Loads File . . . . .	15-1
16—Atmospheric Loading File . . . . .	16-1
17—Light Extinction File . . . . .	17-1
18—Spatially Varying Kinetics . . . . .	18-1
19—Boundary Conditions File . . . . .	19-1
20—Submerged Aquatic Vegetation File . . . . .	20-1
21—Hydrodynamics File . . . . .	21-1
22—Benthic Flux Input File . . . . .	22-1
23—ASCII Output Files . . . . .	23-1
Snapshot File . . . . .	23-1
Benthic Flux Output File . . . . .	23-2
Diagnostic File . . . . .	23-2
24—Binary Output Files . . . . .	24-1
Initial Conditions Output File . . . . .	24-1
Restart Output File . . . . .	24-1
Plot File . . . . .	24-2
Average Plot . . . . .	24-8

Transportation Flux File . . . . .	24-9
Mass-Balance File . . . . .	24-11
Kinetics Flux File . . . . .	24-14
Oxygen Volume Output File . . . . .	24-18
References . . . . .	Ref-1

SF 298

# Preface

---

Production of this manual was sponsored by the Numerical Model Maintenance Program of the Headquarters, U.S. Army Corps of Engineers (HQUSACE). Proponent was Dr. Ming Tseng, HQUSACE.

The manual was produced by Dr. Carl F. Cerco and Mr. Thomas Cole, Water Quality and Contaminant Modeling Branch (WQCMB), Environmental Laboratory (EL), U.S. Army Engineer Waterways Experiment Station (WES). Supervision was provided by Dr. Mark Dortch, Chief, WQCMB, and Mr. Donald Robey, Chief, Environmental Processes and Effects Division, EL. Overall supervision was provided by Dr. John Keeley, Director, EL.

At the time of publication of this report, Director of WES was Dr. Robert W. Whalin. Commander was COL Bruce K. Howard, EN.

This report should be cited as follows:

Cerco, C. F., and Cole, T. (1995). "User's guide to the CE-QUAL-ICM three-dimensional eutrophication model, release version 1.0," Technical Report EL-95-15, U.S. Army Engineer Waterways Experiment Station, Vicksburg, MS.

*The contents of this report are not to be used for advertising, publication, or promotional purposes. Citation of trade names does not constitute an official endorsement or approval for the use of such commercial products.*



# 1 Introduction

---

The CE-QUAL-ICM water quality model was developed as one component of a model package employed to study eutrophication processes in Chesapeake Bay (Cercio and Cole 1994). Subsequent to employment in the Bay study, model code was generalized and minor corrections and improvements were installed. The present version of the code is deemed Release Version 1.0.

## Model Features

Features of the model include:

- a.* Operational in one-, two-, or three-dimensional configurations.
- b.* Twenty-two state variables including physical properties; multiple forms of algae, carbon, nitrogen, phosphorus, and silica; and dissolved oxygen.
- c.* Sediment-water oxygen and nutrient fluxes may be computed in a predictive submodel or specified based on observations.
- d.* State variables may be individually activated or deactivated.
- e.* Computations may be restarted following interruption due to computer failure or similar circumstances.
- f.* Internal averaging of model output over arbitrary intervals.
- g.* Computation and reporting of concentrations, mass transport, kinetics transformations, and mass balances.
- h.* Debugging aids include ability to activate or deactivate model features, diagnostic output, volumetric and mass balances.
- i.* Coded in ANSI Standard FORTRAN F77. Operates on a variety of platforms including 486 PC, Silicon Graphics and Hewlett Packard workstations, and Cray Y-MP and C-90 mainframes.

## **Model Limitations**

The model does not compute hydrodynamics. Flows, diffusion coefficients, and volumes must be specified externally and read into the model. Hydrodynamics may be specified in binary or ASCII format. Hydrodynamics are usually obtained from a hydrodynamics model such as the CH3D-WES model (Johnson et al. 1991). Specifics of coupling to CH3D-WES are provided in an appendix to be published in 1995.

The user must provide processors which prepare input files and process output for presentation.

## **Model Structure**

The model consists of a main program, an INCLUDE file, and subroutines (Figure 1-1). Both main program and subroutines perform read and write operations on numerous input and output files.

## **Model Programs and Subprograms**

### **Program MAIN**

The main program has three primary functions which occupy sequential sections of the program. The first function includes setting specifications for the model run and opening input and output files. The second function is solution of the three-dimensional mass-balance equation. The third function is processing of desired output and writing the output to designated files.

### **INCLUDE file**

The INCLUDE file contains specification and DIMENSION statements for variables held in COMMON. The INCLUDE file is incorporated in the MAIN program and subroutines through the FORTRAN "INCLUDE" statement.

### **Subroutine TVDS**

Subroutine TVDS reads time-variable information from designated input files. Files are initially opened in program MAIN. Subsequent OPEN and CLOSE operations are performed in subroutine TVDS.

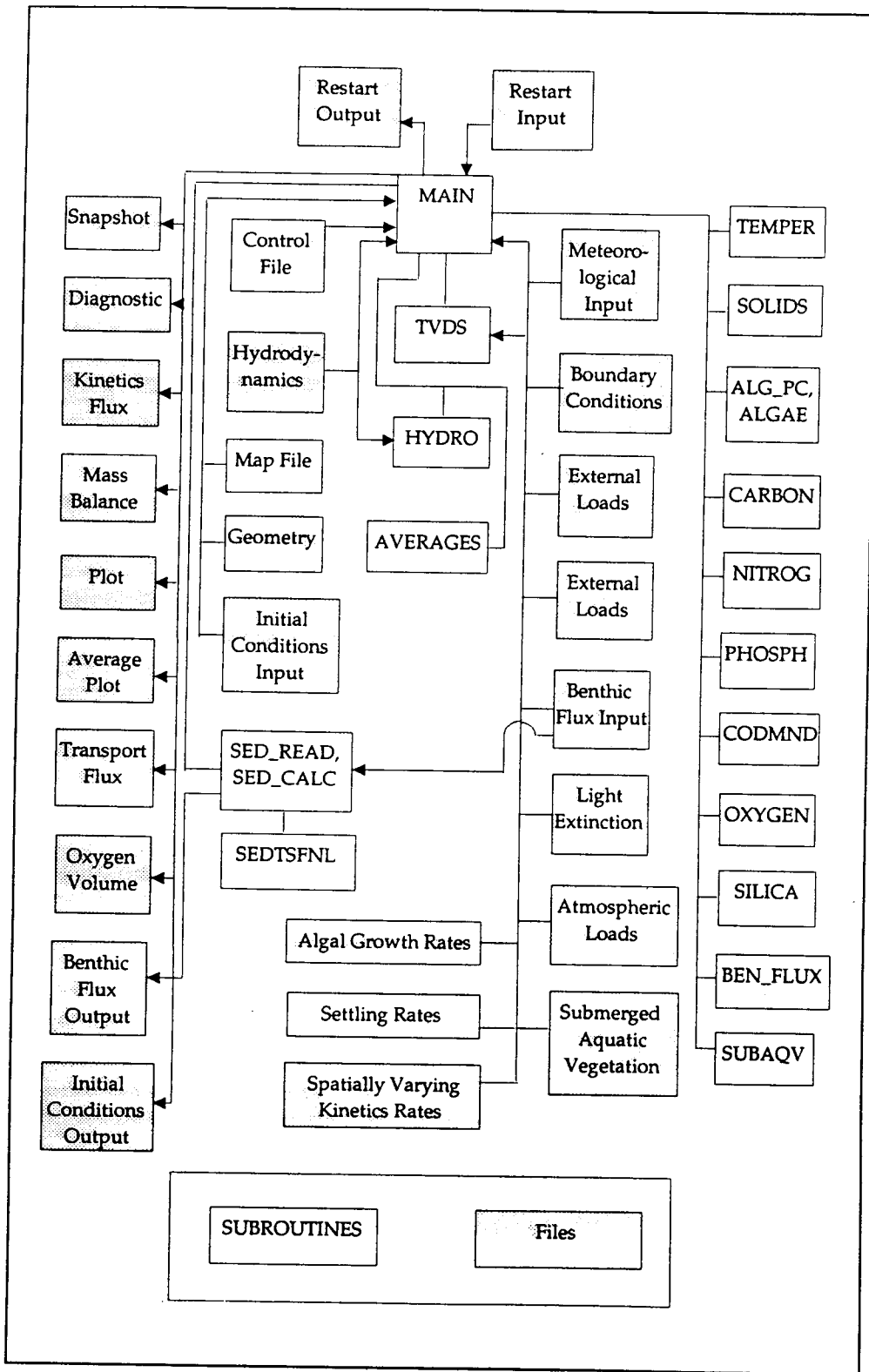

Figure 1-1. Model subroutines and files

### **Subroutine HYDRO**

Subroutine HYDRO reads hydrodynamics information from designated input files. Files are initially opened in program MAIN. Subsequent OPEN and CLOSE operations are performed in subroutine HYDRO.

### **Subroutine AVERAGES**

Subroutine AVERAGES performs temporal averaging on quantities computed internally by the model. The averaged information is written to designated files, at user-specified intervals, by program MAIN.

### **Subroutine TEMPER**

Subroutine TEMPER computes heat transfer through the water surface. The transfer rate is incorporated in the transport equation for temperature in program MAIN.

### **Subroutine SOLIDS**

Subroutine SOLIDS computes the settling of inorganic solids through the water column. Settling computed explicitly in this subroutine is supplied to the mass-balance equation for solids in program MAIN. Settling is treated explicitly so that settling rate can be varied independently of the externally-computed hydrodynamics.

### **Subroutine ALG\_PC, ALGAE**

This subroutine contains two entry points. At entry ALG\_PC, the phosphorus-to-carbon ratio of algae is computed. Computation at this point is required by the mass-balance algorithms. Kinetics and settling for multiple algal groups are computed at entry ALGAE. As with solids, settling is treated explicitly so that settling rate can be varied independently of the externally computed hydrodynamics. Algal settling and kinetics are supplied to the mass-balance equations for the algal groups in program MAIN.

### **Subroutine Carbon**

Kinetic sources and sinks of carbon and settling of the particulate forms are computed in subroutine CARBON. Settling is treated explicitly so that settling rate can be varied independently of the externally computed hydrodynamics. Settling and kinetics are supplied to the mass-balance equations for carbon species in program MAIN.

### **Subroutine NITROG**

Kinetic sources and sinks of nitrogen and settling of the particulate forms are computed in subroutine NITROG. Settling is treated explicitly so that settling rate can be varied independently of the externally computed hydrodynamics. Settling and kinetics are supplied to the mass-balance equations for nitrogen species in program MAIN.

### **Subroutine PHOSP**

Kinetic sources and sinks of phosphorus and settling of the particulate forms are computed in subroutine PHOSP. Settling is treated explicitly so that settling rate can be varied independently of the externally-computed hydrodynamics. Settling and kinetics are supplied to the mass-balance equations for phosphorus species in program MAIN.

### **Subroutine CODMND**

Kinetic sources and sinks of chemical oxygen demand are computed in subroutine CODMND. Kinetics are supplied to the mass-balance equation for chemical oxygen demand in program MAIN.

### **Subroutine OXYGEN**

Kinetic sources and sinks of dissolved oxygen are computed in subroutine OXYGEN. Kinetics are supplied to the mass-balance equation for dissolved oxygen in program MAIN.

### **Subroutine SILICA**

Kinetic sources and sinks of silica and settling of the particulate form are computed in subroutine SILICA. Settling is treated explicitly so that settling rate can be varied independently of the externally-computed hydrodynamics. Settling and kinetics are supplied to the mass-balance equations for silica species in program MAIN.

### **Subroutine BEN\_FLUX**

Subroutine BEN\_FLUX computes sediment-water fluxes of dissolved oxygen and nutrients as functions of temperature and other conditions in the water column. Specification of benthic fluxes is an alternative to employment of the fully-predictive sediment submodel. Fluxes computed in subroutine BEN\_FLUX are provided to kinetics subroutines. From the kinetics

subroutines, the fluxes are supplied to appropriate mass-balance equations in program MAIN.

### **Subroutine SUBAQV**

Subroutine SUBAQV computes mass loading to the water column from submerged aquatic vegetation. Loads must be specified by the user. The present version of the model does not simulate the life cycle of submerged aquatic vegetation. Fluxes computed in subroutine SUBAQV are supplied to the mass-balance equations for appropriate state variables in program MAIN.

### **Subroutine SED\_READ, SED\_CALC**

This subroutine is the major portion of the predictive sediment submodel. The subroutine has two entry points. Input required by the sediment submodel is supplied at entry SED\_READ. Calculation of concentrations and fluxes in the sediments are conducted at entry SED\_CALC.

### **Subroutine SEDTSFNL**

Subroutine SEDTSFNL provides a solution algorithm for a generalized mass-balance equation in the sediments.

## **Model Input Files**

### **Control file**

The control file is the primary input file for the water-quality model. Run specifications, names of additional input and output files, and numerous kinetics parameters are specified in the control file.

### **Hydrodynamics file**

The hydrodynamics file contains transport information used to solve the mass-balance equation. Hydrodynamics may be in binary or ASCII. Multiple hydrodynamics files may be employed. They are opened sequentially in order specified in the control file.

## **Map file**

The water-quality model operates on an “unstructured” grid. Unstructured means that model cells are not referenced in an i-j-k coordinate system. Cells are located, relative to adjacent cells, through the map file.

## **Geometry file**

The contents of the geometry file vary depending on the format of the hydrodynamic input. If hydrodynamics are in ASCII, the geometry file contains cell dimensions and volumes as well as supplementary mapping information. If hydrodynamics are in binary, the geometry file contains supplementary mapping information only. Cell dimensions are input in binary through the hydrodynamic file.

## **Initial conditions input file**

The initial conditions file contains concentrations of state variables, in water and sediment, at initiation of the model run. Multiple options are offered for specification of initial conditions.

## **Restart input file**

The restart input file contains, in binary, all information necessary to restart an interrupted model run. The restart input file must have been created as a restart output file in a previous model run.

## **Meteorological input file**

The meteorological input file contains information required to compute surface heat transfer. The file also contains surface irradiation and daylength employed in computation of algal growth. Multiple files may be employed. They are opened sequentially in order specified in the control file.

## **Boundary conditions file**

The boundary conditions input file contains concentrations of state variables specified at open boundaries. Multiple files may be employed. They are opened sequentially in order specified in the control file.

### **External loads files**

The external loads input files contain location and magnitude of mass loading of state variables. These loads represent point-source loads, distributed nonpoint source loads, and loads from tributaries. Two load files may be opened simultaneously to allow for differentiation of source and timing of loads. Additional files may be opened sequentially in order specified in the control file.

### **Benthic flux input file**

The contents of the benthic flux input file vary depending on the option selected for benthic fluxes. If fluxes are predicted through the sediment submodel, the file contains input to the submodel. Otherwise, the file contains user-specified fluxes and parameters which specify effects of temperature and other influences.

### **Light extinction file**

The light extinction input file specifies light extinction throughout the water column. Extinction is necessary to compute the influence of light on algal growth. Multiple files may be employed. They are opened sequentially in order specified in the control file.

### **Atmospheric load file**

The atmospheric load file contains information necessary to compute atmospheric nutrient loads directly to the water surface. Multiple files may be employed. They are opened sequentially in order specified in the control file.

### **Submerged aquatic vegetation file**

The submerged aquatic vegetation file contains distribution and mass loading information necessary to compute mass loading from vegetation to the water column. Multiple files may be employed. They are opened sequentially in order specified in the control file.

### **Algal growth rates file**

The algal growth rates file contains growth, metabolism, and predation rates for three algal groups. These are specified once, at initiation of the model run, for each cell in the grid.



### **Settling rates file**

The settling rates file contains settling rates for suspended solids, algae, and detritus. These are specified once, at initiation of the model run, for each cell in the grid.

### **Spatially varying kinetics file**

The spatially varying kinetics file contains numerous kinetics rates including organic matter hydrolysis and mineralization, nitrification, and reaeration. All are specified once, at initiation of the run, for each cell in the grid.

## **Model Output Files**

### **Restart output file**

The restart output file contains, in binary, all information necessary to restart an interrupted model run. The restart output file may be used as an input file in a subsequent model run. Multiple restart output files may be created at user-specified intervals.

### **Snapshot file**

The snapshot file is the primary ASCII output file. The first portion of the file is a listing of run specifications and files named in the control file. Next, kinetics parameters specified in the control file are listed. The remainder of the file is devoted to printouts of state variable concentrations in the water and sediments. Printouts occur at user-specified intervals.

### **Diagnostic file**

The diagnostic file is an ASCII file which provides information useful in interpreting and debugging model runs. Diagnostic information includes volume and mass balances, timestep and stability limitations, and a record of input files opened. Diagnostic information is available at user-specified intervals.

### **Benthic flux output file**

The benthic flux output file provides an ASCII listing of information input to the sediment submodel.

### **Plot file**

Instantaneous values of quantities computed by the model are written in binary to the plot file. Up to three groups are provided according to user specifications. The first group contains state variable concentrations in the water column. The second group contains information on algal processes and limitations. The third group contains concentrations in the sediment and sediment-water fluxes. Quantities are written to the plot file at user-specified intervals. The user must supply his own postprocessor to view and analyze information contained in the plot file.

### **Average plot file**

The average plot file contains the same quantities and provides the same options as the plot file. Quantities written to the average plot file are temporally averaged over user-specified intervals, however. The average plot file is useful for determining daily or seasonal averages of model computations. The user must supply his own postprocessor to view and analyze information contained in the average plot file.

### **Kinetics flux file**

Kinetic transformations of state variables occur through a variety of pathways. Transformation rates through individual processes are tracked in the model. Transformations are averaged at user-specified intervals and output in binary form for each cell in the grid. The user must supply his own postprocessor to view and analyze information contained in the kinetics flux file.

### **Mass-balance file**

The kinetics flux file reports transformations that do not add or subtract material from the water column. The mass-balance file reports net addition or removal of mass from each cell. Processes included in the mass-balance accounting are external loads, atmospheric loads, benthic fluxes, and respiration. Mass balances are averaged at user-specified intervals and output in binary form for each cell in the grid. The user must supply his own postprocessor to view and analyze information contained in the mass-balance file. The mass-balance file does not contain the system-wide mass accounting provided in the diagnostic file.

### **Transport flux file**

The transport flux file contains computed transport of a subset of state variables across the interfaces of model cells. Transport fluxes are averaged at user-specified intervals and output in binary form for each cell in the grid.

The user must supply his own postprocessor to view and analyze information contained in the transport flux file.

### **Oxygen volume file**

The oxygen volume file provides an accounting of volume and duration of water within user-specified limits of dissolved oxygen concentration. The accounting is useful to determine volume and duration of anoxia, for example. Oxygen volumes are averaged at user-specified intervals and output in binary form for each cell in the grid. The user must supply his own postprocessor to view and analyze information contained in the oxygen volume file.

### **Initial conditions output file**

Computed concentrations at the end of a model run can be written, in binary, to the initial conditions output file. This file can be used, with no modification, as an initial conditions input file in a subsequent model run.

## 2 Conservation-of-Mass Equation

---

### Model Grid

Application of the model requires division of the study system into a grid of discrete volumes or cells. Although each volume is three-dimensional, the grid may be one-, two-, or three-dimensional, depending on the arrangement of the cells. An example of a two-dimensional grid is shown as Figure 2-1. This grid contains ten cells in the longitudinal dimension, one cell in the lateral dimension, and three cells in the vertical dimension.

Each cell in the grid is assigned a unique number or index (Figure 2-2). Interfaces are numbered where flows pass between cells or where cells adjoin open boundaries. Faces adjacent to solid boundaries are not numbered. The grid is unstructured. That is, the cell indices contain no information that indicates cell location in a three-dimensional coordinate system. Neither is there a general relationship between the indices of adjacent cells or between cells and flow faces. A connectivity or "map" file is required that locates cells and faces relative to each other.

The unstructured grid of discrete volumes provides maximum flexibility in coupling the water quality model with hydrodynamic models. No restriction is placed on cell shape or number of flow faces per cell. A price is paid for the flexibility, however. Model coding is more complex for the unstructured grid than for a structured grid. Creation of the map file and coupling with a hydrodynamic model which operates on a structured grid are time-consuming, exacting tasks. The procedure for coupling the eutrophication model with the structured CH3D-WES hydrodynamic model is detailed in an appendix to this manual, to be published in 1995.

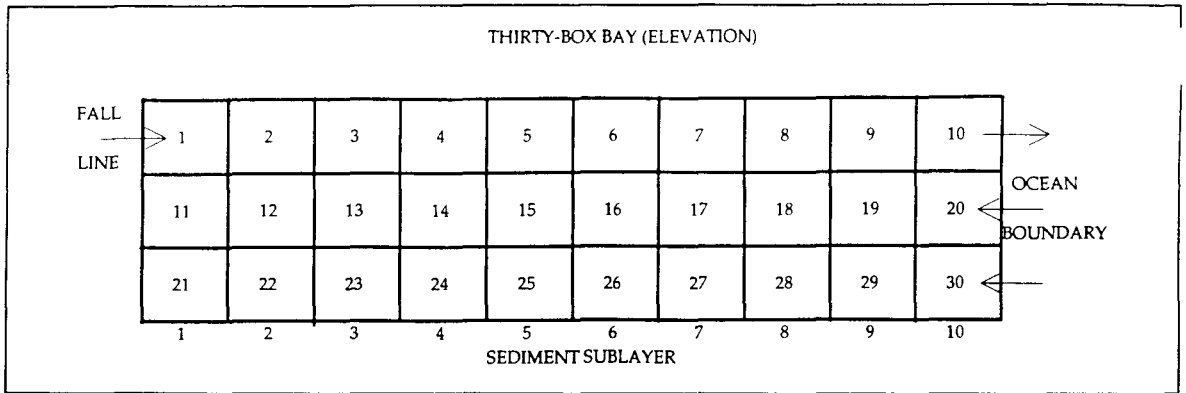

Figure 2-1. Two-dimensional model grid (elevation)

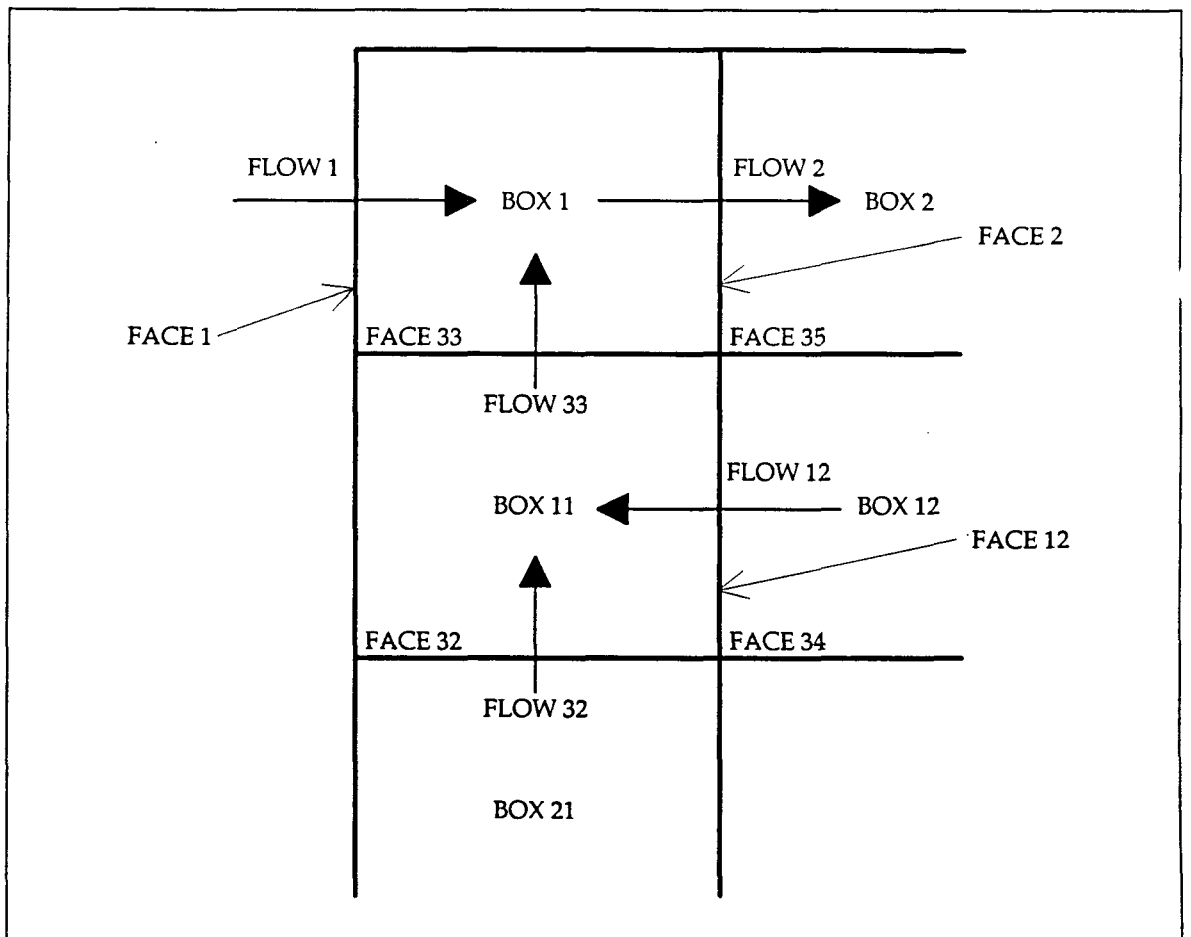

Figure 2-2. Cell and interface numbering scheme

## Conservation-of-Mass Equation

The foundation of CE-QUAL-ICM is the solution to the three-dimensional mass-conservation equation for a control volume. CE-QUAL-ICM solves, for each volume and for each state variable, the equation:

$$\frac{\delta V_j C_j}{\delta t} = \sum_{k=1}^n Q_k C_k + \sum_{k=1}^n A_k D_k \frac{\delta C}{\delta x_k} + \sum S_j \quad (2-1)$$

$V_j$  = volume of  $j^{\text{th}}$  control volume ( $\text{m}^3$ )

$C_j$  = concentration in  $j^{\text{th}}$  control volume ( $\text{gm m}^{-3}$ )

$t, x$  = temporal and spatial coordinates

$n$  = number of flow faces attached to  $j^{\text{th}}$  control volume

$Q_k$  = volumetric flow across flow face  $k$  of  $j^{\text{th}}$  control volume ( $\text{m}^3 \text{sec}^{-1}$ )

$C_k$  = concentration in flow across flow face  $k$  ( $\text{gm m}^{-3}$ )

$A_k$  = area of flow face  $k$  ( $\text{m}^2$ )

$D_k$  = diffusion coefficient at flow face  $k$  ( $\text{m}^2 \text{sec}^{-1}$ )

$S_j$  = external loads and kinetic sources and sinks in  $i^{\text{th}}$  control volume ( $\text{gm sec}^{-1}$ )

## Discretization of the Conservation Equation

Solution of the conservation-of-mass equation on a digital computer requires specification of parameter values and discretization of the continuous derivatives. Numerous formulae for evaluation and discretization exist. Formulae employed in CE-QUAL-ICM were selected based on computational efficiency and accuracy.

The conservation-of-mass equation is solved in two steps. In the first step, an intermediate value is computed. The intermediate value includes the effects of change in cell volume, longitudinal and lateral transport, and external loading. In the second step, the effects of vertical transport are computed.

## Longitudinal and lateral advection

Solution to the conservation-of-mass equation in the longitudinal and lateral directions is via explicit time stepping. That is:

$$C_j^* = \frac{V_j}{V_j^{t+\Delta t}} C_j + \frac{\Delta t}{V_j^{t+\Delta t}} \left[ \sum_{k=1}^{nhf} Q_k C_k + \sum_{k=1}^{nhf} A_k D_k \frac{\delta C}{\delta x_k} + \sum S_j \right] \quad (2-2)$$

$C_j^*$  = concentration in  $j^{\text{th}}$  control volume after volume change, loading, longitudinal/lateral transport processes

$V_j^{t+\Delta t}$  = volume of  $j^{\text{th}}$  control volume at time  $t = \Delta t$

$\Delta t$  = discrete time step

$nhf$  = number of longitudinal and lateral flow faces attached to  $j^{\text{th}}$  control volume

The remaining parameters in Equation 2-2 are evaluated at time  $t$ .

**Upwind differencing.** Solution of Equation 2-2 requires evaluation of the  $C_k$ . Two options are provided within CE-QUAL-ICM. The first is backwards or upwind differencing. In upwind differencing, concentration in the flow across any face is taken as concentration in the cell upstream of the face (Figure 2-3). Upstream is defined relative to direction of the flow. Upstream has no relation to the cell coordinate system.

**QUICKEST.** A second approximation to  $C_k$  fits a parabola to concentration in three adjacent cells (Figure 2-3). For uniform grid spacing:

$$C_k = \frac{1}{2} (C_i + C_j) - \frac{1}{8} (C_{il} + C_j - 2 C_i) \quad (2-3)$$

The approximation in Equation 2-3 is the basis of the QUICK (Quadratic Upstream Interpolation for Convective Kinematics) method. An extension of QUICK for unsteady flows, QUICKEST (QUICK with Estimated Streaming Terms) is implemented in the model. Details of QUICK and QUICKEST, including the QUICKEST formulae for unsteady flows on a non-uniform grid, are provided by Leonard (1979). Implementation of QUICKEST in CE-QUAL-ICM is detailed in an appendix to be published in 1995.

Upwind differencing provides computational simplicity. The upwind method is less accurate and less stable than QUICKEST, however. The

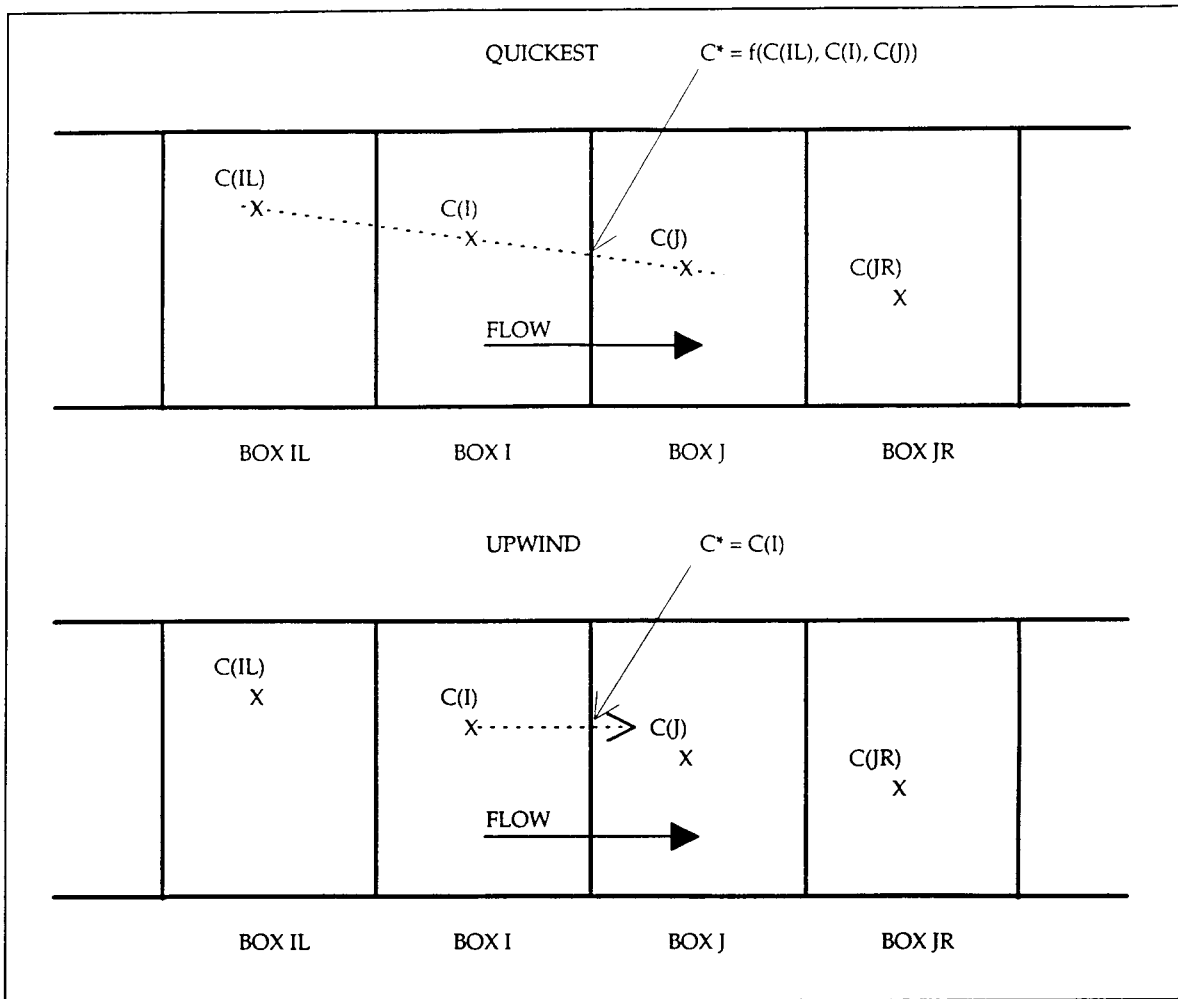

Figure 2-3. Upwind and quick advection schemes

primary disadvantage of QUICKEST is that the method sometimes generates negative concentrations when advecting sharp concentration gradients.

Detailed knowledge of the advective solution schemes are not necessary to execute the model. The upwind and QUICKEST approximations were reviewed to indicate the information required by the model to compute advective transport in the longitudinal and lateral directions. To compute advective transport in any cell, the model requires:

- a. Cell volume.
- b. Indices of longitudinal and lateral flow faces adjoining the cell.
- c. Indices of adjoining and next-most adjoining cells.
- d. Volumetric flow across the indexed flow faces.



e. Length of indexed cells.

The required information is provided in the map, geometry, and hydrodynamics files. Formats of these files are detailed in subsequent chapters.

### Longitudinal and lateral dispersion

Computation of longitudinal and lateral dispersion requires discrete approximation of the continuous derivative in the dispersion term of Equation 2-2. The basic approximation is:

$$\frac{\delta C}{\delta x_k} = \frac{C_j - C_i}{\Delta x} \quad (2-4)$$

where  $\Delta x$  is the distance between centers of two cells.

A higher-order correction to the basic expression is computed when the QUICKEST scheme is employed.

Computation of longitudinal and lateral dispersion requires enumeration of the dispersion coefficient at each flow face. No indexing information is required beyond that supplied for the advection terms.

### Vertical transport

Solution to the conservation-of-mass equation in the longitudinal and lateral directions is by an explicit method. That is, all parameters in the discretized equation are evaluated at time  $t$  except the unknown  $C^*$ . The explicit method is suited for transport dominated by advection rather than diffusion or dispersion. In the vertical direction, diffusion is a significant or dominant component of transport. Solution of vertical transport by an explicit method requires a small time step and consumes large amounts of computer time. In CE-QUAL-ICM, solution to vertical transport is by a partly or fully implicit scheme which practically frees the computation from stability conditions imposed by vertical transport.

The mass-conservation equation in the vertical direction (Figure 2-4) can be expressed:

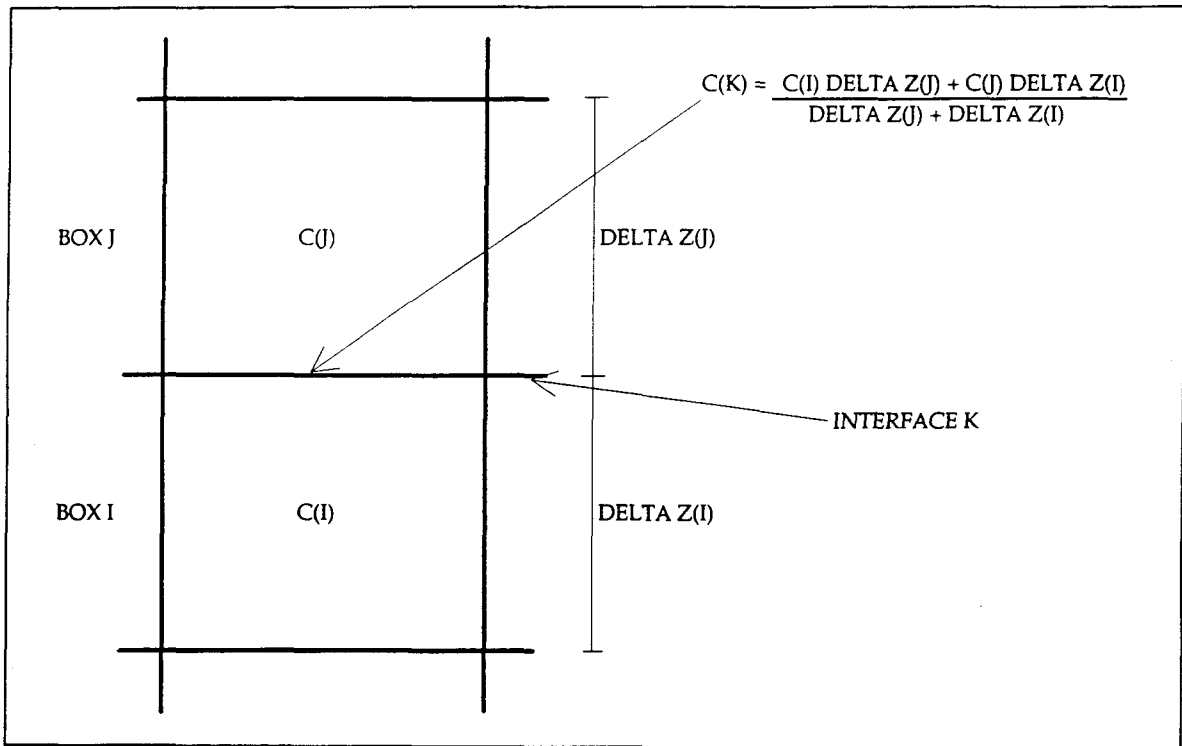

Figure 2-4. Vertical advection scheme

$$\begin{aligned}
 \frac{C_j^{t+\Delta t} - C_j^*}{\Delta t} &= (1 - \theta) \sum_{k=1}^{nvf} \frac{Q_k C_k}{V_k} \\
 &+ \theta \sum_{k=1}^{nvf} \frac{Q_k^{t+\Delta t} C_k^{t+\Delta t}}{V_k^{t+\Delta t}} + \sum_{k=1}^{nvf} \frac{A_k D_k}{V_k^{t+\Delta t}} \frac{\delta C^{t+\Delta t}}{\delta z}
 \end{aligned}
 \tag{2-5}$$

$\theta$  = implicit weighting factor ( $0 \leq \theta \leq 1$ )

$nvf$  = number of vertical faces

$z$  = vertical coordinate

The implicit weighting factor,  $\theta$ , determines whether vertical advection is computed explicitly ( $\theta = 0$ ), implicitly ( $\theta = 1$ ), or is weighted between the two extremes ( $0 < \theta < 1$ ). Computational stability is enhanced as  $\theta \rightarrow 1$ . Practically, however, the value of  $\theta$  has little effect on results of the computation. The value  $\theta = 0.5$  is recommended.

Since vertical velocities are usually much less than longitudinal velocities, the enhanced accuracy of the QUICKEST scheme is not necessary. The

values of  $C_k$  and  $C_k^{t+\Delta t}$  are computed by linear interpolation (Figure 2-4) between concentrations at the centers of adjoining cells:

$$C_k = \frac{C_i \Delta z_i + C_j \Delta z_j}{\Delta z_i + \Delta z_j} \quad (2-6)$$

The spatial gradient in the diffusion term is evaluated by central difference (Equation 2-4) evaluated at time step  $t + \Delta t$ .

The solution scheme for vertical transport is an implicit scheme which means that the equation for concentration in any cell at time  $t + \Delta t$  (e.g. Equation 2-5) contains multiple unknowns. Computation of concentration in any one cell requires solution of a set of simultaneous equations for concentrations in a column of cells extending from water surface to bottom. Details of the solution scheme are not necessary to operate the model. The user must provide, however, the following information required to compute vertical transport:

- a. Indices of all cells in a column.
- b. Indices of vertical flow faces adjoining all cells in a column.
- c. Volumes of all cells in a column.
- d. Volumetric flow across the indexed flow faces.
- e. Diffusion coefficients at indexed flow faces.
- f. Length of indexed cells.

The required information is provided in the map, geometry, and hydrodynamics files. Formats of these files are detailed in subsequent chapters. Details of the implicit solution scheme implemented in CE-QUAL-ICM are provided in an appendix to be published in 1995.

### Summary of numerical solution scheme

The model solves the conservation-of-mass equation through a step-by-step procedure:

- a. Evaluate internal sources and sinks. These include kinetics transformations and sediment-water fluxes. This step provides a partial computation of  $\Sigma S_j$  in Equation 2-1.
- b. Add effects of external loads. This step completes computation of  $\Sigma S_j$  in Equation 2-1.

- c. Compute longitudinal and lateral advection and diffusion at all interfaces. This step provides quantities required to solve Equation 2-2.
- d. Compute concentration at time  $t + \Delta t$  in all cells resulting from volume changes, kinetics, external loads, and longitudinal/lateral transport. This step is the solution to Equation 2-2. For one- or two-dimensional (longitudinal/lateral) systems, solution of the conservation-of-mass equation is complete at this point. For two- (longitudinal/vertical) or three-dimensional systems, the result is an intermediate solution prior to computation of vertical transport.
- e. Compute vertical transport from surface to bottom. Computation is by columns. Each cell at the water surface represents the top of one column.

## Water Quality Model Time Step

Temporal integration of the conservation-of-mass equation (1) is accomplished in discrete time steps  $\Delta t$  (Equations 2-2, 2-5). Integration in discrete steps provides an approximation to the continuous solution of the original differential equation. As  $\Delta t \rightarrow 0$ , the solution of the approximate equation converges on the solution of the continuous equation, although at great cost in computation time. As  $\Delta t \rightarrow \infty$ , computation time diminishes but the solution of the discrete equation diverges from solution of the continuous equation. For sufficiently large  $\Delta t$ , the numerical solution may exhibit large oscillations or instabilities which produce computational failures. The occurrence of instabilities is prevalent in explicit rather than implicit solution schemes. Typical practice in numerical modeling is to select the largest time step possible, to minimize computation time, while remaining in predefined stability limits.

### Vertical transport

The implicit algorithm employed to compute transport in the vertical direction is stable for time step of any size when  $\theta \geq 0.5$  (Roache 1972). Consequently, vertical transport is not considered in determination of the time step.

### Longitudinal and lateral transport

Transport in the longitudinal and lateral directions is computed by explicit schemes which are subject to instabilities for large  $\Delta t$ . The time step employed is determined by an "autostepping" algorithm. The algorithm computes permissible time step based on flow, dispersion, and cell dimension. As a consequence of autostepping, the time step varies throughout a model run. The time step is always near the maximum permissible time step.

Autostepping minimizes computation time while meeting stability requirements.

**Upwind differencing.** The stability requirement for explicit solution to the one-dimensional mass-conservation equation, employing upwind differencing for the advective term, is (Leonard 1979):

$$\Delta t \leq \frac{1}{\frac{2D}{\Delta x^2} + \frac{u}{\Delta x}} \quad (2-7)$$

$\Delta t$  = time step (T)

$D$  = diffusion coefficient ( $L^2 T^{-1}$ )

$\Delta x$  = cell length (L)

$u$  = velocity ( $L T^{-1}$ )

The autostepping algorithm examines velocity, diffusion, and cell length (equivalent to  $Q_j/A_j$ ,  $D_j$ , and  $\delta x_j$  in Equation 2-2) at each flow face of the water quality model control volumes. Allowable time step is computed at each face. The flow face with the most restrictive time step determines the time step for the entire system. The time step is set at a user-specified fraction,  $\alpha$ , of the maximum allowed.

**QUICKEST.** Inspection of the stability region of the one-dimensional QUICKEST algorithm (Leonard 1979) indicates sufficient conditions are:

$$\Delta t \leq \frac{\Delta x}{u} \quad (2-8)$$

and

$$\Delta t \leq \frac{\Delta x^2}{2D} \quad (2-9)$$

The autostepping algorithm examines velocity, diffusion, and cell length at each flow face of the water quality model control volumes. Allowable time step at each face is determined as:

$$\Delta t = \text{minimum} \left[ \alpha \frac{\Delta x}{u}, \alpha \frac{\Delta x^2}{2D} \right] \quad (2-10)$$

where  $\alpha$  is a constant that insures the time step is less than the maximum allowed ( $\approx 0.95$ ).

The flow face with the most restrictive time step determines the time step for the entire system.

The model stability requirements for the QUICKEST algorithm are less restrictive than the stability requirements for upwind differencing. As a consequence, time steps are larger and computation time is reduced when the user specifies QUICKEST rather than upwind differencing. The model stability requirements for QUICKEST also provide a conservative evaluation of the time step. The actual stability region for QUICKEST (Leonard 1979) extends beyond the region employed in the model.

The criteria expressed in Equations 2-7 and 2-10 are for one-dimensional solutions to the mass-conservation equation. Stability requirements for two-dimensional solutions differ from requirements for one-dimensional solutions. The unstructured grid and the solution algorithms employed in the model greatly complicate application of two-dimensional criteria, however. We have thus far found application of the one-dimensional criteria at all flow faces is sufficient to determine the time step in multi-dimensional applications.

## **Boundary Conditions**

Boundary conditions must be specified at the flow faces along the edges of the grid. Through these faces, material is exchanged with the environment outside the model domain. Boundary flow faces are allowed only at the longitudinal and lateral limits of the grid. No flow is allowed through the surface and bottom. Cell faces at the water surface and bottom are not indexed. Neither are cell faces indexed along longitudinal and lateral edges of the grid through which flow does not occur.

Treatment of open boundary conditions requires selection of the numerical scheme and specification of concentration in the environment beyond the grid.

### **Numerical treatment**

Open boundaries are specified as “left-flow boundaries” or “right-flow boundaries” (Figure 2-5). Left- and right-flow boundaries are defined according to the cell numbering scheme in the map file. The designation is independent of flow direction which may be into or out of the grid.

The model employs upwind differencing at all flow boundaries. Upwind differencing occurs whether or not the QUICKEST scheme is specified for advection within the interior of the grid. Upwind differencing is appropriate treatment for inflows that occur at estuarine fall lines and at tributary entry points. Upwind differencing ensures that the concentration of flow entering the grid is the specified boundary concentration. If QUICKEST were employed at an inflow boundary, the three-point weighting scheme would

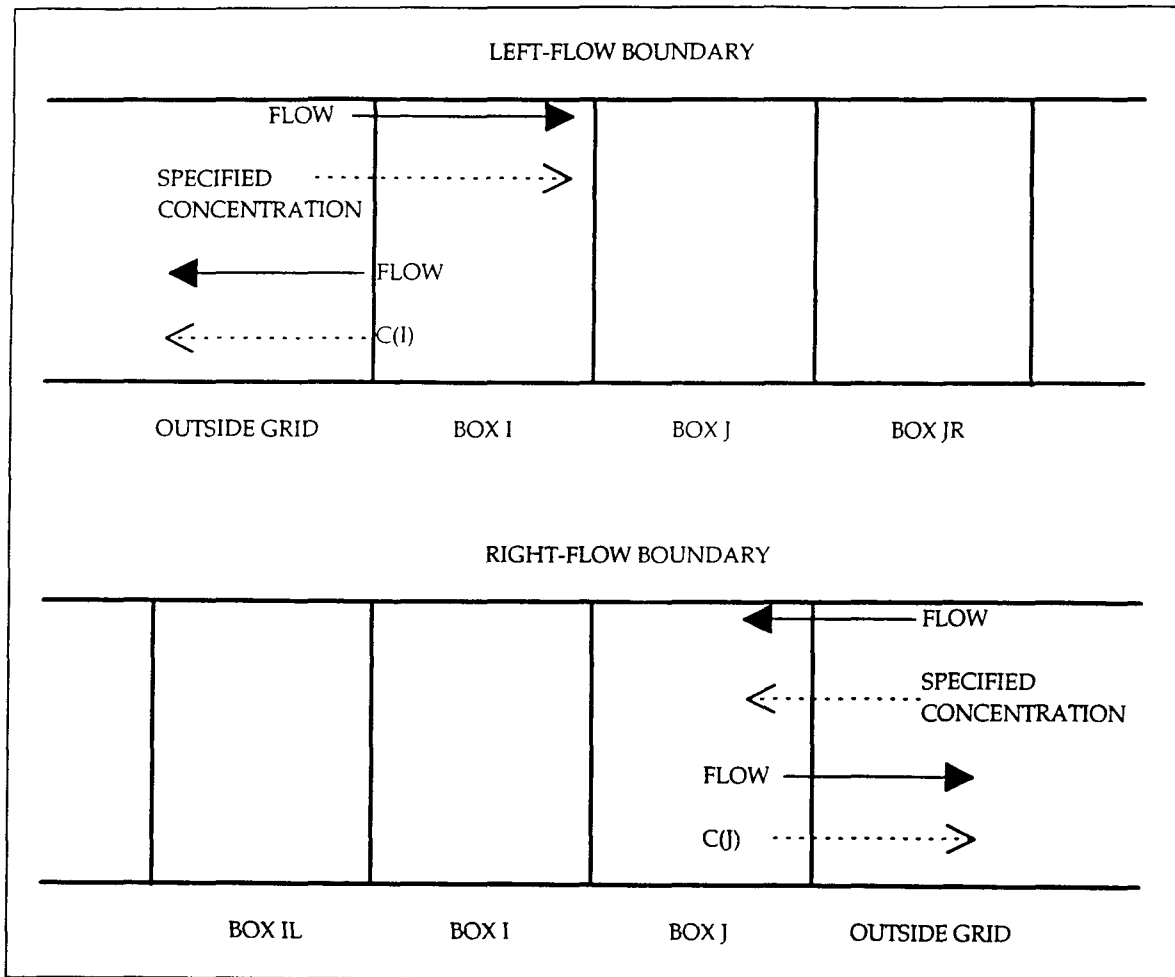

Figure 2-5. Left- and right-flow boundaries

compute an influence of concentration within the system on concentration entering the system.

Upwind differencing is also employed at outflow boundaries. Employment of upwind differencing means that concentration in flow leaving the system is not influenced by concentrations outside the system. Upwind differencing exactly simulates conditions at an outflow such as a spillway. An advantage of upwind differencing at outflows is that the user need not specify a concentration outside the model domain.

Longitudinal and lateral dispersion are set to zero at inflow and outflow boundaries. Absence of dispersion is appropriate at inflow locations such as fall lines and tributary entry points. Absence of dispersion at outflows frees the user from specification of concentration outside the model domain.

### **Concentration in inflows**

Concentration in flow entering the system across open boundaries must be provided to the model. In most cases, such as fall lines and tributary entry points, the concentration is specified by the user.

### **Concentration in outflows**

Concentration in flow leaving the system across open boundaries is specified by the model as the concentration in the cell adjoining the boundary. No user specification of concentration is required.

### **Ocean boundary conditions**

Interfaces at which material is exchanged with the ocean are distinguished in the input deck and model code. As at other boundaries, upwind differencing is employed at ocean interfaces. When flow is from the model domain to the ocean, concentration crossing the boundary face is concentration in the cell adjoining the boundary. When flow is from the ocean to the model domain, concentration crossing the boundary face is the concentration specified for ocean water. The distinction provides options for the specification of concentration in the ocean.

**Reflected boundary condition.** If the oceanic concentration of a model constituent is unknown, the “reflected” boundary condition may be specified. When the reflected boundary condition is specified, concentration in inflowing ocean water is equivalent to concentration in the model cell adjoining the boundary.

**Extrapolated boundary condition.** When oceanic concentration of a model constituent is unknown, the “extrapolated” boundary condition may be selected as an alternate to reflected boundary conditions. When the extrapolated boundary condition is specified, concentration in inflowing ocean water is computed by linear extrapolation of the concentration in two model cells: the cell adjoining the boundary and the next-most upstream cell.

**Mass-balance boundary condition.** The mass-balance boundary condition was developed to meet specific requirements of the Chesapeake Bay Three-Dimensional Model Study (Cercio and Cole 1994). The boundary condition computed concentration of inflowing water as a combination of concentration in outflowing water and a constant concentration at some great distance from the bay mouth.

Dissolved and particulate substances that exit the mouth of Chesapeake Bay are not permanently removed from the system. Water that leaves the bay mixes with shelf water and is returned to the bay by interactions of physical processes including wind, along-shelf currents, and density-driven circulation.



Nutrients leaving the Bay must also be recycled along with water volumes. Recycling of nutrients outside the Bay mouth indicates a linkage between nutrient loads to the Bay and nutrient concentration in inflowing water. If nutrient concentration in water leaving the Bay declines due to load reductions, then concentration in the mixture entering the Bay declines as well. The change in inflow concentration is potentially important and should be incorporated into load-reduction scenarios.

To account for potential changes in boundary conditions during load-reduction scenarios, a mass-balance boundary condition was derived and employed to set nutrient boundary conditions for the scenarios. To maintain consistency between calibration and scenarios, the mass balance was employed in the calibration as well.

Assume a well-mixed volume of water exists between the Bay mouth and an infinite reservoir of continental shelf water (Figure 2-6). A steady-state mass balance for the volume is:

$$Q_u C_u + E(C_{sh} - C_b) = Q_f C_b + Q_b C_b \quad (2-11)$$

$Q_u$  = volumetric flow leaving Bay ( $L^3 T^{-1}$ )

$C_u$  = concentration in flow leaving Bay ( $M L^{-3}$ )

$E$  = exchange coefficient between well-mixed volume and shelf reservoir ( $L^3 T^{-1}$ )

$C_{sh}$  = concentration in continental shelf reservoir ( $M L^{-3}$ )

$C_b$  = concentration in well-mixed volume ( $M L^{-3}$ )

$Q_f$  = freshwater runoff into Bay ( $L^3 T^{-1}$ )

$Q_b$  = volumetric flow from well-mixed volume into Bay ( $L^3 T^{-1}$ )

The mass balance indicates concentration in water entering the Bay is a mixture of concentrations in shelf water and in water leaving the Bay:

$$C_b = \frac{Q_u}{Q_u + E} C_u + \frac{E}{Q_u + E} C_{sh} \quad (2-12)$$

Equation 2-12 contains two unknowns: the proportions in the mixture and the concentration of the shelf reservoir. The proportions were determined from a salt balance on the well-mixed volume, employing the known salinity of the world's oceans. Equation 2-12 was simplified to yield:

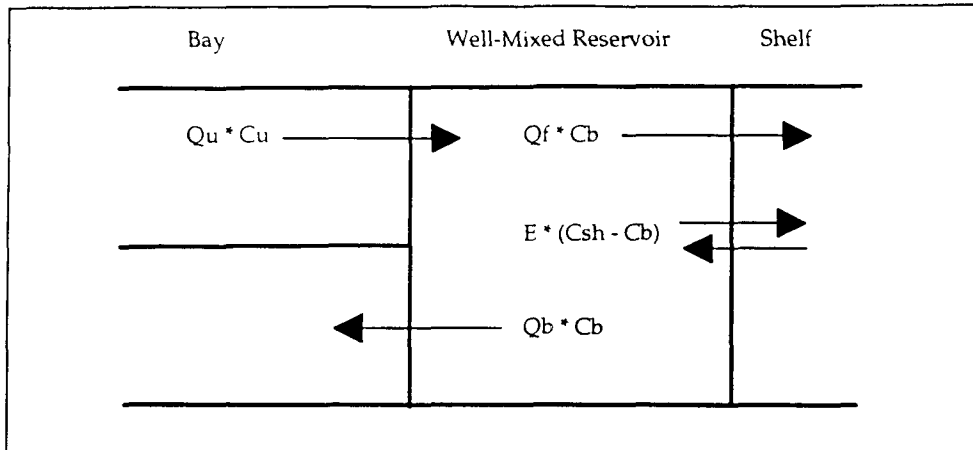

Figure 2-6. Mass-balance boundary condition

$$S_b = \alpha S_u + (1 - \alpha) S_{sh} \quad (2-13)$$

$S_b$  = salinity of water entering the Bay mouth (ppt)

$\alpha$  = proportionality constant ( $0 \leq \alpha \leq 1$ )

$S_u$  = salinity of water leaving the Bay mouth (ppt)

$S_{sh}$  = salinity of continental shelf (35 ppt)

The constant  $\alpha$  indicates the fraction of inflowing mass that is made up of mass that previously left the Bay.

A map was drawn of Lagrangian flows at the Bay mouth computed by the hydrodynamic model (Figure 2-7). This map was superimposed on station locations and sample depths to determine the observations that characterized water entering the Bay. Once inflowing salinities were known, Equation 2-13 was solved on a monthly basis for the unknown  $\alpha$ . Evaluation of  $\alpha$  indicated a large fraction of Bay water ( $\approx 75\%$ ) was recycled during autumn and winter months while a lesser fraction ( $\approx 50\%$ ) was recycled during spring and summer.

Shelf concentrations of nitrogen and phosphorus were obtained by substituting into Equation 2-13 the proportionality constants and observed concentrations entering and leaving the Bay. Annual average shelf concentrations were derived for 1984-1986. These were averaged into a grand mean for use in the model.

**Special case:  $\alpha = 0$ .** When the mass-balance boundary condition is employed with  $\alpha = 0$ , the boundary condition is equivalent to specification of concentration of inflowing water (Equations 2-12, 2-13). For this case, the

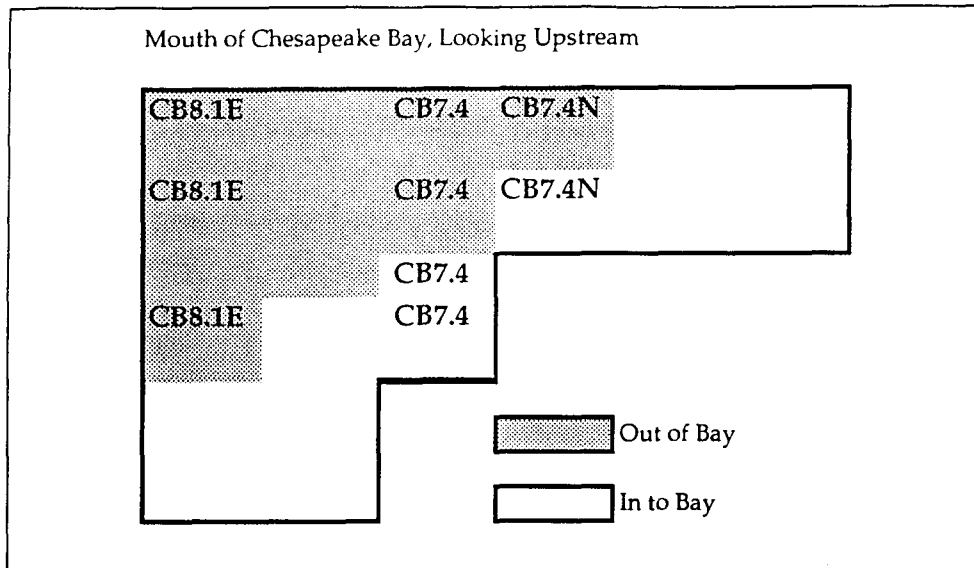

Figure 2-7. Lagrangian flow and sample stations at mouth of Chesapeake Bay

inflowing boundary condition at the ocean interface is equivalent to treatment of inflows at any other location.

**Summary of ocean boundary conditions.** Table 2-1 provides a summary of ocean boundary conditions. The reflected and extrapolated boundary conditions were implemented during model development. These were supplanted by the mass-balance boundary condition and are not recommended for use. The general mass-balance boundary condition provides an advanced approach to boundary specification under changing loads. Application in Chesapeake Bay indicated, however, that boundary conditions were not sensitive to loading. Ninety-percent load reductions resulted in changes less than 10 percent

Table 2-1 Oceanic Boundary Condition Options		
Boundary Condition	Outflow Concentration	Inflow Concentration
Reflected	Concentration in cell adjoining boundary	Concentration in cell adjoining boundary
Extrapolated	Concentration in cell adjoining boundary	Linear extrapolation from interior of model grid
Mass-Balance	Concentration in cell adjoining boundary	Combination of outflowing concentration and specified boundary concentration
Mass-Balance, $\alpha = 0$	Concentration in cell adjoining boundary	Specified boundary concentration

in inflowing nitrogen and phosphorus concentration (Cercio and Cole 1994). Consequently, the sophistication of the general mass-balance boundary condition may not be required. Moreover, the general application depends upon simultaneous occurrence of inflows and outflows at different cell faces of the complete ocean-bay interface. This simultaneous occurrence occurs when flows are averaged over tidal cycles but is not a characteristic of flows which vary on time scales less than a tidal cycle. Employment of the mass-balance boundary condition with  $\alpha = 0$ , equivalent to specification of the ocean boundary concentration, is the recommended implementation.

### Timing

User-specified boundary concentrations may be updated at arbitrary times during a model run. Two options are available for specification of boundary concentrations between updates (Figure 2-8). If the "step-function" option is selected, boundary concentrations are immediately assume the updated concentration and remain constant until the next update. If the "interpolate" option is selected, boundary concentrations are linearly interpolated between updates.

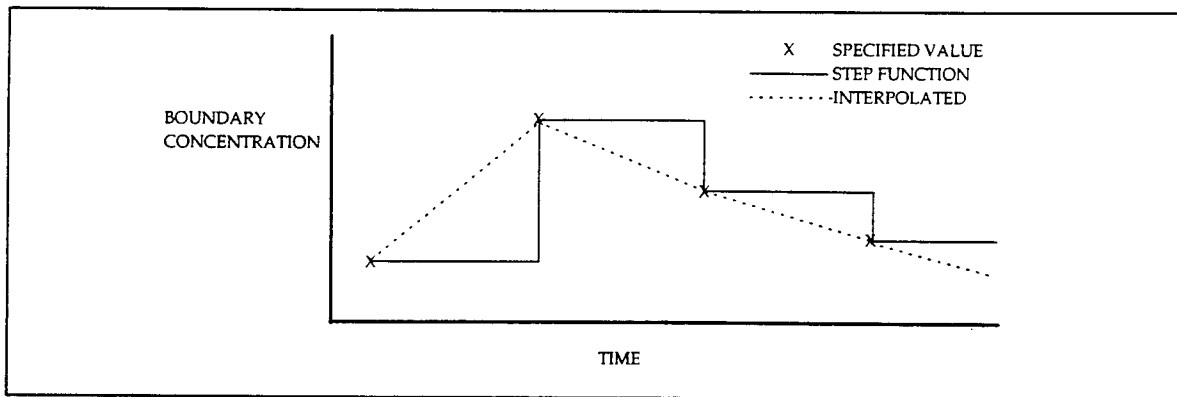

Figure 2-8. Step-function and interpolated boundary conditions

# 3 Eutrophication Kinetics

---

## Introduction

Kinetics for CE-QUAL-ICM were developed for application of the model to Chesapeake Bay (Cerco and Cole 1994). Consequently, several features of the kinetics are specific to the bay. Model formulations are robust, however, and widely applicable. Most bay-specific features are readily disabled through assignment of parameter values.

The central issues in eutrophication modeling are primary production of carbon by algae and concentration of dissolved oxygen. Primary production provides the energy required by the ecosystem to function. Excessive primary production is detrimental, however, since its decomposition, in the water and sediments, consumes oxygen. Dissolved oxygen is necessary to support the life functions of higher organisms and is considered an indicator of the “health” of estuarine systems. In order to predict primary production and dissolved oxygen, a large suite of model state variables is necessary (Table 3-1).

Temperature	Salinity
Total Active Metal	Cyanobacteria
Diatoms	Green Algae
Dissolved Organic Carbon	Labile Particulate Organic Carbon
Refractory Particulate Organic Carbon	Ammonium
Nitrate	Dissolved Organic Nitrogen
Labile Particulate Organic Nitrogen	Refractory Particulate Organic Nitrogen
Total Phosphate	Dissolved Organic Phosphorus
Labile Particulate Organic Phosphorus	Refractory Particulate Organic Phosphorus
Chemical Oxygen Demand	Dissolved Oxygen
Particulate Biogenic Silica	Available Silica

## **Algae**

Algae are grouped into three model classes: cyanobacteria, diatoms, and greens. The grouping is based upon the distinctive characteristics of each class and upon the significant role the characteristics play in the ecosystem. Cyanobacteria, commonly called blue-green algae, are characterized by their abundance (as picoplankton) in saline water and by their bloom-forming characteristics in fresh water. Cyanobacteria are unique in that some species fix atmospheric nitrogen although nitrogen fixers are not predominant in temperate estuarine waters. The cyanobacteria distinguished in the model are the bloom-forming species found in the tidal, freshwater Potomac River. They are characterized as having negligible settling velocity and are subject to low predation pressure. Diatoms are distinguished by their requirement of silica as a nutrient to form cell walls. Diatoms are large algae characterized by high settling velocities. Settling of spring diatom blooms to the sediments may be a significant source of carbon for sediment oxygen demand.

Algae that do not fall into the preceding two groups are lumped into the heading of green algae. Green algae settle at a rate intermediate between cyanobacteria and diatoms and are subject to greater grazing pressure than cyanobacteria.

## **Organic carbon**

Three organic carbon state variables are considered: dissolved, labile particulate, and refractory particulate. Labile and refractory distinctions are based upon the time scale of decomposition. Labile organic carbon decomposes on a time scale of days to weeks while refractory organic carbon requires more time. Labile organic carbon decomposes rapidly in the water column or the sediments. Refractory organic carbon decomposes slowly, primarily in the sediments, and may contribute to sediment oxygen demand years after deposition.

## **Phosphorus**

As with carbon and nitrogen, organic phosphorus is considered in three states: dissolved, labile particulate, and refractory particulate. Only a single mineral form, total phosphate, is considered. Total phosphate exists as several states within the model ecosystem: dissolved phosphate, phosphate sorbed to inorganic solids, and phosphate incorporated in algal cells. Equilibrium partition coefficients are used to distribute the total among the three states.

## **Nitrogen**

Nitrogen is first divided into organic and mineral fractions. Organic nitrogen state variables are: dissolved organic nitrogen, labile particulate organic nitrogen, and refractory particulate organic nitrogen. Two mineral nitrogen forms are considered: ammonium and nitrate. Both are utilized to fulfill algal nutrient requirements although ammonium is preferred from thermodynamic considerations. The primary reason for distinguishing the two is that ammonium is oxidized by nitrifying bacteria into nitrate. This oxidation can be a significant sink of oxygen in the water column and sediments. An intermediate in the complete oxidation of ammonium, nitrite, also exists. Nitrite concentrations are usually much less than nitrate and for modeling purposes nitrite is combined with nitrate. Hence the nitrate state variable actually represents the sum of nitrate plus nitrite.

## **Silica**

Silica is divided into two state variables: available silica and particulate biogenic silica. Available silica is primarily dissolved and can be utilized by diatoms. Particulate biogenic silica cannot be utilized. In the model, particulate biogenic silica is produced through diatom mortality. Particulate biogenic silica undergoes dissolution to available silica or else settles to the bottom sediments.

## **Chemical oxygen demand**

Chemical oxygen demand is the concentration of reduced substances that are oxidizable by inorganic means. The primary component of chemical oxygen demand is sulfide released from sediments. Oxidation of sulfide to sulfate may remove substantial quantities of dissolved oxygen from the water column.

## **Dissolved oxygen**

Dissolved oxygen is required for the existence of higher life forms. Oxygen availability determines the distribution of organisms and the flows of energy and nutrients in an ecosystem. Dissolved oxygen is a central component of the water quality model.

## **Total active metal**

Both phosphate and dissolved silica sorb to inorganic solids, primarily iron and manganese. Sorption and subsequent settling is one pathway for removal of phosphate and silica from the water column. Consequently, the concentration and transport of iron and manganese are represented in the model.

Limited data do not allow a complete treatment of iron and manganese chemistry, however. Rather, a single state variable, total active metal, is defined as the total concentration of metals that are active in phosphate and silica transport. Total active metal is partitioned between particulate and dissolved phases by an oxygen-dependent partition coefficient.

The total active metal state variable is a bay-specific implementation of an inorganic suspended solids state variable. Inorganic suspended solids can be modeled by specification of parameters affecting total active metal. Sorption of nutrients to the inorganic solids can be enabled or disabled through parameter specification. Appropriate parameter specification is explained in the chapter which details the model input files.

## **Salinity**

Salinity is a conservative tracer that provides verification of the transport component of the model and facilitates examination of conservation of mass. Salinity also influences the dissolved oxygen saturation concentration and is used in the determination of kinetics constants that differ in saline and fresh water.

## **Temperature**

Temperature is a primary determinant of the rate of biochemical reactions. Reaction rates increase as a function of temperature although extreme temperatures result in the mortality of organisms.

## **Conservation-of-mass equation**

The foundation of CE-QUAL-ICM is the solution to the three-dimensional mass-conservation equation for a control volume. The equation and solution algorithms were detailed in Chapter 2. The remainder of this chapter details the kinetics portion of the mass-conservation equation for each state variable. Parameters are defined where they first appear. All parameters are listed, in alphabetical order, in a glossary at the end of the chapter. For consistency with reported rate coefficients, kinetics are detailed using a temporal dimension of days. Within the CE-QUAL-ICM code, kinetics sources and sinks are converted to a dimension of seconds before employment in the mass-conservation equation.

## **Algae**

Algae play a central role in the carbon and nutrient cycles that comprise the model ecosystem. Equations governing the three algal groups are largely



the same. Differences among groups are expressed through the magnitudes of parameters in the equations. In describing the parameters, the letter “x” is used as a “wild card.” As needed in this text, the wild card is replaced with a letter that indicates a specific algal group. Characters that indicate each algal group are:

*c* = cyanobacteria

*d* = diatoms

*g* = green algae

Sources and sinks of algae are:

Growth (production)

Basal metabolism

Predation

Settling

The governing equation for algal biomass is:

$$\frac{\delta}{\delta t} Bx = \left[ Px - BMx - PRx - WSx \frac{\delta}{\delta z} \right] Bx \quad (3-1)$$

*Bx* = algal biomass, expressed as carbon (gm C m<sup>-3</sup>)

*Px* = production (day<sup>-1</sup>)

*BMx* = basal metabolism (day<sup>-1</sup>)

*PRx* = predation (day<sup>-1</sup>)

*WSx* = settling velocity (m day<sup>-1</sup>)

*z* = vertical coordinate (m)

### Production

Production by phytoplankton is determined by the availability of nutrients, by the intensity of light, and by the ambient temperature. The effects of each are considered to be multiplicative:

$$Px = PMx f(N) f(I) f(T) \quad (3-2)$$

$PMx$  = production under optimal conditions ( $\text{day}^{-1}$ )

$f(N)$  = effect of suboptimal nutrient concentration ( $0 \leq f \leq 1$ )

$f(I)$  = effect of suboptimal illumination ( $0 \leq f \leq 1$ )

$f(T)$  = effect of suboptimal temperature ( $0 \leq f \leq 1$ )

The cyanobacteria found in the Potomac are freshwater organisms that undergo rapid mortality in salt water. This effect is noted by including a salinity toxicity term in the cyanobacteria production equation:

$$P_c = PMc f(N) f(I) f(T) f(S) \quad (3-3)$$

$f(S)$  = effect of salinity on cyanobacteria production ( $0 \leq f \leq 1$ )

### Nutrients

Carbon, nitrogen, and phosphorus are the primary nutrients required for algal growth. Diatoms require silica, as well. Inorganic carbon is usually available in excess and is not considered in the model. The effects of the remaining nutrients on growth are described by the formulation commonly referred to as "Monod kinetics" (Monod 1949). In the Monod formulation (Figure 3-1) growth is dependent upon nutrient availability at low nutrient concentrations but is independent of nutrients at high concentrations. A key parameter in the formulation is the "half-saturation concentration." Growth rate is half the maximum when available nutrient concentration equals the half-saturation concentration. Liebig's "law of the minimum" (Odum 1971) indicates growth is determined by the nutrient in least supply. For cyanobacteria and greens:

$$f(N) = \text{minimum} \left[ \frac{NH_4 + NO_3}{KH_{nx} + NH_4 + NO_3}, \frac{PO_4d}{KH_{px} + PO_4d} \right] \quad (3-4)$$

$NH_4$  = ammonium concentration ( $\text{gm N m}^{-3}$ )

$NO_3$  = nitrate concentration ( $\text{gm N m}^{-3}$ )

$KH_{nx}$  = half-saturation constant for nitrogen uptake ( $\text{gm N m}^{-3}$ )

$PO_4d$  = dissolved phosphate concentration ( $\text{gm P m}^{-3}$ )

$KH_{px}$  = half-saturation constant for phosphorus uptake ( $\text{gm P m}^{-3}$ )

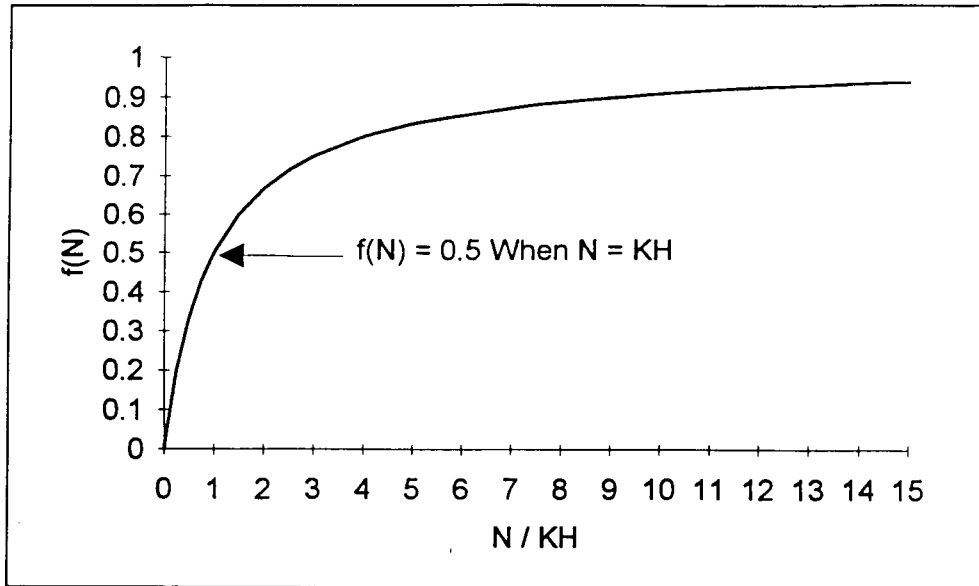

Figure 3-1. Monod formulation for nutrient-limited growth

Some cyanobacteria, notably the bloom-forming genus *Anabaena*, can use atmospheric nitrogen to supply their nutrient requirements. At present, a nonfixing genus, *Microcystis*, is the predominant cyanobacteria in the freshwater Potomac River (Thomann et al. 1985). Consequently, the nitrogen limitation expressed in Equation 3-4 applies to cyanobacteria represented in the model. The potential growth of nitrogen fixers, such as *Anabaena*, can be estimated, if desired, by removing from the model the nitrogen limitation on cyanobacteria.

Diatoms require silica, as well as nitrogen and phosphorus, for growth. For diatoms, the nutrient limitation is the minimum of the limitations expressed in Equation 3-4 or the following:

$$f(N) = \frac{SAd}{KHs + SAd} \quad (3-5)$$

$SAd$  = dissolved available silica concentration ( $\text{gm Si m}^{-3}$ )

$KHs$  = half-saturation constant for silica uptake by diatoms ( $\text{gm Si m}^{-3}$ )

## Light

Algal production increases as a function of light intensity until an optimal intensity is reached. Beyond the optimal intensity, production declines as intensity increases. Steele's equation (DiToro et al. 1971) describes this phenomenon:

$$f(I) = \frac{I}{I_s} e^{1 - \frac{I}{I_s}} \quad (3-6)$$

$I$  = illumination rate (Langley's day<sup>-1</sup>)

$I_s$  = optimal illumination (Langley's day<sup>-1</sup>)

Steele's equation describes the instantaneous light limitation at a point in space. The model, however, computes processes integrated over discrete time intervals and aggregated spatially into model segments. Therefore, Steele's equation must be integrated over an appropriate time interval and averaged over the thickness of each model segment. The integration interval selected is one day. This interval does not preclude computation steps less than a day but frees the model from accounting for illumination in "real time." Daily averaging does preclude computation of diurnal fluctuations in algal production. This restriction is not severe, however, since the classic equations for algal growth are not appropriate for short time scales.

Assuming light intensity declines exponentially with depth, the integrated, averaged form of Steele's equation is:

$$f(I) = \frac{2.72 FD}{K_{ess} \Delta z} (e^{\alpha b} - e^{\alpha t}) \quad (3-7)$$

$$\alpha b = - \frac{I_0}{FD I_s} e^{-K_{ess}(ZD + \Delta z)} \quad (3-8)$$

$$\alpha t = - \frac{I_0}{FD I_s} e^{-K_{ess} ZD} \quad (3-9)$$

$FD$  = fractional daylength ( $0 \leq FD \leq 1$ )

$K_{ess}$  = total light attenuation coefficient (m<sup>-1</sup>)

$\Delta z$  = model segment thickness (m)

$I_0$  = daily illumination at water surface (Langley's day<sup>-1</sup>)

$ZD$  = distance from water surface to top of model segment (m)

Light attenuation in the water column is composed of two fractions: a background value dependent on water color and concentration of suspended particles, and extinction due to light absorption by ambient chlorophyll:

$$K_{ess} = K_{eb} + K_{echl} \sum_{x=c,d,g} \frac{1}{CChlx} Bx \quad (3-10)$$

$K_{eb}$  = background light attenuation ( $m^{-1}$ )

$K_{echl}$  = light attenuation coefficient for chlorophyll 'a' ( $m^2 \text{ mg}^{-1}$ )

$CChlx$  = carbon-to-chlorophyll ratio of algal group x ( $\text{gm C mg}^{-1} \text{ chl}$ )

Optimal illumination for photosynthesis depends on algal taxonomy, duration of exposure, temperature, nutritional status, and previous acclimation. Variations in optimal illumination are largely due to adaptations by algae intended to maximize production in a variable environment. Steele (1962) noted the result of adaptations is that optimal illumination is a consistent fraction ( $\approx 50\%$ ) of daily illumination. Kremer and Nixon (1978) reported an analogous finding that maximum algal production occurs at a constant depth ( $\approx 1\text{m}$ ) in the water column. Their approach is adopted here so that optimal illumination is expressed:

$$I_{sx} = I_{oavg} e^{-K_{ess} D_{optx}} \quad (3-11)$$

$I_{oavg}$  = adjusted surface illumination ( $\text{Langley's day}^{-1}$ )

$D_{optx}$  = depth of maximum algal production (m)

A minimum,  $I_{smin}$ , is specified for optimal illumination so that algae do not thrive at extremely low light levels. The time required for algae to adapt to changes in illumination is recognized by computing  $I_s$  based on a time-weighted average of daily illumination:

$$I_{oavg} = 0.7 I_0 + 0.2 I_1 + 0.1 I_2 \quad (3-12)$$

$I_1$  = daily illumination one day preceding model day ( $\text{Langley's day}^{-1}$ )

$I_2$  = daily illumination two days preceding model day ( $\text{Langley's day}^{-1}$ )

Insight into the interactions of light and algal production can be gained by averaging the light effect,  $f(I)$ , over the entire water column. For this case,  $ZD = 0$ , and  $\Delta z = H$ , the total water column depth. Four independent

parameters determine the light effect:  $FD$ ,  $Ke$ ,  $D_{opt}$ , and  $H$ . The parameters  $Ke$  and  $D_{opt}$ , and  $Ke$  and  $H$  occur as products, however, so the number of independent parameters that determine the light effect is actually three:  $FD$ ,  $Ke * D_{opt}$ , and  $Ke * H$ .

Fractional daylength,  $FD$ , occurs as a multiplier and in the exponential terms of the integrated form of Steele's equation (Equation 3-7). The net effect of  $FD$  on the light function is nearly linear, however (Figure 3-2). At the latitude of Chesapeake Bay,  $FD$  is limited to the range  $\approx 0.4$  to  $0.6$  so that  $f(I)$  varies by  $\approx 50\%$  from the shortest to longest day of the year.

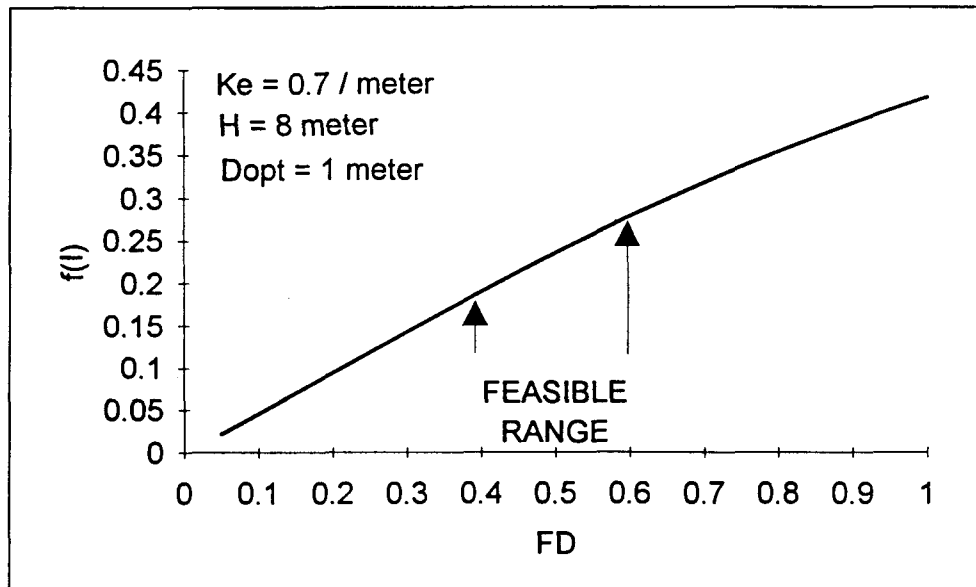

Figure 3-2. Effect of fractional daylength on algal light limitation

A plot of the effects on growth of the pairs  $Ke * H$  and  $Ke * D_{opt}$  (Figure 3-3) has numerous interpretations. For  $Ke * H \gg Ke * D_{opt}$ , growth diminishes as  $Ke * H$  increases. In other words, averaged over the water column, growth goes down as light extinction and/or depth increase. For much of the feasible range of  $Ke * H$ , growth is only weakly dependent on  $D_{opt}$ . This weak dependence was one factor in the selection of the light-effect formulation. Maximum growth occurs when  $Ke * H$  is slightly larger than  $Ke * D_{opt}$  (when  $H$  is slightly larger than  $D_{opt}$ ). When  $Ke * H \leq Ke * D_{opt}$  ( $H \leq D_{opt}$ ), growth is diminished from the maximum due to light levels in the majority of the water column occupying the supersaturated range for algal growth. For small  $Ke * H$  (shallow systems with little light attenuation) maximum growth occurs when  $D_{opt} = 0$ . When  $D_{opt} = 0$ , no portion of the water column is in the supersaturated range. For much of the feasible range of  $Ke * H$ , however, maximum production occurs when  $D_{opt} > 0$ . For this case, diminished production due to light supersaturation near the surface is offset by increased production at deeper depths.

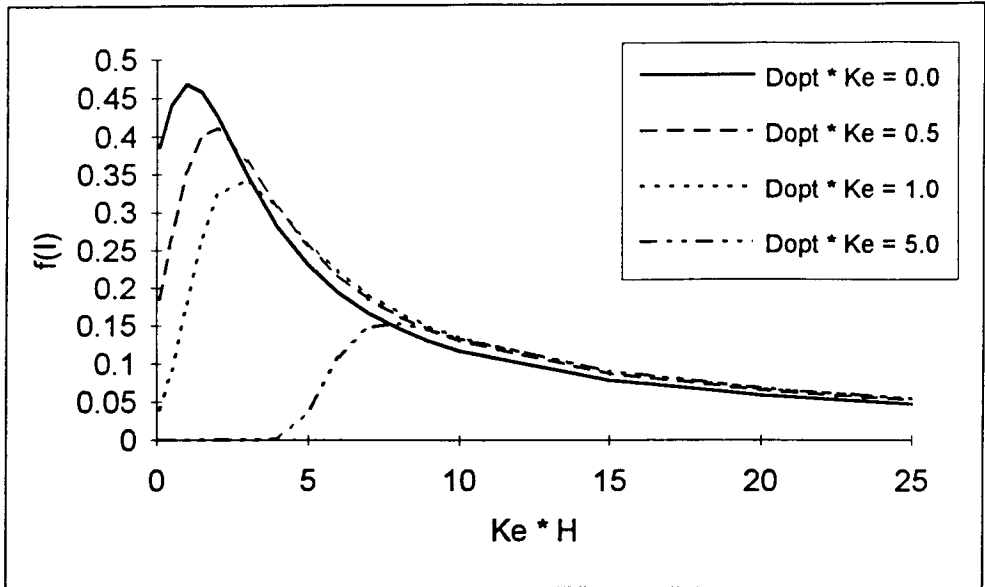

Figure 3-3. Effect of light extinction, total depth, and optimal depth on algal light limitation

### Temperature

Algal production increases as a function of temperature until an optimum temperature or temperature range is reached. Above the optimum, production declines until a temperature lethal to the organisms is attained. Numerous functional representations of temperature effects are available. Inspection of growth versus temperature curves indicates a function similar to a Gaussian probability curve (Figure 3-4) provides a good fit to observations:

$$\begin{aligned}
 f(T) &= e^{-KTgx1(T - Tmx)^2} \text{ when } T \leq Tmx \\
 &= e^{-KTgx2(Tmx - T)^2} \text{ when } T > Tmx
 \end{aligned}
 \tag{3-13}$$

$T$  = temperature ( $C^{\circ}$ )

$Tmx$  = optimal temperature for algal growth ( $C^{\circ}$ )

$KTgx1$  = effect of temperature below  $TMx$  on growth ( $C^{\circ -2}$ )

$KTgx2$  = effect of temperature above  $TMx$  on growth ( $C^{\circ -2}$ )

### Salinity toxicity

The effect of salinity on freshwater cyanobacteria is represented by an empirical equation:

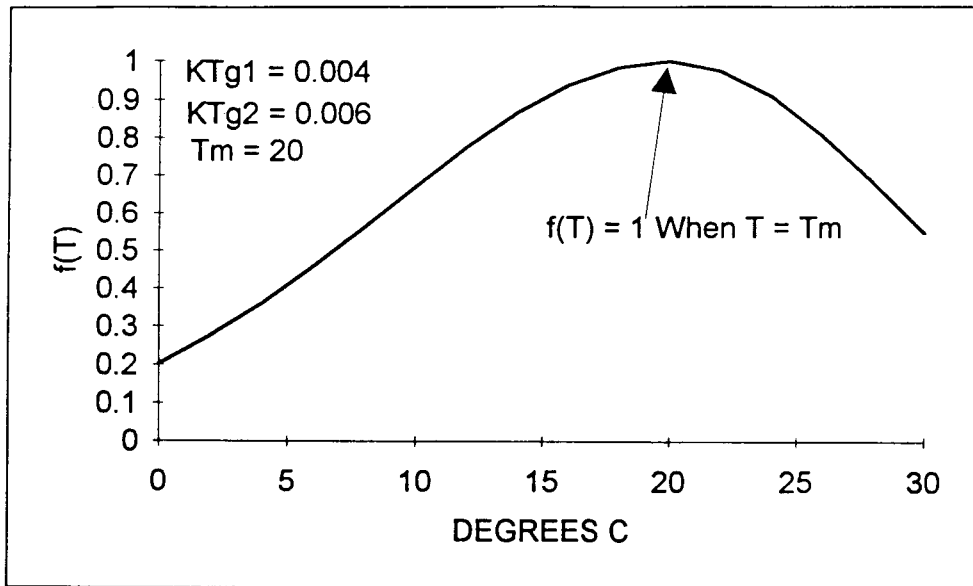

Figure 3-4. Effect of temperature on algal production

$$f(S) = \frac{Stox^2}{Stox^2 + S^2} \quad (3-14)$$

$Stox$  = salinity which *Microcystis* growth is halved (ppt)

### Settling

Species comprising the diatom population of Chesapeake Bay vary according to season and location. In late winter and early spring, diatom population in the bay and lower tributaries is characterized by large species with high settling velocities. At the end of spring, large diatoms are replaced by populations of smaller individuals with lower settling velocities. Seasonal variations in settling velocity may be one factor that influences formation of the subsurface chlorophyll maximum during the spring phytoplankton bloom. Diatom settling is represented in the model:

$$WSd = WSdb + Prdval WSds \quad (3-15)$$

$WSdb$  = base diatom settling velocity (m day<sup>-1</sup>)

$Prdval$  = piecewise function used to specify seasonal diatom settling velocity

$WSds$  = enhanced settling velocity of large diatoms (m day<sup>-1</sup>)



## Basal metabolism

As employed here, basal metabolism is the sum of all internal processes that decrease algal biomass. A portion of metabolism is respiration which may be viewed as a reversal of production. In respiration, carbon and nutrients are returned to the environment accompanied by the consumption of dissolved oxygen. A second internal sink of biomass is the excretion of dissolved organic carbon.

Respiration cannot proceed in the absence of oxygen. Basal metabolism cannot decrease in proportion to oxygen availability, however, or algae would approach immortality under anoxic conditions. To solve this dilemma, basal metabolism is considered to be independent of dissolved oxygen concentration but the distribution of metabolism between respiration and excretion is oxygen-dependent. When oxygen is freely available, respiration is a large fraction of the total. When oxygen is restricted, excretion becomes dominant. Formulation of this process is detailed in the text that describes algal effects on carbon and dissolved oxygen.

Basal metabolism is commonly considered to be an exponentially increasing (Figure 3-5) function of temperature:

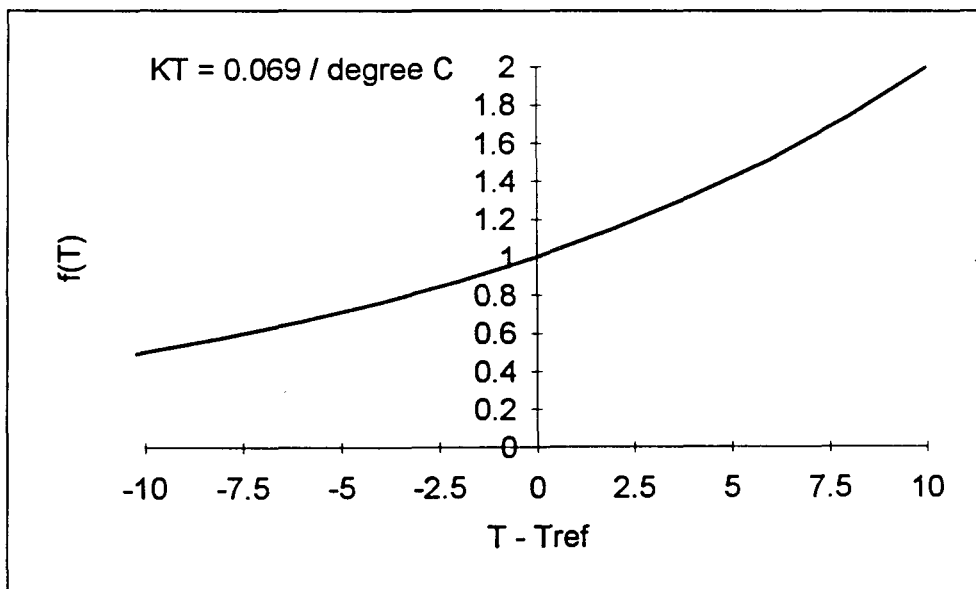

Figure 3-5. Exponential temperature function

$$BM_x = BM_{rx} e^{KT_{bx}(T - T_{rx})} \quad (3-16)$$

$BM_{rx}$  = metabolic rate at  $T_{rx}$  ( $\text{day}^{-1}$ )

$KT_{bx}$  = effect of temperature on metabolism ( $\text{C}^{-1}$ )

$T_{rx}$  = reference temperature for metabolism ( $C^{\circ}$ )

### Predation

Detailed specification of predation rate requires predictive modeling of zooplankton biomass and activity. At present, zooplankton are not included in the model. Consequently, a constant predation rate is specified. This specification implicitly assumes zooplankton biomass is a constant fraction of algal biomass. Zooplankton activity is assumed to be influenced by temperature and is taken into account by incorporating an exponential temperature relationship (Figure 3-5) into the predation term. The predation formulation is identical to basal metabolism. The difference in predation and basal metabolism lies in the distribution of the end products of these processes.

$$PR_x = BPR_x e^{KT_{bx}(T - T_{rx})} \quad (3-17)$$

where  $BPR_x$  is the predation rate at  $T_{rx}$  ( $\text{day}^{-1}$ ).

### Effect of algae on organic carbon

During production and respiration, algae primarily take up and produce carbon dioxide, an inorganic form not considered in the model. A small fraction of basal metabolism is exuded as dissolved organic carbon, however, and in the model this fraction increases as dissolved oxygen becomes scarce. Algae also produce organic carbon through the effects of predation. Zooplankton take up and redistribute algal carbon through grazing, assimilation, respiration, and excretion. Since zooplankton are not included in the model, routing of algal carbon through zooplankton is simulated by empirical distribution coefficients. The effects of algae on organic carbon are expressed:

$$\frac{\delta}{\delta t} DOC = \left[ \left[ FCD_x + (1 - FCD_x) \frac{KH_{rx}}{KH_{rx} + DO} \right] \right. \\ \left. BM_x + FCDP PR_x \right] B_x \quad (3-18)$$

$$\frac{\delta}{\delta t} LPOC = FCLP PR_x B_x \quad (3-19)$$

$$\frac{\delta}{\delta t} RPOC = FCRP PR_x B_x \quad (3-20)$$

*DOC* = dissolved organic carbon concentration (gm C m<sup>-3</sup>)

*FCD<sub>x</sub>* = fraction of basal metabolism exuded as dissolved organic carbon

*KH<sub>r<sub>x</sub></sub>* = half-saturation concentration for algal dissolved organic carbon excretion (gm O<sub>2</sub> m<sup>-3</sup>)

*DO* = dissolved oxygen concentration (gm O<sub>2</sub> m<sup>-3</sup>)

*FCDP* = fraction of dissolved organic carbon produced by predation

*LPOC* = labile particulate organic carbon concentration (gm C m<sup>-3</sup>)

*FCLP* = fraction of labile particulate carbon produced by predation

*RPOC* = refractory particulate organic carbon concentration (gm C m<sup>-3</sup>)

*FCRP* = fraction of refractory particulate carbon produced by predation

The sum of the three predation fractions must equal unity.

### Effect of algae on phosphorus

Algae take up dissolved phosphate during production and release dissolved phosphate and organic phosphorus through mortality. As with carbon, the fate of algal phosphorus released by metabolism and predation is represented by distribution coefficients. Since the total phosphate state variable includes both intra and extracellular phosphate, no explicit representation of the effect of algae on phosphate is necessary. Distribution of total phosphate is determined by partition coefficients as detailed in the **Phosphorus** section of this chapter. The equations that express the effects of algae on organic phosphorus are:

$$\frac{\delta}{\delta t} DOP = (BM_x FPD_x + PR_x FPDP) APC B_x \quad (3-21)$$

$$\frac{\delta}{\delta t} LPOP = (BM_x FPL_x + PR_x FPLP) APC B_x \quad (3-22)$$

$$\frac{\delta}{\delta t} RPOP = (BM_x FPR_x + PR_x FPRP) APC B_x \quad (3-23)$$

*DOP* = dissolved organic phosphorus concentration (gm P m<sup>-3</sup>)

*FPD<sub>x</sub>* = fraction of dissolved organic phosphorus produced by metabolism

*FPDP* = fraction of dissolved organic phosphorus produced by predation

*APC* = phosphorus-to-carbon ratio of all algal groups (gm P gm<sup>-1</sup> C)

*LPOP* = labile particulate organic phosphorus concentration (gm P m<sup>-3</sup>)

*FPL<sub>x</sub>* = fraction of labile particulate phosphorus produced by metabolism

*FPLP* = fraction of labile particulate phosphorus produced by predation

*RPOP* = refractory particulate organic phosphorus concentration  
(gm P m<sup>-3</sup>)

*FPR<sub>x</sub>* = fraction of refractory particulate phosphorus produced by  
metabolism

*FPRP* = fraction of refractory particulate phosphorus produced by  
predation

The sums of the metabolism and respiration fractions must each be less than or equal to unity.

### **Effect of algae on nitrogen**

Algae take up ammonium and nitrate during production and release ammonium and organic nitrogen through mortality. Nitrate is internally reduced to ammonium before synthesis into biomass occurs (Parsons et al. 1984). Trace concentrations of ammonium inhibit nitrate reduction so that, in the presence of ammonium and nitrate, ammonium is utilized first. The "preference" of algae for ammonium can be expressed empirically (Thomann and Fitzpatrick 1982):

$$\begin{aligned}
 PN_x = & NH_4 \frac{NO_3}{(KH_{nx} + NH_4)(KH_{nx} + NO_3)} \\
 & + NH_4 \frac{KH_{nx}}{(NH_4 + NO_3)(KH_{nx} + NO_3)}
 \end{aligned}
 \tag{3-24}$$

where  $PN_x$  is the algal preference for ammonium uptake ( $0 \leq PN_x \leq 1$ ).

The ammonium preference function (Figure 3-6) has two limiting values. When nitrate is absent, the preference for ammonium is unity. When ammonium is absent, the preference is zero. In the presence of ammonium and nitrate, the preference depends on the abundance of both forms relative to the half-saturation constant for nitrogen uptake. When both ammonium and nitrate are abundant, the preference for ammonium approaches unity. When ammonium is scarce but nitrate is abundant, the preference decreases in magnitude and a significant fraction of algal nitrogen requirement comes from nitrate.

The fate of algal nitrogen released by metabolism and predation is represented by distribution coefficients. The effects of algae on the nitrogen state variables are expressed:

$$\frac{\delta}{\delta t} NH_4 = (BM_x FNL_x + PR_x FNIP - PN_x P_x) ANC_x B_x \tag{3-25}$$

$$\frac{\delta}{\delta t} NO_3 = (PN_x - 1) P_x ANC_x B_x \tag{3-26}$$

$$\frac{\delta}{\delta t} DON = (BM_x FND_x + PR_x FNDP) ANC_x B_x \tag{3-27}$$

$$\frac{\delta}{\delta t} LPON = (BM_x FNL_x + PR_x FNLP) ANC_x B_x \tag{3-28}$$

$$\frac{\delta}{\delta t} RPON = (BM_x FNR_x + PR_x FNRP) ANC_x B_x \tag{3-29}$$

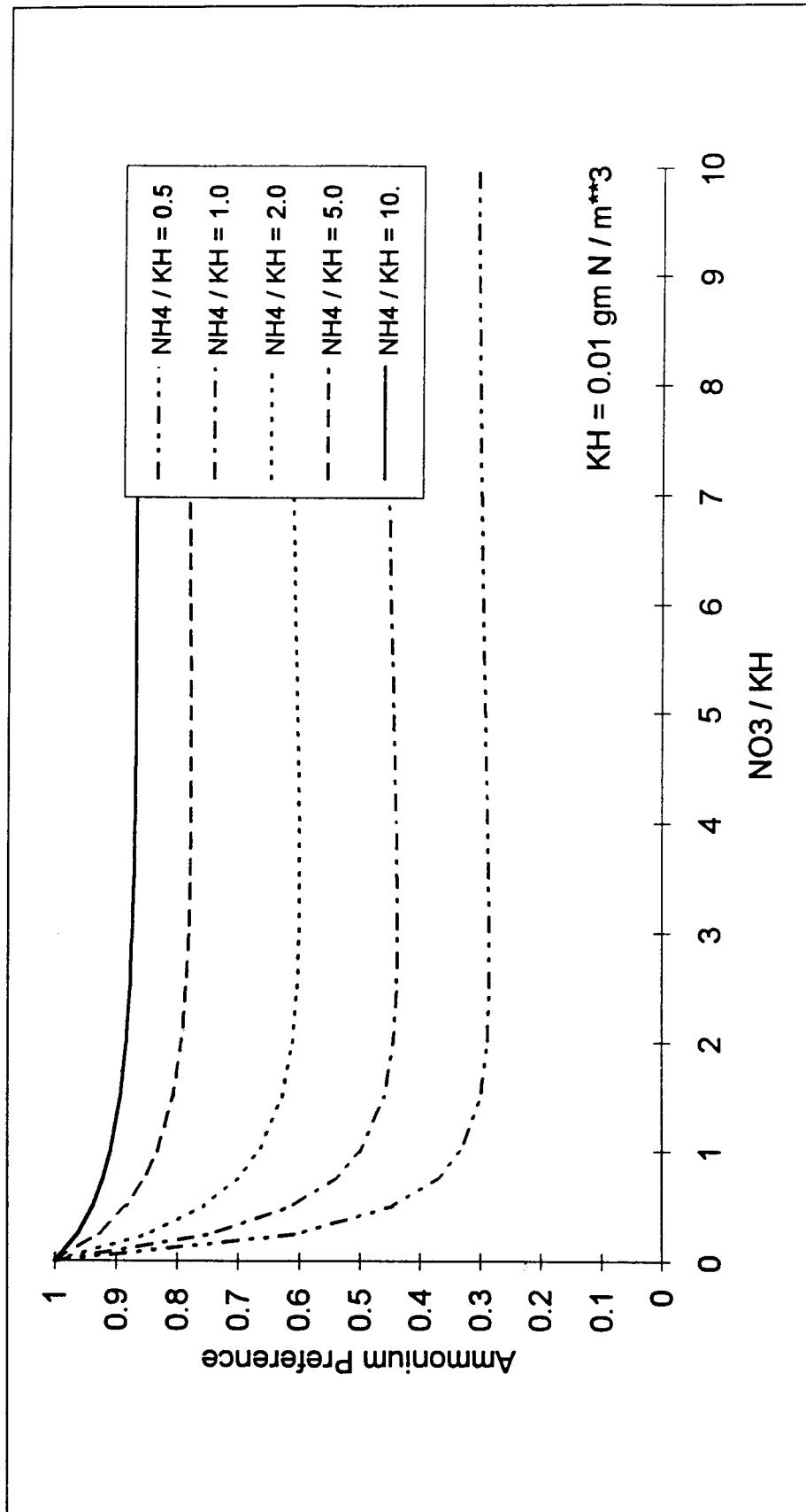

Figure 3-6. Ammonium preference function

*FNlx* = fraction of inorganic nitrogen produced by metabolism

*FNIP* = fraction of inorganic nitrogen produced by predation

*ANCx* = nitrogen-to-carbon ratio of algae ( $\text{gm N gm}^{-1} \text{C}$ )

*DON* = dissolved organic nitrogen concentration ( $\text{gm N m}^{-3}$ )

*FNDx* = fraction of dissolved organic nitrogen produced by metabolism

*FNDP* = fraction of dissolved organic nitrogen produced by predation

*LPON* = labile particulate organic nitrogen concentration ( $\text{gm N m}^{-3}$ )

*FNLx* = fraction of labile particulate nitrogen produced by metabolism

*FNLP* = fraction of labile particulate nitrogen produced by predation

*RPON* = refractory particulate organic nitrogen concentration ( $\text{gm N m}^{-3}$ )

*FNRx* = fraction of refractory particulate nitrogen produced by  
metabolism

*FNRP* = fraction of refractory particulate nitrogen produced by predation

The sums of the metabolism fractions and the predation fractions must each equal unity.

### **Algal stoichiometry**

Algal biomass is quantified in units of carbon. In order to express the effects of algae on nitrogen and phosphorus, the ratios of nitrogen-to-carbon and phosphorus-to-carbon in algal biomass must be specified. Global mean values of these ratios are well known (Redfield et al. 1966). Algal composition varies, however, especially as a function of nutrient availability. As nitrogen and phosphorus become scarce, algae adjust their composition so that smaller quantities of these vital nutrients are required to produce carbonaceous biomass (Droop 1973; DiToro 1980; Parsons et al. 1984).

Observations from upper Chesapeake Bay were examined to assess the potential variability of algal stoichiometry. Data employed were collected by the Maryland Department of the Environment from June 1985 to December 1987. This subset of the monitoring data base was selected since it contained direct laboratory analysis of particulate nutrients. Examination was restricted to surface ( $\leq 2\text{m}$ ) data to maximize the fraction of algae in the particulate analyses. The ratio of particulate carbon-to-nitrogen was plotted as a function of ammonium plus nitrate concentration (Figure 3-7). The ratio of particulate carbon-to-phosphorus was plotted as a function of dissolved phosphate

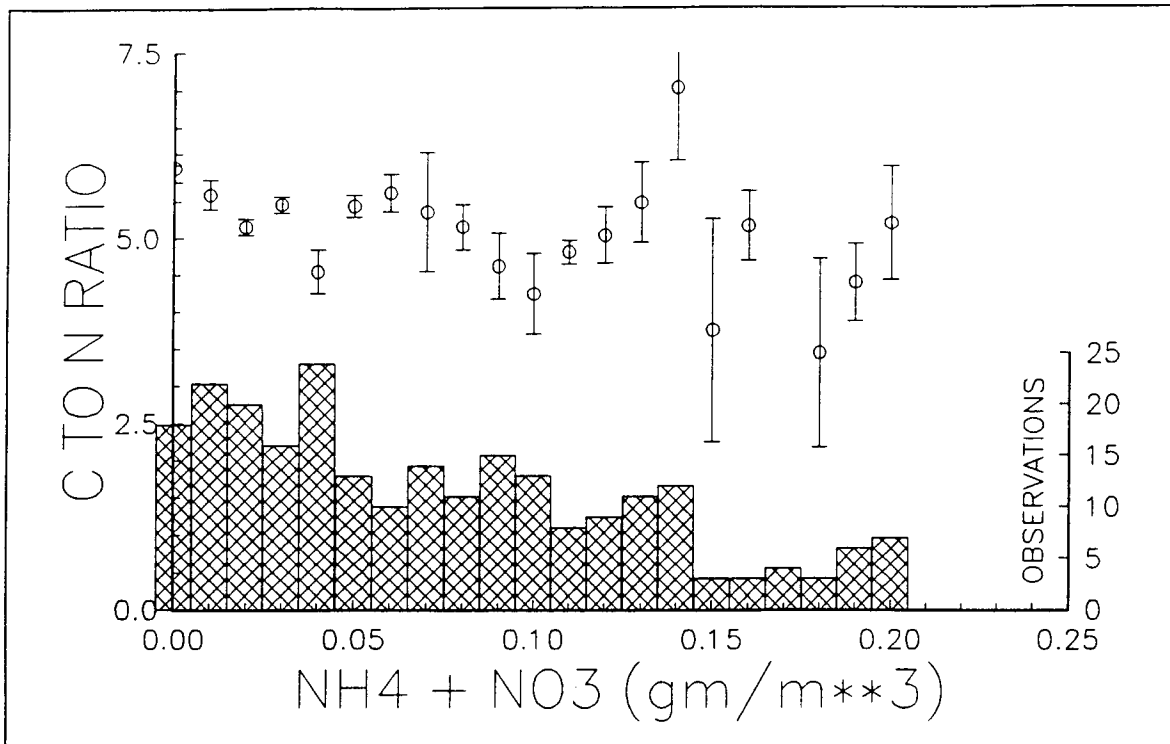

Figure 3-7. Carbon-to-nitrogen ratio (mean and standard error) of seston in upper Chesapeake Bay. Bars show number of observations

concentration (Figure 3-8). (These ratios were plotted to correspond to conventional reporting of algal composition. Their inverses are used in the model.) The variation of carbon-to-nitrogen stoichiometry in the upper Bay was small. No altered composition as a function of diminished nutrient availability was evident. As a consequence of these observations, the model formulation specified constant algal nitrogen-to-carbon ratio,  $ANC_x$ . Large variations in carbon-to-phosphorus ratio occurred, however. The carbon-to-phosphorus ratio in seston more than doubled as dissolved phosphate concentration diminished. To account for this effect, a variable algal phosphorus-to-carbon ratio,  $APC$ , was specified in the model. The ratio was described by an empirical approximation to the trend apparent in Figure 3-8:

$$APC = \frac{1}{PCprm1 + PCprm2 e^{-PCprm3 PO_4d}} \quad (3-30)$$

$PCprm1$  = minimum carbon-to-phosphorus ratio ( $gm\ C\ gm^{-1}\ P$ )

$PCprm2$  = difference between minimum and maximum carbon-to-phosphorus ratio ( $gm\ C\ gm^{-1}\ P$ )



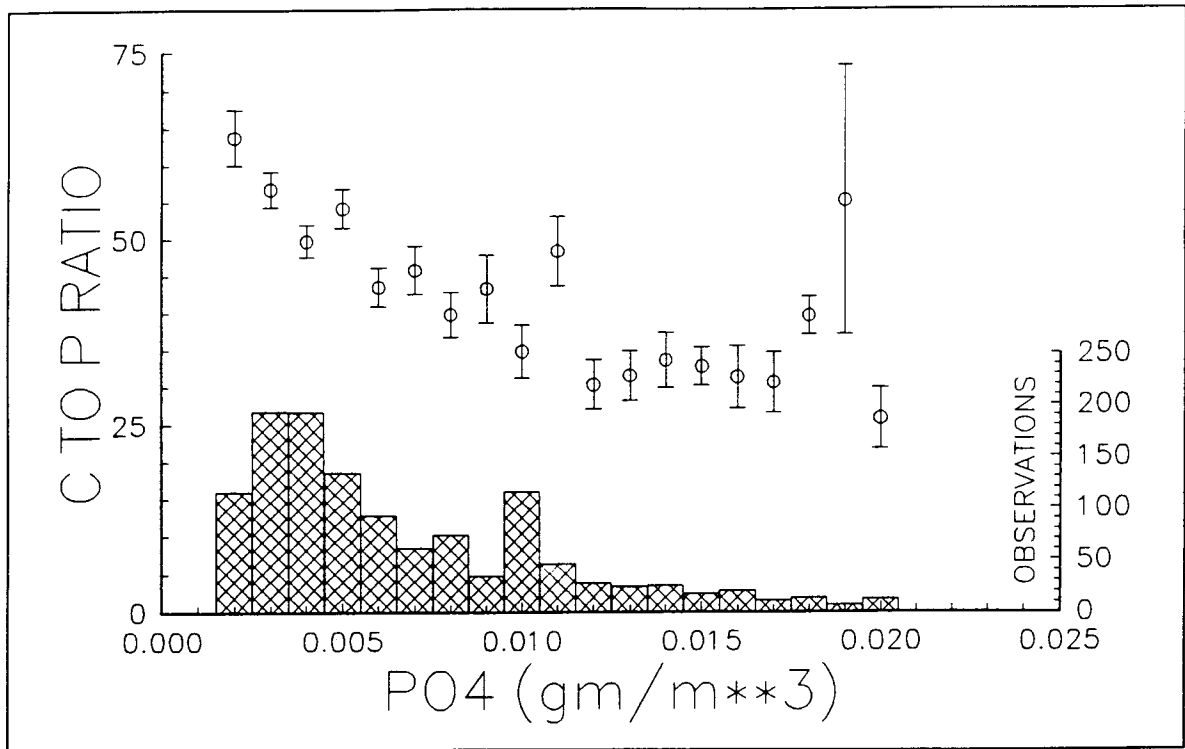
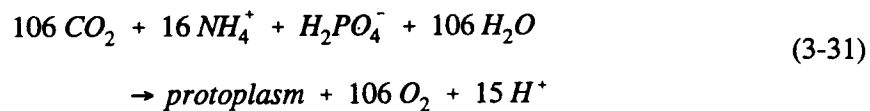

Figure 3-8. Carbon-to-phosphorus ratio (mean and standard error) of seston in upper Chesapeake Bay. Bars show number of observations

$PC_{prm3}$  = effect of dissolved phosphate concentration on carbon-to-phosphorus ratio ( $m^3 gm^{-1} P$ )

### Effect of algae on dissolved oxygen

Algae produce oxygen during photosynthesis and consume oxygen through respiration. The quantity produced depends on the form of nitrogen utilized for growth. More oxygen is produced, per unit of carbon fixed, when nitrate is the algal nitrogen source than when ammonium is the source. Equations describing algal uptake of carbon and nitrogen and production of dissolved oxygen (Morel 1983) are:



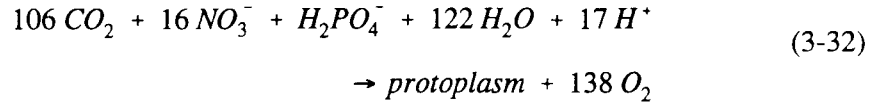

When ammonium is the nitrogen source, one mole oxygen is produced per mole carbon dioxide fixed. When nitrate is the nitrogen source, 1.3 moles oxygen are produced per mole carbon dioxide fixed.

The equation that describes the effect of algae on dissolved oxygen in the model is:

$$\frac{\delta}{\delta t} \text{ DO} = \left[ (1.3 - 0.3 \text{ PN}_x) \text{ P}_x - (1 - \text{ FCD}_x) \frac{\text{ DO}}{\text{ KH}_{rx} + \text{ DO}} \text{ BM}_x \right] \text{ AOCR B}_x \quad (3-33)$$

where *AOCR* is the dissolved oxygen-to-carbon ratio in respiration (2.67 gm O<sub>2</sub> gm<sup>-1</sup> C).

The magnitude of *AOCR* is derived from a simple representation of the respiration process:



The quantity (1.3 - 0.3 *PN<sub>x</sub>*) is the photosynthesis ratio and expresses the molar quantity of oxygen produced per mole carbon fixed. The photosynthesis ratio approaches unity as the algal preference for ammonium approaches unity.

## Organic Carbon

Organic carbon undergoes innumerable transformations in the water column. The model carbon cycle (Figure 3-9) consists of the following elements:

- Phytoplankton production
- Phytoplankton exudation
- Predation on phytoplankton
- Dissolution of particulate carbon
- Heterotrophic respiration

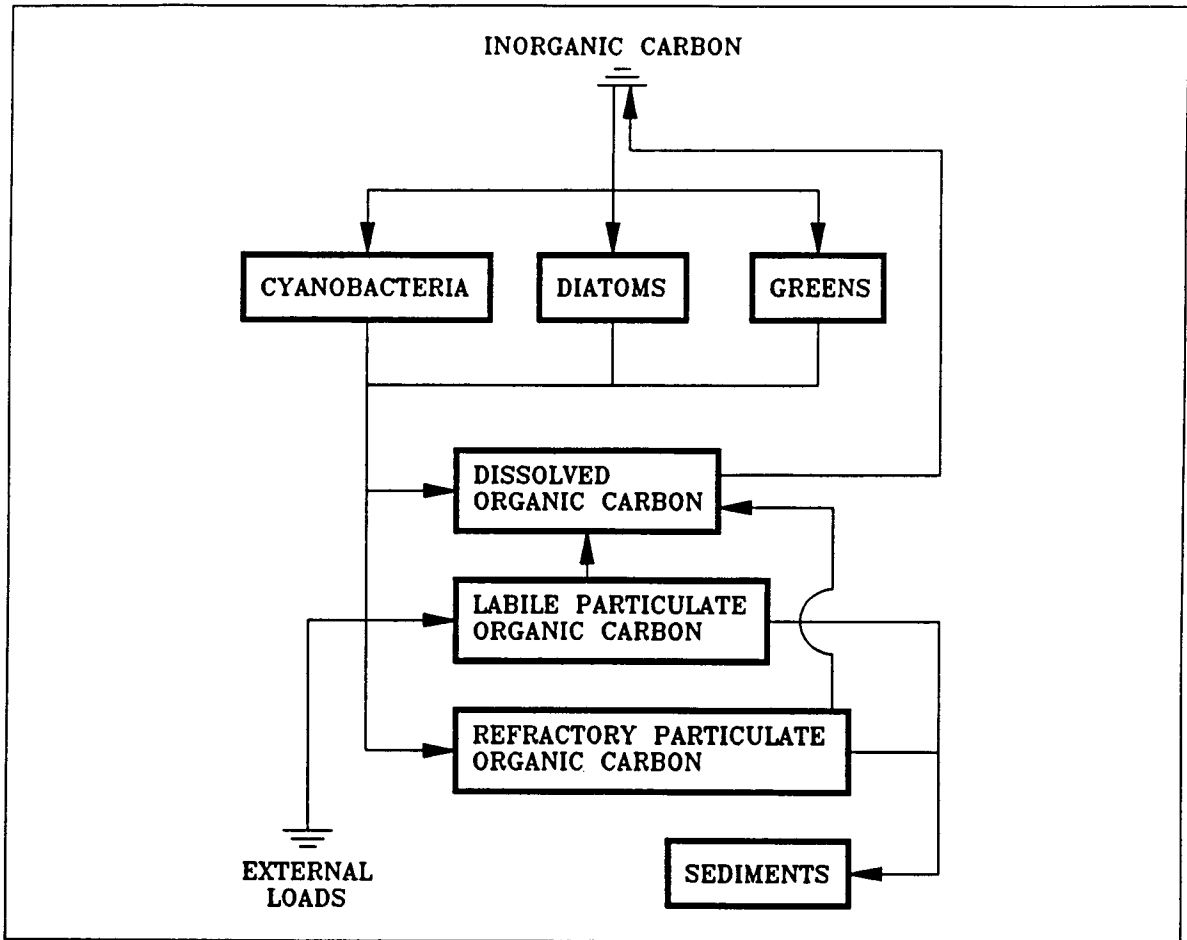

Figure 3-9. Model carbon cycle

**Denitrification  
Settling**

Algal production is the primary carbon source although carbon also enters the system through external loading. Predation on algae releases particulate and dissolved organic carbon to the water column. A fraction of the particulate organic carbon undergoes first-order dissolution to dissolved organic carbon. The remainder settles to the sediments. Dissolved organic carbon produced by phytoplankton exudation, by predation, and by dissolution is respired or denitrified at a first-order rate to inorganic carbon. No carbon is recycled from the sediments to the water column although oxygen demand created by carbon diagenesis is included in the model.

**Dissolution and respiration rates**

Dissolution and respiration rates depend on the availability of carbonaceous substrate and on heterotrophic activity. Heterotrophic activity and biomass have been correlated with algal activity and biomass across a

wide range of natural systems (Bird and Kalff 1984; Cole et al. 1988). Consequently, algal biomass can be incorporated into dissolution and respiration rate formulations as a surrogate for heterotrophic activity. The correlation between algae and heterotrophs occurs because algae produce labile carbon that fuels heterotrophic activity. Dissolution and respiration processes do not require the presence of algae, however, and may be fueled entirely by external carbon inputs. Representation of dissolution and respiration in the model allows specification of algal-dependent and algal-independent rates:

$$Kdoc = Kdc + Kdcalg \sum_{x=c,d,g} Bx \quad (3-35)$$

$Kdoc$  = respiration rate of dissolved organic carbon ( $\text{day}^{-1}$ )

$Kdc$  = minimum respiration rate ( $\text{day}^{-1}$ )

$Kdcalg$  = constant that relates respiration to algal biomass ( $\text{m}^3 \text{ gm}^{-1} \text{ C day}^{-1}$ )

$$Klpoc = Klc + Klcalg \sum_{x=c,d,g} Bx \quad (3-36)$$

$Klpoc$  = dissolution rate of labile particulate organic carbon ( $\text{day}^{-1}$ )

$Klc$  = minimum dissolution rate ( $\text{day}^{-1}$ )

$Klcalg$  = constant that relates dissolution to algal biomass ( $\text{m}^3 \text{ gm}^{-1} \text{ C day}^{-1}$ )

$$Krpoc = Krc + Krcalg \sum_{x=c,d,g} Bx \quad (3-37)$$

$Krpoc$  = dissolution rate of refractory particulate organic carbon ( $\text{day}^{-1}$ )

$Krc$  = minimum dissolution rate ( $\text{day}^{-1}$ )

$Krcalg$  = constant that relates dissolution to algal biomass ( $\text{m}^3 \text{ gm}^{-1} \text{ C day}^{-1}$ )

An exponential function (Figure 3-5) relates dissolution and respiration to temperature.

## Denitrification

As oxygen is depleted from natural systems, oxidation of organic matter is effected by the reduction of alternate oxidants (referred to as “alternate electron acceptors”). The sequence in which alternate acceptors are employed is determined by the thermodynamics of oxidation-reduction reactions. The first substance reduced in the absence of oxygen is nitrate. A representation of the denitrification reaction can be obtained by balancing standard half-cell redox reactions (Stumm and Morgan 1981):

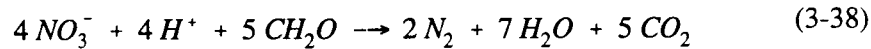

Equation 3-38 describes the stoichiometry of the denitrification reaction. The kinetics of the reaction, represented in the model, are first-order. The dissolved organic carbon respiration rate,  $K_{doc}$ , is modified so that significant decay via denitrification occurs only when nitrate is freely available and dissolved oxygen is depleted (Figure 3-10). A parameter is included so that the anoxic respiration rate is slower than oxic respiration:

$$\text{Denit} = \frac{K_{Hodoc}}{K_{Hodoc} + DO} \frac{\text{NO}_3}{K_{Hndn} + \text{NO}_3} \text{AANOX } K_{doc} \quad (3-39)$$

$\text{Denit}$  = denitrification rate of dissolved organic carbon ( $\text{day}^{-1}$ )

$\text{AANOX}$  = ratio of denitrification to oxic carbon respiration rate  
( $0 \leq \text{AANOX} \leq 1$ )

$K_{Hodoc}$  = half-saturation concentration of dissolved oxygen required for oxic respiration ( $\text{gm O}_2 \text{ m}^{-3}$ )

$K_{Hndn}$  = half-saturation concentration of nitrate required for denitrification ( $\text{gm N m}^{-3}$ )

An exponential function (Figure 3-5) relates denitrification to temperature. Parameter values in the function are the same as for dissolved organic carbon respiration.

## Dissolved organic carbon

The complete representation of all dissolved organic carbon sources and sinks in the model ecosystem is:

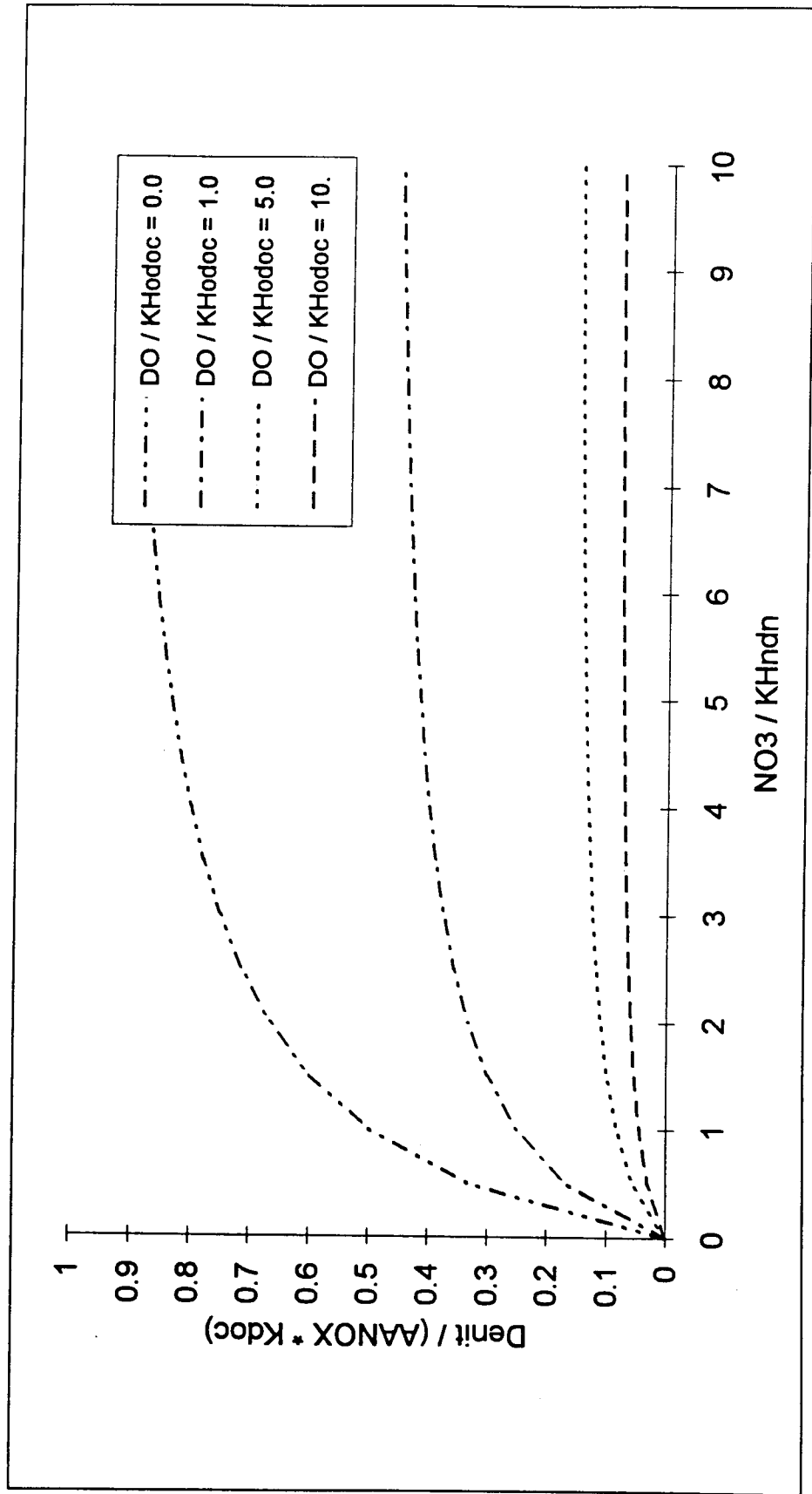

Figure 3-10. Effect of nitrate and dissolved oxygen on denitrification rate

$$\begin{aligned} \frac{\delta}{\delta t} DOC = & \sum_{x=c,d,g} \left[ \left[ FCDx + (1 - FCDx) \frac{KHrx}{KHrx + DO} \right] BMx \right. \\ & \left. + FCDP PRx \right] Bx + Kl poc LPOC + Kr poc RPOC \quad (3-40) \\ & - \frac{DO}{KHodoc + DO} Kdoc DOC - Denit DOC \end{aligned}$$

### Labile particulate organic carbon

The complete representation of all labile particulate organic carbon sources and sinks in the model ecosystem is:

$$\frac{\delta}{\delta t} LPOC = \sum_{x=c,d,g} FCLP PRx Bx - Kl poc LPOC - WSl \frac{\delta}{\delta z} LPOC \quad (3-41)$$

where  $WSl$  is the settling velocity of labile particles ( $m \text{ day}^{-1}$ ).

### Refractory particulate organic carbon

The complete representation of all refractory particulate organic carbon sources and sinks in the model ecosystem is:

$$\frac{\delta}{\delta t} RPOC = \sum_{x=c,d,g} FCRP PRx Bx - Kr poc RPOC - WSr \frac{\delta}{\delta z} RPOC \quad (3-42)$$

where  $WSr$  is the settling velocity of refractory particles ( $m \text{ day}^{-1}$ ).

## Phosphorus

The model phosphorus cycle (Figure 3-11) includes the following processes:

- Algal production and metabolism
- Predation
- Hydrolysis of particulate organic phosphorus
- Mineralization of dissolved organic phosphorus
- Settling
- Exchange with inorganic solids

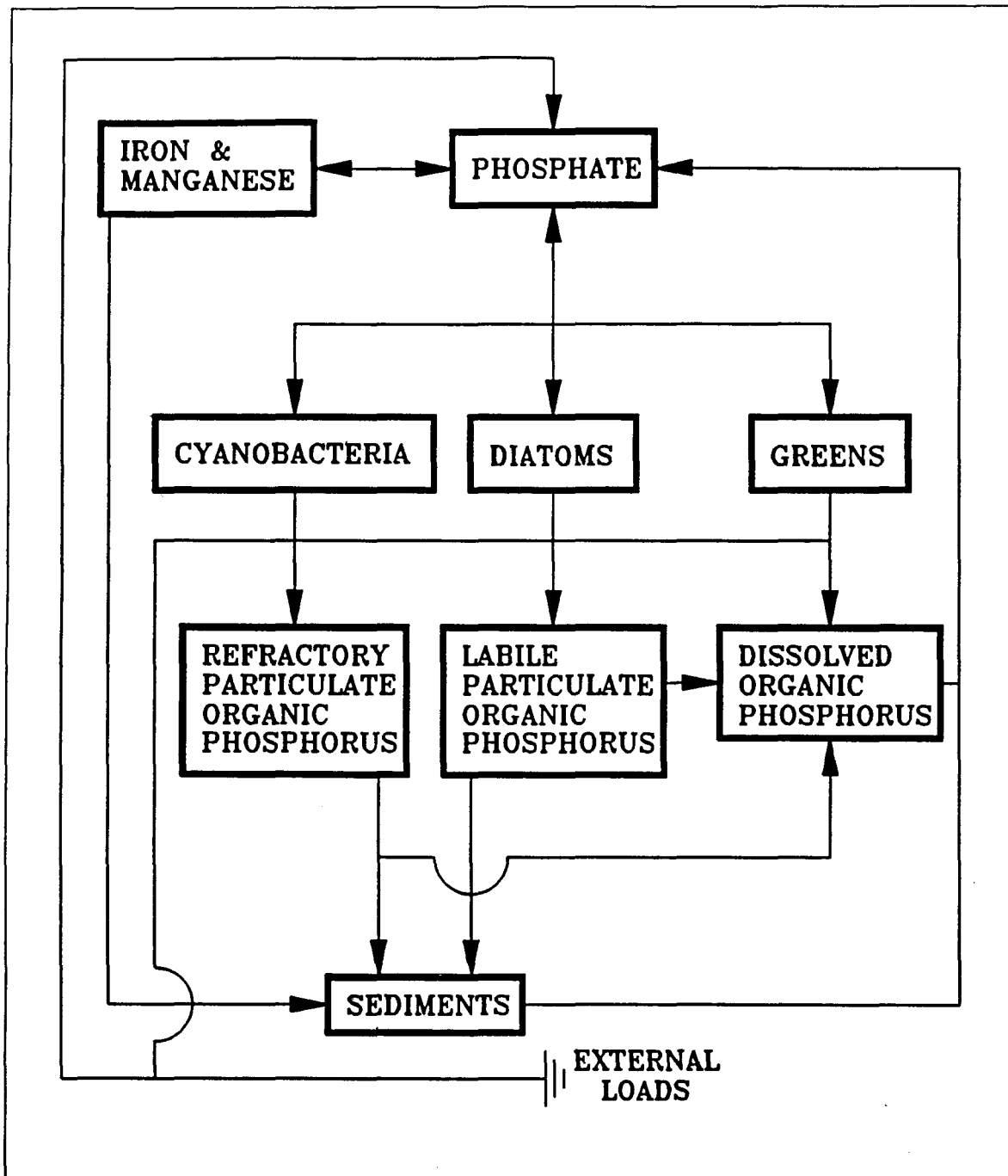

Figure 3-11. Model phosphorus cycle

External loads provide the ultimate source of phosphorus to the system. Dissolved phosphate is incorporated by algae during growth and released as phosphate and organic phosphorus through respiration and predation. A portion of the particulate organic phosphorus hydrolyzes to dissolved organic phosphorus. The balance settles to the sediments. Dissolved organic phosphorus is mineralized to phosphate. A portion of the phosphate sorbs to inorganic solids and settles to the sediments. Within the sediments, particulate



phosphorus is mineralized and recycled to the water column as dissolved phosphate.

Effects on phosphorus of algal production, metabolism, and predation have already been detailed. Descriptions of hydrolysis and mineralization and of the total phosphate system follow.

### Hydrolysis and mineralization

Within the model, hydrolysis is defined as the process by which particulate organic substances are converted to dissolved organic form. Mineralization is defined as the process by which dissolved organic substances are converted to dissolved inorganic form. Conversion of particulate organic phosphorus to phosphate proceeds through the sequence of hydrolysis and mineralization. Direct mineralization of particulate organic phosphorus does not occur.

Mineralization of organic phosphorus is mediated by the release of nucleotidase and phosphatase enzymes by bacteria (Ammerman and Azam 1985; Chrost and Overbeck 1987) and algae (Matavulj and Flint 1987; Chrost and Overbeck 1987; Boni et al. 1989). Since the algae themselves release the enzyme and since bacterial abundance is related to algal biomass, the rate of organic phosphorus mineralization is related, in the model, to algal biomass. A most remarkable property of the enzyme process is that alkaline phosphatase activity is inversely proportional to ambient phosphate concentration (Chrost and Overbeck 1987; Boni et al. 1989). Put in different terms, when phosphate is scarce, algae stimulate production of an enzyme that mineralizes organic phosphorus to phosphate. This phenomenon is simulated by relating mineralization to the algal phosphorus nutrient limitation. Mineralization is highest when algae are strongly phosphorus limited and is least when no limitation occurs.

Expressions for mineralization and hydrolysis rates are:

$$K_{dop} = K_{dp} + \frac{KH_p}{KH_p + PO_4d} K_{dpalg} \sum_{x=c,d,g} B_x \quad (3-43)$$

$K_{dop}$  = mineralization rate of dissolved organic phosphorus ( $\text{day}^{-1}$ )

$K_{dp}$  = minimum mineralization rate ( $\text{day}^{-1}$ )

$KH_p$  = mean half-saturation constant for algal phosphorus uptake  
( $\text{gm P m}^{-3}$ ) =  $(KH_{pc} + KH_{pd} + KH_{pg})/3$

$Kd_{palg}$  = constant that relates mineralization to algal biomass  
( $m^3 \text{ gm}^{-1} \text{ C day}^{-1}$ )

$$Kl_{pop} = Kl_p + \frac{KH_p}{KH_p + PO_4d} Kl_{palg} \sum_{x=c,d,g} B_x \quad (3-44)$$

$Kl_{pop}$  = hydrolysis rate of labile particulate phosphorus ( $\text{day}^{-1}$ )

$Kl_p$  = minimum hydrolysis rate ( $\text{day}^{-1}$ )

$Kl_{palg}$  = constant that relates hydrolysis to algal biomass ( $m^3 \text{ gm}^{-1} \text{ C day}^{-1}$ )

$$Kr_{pop} = Kr_p + \frac{KH_p}{KH_p + PO_4d} Kr_{palg} \sum_{x=c,d,g} B_x \quad (3-45)$$

$Kr_{pop}$  = hydrolysis rate of refractory particulate phosphorus ( $\text{day}^{-1}$ )

$Kr_p$  = minimum hydrolysis rate ( $\text{day}^{-1}$ )

$Kr_{palg}$  = constant that relates hydrolysis to algal biomass ( $m^3 \text{ gm}^{-1} \text{ C day}^{-1}$ )

An exponential function (Figure 3-5) relates mineralization and hydrolysis rates to temperature.

Potential effects of algal biomass and nutrient limitation on mineralization and hydrolysis rates shown in Figure 3-12. When nutrient concentration greatly exceeds the half-saturation concentration for algal uptake, the rate roughly equals the minimum. Algal biomass has little influence. As nutrient becomes scarce relative to the half-saturation concentration, the rate increases. The magnitude of increase depends on algal biomass. Factor of two to three increases are feasible.

### Total phosphate system

One fraction of total phosphorus in the water column is phosphorus incorporated in algal biomass. This fraction is computed in the model as the product of algal biomass and APC, the phosphorus-to-carbon ratio. In the environment, algae adjust their phosphorus content in response to external conditions. Algal phosphorus content is high when external phosphorus is abundant and phosphorus content is low when phosphorus is scarce. The adaptation of algae to their environment indicates phosphorus-to-carbon ratio should be a variable in the model. Treatment of the ratio as a variable,

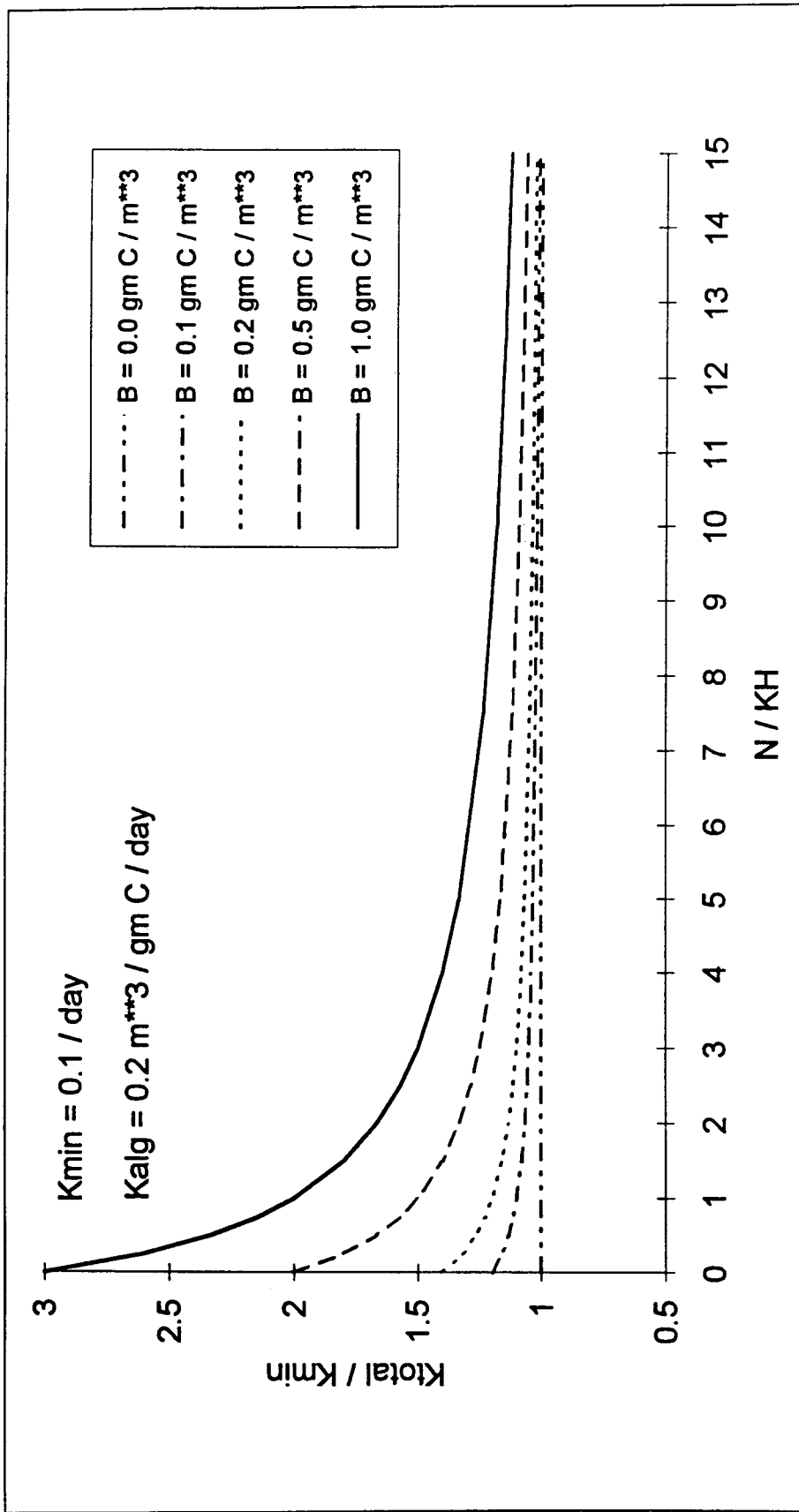

Figure 3-12. Effect of algal biomass and nutrient concentration on hydrolysis and mineralization

however, greatly complicates computation of phosphorus transport due to the mixture of algal masses of different composition. The complication is avoided if intracellular and extracellular phosphorus are treated and transported as a single state variable. Intracellular and extracellular concentrations are determined by equilibrium partitioning of their sum.

Adsorption is the process in which ions or molecules are attracted to the surface of a solid. Phosphate ions exhibit a strong adsorption to particulate species of metals including iron and manganese. Sorption to metals is included in the model based on phenomena observed in the monitoring data (Figure 3-13). Phosphate was rapidly depleted from anoxic bottom waters during the autumn reaeration event. Our hypothesis was that reaeration of bottom waters caused dissolved iron and manganese to precipitate. Phosphate sorbed to the newly formed metal particles and rapidly settled to the bottom. Computation of transport of sorbed and dissolved fractions is facilitated when the model state variable represents the sum of both fractions. Particulate and dissolved fractions are determined by equilibrium partitioning of their sum.

The model phosphate state variable is defined as the sum of dissolved phosphate, sorbed phosphate, and algal phosphorus content:

$$PO_4^t = PO_4^d + PO_4^p + PO_4^a \quad (3-46)$$

$PO_4^t$  = total phosphate (gm P m<sup>-3</sup>)

$PO_4^d$  = dissolved phosphate (gm P m<sup>-3</sup>)

$PO_4^p$  = particulate (sorbed) phosphate (gm P m<sup>-3</sup>)

$PO_4^a$  = algal phosphorus (gm P m<sup>-3</sup>)

### Exchange with particulate metals

Detailed treatment of iron and manganese is beyond the scope of this model. Instead, the state variable “total active metal” is defined as the sum of all metals that act as sorption sites. Phosphate sorbs to only the particulate fraction of the total metal, however. Therefore the total metal is partitioned into particulate and dissolved fractions via an equilibrium partition coefficient. Extracellular phosphate is partitioned by a linear sorption isotherm so that dissolved and particulate fractions are computed:

$$PO_4^d = \frac{1}{1 + Kad_{po4} TAM_p} (PO_4^t - PO_4^a) \quad (3-47)$$

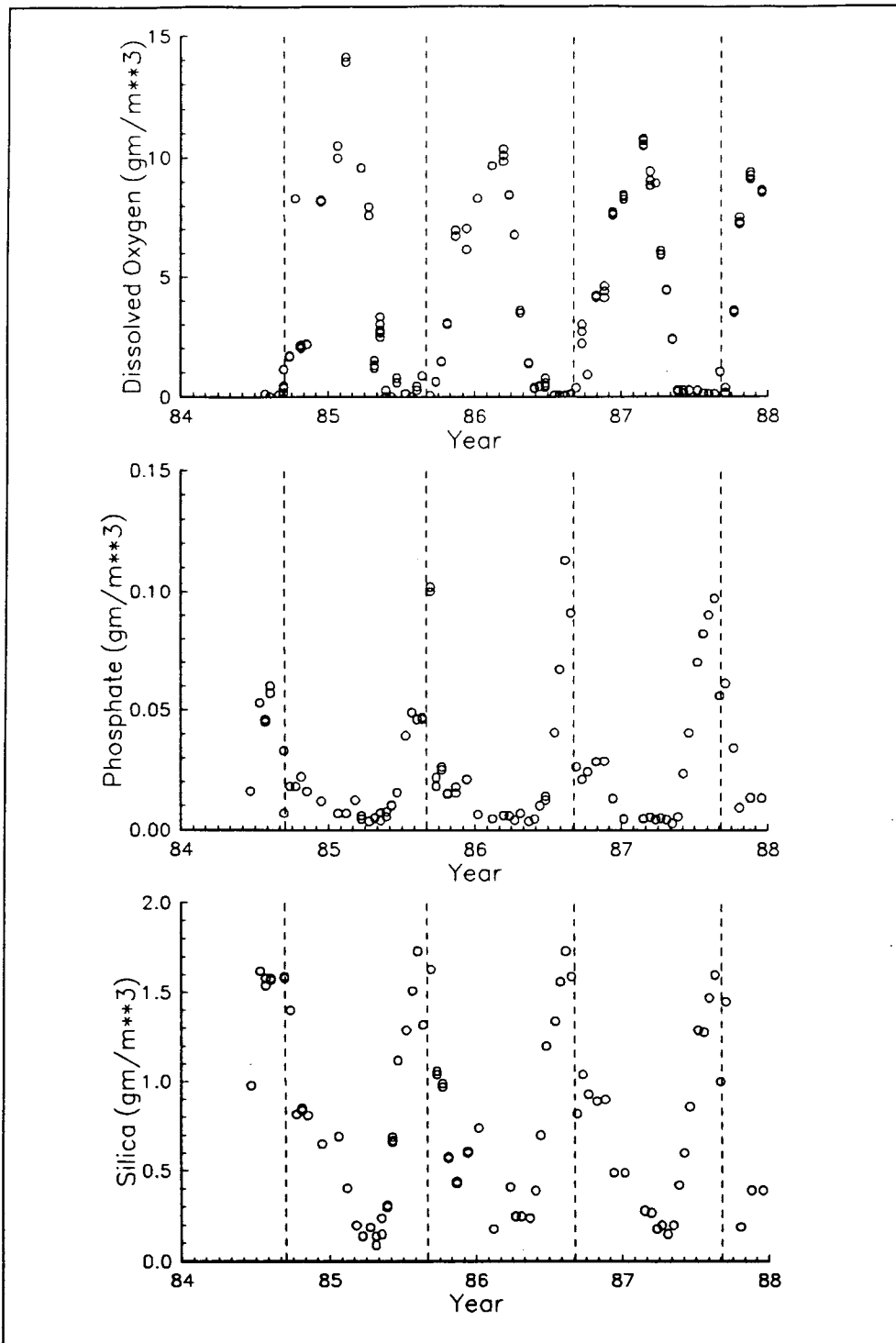

Figure 3-13. Dissolved oxygen, dissolved phosphate, and dissolved silica, 1 meter from bottom, Chesapeake Bay station CB3.3C

$$PO_{4p} = \frac{Kadpo4 TAMp}{1 + Kadpo4 TAMp} (PO_{4t} - PO_{4a}) \quad (3-48)$$

$Kadpo4$  = partition coefficient of sorbed versus dissolved phosphate ( $m^3 \text{ mol}^{-1}$ )

$TAMp$  = particulate total active metal ( $\text{mol m}^{-3}$ )

### Computation of algal phosphorus

Algal phosphorus is defined:

$$PO_{4a} = APC \sum_{x=c,d,g} Bx \quad (3-49)$$

The phosphorus-to-carbon ratio is calculated by the empirical function expressed in Equation 3-30.

Equations 3-30, 3-47, 3-48, and 3-49 form an implicit system. The implicit nature of the system can be seen by substituting the expressions for dissolved phosphate (Equation 3-47) and algal phosphate (Equation 3-49) into the expression for phosphorus-to-carbon ratio (Equation 3-30). For notational simplicity, assume negligible  $TAMp$ . Then:

$$APC = \frac{1}{PCprm1 + PCprm2 e^{-PCprm3(PO_{4t} - APC \sum Bx)}} \quad (3-50)$$

The phosphorus-to-carbon ratio appears on both sides of the equation and cannot be obtained explicitly. Within the model code, phosphorus-to-carbon ratio is obtained by iterative solution of Equation 3-50 in each control volume at each time step. Following computation of phosphorus-to-carbon ratio, algal phosphorus is computed (Equation 3-49). Next, extra-cellular phosphate is partitioned into dissolved and particulate fractions (Equations 3-47 and 3-48).

### Effect of variable phosphorus stoichiometry

The effect of the variable phosphorus-to-carbon ratio and the operation of the total phosphate system is best seen by an example. The model was applied to a chemostat supplied with unlimited inorganic nitrogen. Phosphorus recycling was eliminated in the water and sediments so that only the initial phosphate was available to the algae. The chemostat was simulated for

30 days. Midway through the simulation, a phosphate load, equivalent to the initial mass in the chemostat, was injected. Simulations were conducted with and without variable stoichiometry.

Algal production was initially identical with and without variable stoichiometry (Figure 3-14). As dissolved phosphate became scarce in the constant-stoichiometry chemostat, algal production diminished so that respiration exceeded growth prior to day five. Biomass decreased until the phosphate injection at day fifteen. In the variable-stoichiometry chemostat, algae responded to diminished phosphate availability by reducing their phosphorus-to-carbon ratio. Because less phosphorus was required per unit carbonaceous biomass formed, growth exceeded respiration beyond day five and maximum biomass exceeded biomass formed under constant stoichiometry. Upon injection of new phosphate, algal production increased with and without variable stoichiometry. Algae with variable stoichiometry responded with increased phosphorus-to-carbon ratio as well as increased production. As a result of the altered ratio, dissolved phosphate peaked at a lower concentration in the presence of variable stoichiometry. The ability of algae to diminish phosphorus-to-carbon ratio still allowed algae in the variable-stoichiometry chemostat to exceed biomass formed in the constant-stoichiometry chemostat, however.

This example is an analog to our simulation of the spring algal bloom and late autumn flood periods in Chesapeake Bay. We found that variable stoichiometry provided the minimum phosphorus-to-carbon ratio necessary to simulate the spring bloom. As an alternative, we could have specified a constant, extremely low phosphorus-to-carbon ratio. We found, however, that algal phosphorus uptake in autumn and winter was too low when a constant, minimum ratio was employed. Predicted dissolved phosphate exceeded observations during these seasons. In multi-year simulations, the excess phosphate “carried over” into the subsequent spring and confounded simulation of the spring bloom. Variable stoichiometry allowed reasonable simulations of dissolved phosphate over lengthy periods spanning seasons of high and low dissolved phosphate concentrations.

## Phosphate

Once the interactions of dissolved, particulate, and algal phosphate are made explicit, the balance of the equations describing phosphorus are straightforward summations of previously-described sources and sinks:

$$\begin{aligned} \frac{\delta}{\delta t} PO_4^t = & - \sum_{x=c,d,g} WS_x \frac{\delta}{\delta z} APC B_x \\ & - WS_s \frac{\delta}{\delta z} PO_4^p + K_{dop} DOP \end{aligned} \quad (3-51)$$

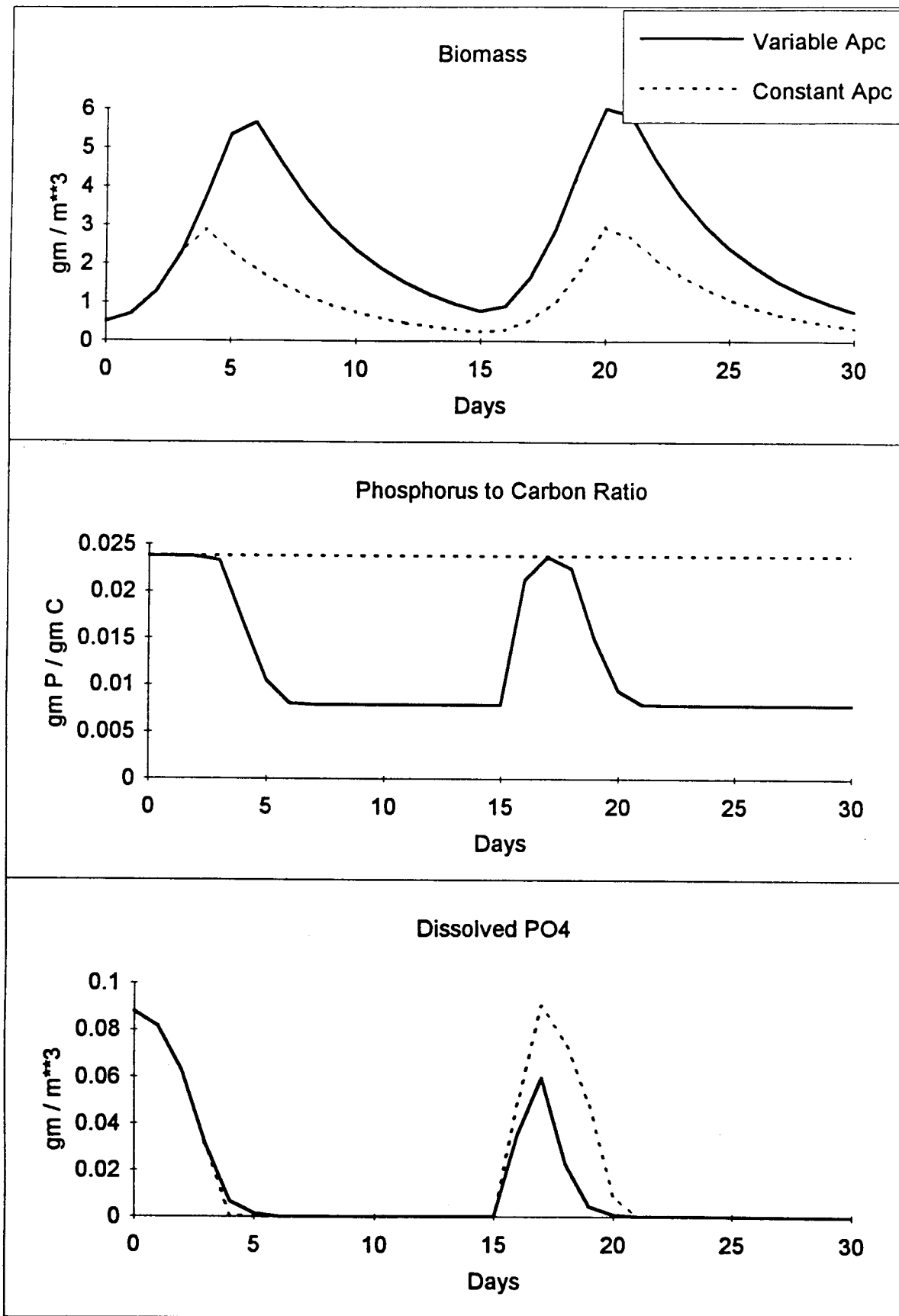

Figure 3-14. Chemostat simulation with and without variable phosphorus stoichiometry



where  $WS_s$  is the settling velocity of particulate metal ( $m\ day^{-1}$ ).

Algal uptake and release of phosphate represents an exchange of phosphate fractions rather than a phosphate source or sink. Consequently, no algal source or sink terms are included in the phosphate mass-conservation equation. The settling terms are required to represent the settling of particulate phosphate incorporated in algal biomass or sorbed to particles.

### Dissolved organic phosphorus

$$\begin{aligned} \frac{\delta}{\delta t} DOP = & \sum_{x=c,d,g} (BM_x FPD_x + PR_x FPDP) APC B_x \\ & + Kl_{pop} LPOP + Kr_{pop} RPOP - Kdop DOP \end{aligned} \quad (3-52)$$

### Labile particulate organic phosphorus

$$\begin{aligned} \frac{\delta}{\delta t} LPOP = & \sum_{x=c,d,g} (BM_x FPL_x + PR_x FPLP) APC B_x \\ & - Kl_{pop} LPOP - WS_l \frac{\delta}{\delta z} LPOP \end{aligned} \quad (3-53)$$

### Refractory particulate organic phosphorus

$$\begin{aligned} \frac{\delta}{\delta t} RPOP = & \sum_{x=c,d,g} (BM_x FPR_x + PR_x FPRP) APC B_x \\ & - Kr_{pop} RPOP - WS_r \frac{\delta}{\delta z} RPOP \end{aligned} \quad (3-54)$$

## Nitrogen

The model nitrogen cycle (Figure 3-15) includes the following processes:

- Algal production and metabolism
- Predation
- Hydrolysis of particulate organic nitrogen
- Mineralization of dissolved organic nitrogen

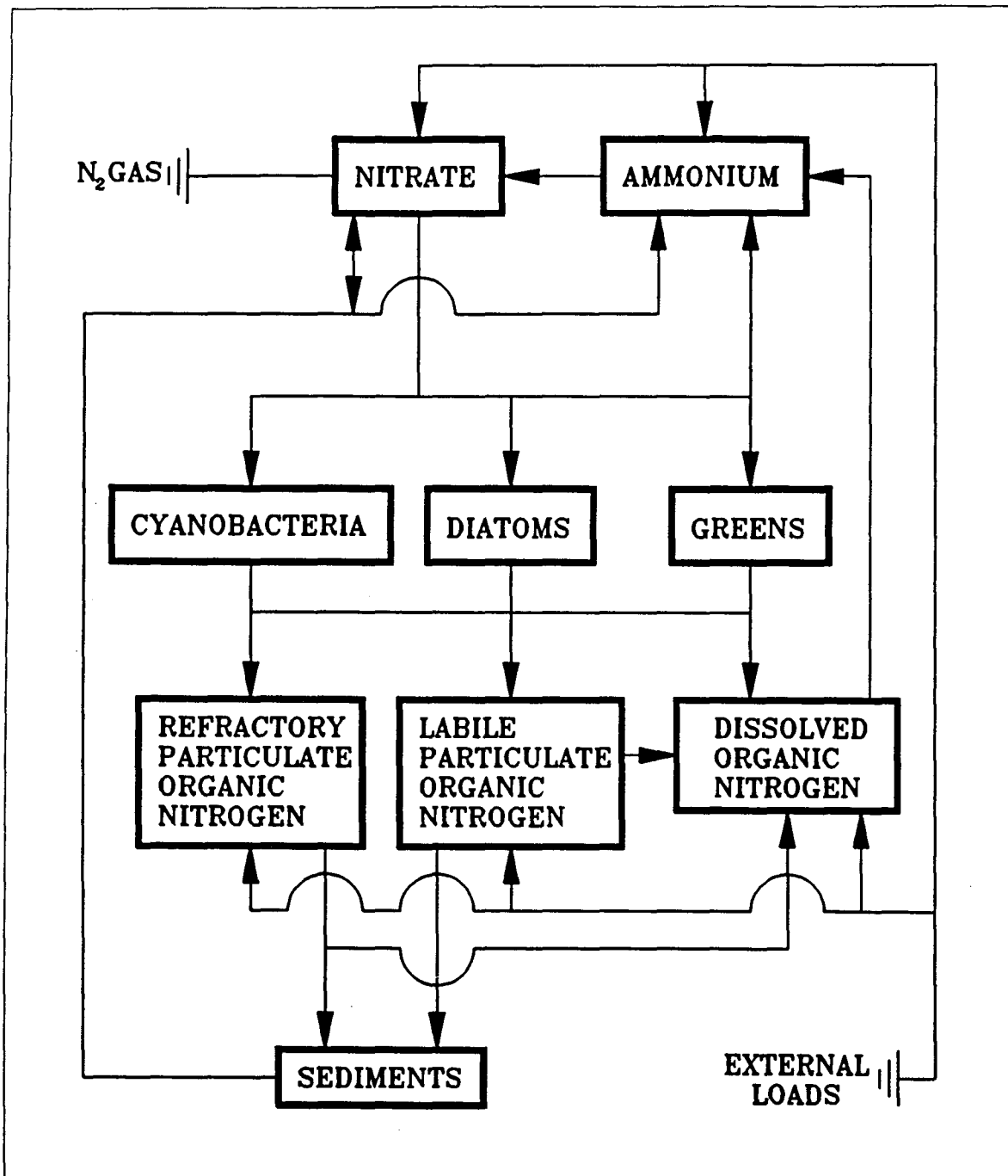

Figure 3-15. Model nitrogen cycle

Settling  
 Nitrification  
 Denitrification

External loads provide the ultimate source of nitrogen to the system. Inorganic nitrogen is incorporated by algae during growth and released as ammonium and organic nitrogen through respiration and predation. A portion

of the particulate organic nitrogen hydrolyzes to dissolved organic nitrogen. The balance settles to the sediments. Dissolved organic nitrogen is mineralized to ammonium. In an oxygenated water column, a fraction of the ammonium is subsequently oxidized to nitrate through the nitrification process. In anoxic water, nitrate is lost to nitrogen gas through denitrification. Particulate nitrogen that settles to the sediments is mineralized and recycled to the water column, primarily as ammonium. Nitrate moves in both directions across the sediment-water interface, depending on relative concentrations in the water column and sediment interstices.

Effects on nitrogen of algal production, metabolism, and predation have already been detailed. Descriptions of hydrolysis, mineralization, nitrification and denitrification follow.

### Hydrolysis and mineralization

In the model, particulate organic nitrogen is converted to the dissolved organic form via hydrolysis. Dissolved organic nitrogen is converted to ammonium through mineralization. Conversion of particulate nitrogen to ammonium proceeds through the sequence of hydrolysis and mineralization. Direct mineralization of particulate nitrogen does not occur. The argument for accelerated hydrolysis and mineralization during nutrient-limited conditions is not as clear for nitrogen as for phosphorus. The same formulations are made available for nitrogen as for phosphorus, however. Accelerated processes can be activated or deactivated through parameter selection. The nitrogen hydrolysis and mineralization formulations are:

$$K_{don} = K_{dn} + \frac{KHn}{KHn + NH_4 + NO_3} K_{dnalg} \sum_{x=c,d,g} Bx \quad (3-55)$$

$K_{don}$  = mineralization rate of dissolved organic nitrogen ( $\text{day}^{-1}$ )

$K_{dn}$  = minimum mineralization rate ( $\text{day}^{-1}$ )

$KHn$  = mean half-saturation constant for algal nitrogen uptake ( $\text{gm N m}^{-3}$ ) =  $(KHnc + KHnd + KHng)/3$

$K_{dnalg}$  = constant that relates mineralization to algal biomass ( $\text{m}^3 \text{ gm}^{-1} \text{ C day}^{-1}$ )

$$K_{lpon} = K_{ln} + \frac{KHn}{KHn + NH_4 + NO_3} K_{lnalg} \sum_{x=c,d,g} Bx \quad (3-56)$$

$K_{lpon}$  = hydrolysis rate of labile particulate nitrogen ( $\text{day}^{-1}$ )

$Kln$  = minimum hydrolysis rate ( $\text{day}^{-1}$ )

$Klnalg$  = constant that relates hydrolysis to algal biomass ( $\text{m}^3 \text{ gm}^{-1} \text{ C day}^{-1}$ )

$$Krpon = Krn + \frac{KHn}{KHn + NH_4 + NO_3} Krnalg \sum_{x=c,d,g} Bx \quad (3-57)$$

$Krpon$  = hydrolysis rate of refractory particulate nitrogen ( $\text{day}^{-1}$ )

$Krn$  = minimum hydrolysis rate ( $\text{day}^{-1}$ )

$Krnalg$  = constant that relates hydrolysis to algal biomass ( $\text{m}^3 \text{ gm}^{-1} \text{ C day}^{-1}$ )

An exponential function (Figure 3-5) relates mineralization and hydrolysis rates to temperature.

### Nitrification

Nitrification is a process mediated by specialized groups of autotrophic bacteria that obtain energy through the oxidation of ammonium to nitrite and oxidation of nitrite to nitrate. A simplified expression for complete nitrification (Tchobanoglous and Schroeder 1987) is:

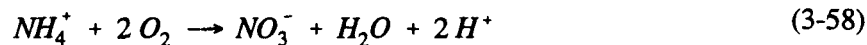

The equation indicates that two moles of oxygen are required to nitrify one mole of ammonium into nitrate. The simplified equation is not strictly true, however. Cell synthesis by nitrifying bacteria is accomplished by the fixation of carbon dioxide so that less than two moles of oxygen are consumed per mole ammonium utilized (Wezernak and Gannon 1968).

The kinetics of complete nitrification are modeled as a function of available ammonium, dissolved oxygen, and temperature:

$$NT = \frac{DO}{KHont + DO} \frac{NH_4}{KHnt + NH_4} f(T) NTm \quad (3-59)$$

$NT$  = nitrification rate ( $\text{gm N m}^{-3} \text{ day}^{-1}$ )

$KH_{ont}$  = half-saturation constant of dissolved oxygen required for nitrification ( $\text{gm O}_2 \text{ m}^{-3}$ )

$KH_{nnt}$  = half-saturation constant of  $\text{NH}_4$  required for nitrification ( $\text{gm N m}^{-3}$ )

$NT_m$  = maximum nitrification rate at optimal temperature ( $\text{gm N m}^{-3} \text{ day}^{-1}$ )

The kinetics formulation (Figure 3-16) incorporates the products of two "Monod" functions. The first function diminishes nitrification at low dissolved oxygen concentration. The second function expresses the influence of ammonium concentration on nitrification. When ammonium concentration is low, relative to  $KH_{nnt}$ , nitrification is proportional to ammonium concentration. For  $\text{NH}_4 \ll KH_{nnt}$ , the reaction is approximately first-order. (The first-order decay constant  $\approx NT_m/KH_{nnt}$ .) When ammonium concentration is large, relative to  $KH_{nnt}$ , nitrification approaches a maximum rate. This formulation is based on a concept proposed by Tuffey et al. (1974). Nitrifying bacteria adhere to benthic or suspended sediments. When ammonium is scarce, vacant surfaces suitable for nitrifying bacteria exist. As ammonium concentration increases, bacterial biomass increases, vacant surfaces are occupied, and the rate of nitrification increases. The bacterial population attains maximum density when all surfaces suitable for bacteria are occupied. At this point, nitrification proceeds at a maximum rate independent of additional increase in ammonium concentration.

The optimal temperature for nitrification may be less than peak temperatures that occur in coastal waters. To allow for a decrease in nitrification at superoptimal temperature, the effect of temperature on nitrification is modeled in the Gaussian form of Equation 3-13.

#### Effect of nitrification on ammonium

$$\frac{\delta}{\delta t} \text{NH}_4 = - NT \quad (3-60)$$

#### Effect of nitrification on nitrate

$$\frac{\delta}{\delta t} \text{NO}_3 = NT \quad (3-61)$$

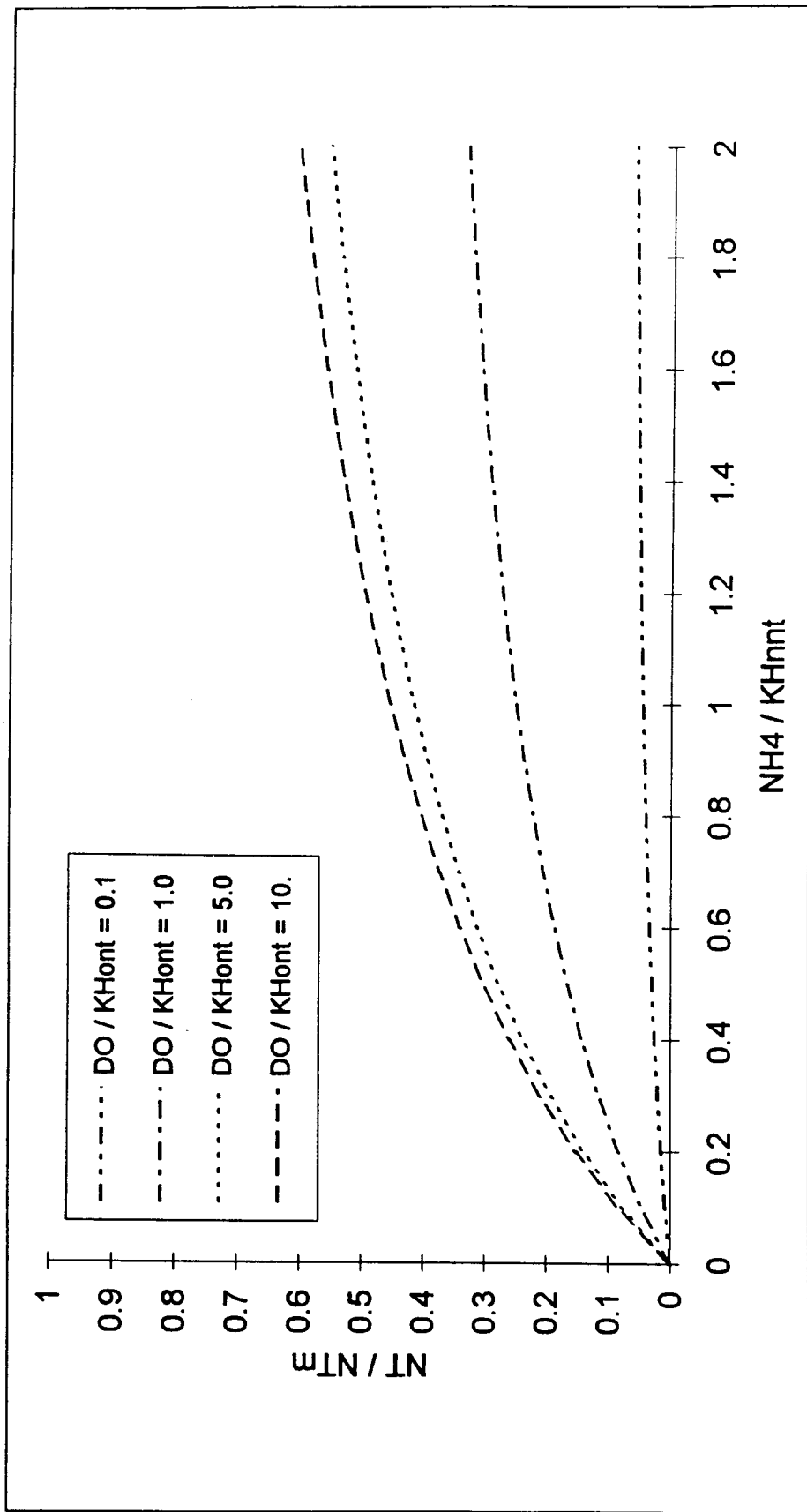

Figure 3-16. Effect of dissolved oxygen and ammonium concentration on nitrification rate

### Effect of nitrification on dissolved oxygen

$$\frac{\delta}{\delta t} DO = - AONT NT \quad (3-62)$$

where  $AONT$  is the mass dissolved oxygen consumed per mass ammonium-nitrogen nitrified ( $4.33 \text{ gm O}_2 \text{ gm}^{-1} \text{ N}$ ).

### Effect of denitrification on nitrate

The effect of denitrification on dissolved organic carbon has been described. Denitrification removes nitrate from the system in stoichiometric proportion to carbon removal as determined by Equation 3-38:

$$\frac{\delta}{\delta t} NO_3 = - ANDC Denit DOC \quad (3-63)$$

where  $ANDC$  is the mass nitrate-nitrogen reduced per mass dissolved organic carbon oxidized ( $0.933 \text{ gm N gm}^{-1} \text{ C}$ ).

### Nitrogen mass balance equations

The mass-balance equations for nitrogen state variables are written by summing all previously-described sources and sinks:

#### Ammonium

$$\begin{aligned} \frac{\delta}{\delta t} NH_4 = & \sum_{x=c,d,g} (BM_x FN_{1x} + PR_x FN_{1P} - PN_x P_x) ANC_x B_x \\ & + K_{don} DON - NT \end{aligned} \quad (3-64)$$

### Dissolved organic nitrogen

$$\begin{aligned} \frac{\delta}{\delta t} DON = \sum_{x=c,d,g} (BM_x FND_x + PR_x FNDP) ANC_x B_x \\ + Kl_{pon} LPON + Kr_{pon} RPON - K_{don} DON \end{aligned} \quad (3-65)$$

### Labile particulate organic nitrogen

$$\begin{aligned} \frac{\delta}{\delta t} LPON = \sum_{x=c,d,g} (BM_x FNL_x + PR_x FNL P) ANC_x B_x \\ - Kl_{pon} LPON - WSl \frac{\delta}{\delta z} LPON \end{aligned} \quad (3-66)$$

### Refractory particulate organic nitrogen

$$\begin{aligned} \frac{\delta}{\delta t} RPON = \sum_{x=c,d,g} (BM_x FNR_x + PR_x FNR P) ANC_x B_x \\ - Kr_{pon} RPON - WSl \frac{\delta}{\delta z} RPON \end{aligned} \quad (3-67)$$

### Nitrate

$$\begin{aligned} \frac{\delta}{\delta t} NO_3 = \sum_{x=c,d,g} (PN_x - 1) P_x ANC_x B_x \\ + NT - ANDC Denit DOC \end{aligned} \quad (3-68)$$

### Silica

The model incorporates two siliceous state variables, available silica and particulate biogenic silica. For practical purposes, available silica is equivalent to dissolved silica although sorption of available silica to inorganic solids occurs. The silica cycle (Figure 3-17) is a simple one in which diatoms take



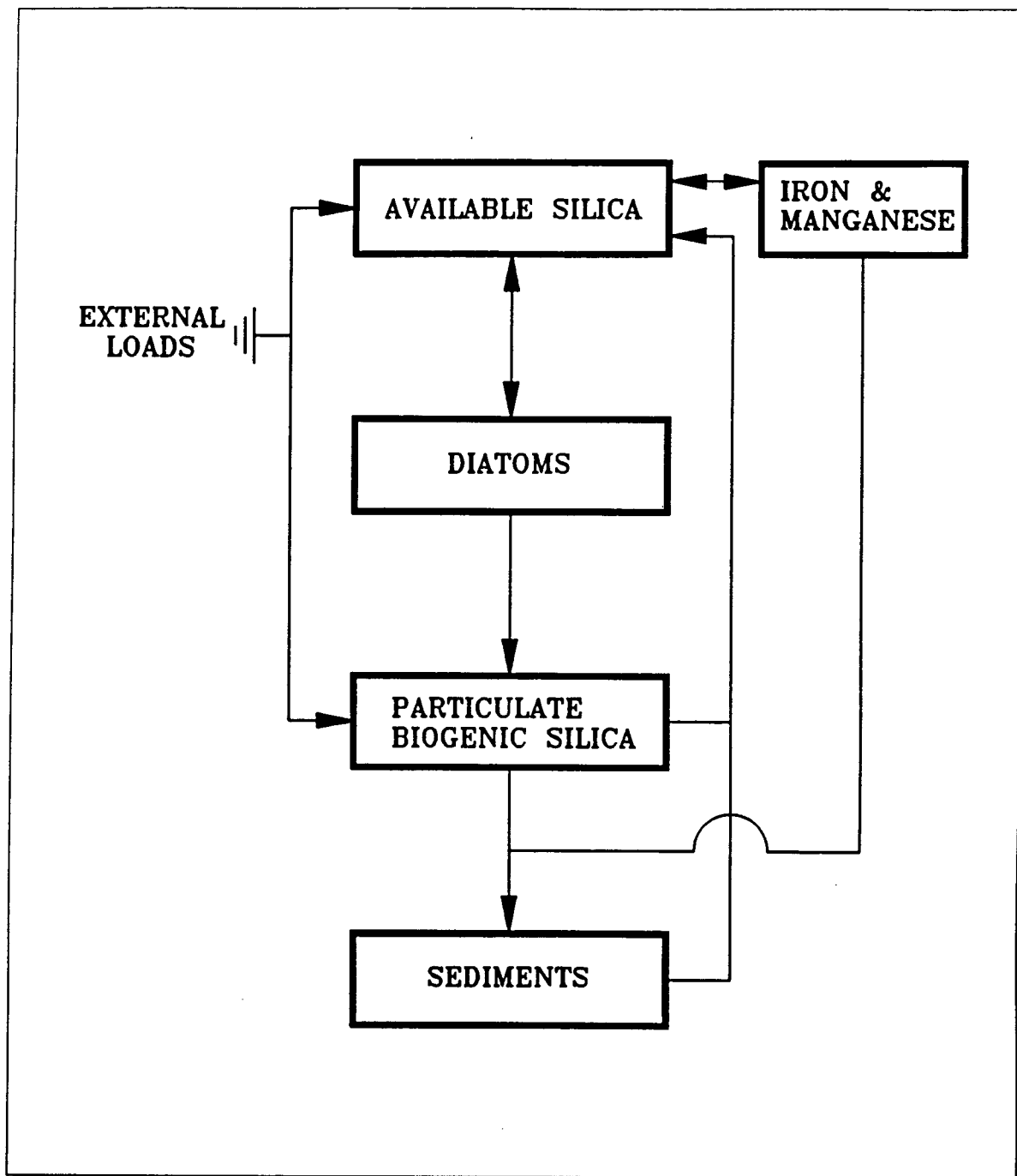

Figure 3-17. Model silica cycle

up available silica and recycle available and particulate biogenic silica through the actions of metabolism and predation. Particulate silica dissolves in the water column or settles to the bottom. A portion of the settled particulate biogenic dissolves within the sediments and returns to the water column as available silica. Sources and sinks represented are:

Diatom production and metabolism  
 Predation  
 Dissolution of particulate to dissolved silica  
 Settling  
 Exchange with inorganic solids

### Available silica

Analysis of monitoring data indicated depletion of dissolved silica from anoxic bottom water following reaeration events (Figure 3-13). The phenomenon was similar to, and concurrent with, phosphate depletion. Our hypothesis to explain the phenomenon was the same as for phosphorus. Reaeration of bottom waters caused dissolved iron and manganese to precipitate. Dissolved silica sorbed to the newly formed metal particles and rapidly settled to the bottom. To represent this process, available silica was partitioned into dissolved and particulate fractions according to a linear sorption isotherm:

$$SA_d = \frac{1}{1 + K_{ads} TAP} SA \quad (3-69)$$

$$SA_p = \frac{K_{ads} TAP}{1 + K_{ads} TAP} SA \quad (3-70)$$

$SA$  = available silica concentration (gm Si m<sup>-3</sup>)

$SA_d$  = dissolved available silica (gm Si m<sup>-3</sup>)

$SA_p$  = particulate available silica (gm Si m<sup>-3</sup>)

$K_{ads}$  = partition coefficient of sorbed versus dissolved available silica  
 (m<sup>3</sup> mol<sup>-1</sup>)

The kinetics equation for available silica is:

$$\begin{aligned} \frac{\delta}{\delta t} SA &= (FSAP PR_d - Pd) ASC_d Bd \\ &- WS_s \frac{\delta}{\delta z} SA_p + K_{sua} SU \end{aligned} \quad (3-71)$$

$FSAP$  = fraction of diatom silica made available by predation  
 (0 ≤  $FSAP$  ≤ 1)

$ASCd$  = silica-to-carbon ratio of diatoms ( $\text{gm Si gm}^{-1} \text{C}$ )

$SU$  = particulate biogenic silica concentration ( $\text{gm Si m}^{-3}$ )

$Ksua$  = particulate silica dissolution rate ( $\text{day}^{-1}$ )

### Particulate biogenic silica

The kinetics equation for particulate biogenic silica is:

$$\begin{aligned} \frac{\delta}{\delta t} SU = & (Bmd + (1 - FSAP) PRd) ASCd Bd \\ & - WSs \frac{\delta}{\delta z} SU - Ksua SU \end{aligned} \quad (3-72)$$

An exponential function (Figure 3-5) describes the effect of temperature on silica dissolution.

## Chemical Oxygen Demand

Chemical oxygen demand is the concentration of reduced substances that are oxidizable through inorganic means. The source of chemical oxygen demand in saline water is sulfide released from sediments. A cycle occurs in which sulfate is reduced to sulfide in the sediments and reoxidized to sulfate in the water column. In freshwater, methane is released to the water column by the sediment model. Both sulfide and methane are quantified in units of oxygen demand and are treated with the same kinetics formulation:

$$\frac{\delta}{\delta t} COD = - \frac{DO}{KHocod + DO} Kcod COD \quad (3-73)$$

$COD$  = chemical oxygen demand concentration ( $\text{gm O}_2\text{-equivalents m}^{-3}$ )

$KHocod$  = half-saturation concentration of dissolved oxygen required for exertion of chemical oxygen demand ( $\text{gm O}_2 \text{m}^{-3}$ )

$Kcod$  = oxidation rate of chemical oxygen demand ( $\text{day}^{-1}$ )

An exponential function (Figure 3-5) describes the effect of temperature on exertion of chemical oxygen demand.

## Dissolved Oxygen

Sources and sinks of dissolved oxygen in the water column (Figure 3-18) include:

- Algal photosynthesis
- Atmospheric reaeration
- Algal respiration
- Heterotrophic respiration
- Nitrification
- Chemical oxygen demand

### Reaeration

The rate of reaeration is proportional to the dissolved oxygen deficit in model segments that form the air-water interface:

$$\frac{\delta}{\delta t} DO = \frac{Kr}{\Delta z} (DO_s - DO) \quad (3-74)$$

$Kr$  = reaeration coefficient (m day<sup>-1</sup>)

$DO_s$  = dissolved oxygen saturation concentration (gm O<sub>2</sub> m<sup>-3</sup>)

In shallow water (e.g. free-flowing streams), the reaeration coefficient depends largely on turbulence generated by bottom shear stress (O'Connor and Dobbins 1958). In deeper systems (e.g. estuaries), however, wind effects may dominate the reaeration process (O'Connor 1983). The reaeration coefficient is also influenced by temperature (ASCE 1961) and salinity (Wen et al. 1984). No universal formula for evaluation of the reaeration coefficient exists. In the model, the reaeration coefficient is treated as a user-supplied parameter.

Saturation dissolved oxygen concentration diminishes as temperature and salinity increase. An empirical formula that describes these effects (Genet et al. 1974) is:

$$\begin{aligned} DO_s = & 14.5532 - 0.38217 T + 0.0054258 T^2 \\ & - CL (1.665 \times 10^{-4} - 5.866 \times 10^{-6} T \\ & + 9.796 \times 10^{-8} T^2) \end{aligned} \quad (3-75)$$

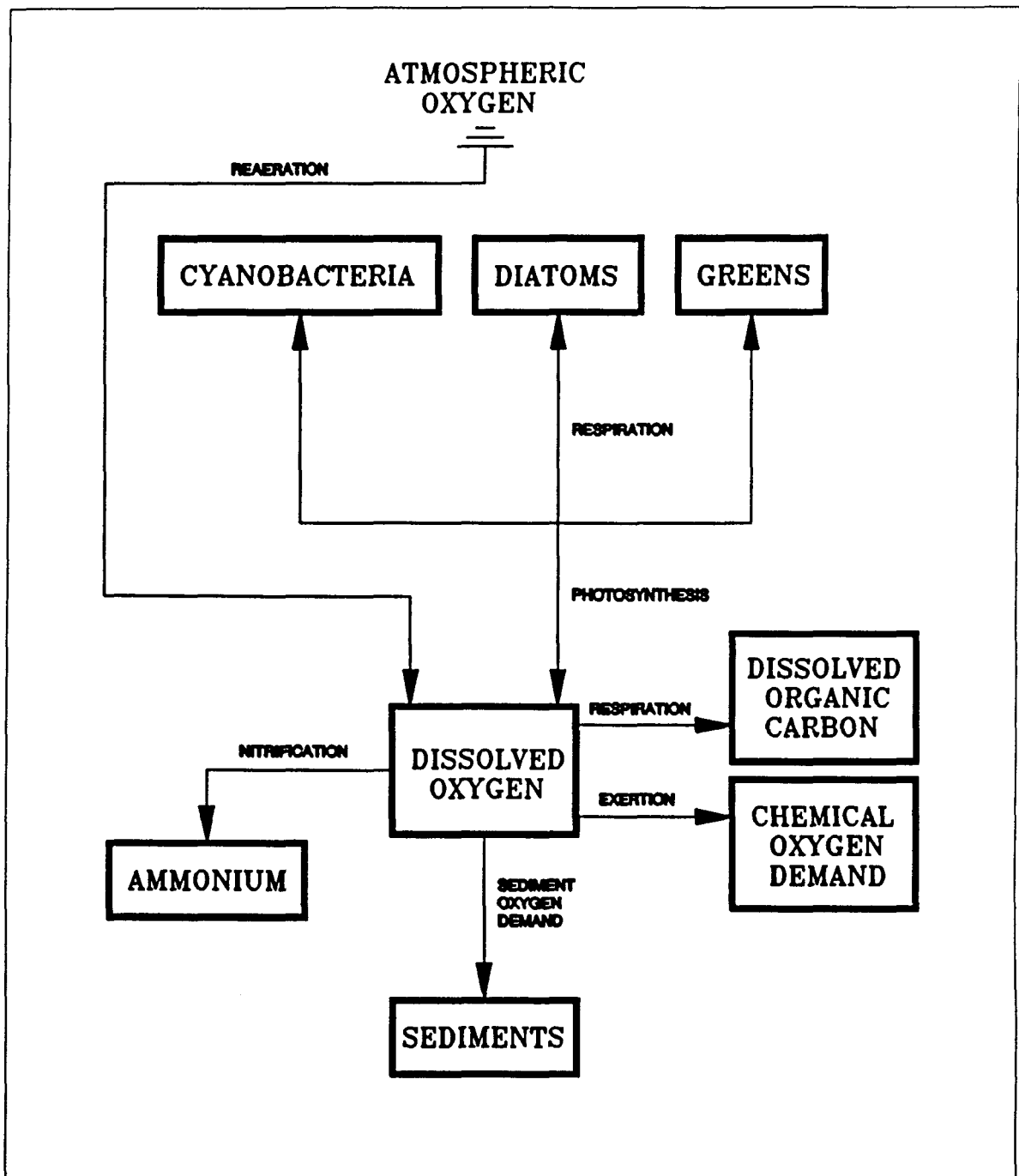

Figure 3-18. Dissolved oxygen sources and sinks

where  $CL$  is the chloride concentration ( $= \text{salinity}/1.80655$ ).

### Summary of dissolved oxygen sources and sinks

The complete kinetics for dissolved oxygen are:

$$\begin{aligned}
\frac{\delta}{\delta t} DO = & \sum_{x=c,d,g} \left[ (1.3 - 0.3 PN_x) P_x - \frac{DO}{KH_{rx} + DO} BM_x \right] AOCR B_x \\
& - AONT NT - \frac{DO}{KH_{doc} + DO} AOCR K_{doc} DOC \\
& - \frac{DO}{KH_{cod} + DO} K_{cod} COD + \frac{K_r}{\Delta z} (DO_s - DO)
\end{aligned} \tag{3-76}$$

## Total Active Metal

The total active metal state variable is the sum of iron and manganese concentrations. Iron and manganese exist in particulate and dissolved forms in estuaries. The prime determinant of the species is dissolved oxygen. In the oxygenated water, total iron and manganese are almost completely particulate. Under anoxic conditions, large fractions of total iron and manganese are dissolved although solid-phase sulfides and carbonates exist and may predominate. The simplified partitioning of particulate and dissolved phases of total active metal employed here notes that total active metal concentration must achieve a minimum level before precipitation occurs. The minimum level is a function of dissolved oxygen:

$$TAM_d = \text{minimum}(TAM_{dmx} e^{-K_{dotam} DO}, TAM) \tag{3-77}$$

$$TAM_p = TAM - TAM_d \tag{3-78}$$

$TAM$  = total active metal concentration ( $\text{mol m}^{-3}$ )

$TAM_d$  = dissolved total active metal ( $\text{mol m}^{-3}$ )

$TAM_p$  = particulate total active metal ( $\text{mol m}^{-3}$ )

$TAM_{dmx}$  = solubility of total active metal under anoxic conditions ( $\text{mol m}^{-3}$ )

$K_{dotam}$  = constant that relates total active metal solubility to dissolved oxygen concentration ( $\text{m}^3 \text{gm}^{-1} \text{O}_2$ )

Behavior of the functions expressed in Equations 3-77 and 3-78 is shown in Figures 3-19 and 3-20. In the first figure, total active metal concentration exceeds the maximum solubility,  $TAM_{dmx}$ . Particulate metal is present at all dissolved oxygen concentrations. The particulate fraction increases as oxygen

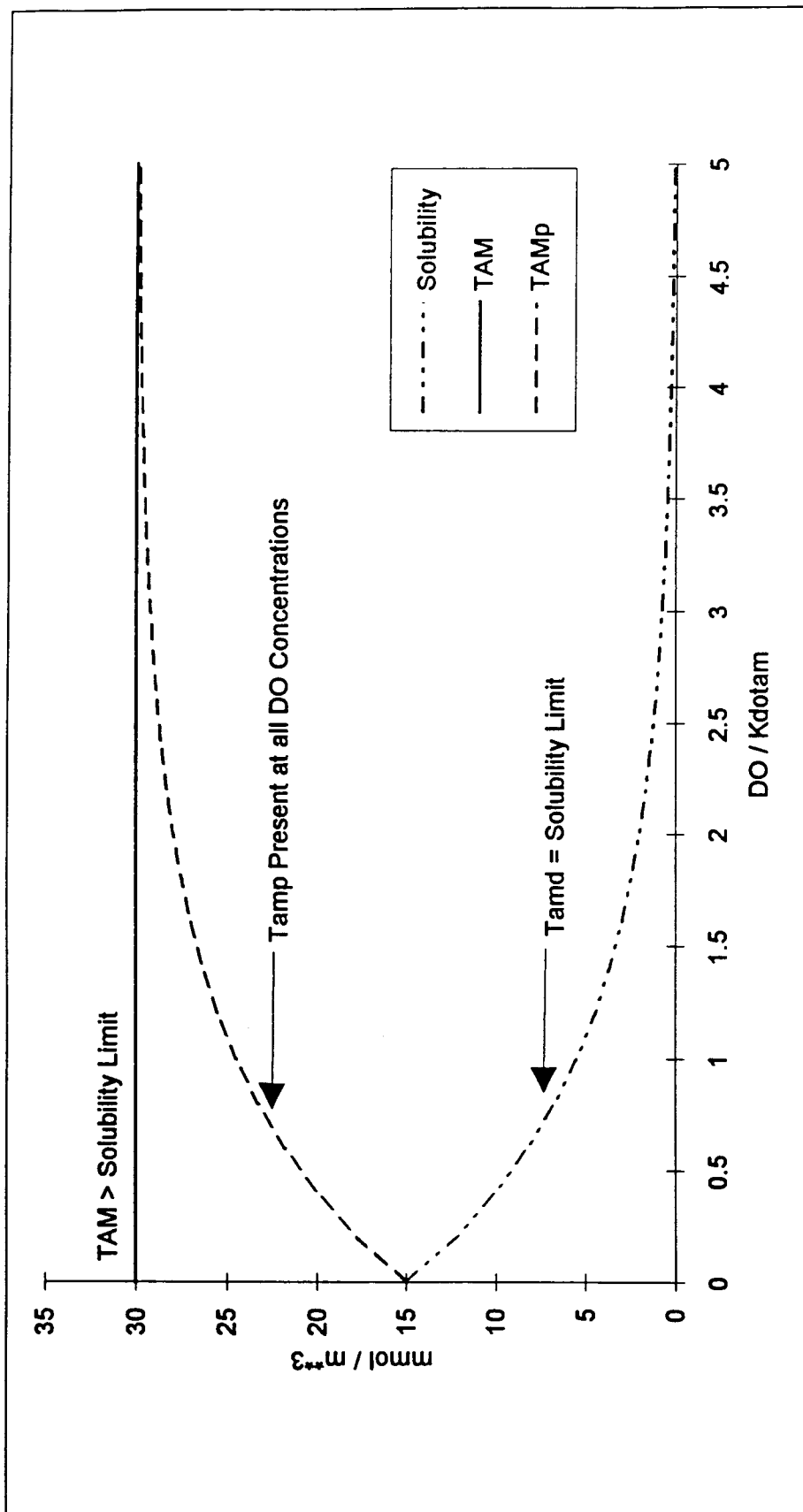

Figure 3-19. Total active metal partitioning when concentration exceeds maximum solubility

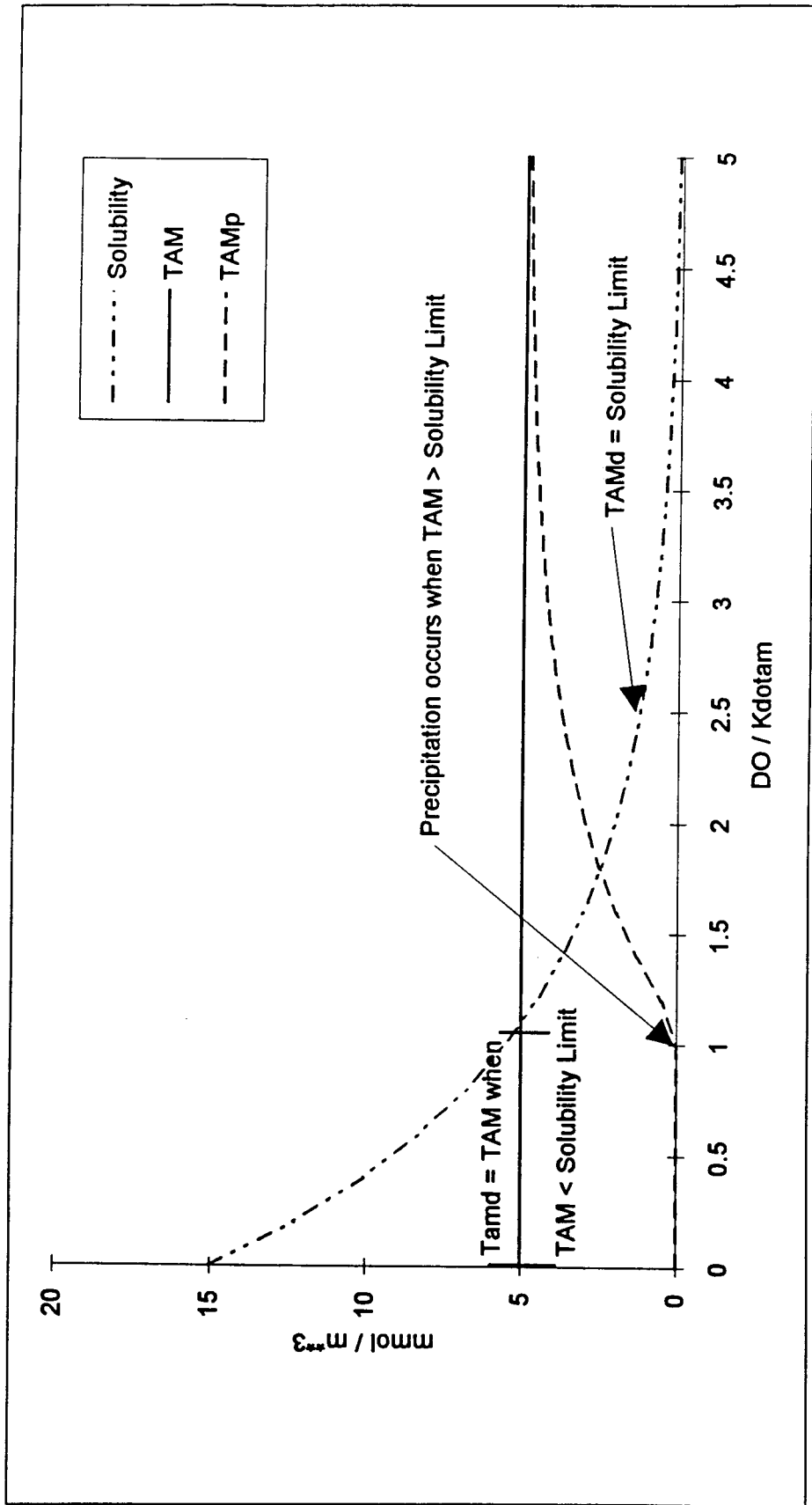

Figure 3-20. Total active metal partitioning when concentration is less than maximum solubility



concentration increases. When dissolved oxygen  $\gg K_{dotam}$ , virtually all metal is in particulate form. In the second figure, total active metal concentration is less than the maximum solubility. All metal is in dissolved form until oxygen-dependent solubility falls below total metal concentration. At that oxygen concentration, precipitation of particulate metal occurs. Following precipitation, the particulate fraction increases as a function of oxygen concentration until virtually all metal is particulate when dissolved oxygen  $\gg K_{dotam}$ .

The origin of total active metal in the model is benthic sediments. Since metal release is not explicit in the sediment model, release is incorporated into the kinetics portion of the water column model. Release is treated as a spatially uniform, empirical function of temperature and dissolved oxygen concentration. The only other source or sink in the water column is settling of the particulate fraction. In the mass balance equation that follows, the benthic source is understood to operate only in model cells that adjoin the bottom:

$$\frac{\delta}{\delta t} TAM = - WSs \frac{\delta}{\delta z} TAM_p + \frac{KHbmf}{KHbmf + DO} \frac{BENTAM}{\Delta z} \quad (3-79)$$

$KHbmf$  = dissolved oxygen concentration at which total active metal release is half the anoxic rate ( $\text{gm O}_2 \text{ m}^{-3}$ )

$BENTAM$  = anoxic total active metal release rate ( $\text{mol m}^{-2} \text{ day}^{-1}$ )

Release of metal from the bottom is maximum when dissolved oxygen is absent from the overlying water (Figure 3-21). Release declines as oxygen concentration increases and is negligible when dissolved oxygen  $\gg KHbmf$ .

Sediment release of total active metal is treated as an exponential function of temperature (Figure 3-5).

## Salinity

No internal sources or sinks of salinity exist.

## Temperature

A conservation of internal energy equation can be written analogous to the conservation of mass equation. The only source or sink of internal energy considered is exchange with the atmosphere. Although solar radiation can penetrate several meters into the water column, radiation-induced increases in internal energy are here assigned entirely to the surface model layer.

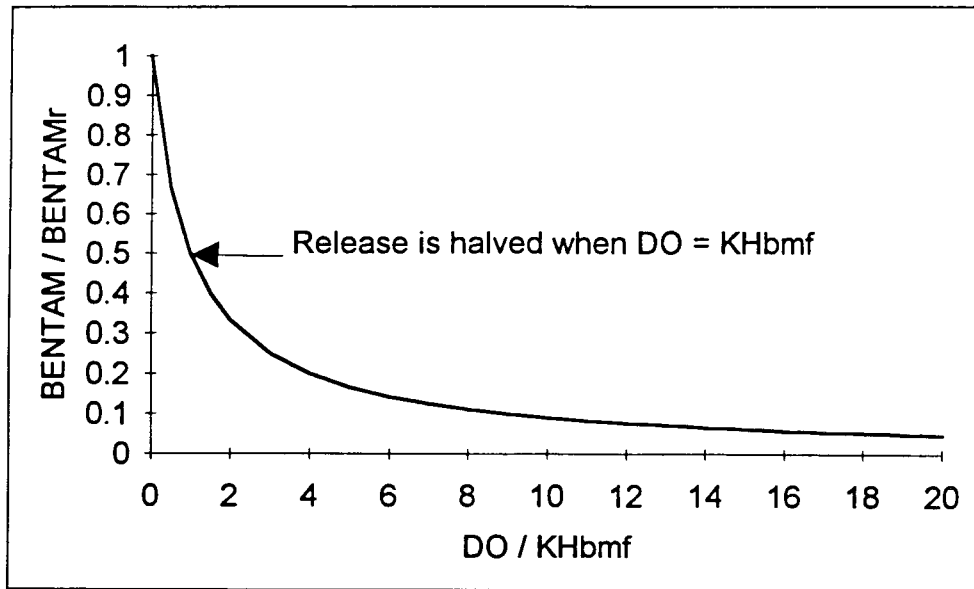

Figure 3-21. Effect of dissolved oxygen on benthic metal release

For practical purposes, the internal-energy equation can be written as a conservation of temperature equation. Change of temperature due to atmospheric exchange is considered proportional to the temperature difference between the water surface and a theoretical equilibrium temperature (Edinger et al. 1974):

$$\frac{\delta}{\delta t} T = \frac{KT}{\rho C_p \Delta z} (T_e - T) \quad (3-80)$$

$KT$  = heat exchange coefficient ( $\text{watt m}^{-2} \text{C}^{\circ-1}$ )

$T_e$  = equilibrium temperature ( $\text{C}^{\circ}$ )

$\rho$  = density of water ( $1000 \text{ kg m}^{-3}$ )

$C_p$  = specific heat of water ( $4200 \text{ watt sec kg}^{-1} \text{C}^{\circ-1}$ )

## Glossary

Table 3-2 presents a glossary of all terms employed in equations in this chapter.

<b>Table 3-2 Terms in Kinetics Equations</b>		
<b>Symbol</b>	<b>Definition</b>	<b>Units</b>
<i>AANOX</i>	ratio of denitrification to oxic carbon respiration rate	
<i>ANC<sub>x</sub></i>	nitrogen-to-carbon ratio of algal group x	gm N gm <sup>-1</sup> C
<i>AOCR</i>	dissolved oxygen-to-carbon ratio in respiration	gm O <sub>2</sub> gm <sup>-1</sup> C
<i>AONT</i>	mass dissolved oxygen consumed per mass ammonium nitrified	gm O <sub>2</sub> gm <sup>-1</sup> N
<i>ANDC</i>	mass nitrate-nitrogen consumed per mass carbon oxidized	gm N gm <sup>-1</sup> C
<i>APC</i>	algal phosphorus-to-carbon ratio	gm P gm <sup>-1</sup> C
<i>ASC<sub>d</sub></i>	silica-to-carbon ratio of diatoms	gm Si gm <sup>-1</sup> C
<i>BENTAM</i>	anoxic total active metal release rate	mol m <sup>-2</sup> day <sup>-1</sup>
<i>BM<sub>rx</sub></i>	basal metabolic rate of algal group x at reference temperature Tr	day <sup>-1</sup>
<i>BM<sub>x</sub></i>	basal metabolic rate of algal group x	day <sup>-1</sup>
<i>BPR<sub>x</sub></i>	predation rate on algal group x at reference temperature Tr	day <sup>-1</sup>
<i>B<sub>x</sub></i>	biomass of algal group x	gm C m <sup>-3</sup>
<i>c</i>	cyanobacteria	gm C m <sup>-3</sup>
<i>CCh<sub>lx</sub></i>	carbon-to-chlorophyll ratio of algal group x	gm C mg <sup>-1</sup> chl
<i>CL</i>	chloride concentration	ppt
<i>COD</i>	concentration of chemical oxygen demand	gm m <sup>-3</sup>
<i>C<sub>p</sub></i>	specific heat of water	watt sec kg <sup>-1</sup> C <sup>0-1</sup>
<i>d</i>	diatoms	gm C m <sup>-3</sup>
<i>Denit</i>	denitrification rate of dissolved organic carbon	day <sup>-1</sup>
<i>DO</i>	dissolved oxygen	gm O <sub>2</sub> m <sup>-3</sup>
<i>DOC</i>	dissolved organic carbon	gm C m <sup>-3</sup>
<i>DON</i>	dissolved organic nitrogen	gm N m <sup>-3</sup>
<i>DOP</i>	dissolved organic phosphorus	gm P m <sup>-3</sup>
<i>Dopt<sub>x</sub></i>	depth of maximum production of algal group x	m
<i>DO<sub>s</sub></i>	saturation dissolved oxygen concentration	gm O <sub>2</sub> m <sup>-3</sup>
<i>FCD<sub>x</sub></i>	fraction of basal metabolism exuded as dissolved organic carbon by algal group x	0 ≤ FCD <sub>x</sub> ≤ 1
<i>FCDP</i>	fraction of dissolved organic carbon produced by predation	0 ≤ FCDP ≤ 1

(Sheet 1 of 7)

Table 3-2 (Continued)		
Symbol	Definition	Units
<i>FCLP</i>	fraction of labile particulate carbon produced by predation	$0 \leq FCLP \leq 1$
<i>FCRP</i>	fraction of refractory particulate carbon produced by predation	$0 \leq FCRP \leq 1$
<i>FD</i>	daylight fraction of total daylength	$0 \leq FD \leq 1$
<i>f(I)</i>	effect of suboptimal illumination on algal production	$0 \leq f(I) \leq 1$
<i>f(N)</i>	effect of suboptimal nutrient concentration on algal production	$0 \leq f(N) \leq 1$
<i>FNlx</i>	fraction of inorganic nitrogen produced by metabolism of algal group x	$0 \leq FNlx \leq 1$
<i>FNIP</i>	fraction of inorganic nitrogen produced by predation	$0 \leq FNIP \leq 1$
<i>FNDx</i>	fraction of dissolved organic nitrogen produced by metabolism of algal group x	$0 \leq FNDx \leq 1$
<i>FNDP</i>	fraction of dissolved organic nitrogen produced by predation	$0 \leq FNDP \leq 1$
<i>FNLx</i>	fraction of labile particulate nitrogen produced by metabolism of algal group x	$0 \leq FNLx \leq 1$
<i>FNLP</i>	fraction of labile particulate nitrogen produced by predation	$0 \leq FNLP \leq 1$
<i>FNRx</i>	fraction of refractory particulate nitrogen produced by metabolism of algal group x	$0 \leq FNRx \leq 1$
<i>FNRP</i>	fraction of refractory particulate nitrogen produced by predation	$0 \leq FNRP \leq 1$
<i>FPDx</i>	fraction of dissolved organic phosphorus produced by metabolism by algal group x	$0 \leq FPDx \leq 1$
<i>FPDP</i>	fraction of dissolved organic phosphorus produced by predation	$0 \leq FPDP \leq 1$
<i>FPLx</i>	fraction of labile particulate phosphorus produced by metabolism of algal group x	$0 \leq FPLx \leq 1$
<i>FPLP</i>	fraction of labile particulate phosphorus produced by predation	$0 \leq FPLP \leq 1$
<i>FPRx</i>	fraction of refractory particulate phosphorus produced by metabolism of algal group x	$0 \leq FPRx \leq 1$
<i>FPRP</i>	fraction of refractory particulate phosphorus produced by predation	$0 \leq FPRP \leq 1$
<i>f(S)</i>	effect of salinity on cyanobacteria production	$0 \leq f(S) \leq 1$
<i>FSAP</i>	fraction of diatom silica made available by predation	$0 \leq FSAP \leq 1$

(Sheet 2 of 7)

Table 3-2 (Continued)		
Symbol	Definition	Units
$f(T)$	effect of suboptimal temperature on algal production	$0 \leq f(T) \leq 1$
$g$	green algae	$\text{gm C m}^{-3}$
$I$	illumination rate	$\text{Langleys day}^{-1}$
$I_0$	daily illumination at water surface	$\text{Langleys day}^{-1}$
$I_{avg}$	time-weighted average of daily illumination	$\text{Langleys day}^{-1}$
$I_s$	optimal illumination	$\text{Langleys day}^{-1}$
$I_{smin}$	minimum illumination for algal growth	$\text{Langleys day}^{-1}$
$I_1$	daily illumination one day preceding model day	$\text{Langleys day}^{-1}$
$I_2$	daily illumination two days preceding model day	$\text{Langleys day}^{-1}$
$K_{dpo4}$	partition coefficient of sorbed vs. dissolved phosphate	$\text{m}^3 \text{mol}^{-1}$
$K_{dsa}$	partition coefficient of sorbed vs. dissolved available silica	$\text{m}^3 \text{mol}^{-1}$
$K_{cod}$	oxidation rate of chemical oxygen demand	$\text{day}^{-1}$
$K_{dc}$	minimum respiration rate of dissolved organic carbon	$\text{day}^{-1}$
$K_{dcalg}$	constant that relates respiration rate to algal biomass	$\text{m}^3 \text{gm}^{-1} \text{C day}^{-1}$
$K_{dn}$	minimum mineralization rate of dissolved organic nitrogen	$\text{day}^{-1}$
$K_{dnalg}$	constant that relates mineralization rate to algal biomass	$\text{m}^3 \text{gm}^{-1} \text{C day}^{-1}$
$K_{doc}$	dissolved organic carbon respiration rate	$\text{day}^{-1}$
$K_{don}$	dissolved organic nitrogen mineralization rate	$\text{day}^{-1}$
$K_{dop}$	dissolved organic phosphorus mineralization rate	$\text{day}^{-1}$
$K_{dotam}$	constant that relates total active metal solubility to dissolved oxygen concentration	$\text{m}^3 \text{gm}^{-1} \text{O}_2$
$K_{dp}$	minimum mineralization rate of dissolved organic phosphorus	$\text{day}^{-1}$
$K_{dpalg}$	constant that relates mineralization rate to algal biomass	$\text{m}^3 \text{gm}^{-1} \text{C day}^{-1}$
$K_{eb}$	background light attenuation	$\text{m}^{-1}$
$K_{echl}$	light attenuation coefficient for chlorophyll 'a'	$\text{m}^2 \text{mg}^{-1}$
$K_{ess}$	total light attenuation	$\text{m}^{-1}$

(Sheet 3 of 7)

<b>Table 3-2 (Continued)</b>		
<b>Symbol</b>	<b>Definition</b>	<b>Units</b>
<i>KH<sub>bmf</sub></i>	dissolved oxygen concentration at which total active metal release is half the anoxic rate	gm O <sub>2</sub> m <sup>-3</sup>
<i>KH<sub>n</sub></i>	mean half-saturation concentration for nitrogen uptake by all algal groups	gm N m <sup>-3</sup>
<i>KH<sub>nx</sub></i>	half-saturation concentration for nitrogen uptake by algal group x	gm N m <sup>-3</sup>
<i>KH<sub>ndn</sub></i>	half-saturation concentration of nitrate required for denitrification	gm N m <sup>-3</sup>
<i>KH<sub>mnt</sub></i>	half-saturation concentration of NH <sub>4</sub> required for nitrification	gm N m <sup>-3</sup>
<i>KH<sub>ocod</sub></i>	half-saturation concentration of dissolved oxygen required for exertion of COD	gm O <sub>2</sub> m <sup>-3</sup>
<i>KH<sub>odoc</sub></i>	half-saturation concentration of dissolved oxygen required for oxidic respiration	gm O <sub>2</sub> m <sup>-3</sup>
<i>KH<sub>ont</sub></i>	half-saturation concentration of dissolved oxygen required for nitrification	gm O <sub>2</sub> m <sup>-3</sup>
<i>KH<sub>p</sub></i>	mean half-saturation concentration for phosphorus uptake by all algal groups	gm P m <sup>-3</sup>
<i>KH<sub>px</sub></i>	half-saturation concentration for phosphorus uptake by algal group x	gm P m <sup>-3</sup>
<i>KH<sub>rx</sub></i>	half-saturation concentration for dissolved organic carbon excretion by algal group x	gm O <sub>2</sub> m <sup>-3</sup>
<i>KH<sub>s</sub></i>	half-saturation concentration for silica uptake by diatoms	gm Si m <sup>-3</sup>
<i>K<sub>lc</sub></i>	minimum dissolution rate of labile particulate carbon	day <sup>-1</sup>
<i>K<sub>lcalg</sub></i>	constant that relates dissolution rate to algal biomass	m <sup>3</sup> gm <sup>-1</sup> C day <sup>-1</sup>
<i>K<sub>ln</sub></i>	minimum dissolution rate of labile particulate nitrogen	day <sup>-1</sup>
<i>K<sub>lnalg</sub></i>	constant that relates dissolution rate to algal biomass	m <sup>3</sup> gm <sup>-1</sup> C day <sup>-1</sup>
<i>K<sub>lp</sub></i>	minimum dissolution rate of labile particulate phosphorus	day <sup>-1</sup>
<i>K<sub>lpalg</sub></i>	constant that relates dissolution rate to algal biomass	m <sup>3</sup> gm <sup>-1</sup> C day <sup>-1</sup>
<i>K<sub>lpoc</sub></i>	labile particulate organic carbon dissolution rate	day <sup>-1</sup>
<i>K<sub>lpon</sub></i>	labile particulate organic nitrogen hydrolysis rate	day <sup>-1</sup>
<i>K<sub>lpop</sub></i>	labile particulate organic phosphorus hydrolysis rate	day <sup>-1</sup>

(Sheet 4 of 7)

Table 3-2 (Continued)		
Symbol	Definition	Units
<i>K<sub>r</sub></i>	reaeration coefficient	m day <sup>-1</sup>
<i>K<sub>rc</sub></i>	minimum dissolution rate of refractory particulate carbon	day <sup>-1</sup>
<i>K<sub>rca</sub>g</i>	constant that relates dissolution rate to algal biomass	m <sup>3</sup> gm <sup>-1</sup> C day <sup>-1</sup>
<i>K<sub>rn</sub></i>	minimum dissolution rate of refractory particulate nitrogen	day <sup>-1</sup>
<i>K<sub>rna</sub>g</i>	constant that relates dissolution rate to algal biomass	m <sup>3</sup> gm <sup>-1</sup> C day <sup>-1</sup>
<i>K<sub>rp</sub></i>	minimum dissolution rate of refractory particulate phosphorus	day <sup>-1</sup>
<i>K<sub>rpa</sub>g</i>	constant that relates dissolution rate to algal biomass	m <sup>3</sup> gm <sup>-1</sup> C day <sup>-1</sup>
<i>K<sub>rpo</sub>c</i>	refractory particulate organic carbon dissolution rate	day <sup>-1</sup>
<i>K<sub>rpo</sub>n</i>	refractory particulate organic nitrogen hydrolysis rate	day <sup>-1</sup>
<i>K<sub>rpo</sub>p</i>	refractory particulate organic phosphorus hydrolysis rate	day <sup>-1</sup>
<i>K<sub>sua</sub></i>	particulate biogenic silica dissolution rate	day <sup>-1</sup>
<i>KT</i>	surface heat exchange coefficient	watt m <sup>-2</sup> C <sup>0.1</sup>
<i>KT<sub>bx</sub></i>	effect of temperature on basal metabolism of algal group x	C <sup>0.1</sup>
<i>KT<sub>gx1</sub></i>	effect of temperature below <i>T<sub>mx</sub></i> on growth of algal group x	C <sup>0.2</sup>
<i>KT<sub>gx2</sub></i>	effect of temperature above <i>T<sub>mx</sub></i> on growth of algal group x	C <sup>0.2</sup>
<i>K<sub>Thdr</sub></i>	constant that relates hydrolysis rates to temperature	C <sup>0.1</sup>
<i>K<sub>Tmnl</sub></i>	constant that relates mineralization rates to temperature	C <sup>0.1</sup>
<i>KT<sub>nt1</sub></i>	effect of temperature below <i>T<sub>mnt</sub></i> on nitrification	C <sup>0.2</sup>
<i>KT<sub>nt2</sub></i>	effect of temperature above <i>T<sub>mnt</sub></i> on nitrification	C <sup>0.2</sup>
<i>LPOC</i>	labile particulate organic carbon	gm C m <sup>-3</sup>
<i>LPON</i>	labile particulate organic nitrogen	gm N m <sup>-3</sup>
<i>LPOP</i>	labile particulate organic phosphorus	gm P m <sup>-3</sup>
<i>NH<sub>4</sub></i>	ammonium concentration	gm N m <sup>-3</sup>
<i>NO<sub>3</sub></i>	nitrate + nitrite concentration	gm N m <sup>-3</sup>

(Sheet 5 of 7)

Table 3-2 (Continued)		
Symbol	Definition	Units
<i>NT</i>	nitrification rate	gm N m <sup>-3</sup> day <sup>-1</sup>
<i>NTm</i>	maximum nitrification rate at optimal temperature	gm N m <sup>-3</sup> day <sup>-1</sup>
<i>PCprm1</i>	minimum algal carbon-to-phosphorus ratio	gm C gm <sup>-1</sup> P
<i>PCprm2</i>	difference between minimum and maximum algal carbon-to-phosphorus ratio	gm C gm <sup>-1</sup> P
<i>PCprm3</i>	effect of dissolved phosphate concentration on algal carbon-to-phosphorus ratio	m <sup>3</sup> gm <sup>-1</sup> P
<i>PMx</i>	production rate of algal group x under optimal conditions	day <sup>-1</sup>
<i>PNx</i>	preference for ammonium uptake by algal group x	$0 \leq PN \leq 1$
<i>PO<sub>4a</sub></i>	phosphate in algal biomass	gm P m <sup>-3</sup>
<i>PO<sub>4d</sub></i>	dissolved phosphate concentration	gm P m <sup>-3</sup>
<i>PO<sub>4p</sub></i>	particulate (sorbed) phosphate concentration	gm P m <sup>-3</sup>
<i>PO<sub>4t</sub></i>	total phosphate concentration	gm P m <sup>-3</sup>
<i>Prdval</i>	piecewise function used to specify seasonal diatom settling velocity	$0 \leq Prdval \leq 1$
<i>PRx</i>	rate of predation on algal group x	day <sup>-1</sup>
<i>Px</i>	production rate of algal group x	day <sup>-1</sup>
<i>RPOC</i>	refractory particulate organic carbon	gm C m <sup>-3</sup>
<i>RPON</i>	refractory particulate organic nitrogen	gm N m <sup>-3</sup>
<i>RPOP</i>	refractory particulate organic phosphorus	gm P m <sup>-3</sup>
<i>S</i>	salinity	ppt
<i>SA</i>	available silica concentration	gm Si m <sup>-3</sup>
<i>SAd</i>	dissolved available silica concentration	gm Si m <sup>-3</sup>
<i>SAp</i>	sorbed (particulate) available silica concentration	gm Si m <sup>-3</sup>
<i>Stox</i>	salinity at which <i>Microcystis</i> growth is halved	ppt
<i>SU</i>	particulate biogenic silica concentration	gm Si m <sup>-3</sup>
<i>T</i>	temperature	C <sup>0</sup>
<i>TAM</i>	total active metal concentration	mol m <sup>-3</sup>
<i>TAMd</i>	dissolved total active metal concentration	mol m <sup>-3</sup>
<i>TAMdmx</i>	solubility of total active metal under anoxic conditions	mol m <sup>-3</sup>
<i>TAMp</i>	particulate total active metal concentration	mol m <sup>-3</sup>
<i>Te</i>	equilibrium temperature	C <sup>0</sup>

(Sheet 6 of 7)



<b>Table 3-2 (Concluded)</b>		
<b>Symbol</b>	<b>Definition</b>	<b>Units</b>
<i>T<sub>mx</sub></i>	optimal temperature for growth of algal group x	25 C <sup>0</sup>
<i>T<sub>mnt</sub></i>	optimal temperature for nitrification	30 C <sup>0</sup>
<i>T<sub>r</sub></i>	reference temperature for metabolism	20 C <sup>0</sup>
<i>T<sub>rhdr</sub></i>	reference temperature for hydrolysis	20 C <sup>0</sup>
<i>T<sub>rmnl</sub></i>	reference temperature for mineralization	20 C <sup>0</sup>
<i>WS<sub>d</sub></i>	diatom settling rate	m day <sup>-1</sup>
<i>WS<sub>db</sub></i>	base diatom settling rate	m day <sup>-1</sup>
<i>WD<sub>ds</sub></i>	enhanced settling velocity of large diatoms	m day <sup>-1</sup>
<i>WS<sub>l</sub></i>	settling velocity of labile particles	m day <sup>-1</sup>
<i>WS<sub>r</sub></i>	settling velocity of refractory particles	m day <sup>-1</sup>
<i>WS<sub>s</sub></i>	settling velocity of suspended solids	m day <sup>-1</sup>
<i>WS<sub>x</sub></i>	settling velocity of algal group x	m day <sup>-1</sup>
<i>z</i>	vertical coordinate	m
<i>ZD</i>	distance from water surface to top of model segment	m
$\Delta z$	model segment thickness	m
$\rho$	density of water	kg m <sup>-3</sup>
<i>(Sheet 7 of 7)</i>		

# 4 Sediment-Water Interactions

---

Exchange of material between the water column and benthic sediments is an important component of the eutrophication process. Sediment oxygen demand may comprise a substantial fraction of total system oxygen consumption. Over lengthy time scales (e.g. years to decades), the sediments are an ultimate sink of nutrients and other substances discharged to the water column. Over lesser time scales (e.g. seasons to years), however, sediment release of previously deposited nutrients can be a net source to the water column.

Within the model, transfer of particulate matter from water to sediments is treated through specification of a settling velocity. Two options are available for determination of sediment oxygen consumption and sediment nutrient releases. The first option employs user-specified fluxes. Basic relationships are provided that express the influence of conditions in the water column on the specified fluxes. The second option is employment of a fully predictive sediment submodel that computes fluxes based on deposition of organic particles and other factors.

Excellent calibration of the water quality model can be achieved with employment of user-specified fluxes. This option provides limited insight into sediment response to alterations in loading and other factors, however. Employment of the sediment submodel provides rational predictions of sediment response to environmental alterations. Employment of the submodel vastly increases information requirements and computation time compared to employment of user-specified fluxes.

## User-Specified Fluxes

The model employs the convention that positive fluxes are from sediment to water and negative fluxes are from water to sediment. Fluxes of dissolved organic matter, ammonium, phosphate, and chemical oxygen demand are most often from sediments to water and are positive quantities. Nitrate commonly passes in both directions across the sediment-water interface and may be

positive or negative. Since oxygen moves from water to sediments, sediment oxygen consumption is represented as a negative quantity.

### Dissolved organic carbon, ammonium, phosphate

The model accounts for effects of temperature (Figure 4-1) on user-specified sediment-water fluxes of dissolved organic carbon, ammonium, and phosphate. The relationship is:

$$BEN_x = BEN_{x_b} e^{KS_x(T - TRS_x)} \quad (4-1)$$

$BEN_x$  = benthic flux of substance x at temperature T ( $gm\ m^{-2}\ day^{-1}$ )

$BEN_{x_b}$  = benthic flux of substance x specified at temperature  $TRS_x$  ( $gm\ m^{-2}\ day^{-1}$ )

$KS_x$  = effect of temperature on flux of substance x ( $C^{\circ\ -1}$ )

$TRS_x$  = reference temperature for specification of benthic flux ( $C^{\circ}$ )

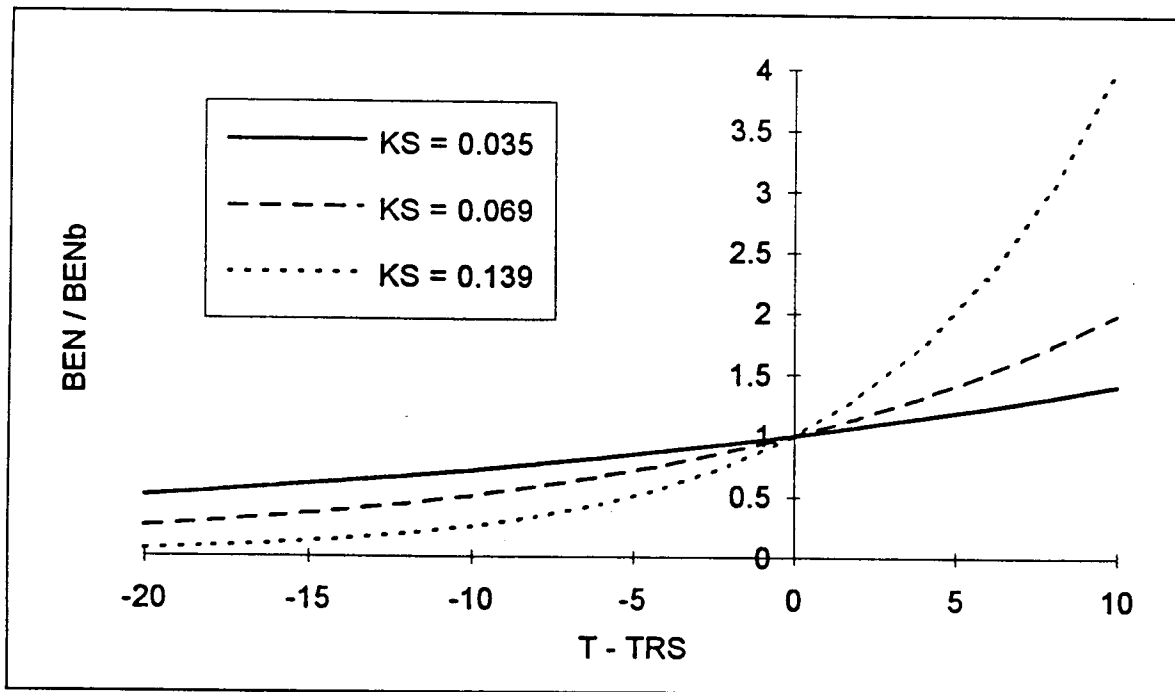

Figure 4-1. Effect of temperature on specified fluxes

### Nitrate

Movement of nitrate between water and sediments is strongly influenced by concentration of nitrate in the water column. When nitrate is abundant in the

water column, nitrate usually diffuses from overlying water into the sediments where it is denitrified to gaseous form. When nitrate is absent from the water column, small quantities of nitrate may diffuse from sediment interstitial water into the overlying water. The model allows for user-specified nitrate flux and provides a function (Figure 4-2) that relates flux to concentration:

$$BENNO_3 = BENNO_{3b} + MTCNO_3 (SEDNO_3 - NO_3) e^{KSno_3(T - TRSno_3)} \quad (4-2)$$

$BENNO_3$  = sediment-water nitrate flux ( $gm\ N\ m^{-2}\ day^{-1}$ )

$BENNO_{3b}$  = specified sediment-water nitrate flux ( $gm\ N\ m^{-2}\ day^{-1}$ )

$MTCNO_3$  = sediment-water mass transfer coefficient ( $m\ day^{-1}$ )

$SEDNO_3$  = nitrate concentration in interstitial water ( $gm\ m^{-3}$ )

$NO_3$  = nitrate concentration in water overlying sediments ( $gm\ m^{-3}$ )

$KSno_3$  = effect of temperature on denitrification rate ( $C^{\circ -1}$ )

$TRSno_3$  = reference temperature for specification of denitrification rate ( $C^{\circ}$ )

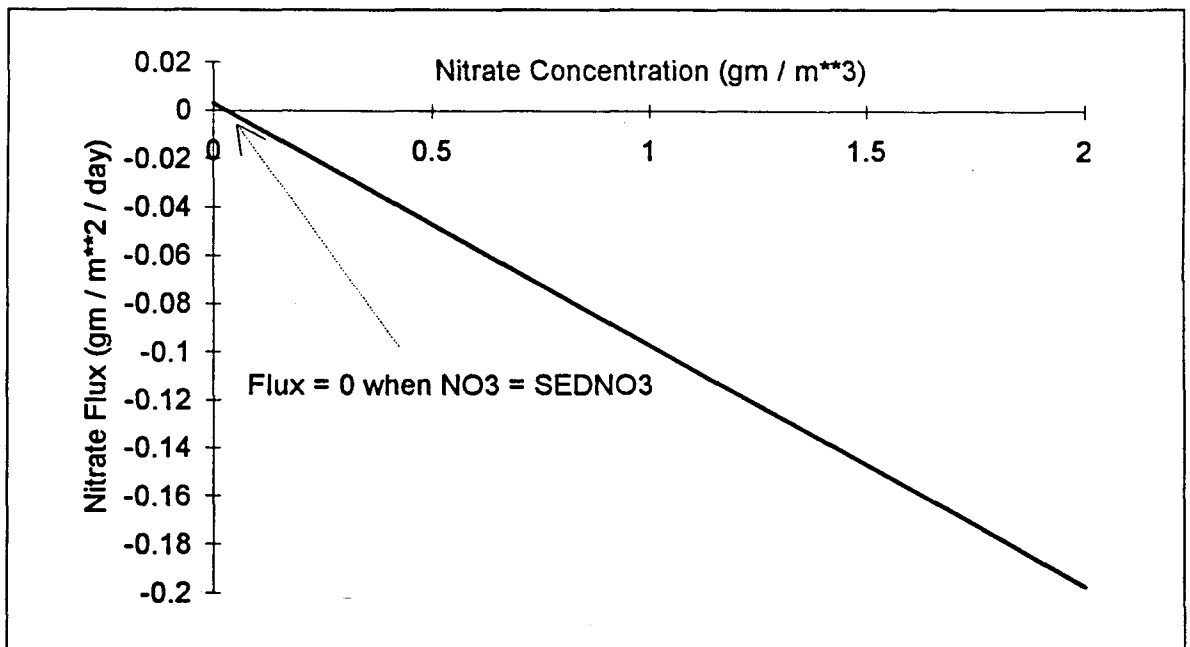

Figure 4-2. Effect of nitrate concentration on sediment-water nitrate flux

In typical model employment, the user specifies the nitrate flux, if known, or relies on the model to compute flux as a function of nitrate in the water column.

## Sediment oxygen consumption

Oxygen consumption in the sediments depends upon water-column temperature and oxygen availability. As temperature increases, respiration in the sediment increases. Sediment oxygen consumption is reduced as oxygen concentration in the overlying water decreases. The model accounts for these influences through the relationship:

$$BENDO = \frac{DO}{KH_{so} + DO} BENDOb e^{KSo(T - TRSo)} \quad (4-3)$$

$BENDO$  = sediment oxygen consumption ( $\text{gm m}^{-2} \text{day}^{-1}$ )

$KH_{so}$  = dissolved oxygen concentration at which sediment oxygen consumption is halved ( $\text{gm m}^{-3}$ )

$BENDOb$  = sediment oxygen consumption under conditions of unlimited oxygen availability, specified at temperature  $TRSo$  ( $\text{gm m}^{-2} \text{day}^{-1}$ )

$KSo$  = effect of temperature on sediment oxygen consumption ( $\text{C}^{\circ -1}$ )

$TRSo$  = reference temperature for specification of sediment oxygen consumption ( $\text{C}^{\circ}$ )

## Chemical oxygen demand

The processes that create sediment oxygen demand are little affected by the concentration of oxygen in the overlying water. When oxygen is unavailable to fulfill sediment oxygen demand, the demand is exported to the water column. The exported demand may be in the form of reduced iron, manganese, or sulfide, which are represented in the model as chemical oxygen demand. The model allows for user-specified sediment release of chemical oxygen demand and provides a function which computes additional release as oxygen consumption in the sediments is restrained:

$$BENCOD = BENCOD_b - \frac{KH_{so}}{KH_{so} + DO} BENDOb e^{KSo(T - TRSo)} \quad (4-4)$$

$BENCOD$  = sediment flux of chemical oxygen demand ( $\text{gm m}^{-2} \text{day}^{-1}$ )

$BENCOD_b$  = specified sediment-water flux of chemical oxygen demand ( $\text{gm m}^{-2} \text{day}^{-1}$ )

In typical model employment, the user specifies the flux of chemical oxygen demand, if known, or relies on the model to compute flux as a function of sediment oxygen consumption and dissolved oxygen in the water column. The computed flux is negligible when  $DO \gg KH_{so}$  (Figure 4-3). When dissolved oxygen is absent from the water column, oxygen demand equivalent to maximum specified sediment consumption is released to the water as chemical oxygen demand.

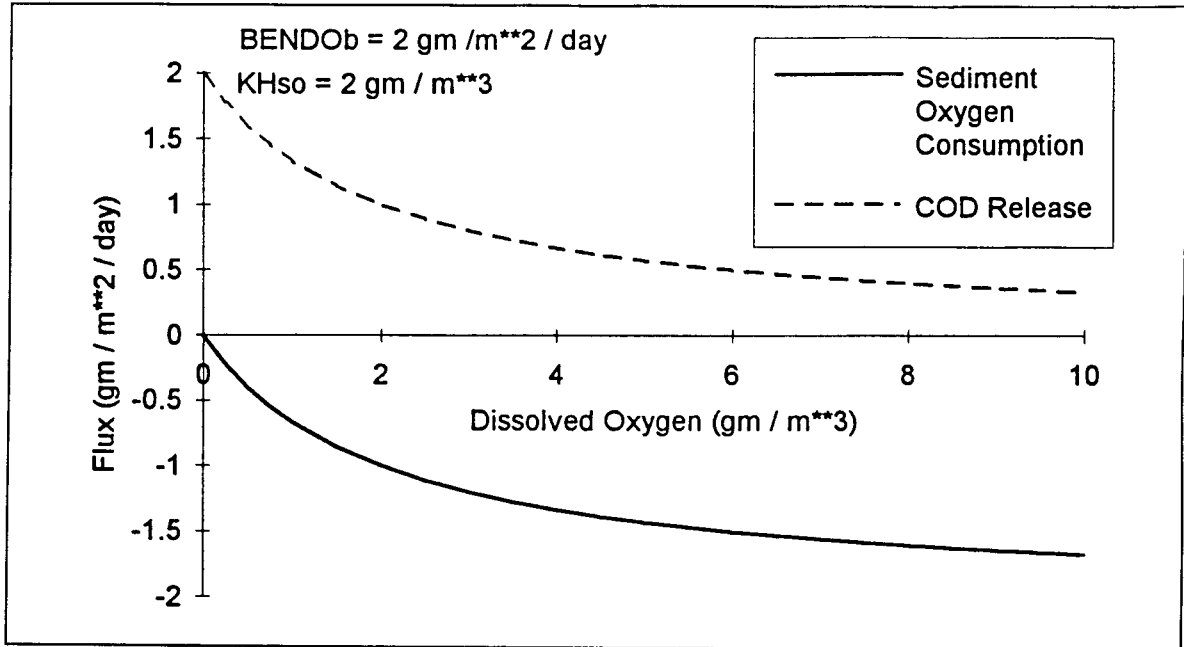

Figure 4-3. Effect of dissolved oxygen on sediment oxygen consumption and COD release

### Dissolved organic nitrogen and phosphorus

The model allows for user-specified fluxes of dissolved organic nitrogen and dissolved organic phosphorus. Sediment release of these substances is small and erratic. The model provides no functions which modify the user-specified basic fluxes.

### Predictive sediment submodel

The predictive sediment submodel was developed as one component of the Chesapeake Bay eutrophication model study (Cercio and Cole 1994). The need for a predictive benthic sediment model was made apparent by the results of a preceding steady-state model study of the bay (HydroQual 1987). The study indicated sediments were the dominant source of phosphorus and ammonium during the summer period of minimum dissolved oxygen. Increases in sediment oxygen demand and nutrient releases were implicated in a perceived dissolved oxygen decline from 1965 to 1985. No means existed to predict how these sediment processes would respond to nutrient load reductions,

however. Neither was the time scale for completion of the responses predictable.

For management purposes, a sediment model was required with two fundamental capabilities:

Predict effects of management actions on sediment-water exchange processes, and

Predict time scale for alterations in sediment-water exchange processes.

The model (Figure 4-4) was driven by net settling of organic matter from the water column to the sediments. In the sediments, the model simulated the diagenesis (decay) of the organic matter. Diagenesis produced oxygen demand and inorganic nutrients. Oxygen demand, as sulfide (in saltwater) or methane (in freshwater), took three paths out of the sediments: export to the water column as chemical oxygen demand, oxidation at the sediment-water interface as sediment oxygen demand, or burial to deep, inactive sediments. Inorganic nutrients produced by diagenesis took two paths out of the sediments: release to the water column, or burial to deep, inactive sediments.

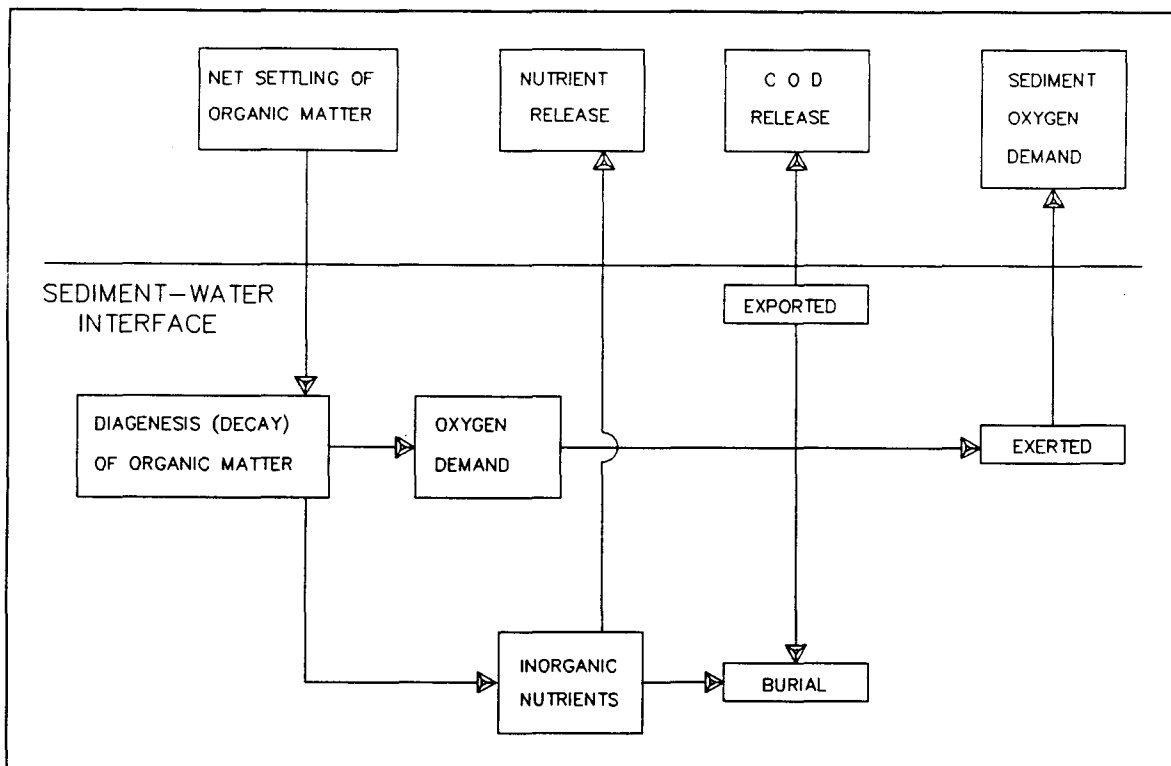

Figure 4-4. Sediment model schematic

Additional details of the model, required to understand the coupling of the sediment submodel to the model of the water column, are provided below. Complete model documentation is provided by DiToro and Fitzpatrick (1993).

A listing of sediment model state variables and predicted sediment-water fluxes is provided in Table 4-1.

<b>Table 4-1 Sediment Model State Variables and Fluxes</b>	
<b>State Variable</b>	<b>Sediment-Water Flux</b>
Temperature	
Particulate Organic Carbon	Sediment Oxygen Demand
Sulfide/Methane	Release of Chemical Oxygen Demand
Particulate Organic Nitrogen	
Ammonium	Ammonium Flux
Nitrate	Nitrate Flux
Particulate Organic Phosphorus	
Phosphate	Phosphate Flux
Particulate Biogenic Silica	
Available Silica	Silica Flux

### **Description of sediment model**

Benthic sediments are represented as two layers with a total depth of 10 cm (Figure 4-5). The upper layer, in contact with the water column, may be oxic or anoxic depending on dissolved oxygen concentration in the water. The lower layer is permanently anoxic. The thickness of the upper layer is determined by the penetration of oxygen into the sediments. At its maximum thickness, the oxic layer depth is only a small fraction of the total.

The sediment model consists of three basic processes. The first is deposition of particulate organic matter from the water column to the sediments. Due to the negligible thickness of the upper layer, deposition proceeds from the water column directly to the lower, anoxic layer. Within the lower layer, organic matter is subject to the second basic process, diagenesis (or decay). The third basic process is flux of substances produced by diagenesis to the upper sediment layer, to the water column, and to deep, inactive sediments. The flux portion of the model is the most complex. Computation of flux requires consideration of reactions in both sediment layers, of partitioning between particulate and dissolved fractions in both layers, of sedimentation from the upper to lower layer and from the lower layer to deep inactive sediments, of particle mixing between layers, of diffusion between layers, and of mass transfer between the upper layer and the water column.



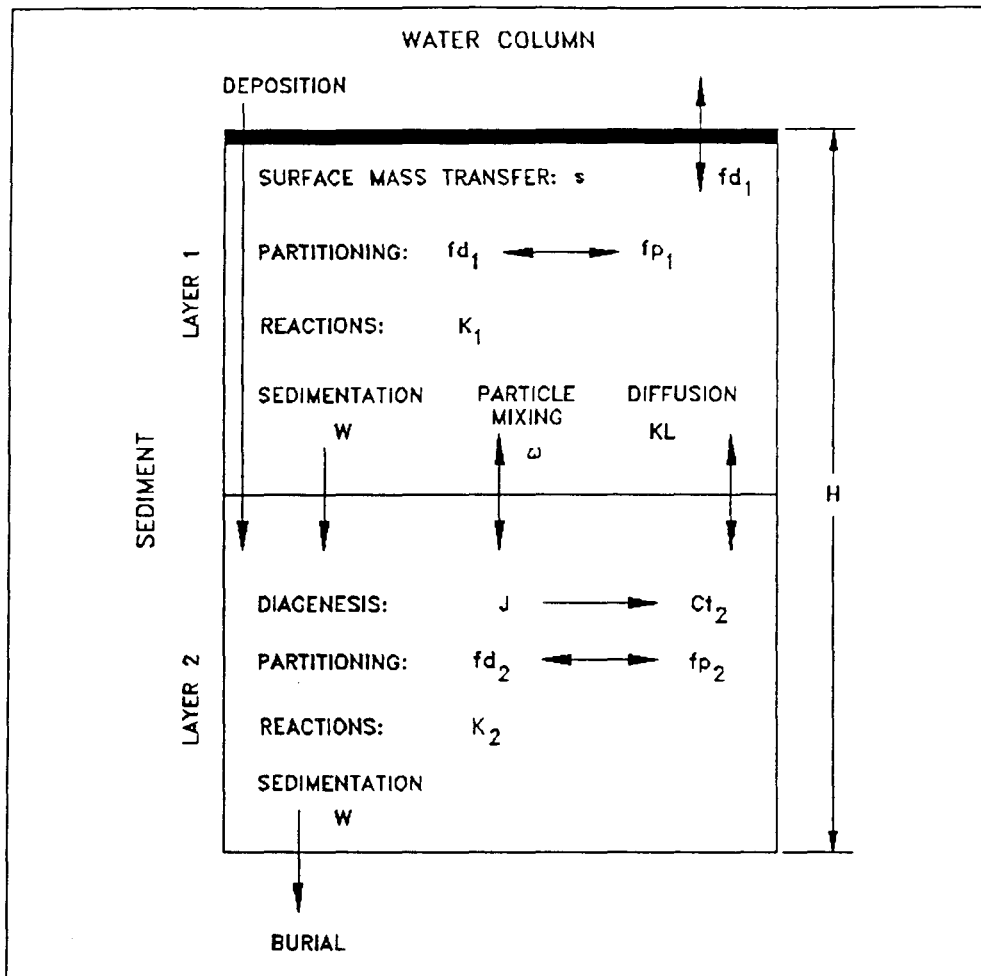

Figure 4-5. Sediment model layers and definitions

### Deposition

Deposition is one process which couples the model of the water column with the model of the sediments. Consequently, deposition is represented in both the sediment and water-column models. In the water column, deposition is represented with a modification of the mass-balance equation applied only to cells that interface the sediments:

$$\frac{\delta C}{\delta t} = [\text{transport}] + [\text{kinetics}] + \frac{WS}{\Delta z} C_{up} - \frac{W_{net}}{\Delta z} C \quad (4-5)$$

$C$  = concentration of particulate constituent ( $\text{gm m}^{-3}$ )

$WS$  = settling velocity in water column ( $\text{m day}^{-1}$ )

$\Delta z$  = cell thickness (m)

$C_{up}$  = constituent concentration two cells above sediments ( $\text{gm m}^{-3}$ )

$W_{net}$  = net settling to sediments ( $\text{m day}^{-1}$ )

Net settling to the sediments may be greater or lesser than settling in the water column. Sediment resuspension is implied when settling to the sediments is less than settling through the water column. Net settling that exceeds particle settling velocity implies active incorporation of particles into sediment by biota or other processes.

## Diagenesis

Organic matter in the sediments is divided into three G classes or fractions, in accordance with principles established by Westrich and Berner (1984). Division into G classes accounts for differential decay rates of organic matter fractions. The G1, labile, fraction has a half life of 20 days. The G2, refractory, fraction has a half life of one year. The G3, inert, fraction undergoes no significant decay before burial into deep, inactive sediments. Each G class has its own mass-conservation equation:

$$H \frac{\delta G_i}{\delta t} = W_{net} f_i C - W G_i - H K_i G_i \theta_i^{(T-20)} \quad (4-6)$$

$H$  = total thickness of sediment layer (m)

$G_i$  = concentration organic matter in G class i ( $\text{gm m}^{-3}$ )

$f_i$  = fraction of deposited organic matter assigned to G class i

$W$  = burial rate ( $\text{m day}^{-1}$ )

$K_i$  = decay rate of G class i ( $\text{day}^{-1}$ )

$\theta_i$  = constant that expresses effect of temperature on decay of G class i

Since the G3 class is inert,  $K_3 = 0$ .

Total diagenesis is the rate at which oxygen demand and nutrients are produced by diagenesis of the G1 and G2 fractions:

$$J = H \left[ K_1 G_1 \theta_1^{(T-20)} + K_2 G_2 \theta_2^{(T-20)} \right] \quad (4-7)$$

where  $J$  is the total diagenesis ( $\text{gm m}^{-2} \text{day}^{-1}$ ).

## Flux

Total diagenesis provides the driving force for the flux portion of the model. Computation of flux requires mass-balance equations for oxygen demand and nutrients in both sediment layers. The upper layer is thin such that a steady-state approximation is appropriate:

$$sfd_1 C_{t_1} = \omega (fp_2 C_{t_2} - fp_1 C_{t_1}) + KL (fd_2 C_{t_2} - fd_1 C_{t_1}) - W C_{t_1} \pm \sum K_1 \quad (4-8)$$

$s$  = sediment-water mass-transfer coefficient (m day<sup>-1</sup>)

$fd_1$  = dissolved fraction of total substance in upper layer ( $0 \leq fd \leq 1$ )

$C_{t_1}$  = total concentration in upper layer (gm m<sup>-3</sup>)

$\omega$  = particle mixing velocity (m day<sup>-1</sup>)

$fp_2$  = particulate fraction of total substance in lower layer

$C_{t_2}$  = total concentration in lower layer (gm m<sup>-3</sup>)

$fp_1$  = particulate fraction of total substance in upper layer  
= 1 -  $fd_1$

$KL$  = diffusion velocity for dissolved fraction (m day<sup>-1</sup>)

$fd_2$  = dissolved fraction of total substance in lower layer

$\sum K_1$  = sum of all sources and sinks due to reactions in upper layer  
(gm m<sup>-2</sup> day<sup>-1</sup>)

The left-hand side of Equation 4-8 represents flux to the water column under the assumption that dissolved concentration in the water column is negligibly small compared to the sediments. The assumption is made here for notational simplicity. Effects of concentration in the overlying water are computed in the sediment model code. The terms on the right-hand side are mass transport due to particle mixing, diffusion of dissolved substance, deposition to the lower layer, and reactive sources and sinks. The reactions include, for example, the oxidation of sulfide that results in sediment oxygen demand. The equation states that flux to the water column, deposition from surficial sediments, and reactive sources and sinks are balanced by mixing and diffusion from deeper sediments.

The mass balance equation for the lower layer accounts for temporal concentration variations:

$$\frac{\delta C_{t_2}}{\delta t} = \frac{J}{H} - \frac{\omega}{H} (fp_2 C_{t_2} - fp_1 C_{t_1}) - \frac{KL}{H} (fd_2 C_{t_2} - fd_1 C_{t_1}) + \frac{W}{H} (C_{t_1} - C_{t_2}) \pm \sum K_2 \quad (4-9)$$

$\sum K_2$  = sum of all sources and sinks due to reactions in upper layer  
(gm m<sup>-2</sup> day<sup>-1</sup>)

The first term on the right of Equation 4-9 represents the diagenetic source of oxygen demand or nutrient. The second term represents exchange of the particulate fraction with the upper layer. The third term represents exchange of the dissolved fraction with the upper layer. The fourth term represents deposition of total substance from the upper layer to the lower layer and burial from the lower layer to deep, inactive sediments. The last term is the sum of all internal sources and sinks due to reactions.

The mass balance equations, with appropriate sources and sinks, are solved within the sediment model for sulfide, methane, ammonium, nitrate, phosphate, and silica. Details of the reactions and solution scheme may be found in the model documentation (DiToro and Fitzpatrick 1993).

The water quality and sediment models interact on a time scale equal to the integration time step of the water quality model. After each integration, predicted particle deposition, temperature, nutrient and dissolved oxygen concentrations are passed from the water quality model to the sediment model. The sediment model computes sediment-water fluxes of dissolved nutrients and oxygen based on predicted diagenesis and concentrations in the sediments and water. The computed sediment-water fluxes are incorporated by the water quality model into appropriate mass balances and kinetic reactions.

# 5 Kinetics Parameter Evaluation

---

Model parameter evaluation is a recursive process. Parameters are selected from a range of feasible values, tested in the model, and adjusted until optimal agreement between predicted and observed variables is obtained. Ideally, the range of feasible values is determined by observation or experiment. For some parameters, however, no observations are available. Then, the feasible range is determined by parameter values employed in similar models or by the judgement of the modeler.

The most extensive application of CE-QUAL-ICM to date was the Chesapeake Bay eutrophication study (Cercio and Cole 1994). Scientific investigations and an EPA monitoring program provided an excellent data base for derivation of numerous model parameters. The present chapter reports parameter values determined during the Chesapeake Bay application. The processes employed to determine the values are detailed and comparable literature values are listed, when available.

## Algae

### Production

Maximum growth rates and their temperature dependence were based on observational summaries produced by Canale and Vogel (1974) supplemented with additional values provided by Collins and Wlosinski (1983). Reported growth rates were subject to in situ nutrient limitations. Since the maximum growth rates employed by the model were for nutrient-unlimited situations, parameter values (Table 5-1) were selected to provide an envelope around maximum reported rates (Figures 5-1 to 5-3) based on the assumption that maximum reported rates were independent of nutrient limitations. Employment of the maximum rates reported for the cyanobacteria group proved unsuited for the *microcystis* genus found in the upper Potomac, however. The temperature relationship employed for *microcystis* was less than the cyanobacteria maximum at temperatures greater than  $\approx 25$  °C.

Table 5-1 Algal Growth Rates and Temperature Parameters			
Group	Parameter	Value	Units
Cyanobacteria	PMc	2.5 (Upper Potomac only)	day <sup>-1</sup>
	Tmc	27.5	C°
	KTgc1	0.005	C° <sup>-2</sup>
	KTgc2	0.004	C° <sup>-2</sup>
	Stox	1.0	ppt
Diatoms	PMd	2.25	day <sup>-1</sup>
	Tmd	20.0	C°
	KTgd1	0.004	C° <sup>-2</sup>
	KTgd2	0.006	C° <sup>-2</sup>
Greens	PMg	2.50	day <sup>-1</sup>
	Tmg	25.0	C°
	KTgg1	0.008	C° <sup>-2</sup>
	KTgg2	0.010	C° <sup>-2</sup>

The model included a salinity toxicity factor (Equation 3-14) that limited *microcystis* growth. The toxicity factor (Table 5-1) was based on observations that the photosynthetic ability of Potomac River *microcystis* decreased rapidly at 1 to 2 ppt salinity (Sellner et al. 1988).

### Mortality

**Basal metabolism.** Metabolic rates were specified consistent with reported respiration rates (Table 5-2). Initial calibration efforts indicated diminished base rates were required to replicate the spring diatom bloom. Temperature effects were specified so that metabolism doubled for a 10 °C temperature increase.

**Predation.** Consider a phytoplankton system in which predation depends upon local zooplankton biomass. For simplicity, ignore settling and macrobenthic grazing. Then:

$$\frac{\delta}{\delta t} B = (P - R) B - GZ \quad (5-1)$$

$B$  = algal biomass as carbon (gm C m<sup>-3</sup>)

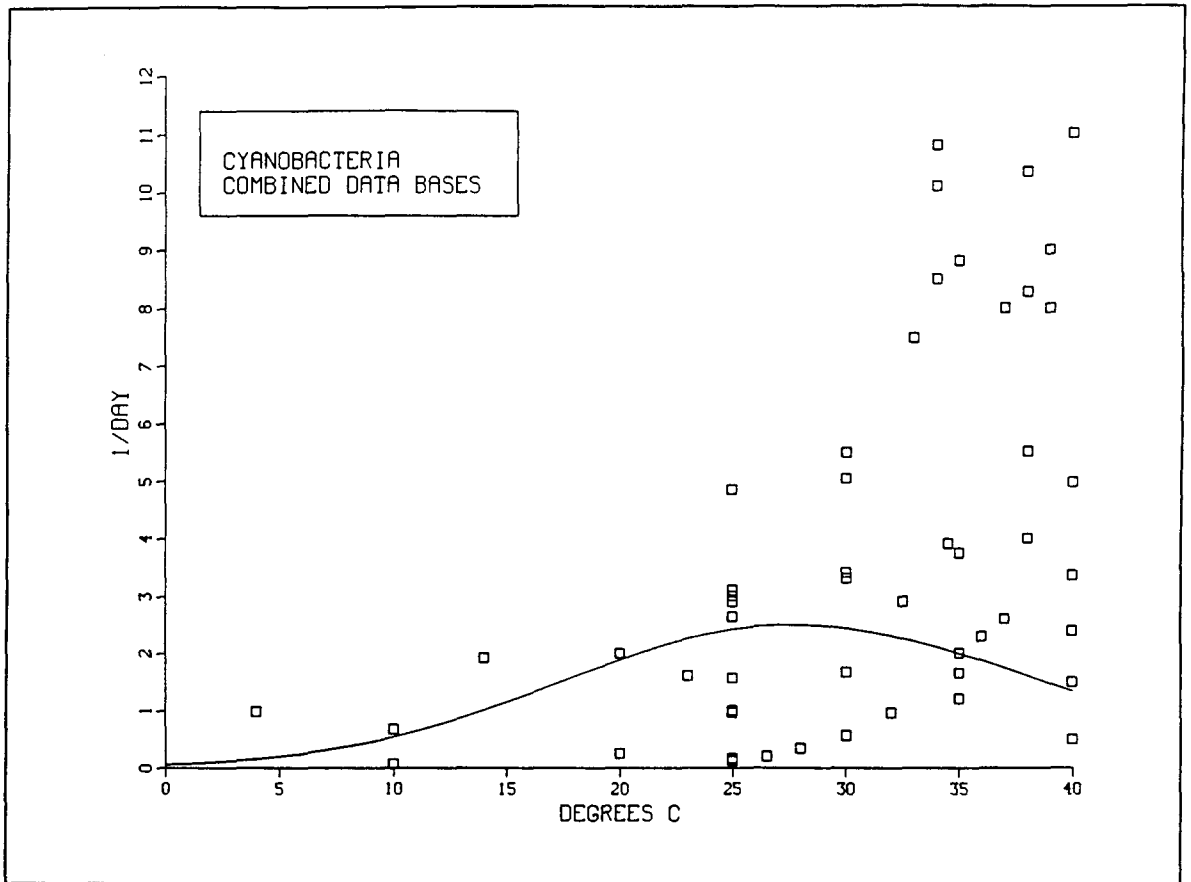

Figure 5-1. Reported and modeled growth rates for cyanobacteria

$P$  = production ( $\text{day}^{-1}$ )

$R$  = respiration ( $\text{day}^{-1}$ )

$G$  = ingestion rate ( $\text{gm algal C gm}^{-1}$  zooplankton C  $\text{day}^{-1}$ )

$Z$  = zooplankton biomass ( $\text{gm C m}^{-3}$ )

If zooplankton biomass is proportional to algal biomass,  $Z = \alpha B$ , Equation 5-1 can be rewritten:

$$\frac{\delta}{\delta t} B = (P - R - \alpha G) B \quad (5-2)$$

Equation 5-2 is analogous to the governing equation for algal biomass, Equation 3-1. The problem of specifying the predation rate,  $PRx$ , in Equation 3-1 becomes a problem of specifying parameters  $\alpha$  and  $G$  in Equation 5-2. Algal

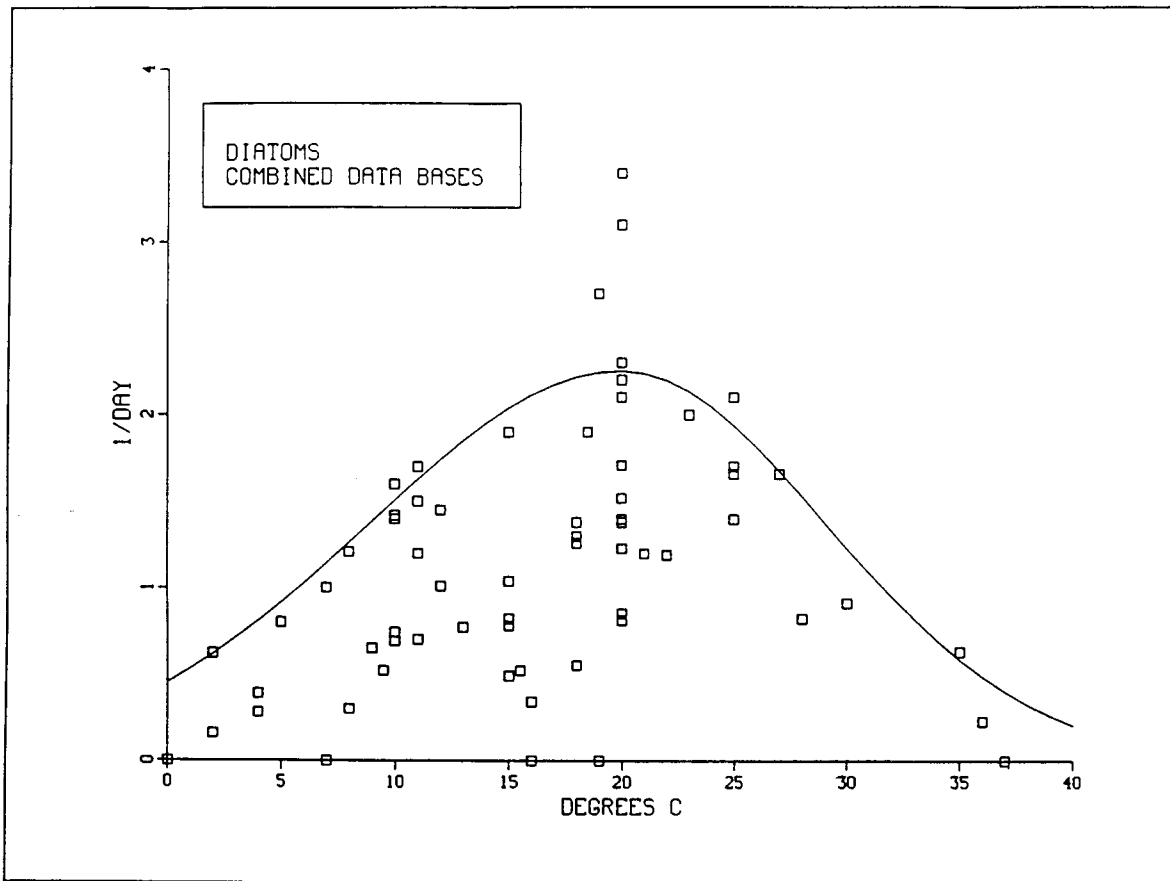

Figure 5-2. Reported and modeled growth rates for diatoms

biomass estimates for upper Chesapeake Bay indicate biomass is 1 - 2 gm C m<sup>-3</sup> during the spring bloom and 0.5 - 1 gm C m<sup>-3</sup> otherwise. Zooplankton biomass in the same region is  $\approx$  0.05 - 0.1 gm C m<sup>-3</sup> (OEP 1987). Consequently,  $\alpha$  is of order 0.1. Specific grazing rates derived from published values are  $\approx$  1 - 2 gm algal C gm<sup>-1</sup> zooplankton C day<sup>-1</sup> (Table 5-3). The order-of-magnitude grazing rate should then be 0.1 - 0.2 day<sup>-1</sup>.

Predation rates employed in the model (Table 5-3) were determined by calibration in the vicinity of the order-of-magnitude values derived above. Effects of temperature on predation were considered identical to effects of temperature on respiration. As with respiration, predation rates on diatoms in spring were reduced in order to simulate the bloom.

**Macrobenthic grazing.** Although macrobenthic grazing may be a locally important phytoplankton sink (Cohen et al. 1984), grazing rates were set to zero in the model. Spatial and temporal specification of benthic biomass presented a complication that could not be addressed within the time and technical frame of the study. Proper implementation of benthic grazing also



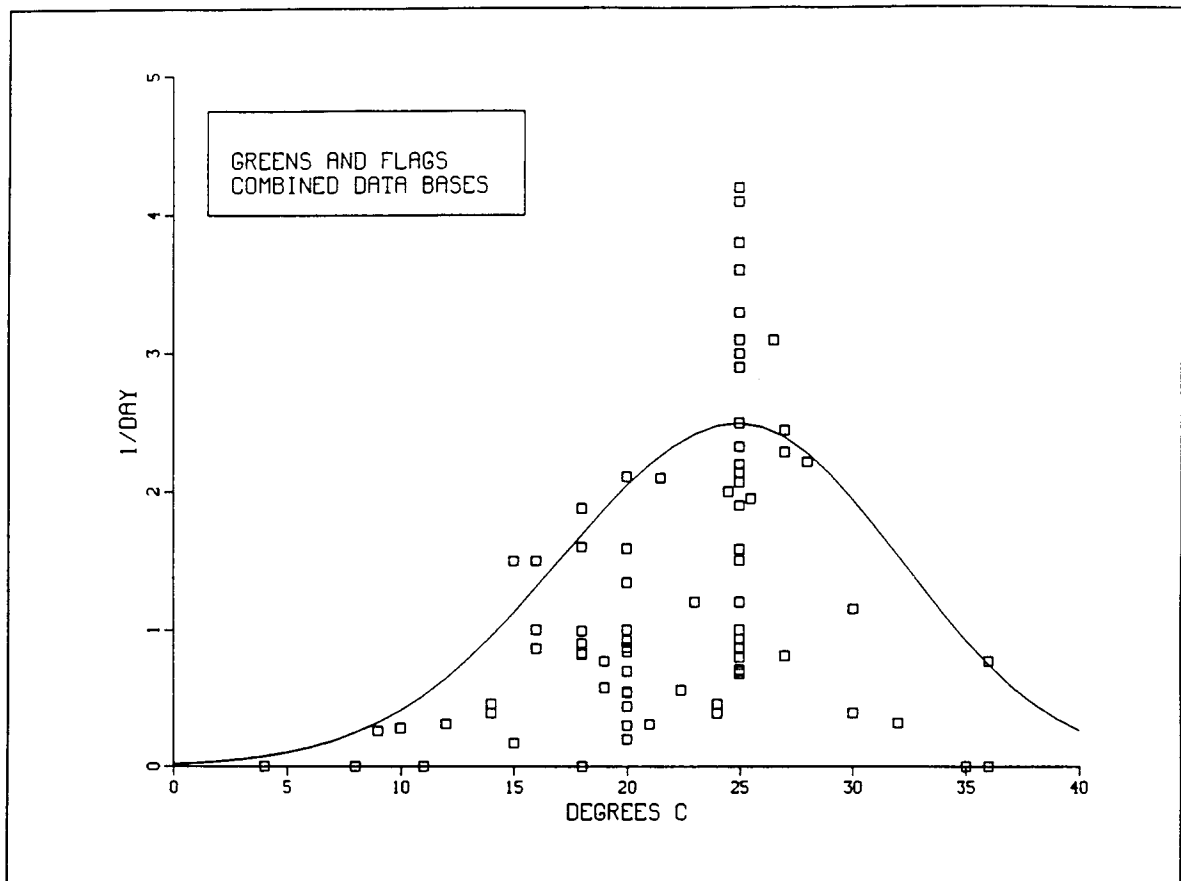

Figure 5-3. Reported and modeled growth rates for green algae

required modifications to the sediment submodel. Explicit treatment of benthic grazing may be a worthwhile future improvement in the water quality and sediment models. In the meanwhile, algal losses due to benthic grazing were lumped into the predation term.

### Composition

**Nitrogen.** Determination of algal stoichiometry was based on the assumption that composition of organic particles near the surface of the Bay (depth  $\leq 2$  m) approximated the composition of viable algae. Algal carbon-to-nitrogen ratio was evaluated using the relationship:

$$POC = POC_b + CNR PON \quad (5-3)$$

Table 5-2 Basal Metabolic Rates			
Group	Parameter	Value	Comments
	BMrx	0.03 - 0.09 day <sup>-1</sup>	Experiments by Laws and Wong (1978)
	BMrx	0.02 - 0.36 day <sup>-1</sup>	Raven and Beardall (1981)
Cyanobacteria	BMrc	0.04 day <sup>-1</sup>	Model value
	Trc	20 C°	"
	KTbc	0.069 C° <sup>-1</sup>	"
Diatoms	BMrd	0.01 day <sup>-1</sup> 0.003 day <sup>-1</sup>	Model value January - May in saltwater only
	Trd	20 C°	Model value
	KTbd	0.069 C° <sup>-1</sup>	"
Greens	BMrg	0.01 day <sup>-1</sup>	"
	Trg	20 C°	"
	KTbg	0.069 C° <sup>-1</sup>	"

Table 5-3 Predation Rates			
Group	Parameter	Value	Comments
	G	1 - 2 day <sup>-1</sup>	Copepod <i>Calanus pacificus</i> , derived from Beers (1986)
	G	0.7 - 1.1 day <sup>-1</sup>	<i>Acartia</i> , Patuxent River, derived from Storms (1974)
	G	2.6 day <sup>-1</sup>	<i>Strombodium</i> , derived from Beers and Brownlee (1988)
Cyanobacteria	BPRc	0.01 day <sup>-1</sup>	Model value
Diatoms	BPRd	0.215 day <sup>-1</sup> 0.065 day <sup>-1</sup>	Model value January - May, saltwater only
Greens	BPRg	0.215 day <sup>-1</sup>	Model value

$POC$  = particulate organic carbon (gm C m<sup>-3</sup>)

$POC_b$  = non-algal particulate organic carbon (gm C m<sup>-3</sup>)

$CNR$  = carbon-to-nitrogen ratio of algae (gm C gm<sup>-1</sup> N)

$PON$  = particulate organic nitrogen (gm N m<sup>-3</sup>)

Carbon-to-nitrogen ratio was evaluated via regression employing observed particulate organic nitrogen as the independent variable and observed particulate organic carbon as the dependent variable. Type II regression (Ricker 1972; Laws and Archie 1981), appropriate when the value of the independent variable is uncertain, was employed in the determination.

Regressions were performed using data separated into seasons. The separation allowed for potential seasonal variation in algal composition and in the background concentration of non-algal particulate organic carbon (Figure 5-4). Seasonal differences in composition were apparent (Table 5-4) although the significance of the seasonal differences was not tested. Ratios were close to Redfield stoichiometry which was employed in the model (Table 5-5).

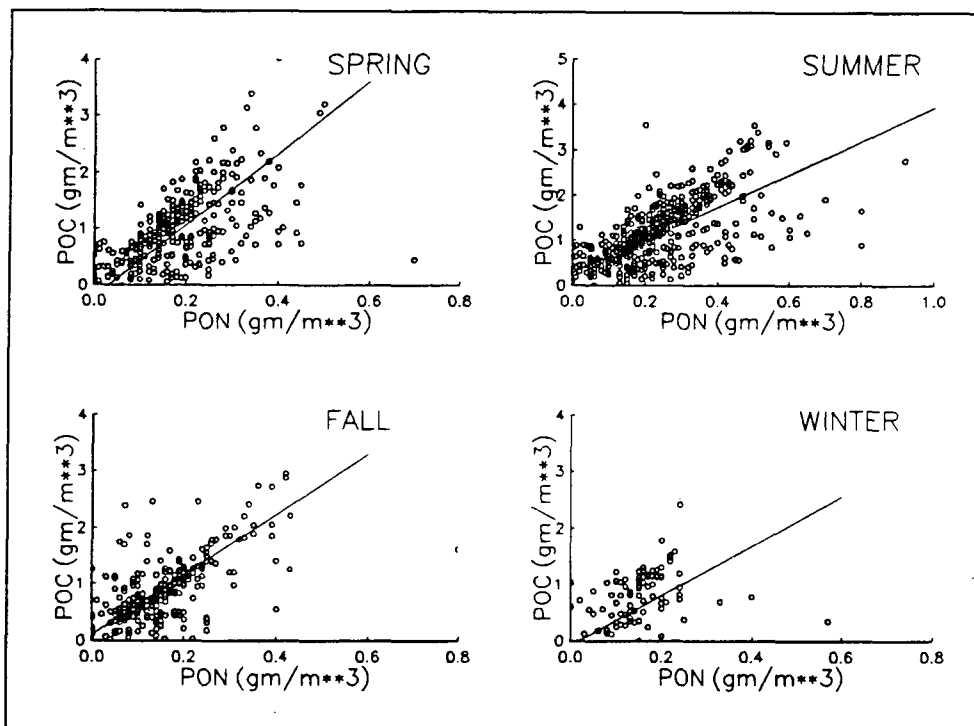

Figure 5-4. Carbon-to-nitrogen ratio in upper Chesapeake Bay seston

**Phosphorus.** Analysis indicated the carbon-to-phosphorus ratio of particles varied as a function of dissolved phosphate concentration (Figure 3-8). To account for the phenomenon, variable algal phosphorus stoichiometry was formulated (Equation 3-30). Parameters in the stoichiometry relationship (Table 5-5) were initially evaluated by visual fit to the observed particle composition. Initial values were subsequently adjusted during calibration of algae and phosphorus state variables. Modeled algal carbon-to-phosphorus ratio maintained the functional form suggested by the observations but was greater than observed particle composition (Figure 5-5). The offset between observations and model indicated a fraction of the observed particulate phosphorus was not incorporated in viable algae. Modeled algal composition approached Redfield stoichiometry (carbon-to-phosphorus = 42) at dissolved phosphate

Table 5-4 Carbon-to-Nitrogen Ratio of Particles in Upper Chesapeake Bay				
Season	Ratio, gm C gm <sup>-1</sup> N	Observations	r	p
Spring	6.34	335	0.55	< 0.0001
Summer	3.64	667	0.68	< 0.0001
Autumn	5.32	377	0.54	< 0.0001
Winter	4.39	102	0.61	< 0.0001

Table 5-5 Model Algal Nitrogen and Phosphorus Stoichiometry		
Parameter	Units	Value
ANCx	gm N gm <sup>-1</sup> C	0.167, all groups
PCprm1	gm C gm <sup>-1</sup> P	42.
PCprm2	gm C gm <sup>-1</sup> P	85.
PCprm3	m <sup>3</sup> gm <sup>-1</sup> P	200.

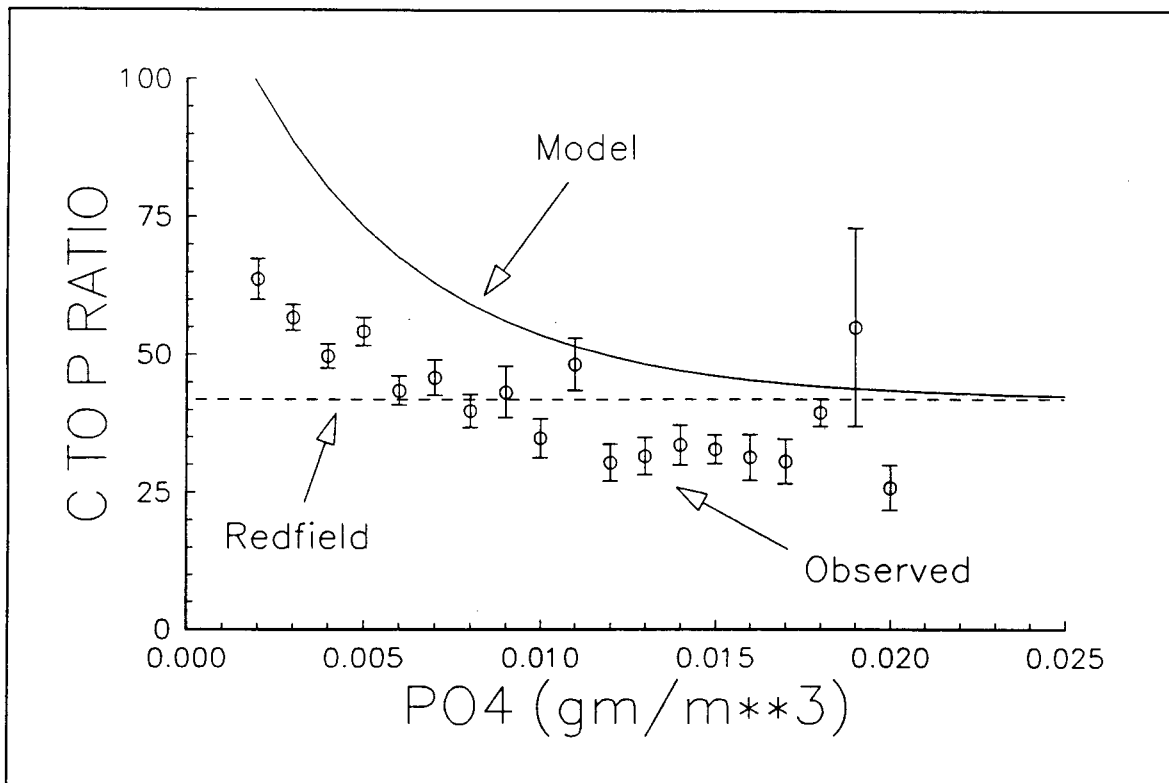

Figure 5-5. Modeled and observed phosphorus-to-carbon ratio

concentration greater than  $\approx 0.02 \text{ gm m}^{-3}$ . Algal carbon-to-phosphorus ratio increased when phosphate was less than  $\approx 0.02 \text{ gm m}^{-3}$ .

**Silica.** The silica content of diatoms was estimated by Type II regression of particulate biogenic silica on particulate organic carbon. Data were divided into seasons to allow for variations in the ratio as a function of diatom abundance. A significant relationship occurred only in Spring (March to May) coincident with the spring bloom. The model value was adjusted from the regression value to optimize predicted chlorophyll during the spring bloom (Table 5-6).

<b>Table 5-6 Silica Stoichiometry</b>		
<b>Parameter</b>	<b>Value</b>	<b>Comments</b>
ASCd (gm Si gm <sup>-1</sup> C)	0.43	Regression on observations at R-64. n = 38, R <sup>2</sup> = 0.45, p < 0.0001
	0.29	Suggested by D'Elia et al. (1983) for Chesapeake Bay
	0.5 - 1.0	Summary by Parsons et al. (1984)
	0.50	Model value

**Carbon-to-chlorophyll ratio.** Determination of carbon-to-chlorophyll ratio followed the pattern set for carbon-to-nitrogen ratio. Type II regression was performed on data segregated by season. Chlorophyll concentration was treated as the independent variable and particulate organic carbon was treated as the dependent variable (Figure 5-6). Significant regressions were obtained for three seasons (Table 5-7). Seasonal variations in carbon-to-chlorophyll ratio were apparent but the statistical significance of the variation was not tested. A constant ratio, consistent with the regressions and reported values was specified (Table 5-8).

### **Nutrient uptake**

Model half-saturation values for nutrient uptake are reported along with relevant literature values in Table 5-9.

### **Light**

Model parameters that relate algal growth to light are reported in Table 5-10.

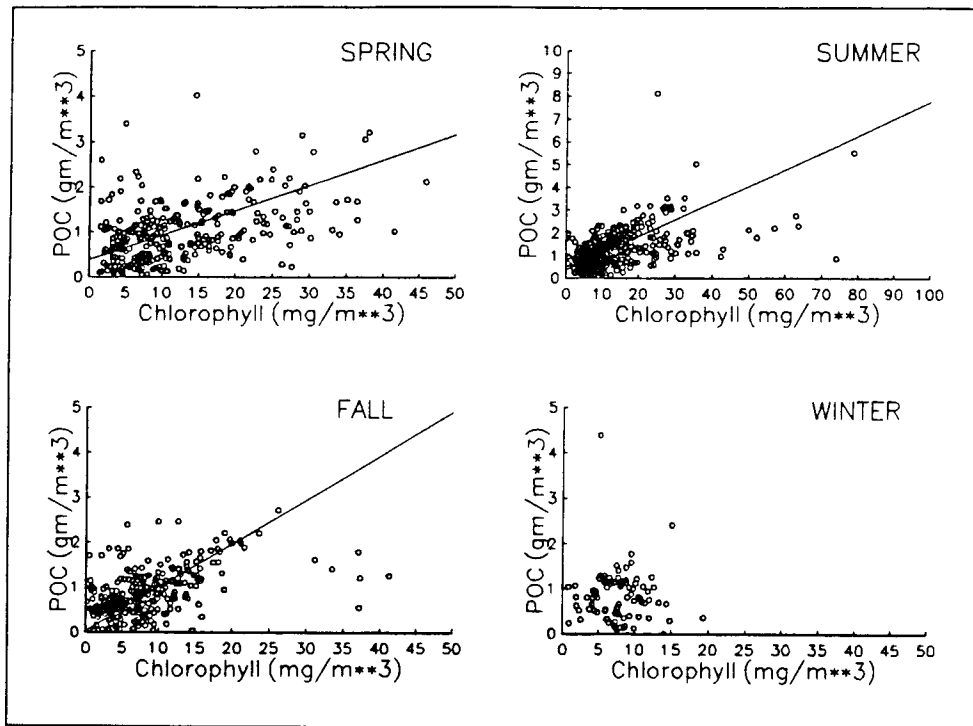

Figure 5-6. Particulate organic carbon versus chlorophyll in upper Chesapeake Bay surface water

<b>Table 5-7 Carbon-to-Chlorophyll Ratio of Upper Bay Particles</b>				
Season	Ratio, gm C gm <sup>-1</sup> Chl	Observations	r	p
Spring	77	320	0.45	< 0.0001
Summer	67	654	0.46	< 0.0001
Autumn	97	364	0.44	< 0.0001
Winter				> 0.59

<b>Table 5-8 Reported and Modeled Carbon-to-Chlorophyll Ratio</b>		
CChl, gm C gm <sup>-1</sup> Chl	Comments	Source
90	Proposed for Chesapeake Bay	Harding et al. (1986)
37 - 79	Marine phytoplankton	Antia et al., cited by Parsons et al. (1984)
48	Choptank River mesocosms	Roman et al. (1988)
30 - 143	Mesohaline Chesapeake Bay	Malone et al. (1988)
60	Model, all groups	

<b>Table 5-9 Half-Saturation Constants for Algal Nutrient Uptake</b>			
<b>Nutrient</b>	<b>Parameter</b>	<b>Value, gm m<sup>-3</sup></b>	<b>Comments</b>
Nitrogen	KHnc	0.16 - 0.22	Literature search (Collins and Wlosinski 1983)
	KHnd	0.003 - 0.186	"
	KHng	0.006 - 0.589	"
		0.001 - 0.008	NH <sub>4</sub> uptake in Chesapeake Bay (Wheeler et al. 1982)
	KHnx	0.010, all groups	Model Value
Phosphorus		0.001 - 0.105	Literature search (Collins and Wlosinski 1983)
		0.003 - 0.008	PO <sub>4</sub> uptake in Chesapeake Bay (Taft et al. 1975)
	KHpx	0.001, all groups	Model Value
Silica	KHs	0.031	<i>Skelotenema costatum</i> (Davis et al. 1978)
	KHs	0.02 - 0.10	Paasche cited by Parsons et al. (1984)
	KHs	0.082	Goering et al. cited by Parsons et al. (1984)
	KHs	0.050	Model Value

<b>Table 5-10 Model Parameters Relating Algae to Light</b>		
<b>Parameter</b>	<b>Model Value</b>	<b>Comments</b>
Kechl	17 m <sup>2</sup> gm <sup>-1</sup> Chl 'a'	Compares to 14 - 31 m <sup>2</sup> gm <sup>-1</sup> Chl 'a' reported in summary by Pennock (1985)
Dopt	1 m, all groups	Obtained from Kremer and Nixon (1978)
Ismin	40 Langleys day <sup>-1</sup>	Obtained from Kremer and Nixon (1978)

### Algal Settling Rates

Reported settling rates observed for diatoms (Figure 5-7) and other algae (Figure 5-8) vary over several orders of magnitude. In part, this variation is a function of physical factors related to algal size, shape, and density. The dramatic variability also reflects regulation of algal buoyancy as a function of light, nutrients, and other factors. Settling rates employed in the model (Table 5-11) were determined via calibration, aided by qualitative guidelines.

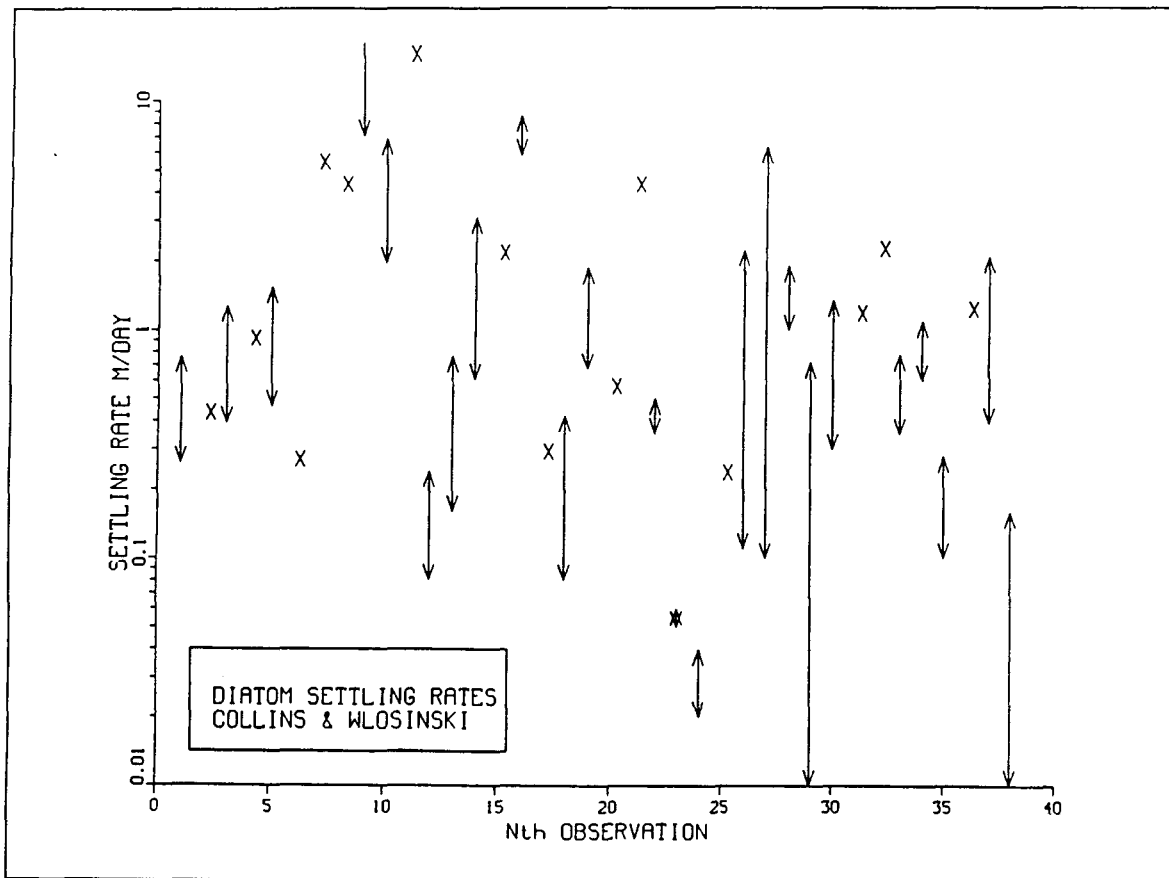

Figure 5-7. Diatom settling rates (Collins and Wlosinski 1983)

One guideline was that settling of the large diatoms that characterize the spring bloom should be greater than settling of smaller diatoms and other species that predominate the remainder of the year. A second guideline was that net settling of cyanobacteria must be small as evidenced by formation of surface algal mats.

#### Effect of algae on organic carbon and dissolved oxygen

Direct relation of experimental observations to the model distribution of biomass due to algal mortality is difficult. One problem is that experimental design is not intended to measure distribution as parameterized in the model. A second problem is that carbon and nutrient cycles in the model are affected by both the initial distribution of algal biomass and the recycling rates. Different combinations of initial distributions and recycling rates can yield equivalent concentrations of organic and inorganic substances. As a consequence, experiments should be viewed as qualitative guides only for selection of model parameters.



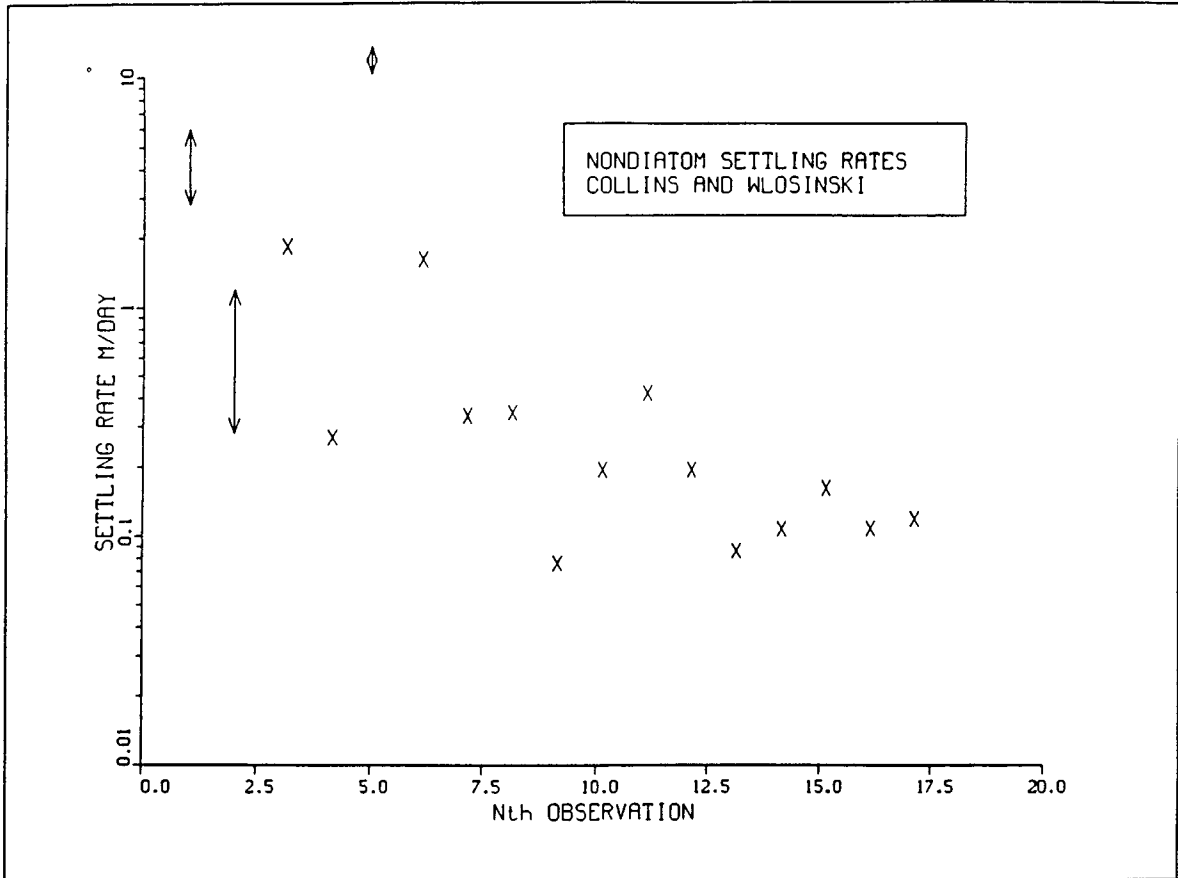

Figure 5-8. Nondiatom algal settling rates (Collins and Wlosinski 1983)

Table 5-11 Algal Settling Rates		
Group	Parameter	Value
Cyanobacteria	WSc	0.0 m day <sup>-1</sup>
Diatoms	WSdb	0.1 m day <sup>-1</sup>
	WSds	0.25 m day <sup>-1</sup>
	Prdval	1 (January - May)
		0 (June - December)
Greens	WSg	0.1 m day <sup>-1</sup>

The primary issue in recycling of algal carbon was the distribution of dissolved, labile particulate, and refractory particulate organic carbon. No universal distinction between labile and refractory exists. Definition in the present study was based on parameters employed in the sediment model. In the sediment model, the carbon fraction deemed labile (G1) had a decay rate

of  $0.035 \text{ day}^{-1}$  @  $20 \text{ }^{\circ}\text{C}$ . Ninety-percent of G1 carbon was mineralized in 65 days. Labile carbon in the water quality model was defined as the carbon that mineralizes in  $\approx 60$  days. In interpretation of experiments, carbon that mineralized in  $\approx 60$  days or less corresponded to labile carbon in the model. Results of some relevant experiments (Table 5-12) were used to guide selection of initial model parameters. Final parameters (Table 5-13) were selected by adjustment of initial values to optimize agreement of predicted and observed state variables.

<b>Table 5-12 Reported Distribution of Algal Carbon</b>	
<b>Distribution</b>	<b>Reference</b>
Refractory fraction of algae averages 40% of ash-free dry weight	Foree and McCarty (1970)
22% dissolved, 73% labile particulate, 5% refractory particulate	Pett (1989)
33% dissolved, 33% labile particulate, 33% refractory particulate	Westrich and Berner (1984)
7% dissolved, 63% labile particulate, 30% refractory particulate	Otsuki and Hanya (1972)
dissolved organic carbon exudation from healthy cells < 15% of carbon fixed	Parsons et al. (1984)

<b>Table 5-13 Modeled Effects of Algae on Organic Carbon and Dissolved Oxygen</b>	
<b>Parameter</b>	<b>Value</b>
FCDx	0.0, all groups
FCDP	0.10
FCLP	0.55
FCRP	0.35
KHrx	0.5 gm DO $\text{m}^{-3}$ , all groups
AOCR	2.67 gm DO $\text{gm}^{-1}$ C

### **Effect of algae on nitrogen and phosphorus**

Parameterization of the distribution of algal nutrients upon mortality was similar to distribution of algal carbon except that distribution into an inorganic pool was also required. As with carbon, experiments were interpreted so that

organic matter that decayed on a time scale  $\approx 60$  days was considered labile. Results of relevant experiments (Table 5-14) guided selection of initial model parameters. Final nitrogen and phosphorus parameters (Table 5-15) were selected to optimize agreement of predicted and observed state variables.

<b>Table 5-14 Reported Distribution of Algal Nitrogen and Phosphorus</b>		
<b>Nutrient</b>	<b>Distribution</b>	<b>Reference</b>
Nitrogen	5 to 7% dissolved inorganic, 30 to 50% dissolved organic, labile particulate > 22 to 44%, refractory particulate < 21 to 23%	Garber (1984)
	50% of particulate nitrogen is refractory	Grill and Richards (1964)
	6% dissolved organic, 64% labile particulate, 30% refractory particulate	Otsuki and Hanya (1972)
Phosphorus	24 to 27% dissolved inorganic, 42 to 56% dissolved organic, labile particulate > 4 to 16%, refractory particulate < 7 to 27%	Garber (1984)
	33% of particulate phosphorus is refractory	Grill and Richards (1964)

<b>Table 5-15 Modeled Effects of Algae on Nitrogen and Phosphorus</b>			
<b>Parameter</b>	<b>Value</b>	<b>Parameter</b>	<b>Value</b>
FNix	0.0, all groups		
FNDx	1.0, all groups	FPDx	1.0, all groups
FNLx	0.0, all groups	FPLx	0.0, all groups
FNRx	0.0, all groups	FPRx	0.0, all groups
FNIP	0.0		
FNDP	0.1	FPDP	0.5
FNLP	0.55	FPLP	0.2
FNRP	0.35	FPRP	0.1

## Hydrolysis and Mineralization Rates

The model required specification of the rates at which particulate organic matter was solubilized into dissolved organic matter and the rates at which dissolved organic matter was converted to inorganic form. For carbon, these rates were referred to as dissolution and respiration rates. For nitrogen and phosphorus, the rates were referred to as hydrolysis and mineralization rates.

Literature summaries (Bowie et al. 1985) indicated orders-of-magnitude variation in the rates employed in eutrophication models. Most often, the first-order rate constants were of order  $10^{-2}$  to  $10^{-1}$  day<sup>-1</sup>. The base rates employed for dissolved and labile particulate organic matter in the present study (Table 5-16), selected to optimize agreement of predicted and observed state variables, were within the order-of-magnitude range most often employed elsewhere. Temperature parameters were specified so that rates doubled for a 10 °C increase in temperature.

Parameter	Value	Parameter	Value	Parameter	Value
Kdc	0.010 day <sup>-1</sup>	Kdn	0.015 day <sup>-1</sup>	Kdp	0.100 day <sup>-1</sup>
Klc	0.075 day <sup>-1</sup>	Kln	0.075 day <sup>-1</sup>	Klp	0.075 day <sup>-1</sup>
Krc	0.005 day <sup>-1</sup>	Krn	0.005 day <sup>-1</sup>	Krp	0.005 day <sup>-1</sup>
Kdcalg	0.0	Kdnalg	0.0	Kdpalg	0.2 m <sup>3</sup> day <sup>-1</sup> gm <sup>-1</sup> C
Klcalg	0.0	Klnalg	0.0	Klpalg	0.0
Krcalg	0.0	Krnalg	0.0	Krpalg	0.0
AANOX	0.5				
KHodoc	0.5 gm DO m <sup>-3</sup>				
KHndn	0.1 gm N m <sup>-3</sup>				
Trmnl	20 C°				
KTmnl	0.069 C° <sup>-1</sup>				
Trhdr	20 C°				
KThdr	0.069 C° <sup>-1</sup>				

Dissolution and hydrolysis rates for refractory particulates were arbitrarily set an order of magnitude ( $\approx 10^{-3}$  day<sup>-1</sup>) less than the rates for labile particulates. The refractory rates (Table 5-16) were negligibly small and their specification had no demonstrable effect on calibration.

The formulation of the model allowed relation of carbon, nitrogen, and phosphorus recycle rates to algal biomass, a surrogate for bacterial activity. For nitrogen and phosphorus, the formulation also accelerated hydrolysis and mineralization as nutrients become scarce. This option rested on a strong observational base for phosphorus. The option was originally included in the model in order to make phosphorus available during the spring bloom, a period of high algal biomass and phosphorus-limited conditions, without overestimating inorganic phosphorus concentration the remainder of the year. The

acceleration option for phosphorus was activated in the calibration (Table 5-16). Assuming a characteristic algal biomass of  $1 \text{ gm C m}^{-3}$ , the phosphorus mineralization rate increased from  $0.1 \text{ day}^{-1}$  when phosphate was freely available to  $0.3 \text{ day}^{-1}$  when phosphate was 100% limiting to algal growth. During the calibration procedure, no advantage in relating carbon dissolution and respiration rates to algal biomass was noted. Calibration of nitrogen concentrations was satisfactory without relating recycle rates to algal biomass.

## Detrital Settling Rates

The first estimate of detrital settling rates was obtained by computation of Stokes' velocity for a settling sphere (Scavia 1980):

$$W = \frac{2}{9} g r^2 \frac{\Delta\rho}{\nu} \quad (5-4)$$

$W$  = settling velocity ( $\text{cm sec}^{-1}$ )

$g$  = gravitational acceleration ( $980 \text{ cm sec}^{-2}$ )

$r$  = equivalent radius (cm)

$\Delta\rho$  = excess density ( $\text{gm cm}^{-3}$ )

$\nu$  = kinematic viscosity of water ( $\approx 0.01 \text{ gm sec}^{-1} \text{ cm}^{-1}$  @  $20 \text{ }^\circ\text{C}$ )

The size and density of organic detritus, for use in Stokes' equation, were characterized by reported size and density of phytoplankton. The characteristic radius of phytoplankton was  $10^0$  to  $10^2 \text{ } \mu\text{m}$  (Beers 1986). Excess density was  $\approx 0.2 \text{ gm cm}^{-3}$  for diatoms and  $0.03 \text{ gm cm}^{-3}$  for other algae (Scavia 1980). The resulting computed range of settling velocities ranged from  $10^{-2}$  to  $10^2 \text{ m day}^{-1}$  (a fairly large range from which to choose).

An alternate, more precise, initial estimate of detrital settling velocity was obtained employing data from a sediment trap in the upper Bay. Dimensional analysis indicated detrital settling rate could be estimated:

$$W = \frac{Dpoc}{POC} \quad (5-5)$$

$W$  = settling velocity ( $\text{m day}^{-1}$ )

$D_{poc}$  = particulate organic carbon deposition rate measured in trap  
(gm C m<sup>-2</sup> day<sup>-1</sup>)

$POC$  = particulate organic carbon concentration in vicinity of trap  
(gm C m<sup>-3</sup>)

Particulate carbon deposition rates measured in the trap were 0.5 to 1 gm C m<sup>-2</sup> day<sup>-1</sup>. Water-column surface particulate organic carbon concentrations in the vicinity were 0.5 to 1.5 gm C m<sup>-3</sup>. The characteristic settling velocity, given by Equation 5-5, was 0.5 to 1.5 m day<sup>-1</sup>.

The sediment trap analysis provided a range of feasible settling velocities for use in the model. Final value of settling velocity (Table 5-17) was selected to optimize agreement of predicted and observed carbon, nitrogen, and phosphorus in the water column and benthic sediments.

<b>Table 5-17 Detrital Settling Velocities</b>		
<b>Parameter</b>	<b>Value</b>	<b>Comments</b>
	10 <sup>-2</sup> - 10 <sup>2</sup> m day <sup>-1</sup>	Stokes' velocity for phytoplankton-size particles
	0.5 - 1.5 m day <sup>-1</sup>	Characteristic of sediment trap
WSs	1.0 m day <sup>-1</sup>	Model value
WSI	1.0 m day <sup>-1</sup>	"
WSr	1.0 m day <sup>-1</sup>	"

## Nitrification

Representation of nitrification in the model required specification of maximum nitrification rate and effects of dissolved oxygen, ammonium, and temperature on the maximum. Parameters for the Bay model were selected from reported ranges (Table 5-18). Extensive calibration of the nitrification parameters was not conducted as the process was not a major factor in the oxygen budget or distribution of ammonium and nitrate.

## Chemical Oxygen Demand

The principal component of chemical oxygen demand in saline waters of Chesapeake Bay is the oxidation of sulfide. Parameters for chemical oxygen demand kinetics in the model (Table 5-19) were selected from reported rates for sulfide oxidation.

Table 5-18 Parameters in Nitrification Kinetics					
NTm, gm N m <sup>-3</sup> day <sup>-1</sup>	KHnt, gm N m <sup>-3</sup>	KHont, gm DO m <sup>-3</sup>	Tmnt, C°	KTnt, C° <sup>-2</sup>	Comments
0.006 - 0.446					Chesapeake Bay (Horrigan et al. 1990)
0.018					Enriched microcosm, Narragansett Bay (Berounsky and Nixon 1985)
0.027					James River (Kator 1990)
0.043					Tamar Estuary (Owens 1986)
0.004 - 0.11					Delaware Estuary (Lipschultz et al. 1986)
	0.78	1	25 - 35	≈ 0.006	For growth of <i>nitrosomonas</i> (Helder and DeVries 1983)
	1.6		15		Charley et al. (1980)
	1.3 - 2.6		> 25		Stratton and McCarty (1967)
	0.06 - 3.5	0.6 - 3	28 - 36		Review by Sharma and Ahlert (1977)
0.07	1.0	1.0	27	0.0045	Model

Table 5-19 Chemical Oxygen Demand Parameters			
Kcod, day <sup>-1</sup>	KHocod, gm DO m <sup>-3</sup>	KTcod, C° <sup>-1</sup>	Comments
1 to 42	≈ 1	0.041	Seawater (Almgren and Hagstrom 1974)
35 to 76	3	0.046	Domestic wastewater (Wilmot et al. 1988)
43 to 144			Chesapeake Bay bottom water (Millero 1991)
20	1.5	0.041	Model. Trcod = 20 C°

## Particulate Biogenic Silica

Parameters affecting the cycling of particulate biogenic silica were selected within the range of published values (Table 5-20) and adjusted to optimize agreement of predicted and observed silica and chlorophyll.

<b>Table 5-20 Particulate Biogenic Silica Parameters</b>			
<b>K<sub>sua</sub>, day<sup>-1</sup></b>	<b>K<sub>Tsua</sub>, °C</b>	<b>FSAP</b>	<b>Comments</b>
0.06			Wollast (1974)
0.04			Vanderborght et al. (1977)
0.017			Grill and Richards (1964)
	0.092		Lawson cited by Yamada and D'Elia (1984)
0.03	0.092	0.0	Model. Tr <sub>sua</sub> = 20 C°

## Reaeration

Application of two reaeration formulae, one dependent on bottom stress and the other a wind-dependent formulation, indicated the order-of-magnitude reaeration coefficient for Chesapeake Bay is 1 m day<sup>-1</sup> (Cerco 1989). The order-of-magnitude estimate was employed as a starting value during model calibration. The final reaeration coefficient selected was  $K_r = 2.4 \text{ m day}^{-1}$ .

## Total Active Metal

Solubility and benthic release rate for total active metal were selected from iron and manganese data reported for estuaries (Table 5-21). The half-saturation dissolved oxygen concentration and temperature dependence were developed from the same sources. Order-of-magnitude phosphorus and silica partition coefficients were derived from O'Connor (1988) and converted to appropriate units employing a metal molecular weight of 55 gm mol<sup>-1</sup>.



**Table 5-21  
Total Active Metal Parameters**

Parameter	Value	Comments	Reference
BENTAM (mmol m <sup>2</sup> day <sup>-1</sup> )	0.73	Anoxic Fe release	Kiel Bight (Balzer 1982)
	0.36	Oxic Mn release	
	1.1	Anoxic Mn release	
	0.3	Oxic Mn release	
	7.0	Anoxic Mn release	
	0.36	Oxic Mn release	Narragansett Bay (Graham et al. 1976)
	10.0	Model value @ 20C°	
TAMdmx (mmol m <sup>-3</sup> )	8 to 10	Fe in anoxic water	Kiel Bight (Balzer 1982)
	≈ 80	Mn in anoxic water	
	2 to 5	Fe in anoxic water	Chesapeake Bay (Gavis and Grant 1986)
	5 to 10	Mn in anoxic water	
	5 to 12	Mn in anoxic water	Chesapeake Bay (Eaton 1979)
	15	Model value	
Kdotam (gm DO m <sup>-3</sup> )	1.0	Model value	
KHbmf (gm DO m <sup>-3</sup> )	0.5	Model value	
KTbmf (C° <sup>-1</sup> )	0.2	Model value	
Kadpo4 (m <sup>3</sup> mol <sup>-1</sup> )	6.0	Model value	
Kadsa (m <sup>3</sup> mol <sup>-1</sup> )	6.0	Model value	

# 6 Sediment Parameter Evaluation

## User-Specified Fluxes

Base fluxes and influences of temperature and other factors are best determined from observations collected in the prototype system. Table 6-1 lists observations from several systems which may be employed as starting values when no observations are available.

<b>Ammonium, mg m<sup>-2</sup> day<sup>-1</sup></b>	<b>Nitrate, mg m<sup>-2</sup> day<sup>-1</sup></b>	<b>Phosphate, mg m<sup>-2</sup> day<sup>-1</sup></b>	<b>Silica, mg m<sup>-2</sup> day<sup>-1</sup></b>	<b>SOD, gm m<sup>-2</sup> day<sup>-1</sup></b>	<b>System</b>
10 to 280	-40 to 100	-3 to 30		-1.5 to -3.5	Chesapeake Bay (Boynton and Kemp 1985)
			67 to 670		Chesapeake Bay (D'Elia et al. 1983)
-1 to 90	-20 to 15	-7 to 31		-0.1 to -2.6	Narragansett Bay (Hale 1975)
0 to 150	0 to 2	-6 to 34		-0.6 to -2.4	Neuse and South Rivers, NC (Fisher et al. 1982)
-40 to 360	-100 to 80	-19 to 124		-0.1 to -2.7	Potomac Estuary (Callender and Hammond 1982)
-35 to 530	-230 to 30	1 to 220		-0.5 to -4.1	Patuxent Estuary (Boynton et al. 1980)

Suggested starting values for parameters in the functions that relate sediment-water fluxes to conditions in the water column are listed in Table 6-2.

<b>Table 6-2 Parameters in Sediment-Water Flux Relationships</b>	
<b>Parameter</b>	<b>Suggested Range</b>
KSx	0.04 to 0.07 C° <sup>-1</sup>
MTCNO <sub>3</sub>	0.05 to 0.15 m day <sup>-1</sup>
SEDNO <sub>3</sub>	0 to 0.05 gm m <sup>-3</sup>
KHso	1 to 2 gm m <sup>-3</sup>

## Predictive Sediment Submodel

The predictive sediment submodel (DiToro and Fitzpatrick 1993) was developed in a “standalone” mode, independent of a model of the water column. Development and initial calibration were based on extensive observations collected in Chesapeake Bay. Next, the sediment model was operated in a coupled mode with the Chesapeake Bay eutrophication model (Cercó and Cole 1994). The Chesapeake Bay study represents the most extensive application of the sediment model to date and is the source of the vast majority of parameter values listed below.

Parameters in the sediment submodel can be divided into two categories. The first category includes parameters that were developed in the standalone mode and transferred directly to the coupled mode. The second category includes parameters that were revised during operation in the coupled mode or that required evaluation only during coupled operation.

### Sediment model constants

Parameters that were transferred directly from standalone to coupled operation are listed in Table 6-3. These values were employed in the standalone and coupled modes in Chesapeake Bay and were suitable for preliminary application of the coupled models to the Inland Bays of Delaware. The tabulated values are presently recommended for employment without modification in applications of the sediment submodel.

<b>Table 6-3 Constants in Sediment Submodel</b>			
<b>Constant</b>	<b>Definition</b>	<b>Value</b>	<b>Units</b>
CSISAT	Saturation concentration of porewater silica	40000	mg Si m <sup>-3</sup>
DCTHTA(1)	Temperature constant ( $\theta$ in Eq. 4-7) for diagenesis of G1 carbon fraction	1.1	
DCTHTA(2)	Temperature constant for diagenesis of G2 carbon fraction	1.15	
DCTHTA(3)	Temperature constant for diagenesis of G3 carbon fraction	1.17	
DIFFT	Sediment-water thermal diffusion coefficient	0.0018	cm <sup>2</sup> sec <sup>-1</sup>
DNTHTA(1)	Temperature constant ( $\theta$ in Eq. 4-7) for diagenesis of G1 nitrogen fraction	1.1	
DNTHTA(2)	Temperature constant for diagenesis of G2 nitrogen fraction	1.15	
DNTHTA(3)	Temperature constant for diagenesis of G3 nitrogen fraction	1.17	
DPIE1SI	Ratio of oxic to anoxic silica partition coefficient	10	
DPMIN	Minimum particle mixing coefficient	3 x 10 <sup>-6</sup>	m <sup>2</sup> day <sup>-1</sup>
DPTHTA(1)	Temperature constant ( $\theta$ in Eq. 4-7) for diagenesis of G1 phosphorus fraction	1.1	
DPTHTA(2)	Temperature constant for diagenesis of G2 phosphorus fraction	1.15	
DPTHTA(3)	Temperature constant for diagenesis of G3 phosphorus fraction	1.17	
HSED	Depth of active sediment layer	10	cm
KAPPCH4	Reaction velocity for methane oxidation	0.2	m day <sup>-1</sup>
KAPPP1	Reaction velocity for particulate sulfide oxidation in layer 1	0.4	m day <sup>-1</sup>
KAPPD1	Reaction velocity for dissolved sulfide oxidation in layer 1	0.2	m day <sup>-1</sup>
KBENSTR	Decay coefficient for benthic stress	0.03	day <sup>-1</sup>
KCDIAG(1)	Diagenesis rate for G1 carbon fraction at 20 C°	0.035	day <sup>-1</sup>
KCDIAG(2)	Diagenesis rate for G2 carbon fraction at 20 C°	0.0018	day <sup>-1</sup>
KCDIAG(3)	Diagenesis rate for G3 carbon fraction at 20 C°	0.0	day <sup>-1</sup>

(Sheet 1 of 3)

<b>Table 6-3 (Continued)</b>			
<b>Constant</b>	<b>Definition</b>	<b>Value</b>	<b>Units</b>
KLBNTH	Ratio of bioirrigation to bioturbation	0.0	
KMHSO2	Constant that expresses effect of dissolved oxygen on sulfide oxidation	4.0	gm O <sub>2</sub> m <sup>-3</sup>
KMO2DP	Dissolved oxygen concentration at which bioturbation is halved	4.0	gm O <sub>2</sub> m <sup>-3</sup>
KMPSI	Concentration of particulate biogenic silica at which dissolution is halved	5 x 10 <sup>7</sup>	mg Si m <sup>-3</sup>
KNDIAG(1)	Diagenesis rate for G1 nitrogen fraction at 20 C°	0.035	day <sup>-1</sup>
KNDIAG(2)	Diagenesis rate for G2 nitrogen fraction at 20 C°	0.0018	day <sup>-1</sup>
KNDIAG(3)	Diagenesis rate for G3 nitrogen fraction at 20 C°	0.0	day <sup>-1</sup>
KPDIAG(1)	Diagenesis rate for G1 phosphorus fraction at 20 C°	0.035	day <sup>-1</sup>
KPDIAG(2)	Diagenesis rate for G2 phosphorus fraction at 20 C°	0.0018	day <sup>-1</sup>
KPDIAG(3)	Diagenesis rate for G3 phosphorus fraction at 20 C°	0.0	day <sup>-1</sup>
KSI	Dissolution rate of particulate biogenic silica	0.5	day <sup>-1</sup>
M1	Concentration of solids in layer 1	0.5	kg L <sup>-1</sup>
M2	Concentration of solids in layer 2	0.5	kg L <sup>-1</sup>
O2CRIT	Dissolved oxygen concentration at which sorption of phosphate to solids is diminished	2.0	gm m <sup>-3</sup>
O2CRITSI	Dissolved oxygen concentration at which sorption of silica to solids is diminished	1.0	gm m <sup>-3</sup>
PIENH4	Ammonium partition coefficient	1.0	L kg <sup>-1</sup>
PIE1S	Sulfide partition coefficient in layer 1	100	L kg <sup>-1</sup>
PIE2S	Sulfide partition coefficient in layer 2	100	L kg <sup>-1</sup>
PIE2SI	Silica partition coefficient in layer 2	100	L kg <sup>-1</sup>
TEMPBEN	Temperature at which benthic stress is reset to zero	10	C°
THTACH4	Temperature constant ( $\theta$ ) for diagenesis of methane	1.08	

(Sheet 2 of 3)

<b>Table 6-3 (Concluded)</b>			
<b>Constant</b>	<b>Definition</b>	<b>Value</b>	<b>Units</b>
THTADD	Temperature constant ( $\theta$ ) for porewater diffusion	1.08	
THTADP	Temperature constant ( $\theta$ ) for particle mixing	1.17	
THTANH4	Temperature constant ( $\theta$ ) for nitrification	1.08	
THTANO3	Temperature constant ( $\theta$ ) for denitrification	1.08	
THTAPD1	Temperature constant ( $\theta$ ) for sulfide oxidation	1.08	
THTASI	Temperature constant ( $\theta$ ) for silica dissolution	1.1	
VDMIX	Porewater diffusion coefficient	0.001	m <sup>2</sup> day <sup>-1</sup>
VPMIX	Particle mixing coefficient	0.00012	m <sup>2</sup> day <sup>-1</sup>
<i>(Sheet 3 of 3)</i>			

### **Sediment model variables**

During application of the coupled models to Chesapeake Bay, the need for adjustment of sediment model parameters determined in standalone mode became apparent. Sediments adjacent to fall lines appeared to retain larger fractions of deposited nitrogen and phosphorus than sediments elsewhere. One way to readily parameterize this variation, especially in the tributaries, was assignment of different parameter values in fresh and saltwater. Increased nitrification and denitrification rates and phosphorus sorption coefficients were specified in freshwater relative to saltwater.

The adjustments for freshwater, forced by mass-balance considerations, were later independently validated. Experiments by Gardner, Seitzinger, and Malczyk (1991) determined that ammonium release from sediments in freshwater was less than from the same sediments in synthetic seawater. In the sediment model documentation, DiToro and Fitzpatrick (1993) indicated the phosphate partition coefficient was largest at the most upstream sample station, near the fall line, and decreased downstream.

During application of coupled models to Chesapeake Bay and the Inland Bays, a few other parameters also required revision from values determined in standalone mode. A distributed load of particulate biogenic silica was assigned to make up for absence of loading at and below the fall lines. Parameters determined during coupled model calibration are listed in Table 6-4. The tabulated parameters are suggested as the first parameters users should modify in application of the sediment model to other systems.

<b>Variable</b>	<b>Definition</b>	<b>Value</b>	<b>Units</b>
DPIE1PO4F	Ratio of oxic to anoxic phosphate partition coefficient in freshwater	3000 (Chesapeake Bay), 3 (Inland Bays)	
DPIE1PO4S	Ratio of oxic to anoxic phosphate partition coefficient in saltwater	300 (Chesapeake Bay), 3 (Inland Bays)	
JSIDETR	Distributed source of biogenic silica to sediments	100	mg Si m <sup>-2</sup> day <sup>-1</sup>
KAPPNH4F	Nitrification reaction velocity for layer 1 in freshwater	0.2	m day <sup>-1</sup>
KAPPNH4S	Nitrification reaction velocity for layer 1 in saltwater	0.14	m day <sup>-1</sup>
KAPPNO3F	Denitrification reaction velocity for layer 1 in freshwater	0.3	m day <sup>-1</sup>
KAPPNO3S	Denitrification reaction velocity for layer 1 in saltwater	0.125	m day <sup>-1</sup>
KMNH4	Ammonium concentration at which nitrification rate is halved	1500	mg N m <sup>-3</sup>
KMNH4O2	Dissolved oxygen concentration at which nitrification rate is halved	1.0	gm O <sub>2</sub> m <sup>-3</sup>
K2NO3	Denitrification reaction velocity for layer 2	0.25	m day <sup>-1</sup>
PIE2PO4	Phosphate partition coefficient in layer 2	100	L kg <sup>-1</sup>
SALTSW	Salinity below which methane rather than sulfide is produced as a result of carbon diagenesis. Also determines use of freshwater or saltwater phosphate partition coefficients	1.0	ppt
SALTND	Salinity below which freshwater nitrification and denitrification reactions velocities are employed	1.0	ppt
VSED	Sedimentation rate	0.5 near fall line, 0.25 to 0.37 elsewhere	cm year <sup>-1</sup>

## Coupling the water column and sediment submodel

**Net deposition rates.** Sensitivity analysis during the Chesapeake Bay application indicated that net settling velocity into the sediments ( $W_{net}$  in Equation 4-5) was not a critical model parameter. Transport from the water into the sediments was largely determined by the primary production of particles and settling through the water column. No more particles could be incorporated into the sediments than were produced in the water, no matter how large the net settling velocity. Specification of net settling less than settling in the water caused concentration in the cells above the sediments to increase until the product of concentration and settling velocity equaled the delivery of particles from the surface region of the water column.

Net settling was specified identical to particle settling velocities in the water column. The only exception was net settling of diatoms which was set to zero during the spring bloom period (January - May). Prevention of diatom settling into the sediments was essential to simulating the elevated subsurface diatom concentrations that defined the spring bloom.

**Assignment to G classes.** Upon deposition in the sediments, state variables representing particulate organic matter in the eutrophication model require conversion into sediment model state variables. The eutrophication model considers two classes of particulate organic matter: labile and refractory. The sediment model is based on three classes of organic particles: labile (G1), refractory (G2), and inert (G3). Labile particles from the eutrophication model are transferred directly into the G1 class in the sediment model. Refractory particles from the water quality model have to be split into G2 and G3 fractions upon entering the sediments. Initial guidance for the splits is obtained from experiments (Westrich and Berner 1984) in which roughly even distribution between refractory and inert particulate organic carbon was noted.

During the Chesapeake Bay study, spatial variation in the split between G2 and G3 fractions was required. Detritus deposited immediately below the fall lines was considered largely inert. The inert fraction was reduced as a function of distance downstream from the fall lines. The variable split was driven by observed nutrient concentrations in the water column. Unless fall-line particles settling to the sediments were assigned minimal reactivity, sediment nutrient releases produced water column concentrations greatly in excess of observations.

In all regions, nitrogen was considered slightly more reactive than carbon or phosphorus. This treatment was determined by the observed carbon enrichment of sediment particles relative to the water column. The carbon-to-nitrogen ratio in Chesapeake Bay sediments is  $\approx 10:1$ ; the carbon-to-nitrogen ratio in the water column is  $\approx 6:1$ .

Algae settling directly to the sediments also require routing into sediment model state variables. In the Chesapeake Bay study, the algal fraction routed



into G1 particles was equivalent to the fraction of algal particles assigned to the labile pool following mortality in the water column. Routing of refractory algae into G2 and G3 classes was equivalent to the split employed for detritus throughout most of the bay. No spatial variation in the reactivity of algae was considered.

A listing of parameters employed to route eutrophication model organic particles into sediment model organic particles is provided in Table 6-5.

<b>Table 6-5 Routing Organic Particles into Sediment Classes</b>		
<b>Variable</b>	<b>Definition</b>	<b>Value</b>
FRCPhx(1)	Fraction of algal group x carbon routed to G1 sediment class	0.65, all algal groups
FRCPhx(2)	Fraction of algal group x carbon routed to G2 sediment class	0.25, all algal groups
FRCPhx(3)	Fraction of algal group x carbon routed to G3 sediment class	0.10, all algal groups
FRNPhx(1)	Fraction of algal group x nitrogen routed to G1 sediment class	0.65, all algal groups
FRNPhx(2)	Fraction of algal group x nitrogen routed to G2 sediment class	0.28, all algal groups
FRNPhx(3)	Fraction of algal group x nitrogen routed to G3 sediment class	0.07, all algal groups
FRPOC(2)	Fraction of refractory carbon routed to G2 sediment class	0.11 to 0.43 near fall line, 0.73 elsewhere
FRPOC(3)	Fraction of refractory carbon routed to G3 sediment class	0.57 to 0.89 near fall line, 0.27 elsewhere
FRPON(2)	Fraction of refractory nitrogen routed to G2 sediment class	0.26 to 0.54 near fall line, 0.82 elsewhere
FRPON(3)	Fraction of refractory nitrogen routed to G3 sediment class	0.46 to 0.74 near fall line, 0.18 elsewhere
FRPOP(2)	Fraction of refractory phosphorus routed to G2 sediment class	0.11 to 0.43 near fall line, 0.73 elsewhere
FRPOP(3)	Fraction of refractory phosphorus routed to G3 sediment class	0.57 to 0.89 near fall line, 0.27 elsewhere
FRPPHx(1)	Fraction of algal group x phosphorus routed to G1 sediment class	0.65, all algal groups
FRPPHx(2)	Fraction of algal group x phosphorus routed to G2 sediment class	0.25, all algal groups
FRPPHx(3)	Fraction of algal group x phosphorus routed to G3 sediment class	0.10, all algal groups

## 7 Control File

---

The control file contains the parameters used to run CE-QUAL-ICM. It consists of card images 80 characters in length. The format of the input files has been developed in order to take advantage of a full-screen text editor. The control file begins with three lines which can be used for file identification and are ignored by the program. The rest of the file consists of a line which contains the card identification and the names of the FORTRAN variables associated with the input card. The FORTRAN names are right-justified according to the field widths associated with the input variable. The next line consists of the actual input values. There are 10 input fields associated with each card although the first field is not used. Each field has a length of eight characters. The next line is left blank for ease of display in a full-screen editor.

There are **no** optional cards in the control file - **each card is required** although there may be no values associated with the card. The following pages contain a description of each card. **All character inputs must be capitalized except the TITLE cards** or the variable will take on the **default** value.

## Title Cards (TITLE)

Field	Name	Value	Description
1-72	TITLE	Character	

Text for identification of simulation

There are six title cards that help identify the model run. Each line contains up to 72 characters of text. The title cards appear in every output file except for restarts. Uses for the title cards include identifying the application, the dates of the application, the date of the simulation, and any other information specific to the simulation.

### EXAMPLE

```
TITLE C .....Title.....  
Chesapeake Bay Water Quality control file input  
30 year run  
Using kinetic values from final calibration  
March 14, 1994  
Extra title line  
Extra title line
```

## Geometry Definition (GEOM DEFINE)

Field	Name	Value	Description
1	NB	Integer	Number of boxes in grid
2	NSB	Integer	Number of surface boxes in grid
3	NQF	Integer	Number of flow faces in grid
4	NHQF	Integer	Number of horizontal flow faces in grid
5	NSQF	Integer	Number of horizontal flow faces in surface layer of grid
6	NL	Integer	Maximum number of layers in grid

This card specifies the dimensions of the water quality model grid. The user must take care that the values specified here are consistent with corresponding PARAMETER statements in the file WQM\_COM.INC.

### EXAMPLE

```
GEOM DEFINE  NB      NSB      NQF      NHQF     NSHQF     NL
              30      10      51      31      10      3
```

## Time Control (TIME CON)

Field	Name	Value	Description
1	TMSTRT	Real	Starting simulation date (Julian day)
2	TMEND	Real	Ending simulation date (Julian day)

This card specifies the starting and ending dates of the simulation.

### EXAMPLE

```
TIME CON  TMSTRT  TMEND  
          0.0    365.0
```

## Number of Timestep Intervals (# DLT)

Field	Name	Value	Description
1	NDLT	Integer	Number of timestep intervals

The model provides the option to vary the time step. The time step may be varied through the autostepping option or at discrete, user-specified intervals. This card specifies the number of intervals in which the timestep, maximum timestep, and/or the fraction of the calculated timestep vary.

This card group establishes a pattern followed by successive groups which govern output. The first card establishes that time steps are assigned three times. The second card names the times as days 0, 120, and 250. The third card assigns a time step of 3600 seconds at day 0; 1800 seconds at day 120; 3600 seconds at day 250.

### EXAMPLE

```
# DLT      NDLT
           3
```

## Timestep Date (DLT DAY)

Field	Name	Value	Description
1	DLTDAY	Real	Date of timestep interval (Julian day)

This card specifies the intervals in which the timestep, maximum timestep, and/or fraction of the maximum calculated timestep may vary.

### EXAMPLE

DLT DAY	DLTD	DLTD	DLTD	DLTD	DLTD	DLTD	DLTD	DLTD	DLTD
	0.0	120.0	250.0						

## Timestep Value (DLT VAL)

Field	Name	Value	Description
1	DLTVAL	Real	Timestep (sec)

This card specifies the initial timestep if autostepping is used or the values for the timestep if autostepping is turned off.

### EXAMPLE

```
DLT VAL  DLTVAL  DLTVAL  DLTVAL  DLTVAL  DLTVAL  DLTVAL  DLTVAL  DLTVAL  DLTVAL
          3600.0  1800.0  3600.0
```



## Maximum Timestep (DLT MAX)

Field	Name	Value	Description
1	DLTMAX	Real	Maximum timestep (sec)

This card specifies the maximum value for the timestep if autostepping is turned on.

### EXAMPLE

```
DLT MAX  DLTMAX  DLTMAX  DLTMAX  DLTMAX  DLTMAX  DLTMAX  DLTMAX  DLTMAX  DLTMAX
          7200.0  7200.0  7200.0
```

## Timestep Fraction (DLT FTN)

Field	Name	Value	Description
1	DLTFTN	Real	Fraction of calculated timestep used

This card specifies the fraction of the timestep used if autostepping is turned on. The autostepping algorithm estimates the maximum timestep in order to maintain stability. Since this is an estimate, DLTFTN can be used to decrease the timestep if the model becomes unstable when autostepping is turned on.

### EXAMPLE

```
DLT FTN  DLTFTN  DLTFTN  DLTFTN  DLTFTN  DLTFTN  DLTFTN  DLTFTN  DLTFTN  DLTFTN
          0.95   0.80   0.95
```

## Hydrodynamic Model Timestep (HM DLT)

Field	Name	Value	Description
1	AHMDLT	Real	Hydrodynamic update interval (sec)
2	HMEND	Real	Ending date of hydrodynamic file (Julian day)

This card specifies the interval at which hydrodynamic information is input to the model. This information is employed only if "BINARY" or "DEPTH-AVERAGE" options are specified (see card HYD MODEL). The present formulation requires a constant update interval. The ending date of the hydrodynamic input (HMEND) is necessary to synchronize elapsed time in the model, time determined from hydrodynamic updates, and update times specified on various input files. If multiple hydrodynamic files are employed, they should be as close to one year in length as possible.

### EXAMPLE

```
HM DLT  AHMDLT  HMEND
          0.0  364.52
```

## Snapshot Output Control (SNAPSHOT)

Field	Name	Value	Description
1	SNPC	Character	Specifies if output is written to snapshot file
2	NSNP	Integer	Number of snapshot intervals

This card specifies if information is output to the snapshot file. The output interval is variable. The card also lists the number of intervals in which the frequency varies.

The first card in this card group indicates that snapshot frequency is specified four times. The second card indicates frequency is specified on days 0, 100, 101, and 200. The final card indicates snapshots are put out at a frequency of every 7 days starting at day 0; every 0.1 days starting at day 100; every 7 days starting at day 101; and every 1.0 days starting at day 200.

### EXAMPLE

```
SNAPSHOT  SNPC  NSNP
          ON    4
```

## Snapshot Date (SNAP DAY)

Field	Name	Value	Description
1-9	SNPD	Real	Date of snapshot interval (Julian day)

This card specifies the intervals at which the snapshot output varies. If there are more intervals than can be specified on one line, then they are continued on the next line.

### EXAMPLE

```
SNAP DAY  SNPD  SNPD  SNPD  SNPD  SNPD  SNPD  SNPD  SNPD  SNPD
           0.0  100.0  101.0  200.0
```

## Snapshot Frequency (SNAP FREQ)

Field	Name	Value	Description
1-9	SNPF	Real	Snapshot output frequency (Julian day)

This card specifies the frequency at which snapshot information is output. If there are more values than can be specified on one line, then they are continued on the next line.

### EXAMPLE

```
SNAP FREQ  SNPF  SNPF  SNPF  SNPF  SNPF  SNPF  SNPF  SNPF  SNPF
              7.0   0.1   7.0   1.0
```

## Plot Output Control (PLOT)

Field	Name	Value	Description
1	PLTC	Character	Specifies if output is written to plot file
2	QPLTC	Character	Specifies if water quality information is output
3	SPLTC	Character	Specifies if sediment information is output
4	NPLT	Integer	Number of plot intervals

This card specifies if information is output to the plot file and the number of intervals in which the frequency of the output varies.

### EXAMPLE

```
PLOT      PLTC  QPLTC  SPLTC  NPLT
          ON   ON    ON    4
```

## Plot Date (PLOT DAY)

Field	Name	Value	Description
1-9	PLTD	Real	Date of plot interval (Julian day)

This card specifies the intervals at which the plot output varies. If there are more intervals than can be specified on one line, then they are continued on the next line.

### EXAMPLE

PLOT DAY	PLTD	PLTD	PLTD	PLTD	PLTD	PLTD	PLTD	PLTD	PLTD
	0.0	100.0	101.0	200.0					



## Plot Frequency (PLOT FREQ)

Field	Name	Value	Description
1-9	PLTF	Real	Plot output frequency (Julian day)

This card specifies the frequency at which plot information is output. If there are more values than can be specified on one line, then they are continued on the next line.

### EXAMPLE

```
PLOT FREQ  PLTF  PLTF  PLTF  PLTF  PLTF  PLTF  PLTF  PLTF  PLTF
            7.0   0.1   7.0   1.0                
```

## Average Plot Output Control (AV PLOT)

Field	Name	Value	Description
1	APLC	Character	Specifies if output is written to average plot file
2	NAPL	Integer	Number of average plot intervals

This card specifies if information is output to the average plot file and the number of times at which averaging interval varies.

The first card in this card group indicates that averaging interval is specified four times. The second card indicates the interval is specified on days 0, 100, 101, and 200. The final card indicates the averaging interval is 7 days starting at day 0; 0.1 days starting at day 100; 7 days starting at day 101; and 1.0 days starting at day 200.

### EXAMPLE

```
AV PLOT      APLC      NAPL
              ON        4
```

## Average Plot Date (AVPLT DAY)

Field	Name	Value	Description
1-9	APLD	Real	Date of average plot interval (Julian day)

This card specifies the intervals at which the average plot output varies. If there are more intervals than can be specified on one line, then they are continued on the next line.

### EXAMPLE

AVPLT DAY	APLD	APLD	APLD	APLD	APLD	APLD	APLD	APLD	APLD
	0.0	100.0	101.0	200.0					

## Average Plot Frequency (AVPLT FREQ)

Field	Name	Value	Description
1-9	APLF	Real	Average plot output frequency (Julian day)

This card specifies the frequency at which average plot information is output. If there are more values than can be specified on one line, then they are continued on the next line.

### EXAMPLE

```
AVPLT FREQ  APLF  APLF  APLF  APLF  APLF  APLF  APLF  APLF  APLF
              7.0   0.1   7.0   1.0
```

## Transport Flux Output Control (TRAN FLUX)

Field	Name	Value	Description
1	TFLC	Character	Specifies if output is written to transport flux file
2	NTFL	Integer	Number of transport flux intervals

This card specifies if information is output to the transport flux file and the number of intervals in which the frequency of the output varies. Transport flux is averaged similar to the Average Plot file.

### EXAMPLE

```
TRAN FLUX  TFLC  NTFL  
            ON    4
```

## Transport Flux Date (FLUX DAY)

Field	Name	Value	Description
1-9	TFLD	Real	Date of transport flux interval (Julian day)

This card specifies the intervals at which the transport flux output varies. If there are more intervals than can be specified on one line, then they are continued on the next line.

### EXAMPLE

FLUX DAY	TFLD	TFLD	TFLD	TFLD	TFLD	TFLD	TFLD	TFLD	TFLD
	0.0	100.0	101.0	200.0					

## Transport Flux Frequency (FLUX FREQ)

Field	Name	Value	Description
1-9	TFLF	Real	Transport flux output frequency (Julian day)

This card specifies the frequency at which transport flux information is output. If there are more values than can be specified on one line, then they are continued on the next line.

### EXAMPLE

```
FLUX FREQ  TFLF  TFLF  TFLF  TFLF  TFLF  TFLF  TFLF  TFLF  TFLF
              7.0   0.1   7.0   1.0
```

## Kinetics Flux Output Control (KIN FLUX)

Field	Name	Value	Description
1	KFLC	Character	Specifies if output is written to kinetics flux file
2	NKFL	Integer	Number of kinetics flux intervals

This card specifies if information is output to the kinetics flux file and the number of intervals in which the frequency of the output varies. Kinetics fluxes are averaged similar to the Average Plot file

### EXAMPLE

```
TRAN FLUX  KFLC  NKFL  
            ON    4
```



## Kinetic Flux Date (FLUX DAY)

Field	Name	Value	Description
1-9	KFLD	Real	Date of kinetic flux interval (Julian day)

This card specifies the intervals at which the kinetic flux output varies. If there are more intervals than can be specified on one line, then they are continued on the next line.

### EXAMPLE

FLUX DAY	KFLD	KFLD	KFLD	KFLD	KFLD	KFLD	KFLD	KFLD	KFLD
	0.0	100.0	101.0	200.0					

## Kinetic Flux Frequency (FLUX FREQ)

Field	Name	Value	Description
1-9	KFLF	Real	Kinetic flux output frequency (Julian day)

This card specifies the frequency at which kinetic flux information is output. If there are more values than can be specified on one line, then they are continued on the next line.

### EXAMPLE

```
FLUX FREQ  KFLF  KFLF  KFLF  KFLF  KFLF  KFLF  KFLF  KFLF  KFLF
             7.0   0.1   7.0   1.0
```

## Oxygen Plot Output Control (OXY PLOT)

Field	Name	Value	Description
1	OPLC	Character	Specifies if output is written to oxygen plot file
2	NOPL	Integer	Number of oxygen plot intervals
3	NOINT	Integer	Number of oxygen concentration intervals

This card specifies if information is output to the oxygen plot file and the number of intervals in which the frequency of the output varies. In addition, it specifies the oxygen concentration ranges used in determining oxygen volume-days. Oxygen Plot output is averaged in a manner similar to the Average Plot file.

### EXAMPLE

```
OXY PLOT      OPLC      NOPL      NOINT
                ON         4         8
```

## Oxygen Intervals (OXY INT)

Field	Name	Value	Description
1-9	OINT	Real	Interval value for determining oxygen volume-days

This card specifies the concentration ranges used in determining oxygen volume-days. If there are more values than can be specified on one line, then they are continued on the next line.

### EXAMPLE

```
OXY INT      OINT      OINT      OINT      OINT      OINT      OINT      OINT      OINT      OINT
             -1.0      1.0       2.0       3.0       4.0       5.0       8.0      16.0
```

## Oxygen Plot Date (OXY DAY)

Field	Name	Value	Description
1-9	OPLD	Real	Date of oxygen plot interval (Julian day)

This card specifies the intervals at which the oxygen plot output varies. If there are more intervals than can be specified on one line, then they are continued on the next line.

### EXAMPLE

```
OXY DAY      OPLD      OPLD      OPLD      OPLD      OPLD      OPLD      OPLD      OPLD      OPLD
              0.0      100.0     101.0     200.0
```

## Oxygen Plot Frequency (OXY FREQ)

Field	Name	Value	Description
1-9	OPLF	Real	Oxygen plot output frequency (Julian day)

This card specifies the frequency at which oxygen plot information is output. If there are more values than can be specified on one line, then they are continued on the next line.

### EXAMPLE

```
OXY FREQ      OPLF      OPLF      OPLF      OPLF      OPLF      OPLF      OPLF      OPLF
                7.0        0.1        7.0        1.0
```

## Mass Balance Output Control (MASS BAL)

Field	Name	Value	Description
1	MBLC	Character	Specifies if output is written to mass balance file
2	NMBL	Integer	Number of mass balance intervals

This card specifies if mass balances are computed and the number of intervals in which the frequency of the output varies. Mass balances are averaged in a manner similar to the Average Plot file.

### EXAMPLE

```
MASS BAL      MBLC      NMBL
              ON        4
```

## Mass Balance Date (MBL DAY)

Field	Name	Value	Description
1-9	MBLD	Real	Date of mass balance interval (Julian day)

This card specifies the intervals at which the mass balance output varies. If there are more intervals than can be specified on one line, then they are continued on the next line.

### EXAMPLE

MBL DAY	MBLD	MBLD	MBLD	MBLD	MBLD	MBLD	MBLD	MBLD	MBLD
	0.0	100.0	101.0	200.0					



## Mass Balance Frequency (MBL FREQ)

Field	Name	Value	Description
1-9	MBLF	Real	Mass balance output frequency (Julian day)

This card specifies the frequency at which mass balance information is output. If there are more values than can be specified on one line, then they are continued on the next line.

### EXAMPLE

```
MBL FREQ      MBLF  MBLF  MBLF  MBLF  MBLF  MBLF  MBLF  MBLF  MBLF
              7.0   0.1   7.0   1.0
```

## Diagnostics Output Control (DIAGNSTCS)

Field	Name	Value	Description
1	DIAC	Character	Specifies if output is written to diagnostic file
2	NDIA	Integer	Number of diagnostic intervals

This card specifies if information is output to the diagnostics file and the number of intervals in which the frequency of the output varies.

### EXAMPLE

```
DIAGNSTCS  DIAC  NDIA  
            ON   4
```

## Diagnostics Date (DIA DAY)

Field	Name	Value	Description
1-9	DIAD	Real	Date of diagnostics interval (Julian day)

This card specifies the intervals at which the diagnostics output varies. If there are more intervals than can be specified on one line, then they are continued on the next line.

### EXAMPLE

```
DIA DAY      DIAD      DIAD      DIAD      DIAD      DIAD      DIAD      DIAD      DIAD
              0.0      100.0     101.0     200.0
```

## Diagnostic Frequency (DIA FREQ)

Field	Name	Value	Description
1-9	DIAF	Real	Diagnostics output frequency (Julian day)

This card specifies the frequency at which diagnostics information is output. If there are more values than can be specified on one line, then they are continued on the next line.

### EXAMPLE

```
DIA FREQ      DIAF  DIAF  DIAF  DIAF  DIAF  DIAF  DIAF  DIAF  DIAF
              7.0   0.1   7.0   1.0
```

## Restart Output (RESTART)

Field	Name	Value	Description
1	RSOC	Character	Specifies if output is written to restart file
2	NRSO	Integer	Number of restart output dates
3	RSIC	Character	Specifies if present simulation is generated from a restart file

### EXAMPLE

```
RESTART      RSOC      NRSO      RSIC
              OFF        1         OFF
```

## Restart Date (RST DAY)

Field	Name	Value	Description
1-9	RSOD	Real	Date of restart output (Julian day)

This card specifies the days at which restart information is output. If there are more restarts than can be specified on one line, then they are continued on the next line.

### EXAMPLE

```
RST DAY  RSOD  RSOD  RSOD  RSOD  RSOD  RSOD  RSOD  RSOD  RSOD
          100.0
```

## Hydrodynamic Model (HYD MODEL)

Field	Name	Value	Description
1	HYDC	Character	Specifies the type of hydrodynamic model input

This card specifies the nature of hydrodynamic inputs to the water quality model. There are three options: "BINARY," "ASCII," and "DEPTH\_AV." The BINARY option is usually specified for large files generated by a hydrodynamic model, e.g. CH3D-WES. The ASCII option is usually specified for smaller files which are created independent of a hydrodynamic model. The DEPTH\_AV option indicates a two-dimensional (longitudinal-lateral) implementation of the water quality model with binary input format.

### EXAMPLE

```
HYD MODEL    HYDC  
              BINARY
```

## Hydrodynamic Solution (HYD SOLTN)

Field	Name	Value	Description
1	SLC	Character	Specifies the type of transport solution
2	CONSC	Character	Specifies the type of conservation used
3	TH	Real	Crank-Nicholson weighting factor

This card allows the user to specify the type of longitudinal transport scheme that the water quality model uses, how mass is conserved, and the amount of implicit /explicit weighting used in vertical transport. The options for the longitudinal transport scheme are "UPWIND" and "QUICKEST." The upwind option is numerically diffusive which can cause problems during calibration. The QUICKEST option reduces numerical diffusion but can cause overshoots and undershoots in regions of sharp gradients. The model has the capability to use different hydrodynamic files over the period of a simulation. If the hydrodynamic files are disjointed (not continuous in time), the total volume of the system can change when a new hydrodynamic file is used. The abrupt change in volume may cause mass-balance errors in the water quality model. The user can specify if either mass ("MASS") or concentration ("CONC") is conserved when hydrodynamic files are spanned. Theta ("TH") specifies the amount of explicit /implicit time weighting in the vertical transport scheme. A value of zero is fully explicit and a value of one is fully implicit.

### EXAMPLE

```
HYD SOLTN  SLC  CONSC  TH
           QUICKEST  MASS  1.0
```



## Miscellaneous Controls (CONTROLS)

Field	Name	Value	Description
1	SEDC	Character	Turns on/off predictive sediment submodel
2	AUTO	Character	Turns on/off autostepping
3	VBC	Character	Turns on/off volume balance calculations
4	BFOC	Character	Turns on/off output of benthic model parameters and fluxes to designated output file
5	STLC	Character	Turns on/off particle settling
6	ICIC	Character	Specifies format of initial conditions
7	ICOC	Character	Specifies if initial conditions are created for use in a subsequent model run

The first five fields must be specified as "ON" or "OFF." The sixth field may be "UNIFORM," "VARIED," OR "BINARY." Descriptions of these options are provided in the description of the Initial Conditions File. The last field must be specified as "ON," or "OFF."

### EXAMPLE

```

CONTROLS      SEDC  AUTO  VBC  BFOC  STLC  ICIC  ICOC
              ON   OFF  OFF  OFF   ON  UNIFORM  OFF
  
```

## Dead Sea Case (DEAD SEA)

Field	Name	Value	Description
1	FLC	Character	Turns on/off hydrodynamic flows
2	XYDFC	Character	Turns on/off horizontal diffusion
3	ZDFC	Character	Turns on/off vertical diffusion

This card allows the user to turn off any or all transport processes in the model. All fields must be specified as "ON" or "OFF."

### EXAMPLE

```
DEAD SEA    FLC    XYDFC    ZDFC
            ON     ON     ON
```

## Horizontal Diffusion (HDIFF)

Field	Name	Value	Description
1	XYDF	Real	Value for horizontal diffusion ( $\text{m}^2 \text{s}^{-1}$ )
2	ZDFMUL	Real	Multiplier for vertical diffusion
3	ZDFMAX	Real	Maximum vertical diffusion ( $\text{m}^2 \text{s}^{-1}$ )

The first application of the water quality model was in a system with negligible horizontal dispersion. To minimize the size of the hydrodynamic file, dispersion was specified once in the control file rather than written out by the hydrodynamic model at every cell interface, at every time step. This feature is still in place when the BINARY or DEPTH\_AV hydrodynamic options are employed. Spatially variable dispersion is a feature of the model code but the user must perform revisions to read dispersion in binary format. When the ASCII option is employed, spatially and temporally varying horizontal dispersion is specified in the hydrodynamic file and the field on this card is ignored.

In the first application of the model, sensitivity runs were performed with varying vertical diffusion. To avoid running the hydrodynamic model repeatedly, a vertical diffusion multiplier was installed in the water quality model. For similar reasons, specification of maximum vertical diffusion was allowed.

### EXAMPLE

```
HDIFF      XYDF  ZDFMUL  ZDFMAX
           10.0    1.0    0.1
```

## Constituent Input (CST INPUT)

Field	Name	Value	Description
1	BCC	Character	Turns on/off boundary inputs
2	S1C	Character	Turns on/off first external load file
3	S2C	Character	Turns on/off second external load file
4	MDC	Character	Turns on/off modifications to initial concentrations
5	BFC	Character	Turns on/off specified benthic fluxes
6	ATMC	Character	Turns on/off atmospheric inputs
7	SAVC	Character	Turns on/off submerged aquatic plant inputs

This card allows the user to selectively turn on/off constituent inputs. All fields must be specified as "ON" or "OFF."

### EXAMPLE

CST INPUT	BCC	S1C	S2C	MDC	BFC	ATMC	SAVC
	ON	OFF	OFF	OFF	OFF	ON	OFF

## Nutrient Reductions (NUTR RED)

Field	Name	Value	Description
1	REDS1C	Real	Modifies S1 carbon inputs
2	REDS1N	Real	Modifies S1 nitrogen inputs
3	REDS1P	Real	Modifies S1 phosphorus inputs
4	REDS2C	Real	Modifies S2 carbon inputs
5	REDS2N	Real	Modifies S2 nitrogen inputs
6	REDS2P	Real	Modifies S2 phosphorus inputs
7	REDCBC	Real	Modifies boundary carbon inputs
8	REDCBN	Real	Modifies boundary nitrogen inputs
9	REDCBP	Real	Modifies boundary phosphorus inputs

This card allows the user to selectively modify nutrient loads and boundary conditions. Values in the input files are multiplied by the fraction specified on this card. Specification of zero eliminates input values. Specification of unity leaves input values as in the original files. This feature is useful in preliminary investigations of nutrient reduction strategies.

### EXAMPLE

```
NUTR RED  REDPSC  REDPSN  REDPSP  REDNPC  REDNPN  REDNPP  REDCBC  REDCBN  REDCBP
          1.0    1.0    1.0    1.0    1.0    1.0    1.0    1.0    1.0
```

## Boundary Concentrations (BOUNDARY)

Field	Name	Value	Description
1	BNDTC	Character	Specifies how boundary concentrations are handled

This card specifies if input boundary concentrations are updated when the next value is read in from the time-varying data file or if the concentrations are interpolated for each timestep. The inputs are "STEP" or "INTERP." Information regarding these options is found in Chapter 2.

### EXAMPLE

```
BOUNDARY  BNDTC  
          STEP
```

## Boundary Solution (BOUNDARY)

Field	Name	Value	Description
1-22	BNDSC	Character	Specifies how boundary concentration are calculated

This card allows the user to specify how boundary concentrations are handled by the transport scheme. The values can be "UPWIND," "EXTRAP," or "REFLECT." Information regarding these options is found in Chapter 2.

### EXAMPLE

```
BOUNDARY  BNDSC  BNDSC  BNDSC  BNDSC  BNDSC  BNDSC  BNDSC  BNDSC  BNDSC
          UPWIND UPWIND UPWIND UPWIND UPWIND UPWIND UPWIND UPWIND UPWIND
          UPWIND UPWIND UPWIND UPWIND UPWIND UPWIND UPWIND UPWIND UPWIND
          UPWIND UPWIND UPWIND UPWIND
```

## Active Constituents (ACT CST)

Field	Name	Value	Description
1-22	ACC	Character	Turns on/off constituent calculations

This card allows the user to turn on/off a state variable for a simulation. Care must be taken when exercising this option because of the interaction of the state variables in the kinetic formulations. Most commonly, this option is used when initially calibrating the water quality model transport to the hydrodynamic model transport using salinity. This option turns off computations only. All state variables must still be included in load files, boundary conditions, etc. The state variables and their order are

- 1 Temperature
- 2 Salinity
- 3 Iron + Manganese (or suspended solids)
- 4 Cyanobacteria
- 5 Diatoms
- 6 Green algae
- 7 Dissolved organic carbon
- 8 Labile particulate carbon
- 9 Refractory particulate carbon
- 10 Ammonium
- 11 Nitrate-nitrite
- 12 Dissolved organic nitrogen
- 13 Labile particulate nitrogen
- 14 Refractory particulate nitrogen
- 15 Total phosphate
- 16 Dissolved organic phosphorus
- 17 Labile particulate phosphorus
- 18 Refractory particulate phosphorus
- 19 Chemical oxygen demand
- 20 Dissolved oxygen
- 21 Particulate silica
- 22 Dissolved silica

### EXAMPLE

ACT CST	ACC	ACC	ACC	ACC	ACC	ACC	ACC	ACC	ACC
	ON	ON	ON	ON	ON	ON	ON	ON	ON
	ON	ON	ON	ON	ON	ON	ON	ON	ON
	ON	ON	ON	ON					



## Half-Saturation Constants (HALF SAT 1)

Field	Name	Value	Description
1	KHONT	Real	Concentration of DO required for nitrification
2	KHNNT	Real	Concentration of ammonia required for nitrification
3	KHNC	Real	Constant for cyanobacteria nitrogen uptake
4	KHPC	Real	Constant for cyanobacteria phosphorus uptake
5	KHRC	Real	Constant for cyanobacteria DOC excretion
6	KHND	Real	Constant for diatom nitrogen uptake
7	KHPD	Real	Constant for diatom phosphorus uptake
8	KHRD	Real	Constant for diatom DOC excretion
9	KHSD	Real	Constant for silica uptake by diatoms

This card and the following card specify the half-saturation constants used in the kinetic formulations. Definitions of these parameters are found in Chapter 3. Suggested values are presented in Chapter 5.

### EXAMPLE

HALF SAT 1	KHONT	KHNNT	KHNC	KHPC	KHRC	KHND	KHPD	KHRD	KHSD
	1.0	1.0	0.01	0.001	0.5	0.01	0.001	0.5	0.03

## Half-Saturation Constants (HALF SAT 2)

Field	Name	Value	Description
1	KHNG	Real	Constant for green algae nitrogen uptake
2	KHPG	Real	Constant for green algae phosphorus uptake
3	KHRG	Real	Constant for green algae DOC excretion
4	KHOCOD	Real	Concentration of DO needed for COD exertion
5	KHODOC	Real	Concentration of DO required for oxic respiration
6	KHNDN	Real	Concentration of nitrogen required for denitrification

### EXAMPLE

HALF SAT 2	KHNG	KHPG	KHRG	KHOCOD	KHODOC	KHNDN
	0.01	0.001	0.5	0.5	0.5	0.1

## Ratios (RATIOS)

Field	Name	Value	Description
1	AOCR	Real	Dissolved oxygen-to-carbon ratio in respiration
2	AONT	Real	Mass dissolved oxygen consumed per mass ammonium nitrified
3	ANCC	Real	Nitrogen-to-carbon ratio for cyanobacteria
4	ANCD	Real	Nitrogen to-carbon ratio for diatoms
5	ASCD	Real	Silica-to-carbon ration for diatoms
6	ANCG	Real	Nitrogen-to-carbon ration for green algae
7	ANDC	Real	Mass dissolved oxygen reduced per mass DOC oxidized

This card specifies ratios used in the kinetic formulations. Definitions of these ratios are found in Chapter 3. Suggested values are presented in Chapter 5.

### EXAMPLE

RATIOS	AOCR	AONT	ANCC	ANCD	ASCD	ANCG	ANDC
	2.67	4.33	0.167	0.167	0.4	0.167	0.933

## Phosphorus to Carbon Coefficients (P TO C)

Field	Name	Value	Description
1	PCPRM1	Real	Constant used in determining phosphorus-to-carbon ratio
2	PCPRM2	Real	Constant used in determining phosphorus-to-carbon ratio
3	PCPRM3	Real	Constant used in determining phosphorus-to-carbon ratio

This card provides parameters for the variable phosphorus stoichiometry described in Equation 3-30. Constant stoichiometry can be employed by setting  $PCPRM2 = 0$ .

### EXAMPLE

```
P TO C   PCPRM1  PCPRM2  PCPRM3
          42.0    85.0    200.0
```

## Nitrogen Recycling Fractions (FRACTN N 1)

Field	Name	Value	Description
1	FNIC	Real	Fraction of inorganic nitrogen produced by cyanobacteria
2	FNDC	Real	Fraction of DON produced by cyanobacteria
3	FNLC	Real	Fraction of labile PON produced by cyanobacteria
4	FNRC	Real	Fraction of refractory PON produced by cyanobacteria
5	FNID	Real	Fraction of inorganic nitrogen produced by diatoms
6	FNDD	Real	Fraction of DON produced by diatoms
7	FNLD	Real	Fraction of labile PON produced by diatoms
8	FNRD	Real	Fraction of refractory PON produced by diatoms
9	FNIG	Real	Fraction of inorganic nitrogen produced by green algae

This card and the following card specify the nitrogen fractions produced by various kinetic processes. Definitions of these fractions are found in Chapter 3. Suggested values are presented in Chapter 5.

### EXAMPLE

FRACTN N 1	FNIC	FNDC	FNLC	FNRC	FNID	FNDD	FNLD	FNRD	FNIG
	0.0	1.0	0.0	0.0	0.0	1.0	0.0	0.0	0.0

## Nitrogen Recycling Fractions (FRACTN N 2)

Field	Name	Value	Description
1	FNDG	Real	Fraction of DON produced by green algae
2	FNLG	Real	Fraction of labile PON produced by green algae
3	FNRG	Real	Fraction of refractory PON produced by green algae
4	FNIP	Real	Fraction of inorganic nitrogen produced by predation
5	FNDP	Real	Fraction of DON produced by predation
6	FNLP	Real	Fraction of labile PON produced by predation
7	FNRP	Real	Fraction of refractory PON produced by predation

### EXAMPLE

FRACTN N 2	FNDG	FNLG	FNRG	FNIP	FNDP	FNLP	FNRP
	1.0	0.0	0.0	0.0	0.1	0.55	0.35

## Phosphorus Recycling Fractions (FRACTN P 1)

Field	Name	Value	Description
1	FPIC	Real	Fraction of inorganic phosphorus produced by cyanobacteria
2	FPDC	Real	Fraction of DOP produced by cyanobacteria
3	FPLC	Real	Fraction of labile POP produced by cyanobacteria
4	FPRC	Real	Fraction of refractory POP produced by cyanobacteria
5	FPID	Real	Fraction of inorganic phosphorus produced by diatoms
6	FPDD	Real	Fraction of DOP produced by diatoms
7	FPLD	Real	Fraction of labile POP produced by diatoms
8	FPRD	Real	Fraction of refractory POP produced by diatoms
9	FPIG	Real	Fraction of inorganic phosphorus produced by green algae

This card and the following card specify the phosphorus fractions produced by various kinetic processes. Definitions of these fractions are found in Chapter 3. Suggested values are presented in Chapter 5.

### EXAMPLE

FRACTN P 1	FPIC	FPDC	FPLC	FPRC	FPID	FPDD	FPLD	FPRD	FPIG
	0.0	1.0	0.0	0.0	0.0	1.0	0.0	0.0	0.0

## Phosphorus Recycling Fractions (FRACTN P 2)

Field	Name	Value	Description
1	FPDG	Real	Fraction of DOP produced by green algae
2	FPLG	Real	Fraction of labile POP produced by green algae
3	FPRG	Real	Fraction of refractory POP produced by green algae
4	FPIP	Real	Fraction of inorganic phosphorus produced by predation
5	FPDP	Real	Fraction of DOP produced by predation
6	FPLP	Real	Fraction of labile POP produced by predation
7	FPRP	Real	Fraction of refractory POP produced by predation

### EXAMPLE

FRACTN P 2	FPDG	FPLG	FPRG	FPIP	FPDP	FPLP	FPRP
	1.0	0.0	0.0	0.2	0.5	0.2	0.1



## Carbon Recycling Fractions (FRACTN C)

Field	Name	Value	Description
1	FCDC	Real	Fraction of DOC produced by cyanobacteria respiration
2	FCDD	Real	Fraction of DOC produced by diatom respiration
3	FCDG	Real	Fraction of DOC produced by green algal respiration
4	FDOP	Real	Fraction of algal carbon consumed immediately through respiration by predators
5	FCDP	Real	Fraction of DOC produced by predation
6	FCLP	Real	Fraction of labile POC produced by predation
7	FCRP	Real	Fraction of refractory POC produced by predation

This card specifies the carbon fractions produced by algal respiration and predation. Definitions of these fractions are found in Chapter 3. Suggested values are presented in Chapter 5.

### EXAMPLE

FRACTN C	FCDC	FCDD	FCDG	FDOP	FCDP	FCLP	FCRP
	0.0	0.0	0.0	0.0	0.1	0.55	0.35

## Reference Temperatures (REF T RESP)

Field	Name	Value	Description
1	TRC	Real	Reference temperature for cyanobacteria metabolism
2	TRD	Real	Reference temperature for diatom metabolism
3	TRG	Real	Reference temperature for green algae metabolism
4	TRCOD	Real	Reference temperature for COD
5	TRMNL	Real	Reference temperature for mineralization
6	TRHDR	Real	Reference temperature for hydrolysis
7	TSRUA	Real	Reference temperature for silica dissolution

This card specifies the reference temperatures for temperature-dependent processes in the kinetic formulations. Definitions of these parameters are found in Chapter 3. Suggested values are presented in Chapter 5.

### EXAMPLE

REF T RESP	TRC	TRD	TRG	TRCOD	TRMNL	TRHDR	TSRUA
	20.0	20.0	20.0	23.0	20.0	20.0	20.0

## Temperature Effects (TEMP EFF)

Field	Name	Value	Description
1	KTBC	Real	Temperature effect on cyanobacteria metabolism
2	KTBD	Real	Temperature effect on diatom metabolism
3	KTBG	Real	Temperature effect on green algae metabolism
4	KTCOD	Real	Temperature effect on chemical oxygen demand
5	KTMNL	Real	Temperature effect on mineralization
6	KTHDR	Real	Temperature effect on hydrolysis
7	KTSUA	Real	Temperature effect on silica dissolution rate

This card specifies the effect of temperature on metabolic rates, chemical oxygen demand, mineralization, hydrolysis, and silica dissolution. Definitions of these parameters are found in Chapter 3. Suggested values are presented in Chapter 5.

### EXAMPLE

TEMP EFF	KTBC	KTBD	KTBG	KTCOD	KTMNL	KTHDR	KTSUA
	0.069	0.069	0.069	0.041	0.069	0.069	0.092

## Suboptimal Temperature Effect (SUBOPT T)

Field	Name	Value	Description
1	KTNT1	Real	Suboptimal temperature effect on nitrification
2	KTGC1	Real	Suboptimal temperature effect on cyanobacteria growth
3	KTGD1	Real	Suboptimal temperature effect on diatom growth
4	KTGG1	Real	Suboptimal temperature effect on green algae growth

Nitrification and algal growth rates increase as a function of temperature until an optimum temperature is reached and then decline. This card specifies the effect of temperature below the optimal temperature on nitrification and algal growth. Definitions of these parameters are found in Chapter 3. Suggested values are presented in Chapter 5.

### EXAMPLE

```
SUBOPT T  KTNT1  KTGC1  KTGD1  KTGG1
           0.09   0.005  0.004  0.008
```

## Superoptimal Temperature Effects (SUOPT T)

Field	Name	Value	Description
1	KTNT2	Real	Superoptimal temperature effect on nitrification
2	KTGC2	Real	Superoptimal temperature effect on cyanobacteria growth
3	KTGD2	Real	Superoptimal temperature effect on diatom growth
4	KTGG2	Real	Superoptimal temperature effect on green algae growth

This card specifies the effect of temperature above the optimal temperature on nitrification and algal growth. Definitions of these parameters are found in Chapter 3. Suggested values are presented in Chapter 5.

### EXAMPLE

SUOPT T	KTNT2	KTGC2	KTGD2	KTGG2
	0.09	0.004	0.006	0.10

## Optimal Temperatures (MAX T)

Field	Name	Value	Description
1	TMNT	Real	Optimal temperature for nitrification
2	TMC	Real	Optimal temperature for cyanobacteria growth
3	TMD	Real	Optimal temperature for diatom growth
4	TMG	Real	Optimal temperature for green algae growth

This card specifies the optimal temperatures for nitrification and algal growth. Definitions of these parameters are found in Chapter 3. Suggested values are presented in Chapter 5.

### EXAMPLE

MAX T	TMNT	TMC	TMD	TMG
	30.0	27.5	20.0	25.0

## Predation Time Intervals (PREDATION)

Field	Name	Value	Description
1	NPRD	Integer	Number of predation time intervals

This card allows the user to specify the number of intervals in which the predation rate varies. This option allows specification of a piece-wise predation function. Piece-wise specification was required to calculate a spring algal bloom and lesser summer chlorophyll concentrations in Chesapeake Bay.

### EXAMPLE

```
PREDATION  NPRD  
              6
```

## Predation Interval Dates (PRED DAY)

Field	Name	Value	Description
1-9	PRDD	Real	Date of predation interval

This card specifies the dates at which the predation rates change. If there are more values than will fit on one line, then the values are continued on the next line.

### EXAMPLE

PRED DAY	PRDD	PRDD	PRDD	PRDD	PRDD	PRDD	PRDD	PRDD	PRDD
	0.0	152.0	365.0	517.0	730.0	882.0			



## Predation Rates (PRED VAL)

Field	Name	Value	Description
1-9	PRDVAL	Real	Predation rate

This card specifies the piece-wise predation rates. The predation function is:

$$PR = (1 - 0.7 PRDVAL) BPR$$

PR = predation rate

BPR = base predation rate

### EXAMPLE

PRED VAL	PRDVAL	PRDVAL	PRDVAL	PRDVAL	PRDVAL	PRDVAL	PRDVAL	PRDVAL	PRDVAL
	1.0	0.0	1.0	0.0	1.0	0.0			

## Macrobenthos (MACROBEN)

Field	Name	Value	Description
1	MBGM	Real	Macrobenthic biomass
2	FR	Real	Macrobenthic filtration rate
3	UCM	Real	Macrobenthic utilization of cyanobacteria
4	UDM	Real	Macrobenthic utilization of diatoms
5	UGM	Real	Macrobenthic utilization of green algae

This card specifies the input variables associated with macrobenthic grazing of phytoplankton. This option is included in the model code but has never been employed.

### EXAMPLE

MACROBEN	MBGM	FR	UCM	UDM	UGM
	0.0	1.0	0.0	0.0	0.0

## Light (LIGHT 1)

Field	Name	Value	Description
1	DOPTC	Real	Depth of optimum cyanobacteria production
2	DOPTD	Real	Depth of optimum diatom production
3	DOPTG	Real	Depth of optimum green algae production
4	FCYAN	Real	Factor to allow cyanobacteria mat formation
5	KECHL	Real	Light attenuation coefficient for chlorophyll <i>a</i>

This card specifies parameters which relate algal production to light. Definitions of these parameters are found in Chapter 3. Suggested values are presented in Chapter 5.

### EXAMPLE

LIGHT 1	DOPTC	DOPTD	DOPTG	FCYAN	KECHL
	1.0	1.0	1.0	1.0	17.0

## Light (LIGHT 2)

Field	Name	Value	Description
1	IO	Real	Initial daily illumination at water surface
2	ISMIN	Real	Minimum optimal illumination
3	IOWT	Real	Weighting factor for illumination at current day
4	I1WT	Real	Weighting factor for illumination one day preceding
5	I2WT	Real	Weighting factor for illumination two days preceding

Algae require time to adapt to light conditions. This is incorporated into the model by time-weighting the surface illumination over a three day period to produce an average daily illumination. This card allows the user to specify an initial daily surface illumination and weighting factors for the time averaging. In addition, a minimum optimal illumination can be specified so that algae do not thrive at low light levels. Definitions of these parameters are found in Chapter 3. Suggested values are presented in Chapter 5.

### EXAMPLE

```
LIGHT 2      IO  ISMIN  IOWT  I1WT  I2WT
              110.0  40.0   0.7   0.2   0.1
```

## Iron + Manganese (METALS)

Field	Name	Value	Description
1	KDOTAM	Real	Relates metal solubility to DO concentration
2	TAMDMX	Real	Metal solubility under anoxic conditions
3	BENTAM	Real	Benthic release rate
4	KTBMF	Real	Temperature coefficient for benthic metal release
5	KHBMF	Real	Half-saturation constant for benthic metal release

This card specifies values for coefficients affecting the total active metal state variable. Definitions of these parameters are found in Chapter 3. Suggested values are presented in Chapter 5.

### EXAMPLE

METALS	KDOTAM	TAMDMX	BENTAM	KTBMF	KHBMF
	1.0	0.015	0.0	0.2	0.5

## Partition Coefficients (SORPTION)

Field	Name	Value	Description
1	KADPO4	Real	Partition coefficient for sorbed vs. dissolved phosphate
2	KADSA	Real	Partition coefficient for sorbed vs. dissolved silica

This card specifies the partitioning coefficients for phosphorus and silica. Definitions of these parameters are found in Chapter 3. Suggested values are presented in Chapter 5.

### EXAMPLE

```
SORPTION  KADPO4  KADSA  
          0.0     0.0
```

## Carbon to Chlorophyll Ratios (CAR/CHL)

Field	Name	Value	Description
1	CCHLC	Real	Cyanobacteria carbon-to-chlorophyll ratio
2	CCHLD	Real	Diatom carbon-to-chlorophyll ratio
3	CCHLG	Real	Blue green carbon-to-chlorophyll ratio

This card specifies the carbon to chlorophyll ratios for the three algal groups. Suggested values are presented in Chapter 5.

### EXAMPLE

CAR/CHL	CCHLC	CCHLD	CCHLG
	60.0	60.0	60.0

## Miscellaneous Coefficients (MISC)

Field	Name	Value	Description
1	FSAP	Real	Fraction of diatom silica available from predation
2	SCTOX	Real	Salinity at which Microcystis growth is halved
3	AANOX	Real	Ratio of denitrification to oxic carbon respiration rate

This card specifies miscellaneous kinetic coefficients which did not fall into any of the other groups. Definitions of these parameters are found in Chapter 3. Suggested values are presented in Chapter 5.

### EXAMPLE

MISC	FSAP	SCTOX	AANOX
	0.0	1.0	0.5



## Number of Files (# FILES)

Field	Name	Value	Description
1	NHYDF	Integer	Number of hydrodynamic files in simulation
2	NTVDF	Integer	Number of time-varying data files in simulation

This card is used to specify the number of time-varying input files which will be used during the simulation. When the end of a file is reached during the simulation, a new file will be opened. For example, if NTVDF is set to 3, then a new file will be opened each time an end of file is reached until the third file is opened. If an end of file is reached for the last file, the run terminates. Potential time-varying input files are HYD through BFI listed on the next page.

### EXAMPLE

```
# FILES    NHYDF    NTVDF
           2         2
```

## Input/Output Filenames

Field	Name	Value	Description
1-9	"File"	Character	Input/output filename

The last cards in the control file specify the names of all input/output files used by the model. This method eliminates the need to know how to link FORTRAN files under a particular operating system. However, it does not preclude linking I/O files. If the user does decide to link files, they must be linked with the names specified by the user on the following cards. Under UNIX and VAX operating systems, full pathnames can be included in the filename specification. The names listed below are recommended from experience with the model. It is better to keep the names the same for all applications and put the I/O files in separate subdirectories with descriptive names. The number of hydrodynamic files listed under HYDFN must correspond to the number specified for NHYDF. The same holds true for the other time-varying input files. There must be the exact number specified by NTVDF.

### EXAMPLE

```

MAP FILE.....MAPFN.....
    map.npt

GEO FILE.....GEOFN.....
    geo.npt

ICI FILE.....ICIFN.....
    ici.npt

RSI FILE.....RSIFN.....
    rsi.npt

AGR FILE.....AGRFN.....
    agr.npt

STL FILE.....STLFN.....
    stl.npt

MRL FILE.....MRLFN.....
    mrl.npt

HYD FILE.....HYDFN.....
    hyd.npt
    hyd2.npt

MET FILE.....METFN.....
    met.npt
    met2.npt

S1 FILE.....S1 FN.....
    pts.npt
    pts2.npt

S2 FILE.....S2 FN.....
    nps.npt
    nps2.npt
  
```

ATM FILE.....ATMFN.....  
     atm.npt  
     atm2.npt

SAV FILE.....SAVFN.....  
     sav.npt  
     sav2.npt

EXT FILE.....EXTFN.....  
     ext.npt  
     ext2.npt

CBC FILE.....CBCFN.....  
     cbc.npt  
     cbc2.npt

BFI FILE.....BFIFN.....  
     bfi.npt  
     bfi2.npt

ICO FILE.....ICOFN.....  
     ico.opt

SNP FILE.....SNPFN.....  
     snp.opt

RSO FILE.....RSOFN.....  
     rso.opt

PLT FILE.....PLTFN.....  
     plt.opt

APL FILE.....APLFN.....  
     apl.opt

DIA FILE.....DIAFN.....  
     dia.opt

TFL FILE.....TFLFN.....  
     tfl.opt

KFL FILE.....KFLFN.....  
     kfl.opt

OPL FILE.....OPLFN.....  
     opl.opt

MBL FILE.....MBLFN.....  
     mbl.opt

BFO FILE.....BFOFN.....  
     bfo.opt

## 8 INCLUDE File

---

The vast majority of DIMENSION and COMMON statements are coded in a file WQM\_COM.INC. This file is incorporated into the main program and subroutines through the FORTRAN "INCLUDE" statement. Dimensions of most arrays are specified by the user through PARAMETER statements at the beginning of the INCLUDE file. Specification must take place prior to compilation of the program. For most arrays, dimensions must be greater than or equal to number of corresponding grid elements or model inputs. **For one parameter, NOBP, the dimension must correspond exactly to number of model inputs.** Variables in PARAMETER statements and their definitions are noted in Table 8-1.

The INCLUDE file contains the code:

```
C   REAL          MAXDLTDP, MXDLTDP, NXHYDDP
   DOUBLE PRECISION MAXDLTDP, MXDLTDP, NXHYDDP
   DOUBLE PRECISION V1, V2, ELTMS, ELTMS1
```

The DOUBLE PRECISION statements are required on 32-bit machines including most personal computers and many work stations (e.g. Silicon Graphics Indigo). The DOUBLE PRECISION statements are not required on 64-bit machines including Cray supercomputers and many newer work stations. For operation on 64-bit machines, the user may remove the "C" from the REAL statement and comment out or delete the DOUBLE PRECISION statements.

**Table 8-1**  
**Variables in PARAMETER Statements**

Variable	Definition
NCP	Number of model state variables. Do not alter the coded value NCP = 22.
NBP	Total number of cells in grid.
NQFP	Total number of flow faces.
NHQF	Number of horizontal flow faces.
NSBP	Number of model cells in surface layer.
NLP	Number of layers in vertical direction.
NS1P	Number of load sources specified in first external load file.
NS2P	Number of load sources specified in second external load file.
NBCP	Number of faces at which boundary conditions are specified.
NMP	Number of modifications to uniformly specified initial conditions.
NDP	Maximum number of days at which plot outputs and similar features are specified.
NSAVP	Number of model cells with submerged aquatic vegetation.
NFLP	Maximum number of time-varying input files.
NOIP	Maximum number of oxygen-plot intervals.
NOBP	Exact number of cell faces at open-ocean boundary. Required for mass-balance boundary conditions.

## 9 Map File

---

The map file specifies the linkage between faces and boxes, the number of vertical faces for each column in the water quality model, the vertical face numbers in each column, and the faces at the open-ocean boundary. Because of the nature of “box” models and the transport solution scheme employed in the model, a large amount of information must be specified in the map file.

In setting up the map file, the user must assign a face number to each face in a box. The only restriction in assigning face numbers is that all faces in the X and Y directions must be assigned a number before the vertical faces are assigned a number. Other than this restriction, there is no requirement that face numbers be assigned in any order.

Once the face numbers are assigned to the boxes, the user must specify the direction in which the faces are oriented and the surrounding box numbers. Faces in the X direction are assigned a flow direction of 1, faces in the Y direction are assigned a flow direction of 2, and faces in the Z direction are assigned a flow direction of 3.

The QUICKEST advection scheme uses a three-point interpolation scheme to estimate concentrations at a face. This requires that the solution scheme know the concentration in the two upstream boxes for a positive flow and the two downstream boxes for a negative flow. Thus, for each face, four box numbers are required. They are specified in relation to positive flow. The variables ILB, IB, JB, and JRB designate which is the next upstream box number, the box immediately upstream, the box immediately downstream, and the next downstream box. If one of these boxes for a given face lies outside the grid, the box number is assigned a value of zero. Faces that exist on an inflow or outflow boundary are defined, but the IB and ILB for positive inflow and the JB and JRB for positive outflow are assigned a value of zero.

The user is also required to specify the number of vertical faces in each column even if the model is in depth integrated mode. In addition, the user must specify the bottom box number of each column and the vertical face numbers in the column starting from the bottom face.

Finally, the user must specify the face numbers of cells located along open-ocean boundaries. This specification is required for the mass-balance boundary condition.

The first six lines of the map file are ignored and can be used to describe the file. The input formats are (6I8) for the faces and box associations, (11X,8I8) for the number of vertical faces in each column, and (9I8) for the vertical face numbers.

The following example is a 30-cell, two-dimensional grid (Figure 9-1). The grid contains 10 cells in the longitudinal direction, one cell in the lateral dimension, and three cells in the vertical. The grid contains one inflow boundary (Face 1) and three open-ocean boundaries (Faces 11, 21, 31).

1	1	2	2	3	3	4	4	5	5	6	6	7	7	8	8	9	9	10	10	11
	33		35		37		39		41		43		45		47		49		51	
	11	12	12	13	13	14	14	15	15	16	16	17	17	18	18	19	19	20	20	21
	32		34		36		38		40		42		44		46		48		50	
	21	22	22	23	23	24	24	25	25	26	26	27	27	28	28	29	29	30	30	31

1 Face Number      1 Cell Number

Figure 9-1. Elevation of 30-cell grid showing cell and face numbers

Chesapeake Bay mock up for teaching purposes.

SET UP August 10, 1992

dummy title

dummy title

dummy title

dummy title

F	QD	IL	IQ	JQ	JR
1	1	0	0	1	2
2	1	0	1	2	3
3	1	1	2	3	4
4	1	2	3	4	5
5	1	3	4	5	6
6	1	4	5	6	7
7	1	5	6	7	8
8	1	6	7	8	9
9	1	7	8	9	10
10	1	8	9	10	0
11	1	9	10	0	0
12	1	0	11	12	13
13	1	11	12	13	14
14	1	12	13	14	15
15	1	13	14	15	16
16	1	14	15	16	17
17	1	15	16	17	18
18	1	16	17	18	19
19	1	17	18	19	10
20	1	18	19	20	0
21	1	19	20	0	0
22	1	0	21	22	23
23	1	21	22	23	24
24	1	22	23	24	25
25	1	23	24	25	26
26	1	24	25	26	27
27	1	25	26	27	28
28	1	26	27	28	29
29	1	27	28	29	30
30	1	28	29	30	0
31	1	29	30	0	0
32	3	0	21	11	1
33	3	21	11	1	0
34	3	0	22	12	2
35	3	22	12	2	0
36	3	0	23	13	3
37	3	23	13	3	0
38	3	0	24	14	4
39	3	24	14	4	0
40	3	0	25	15	5
41	3	25	15	5	0
42	3	0	26	16	6
43	3	26	16	6	0
44	3	0	27	17	7
45	3	27	17	7	0
46	3	0	28	18	8
47	3	28	18	8	0
48	3	0	29	19	9
49	3	29	19	9	0
50	3	0	30	20	10
51	3	30	20	10	0



COLUMNS	NVF	NVF	NVF	NVF	NVF	NVF	NVF	NVF	NVF
1-9	2	2	2	2	2	2	2	2	2
	2	2							
BBX	VFN	VFN	VFN	VFN	VFN	VFN	VFN	VFN	VFN
21	32	33							
22	34	35							
23	36	37							
24	38	39							
25	40	41							
26	42	43							
27	44	45							
28	46	47							
29	48	49							
30	50	51							
OCEAN BOUND	OBP	OBP	OBP	OBP	OBP	OBP	OBP	OBP	OBP
	11	21	31						

# 10 Geometry File

---

The geometry file has two, alternate formats. The appropriate format depends on the form of hydrodynamic input. When ASCII hydrodynamics are input, the geometry file specifies cell dimensions, volumes, water-column depth to top of each cell, the cell number immediately above each cell, and the surface and bottom cell numbers in each column of cells. All dimensions are in meters. Cell geometry is invariant. When BINARY hydrodynamics are input, the geometry file specifies only the cell number immediately above each cell and the surface and bottom cell numbers in each column of cells. The remaining geometric information is input in the hydrodynamics file. This format allows cell geometry to vary due to changes in surface elevation.

Two examples follow. The first illustrates the ASCII hydrodynamic input option applied to the grid shown in Figure 9-1. Two title cards and two header cards are available for descriptive purposes but are ignored by the program. The format for the cell number, cell dimensions, volumes, cell depths, and upper cell number is (5X,3F15.0,F18.0,F12.0,I10). The format for the surface cell and bottom cell number is (2I10).

The second example is the geometry file for the same grid but with BINARY hydrodynamic input. The format to read the upper cell is (8X,I8). The first field lists each cell in the grid in sequential order but is ignored by the computer. The format to read surface and bottom cells in each column of cells is (2I8).

Mock up Chesapeake Bay for teaching purposes.  
 ASCII Hydrodynamics. August 10, 1992.

B	BL(1)	BL(2)	BL(3)	V1	ZD	BU
1	30000.0	20000.0	5.0	3.0E9	0.0	0
2	30000.0	20000.0	5.0	3.0E9	0.0	0
3	30000.0	20000.0	5.0	3.0E9	0.0	0
4	30000.0	20000.0	5.0	3.0E9	0.0	0
5	30000.0	20000.0	5.0	3.0E9	0.0	0
6	30000.0	20000.0	5.0	3.0E9	0.0	0
7	30000.0	20000.0	5.0	3.0E9	0.0	0
8	30000.0	20000.0	5.0	3.0E9	0.0	0
9	30000.0	20000.0	5.0	3.0E9	0.0	0
10	30000.0	20000.0	5.0	3.0E9	0.0	0
11	30000.0	20000.0	5.0	3.0E9	5.0	1
12	30000.0	20000.0	5.0	3.0E9	5.0	2
13	30000.0	20000.0	5.0	3.0E9	5.0	3
14	30000.0	20000.0	5.0	3.0E9	5.0	4
15	30000.0	20000.0	5.0	3.0E9	5.0	5
16	30000.0	20000.0	5.0	3.0E9	5.0	6
17	30000.0	20000.0	5.0	3.0E9	5.0	7
18	30000.0	20000.0	5.0	3.0E9	5.0	8
19	30000.0	20000.0	5.0	3.0E9	5.0	9
20	30000.0	20000.0	5.0	3.0E9	5.0	10
21	30000.0	20000.0	5.0	3.0E9	10.0	11
22	30000.0	20000.0	5.0	3.0E9	10.0	12
23	30000.0	20000.0	5.0	3.0E9	10.0	13
24	30000.0	20000.0	5.0	3.0E9	10.0	14
25	30000.0	20000.0	5.0	3.0E9	10.0	15
26	30000.0	20000.0	5.0	3.0E9	10.0	16
27	30000.0	20000.0	5.0	3.0E9	10.0	17
28	30000.0	20000.0	5.0	3.0E9	10.0	18
29	30000.0	20000.0	5.0	3.0E9	10.0	19
30	30000.0	20000.0	5.0	3.0E9	10.0	20

SB	BBX
1	21
2	22
3	23
4	24
5	25
6	26
7	27
8	28
9	29
10	30

Mock up Chesapeake Bay for teaching purposes.  
BINARY Hydrodynamics. March 17, 1994.

B	BUP
1	0
2	0
3	0
4	0
5	0
6	0
7	0
8	0
9	0
10	0
11	1
12	2
13	3
14	4
15	5
16	6
17	7
18	8
19	9
20	10
21	11
22	12
23	13
24	14
25	15
26	16
27	17
28	18
29	19
30	20

sbox	bbox
1	21
2	22
3	23
4	24
5	25
6	26
7	27
8	28
9	29
10	30

# 11 Initial Conditions File

---

The Initial Conditions File has three, alternate formats. The appropriate format depends on the initial conditions option specified in the Control File. The options are "UNIFORM," "VARIED," and "BINARY." The UNIFORM option supplies uniform concentrations to each cell in the water column and sediments. (Modifications to the uniform conditions may be specified.) The VARIED option requires specification, in ASCII, of initial concentration in every water column and sediment cell. The BINARY option requires specification, in binary, of initial concentration in every water column and sediment cell. In typical application of the model, uniform conditions are specified for the first model run. After sufficient "spin up" time, model results are output, in ASCII or binary, and employed as initial conditions in subsequent model runs. The format of the ASCII input is identical to the format of output to the Snapshot File so that snapshots at any time interval can be cut from the Snapshot File and used as initial conditions.

The first example provided is for specification of uniform initial conditions for the 30-cell grid shown in Figure 9-1. The input format for all cards is (8X,9I8 or 9F8.0). Three title cards are available for identifying the file.

## EXAMPLE

```
Initial conditions for thirty segment bay mockup
Includes modifications for initial sediment conditions
August 15, 1992
```

## Initial Concentrations (INIT CONC)

Field	Name	Value	Description
1-22	CIC	Real	Initial concentrations

This card specifies initial water-column concentrations for each of the water-column state variables.

### EXAMPLE

INIT CONC	CIC	CIC	CIC	CIC	CIC	CIC	CIC	CIC	CIC
	5.0	25.0	0.0	0.0	0.1	0.1	1.0	1.0	1.0
	1.0	1.0	1.0	1.0	1.0	1.0	1.0	1.0	1.0
	1.0	8.0	1.0	1.0					

## Initial Sediment Concentrations (INIT SEDC)

Field	Name	Value	Description
1	CTEMP	Real	Initial sediment temperature
1	CPOP1	Real	Initial G1 particulate phosphorus concentration
2	CPOP2	Real	Initial G2 particulate phosphorus concentration
3	CPOP3	Real	Initial G3 particulate phosphorus concentration
1	CPON1	Real	Initial G1 particulate nitrogen concentration
2	CPON2	Real	Initial G2 particulate nitrogen concentration
3	CPON3	Real	Initial G3 particulate nitrogen concentration
1	CPOC1	Real	Initial G1 particulate carbon concentration
2	CPOC2	Real	Initial G2 particulate carbon concentration
3	CPOC3	Real	Initial G3 particulate carbon concentration
1	CPOS	Real	Initial particulate biogenic silica concentration
2	PO4T2	Real	Initial phosphate concentration
3	NH4T2	Real	Initial ammonium concentration
4	NO3T2	Real	Initial nitrate concentration
5	HST2	Real	Initial sulfide concentration
6	SIT2	Real	Initial dissolved silica concentration
7	BENST	Real	Initial benthic stress

This card specifies the initial sediment concentrations. This card is required only if the predictive sediment model is employed.

**EXAMPLE**

```
INIT SEDS  CTEMP
           25.0

           CPOP1  CPOP2  CPOP3
           1000.  10000.  75000.

           CPON1  CPON2  CPON3
           10000. 200000. 750000.

           CPOC1  CPOC2  CPOC3
           50000. 800000.  5.E6

           CPOS   PO4T2  NH4T2  NO3T2  HST2  SIT2  BENST
           5.E6  50000.  5000.   50.    2000. 75000.  20.
```



## Number of Modifications (# MOD)

Field	Name	Value	Description
1-22	NMOD	Integer	Specifies number of cells to modify initial concentrations

This card specifies how many cells will have their initial concentrations modified for each water-column state variable. Typically, modifications are employed to simulate dye injections and in mass-conservation studies.

### EXAMPLE

# MOD	NMOD	NMOD	NMOD	NMOD	NMOD	NMOD	NMOD	NMOD	NMOD
	3	0	0	0	0	0	0	0	0
	0	0	0	0	0	0	0	0	0
	0	0	0	0					

## Box Number of Modification

Field	Name	Value	Description
1-9	BMOD	Integer	Cell in which concentration is modified

This card contains the cell number of the constituent to be modified. If there are no modifications to be made, the value for the cell number can be left blank or a zero value may be entered. The number of values entered must correspond to the value given for NMOD on the previous card.

### EXAMPLE

```
T      BMOD  BMOD  BMOD  BMOD  BMOD  BMOD  BMOD  BMOD  BMOD
      1      5      10
```

The next card goes in tandem with the box number card.

## Concentration Modification

Field	Name	Value	Description
1-9	CMOD	Real	Value of modified concentration

This card specifies the value of the modified concentration for the cell number listed in the previous card.

### EXAMPLE

```
CMOD  CMOD  CMOD  CMOD  CMOD  CMOD  CMOD  CMOD  CMOD
30.0  30.0  30.0
```

As stated previously, these two cards go in tandem for each constituent. The remaining cards are the same as the previous example except for a different constituent.

## Example of Uniform Input File

The following example illustrates the complete initial conditions file when uniform conditions are specified.

INITIAL CONDITIONS FOR THIRTY-SEGMENT BAY MOCKUP.  
INCLUDES MOD FOR INITIAL SEDIMENT CONDITIONS. AUGUST 11, 1992

INIT CONC	CIC	CIC	CIC	CIC	CIC	CIC	CIC	CIC	CIC
	5.0	25.0	0.0	0.0	0.1	0.1	1.0	1.0	1.0
	1.0	1.0	1.0	1.0	1.0	1.0	1.0	1.0	1.0
	1.0	8.0	1.0	1.0					
INIT SEDS	CTEMP								
	20.0								
	CPOP1	CPOP2	CPOP3						
	1000.	10000.	75000.						
	CPON1	CPON2	CPON3						
	10000.	200000.	750000.						
	CPOC1	CPOC2	CPOC3						
	50000.	800000.	5.E6						
	CPOS	PO4T2	NH4T2	NO3T2	HST2	SIT2	BENST		
	5.E6	50000.	5000.	50.	2000.	75000.	20.		
# MOD	NMOD	NMOD	NMOD	NMOD	NMOD	NMOD	NMOD	NMOD	NMOD
	0	0	0	0	0	0	0	0	0
	0	0	0	0	0	0	0	0	0
	0	0	0	0					
T	BMOD	BMOD	BMOD	BMOD	BMOD	BMOD	BMOD	BMOD	BMOD
	CMOD	CMOD	CMOD	CMOD	CMOD	CMOD	CMOD	CMOD	CMOD
SALT	BMOD	BMOD	BMOD	BMOD	BMOD	BMOD	BMOD	BMOD	BMOD
	CMOD	CMOD	CMOD	CMOD	CMOD	CMOD	CMOD	CMOD	CMOD
SSI	BMOD	BMOD	BMOD	BMOD	BMOD	BMOD	BMOD	BMOD	BMOD
	CMOD	CMOD	CMOD	CMOD	CMOD	CMOD	CMOD	CMOD	CMOD
BC	BMOD	BMOD	BMOD	BMOD	BMOD	BMOD	BMOD	BMOD	BMOD
	CMOD	CMOD	CMOD	CMOD	CMOD	CMOD	CMOD	CMOD	CMOD
BD	BMOD	BMOD	BMOD	BMOD	BMOD	BMOD	BMOD	BMOD	BMOD
	CMOD	CMOD	CMOD	CMOD	CMOD	CMOD	CMOD	CMOD	CMOD
BG	BMOD	BMOD	BMOD	BMOD	BMOD	BMOD	BMOD	BMOD	BMOD
	CMOD	CMOD	CMOD	CMOD	CMOD	CMOD	CMOD	CMOD	CMOD

DOC	BMOD	BMOD	BMOD	BMOD	BMOD	BMOD	BMOD	BMOD	BMOD
	CMOD	CMOD	CMOD	CMOD	CMOD	CMOD	CMOD	CMOD	CMOD
LPOC	BMOD	BMOD	BMOD	BMOD	BMOD	BMOD	BMOD	BMOD	BMOD
	CMOD	CMOD	CMOD	CMOD	CMOD	CMOD	CMOD	CMOD	CMOD
RPOC	BMOD	BMOD	BMOD	BMOD	BMOD	BMOD	BMOD	BMOD	BMOD
	CMOD	CMOD	CMOD	CMOD	CMOD	CMOD	CMOD	CMOD	CMOD
NH4	BMOD	BMOD	BMOD	BMOD	BMOD	BMOD	BMOD	BMOD	BMOD
	CMOD	CMOD	CMOD	CMOD	CMOD	CMOD	CMOD	CMOD	CMOD
NO3	BMOD	BMOD	BMOD	BMOD	BMOD	BMOD	BMOD	BMOD	BMOD
	CMOD	CMOD	CMOD	CMOD	CMOD	CMOD	CMOD	CMOD	CMOD
DON	BMOD	BMOD	BMOD	BMOD	BMOD	BMOD	BMOD	BMOD	BMOD
	CMOD	CMOD	CMOD	CMOD	CMOD	CMOD	CMOD	CMOD	CMOD
LPON	BMOD	BMOD	BMOD	BMOD	BMOD	BMOD	BMOD	BMOD	BMOD
	CMOD	CMOD	CMOD	CMOD	CMOD	CMOD	CMOD	CMOD	CMOD
RPON	BMOD	BMOD	BMOD	BMOD	BMOD	BMOD	BMOD	BMOD	BMOD
	CMOD	CMOD	CMOD	CMOD	CMOD	CMOD	CMOD	CMOD	CMOD
PO4	BMOD	BMOD	BMOD	BMOD	BMOD	BMOD	BMOD	BMOD	BMOD
	CMOD	CMOD	CMOD	CMOD	CMOD	CMOD	CMOD	CMOD	CMOD
DOP	BMOD	BMOD	BMOD	BMOD	BMOD	BMOD	BMOD	BMOD	BMOD
	CMOD	CMOD	CMOD	CMOD	CMOD	CMOD	CMOD	CMOD	CMOD
LPOP	BMOD	BMOD	BMOD	BMOD	BMOD	BMOD	BMOD	BMOD	BMOD
	CMOD	CMOD	CMOD	CMOD	CMOD	CMOD	CMOD	CMOD	CMOD
RPOP	BMOD	BMOD	BMOD	BMOD	BMOD	BMOD	BMOD	BMOD	BMOD
	CMOD	CMOD	CMOD	CMOD	CMOD	CMOD	CMOD	CMOD	CMOD

COD	BMOD	BMOD	BMOD	BMOD	BMOD	BMOD	BMOD	BMOD	BMOD
	CMOD	CMOD	CMOD	CMOD	CMOD	CMOD	CMOD	CMOD	CMOD
DO	BMOD	BMOD	BMOD	BMOD	BMOD	BMOD	BMOD	BMOD	BMOD
	CMOD	CMOD	CMOD	CMOD	CMOD	CMOD	CMOD	CMOD	CMOD
SU	BMOD	BMOD	BMOD	BMOD	BMOD	BMOD	BMOD	BMOD	BMOD
	CMOD	CMOD	CMOD	CMOD	CMOD	CMOD	CMOD	CMOD	CMOD
SA	BMOD	BMOD	BMOD	BMOD	BMOD	BMOD	BMOD	BMOD	BMOD
	CMOD	CMOD	CMOD	CMOD	CMOD	CMOD	CMOD	CMOD	CMOD

## Example of Varied Input File

The following example illustrates a **portion** of the initial conditions file when the VARIED option is specified. If the sediment submodel is employed, concentrations in both water column and sediments must be supplied. The format for concentration input is (:///10(10F8.0:/)). The format is of little concern, however, since the ASCII initial conditions are cut and pasted from the snapshot file.

No example is provided of binary initial conditions. Input sequence and format are handled by the model with no user options.

INITIAL CONDITIONS FOR THIRTY-SEGMENT BAY MOCKUP.  
Looped from first three-year run. November 12, 1992

### Temperature

4.9270	5.4710	5.7669	5.8596	5.8192	5.6848	5.4855	5.2670	5.1115	5.1482
5.9457	6.7019	7.0215	7.0740	6.9612	6.7321	6.4327	6.1511	6.0430	6.3396
6.4314	7.2814	7.6065	7.6363	7.4866	7.2106	6.8628	6.5518	6.4584	6.7769

### Salinity

1.6007	3.8823	6.5603	9.4101	12.2893	15.1070	17.8087	20.3684	22.7844	25.0908
1.8511	4.4289	7.4163	10.5474	13.6652	16.6744	19.5233	22.1947	24.7015	27.1140
1.9743	4.6971	7.8350	11.1021	14.3345	17.4346	20.3525	23.0733	25.6009	27.9156

### Iron + Manganese

0.0000	0.0000	0.0000	0.0000	0.0000	0.0000	0.0000	0.0000	0.0000	0.0000
0.0000	0.0000	0.0000	0.0000	0.0000	0.0000	0.0000	0.0000	0.0000	0.0000
0.0000	0.0000	0.0000	0.0000	0.0000	0.0000	0.0000	0.0000	0.0000	0.0000

## 12 Algal Growth Rate File

---

This file specifies the algal growth, respiration, and predation rates. A growth rate must be specified for each box in the grid. Spatially varying rates are permissible. As in the previous input files, three title lines are available for identifying the file. The input format for the file is (8X,9F8.0). The first column is ignored but is commonly given the box number associated with the algal growth rates. The values must be specified for each box in ascending order.

<b>Field</b>	<b>Name</b>	<b>Value</b>	<b>Description</b>
1	PMC	Real	Cyanobacteria production rate under optimum conditions
2	BMRC	Real	Cyanobacteria base metabolic rate
3	BPRC	Real	Cyanobacteria predation rate
4	PMD	Real	Diatom production rate under optimum conditions
5	BMRD	Real	Diatom base metabolic rate
6	BPRD	Real	Diatom predation rate
7	PMG	Real	Green algae production rate under optimum conditions
8	BMRG	Real	Green algae base metabolic rate
9	BPRG	Real	Green algae predation rate



## EXAMPLE

Algal growth rates for thirty-box Chesapeake Bay mockup.  
August 11, 1992

BOX	PMC	BMRC	BPRC	PMD	BMRD	BPRD	PMG	BMRG	BPRG
1	0.000	0.000	0.000	2.250	0.010	0.215	2.500	0.010	0.215
2	0.000	0.000	0.000	2.250	0.010	0.215	2.500	0.010	0.215
3	0.000	0.000	0.000	2.250	0.010	0.215	2.500	0.010	0.215
4	0.000	0.000	0.000	2.250	0.010	0.215	2.500	0.010	0.215
5	0.000	0.000	0.000	2.250	0.010	0.215	2.500	0.010	0.215
6	0.000	0.000	0.000	2.250	0.010	0.215	2.500	0.010	0.215
7	0.000	0.000	0.000	2.250	0.010	0.215	2.500	0.010	0.215
8	0.000	0.000	0.000	2.250	0.010	0.215	2.500	0.010	0.215
9	0.000	0.000	0.000	2.250	0.010	0.215	2.500	0.010	0.215
10	0.000	0.000	0.000	2.250	0.010	0.215	2.500	0.010	0.215
11	0.000	0.000	0.000	2.250	0.010	0.215	2.500	0.010	0.215
12	0.000	0.000	0.000	2.250	0.010	0.215	2.500	0.010	0.215
13	0.000	0.000	0.000	2.250	0.010	0.215	2.500	0.010	0.215
14	0.000	0.000	0.000	2.250	0.010	0.215	2.500	0.010	0.215
15	0.000	0.000	0.000	2.250	0.010	0.215	2.500	0.010	0.215
16	0.000	0.000	0.000	2.250	0.010	0.215	2.500	0.010	0.215
17	0.000	0.000	0.000	2.250	0.010	0.215	2.500	0.010	0.215
18	0.000	0.000	0.000	2.250	0.010	0.215	2.500	0.010	0.215
19	0.000	0.000	0.000	2.250	0.010	0.215	2.500	0.010	0.215
20	0.000	0.000	0.000	2.250	0.010	0.215	2.500	0.010	0.215
21	0.000	0.000	0.000	2.250	0.010	0.215	2.500	0.010	0.215
22	0.000	0.000	0.000	2.250	0.010	0.215	2.500	0.010	0.215
23	0.000	0.000	0.000	2.250	0.010	0.215	2.500	0.010	0.215
24	0.000	0.000	0.000	2.250	0.010	0.215	2.500	0.010	0.215
25	0.000	0.000	0.000	2.250	0.010	0.215	2.500	0.010	0.215
26	0.000	0.000	0.000	2.250	0.010	0.215	2.500	0.010	0.215
27	0.000	0.000	0.000	2.250	0.010	0.215	2.500	0.010	0.215
28	0.000	0.000	0.000	2.250	0.010	0.215	2.500	0.010	0.215
29	0.000	0.000	0.000	2.250	0.010	0.215	2.500	0.010	0.215
30	0.000	0.000	0.000	2.250	0.010	0.215	2.500	0.010	0.215

# 13 Settling Velocity File

---

This file specifies the water-column settling velocities. Three title cards are available for identifying the file. The input format is (8X,7F8.0). The first field can be left blank, but it is commonly used to identify the box number associated with the given settling velocities. Settling velocities must be specified for each box in ascending order. Spatially varying velocities are permissible.

<b>Field</b>	<b>Name</b>	<b>Value</b>	<b>Description</b>
1	WSS	Real	Suspended solids settling velocity
2	WSLAB	Real	Labile particle settling velocity
3	WSREF	Real	Refractory particle settling velocity
4	WSC	Real	Cyanobacteria settling velocity
5	WSDB	Real	Base diatom settling velocity
6	WSDS	Real	Large diatom enhanced settling velocity

## EXAMPLE

Water column settling velocities for thirty-segment bay mockup  
Adopted from zone 5 of Chesapeake Bay

BOX	WSS	WSLAB	WSREF	WSC	WSDB	WSDS	WSG
1	0.000	1.000	1.000	0.000	0.100	0.250	0.100
2	0.000	1.000	1.000	0.000	0.100	0.250	0.100
3	0.000	1.000	1.000	0.000	0.100	0.250	0.100
4	0.000	1.000	1.000	0.000	0.100	0.250	0.100
5	0.000	1.000	1.000	0.000	0.100	0.250	0.100
6	0.000	1.000	1.000	0.000	0.100	0.250	0.100
7	0.000	1.000	1.000	0.000	0.100	0.250	0.100
8	0.000	1.000	1.000	0.000	0.100	0.250	0.100
9	0.000	1.000	1.000	0.000	0.100	0.250	0.100
10	0.000	1.000	1.000	0.000	0.100	0.250	0.100
11	0.000	1.000	1.000	0.000	0.100	0.250	0.100
12	0.000	1.000	1.000	0.000	0.100	0.250	0.100
13	0.000	1.000	1.000	0.000	0.100	0.250	0.100
14	0.000	1.000	1.000	0.000	0.100	0.250	0.100
15	0.000	1.000	1.000	0.000	0.100	0.250	0.100
16	0.000	1.000	1.000	0.000	0.100	0.250	0.100
17	0.000	1.000	1.000	0.000	0.100	0.250	0.100
18	0.000	1.000	1.000	0.000	0.100	0.250	0.100
19	0.000	1.000	1.000	0.000	0.100	0.250	0.100
20	0.000	1.000	1.000	0.000	0.100	0.250	0.100
21	0.000	1.000	1.000	0.000	0.100	0.250	0.100
22	0.000	1.000	1.000	0.000	0.100	0.250	0.100
23	0.000	1.000	1.000	0.000	0.100	0.250	0.100
24	0.000	1.000	1.000	0.000	0.100	0.250	0.100
25	0.000	1.000	1.000	0.000	0.100	0.250	0.100
26	0.000	1.000	1.000	0.000	0.100	0.250	0.100
27	0.000	1.000	1.000	0.000	0.100	0.250	0.100
28	0.000	1.000	1.000	0.000	0.100	0.250	0.100
29	0.000	1.000	1.000	0.000	0.100	0.250	0.100
30	0.000	1.000	1.000	0.000	0.100	0.250	0.100

# 14 Meteorologic Input File

---

This file contains the meteorologic data used to compute temperature. The file also contains illumination and fractional daylength used to compute algal growth. The file consists of three title cards used to identify the run. The remaining cards consist of the Julian date and the meteorologic inputs. The required parameters must be measured or computed external to the model. Suggested computational procedures are found in Edinger et al. (1974).

Field	Name	Value	Description
1	JDAY	Real	Julian date
2	KT	Real	Coefficient of surface heat exchange
3	TE	Real	Equilibrium temperature
4	I0	Real	Total daily illumination
5	FD	Real	Fractional day length

The example below is a portion of an one-year meteorological file.

## EXAMPLE

Meteorological file for 1985 annual run  
Set up February 22, 1989

JDAY	KT	TE	I0	FD
0.0	31.1	9.5	110.7	0.391
1.0	34.0	9.5	102.6	0.392
2.0	34.8	0.3	82.5	0.392
3.0	23.8	-0.4	82.9	0.393
4.0	40.1	0.9	183.7	0.393
5.0	17.0	1.9	209.7	0.394
6.0	23.8	2.2	100.0	0.394
7.0	36.5	0.1	179.4	0.395
8.0	28.0	-4.7	220.7	0.396
9.0	15.4	-5.3	97.3	0.396
10.0	22.9	-3.4	127.8	0.397
11.0	36.9	-4.1	230.8	0.398
12.0	28.2	-1.7	199.7	0.399
13.0	28.0	1.0	221.2	0.400
14.0	54.2	-3.7	230.8	0.401

# 15 External Loads Files

---

Two files are available for the input of external loads. The format of the files is identical. Provision of two files allows separation of loads by source e.g. point-source and nonpoint-source. Two files also allow updates of loads at different time intervals. One file can list loads at daily intervals while the other lists loads at monthly intervals.

The first three lines in each External Loads file are reserved for identification. The remainder of each file lists the number of loads for each constituent, the cell location for each load, and the loading rate for each cell. Multiple inputs into single cells are allowed. Loads may be updated at specified intervals. The total number of loads and their location cannot be altered, however.

## Number of Loads (PSLN)

Field	Name	Value	Description
1-22	PSLN	Integer	Number of external loads for each constituent

This card is required only once at the beginning of the file.

### EXAMPLE

# LOADS	PSLN	PSLN	PSLN	PSLN	PSLN	PSLN	PSLN	PSLN	PSLN
	0	0	0	5	0	0	5	5	5
	5	5	5	5	5	5	5	5	5
	0	0	0	0					

## Location of Loads (PSLB)

Field	Name	Value	Description
1-9	PSLB	Integer	Cell number for external load

One card for each state variable is required in the input file

### EXAMPLE

```
TEMP  PSLB  PSLB  PSLB  PSLB  PSLB  PSLB  PSLB  PSLB  PSLB
      0
```

## External Load (PSL)

Field	Name	Value	Description
1	JDAY	Real	Julian day
2-8	PSL	Real	External load (kg/day)

One of these cards is required for each constituent. Loadings can be input at any frequency as long as the date of the input is specified in the JDAY variable.

### EXAMPLE

PS	LOAD	JDAY	PSL	PSL	PSL	PSL	PSL	PSL	PSL
TEMP		0.	0.						

The following pages illustrate a complete external load file. Loads are initially specified at Julian day 0 and updated at day 30. Loads retain the value specified at day 30 until the end of the model run.

Point-source example input file  
Chesapeake Bay Workshop

# LOADS	PSLN	PSLN	PSLN	PSLN	PSLN	PSLN	PSLN	PSLN	PSLN
	0	0	0	5	0	0	5	5	5
	5	5	5	5	5	5	5	5	5
	0	0	0	0					
TEMP	PSLB	PSLB	PSLB	PSLB	PSLB	PSLB	PSLB	PSLB	PSLB
	0								
SALT	PSLB	PSLB	PSLB	PSLB	PSLB	PSLB	PSLB	PSLB	PSLB
	0								
TAM	PSLB	PSLB	PSLB	PSLB	PSLB	PSLB	PSLB	PSLB	PSLB
	0								
CYAN	PSLB	PSLB	PSLB	PSLB	PSLB	PSLB	PSLB	PSLB	PSLB
	1	2	3	4	5				
DIAT	PSLB	PSLB	PSLB	PSLB	PSLB	PSLB	PSLB	PSLB	PSLB
	0								
GREN	PSLB	PSLB	PSLB	PSLB	PSLB	PSLB	PSLB	PSLB	PSLB
	0								
DOC	PSLB	PSLB	PSLB	PSLB	PSLB	PSLB	PSLB	PSLB	PSLB
	1	2	3	4	5				
LPOC	PSLB	PSLB	PSLB	PSLB	PSLB	PSLB	PSLB	PSLB	PSLB
	1	2	3	4	5				
RPOC	PSLB	PSLB	PSLB	PSLB	PSLB	PSLB	PSLB	PSLB	PSLB
	1	2	3	4	5				
NH4	PSLB	PSLB	PSLB	PSLB	PSLB	PSLB	PSLB	PSLB	PSLB
	1	2	3	4	5				
NO3	PSLB	PSLB	PSLB	PSLB	PSLB	PSLB	PSLB	PSLB	PSLB
	1	2	3	4	5				
DON	PSLB	PSLB	PSLB	PSLB	PSLB	PSLB	PSLB	PSLB	PSLB
	1	2	3	4	5				
LPON	PSLB	PSLB	PSLB	PSLB	PSLB	PSLB	PSLB	PSLB	PSLB
	1	2	3	4	5				
RPON	PSLB	PSLB	PSLB	PSLB	PSLB	PSLB	PSLB	PSLB	PSLB
	1	2	3	4	5				
PO4	PSLB	PSLB	PSLB	PSLB	PSLB	PSLB	PSLB	PSLB	PSLB
	1	2	3	4	5				
DOP	PSLB	PSLB	PSLB	PSLB	PSLB	PSLB	PSLB	PSLB	PSLB
	1	2	3	4	5				
LPOP	PSLB	PSLB	PSLB	PSLB	PSLB	PSLB	PSLB	PSLB	PSLB
	1	2	3	4	5				
RPOP	PSLB	PSLB	PSLB	PSLB	PSLB	PSLB	PSLB	PSLB	PSLB
	1	2	3	4	5				



	COD	PSLB 0	PSLB	PSLB	PSLB	PSLB	PSLB	PSLB	PSLB	PSLB
	DO	PSLB 0	PSLB	PSLB	PSLB	PSLB	PSLB	PSLB	PSLB	PSLB
	PSIL	PSLB 0	PSLB	PSLB	PSLB	PSLB	PSLB	PSLB	PSLB	PSLB
	DSIL	PSLB 0	PSLB	PSLB	PSLB	PSLB	PSLB	PSLB	PSLB	PSLB
PS LOAD	JDAY	PSL	PSL	PSL	PSL	PSL	PSL	PSL	PSL	PSL
	TEMP	0.	0.							
	SALT	0.	0.							
	TAM	0.	0.							
	CYAN	0.	0.							
	DIAT	0.	0.							
	GREEN	0.	0.							
	DOC	0.	10.	10.	10.	10.	10.			
	LPOC	0.	18.	10.	10.	10.	10.			
	RPOC	0.	10.	10.	10.	10.	10.			
	NH4	0.	10.	10.	10.	10.	10.			
	NO3	0.	10.	10.	10.	10.	10.			
	DON	0.	10.	10.	10.	10.	10.			
	LPON	0.	10.	10.	10.	10.	10.			
	RPON	0.	10.	10.	10.	10.	10.			
	PO4	0.	10.	10.	10.	10.	10.			
	DOP	0.	10.	10.	10.	10.	10.			
	LPOP	0.	10.	10.	10.	10.	10.			
	RPOP	0.	10.	10.	10.	10.	10.			
	COD	0.	0.							
	DO	0.	0.							
	PSIL	0.	0.							
	DSIL	0.	0.							
	TEMP	30.	0.							
	SALT	30.	0.							
	TAM	30.	0.							
	CYAN	30.	0.							
	DIAT	30.	0.							
	GREEN	30.	0.							
	DOC	30.	20.	20.	20.	20.	20.			
	LPOC	30.	18.	20.	20.	20.	20.			
	RPOC	30.	20.	20.	20.	20.	20.			
	NH4	30.	20.	20.	20.	20.	20.			
	NO3	30.	20.	20.	20.	20.	20.			
	DON	30.	20.	20.	20.	20.	20.			
	LPON	30.	20.	20.	20.	20.	20.			
	RPON	30.	20.	20.	20.	20.	20.			
	PO4	30.	20.	20.	20.	20.	20.			
	DOP	30.	20.	20.	20.	20.	20.			
	LPOP	30.	20.	20.	20.	20.	20.			
	RPOP	30.	20.	20.	20.	20.	20.			
	COD	30.	0.							
	DO	30.	0.							
	PSIL	30.	0.							
	DSIL	30.	0.							

# 16 Atmospheric Loading File

---

This file contains the atmospheric loads of nitrogen and phosphorus deposited directly to the water surface. Loads are input in the form of precipitation rate and nutrient concentration within the precipitation. These must be uniform throughout the system. Mass loads to each model cell are computed within the model. Atmospheric loads may be updated on a daily or less frequent basis.

The first three cards in the file are title cards for identification or comments. A header card follows. The balance of the file lists precipitation and concentration. The format is (10F8.0).

Field	Name	Value	Description
1	JDAY	Real	Julian day
2	RNFL	Real	Rainfall (cm day <sup>-1</sup> )
3	ATMNH4	Real	Ammonium concentration (gm m <sup>-3</sup> )
4	ATMNO3	Real	Nitrate concentration (gm m <sup>-3</sup> )
5	ATMDON	Real	Dissolved organic nitrogen concentration (gm m <sup>-3</sup> )
6	ATMPO4	Real	Phosphate concentration (gm m <sup>-3</sup> )
7	ATMDOP	Real	Dissolved organic phosphorus concentration (gm m <sup>-3</sup> )

The following cards are an example of an atmospheric loading file.

First try at Indian River atmospheric loads. Annual averages from  
Joe Scudlark converted to rainfall and concentration. Aug 5, 1992.

JDAY	RNFL	ATMNH4	ATMNO3	ATMDON	ATMPO4	ATMDOP
0.0	0.109	1.30	7.00	0.00	0.000	0.000
90.0	0.005	1.00	6.00	0.10	0.000	0.000
365.0	0.009	1.15	6.50	0.15	0.000	0.000
1200.	0.109	1.30	7.00	0.00	0.000	0.000

# 17 Light-Extinction File

---

This file specifies the light-extinction coefficient for each cell in the model. Extinction may be uniform or spatially varying. Extinction may be updated on a daily or less frequent basis.

The first three cards are used for identification or comments. A header card follows. The remaining cards specify light extinction. The format is (10F8.0, :/( :8X,9F8.0)).

Field	Name	Value	Description
1	JDAY	Real	Julian day
2-10	KE	Real	Light extinction ( $m^{-1}$ )

## EXAMPLE

```

JDAY      KE      KE      KE      KE      KE      KE      KE      KE      KE
  0.0    1.000  1.000  1.000  1.000  1.000  1.000  1.000  1.000  1.000
        1.000  1.000  1.000  1.000  1.000  1.000  1.000  1.000  1.000
        1.000  1.000  1.000  1.000  1.000  1.000  1.000  1.000  1.000
        1.000  1.000  1.000
  
```

The following file illustrates the light-extinction file.

Light-extinction file for thirty-segment bay mockup  
August 11, 1992

```

JDAY      KE      KE      KE      KE      KE      KE      KE      KE      KE
  0.0    1.000  1.000  1.000  1.000  1.000  1.000  1.000  1.000  1.000
        1.000  1.000  1.000  1.000  1.000  1.000  1.000  1.000  1.000
        1.000  1.000  1.000  1.000  1.000  1.000  1.000  1.000  1.000
        1.000  1.000  1.000
1100.0   1.010  1.010  1.010  1.010  1.010  1.010  1.010  1.010  1.010
        1.010  1.010  1.010  1.010  1.010  1.010  1.010  1.010  1.010
        1.010  1.010  1.010  1.010  1.010  1.010  1.010  1.010  1.010
        1.010  1.010  1.010
  
```

# 18 Spatially Varying Kinetics

This file specifies the parameters which determine spatially varying kinetics rates including hydrolysis, mineralization, nitrification, and reaeration. Each parameter must be specified for each model cell. Once specified, the parameters cannot be updated although rates are modified within the model as a function of temperature and other influences. The parameters to be specified are listed in Table 18-1. Additional information on these parameters is provided in Chapter 3. Parameters must be specified in the order tabulated. Each parameter is specified for all model cells before the next parameter is specified. Three lines are provided at the top of the file for comments and identification. Format for the remainder of the file is (//(8X,9F8.0)).

Table 18-1 Spatially Varying Kinetics Parameters		
Symbol	Definition	Units
KDC	minimum respiration rate of dissolved organic carbon	day <sup>-1</sup>
KLC	minimum dissolution rate of labile particulate carbon	day <sup>-1</sup>
KRC	minimum dissolution rate of refractory particulate carbon	day <sup>-1</sup>
KDN	minimum mineralization rate of dissolved organic nitrogen	day <sup>-1</sup>
KLN	minimum dissolution rate of labile particulate nitrogen	day <sup>-1</sup>
KRN	minimum dissolution rate of refractory particulate nitrogen	day <sup>-1</sup>
KDP	minimum mineralization rate of dissolved organic phosphorus	day <sup>-1</sup>
KLP	minimum dissolution rate of labile particulate phosphorus	day <sup>-1</sup>
KRP	minimum dissolution rate of refractory particulate phosphorus	day <sup>-1</sup>
<i>(Continued)</i>		

Table 18-1 (Concluded)		
Symbol	Definition	Units
KSUA	particulate biogenic silica dissolution rate	day <sup>-1</sup>
KCOD	oxidation rate of chemical oxygen demand	day <sup>-1</sup>
KDCALG	constant that relates dissolved carbon respiration rate to algal biomass	m <sup>3</sup> gm <sup>-1</sup> C day <sup>-1</sup>
KLCALG	constant that relates labile carbon dissolution rate to algal biomass	m <sup>3</sup> gm <sup>-1</sup> C day <sup>-1</sup>
KRCALG	constant that relates refractory carbon dissolution rate to algal biomass	m <sup>3</sup> gm <sup>-1</sup> C day <sup>-1</sup>
KDNALG	constant that relates dissolved nitrogen mineralization rate to algal biomass	m <sup>3</sup> gm <sup>-1</sup> C day <sup>-1</sup>
KLNALG	constant that relates labile nitrogen dissolution rate to algal biomass	m <sup>3</sup> gm <sup>-1</sup> C day <sup>-1</sup>
KRNALG	constant that relates refractory nitrogen dissolution rate to algal biomass	m <sup>3</sup> gm <sup>-1</sup> C day <sup>-1</sup>
KDPALG	constant that relates dissolved phosphorus mineralization rate to algal biomass	m <sup>3</sup> gm <sup>-1</sup> C day <sup>-1</sup>
KLPALG	constant that relates labile phosphorus dissolution rate to algal biomass	m <sup>3</sup> gm <sup>-1</sup> C day <sup>-1</sup>
KRPALG	constant that relates refractory phosphorus dissolution rate to algal biomass	m <sup>3</sup> gm <sup>-1</sup> C day <sup>-1</sup>
NTMAX	maximum nitrification rate at optimal temperature	gm N m <sup>-3</sup> day <sup>-1</sup>
KRDO	reaeration coefficient	m day <sup>-1</sup>

### Example of Spatially Varying Kinetics Input File

An example follows of a Kinetics Input file for the 30-cell grid shown as Figure 9-1.

FILE OF SPATIALLY VARIABLE MINERALIZATION RATES  
FEBRUARY 10, 1993

```

      KDC      KDC      KDC      KDC      KDC      KDC      KDC      KDC      KDC      KDC
1  0.0100  0.0100  0.0100  0.0100  0.0100  0.0100  0.0100  0.0100  0.0100  0.0100
2  0.0100  0.0100  0.0100  0.0100  0.0100  0.0100  0.0100  0.0100  0.0100  0.0100
3  0.0100  0.0100  0.0100  0.0100  0.0100  0.0100  0.0100  0.0100  0.0100  0.0100
4  0.0100  0.0100  0.0100

      KLC      KLC      KLC      KLC      KLC      KLC      KLC      KLC      KLC      KLC
1  0.0750  0.0750  0.0750  0.0750  0.0750  0.0750  0.0750  0.0750  0.0750  0.0750
2  0.0750  0.0750  0.0750  0.0750  0.0750  0.0750  0.0750  0.0750  0.0750  0.0750
3  0.0750  0.0750  0.0750  0.0750  0.0750  0.0750  0.0750  0.0750  0.0750  0.0750
4  0.0750  0.0750  0.0750

```







# 19 Boundary Conditions File

---

This file specifies boundary concentrations for all constituents at each boundary face. The first three cards in the file are for identification or comments. The next card specifies the number of flow faces which are open boundaries. The number specified must agree with the number of open faces identified in the map file.

Field	Name	Value	Description
1-22	NCB	Integer	Number of boundary boxes

This card specifies the number of boundary boxes.

NCB	NCB	NCB	NCB	NCB	NCB	NCB	NCB	NCB
4	4	4	4	4	4	4	4	4
4	4	4	4	4	4	4	4	4
4	4	4	4					

The remainder of the file is devoted to specification of concentrations and weighting factors. Boundary concentrations must be specified at least once at commencement of the run. Concentrations may be updated at arbitrary intervals. The concentrations must be ordered according to the order of the flow boundaries specified in the map file. For example, if flow boundaries occur at faces 1, 11, 21, and 31, boundary concentrations must appear in this order in the file. Concentrations are specified at all faces for one constituent, then the mass-balance weighting factor is specified for the same constituent. The weighting factor is required even if no open-ocean boundaries exist. Details of the weighting factor may be found in Chapter 2. Format for boundary specification is (8X,9F8.0,:(16X,8F8.0)).

An example of a boundary conditions file for the 30-cell grid shown as Figure 9-1 follows. Conditions are specified at day 0 and updated at day 30.4. Parameters in the file are:

Field	Name	Value	Description
1	JDAY	Real	Julian day
2-9	CB	Real	Boundary concentration
1	JDAY	Real	Julian day
2	ALPHA	Real	Weighting coefficient

### EXAMPLE

Boundary conditions for thirty-segment bay mockup  
August 11, 1992

	NCB	NCB	NCB	NCB	NCB	NCB	NCB	NCB	NCB
	4	4	4	4	4	4	4	4	4
	4	4	4	4	4	4	4	4	4
	4	4	4	4	4				
	JDAY	CB	CB	CB	CB	CB	CB	CB	CB
TEMP	0.00	5.000	7.500	7.500	7.500				
ALPHA	0.00	0.000							
SALT	0.00	0.000	29.800	29.800	29.800				
ALPHA	0.00	0.000							
TAM	0.00	0.000	0.000	0.000	0.000				
ALPHA	0.00	0.000							
CYAN	0.00	0.000	0.000	0.000	0.000				
ALPHA	0.00	0.000							
DIAT	0.00	0.000	0.745	0.745	0.745				
ALPHA	0.00	0.000							
GREEN	0.00	0.180	0.083	0.083	0.083				
ALPHA	0.00	0.000							
DOC	0.00	1.000	1.070	1.070	1.070				
ALPHA	0.00	0.000							
LPOC	0.00	0.000	0.001	0.001	0.001				
ALPHA	0.00	0.000							
RPOC	0.00	0.820	0.001	0.001	0.001				
ALPHA	0.00	0.000							
NH4	0.00	0.100	0.011	0.011	0.011				
ALPHA	0.00	0.000							
NO3	0.00	1.000	0.009	0.009	0.009				
ALPHA	0.00	0.000							
DON	0.00	0.100	0.300	0.300	0.300				
ALPHA	0.00	0.000							
LPON	0.00	0.000	0.000	0.000	0.000				
ALPHA	0.00	0.000							
RPON	0.00	0.071	0.000	0.000	0.000				
ALPHA	0.00	0.000							
PO4	0.00	0.105	0.036	0.036	0.036				
ALPHA	0.00	0.000							
DOP	0.00	0.010	0.010	0.010	0.010				
ALPHA	0.00	0.000							
LPOP	0.00	0.000	0.004	0.004	0.004				
ALPHA	0.00	0.000							
RPOP	0.00	0.095	0.004	0.004	0.004				
ALPHA	0.00	0.000							
COD	0.00	0.000	0.000	0.000	0.000				
ALPHA	0.00	0.000							
DO	0.00	8.000	11.000	11.000	11.000				
ALPHA	0.00	0.000							
PSIL	0.00	0.000	0.000	0.000	0.000				
ALPHA	0.00	0.000							
DSIL	0.00	2.000	0.000	0.000	0.000				

ALPHA	0.00	0.000			
TEMP	30.40	5.000	3.700	3.700	3.700
ALPHA	30.40	0.000			
SALT	30.40	0.000	30.800	30.800	30.800
ALPHA	30.40	0.000			
TAM	30.40	0.000	0.000	0.000	0.000
ALPHA	30.40	0.000			
CYAN	30.40	0.000	0.000	0.000	0.000
ALPHA	30.40	0.000			
DIAT	30.40	0.000	0.572	0.572	0.572
ALPHA	30.40	0.000			
GREEN	30.40	0.180	0.064	0.064	0.064
ALPHA	30.40	0.000			
DOC	30.40	1.000	1.160	1.160	1.160
ALPHA	30.40	0.000			
LPOC	30.40	0.000	0.002	0.002	0.002
ALPHA	30.40	0.000			
RPOC	30.40	0.820	0.002	0.002	0.002
ALPHA	30.40	0.000			
NH4	30.40	0.100	0.011	0.011	0.011
ALPHA	30.40	0.000			
NO3	30.40	1.000	0.009	0.009	0.009
ALPHA	30.40	0.000			
DON	30.40	0.100	0.300	0.300	0.300
ALPHA	30.40	0.000			
LPON	30.40	0.000	0.000	0.000	0.000
ALPHA	30.40	0.000			
RPON	30.40	0.071	0.000	0.000	0.000
ALPHA	30.40	0.000			
PO4	30.40	0.105	0.031	0.031	0.031
ALPHA	30.40	0.000			
DOP	30.40	0.010	0.010	0.010	0.010
ALPHA	30.40	0.000			
LPOP	30.40	0.000	0.006	0.006	0.006
ALPHA	30.40	0.000			
RPOP	30.40	0.095	0.006	0.006	0.006
ALPHA	30.40	0.000			
COD	30.40	0.000	0.000	0.000	0.000
ALPHA	30.40	0.000			
DO	30.40	8.000	11.500	11.500	11.500
ALPHA	30.40	0.000			
PSIL	30.40	0.000	0.000	0.000	0.000
ALPHA	30.40	0.000			
DSIL	30.40	2.000	0.000	0.000	0.000
ALPHA	30.40	0.000			

# 20 Submerged Aquatic Vegetation File

---

The Submerged Aquatic Vegetation File provides a means of adding or removing material due to the activity of submerged aquatic vegetation (SAV). In its present configuration, loads are considered for particulate organic matter and for dissolved oxygen. Dissolved nutrients can be added with minor code modifications.

The first three lines in the file are reserved for comments or identification. The next card group lists the total number of cells which contain SAV.

Field	Name	Value	Description
1	SAVLN	Integer	Total number of cells with SAV

## EXAMPLE

```
SAVLN
 16
```

The next card group lists the cells which contain SAV.

Field	Name	Value	Description
1-9	SAVLB	Integer	Cells which contain SAV

## EXAMPLE

```
SAVLB  SAVLB  SAVLB  SAVLB  SAVLB  SAVLB  SAVLB  SAVLB  SAVLB
   1     3     5     7     8     10    11    13    15
  16    20    21    22    23    24    25
```

The next card group gives the area (square meters) covered by SAV in each of the cells named.

Field	Name	Value	Description
1-9	SAVAREA	Integer	Area covered by SAV

**EXAMPLE**

```

SAVAREA SAVAREA SAVAREA SAVAREA SAVAREA SAVAREA SAVAREA SAVAREA SAVAREA
100.    100.    100.    100.    100.    200.    200.    300.    300.
200.    200.    100.    100.    250.    250.    250.

```

The last card group gives SAV sources or sinks of particulate matter and dissolved oxygen. Units are  $\text{gm m}^{-2} \text{day}^{-1}$ . Sources or sinks may be updated at arbitrary intervals.

Field	Name	Value	Description
1	NXSAV	Integer	Julian day
2	SAVLPOC	Real	Source/sink of labile particulate carbon
3	SAVRPOC	Real	Source/sink of refractory particulate carbon
4	SAVLPON	Real	Source/sink of labile particulate nitrogen
5	SAVRPON	Real	Source/sink of refractory particulate nitrogen
6	SAVLPOP	Real	Source/sink of labile particulate phosphorus
7	SAVRPOP	Real	Source/sink of refractory particulate phosphorus
8	SAVDO	Real	Source/sink of dissolved oxygen

**EXAMPLE**

```

NXSAV SAVLPOC SAVRPOC SAVLPON SAVRPON SAVLPOP SAVRPOP SAVDO
0.0    0.10    0.01    0.001    0.000    0.001    0.00    0.30

```

## Example of Submerged Aquatic Vegetation Input File

SUBMERGED AQUATIC VEGETATION FILE FOR 1984  
 GENERATED OCTOBER 9, 1991. NO NUTRIENT CONTRIBUTION BY SAV

SAVLN								
16								
SAVLB	SAVLB	SAVLB	SAVLB	SAVLB	SAVLB	SAVLB	SAVLB	SAVLB
1	2	7	8	16	17	18	20	21
27	28	30	39	40	41	42		
SAVAREA SAVAREA SAVAREA SAVAREA SAVAREA SAVAREA SAVAREA SAVAREA SAVAREA								
3.38E+6	1.11E+5	3.05E+6	5.46E+6	2.73E+6	6.24E+6	4.58E+5	7.96E+5	4.58E+4
2.26E+5	2.48E+5	2.14E+5	3.10E+5	1.29E+6	7.26E+5	1.18E+6		
NXSAV	SAVLPOC	SAVRPOC	SAVLPON	SAVRPON	SAVLPOP	SAVRPOP	SAVDO	
0.000	0.000	0.000	0.000	0.000	0.000	0.000	0.000	
120.000	0.950	0.950	0.000	0.000	0.000	0.000	5.070	
300.000	0.000	0.000	0.000	0.000	0.000	0.000	0.000	
364.000	0.000	0.000	0.000	0.000	0.000	0.000	0.000	

# 21 Hydrodynamics File

---

The Hydrodynamics File has several formats. The appropriate format depends on specification of the variable HYDC in the Control File. If “BINARY” or “DEPTH\_AV” is specified, the file is in binary. If “ASCII” is specified, the file is in ASCII. Specification of HYDC also determines the contents of the file and forces assumptions about the nature of the hydrodynamics. The BINARY and DEPTH\_AV options allow variable surface-cell geometry (to accommodate tidal cycling and other actions) but require uniform, constant horizontal dispersion. The ASCII option requires constant geometry in all cells (including the surface) but accommodates spatially and temporally variable dispersion.

The varying features and requirements associated with specification of HYDC were installed during model development to couple with specific hydrodynamic models. No barrier exists, for example, that prevents binary input of variable dispersion. This input simply was not needed when the model was created. Present features associated with specification of HYDC can be modified through code revisions to the water quality model.

No matter what the format, the first portion of the Hydrodynamics File contains invariant information. The remainder of the file is devoted to time-variable flows, diffusion, and geometry. The portion of the code that reads the invariant information is:

\*\*\*\*\* Time-invariant hydrodynamic data

```
IF (BINARY_HYDRO) THEN
  READ (HYD) SFA
  READ (HYD) (BL(SB,1),SB=1,NSB)
  READ (HYD) (BL(SB,2),SB=1,NSB)
  READ (HYD) (A(F),F=1,NHQF)
  READ (HYD) HMBV
  READ (HYD) HMSBV

ELSE IF (ASCII_HYDRO) THEN
  READ (HYD,1000)
  READ (HYD,1160) (A(F),F=1,NQF)
  READ (HYD,1100)

ELSE IF (DEPTH_AVG_HYDRO) THEN
  READ (HYD) SFA
  READ (HYD) (A(F),F=1,NHQF)
  READ (HYD) (BL(SB,1),SB=1,NSB)
  READ (HYD) (BL(SB,2),SB=1,NSB)
```

```

READ (HYD) HMSBV

ELSE
WRITE(*,*) 'hydro file specified incorrectly'
STOP
END IF
1000 FORMAT(////)
1160 FORMAT(13X,F13.0)
1100 FORMAT(/)

```

Explanation of the variables that appear in the code is provided in Table 21-1.

Table 21-1 Variables Which Define Invariant Hydrodynamics		
Variable	Definition	Comments
SFA	Cell surface area (m <sup>2</sup> )	Specified for surface cells only. This is an vector with dimension NSBP specified in the INCLUDE File.
BL(SB,1)	Cell length in the x-direction (m)	Specified for surface cells only. BL is a three-dimensional array BL(0:NBP,3). NBP is specified in the INCLUDE File.
BL(SB,2)	Cell length in the y-direction (m)	
NSB	Number of surface cells	Specified in Control File.
A(F)	Flow-face area (m <sup>2</sup> )	An vector dimensioned A(0:NQFP). NQFP is specified in the INCLUDE File.
NHQF	Number of horizontal flow faces	Specified in Control File.
NQF	Total number of flow faces	Specified in Control File.
HMBV	Volume of cells below surface layer (m <sup>3</sup> )	An array with dimension NSBP. The model assumes that all layers below the surface layer are of uniform thickness. This volume is used to initialize water quality model volumes.
HMSBV	Volume of cells in the surface layer (m <sup>3</sup> )	An array with dimension NSBP. Initial volumes of surface cells may differ from subsurface cells.

Subsequent read operations from the hydrodynamics file are of time-varying input. The coding is complex to allow for end-of-file operations. When an end of file is encountered, the model switches to another file (if one is specified), reinitializes counters, and provides for continuity. A simplified version of the code, that includes only read operations, is shown below.

\*\*\*\*\* Binary time-varying hydrodynamic data

```

IF (BINARY_HYDRO) THEN
READ (HYD,END=10010)          ! Time from hydro model, not used in wqm
READ (HYD) (A(F),F=1,NSQF)
READ (HYD) (DIFF(F),F=NHQF+1,NQF)
READ (HYD) HMSBV

```



```

      READ (HYD) (Q(F),F=1,NQF)
      NHMR = NHMR+1

***** ASCII time-varying hydrodynamic data

      ELSE IF (ASCII_HYDRO) THEN
        READ (HYD,1000) (Q(F),DIFF(F),F=1,NQF)
1000  FORMAT(21X,E10.3,5X,E10.3)

***** depth-averaged hydrodynamics

      ELSE IF (DEPTH_AVG_HYDRO) THEN
        READ (HYD,END=50010)           ! Time from hydro model, not used in wqm
        READ (HYD) HMSBV
        READ (HYD) (Q(F),F=1,NQF)
        READ (HYD) (A(F),F=1,NSQF)

      END IF

```

Explanation of the variables that appear in the code, and not defined in Table 21-1, is provided in Table 21-2.

<b>Table 21-2 Variables Which Define Time-Variable Hydrodynamics</b>		
<b>Variable</b>	<b>Definition</b>	<b>Comments</b>
HYD	Unit number of Hydrodynamics File	Specified as unit 20 in model code.
NSQF	Number of flow faces in surface layer	Specified in Control File.
DIFF	Diffusion or dispersion coefficient ( $m^2 \text{ sec}^{-1}$ ).	An array dimensioned DIFF(0:NQFP). NQFP is specified in the INCLUDE File. For BINARY input, the model reads only vertical diffusion. For ASCII input, the model reads horizontal dispersion and vertical diffusion. For DEPTH_AV input, the model reads no dispersion or diffusion.
NHMR	A counter which records number of read operations from a hydrodynamic file.	

A portion of an ASCII hydrodynamic input file for the 30-cell grid shown in Figure 9-1 is shown below. Hydrodynamics are initially specified at Julian day 0 and updated at day 50.

## Example of ASCII Input File

Chesapeake Bay mock up for teaching purposes.  
August 10, 1992

FACE #	A
1	1.0E5
2	1.0E5
3	1.0E5
4	1.0E5
.	.
.	.
.	.
.	.
48	6.0E8
49	6.0E8
50	6.0E8
51	6.0E8

JDAY	FACE #	Q	DIFF
0.0	1	2000.	10.0
0.0	2	3000.	10.0
0.0	3	4000.	10.0
0.0	4	5000.	10.0
.	.	.	.
.	.	.	.
.	.	.	.
.	.	.	.
0.0	48	500.	0.001
0.0	49	1000.	0.001
0.0	50	500.	0.001
0.0	51	1000.	0.001
50.0	1	3000.	11.0
50.0	2	4000.	11.0
50.0	3	5000.	11.0
.	.	.	.
.	.	.	.
.	.	.	.

# 22 Benthic Flux Input File

---

The Benthic Flux Input File has two formats. The appropriate format depends on the specification of *SEDC* and *BFC* in the Control File. If *SEDC* = "ON" the file contains input to the predictive sediment submodel. If *BFC* = "ON" the file contains user-specified benthic fluxes. If both parameters are "OFF" the file is not opened.

## Input to Sediment Submodel

### Title Cards

Field	Name	Value	Description
1	Title	Character	Text to identify sediment input deck

Four title lines are required to identify the sediment input deck. These are not read as variables but are skipped by a *FORMAT* statement.

### EXAMPLE

```
SEDIMENT INPUT DECK. THIRTY-BOX CHESAPEAKE BAY MOCKUP.  
EVERYTHING AS IN CHESAPEAKE BAY FINAL (FEB 1992) CALIBRATION  
AUGUST 11, 1992  
EXTRA TITLE LINE
```

## Linkage to Water Column

Field	Name	Value	Description
1, 3, 5, 7	IWCSEG	Integer	Water column box overlying sediment box
2, 4, 6, 8	HSED	Fixed	Thickness of sediment layer (cm)

These cards provide a table of linkages between the water column and sediment models. The sediment box is not specified but is understood to start with one and proceed up to the total number of sediment boxes (equal to total number of surface boxes in the water quality model). In the example below, sediment box 1 is linked to water column box 21, sediment box 2 is linked to water column box 22, etc. After specifying the linkage, the thickness of each sediment box is specified in centimeters.

### FORMAT

(:////(4(I5,F10.0)))

### EXAMPLE

21 10.0 22 10.0 23 10.0 24 10.0

## Steady-State Integration

Field	Name	Value	Description
1	INTSEDC	Integer	A flag to provide steady-state integration of G3 organics

The G3 component of sediment organic matter takes decades to come to steady state. An estimate of steady-state G3 carbon, nitrogen, and phosphorus is printed to the snapshot file at the end of a model run if INTSEDC = 1. If INTSEDC = 0, no estimate is provided.

### FORMAT

(I10)

### EXAMPLE

1 INTSEDC=1 TO WRITE OUT STEADY-STATE G3



## Phosphorus Partitioning of Phytoplankton Group 1

Field	Name	Value	Description
1	FRPPH1(1)	Fixed	G1 fraction of Group 1 phosphorus
2	FRPPH1(2)	Fixed	G2 fraction of Group 1 phosphorus
3	FRPPH1(3)	Fixed	G3 fraction of Group 1 phosphorus

FRPPH1 is a three-element array that specifies the fractionation of Group 1 phytoplankton (blue-green algae) phosphorus into G1, G2, G3 components in the sediments. Elements of the array are specified as fractions. The sum of the three elements must equal unity.

### FORMAT

(8F10.0)

### EXAMPLE

0.65 0.255 0.095 FRPPH1

## Phosphorus Partitioning of Phytoplankton Group 2

Field	Name	Value	Description
1	FRPPH2(1)	Fixed	G1 fraction of Group 2 phosphorus
2	FRPPH2(2)	Fixed	G2 fraction of Group 2 phosphorus
3	FRPPH2(3)	Fixed	G3 fraction of Group 2 phosphorus

FRPPH2 is a three-element array that specifies the fractionation of Group 2 phytoplankton (diatoms) phosphorus into G1, G2, G3 components in the sediments. Elements of the array are specified as fractions. The sum of the three elements must equal unity.

### FORMAT

(8F10.0)

### EXAMPLE

0.65 0.255 0.095 FRPPH2

## Phosphorus Partitioning of Phytoplankton Group 3

Field	Name	Value	Description
1	FRPPH3(1)	Fixed	G1 fraction of Group 3 phosphorus
2	FRPPH3(2)	Fixed	G2 fraction of Group 3 phosphorus
3	FRPPH3(3)	Fixed	G3 fraction of Group 3 phosphorus

FRPPH3 is a three-element array that specifies the fractionation of Group 3 phytoplankton (greens) phosphorus into G1, G2, G3 components in the sediments. Elements of the array are specified as fractions. The sum of the three elements must equal unity.

### FORMAT

(8F10.0)

### EXAMPLE

```
0.65    0.255    0.095           FRPPH3
```

## Nitrogen Partitioning of Phytoplankton Group 1

Field	Name	Value	Description
1	FRNPH1(1)	Fixed	G1 fraction of Group 1 nitrogen
2	FRNPH1(2)	Fixed	G2 fraction of Group 1 nitrogen
3	FRNPH1(3)	Fixed	G3 fraction of Group 1 nitrogen

FRNPH1 is a three-element array that specifies the fractionation of Group 1 phytoplankton (blue-green algae) nitrogen into G1, G2, G3 components in the sediments. Elements of the array are specified as fractions. The sum of the three elements must equal unity.

### FORMAT

(8F10.0)

### EXAMPLE

```
0.65    0.280    0.070           FRNPH1
```

## Nitrogen Partitioning of Phytoplankton Group 2

Field	Name	Value	Description
1	FRNPH2(1)	Fixed	G1 fraction of Group 2 nitrogen
2	FRNPH2(2)	Fixed	G2 fraction of Group 2 nitrogen
3	FRNPH2(3)	Fixed	G3 fraction of Group 2 nitrogen

FRNPH2 is a three-element array that specifies the fractionation of Group 2 phytoplankton (diatoms) nitrogen into G1, G2, G3 components in the sediments. Elements of the array are specified as fractions. The sum of the three elements must equal unity.

### FORMAT

(8F10.0)

### EXAMPLE

0.65 0.280 0.070 FRNPH2

## Nitrogen Partitioning of Phytoplankton Group 3

Field	Name	Value	Description
1	FRNPH3(1)	Fixed	G1 fraction of Group 3 nitrogen
2	FRNPH3(2)	Fixed	G2 fraction of Group 3 nitrogen
3	FRNPH3(3)	Fixed	G3 fraction of Group 3 nitrogen

FRNPH3 is a three-element array that specifies the fractionation of Group 3 phytoplankton (greens) nitrogen into G1, G2, G3 components in the sediments. Elements of the array are specified as fractions. The sum of the three elements must equal unity.

### FORMAT

(8F10.0)

### EXAMPLE

0.65 0.280 0.070 FRNPH3



## Carbon Partitioning of Phytoplankton Group 1

Field	Name	Value	Description
1	FRCPH1(1)	Fixed	G1 fraction of Group 1 carbon
2	FRCPH1(2)	Fixed	G2 fraction of Group 1 carbon
3	FRCPH1(3)	Fixed	G3 fraction of Group 1 carbon

FRCPH1 is a three-element array that specifies the fractionation of Group 1 phytoplankton (blue-green algae) carbon into G1, G2, G3 components in the sediments. Elements of the array are specified as fractions. The sum of the three elements must equal unity.

### FORMAT

(8F10.0)

### EXAMPLE

0.65 0.255 0.095 FRCPH1

## Carbon Partitioning of Phytoplankton Group 2

Field	Name	Value	Description
1	FRCPH2(1)	Fixed	G1 fraction of Group 2 carbon
2	FRCPH2(2)	Fixed	G2 fraction of Group 2 carbon
3	FRCPH2(3)	Fixed	G3 fraction of Group 2 carbon

FRCPH2 is a three-element array that specifies the fractionation of Group 2 phytoplankton (diatoms) carbon into G1, G2, G3 components in the sediments. Elements of the array are specified as fractions. The sum of the three elements must equal unity.

### FORMAT

(8F10.0)

### EXAMPLE

0.65 0.255 0.095 FRCPH2

## Carbon Partitioning of Phytoplankton Group 3

Field	Name	Value	Description
1	FRCPH3(1)	Fixed	G1 fraction of Group 3 carbon
2	FRCPH3(2)	Fixed	G2 fraction of Group 3 carbon
3	FRCPH3(3)	Fixed	G3 fraction of Group 3 carbon

FRCPH3 is a three-element array that specifies the fractionation of Group 2 phytoplankton (greens) carbon into G1, G2, G3 components in the sediments. Elements of the array are specified as fractions. The sum of the three elements must equal unity.

### FORMAT

(8F10.0)

### EXAMPLE

0.65    0.255    0.095                    FRCPH3

## Phosphorus Diagenesis Rates

Field	Name	Value	Description
1	KPDIAG(1)	Fixed	Diagenesis rate of G1 phosphorus at 20° C (day <sup>-1</sup> )
2	DPTHTA(1)	Fixed	Effect of temperature on G1 phosphorus diagenesis
3	KPDIAG(2)	Fixed	Diagenesis rate of G2 phosphorus at 20° C (day <sup>-1</sup> )
4	DPTHTA(2)	Fixed	Effect of temperature on G2 phosphorus diagenesis
5	KPDIAG(3)	Fixed	Diagenesis rate of G3 phosphorus at 20° C (day <sup>-1</sup> )
6	DPTHTA(3)	Fixed	Effect of temperature on G3 phosphorus diagenesis

G1, G2, G3 classes of organic matter undergo diagenesis (decay) at different rates. Diagenesis is enhanced at higher temperatures, diminished at lower temperatures. Details of the formulation of the diagenesis reaction are presented in the sediment model documentation. Specify diagenesis in units of day<sup>-1</sup> at 20° C. The temperature effect parameter is dimensionless.

### FORMAT

(8F10.0)

### EXAMPLE

0.035    1.10    0.0018    1.150    0.00000    1.17

## Nitrogen Diagenesis Rates

Field	Name	Value	Description
1	KNDIAG(1)	Fixed	Diagenesis rate of G1 nitrogen at 20° C (day <sup>-1</sup> )
2	DNTHTA(1)	Fixed	Effect of temperature on G1 nitrogen diagenesis
3	KNDIAG(2)	Fixed	Diagenesis rate of G2 nitrogen at 20° C (day <sup>-1</sup> )
4	DNTHTA(2)	Fixed	Effect of temperature on G2 nitrogen diagenesis
5	KNDIAG(3)	Fixed	Diagenesis rate of G3 nitrogen at 20° C (day <sup>-1</sup> )
6	DNTHTA(3)	Fixed	Effect of temperature on G3 nitrogen diagenesis

G1, G2, G3 classes of organic matter undergo diagenesis (decay) at different rates. Diagenesis is enhanced at higher temperatures, diminished at lower temperatures. Details of the formulation of the diagenesis reaction are presented in the sediment model documentation. Specify diagenesis in units of day<sup>-1</sup> at 20° C. The temperature effect parameter is dimensionless.

### FORMAT

(8F10.0)

### EXAMPLE

0.035    1.10    0.0018    1.150    0.00000    1.17

## Carbon Diagenesis Rates

Field	Name	Value	Description
1	KCDIAG(1)	Fixed	Diagenesis rate of G1 carbon at 20° C (day <sup>-1</sup> )
2	DCTHTA(1)	Fixed	Effect of temperature on G1 carbon diagenesis
3	KCDIAG(2)	Fixed	Diagenesis rate of G2 carbon at 20° C (day <sup>-1</sup> )
4	DCTHTA(2)	Fixed	Effect of temperature on G2 carbon diagenesis
5	KCDIAG(3)	Fixed	Diagenesis rate of G3 carbon at 20° C (day <sup>-1</sup> )
6	DCTHTA(3)	Fixed	Effect of temperature on G3 carbon diagenesis

G1, G2, G3 classes of organic matter undergo diagenesis (decay) at different rates. Diagenesis is enhanced at higher temperatures, diminished at lower temperatures. Details of the formulation of the diagenesis reaction are presented in the sediment model documentation. Specify diagenesis in units of day<sup>-1</sup> at 20° C. The temperature effect parameter is dimensionless.

### FORMAT

(8F10.0)

### EXAMPLE

0.035    1.10    0.0018    1.150    0.00000    1.17

## Silica Dissolution Rate

Field	Name	Value	Description
1	KSI	Fixed	Dissolution rate of particulate biogenic silica at 20° C (day <sup>-1</sup> )
2	THTASI	Fixed	Effect of temperature on silica dissolution

Particulate biogenic silica undergoes dissolution at a first-order rate. Dissolution is enhanced at higher temperatures, diminished at lower temperatures. Details of the formulation of the dissolution process are presented in the sediment model documentation. Specify dissolution in units of day<sup>-1</sup> at 20° C. The temperature effect parameter is dimensionless.

### FORMAT

(8F10.0)

### EXAMPLE

0.500 1.10

## Additional Constants

Field	Name	Value	Description
1	M1	Fixed	Solids concentration in sediment layer 1 (kg L <sup>-1</sup> )
2	M2	Fixed	Solids concentration in sediment layer 2 (kg L <sup>-1</sup> )
3	THTADP	Fixed	Effect of temperature on particle mixing rate
4	THTADD	Fixed	Effect of temperature on porewater diffusion coefficient

Specification of inorganic solids concentration in the sediments is required in order to compute concentration and flux of substances sorbed to these solids. Specify solids concentration in kg L<sup>-1</sup>. Both particle mixing and diffusion of dissolved substances are affected by temperature. Formulation of the temperature effect is presented in the sediment model documentation. The temperature effect parameter is dimensionless.

### FORMAT

(8F10.0)

### EXAMPLE

0.5      0.5      1.117      1.08

## Ammonium Kinetics Parameters

Field	Name	Value	Description
1	KAPPNH4F	Fixed	Freshwater nitrification reaction velocity at 20° C (m day <sup>-1</sup> )
2	KAPPNH4S	Fixed	Saltwater nitrification reaction velocity at 20° C (m day <sup>-1</sup> )
3	PIENH4	Fixed	Partition coefficient between dissolved and sorbed ammonium (L kg <sup>-1</sup> )
4	THTANH4	Fixed	Effect of temperature on nitrification rate
5	KMNH4	Fixed	Half-saturation concentration of ammonium in nitrification reaction (mg N m <sup>-3</sup> )
6	KMNH4O2	Fixed	Half-saturation concentration of dissolved oxygen in nitrification reaction (gm O <sub>2</sub> m <sup>-3</sup> )

This line provides kinetic parameters for reactions of ammonium in the sediments. Details of the kinetics formulations are presented in the sediment model documentation.

### FORMAT

(8F10.0)

### EXAMPLE

0.200 0.140 1.0 1.08 1500. 1.00



## Nitrate Kinetics Parameters

Field	Name	Value	Description
1	KAPPNO3F	Fixed	Freshwater denitrification reaction velocity in sediment layer 1 at 20° C (m day <sup>-1</sup> )
2	KAPPNO3S	Fixed	Saltwater denitrification reaction velocity in sediment layer 1 at 20° C (m day <sup>-1</sup> )
3	K2NO3	Fixed	Denitrification reaction velocity in sediment layer 2 at 20° C (m day <sup>-1</sup> )
4	THTANO3	Fixed	Effect of temperature on denitrification rate

This line provides kinetic parameters for reactions of nitrate in the sediments. Details of the kinetics formulations are presented in the sediment model documentation.

### FORMAT

(8F10.0)

### EXAMPLE

0.3    0.125    0.25    1.08

## Sulfide Kinetics Parameters

Field	Name	Value	Description
1	KAPPD1	Fixed	Dissolved sulfide reaction velocity at 20° C (m day <sup>-1</sup> )
2	KAPPP1	Fixed	Particulate sulfide reaction velocity at 20° C (m day <sup>-1</sup> )
3	PIE1S	Fixed	Partition coefficient between dissolved and sorbed sulfide in layer 1 (L kg <sup>-1</sup> )
4	PIE2S	Fixed	Partition coefficient between dissolved and sorbed sulfide in layer 2 (L kg <sup>-1</sup> )
5	THTAPD1	Fixed	Effect of temperature on sulfide oxidation rate
6	KMHSO2	Fixed	Effect of dissolved oxygen on sulfide oxidation (gm O <sub>2</sub> m <sup>-3</sup> )

This line provides kinetic parameters for reactions of sulfide in the sediments. Details of the kinetics formulations are presented in the sediment model documentation.

### FORMAT

(8F10.0)

### EXAMPLE

0.2      0.4      100.      100.      1.08      4.0

## Silica Kinetics Parameters

Field	Name	Value	Description
1	CSISAT	Fixed	Saturation concentration of porewater silica ( $\text{mg Si m}^{-3}$ )
2	DPIE1SI	Fixed	Partition coefficient between dissolved and sorbed silica in layer 1 ( $\text{L kg}^{-1}$ )
3	PIE2SI	Fixed	Partition coefficient between dissolved and sorbed silica in layer 2 ( $\text{L kg}^{-1}$ )
4	KMPSI	Fixed	Half-saturation concentration of dissolved silica in dissolution reaction ( $\text{mg Si m}^{-3}$ )

This line provides kinetic parameters for reactions of silica in the sediments. Details of the kinetics formulations are presented in the sediment model documentation.

### FORMAT

(8F10.0)

### EXAMPLE

40000. 10.0 100. 5.00E+07

## Additional Silica Kinetics Parameters

Field	Name	Value	Description
1	O2CRITSI	Fixed	Effect of dissolved oxygen on silica sorption ( $\text{gm O}_2 \text{m}^{-3}$ )
2	JSIDETR	Fixed	Distributed source of sediment biogenic silica ( $\text{mg Si m}^{-2} \text{day}^{-1}$ )

This line provides additional kinetic parameters for reactions of silica in the sediments. Details of the kinetics formulations are presented in the sediment model documentation.

### FORMAT

(8F10.0)

### EXAMPLE

1.0 100.0

## Phosphate Kinetics Parameters

Field	Name	Value	Description
1	DPIE1PO4F	Fixed	Freshwater partition coefficient between dissolved and sorbed phosphate in layer 1 ( $L\ kg^{-1}$ )
2	DPIE1PO4S	Fixed	Saltwater partition coefficient between dissolved and sorbed phosphate in layer 1 ( $L\ kg^{-1}$ )
3	PIE2PO4	Fixed	Partition coefficient between dissolved and sorbed phosphate in layer 2 ( $L\ kg^{-1}$ )
4	O2CRIT	Fixed	Effect of dissolved oxygen on phosphate sorption in layer 1 ( $gm\ O_2\ m^{-3}$ )
5	KMO2DP	Fixed	Half-saturation concentration for dissolved oxygen effect on particle mixing ( $gm\ O_2\ m^{-3}$ )

This line provides kinetic parameters for reactions of phosphate in the sediments. Details of the kinetics formulations are presented in the sediment model documentation.

### FORMAT

(8F10.0)

### EXAMPLE

3000. 300. 100. 2. 4.0

## Benthic Stress Kinetics Parameters

Field	Name	Value	Description
1	TEMPBEN	Fixed	Temperature at which benthic stress is reset to zero (C°)
2	KBENSTR	Fixed	First-order rate at which benthic stress subsides (day <sup>-1</sup> )
3	KLBNTH	Fixed	Ratio of bioirrigation to bioturbation
4	DPMIN	Fixed	Minimum particle mixing coefficient (m <sup>2</sup> day <sup>-1</sup> )

Benthic stress is a model parameter which quantifies the adverse effect of low dissolved oxygen on benthic infauna. Under conditions of high stress, sediment mixing caused by infauna declines. Details of the benthic stress formulation are presented in the sediment model documentation.

### FORMAT

(8F10.0)

### EXAMPLE

10.0      0.03      0.0      3.0e-6

## Methane Kinetics Parameters

Field	Name	Value	Description
1	KAPPCH4	Fixed	Methane oxidation reaction velocity at 20° C (m day <sup>-1</sup> )
2	THTACH4	Fixed	Effect of temperature on methane oxidation

Methane oxidation occurs in freshwater sediments. Details of the methane kinetics are found in the sediment model documentation.

### FORMAT

(8F10.0)

### EXAMPLE

0.2      1.08

## Settling, Burial, and Mixing Parameters

Field	Name	Value	Description
1	WSSNET	Fixed	Net settling velocity of suspended solids to sediment (m day <sup>-1</sup> )
2	WLSNET	Fixed	Net settling velocity of labile organic particles to sediment (m day <sup>-1</sup> )
3	WSRNET	Fixed	Net settling velocity of refractory organic particles to sediment (m day <sup>-1</sup> )
4	WSCNET	Fixed	Net settling velocity of algal group 1 (blue-greens) to sediment (m day <sup>-1</sup> )
5	WSDNET	Fixed	Net settling velocity of algal group 2 (diatoms) to sediment (m day <sup>-1</sup> )
6	WSGNET	Fixed	Net settling of velocity of algal group 3 (greens) to sediment (m day <sup>-1</sup> )
7	VSED	Fixed	Net sedimentation (burial) velocity (m day <sup>-1</sup> )
8	VPMIX	Fixed	Particle mixing coefficient (m <sup>2</sup> day <sup>-1</sup> )
9	VDMIX	Fixed	Porewater diffusion coefficient (m <sup>2</sup> day <sup>-1</sup> )

Settling, burial, and mixing parameters must be specified for each sediment box. Variables are read in numerical order starting with sediment box 1. The FORMAT statement allows for a four-line header and for listing of box number but these are not read into the model.

### FORMAT

(:////(8X,9F8.1))

### EXAMPLE

```
blank header line
blank header line
  BOX  WSSNET  WLSNET  WSRNET  WSCNET  WSDNET  WSGNET  VSED  VPMIX  VDMIX
    1   0.000   1.000   1.000   0.000   0.100   0.100   0.250 0.00012 0.00100
```

## Coupling Water Quality and Sediment Model Organic Matter

Field	Name	Value	Description
1	FRPOP(BB,2)	Fixed	Fraction water column refractory phosphorus routed into sediment model G2 class
2	FRPOP(BB,3)	Fixed	Fraction water column refractory phosphorus routed into sediment model G3 class
3	FRPON(BB,2)	Fixed	Fraction water column refractory nitrogen routed into sediment model G2 class
4	FRPON(BB,3)	Fixed	Fraction water column refractory nitrogen routed into sediment model G3 class
5	FRPOC(BB,2)	Fixed	Fraction water column refractory carbon routed into sediment model G2 class
6	FRPOC(BB,3)	Fixed	Fraction water column refractory carbon routed into sediment model G3 class

The water quality model has two classes of organic particulate matter: labile and refractory. The sediment model has three classes: G1 (labile), G2 (refractory), G3 (slow refractory or inert). The water quality refractory particles must be mapped into G2 and G3 particles in the sediment. Individual fractionation is required for each sediment box. Variables are read in numerical order starting with sediment box 1. The FORMAT statement allows for a four-line header and for listing of box number but these are not read into the model.

### FORMAT

```
(:////(8X,6F8.1))
```

### EXAMPLE

```
blank header line
blank header line
  BOX   FRG2P   FRG3P   FRG2N   FRG3N   FRG2C   FRG3C
    1   0.500   0.500   0.333   0.667   0.250   0.750
```





## User-Specified Fluxes

As an alternative to the sediment submodel, the water quality model allows for user-specified benthic fluxes. If BFC = "ON" is selected in the Control File, the fluxes are specified in the Benthic Flux Input File. The first three lines of the file are reserved for comments and identification. Three card groups, each consisting of a header and input, follow. These groups specify parameters in the functions which relate specified fluxes to temperature and other influences (refer to Chapter 4). The remainder of the file is occupied by specified fluxes. Fluxes must be specified once at commencement of the model run. Fluxes may be updated at arbitrary intervals throughout the run.

### Temperature Effects Card

Field	Name	Value	Description
1	KSDOC	Real	Effect of temperature on dissolved organic carbon flux
2	KSNH4	Real	Effect of temperature on ammonium flux
3	KSNO3	Real	Effect of temperature on nitrate flux
4	KSPO4	Real	Effect of temperature on phosphate flux
5	KSO	Real	Effect of temperature on sediment oxygen demand
6	KSSA	Real	Effect of temperature on silica flux

### EXAMPLE

KSDOC	KSNH4	KSNO3	KSPO4	KSO	KSSA
0.0693	0.0693	0.0693	0.0693	0.0693	0.0693

### FORMAT

(8X,9F8.0)

## Temperature Effects

Field	Name	Value	Description
1	TRSDOC	Real	Reference temperature for dissolved organic carbon flux
2	TRSNH4	Real	Reference temperature for ammonium flux
3	TRSNO3	Real	Reference temperature for nitrate flux
4	TRSP04	Real	Reference temperature for phosphate flux
5	TRSOD	Real	Reference temperature for sediment oxygen demand
6	TRSSA	Real	Reference temperature for silica flux

### EXAMPLE

```

TRSDOC TRSNH4 TRSNO3 TRSP04 TRSOD TRSSA
 20.0   20.0   20.0   20.0   20.0   20.0

```

### FORMAT

```
(://8X,9F8.0)
```

## Additional Parameters

Field	Name	Value	Description
1	MTCNO3	Real	Nitrate mass transfer coefficient (m day <sup>-1</sup> )
2	SEDNO3	Real	Interstitial nitrate concentration (gm m <sup>-3</sup> )
3	KHSO	Real	Dissolved oxygen at which sediment oxygen consumption is halved

### EXAMPLE

```

MTCNO3 SEDNO3 KHSO
 0.1    0.00   2.00

```

### FORMAT

```
(://8X,9F8.0)
```

## Benthic Fluxes

Field	Name	Value	Description
1	Jday	Real	Julian day
2-9	Flux	Real	Benthic flux (gm m <sup>-2</sup> day <sup>-1</sup> )

### EXAMPLE

```
DOC          0.0  1.0000  0.0000  0.0000  0.0000  0.0000  0.0000  0.0000  0.0000  0.0000
              0.0000  0.0000  0.0000  0.0000  0.0000  0.0000  0.0000  0.0000  0.0000
```

### FORMAT

```
(8X,9F8.0,:(:16X,8F8.0))
```

## Example of User-Specified Benthic Flux File

In the following example, fluxes are specified at Julian day 0 and revalued at day 110.

BENTHIC FLUX FILE FOR THIRTY-BOX BAY MODEL  
FEBRUARY 22, 1994

	KSDOC	KSNH4	KSN03	KSP04	KSO	KSSA			
	0.0693	0.0693	0.0693	0.0693	0.0693	0.0693			
	TRSDOC	TRSNH4	TRSN03	TRSP04	TRSOD	TRSSA			
	20.0	20.0	20.0	20.0	20.0	20.0			
	MTCNO3	SEDNO3	KHSO						
	0.1	0.00	2.00						
PARAM	JDAY	G/M2/DY	G/M2/DY	G/M2/DY	G/M2/DY	G/M2/DY	G/M2/DY	G/M2/DY	G/M2/DY
DOC	0.0	1.0000	0.0000	0.0000	0.0000	0.0000	0.0000	0.0000	0.0000
		0.0000	0.0000						
NH4	0.0	0.1000	0.0100	0.0700	0.0700	0.0700	0.0700	0.0700	0.0700
		0.0700	0.0700						
NO3	0.0	0.1000	0.0000	0.0000	0.0000	0.0000	0.0000	0.0000	0.0000
		0.0000	0.0000						
DON	0.0	1.0000	0.0000	0.0000	0.0000	0.0000	0.0000	0.0000	0.0000
		0.0000	0.0000						
PO4	0.0	0.1000	0.0100	0.0090	0.0090	0.0090	0.0090	0.0090	0.0090
		0.0090	0.0090						
DOP	0.0	1.0000	0.0000	0.0000	0.0000	0.0000	0.0000	0.0000	0.0000
		0.0000	0.0000						
COD	0.0	1.0000	0.0000	0.0000	0.0000	0.0000	0.0000	0.0000	0.0000
		0.0000	0.0000						
SOD	0.0	-1.4500	-1.4500	-1.4500	-1.4500	-1.4500	-1.4500	-1.4500	-1.4500
		-1.4500	-1.4500						
DSIL	0.0	1.0000	0.0000	0.0000	0.0000	0.0000	0.0000	0.0000	0.0000
		0.0000	0.0000						
DOC	110.0	0.0000	0.0000	0.0000	0.0000	0.0000	0.0000	0.0000	0.0000
		0.0000	0.0000						
NH4	110.0	0.0700	0.0700	0.0700	0.0700	0.0700	0.0700	0.0700	0.0700
		0.0700	0.0700						
NO3	110.0	0.0000	0.0000	0.0000	0.0000	0.0000	0.0000	0.0000	0.0000
		0.0000	0.0000						
DON	110.0	0.0000	0.0000	0.0000	0.0000	0.0000	0.0000	0.0000	0.0000
		0.0000	0.0000						
PO4	110.0	0.0090	0.0090	0.0090	0.0090	0.0090	0.0090	0.0090	0.0090
		0.0090	0.0090						
DOP	110.0	0.0000	0.0000	0.0000	0.0000	0.0000	0.0000	0.0000	0.0000
		0.0000	0.0000						
COD	110.0	0.0000	0.0000	0.0000	0.0000	0.0000	0.0000	0.0000	0.0000
		0.0000	0.0000						
SOD	110.0	-1.4500	-1.4500	-1.4500	-1.4500	-1.4500	-1.4500	-1.4500	-1.4500
		-1.4500	-1.4500						
DSIL	110.0	0.0000	0.0000	0.0000	0.0000	0.0000	0.0000	0.0000	0.0000
		0.0000	0.0000						

# 23 ASCII Output Files

---

## Snapshot File

The Snapshot File is the primary ASCII output file. Every model run produces a Snapshot File. The first portion of the file lists run specifications input in the Control File. The information listed includes:

Run title and comments.

Input and output file names.

Geometry, time step, and run duration specifications.

Input and output control specifications.

Additional run control specifications.

List of active constituents.

Kinetics parameters.

The balance of the Snapshot File is devoted to ASCII printout of computed concentrations. The printout is an instantaneous “snapshot” of model computations. The times of snapshot output are specified in the Snapshot Control card group in the Control File.

Concentrations are listed for all model cells for all active state variables. Temperature is reported in degrees Celsius. Salinity is reported in parts per thousand. Total active metal is reported in moles per cubic meter. All other state variables are reported in grams per cubic meter. If the sediment sub-model is active, computed concentrations are provided for the sediment as well. All sediment model state variables are reported in milligrams per cubic meter except benthic stress which has no dimension.

The Snapshot File provides a quick view of model computations. The file is especially useful in diagnosing failed model runs. Contents of the file may

also be “cut and pasted” into an initial conditions file or used as plot input. The binary plot files are the recommended form of plot input, however.

## Benthic Flux Output File

The Benthic Flux Output File is analogous to the Snapshot File. Production of the file is not automatic, however. The file is produced only when “BFOC = ON” is specified on the Miscellaneous Controls card in the Control File.

Contents of the Benthic Flux Output File depend on the specification of benthic fluxes. If the predictive submodel is employed, the file lists input to the submodel including sediment initial conditions. Computed fluxes are provided only in the binary plot files. If user-specified fluxes are employed, the first portion of Benthic Flux Output File lists the parameters that determine effects of temperature and other factors on the specified fluxes. The balance of the file lists, in ASCII, computed fluxes. All fluxes are in  $\text{gm m}^{-2} \text{day}^{-1}$ . The fluxes are output at the same intervals as snapshot printouts.

## Diagnostic File

The Diagnostic File contains information on model performance. The file is especially useful during the model set-up phase and in diagnosing failed model runs. The Diagnostic File is produced when “DIAC = ON” is specified in the Diagnostic Output Control card group in the Control File. Times at which diagnostics are produced are specified in the same group.

## Time-Step Diagnostics

The Diagnostic File reports, at user-specified intervals:

Julian days since commencement of model run.

Number of iterations since commencement of model run.

Current time step (seconds).

Average time step since commencement of model run (seconds).

Maximum Courant number at current time step.

Face at which maximum Courant number occurs.

Cell upstream of maximum Courant number face.

Maximum diffusion number at current time step.

Face at which maximum diffusion number occurs.

Cell upstream of maximum diffusion number face.

The Courant number is computed:

$$C = \frac{Q(F)}{V} \Delta t \quad (23-1)$$

$C$  = Courant number

$Q(F)$  = volumetric flow at flow face F

$V$  = cell volume upstream of flow face

$\Delta t$  = time step

The diffusion number is computed:

$$DN = \frac{D \Delta t A^2}{V^2} \quad (23-2)$$

$DN$  = diffusion number

$D$  = horizontal dispersion coefficient

$A$  = area of flow face F

$V$  = cell volume upstream of flow face

$\Delta t$  = time step

The Courant and diffusion numbers defined above are analogous to the parameters defined in the section on autostepping (Chapter 2). The time-step diagnostics aid in the location of model cells and faces which limit the model time step.

## Volume-Balance Diagnostics

Cell volumes are initiated whenever a hydrodynamic file is opened. Subsequent to initiation, cell volumes are computed in the water quality model as a function of volumetric flows specified in the hydrodynamics file.

Volume-balance diagnostics compare cell volumes computed in the model with cell volumes produced by the hydrodynamic model. Volume-balance diagnostics are produced when "VBC = ON" is specified on the Miscellaneous Controls card in the Control File.

The Diagnostic File reports, at user-specified intervals:

Total volume of water quality model grid (m<sup>3</sup>).

Difference between water quality model volume and hydrodynamic model volume (%).

Difference between water quality model volume and hydrodynamic model volume (m<sup>3</sup>).

In addition to global volume statistics, any cells in which the difference in water quality model volume and hydrodynamic model volume exceeds ten cubic meters are listed.

The volume-balance diagnostics are useful during preparation of the map and hydrodynamics input files. Errors in mapping flow faces or reading hydrodynamics become rapidly apparent in the form of volume imbalances. Volume imbalances also may accrue slowly during a model run. Slow accumulation of volume imbalances usually results from round-off error in the water quality model. Appropriate variables have been declared as DOUBLE PRECISION in the INCLUDE File to combat roundoff error. The DOUBLE PRECISION specification is not necessary on a high-precision supercomputer but is required in personal computer and workstation environments.

## Mass-Balance Diagnostics

The model provides mass-balance summary statistics in the Diagnostic File when "MBLC = ON" is specified in the Mass-Balance Control card group in the Control File. Frequency of statistical output is specified in the same group. Mass-balance statistics include:

Total mass of each active constituent.

Mass-balance error in water column of nitrogen, phosphorus and carbon (%).

Mass-balance error in sediments of nitrogen, phosphorus and carbon (%).

The mass-balance error is computed:



$$MBE = 100 \frac{M(t) - M(0) - \sum SS}{M(t) - M(0)} \quad (23-3)$$

*MBE* = mass-balance error

*M(t)* = nutrient mass at time t

*M(0)* = initial nutrient mass

$\sum SS$  = sum of nutrient sources and sinks since initiation of mass balance

Nutrient masses and the sums of sources and sinks are initialized whenever a hydrodynamic file is opened. When mass balance is perfect, the sum of sources and sinks exactly equals the change in mass since initiation of the balance.

The mass-balance statistic provides a check on linkage between hydrodynamic and water quality models. The statistic also provides a check on accuracy of computations internal to the water quality model. Typical mass-balance error at completion of a model run should be  $\approx 10^{-2}\%$ . The user is cautioned that the percent mass-balance error can become unlimited, however, if *M(t)* approaches *M(0)*.

### **File status**

Input file names and times at which they are opened are reported in the Diagnostic File.

# 24 Binary Output Files

---

## Introduction

The model produces numerous unformatted binary output files. Two of the files, the Initial Conditions Output File and Restart Output File, are produced for use as input in subsequent model runs. The remainder of the files are the primary output files for model computations. At present, the user must provide programs which read and process model output. A post-processing package to accompany the model is planned as a future development.

## Initial Conditions Output File

An Initial Conditions Output File is produced at completion of the model run when "ICOC = ON" is specified on the Miscellaneous Controls card in the Control File. The file contains concentrations of all state variables in the water column and sediment. If the steady-state integration option is selected in the Benthic Flux Input File, G3 sediment concentrations at completion of the model run are replaced with estimated steady-state concentrations.

The Initial Conditions Output File from a previous model run is employed as input when "ICIC = BINARY" is specified on the Miscellaneous Controls card in the Control File. Production and employment of binary initial conditions provide a convenient means of looping successive runs while calibrating the model.

## Restart Output File

One or more Restart Output Files are produced when "RSOC = ON" is specified in the Restart Output card group in the Control File. The Restart Output File contains virtually all variables computed within the model. Creation of restart files provides information required to resume a model run after an abnormal termination.

Restart Output Files are produced at intervals specified in the Restart Output card group. Files are distinguished through a convention provided by the model. The model replaces the last three characters of the Restart Output File name specified in the Control File with the Julian day at which the file is produced. For example, a file “wqm\_rso.123” is produced at Julian day 123 when “wqm\_rso.opt” is specified as the Restart Output File name. Julian day is truncated to an integer value. No more than one restart file can be produced per Julian day.

A model run is resumed using variables in a restart file when “RSIC = ON” is specified in the Restart Output card group in the Control File.

## Plot File

The Plot File contains instantaneous values of concentrations computed within the water column. The Plot File is produced when “PLTC = ON” is specified in the Plot Output Control card group in the Control file. Parameters in the same card group determine the frequency of plot output. Additional output, termed diagnostic information, is produced when “QPLTC = ON” is specified. Sediment-water fluxes and concentrations within the sediments are written to the Plot File when “SPLTC = ON” is specified.

Since the Plot File is unformatted, the user must take great care in reading the file into a postprocessing program. A basic guideline is that the READ statements in the postprocessor should conform exactly to the WRITE statements in the model. Correct results require that variable type and array dimensions agree between the model and the postprocessor.

Header information is written to the Plot File once when it is opened. The WRITE statement is:

```
IF (PLOTS) WRITE (PLT) TITLE,NAC,AC,NB,QUALITY_DIAG,
.             SEDIMENT_DIAG,CCHLC,CCHLD,CCHLG,ANCC,ANCD,
.             ANCG,KADPO4,KADSA
```

## Variables

Variables in the header are summarized in Table 24-1.

Subsequent information is written to the Plot File repeatedly at intervals specified in the Plot Output Control card group. The WRITE statements are:

```
WRITE (PLT) JDAY,((C1(B,AC(JC)),B=1,NB),JC=1,NAC)
WRITE (PLT) TAMP,APC
IF (QUALITY_DIAG) WRITE (PLT) FIC, NLC, PLC, FID,
.             NLD, PLD, SLD, FIG,
.             NLG, PLG, NPP, RESP,
.             KESS
```

```

IF (SEDIMENT_DIAG) WRITE (PLT) BENDOC, BENNH4, BENNO3,
.      BENPO4, BENCOD, BENDO,
.      BENSA, SSFWS, PCFWS,
.      PNFWS, PPFWS, PSFWS,
.      CPOC, CPON, CPOP,
.      CPIP, CPOS

```

Variables in the WRITE statements are summarized in Table 24-1.

<b>Table 24-1 Variables Written to Plot Output File</b>			
<b>Variable</b>	<b>Type</b>	<b>Definition</b>	<b>Units</b>
TITLE	An array with six elements. Each element is CHARACTER*72.	Six title lines from the head of the control file.	
NAC	INTEGER	Number of active constituents	
AC	An INTEGER array with 22 elements.	Sequential number of active constituents. See explanation below.	
NB	INTEGER	Number of cells in model grid	
QUALITY_DIAG	LOGICAL	.TRUE. if diagnostic information is written to the Plot File. .FALSE. otherwise.	
SEDIMENT_DIAG	LOGICAL	.TRUE. if sediment output is written to the Plot File. .FALSE. otherwise.	
CCHLC	REAL	Cyanobacteria carbon-to-chlorophyll ratio	gm C mg <sup>-1</sup> chl
CCHLD	REAL	Diatom carbon-to-chlorophyll ratio	gm C mg <sup>-1</sup> chl
CCHLG	REAL	Green algal carbon-to-chlorophyll ratio	gm C mg <sup>-1</sup> chl
ANCC	REAL	Cyanobacteria nitrogen-to-carbon ratio	gm N gm <sup>-1</sup> C
ANCD	REAL	Diatom nitrogen-to-carbon ratio	gm N gm <sup>-1</sup> C
ANCG	REAL	Green algal nitrogen-to-carbon ratio	gm N gm <sup>-1</sup> C

*(Sheet 1 of 4)*

Table 24-1 (Continued)			
Variable	Type	Definition	Units
KADPO4	REAL	Partition coefficient of sorbed vs. dissolved phosphate	$\text{m}^3 \text{mol}^{-1}$
KADSA	REAL	Partition coefficient of sorbed vs. dissolved available silica	$\text{m}^3 \text{mol}^{-1}$
JDAY	REAL	Julian day elapsed since beginning of run	day
C1	A REAL array dimensioned (0:NBP,NCP). NBP = maximum number of cells. NCP = maximum number of state variables. These are assigned in the INCLUDE file.	C1 is the array containing computed concentrations. See explanation below.	See explanation below
NB	INTEGER	Number of cells in grid	
NAC	INTEGER	Number of active constituents	
TAMP	A REAL array dimensioned (0:NBP)	Concentration of particulate total active metal	$\text{mol m}^{-3}$
APC	A REAL array dimensioned (0:NBP)	Algal phosphorus to carbon ratio	$\text{gm P gm}^{-1} \text{C}$
FIC	A REAL array dimensioned (NBP)	Computed light limitation on cyanobacteria growth	$0 \leq \text{FIC} \leq 1$
NLC	A REAL array dimensioned (NBP)	Computed nitrogen limitation on cyanobacteria growth	$0 \leq \text{NLC} \leq 1$
PLC	A REAL array dimensioned (NBP)	Computed phosphorus limitation on cyanobacteria growth	$0 \leq \text{PLC} \leq 1$
FID	A REAL array dimensioned (NBP)	Computed light limitation on diatom growth	$0 \leq \text{FID} \leq 1$
NLD	A REAL array dimensioned (NBP)	Computed nitrogen limitation on diatom growth	$0 \leq \text{NLD} \leq 1$
NLD	A REAL array dimensioned (NBP)	Computed nitrogen limitation on diatom growth	$0 \leq \text{NLD} \leq 1$

(Sheet 2 of 4)

<b>Table 24-1 (Continued)</b>			
<b>Variable</b>	<b>Type</b>	<b>Definition</b>	<b>Units</b>
PLD	A REAL array dimensioned (NBP)	Computed phosphorus limitation on diatom growth	$0 \leq \text{PLD} \leq 1$
SLD	A REAL array dimensioned (NBP)	Computed silica limitation on diatom growth	$0 \leq \text{SLD} \leq 1$
FIG	A REAL array dimensioned (NBP)	Computed light limitation on green algal growth	$0 \leq \text{FIG} \leq 1$
NLG	A REAL array dimensioned (NBP)	Computed nitrogen limitation on green algal growth	$0 \leq \text{NLG} \leq 1$
PLG	A REAL array dimensioned (NBP)	Computed phosphorus limitation on green algal growth	$0 \leq \text{PLG} \leq 1$
NPP	A REAL array dimensioned (NBP)	Computed algal net primary production	gm C m <sup>-2</sup> day <sup>-1</sup>
RESP	A REAL array dimensioned (NBP)	Total oxygen consumption in water column	gm DO m <sup>-3</sup>
KESS	A REAL array dimensioned (NBP)	Computed light extinction including algal shading	m <sup>-1</sup>
BENDOC	A REAL array dimensioned (NSBP). NSBP = maximum number of surface cells. NSBP is assigned in the INCLUDE file.	Sediment-water dissolved organic carbon flux.	gm C m <sup>-2</sup> day <sup>-1</sup> , positive from sediment to water
BENNH4	A REAL array dimensioned (NSBP)	Sediment-water ammonium flux.	gm N m <sup>-2</sup> day <sup>-1</sup>
BENNO3	A REAL array dimensioned (NSBP)	Sediment-water nitrate flux.	gm N m <sup>-2</sup> day <sup>-1</sup>
BENPO4	A REAL array dimensioned (NSBP)	Sediment-water phosphate flux.	gm P m <sup>-2</sup> day <sup>-1</sup>
BENCOD	A REAL array dimensioned (NSBP)	Sediment-water COD flux.	gm O <sub>2</sub> m <sup>-2</sup> day <sup>-1</sup>
BENDO	A REAL array dimensioned (NSBP)	Sediment oxygen demand	gm O <sub>2</sub> m <sup>-2</sup> day <sup>-1</sup>
BENCOD	A REAL array dimensioned (NSBP)	Sediment-water COD flux.	gm O <sub>2</sub> m <sup>-2</sup> day <sup>-1</sup>
BENDO	A REAL array dimensioned (NSBP)	Sediment oxygen demand	gm O <sub>2</sub> m <sup>-2</sup> day <sup>-1</sup>

(Sheet 3 of 4)

<b>Table 24-1 (Continued)</b>			
<b>Variable</b>	<b>Type</b>	<b>Definition</b>	<b>Units</b>
BENSA	A REAL array dimensioned (NSBP)	Sediment-water silica flux.	gm Si m <sup>-2</sup> day <sup>-1</sup>
SSFWS	A REAL array dimensioned (NSBP)	Solids flux from water to sediment. Total active metal in present model configuration.	mol m <sup>-2</sup> day <sup>-1</sup> , negative from water to sediment
PCFWS	A REAL array dimensioned (NSBP)	Particulate carbon flux from water to sediment	gm C m <sup>-2</sup> day <sup>-1</sup>
PNFWS	A REAL array dimensioned (NSBP)	Particulate nitrogen flux from water to sediment	gm N m <sup>-2</sup> day <sup>-1</sup>
PPFWS	A REAL array dimensioned (NSBP)	Particulate phosphorus flux from water to sediment	gm P m <sup>-2</sup> day <sup>-1</sup>
PSFWS	A REAL array dimensioned (NSBP)	Particulate silica flux from water to sediment	gm Si m <sup>-2</sup> day <sup>-1</sup>
CPOC	A REAL array dimensioned (NSBP,3)	Particulate organic carbon concentration in sediment. Second subscript denotes G1, G2, G3 fractions, respectively	mg C m <sup>-3</sup>
CPON	A REAL array dimensioned (NSBP,3)	Particulate organic nitrogen concentration in sediment. Second subscript denotes G1, G2, G3 fractions, respectively	mg N m <sup>-3</sup>
CPOP	A REAL array dimensioned (NSBP,3)	Particulate organic phosphorus concentration in sediment. Second subscript denotes G1, G2, G3 fractions, respectively	mg P m <sup>-3</sup>
CPIP	A REAL array dimensioned (NSBP)	Particulate inorganic phosphorus concentration in sediment	mg P m <sup>-3</sup>
CPOS	A REAL array dimensioned (NSBP)	Particulate biogenic silica concentration in sediment	mg Si <sup>-3</sup>

(Sheet 4 of 4)

## Sequencing of active constituents

In its present configuration, the model computes a maximum of 22 state variables or constituents. Each constituent is assigned an invariant serial number. These are listed in Table 24-2.

Serial Number	Variable	Serial Number	Variable
1	Temperature	12	Dissolved organic nitrogen
2	Salinity	13	labile particulate organic nitrogen
3	Total active metal	14	refractory particulate organic nitrogen
4	Cyanobacteria	15	Total phosphate
5	Diatoms	16	Dissolved organic phosphorus
6	Green algae	17	Labile particulate organic phosphorus
7	Dissolved Organic Carbon	18	Refractory particulate organic phosphorus
8	Labile Particulate Organic Carbon	19	Chemical oxygen demand
9	Refractory Particulate Organic Carbon	20	Dissolved oxygen
10	Ammonium	21	Particulate biogenic silica
11	Nitrate + nitrite	22	Dissolved silica

The C1 array contains only the state variables which are “active” as specified in the Active Constituents card group in the Control File. The active variables are indicated by placing their serial numbers in array AC. The total number of active constituents is indicated by variable NAC. For example, if temperature, salinity, and dissolved oxygen are the only active state variables, NAC = 3. The first three elements of array AC are 1, 2, 20. The remaining elements of AC are 0. Vector C1(B,1) contains temperature predictions. Vector C1(B,2) contains salinity predictions. Vector C1(B,3) contains dissolved oxygen predictions.



## Average Plot File

The Average Plot File contains average values of concentrations computed within the water column. The Average Plot File is produced when "APLC = ON" is specified in the Average Plot Output Control card group in the Control file. Parameters in the same card group determine the interval over which model computations are averaged. Averages of diagnostic information and sediment-water fluxes are produced when "QPLTC = ON" and "SPLTC = ON" are specified.

Since the Average Plot File is unformatted, the user must take great care in reading the file into a postprocessing program. A basic guideline is that the READ statements in the postprocessor should conform exactly to the WRITE statements in the model. Correct results require that variable type and array dimensions agree between the model and the postprocessor.

Header information is written to the Average Plot File once when it is opened. The WRITE statements are:

```
WRITE (APL) TITLE,NAC,AC,NB,QUALITY_DIAG,
.   SEDIMENT_DIAG,CCHLC,CCHLD,CCHLG,ANCC,ANCD,ANCG,
.   KADPO4,KADSA
WRITE (APL) NSB,V1,SFA
```

The first WRITE statement is identical to the statement that initiates the Plot File. Variables in the second WRITE statement are summarized in Table 24-3.

Variable	Type	Definition	Units
NSB	INTEGER	Number of surface cells in grid	
V1	A REAL array dimensioned (0:NBP). NBP = maximum number of cells assigned in the INCLUDE file.	Volume of model cell	m <sup>3</sup>
SFA	A REAL array dimensioned (NSBP). NSBP = maximum number of surface cells assigned in the INCLUDE file.	Surface area of model cell	m <sup>2</sup>
C1MAX	A REAL array dimensioned (NBP,NCP). NBP = maximum number of cells. NCP = maximum number of state variables. These are assigned in the INCLUDE file.	Maximum value of constituent that occurred during averaging interval	
C1MIN	A REAL array dimensioned (NBP,NCP).	Minimum value of constituent that occurred during averaging interval	

Subsequent information is written to the Average Plot File repeatedly at intervals specified in the Average Plot Output Control card group. The WRITE statements are:

```

WRITE (APL) JDAY,((AC1(B,AC(JC)),
. C1MIN(B,AC(JC)),C1MAX(B,AC(JC)),B=1,NB),JC=1,NAC)
WRITE (APL) ATAMP,AAPC
IF (QUALITY_DIAG) THEN
WRITE (APL) AFIC, ANLC, APLC, AFID, ANLD, APLD, ASLD,
. AFIG, ANLG, APLG, ANPP, ARESP, AKE
END IF
IF (SEDIMENT_DIAG) THEN
WRITE (APL) ABENDOC, ABENNH4, ABENNO3, ABENPO4, ABENCOO,
. ABENDO, ABENSA, ASSFWS, APCFWS, APNFWS,
. APPFWS, APSFWS, ACPOC, ACPON, ACPOP,
. ACPIP, ACPOS
END IF

```

Quantities written to the Average Plot File are analogous to variables written to the Plot File and listed in Table 24-1. The letter “A” at the beginning of the variable name indicates the variables are averaged before output. Two new variables are also written, C1MAX and C1MIN. These are defined in Table 24-3.

## Transportation Flux File

The Transportation Flux File contains computed transport of carbon, nitrogen, and phosphorus at all model flow faces. Computed transport includes the effects of advection, diffusion, and settling. The flux algorithm installed in the model code computes transport of all state variables but these are summarized into substances of most interest prior to output. Positive flux is defined in the positive flow direction, as specified in the Map File.

Transport fluxes are output when “TFLC = ON” is specified in the Transport Flux Output Control card group in the Control File. Transport fluxes are averaged over user-specified intervals. The averaging interval is also specified in the Transport Flux Output Control card group.

Header information is written to the Transportation Flux File once when it is opened. The WRITE statement is:

```
WRITE (TFL) TITLE,NQF
```

### Variables

Variables in the header are summarized in Table 24-4.

Subsequent information is written to the Transportation Flux File repeatedly at intervals specified in the Transport Flux Output Control card group. The WRITE statement is:

WRITE (TFL) JDAY,AFLUX

Variables in the WRITE statement are summarized in Table 24-4.

<b>Table 24-4 Variables Written to Transportation Flux File</b>			
<b>Variable</b>	<b>Type</b>	<b>Definition</b>	<b>Units</b>
TITLE	An array with six elements. Each element is CHARACTER*72.	Six title lines from the head of the Control File	
NOF	INTEGER	Number of flow faces in grid	
JDAY	REAL	Julian day elapsed since beginning of run	day
AFLUX	A REAL array dimensioned (NQFP,11). NQFP = maximum number of flow faces assigned in the INCLUDE file.	Flux of 11 forms of carbon, nitrogen, and phosphorus. See explanation below.	kg sec <sup>-1</sup>

### Sequencing of transportation fluxes

Fluxes of eleven forms of carbon, nitrogen, and phosphorus are output. Each form occupies one vector of the array AFLUX. The first subscript of AFLUX indicates flow face number in the grid. The second subscript indicates the carbon, nitrogen, or phosphorus form. A key to these forms is presented in Table 24-5.

<b>Table 24-5 Contents of AFLUX Array</b>			
<b>Vector</b>	<b>Contents</b>	<b>Vector</b>	<b>Contents</b>
1	Particulate organic carbon	7	Total nitrogen
2	Dissolved organic carbon	8	Dissolved organic phosphorus
3	Total organic carbon	9	Dissolved inorganic phosphorus
4	Dissolved organic nitrogen	10	Particulate organic phosphorus
5	Dissolved inorganic nitrogen	11	Total phosphorus
6	Particulate organic nitrogen		

## Mass-Balance File

The Mass-Balance File is a complement to the Transportation Flux file. The Mass-Balance File contains the sources and sinks of total carbon, nitrogen, and phosphorus for each water-column and sediment cell. The mass balance enumerates external loading, sediment-water fluxes, and loss of total substance through reactions including respiration and denitrification.

Mass balances are output when "MBLC = ON" is specified in the Mass Balance Output Control card group in the Control File. Mass balances are averaged over user-specified intervals. The averaging interval is also specified in the Mass Balance Output Control card group.

Header information is written to the Mass-Balance File once when it is opened. The WRITE statement is:

```
WRITE (MBL) NSB,NB,NHQF,SBN,BBN
```

### Variables

Variables in the WRITE statement are summarized in Table 24-6.

Subsequent information is written to the Mass-Balance File repeatedly at intervals specified in the Mass Balance Output Control card group. The WRITE statements are:

```
WRITE (MBL) JDAY
WRITE (MBL) DLWCKMNB,BENFLXPNB,BENFLXDNB,S1FLXNB,S2FLXNB,
  ATMFLXNB
WRITE (MBL) BENFLXPPB,BENFLXDPB,S1FLXPB,S2FLXPB,ATMFLXPB
WRITE (MBL) DLWCKMCB,BENFLXPCB,S1FLXCB,S2FLXCB
WRITE (MBL) DLSEDKNB,BURIALFLXNB
WRITE (MBL) BURIALFLXPB
WRITE (MBL) DLSEDKCB,BURIALFLXCB
```

Variables in the WRITE statements are summarized in Table 24-6.

### Additional information

The array SBN contains the cell numbers of surface cells in the order they are entered in the Geometry File. Figure 24-1 shows an elevation of the grid corresponding the Geometry File listed in Appendix D. For this grid, the contents of array SBN are:

$$\text{SBN}(1) = 1, \text{SBN}(2) = 2, \dots, \text{SBN}(10) = 10$$

Since the surface cells were entered in numerical order, the array SBN is redundant in this case.

**Table 24-6  
Variables Written to Mass-Balance File**

Variable	Type	Definition	Units
NSB	INTEGER	Number of surface cells in model grid	
NB	INTEGER	Number of cells in model grid	
NHQF	INTEGER	Number of horizontal flow faces in model grid	
SBN	An INTEGER array dimensioned (NSBP). NSBP = maximum number of surface cells. NSBP is assigned in INCLUDE file.	An array of surface cell numbers. See explanation below.	
BBN	An INTEGER array dimensioned (NSBP)	An array of bottom cell numbers. See explanation below.	
JDAY	REAL	Julian day elapsed since beginning of run	day
DLWCKMNB	A REAL array dimensioned (NBP). NBP = maximum number of grid cells. NBP is assigned in INCLUDE file.	Total nitrogen source or sink in cell due to kinetics in water column. The sole term is loss due to denitrification.	kg day <sup>-1</sup>
BENFLXPNB	A REAL array dimensioned (NSBP)	Total particulate nitrogen flux from water to sediment cell. This a negative number when material is input to sediment.	kg day <sup>-1</sup>
BENFLXDNB	A REAL array dimensioned (NSBP)	Total dissolved nitrogen flux from water to sediment cell. This a negative number when material is input to sediment.	kg day <sup>-1</sup>
S1FLXNB	A REAL array dimensioned (NBP)	Total nitrogen load to cell from External Load File 1.	kg day <sup>-1</sup>
S2FLXNB	A REAL array dimensioned (NBP)	Total nitrogen load to cell from External Load File 2.	kg day <sup>-1</sup>
ATMFLXNB	A REAL array dimensioned (NSBP)	Total atmospheric nitrogen load to model cell.	kg day <sup>-1</sup>
BENFLXPPB	A REAL array dimensioned (NSBP)	Total particulate phosphorus flux from water to sediment cell. This a negative number when material is input to sediment.	kg day <sup>-1</sup>
BENFLXDPB	A REAL array dimensioned (NSBP)	Total dissolved phosphorus flux from water to sediment cell. This a negative number when material is input to sediment.	kg day <sup>-1</sup>

*(Continued)*

Table 24-6 (Concluded)			
Variable	Type	Definition	Units
S1FLXPB	A REAL array dimensioned (NBP)	Total phosphorus load to cell from External Load File 1.	kg day <sup>-1</sup>
S2FLXPB	A REAL array dimensioned (NBP)	Total phosphorus load to cell from External Load File 2.	kg day <sup>-1</sup>
ATMFLXPB	A REAL array dimensioned (NSBP)	Total atmospheric phosphorus load to model cell.	kg day <sup>-1</sup>
DLWCKMCB	A REAL array dimensioned (NBP)	Total carbon source or sink in cell due to kinetics in water column. Terms include primary production and respiration.	kg day <sup>-1</sup>
BENFLXPB	A REAL array dimensioned (NSBP)	Total particulate carbon flux from water to sediment cell. This a negative number when material is input to sediment.	kg day <sup>-1</sup>
S1FLXCB	A REAL array dimensioned (NBP)	Total carbon load to cell from External Load File 1.	kg day <sup>-1</sup>
S2FLXCB	A REAL array dimensioned (NBP)	Total carbon load to cell from External Load File 2.	kg day <sup>-1</sup>
DLSEDKNB	A REAL array dimensioned (NSBP)	Total nitrogen source or sink in sediment cell due to kinetics. The sole term is loss due to denitrification.	kg day <sup>-1</sup>
BURIALFLXNB	A REAL array dimensioned (NSBP)	Burial of total nitrogen from sediment cell to deep sediments.	kg day <sup>-1</sup>
BURIALFLXPB	A REAL array dimensioned (NSBP)	Burial of total phosphorus from sediment cell to deep sediments.	kg day <sup>-1</sup>
DLSEDKCB	A REAL array dimensioned (NSBP)	Total carbon source or sink in sediment cell due to kinetics. The sole term is loss due to diagenesis.	kg day <sup>-1</sup>
BURIALFLXCB	A REAL array dimensioned (NSBP)	Burial of organic carbon from sediment cell to deep sediments.	kg day <sup>-1</sup>

The array BBN contains the cell numbers of bottom cells in the order they are entered in the Geometry File. For the grid in Figure 24-1, the contents of array BBN are:

$$\text{BBN}(1) = 21, \text{BBN}(2) = 22, \dots, \text{BBN}(10) = 30$$

The array BBN is useful as a reference to link conditions in the sediments to conditions in overlying water-column cells.

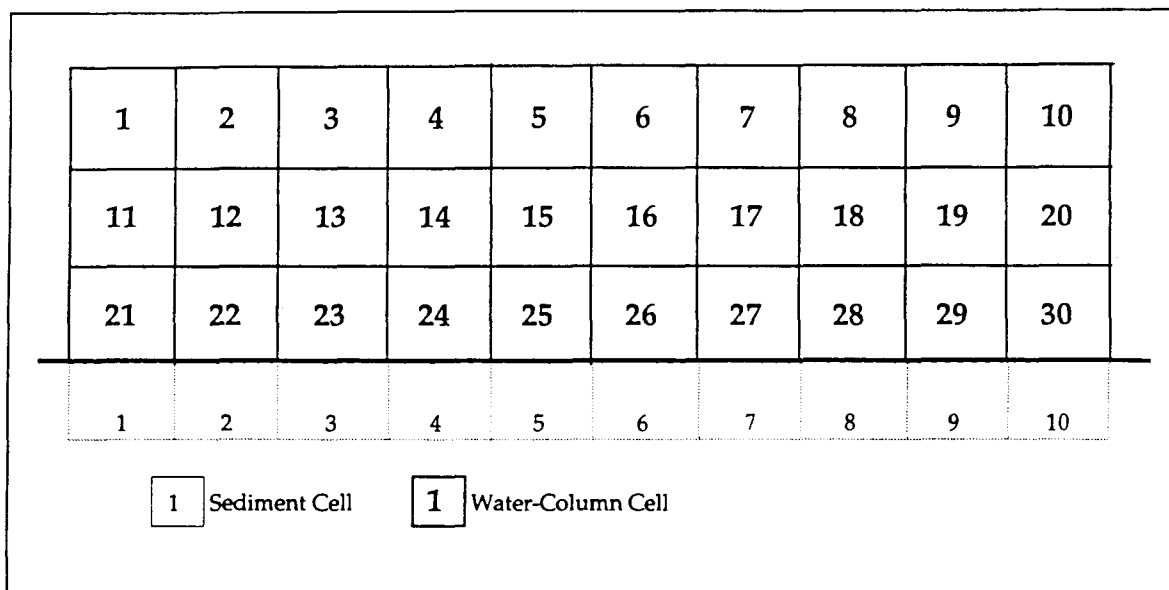

Figure 24-1. Numbering of sediment and water-column cells (elevation)

Mass balances can be listed relative to water-column or sediment cells. For sources such as atmospheric loads and sinks such as burial, the reference to a water-column or sediment cell is obvious as is the sign convention. For mass balances that quantify transfers between water and sediments, the reference and sign convention are not obvious. These fluxes include BENFLXPNB, BENFLXDNB, BENFLXPPB, BENFLXDPB, and BENFLXPCB. For these fluxes, the array element refers to a sediment cell. The sign convention is that **positive fluxes are sources to the water column**. For example, the settling of particulate carbon from water-column cell 10 to sediment cell 1 is BENFLXPCB(1). This variable is output from the model as a negative quantity since it is a loss from the water column.

## Kinetics Flux File

The Kinetics Flux File is a complement to the Transportation Flux File and the Mass-Balance File. The Kinetics Flux File contains the rates of substance transformations in the water column due to kinetics processes. Information to aid in interpretation of kinetics fluxes (including temperature, dissolved oxygen concentration, and algal growth rates) is also provided.

Kinetics fluxes are output when "KFLC = ON" is specified in the Kinetics Flux Output Control card group in the Control File. Kinetics fluxes are averaged over user-specified intervals. The averaging interval is also specified in the Kinetics Flux Output Control card group.

Header information is written to the Kinetics Flux File once when it is opened. The WRITE statement is:

```
WRITE(KFL) JDAY
```

Subsequent information is written to the Kinetics Flux File repeatedly at intervals specified in the Kinetics Flux Output Control card group. The WRITE statements are:

```

WRITE(KFL) A_T,      A_PC,      ABMC,      APRC,
.             APD,      ABMD,      APRD,      APG,
.             ABMG,      APRG
WRITE(KFL) AALGDOC,  AALGPOC,  ADENIT,  AMNLDOC,
.             AHDRLPOC, AHDRRPOC
WRITE(KFL) AALGNH4,  AALGNO3,  AALGDON,  AALGPON,
.             ANT,      ADENNO3,  AMNLDON,  AHDRLPON,
.             AHDRRPON
WRITE(KFL) AALGPO4,  AALGDOP,  AALGPOP,  AMNLDOP,
.             AHDRLPOP, AHDRRPOP
WRITE(KFL) APSD,    ASAP,      AALGUP,  AALGRES
WRITE(KFL) ADO,    ADORALG,  ADOPR,  ADCOD,
.             ADDOC,    ANITRIF

```

## Variables

Variables in the WRITE statements are summarized in Table 24-7.

## Additional information

Algae take up ammonium during growth (production) and release ammonium through respiration and the actions of predation. The variable AALGNH4 is the sum of all algal processes affecting ammonium. If the quantity is positive, ammonium release through respiration and predation exceeds uptake through growth. If the quantity is negative, uptake due to growth exceeds losses through respiration and predation.

The total phosphate state variable includes dissolved phosphate, sorbed phosphate, and algal phosphate. Algal phosphorus uptake does not change the quantity of total phosphate, only the distribution. The sole effect of algae on total phosphate is the loss that occurs when algal phosphate is converted to organic form through respiration or predation. The loss is quantified in the variable AALGPO4. The transformation of dissolved phosphate to algal phosphate is not presently quantified in the Kinetics Flux File. Reporting of this transfer will be incorporated in the next model update.

Algae produce dissolved oxygen during growth (production) and consume dissolved oxygen through respiration. The variable ADORALG is the sum of production and respiration. If the quantity is positive, production exceeds respiration. If the quantity is negative, respiration exceeds production.



**Table 24-7**  
**Variables Written to Kinetics Flux File**

Variable	Type	Definition	Units
JDAY	REAL	Julian day elapsed since beginning of run	day
A_T	A REAL array dimensioned (NBP)	Temperature	C°
A_PC	A REAL array dimensioned (NBP)	Cyanobacteria production rate	day <sup>-1</sup>
ABMC	A REAL array dimensioned (NBP)	Cyanobacteria respiration rate	day <sup>-1</sup>
APRC	A REAL array dimensioned (NBP)	Rate of predation on cyanobacteria	day <sup>-1</sup>
APD	A REAL array dimensioned (NBP)	Diatom production rate	day <sup>-1</sup>
ABMD	A REAL array dimensioned (NBP)	Diatom respiration rate	day <sup>-1</sup>
APRD	A REAL array dimensioned (NBP)	Rate of predation on diatoms	day <sup>-1</sup>
APG	A REAL array dimensioned (NBP)	Green algal production rate	day <sup>-1</sup>
ABMG	A REAL array dimensioned (NBP)	Green algal respiration rate	day <sup>-1</sup>
APRG	A REAL array dimensioned (NBP)	Rate of predation on green algae	day <sup>-1</sup>
AALGDOC	A REAL array dimensioned (NBP)	Dissolved organic carbon production by all algae	gm C m <sup>-3</sup> day <sup>-1</sup>
AALGPOC	A REAL array dimensioned (NBP)	Particulate organic carbon production by all algae	gm C m <sup>-3</sup> day <sup>-1</sup>
ADENIT	A REAL array dimensioned (NBP)	Loss of dissolved organic carbon by denitrification	gm C m <sup>-3</sup> day <sup>-1</sup>
AMNLDOC	A REAL array dimensioned (NBP)	Respiration of dissolved organic carbon	gm C m <sup>-3</sup> day <sup>-1</sup>
AHDLPOC	A REAL array dimensioned (NBP)	Hydrolysis of labile particulate organic carbon	gm C m <sup>-3</sup> day <sup>-1</sup>
AHRRPOC	A REAL array dimensioned (NBP)	Hydrolysis of refractory particulate organic carbon	gm C m <sup>-3</sup> day <sup>-1</sup>
AALGNH4	A REAL array dimensioned (NBP)	Algal uptake /production of ammonium. See explanation below.	gm N m <sup>-3</sup> day <sup>-1</sup>
AALGNO3	A REAL array dimensioned (NBP)	Algal uptake of nitrate	gm N m <sup>-3</sup> day <sup>-1</sup>

(Sheet 1 of 3)

<b>Table 24-7 (Continued)</b>			
<b>Variable</b>	<b>Type</b>	<b>Definition</b>	<b>Units</b>
AALGDON	A REAL array dimensioned (NBP)	Algal production of dissolved organic nitrogen	gm N m <sup>-3</sup> day <sup>-1</sup>
AALGPON	A REAL array dimensioned (NBP)	Algal production of particulate organic nitrogen	gm N m <sup>-3</sup> day <sup>-1</sup>
ANT	A REAL array dimensioned (NBP)	Loss of ammonium through nitrification	gm N m <sup>-3</sup> day <sup>-1</sup>
ADENNO3	A REAL array dimensioned (NBP)	Loss of nitrate through denitrification	gm N m <sup>-3</sup> day <sup>-1</sup>
AMNLDON	A REAL array dimensioned (NBP)	Mineralization of dissolved organic nitrogen	gm N m <sup>-3</sup> day <sup>-1</sup>
AHDLRPN	A REAL array dimensioned (NBP)	Hydrolysis of labile particulate organic nitrogen	gm N m <sup>-3</sup> day <sup>-1</sup>
AHRRPON	A REAL array dimensioned (NBP)	Hydrolysis of refractory particulate organic nitrogen	gm N m <sup>-3</sup> day <sup>-1</sup>
AALGPO4	A REAL array dimensioned (NBP)	Net loss of total phosphate due to algal activity. See explanation below.	gm P m <sup>-3</sup> day <sup>-1</sup>
AALGDOP	A REAL array dimensioned (NBP)	Algal production of dissolved organic phosphorus	gm P m <sup>-3</sup> day <sup>-1</sup>
AALGPOP	A REAL array dimensioned (NBP)	Algal production of particulate organic phosphorus	gm P m <sup>-3</sup> day <sup>-1</sup>
AMNLDOP	A REAL array dimensioned (NBP)	Mineralization of dissolved organic phosphorus	gm P m <sup>-3</sup> day <sup>-1</sup>
AHDLRPOP	A REAL array dimensioned (NBP)	Hydrolysis of labile particulate organic phosphorus	gm P m <sup>-3</sup> day <sup>-1</sup>
AHRRPOP	A REAL array dimensioned (NBP)	Hydrolysis of refractory particulate organic phosphorus	gm P m <sup>-3</sup> day <sup>-1</sup>
APSD	A REAL array dimensioned (NBP)	Dissolution of particulate to dissolved silica	gm Si m <sup>-3</sup> day <sup>-1</sup>
ASAP	A REAL array dimensioned (NBP)	Production of dissolved silica through predation on diatoms	gm Si m <sup>-3</sup> day <sup>-1</sup>
AALGUP	A REAL array dimensioned (NBP)	Silica uptake by diatoms	gm Si m <sup>-3</sup> day <sup>-1</sup>
AALGRES	A REAL array dimensioned (NBP)	Dissolved silica release by diatom respiration	gm Si m <sup>-3</sup> day <sup>-1</sup>

(Sheet 2 of 3)

Table 24-7 (Concluded)			
Variable	Type	Definition	Units
ADO	A REAL array dimensioned (NBP)	Dissolved oxygen concentration	gm m <sup>-3</sup>
ADORALG	A REAL array dimensioned (NBP)	Net algal oxygen production/consumption. See explanation below.	gm O <sub>2</sub> m <sup>-3</sup> day <sup>-1</sup>
ADOPR	A REAL array dimensioned (NBP)	Direct oxygen uptake by predators	gm O <sub>2</sub> m <sup>-3</sup> day <sup>-1</sup>
ADCOD	A REAL array dimensioned (NBP)	Oxygen loss through chemical oxygen demand	gm O <sub>2</sub> m <sup>-3</sup> day <sup>-1</sup>
ADDOC	A REAL array dimensioned (NBP)	Oxygen loss through respiration of dissolved organic carbon	gm O <sub>2</sub> m <sup>-3</sup> day <sup>-1</sup>
ANITRIF	A REAL array dimensioned (NBP)	Oxygen loss through nitrification	gm O <sub>2</sub> m <sup>-3</sup> day <sup>-1</sup>
<i>(Sheet 3 of 3)</i>			

## Oxygen Volume Output File

The Oxygen Volume Output File contains statistics that quantify the volume-time integral of dissolved oxygen within a specified range. The statistics are termed "dissolved-oxygen volume days." Dissolved-oxygen volume days are a useful statistic for comparison of dissolved-oxygen improvements during model scenario runs.

The dissolved-oxygen volume days statistic is defined:

$$DOVD_{i,j} = V_i \int_{T_1}^{T_2} f(j) dt \quad (24-1)$$

$DOVD_{i,j}$  = dissolved oxygen volume days in cell i within oxygen interval j (m<sup>3</sup> days)

$V_i$  = volume of cell i (m<sup>3</sup>)

$T_1$  = beginning of integration interval (day)

$T_2$  = end of integration interval (day)

The function  $f(j)$  has two potential values:

$$f(j) = 1 \text{ when } LLIM_j \leq DO_i < ULIM_j \quad (24-2)$$

or

$$f(j) = 0 \text{ otherwise} \quad (24-3)$$

$DO_i$  = dissolved oxygen concentration in cell  $i$  ( $\text{gm O}_2 \text{ m}^{-3}$ )

$LLIM_j$  = lower limit of dissolved oxygen interval  $j$  ( $\text{gm O}_2 \text{ m}^{-3}$ )

$ULIM_j$  = upper limit of dissolved oxygen interval  $j$  ( $\text{gm O}_2 \text{ m}^{-3}$ )

The Oxygen Volume Output File is produced when "OPLC = ON" is specified in the Oxygen Plot Output Control card group in the Control File. The dissolved-oxygen intervals and integration periods are specified in the same card group.

Header information is written to the Oxygen Volume Output File once when it is opened. The WRITE statement is:

```
WRITE (OPL) TITLE,NB,NOINT,OINT,V1
```

Subsequent information is written to the Oxygen Volume Output File repeatedly at intervals specified in the Oxygen Plot Output Control card group. The WRITE statement is:

```
WRITE (OPL) JDAY,DOVDAYS
```

## Variables

Variables in the WRITE statements are summarized in Table 24-8.

## Additional information

The first subscript of the DOVDAYS array indicates cell number. The second subscript indicates oxygen interval. For example, DOVDAYS(10,2) is the dissolved-oxygen volume days in cell 10 within oxygen interval 2. Note that the number of computed intervals is always one fewer than the number of intervals specified as NOINT. Decrement by one occurs because both upper and lower limits to oxygen intervals must be specified in array OINT.

**Table 24-8**  
**Variables Written to Oxygen Volume Output File**

Variable	Type	Definition	Units
TITLE	An array with six elements. Each element is CHARACTER*72.	Six title lines from the head of the Control File	
NB	INTEGER	Number of cells in model grid	
NOINT	INTEGER	Number of dissolved oxygen concentration intervals	
OINT	A REAL array dimensioned (NOIP). NOIP = maximum number of oxygen intervals assigned in the INCLUDE file.	Dissolved oxygen concentration intervals	gm m <sup>-3</sup>
V1	A REAL array dimensioned (0:NBP). NBP = maximum number of cells assigned in the INCLUDE file.	Volume of model cell	m <sup>3</sup>
JDAY	REAL	Julian day elapsed since beginning of run	day
DOVDAYS	A REAL array dimensioned (NBP,NOIP)	Dissolved-oxygen volume days. See explanation below.	m <sup>3</sup> day

# References

---

- Almgren, T., and Hagstrom, I. (1974). "The oxidation rate of sulphide in seawater," *Water Research*, 8, 395-400.
- American Society of Civil Engineers. (1961). "Effect of water temperature on stream reaeration," *Journal of the Sanitary Engineering Division*, 87(SA6), 59-71.
- Ammerman, J., and Azam, F. (1985). "Bacterial 5'-nucleodase in aquatic ecosystems: a novel mechanism of phosphorus regeneration," *Science*, 227, 1338-1340.
- Anderson, G. (1986). "Silica, diatoms and a freshwater productivity maximum in Atlantic coastal plain estuaries, Chesapeake Bay," *Estuarine, Coastal and Shelf Science*, 22, 183-197.
- Balzer, W. (1982). "On the distribution of iron and manganese at the sediment/water interface: thermodynamic versus kinetic control," *Geochimica et Cosmochimica Acta*, 46, 1153-1161.
- Beers, J. (1986). "Organisms and the food web," *Plankton dynamics of the southern California Bight*, Lecture Notes on Coastal and Estuarine Studies 15, Springer-Verlag, 84-175.
- Beers, J., and Brownlee, D. (1988). "Laboratory observations on the reproduction and feeding of a marine pelagic strombinid ciliate," submitted to *Marine Microbial Food Webs*.
- Berounsky, V., and Nixon, S. (1985). "Eutrophication and the rate of net nitrification in a coastal marine ecosystem," *Estuarine, Coastal and Shelf Science*, 20, 773-781.
- Bird, D., and Kalff, J. (1984). "Empirical relationships between bacterial abundance and chlorophyll concentration in fresh and marine waters," *Canadian Journal of Fisheries and Aquatic Science*, 41, 1015-1023.

- Boni, L., Carpena, E., Wynne, D., and Reti, M. (1989). "Alkaline phosphatase activity in *Protogonyaulax tamarensis*," *Journal of plankton research*, 11, 879-885.
- Bowie, G., Mills, W., Porcella, D., Campbell, C., Pagenkopf, J., Rupp, G., Johnson, K., Chan, P., Gherini, S., and Chamberlin, C. (1985). "Rates, constants, and kinetics formulations in surface water modeling," 2nd ed., EPA/600/3-85/040, U.S. Environmental Protection Agency, Athens, GA.
- Boynton, W., Kemp, W., and Keefe, C. (1982). "A comparative analysis of nutrients and other factors influencing estuarine phytoplankton production," *Estuarine comparisons*, Academic Press, 69-90.
- Boynton, W., and Kemp, W. (1985). "Nutrient regeneration and oxygen consumption along an estuarine salinity gradient," *Marine Ecology Progress Series*, 23, 45-55.
- Brush, G. (1984). "Patterns of recent sediment accumulation in Chesapeake Bay (Virginia-Maryland, U.S.A.) tributaries," *Chemical Geology*, 44, 227-242.
- Brush, G. (1989). "Rates and patterns of estuarine sediment accumulation," *Limnology and Oceanography*, 34(7), 1235-1246.
- Canale, R., and Vogel, A. (1974). "Effects of temperature on phytoplankton growth," *Journal of the Environmental Engineering Division*, 100, 231-241.
- Cerco, C., and Cole, T. (1994). "Three-dimensional eutrophication model of Chesapeake Bay," Technical Report EL-94-4, U.S. Army Engineer Waterways Experiment Station, Vicksburg, MS.
- Cerco, C. (1989). "Estimating estuarine reaeration rates," *Journal of the Environmental Engineering Division*, 115(5), 1066-1070.
- Charley, R., Hooper, D., and McLee, A. (1980). "Nitrification kinetics in activated sludge at various temperatures and dissolved oxygen concentrations," *Water Research*, 14, 1387-1396.
- Chrost, R., and Overbeck, J. (1987). "Kinetics of alkaline phosphatase activity and phosphorus availability for phytoplankton and bacterioplankton in Lake Plubsee (north German eutrophic lake)," *Microbial Ecology*, 13, 229-248.
- Cohen, R., Dresler, P., Phillips, E., and Cory, R. (1984). "The effect of the Asiatic clam, *Corbicula fluminea*, on phytoplankton of the Potomac River, Maryland," *Limnology and Oceanography*, 29, 170-180.

- Cole, J., Findlay, S., and Pace, M. (1988). "Bacterial production in fresh and saltwater ecosystems: a cross-system overview," *Marine Ecology Progress Series*, 43, 1-10.
- Collins, C., and Wlosinski, J. (1983). "Coefficients for use in the U.S. Army Corps of Engineers reservoir model CE-QUAL-R1," Technical Report E-83-5, U.S. Army Engineer Waterways Experiment Station, Vicksburg, MS.
- Conley, D., and Malone, T. (1992). "Annual cycle of dissolved silicate in Chesapeake Bay: implications for the production and fate of phytoplankton biomass," *Marine Ecology Progress Series*, 81, 121-128.
- Davies-Colley, R., and Vant, W. (1988). "Estimation of optical properties of water from Secchi disk depth," *Water Resources Bulletin*, 24, 1329-1335.
- Davis, C., Breitner, N., and Harrison, P. (1978). "Continuous culture of marine diatoms under silicon limitation. 3. a model of Si-limited diatom growth," *Limnology and Oceanography*, 23, 41-52.
- D'Elia, C., Nelson, D., and Boynton, W. (1983). "Chesapeake Bay nutrient and plankton dynamics: III. The annual cycle of silicon," *Geochimica et Cosmochimica Acta*, 47, 1945-1955.
- DiToro, D., O'Connor, S., and Thomann, R. (1971). "A dynamic model of the phytoplankton population in the Sacramento-San Joaquin Delta," *Nonequilibrium systems in water chemistry*, American Chemical Society, Washington, DC, 131-180.
- DiToro, D. (1980). "Applicability of cellular equilibrium and Monod theory to phytoplankton growth kinetics," *Ecological Modelling*, 8, 201-218.
- DiToro, D., Paquin, P., Subburamu, K., and Gruber, D. (1990). "Sediment oxygen demand model: methane and ammonia oxidation," *Journal of Environmental Engineering*, 116(5), 945-986.
- DiToro, D., and Fitzpatrick, J. (1993). "Chesapeake Bay sediment flux model," Contract Report EL-93-2, U.S. Army Engineer Waterways Experiment Station, Vicksburg, MS.
- Droop, M. (1973). "Some thoughts on nutrient limitation in algae," *Journal of Phycology*, 9, 264-272.
- Eaton, A. (1979). "The impact of anoxia on Mn fluxes in the Chesapeake Bay," *Geochimica et Cosmochimica Acta*, 43, 429-432.



- Edinger, J., Brady, D., and Geyer, J. (1974). "Heat exchange and transportation the environment," Report 14, Department of Geography and Environmental Engineering, Johns Hopkins University, Baltimore, MD.
- Effler, S. (1985). "Attenuation versus transparency," *Journal of the Environmental Engineering Division*, 111(4), 448-459.
- Fisher, T., Carlson, P., and Barber, R. (1982). "Sediment nutrient regeneration in three North Carolina estuaries," *Estuarine, Coastal and Shelf Science*, 4, 101-116.
- Fisher, T., Peele, E., Ammerman, J., and Harding, L. (1992). "Nutrient limitation of phytoplankton in Chesapeake Bay," *Marine Ecology Progress Series*, 82, 51-63.
- Foree, E., and McCarty, P. (1970). "Anaerobic decomposition of algae," *Environmental Science and Technology*, 4, 842-849.
- Garber, J. (1984). "Laboratory study of nitrogen and phosphorus remineralization during the decomposition of coastal plankton and seston," *Estuarine, Coastal and Shelf Science*, 18, 685-702.
- Gardner, W., Seitzinger, S., and Malczyk, J. (1991). "The effects of sea salts on the forms of nitrogen released from estuarine and freshwater sediments: does ion pairing affect ammonium flux?," *Estuaries*, 14(2), 157-166.
- Gavis, J., and Grant, V. (1986). "Sulfide, iron, manganese, and phosphate in the deep water of the Chesapeake Bay during anoxia," *Estuarine, Coastal and Shelf Science*, 23, 451-463.
- Genet, L., Smith, D., and Sonnen, M. (1974). "Computer program documentation for the Dynamic Estuary Model," U.S. Environmental Protection Agency, Systems Development Branch, Washington, DC.
- Goodwin, S., Schultz, B., Parkhurst, D., Simon, N., and Callender, E. (1984). "Methods for the collection of geochemical data from the sediments of the tidal Potomac River and estuary and data for 1978-1980," Open-File Report 84-074, US Geological Survey, Reston, VA.
- Graham, W., Bender, M., and Klinkhammer, G. (1976). "Manganese in Narragansett Bay," *Limnology and Oceanography*, 21, 665-673.
- Grill, E., and Richards, F. (1964). "Nutrient regeneration from phytoplankton decomposing in seawater," *Journal of Marine Research*, 22, 51-69.

- Harding, L., Meeson, B., and Fisher, T. (1986). "Phytoplankton production in two east coast estuaries: photosynthesis-light functions and patterns of carbon assimilation in Chesapeake and Delaware Bays," *Estuarine, Coastal and Shelf Science*, 23, 773-806.
- Hecky, R., and Kilham, P. (1988). "Nutrient limitation of phytoplankton in freshwater and marine environments: a review of recent evidence on the effects of enrichment," *Limnology and Oceanography*, 33(4), 796-822.
- Helder, W. and DeVries, R. (1983). "Estuarine nitrite maxima and nitrifying bacteria (Ems Dollard Estuary)," *Netherlands Journal of Sea Research*, 17, 1-18.
- Holmes, R. (1970). "The Secchi disk in turbid coastal water," *Limnology and Oceanography*, 15, 688-694.
- Horrigan, S., Montoya, J., Nevins, J., McCarthy, J., Ducklow, H., Goericke, R., and Malone, T. (1990). "Nitrogenous nutrient transformations in the spring and fall in the Chesapeake Bay," *Estuarine, Coastal and Shelf Science*, 30, 369-391.
- Jenkins, M., and Kemp, W. (1984). "The coupling of nitrification and denitrification in two estuarine sediments," *Limnology and Oceanography*, 29(3), 609-619.
- Kremer, J., and Nixon, S. (1978). *A coastal marine ecosystem simulation and analysis*, Springer Verlag, New York, NY.
- Laws, E., and Wong, D. (1978). "Studies of carbon and nitrogen metabolism by three marine phytoplankton species in nitrate-limited continuous culture," *Journal of Phycology*, 14, 406-416.
- Laws, E., and Archie, J. (1981). "Appropriate use of regression analysis in marine biology," *Marine Biology*, 65, 13-16.
- Leonard, B. (1979). "A stable and accurate convection modelling procedure based on quadratic upstream interpolation," *Computer Methods in Applied Mechanics and Engineering*, 19, 59-98.
- Lipschultz, F., Wofsy, S., and Fox, L. (1986). "Nitrogen metabolism of the eutrophic Delaware River ecosystem," *Limnology and Oceanography*, 31, 701-716.
- Luther, G., Ferdelman, T., and Tsamakis, E. (1988). "Evidence suggesting anaerobic oxidation of the bisulfide ion in Chesapeake Bay," *Estuaries*, 11, 281-285.

- Malone, T., Crocker, L., Pike, S., and Wendler, B. (1988). "Influences of river flow on the dynamics of phytoplankton production in a partially stratified estuary," *Marine Ecology Progress Series*, 48, 235-249.
- Mataulj, M., and Flint, K. (1987). "A model for acid and alkaline phosphatase activity in a small pond," *Microbial Ecology*, 13, 141-158.
- Millero, F. (1991). "The oxidation of H<sub>2</sub>S in the Chesapeake Bay," *Estuarine, Coastal and Shelf Science*, 33, 521-527.
- Monod, J. (1949). "The growth of bacterial cultures," *Annual Review of Microbiology*, 3, 371-394.
- Morel, F. (1983). *Principles of Aquatic Chemistry*, John Wiley and Sons, New York, NY, 150.
- Nixon, S. (1981). "Remineralization and nutrient cycling in coastal marine ecosystems," *Estuaries and Nutrients*, Neilson and Cronin, eds., Humana Press, Clifton, NJ, 111-138.
- O'Connor, D., and Dobbins, W. (1958). "Mechanisms of reaeration in natural streams," *Transactions of the American Society of Civil Engineers*, 123, 641-666.
- O'Connor, D. (1983). "Wind effects on gas-liquid transfer coefficients," *Journal of the Environmental Engineering Division*, 190, 731-752.
- O'Connor, D. (1988). "Models of sorptive toxic substances in freshwater systems. I: basic equations," *Journal of the Environmental Engineering Division*, 114(3), 507-532.
- Odum, E. (1971). *Fundamentals of Ecology*, 3rd ed., W. B. Saunders, Philadelphia, PA, pp 106-107.
- Officer, C., Lynch, D., Setlock, G., and Helz, G. (1984). "Recent sedimentation rates in Chesapeake Bay," *The estuary as a filter*, Academic Press, 131-157.
- Otsuki, A., and Hanya, T. (1972). "Production of dissolved organic matter from dead green algal cells. I. aerobic microbial decomposition," *Limnology and Oceanography*, 17, 248-257.
- Owens, N. (1986). "Estuarine nitrification: a naturally occurring fluidized bed reaction?," *Estuarine, Coastal and Shelf Science*, 22, 31-44.
- Parsons, T., Takahashi, M., and Hargrave, B. (1984). *Biological oceanographic processes*, 3rd ed., Pergamon Press, Oxford.

- Pennock, J. (1985). "Chlorophyll distributions in the Delaware Estuary: regulation by light-limitation," *Estuarine, Coastal and Shelf Science*, 21, 711-725.
- Pett, R. (1989). "Kinetics of microbial mineralization of organic carbon from detrital *Skeletonema costatum* cells," *Marine Ecology Progress Series*, 52, 123-128.
- Raven, J., and Beardall, J. (1981). "Respiration and photorespiration," *Physiological Bases of Phytoplankton Ecology*, Bulletin 210, Canadian Bulletin of Fisheries and Aquatic Sciences.
- Redfield, A., Ketchum, B., and Richards, F. (1966). "The influence of organisms on the composition of sea-water." *The Sea Volume II*. Interscience Publishers, New York, 26-48.
- Ricker, W. (1973). "Linear regressions in fishery research," *Journal of the Fisheries Research Board of Canada*, 30, 409-434.
- Roman, M., Ducklow, H., Furhrman, J., Garside, C., Gilbert, P., Malone, T., and McManus, G. (1988). "Production, consumption, and nutrient cycling in a laboratory mesocosm," *Marine Ecology Progress Series*, 42, 39-52.
- SAS Institute, Inc. (1988). *SAS/STAT User's Guide, Release 6.03 Edition*, Cary, NC.
- Sanders, J., Cibik, S., D'Elia, C., and Boynton, W. (1987). "Nutrient enrichment studies in a coastal plain estuary: changes in phytoplankton species composition," *Canadian Journal of Fisheries and Aquatic Sciences*, 44, 83-90.
- Scavia, D. (1980). "An ecological model of Lake Ontario," *Ecological Modeling*, 8, 49-78.
- Seitzinger, S., Nixon, S., and Pilson, M. (1984). "Denitrification and nitrous oxide production in a coastal marine ecosystem," *Limnology and Oceanography*, 29(1), 73-83.
- Sellner, K., Lacoutre, R., and Parrish, C. (1988). "Effects of increasing salinity on a cyanobacteria bloom in the Potomac River Estuary," *Journal of Plankton Research*, 10, 49-61.
- Sharma, B., and Ahlert, R. (1977). "Nitrification and nitrogen removal," *Water Research*, 11, 897-925.
- Steele, J. (1962). "Environmental control of photosynthesis in the sea," *Limnology and Oceanography*, 7, 137-150.

- Storms, S. (1974). "Selective feeding, ingestion and assimilation rates, and distribution of the copepod *Acartia* in Chesapeake Bay," Ph.D. dissertation, Johns Hopkins University, Baltimore, MD.
- Stratton, F., and McCarty, P. (1967). "Prediction of nitrification effects on the dissolved oxygen balance of streams," *Environmental Science and Technology*, 1, 405-410.
- Strickland, J. (1960). "Measuring the production of marine phytoplankton," *Fisheries Research Board of Canada Bulletin*, 122, 172.
- Taft, J., Taylor, W., and McCarthy, J. (1975). "Uptake and release of phosphorus by phytoplankton in the Chesapeake Bay estuary, USA," *Marine Biology*, 33, 21-32.
- Tchobanoglous, G., and Schroeder, E. (1987). *Water quality*, Addison Wesley, Reading, MA.
- Thomann, R., and Fitzpatrick, J. (1982). "Calibration and verification of a mathematical model of the eutrophication of the Potomac Estuary," HydroQual, Inc., Mahwah, NJ.
- Tuffey, T., Hunter, J., and Matulewich, V. (1974). "Zones of nitrification," *Water Resources Bulletin*, 10, 555-564.
- Vanderborgh, J., Wollast, R., and Billen, G. (1977). "Kinetic models of diagenesis in disturbed sediments; Part I, Mass transfer properties and silica diagenesis," *Limnology and Oceanography*, 22(5), 787-793.
- Walker, T. (1982). "Use of a Secchi disk to measure attenuation of underwater light for photosynthesis," *Journal of Applied Ecology*, 19, 539-544.
- Wen, C., Kao, J., Wang, L., and Liaw, C. (1984). "Effect of salinity on reaeration coefficient of receiving waters," *Water Science and Technology*, 16, 139-154.
- Westrich, J., and Berner, R. (1984). "The role of sedimentary organic matter in bacterial sulfate reduction: the G model tested," *Limnology and Oceanography*, 29, 236-249.
- Wezernak, C., and Gannon, J. (1968). "Evaluation of nitrification in streams," *Journal of the Sanitary Engineering Division*, 94(SA5), 883-895.
- Wheeler, P., Gilbert, P., and McCarthy, J. (1982). "Ammonium uptake and incorporation by Chesapeake Bay phytoplankton: short-term uptake kinetics," *Limnology and Oceanography*, 27, 1113-1128.

Wilmot, P., Cadee, K., Katinic, J., and Kavanagh, B. (1988). "Kinetics of sulfide oxidation by dissolved oxygen," *Journal of the Water Pollution Control Federation*, 60, 1264-1270.

Wollast, R. (1974). "The silica problem," *The Sea*, Vol. 5, Wiley-Interscience, New York, NY, 359-392.

Yamada, S., and D'Elia, C. (1984). "Silica acid regeneration from estuarine sediment cores," *Marine Ecology Progress Series*, 18, 113-188.

# REPORT DOCUMENTATION PAGE

Form Approved  
OMB No. 0704-0188

Public reporting burden for this collection of information is estimated to average 1 hour per response, including the time for reviewing instructions, searching existing data sources, gathering and maintaining the data needed, and completing and reviewing the collection of information. Send comments regarding this burden estimate or any other aspect of this collection of information, including suggestions for reducing this burden, to Washington Headquarters Services, Directorate for Information Operations and Reports, 1215 Jefferson Davis Highway, Suite 1204, Arlington, VA 22202-4302, and to the Office of Management and Budget, Paperwork Reduction Project (0704-0188), Washington, DC 20503.

1. AGENCY USE ONLY (Leave blank)		2. REPORT DATE March 1995	3. REPORT TYPE AND DATES COVERED Final report	
4. TITLE AND SUBTITLE User's Guide to the CE-QUAL-ICM Three-Dimensional Eutrophication Model, Release Version 1.0			5. FUNDING NUMBERS	
6. AUTHOR(S) Carl F. Cerco, Thomas Cole				
7. PERFORMING ORGANIZATION NAME(S) AND ADDRESS(ES) U.S. Army Engineer Waterways Experiment Station 3909 Halls Ferry Road Vicksburg, MS 39180-6199			8. PERFORMING ORGANIZATION REPORT NUMBER Technical Report EL-95-15	
9. SPONSORING/MONITORING AGENCY NAME(S) AND ADDRESS(ES) U.S. Army Corps of Engineers Washington, DC 20314-1000			10. SPONSORING/MONITORING AGENCY REPORT NUMBER	
11. SUPPLEMENTARY NOTES Available from National Technical Information Service, 5285 Port Royal Road, Springfield, VA 22161.				
12a. DISTRIBUTION/AVAILABILITY STATEMENT Approved for public release; distribution is unlimited.			12b. DISTRIBUTION CODE	
13. ABSTRACT (Maximum 200 words)  CE-QUAL-ICM (Release 1.0) is a three-dimensional, time-variable eutrophication model. CE-QUAL-ICM incorporates 22 state variables that include physical properties; multiple forms of algae, carbon, nitrogen, phosphorus, and silica; and dissolved oxygen. The model incorporates a predictive submodel of benthic processes including sediment oxygen demand and sediment-water nutrient flux.  Features of the model include the following: operational in one-, two-, or three-dimensional configurations; state variables may be individually activated or deactivated; computations may be restarted following interruption; internal averaging of model output over arbitrary intervals; computation and reporting of concentrations, mass transport, kinetics transformations, and mass balances; and debugging aids.  The model does not compute hydrodynamics. Flows, diffusion coefficients, and volume must be specified externally and read into the model. The user must provide processors which prepare input files and process output for presentation.  CE-QUAL-ICM is coded in ANSI Standard FORTRAN F77 and operates on a variety of platforms including 486 PC, unix work stations, and mainframe supercomputers.				
14. SUBJECT TERMS Chesapeake Bay Eutrophication Mathematical models			Nitrogen Nutrients Phosphorus	Phytoplankton Sediments
			15. NUMBER OF PAGES 316	16. PRICE CODE
17. SECURITY CLASSIFICATION OF REPORT UNCLASSIFIED	18. SECURITY CLASSIFICATION OF THIS PAGE UNCLASSIFIED	19. SECURITY CLASSIFICATION OF ABSTRACT	20. LIMITATION OF ABSTRACT	

**Destroy this report when no longer needed. Do not return it to the originator.**