

Infection Control for Viral Haemorrhagic Fevers in the African Health Care Setting

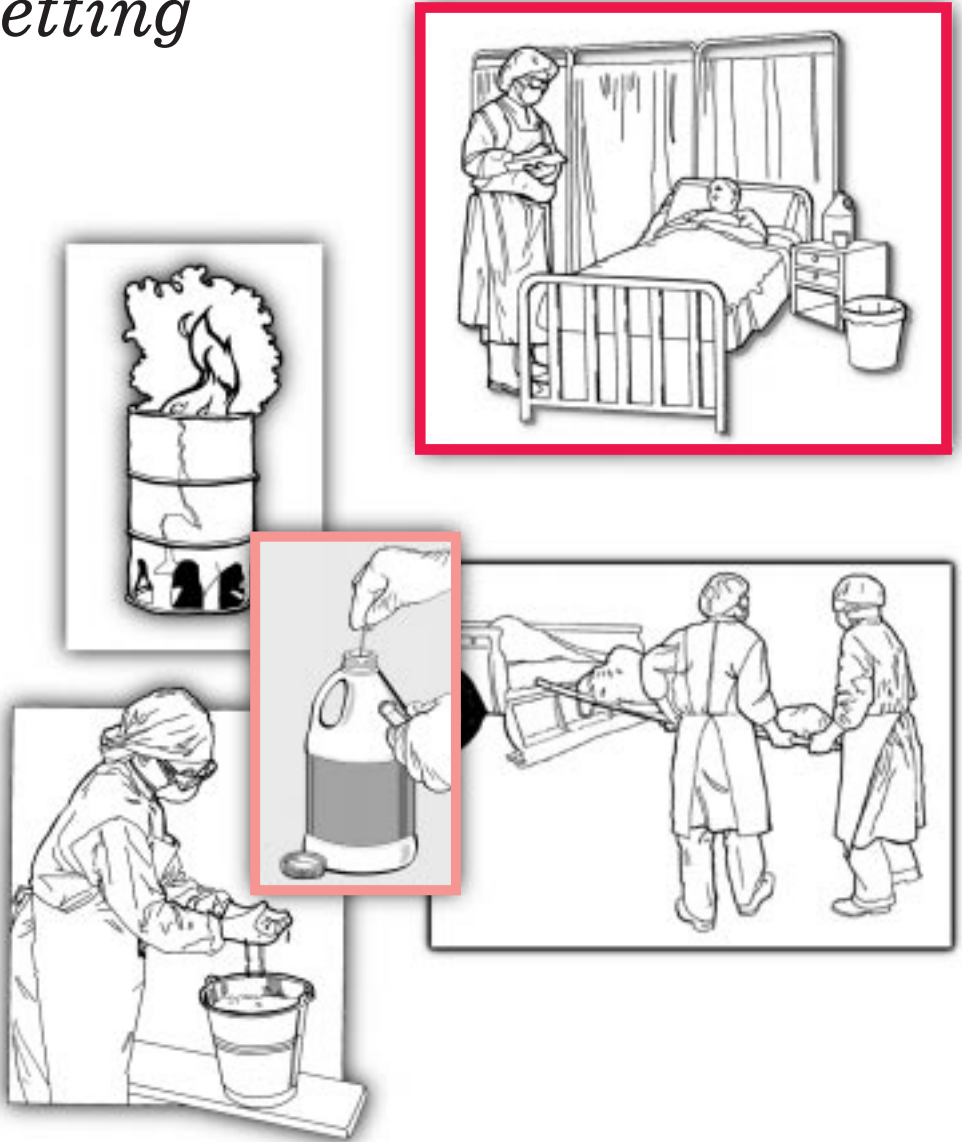

World Health Organization



U.S. DEPARTMENT OF HEALTH & HUMAN SERVICES
Public Health Service



C. J. Peters, M.D., Chief

Special Pathogens Branch
Division of Viral and Rickettsial Diseases
National Center for Infectious Diseases
Centers for Disease Control and Prevention

Guenael Rodier, M.D., Chief

Epidemiological Surveillance and Epidemic Response
Division of Emerging and Other Communicable Diseases
World Health Organization

Developed and written by:

Ethleen Lloyd, M.S., C.H.E.S., Health Communication Specialist
Special Pathogens Branch (CDC)

Helen Perry, M.A., Educational Design Specialist
Special Pathogens Branch (CDC)

Layout and design by:

Lilien Yang, M.S., Visiting Fellow
Special Pathogens Branch (CDC)

Illustrations by:

Willie Richardson, A.A., Visual Information Specialist
Division of Media and Training Services, Public Health Program Practice Office (CDC)

The material in this manual is in the public domain. It may be used and reprinted without permission. The source should be acknowledged. Suggested citation: Centers for Disease Control and Prevention and World Health Organization. Infection Control for Viral Haemorrhagic Fevers in the African Health Care Setting. Atlanta, Centers for Disease Control and Prevention, 1998: 1-198.

Infection Control for Viral Haemorrhagic Fevers in the African Health Care Setting

December 1998

This manual was prepared by:

Centers for Disease Control and Prevention: National Center for Infectious Diseases,
Division of Viral and Rickettsial Diseases, Special Pathogens Branch, WHO Collaborating
Centre for Viral Haemorrhagic Fevers

and

World Health Organization: Division of Emerging and Other Communicable Diseases --
Surveillance and Control

Acknowledgements

The contributions of the following organizations to the preparation and review of this document are gratefully acknowledged:

Centers for Disease Control and Prevention

Hospital Infections Program

Office of Health and Safety

World Health Organization

WHO Regional Office for Africa

WHO Country Programmes in Kenya and Gabon

Centre International de Recherches Médicales de Franceville, Gabon

Communicable Disease Surveillance Centre, United Kingdom

Dr. Kalongi and the staff of Clinique Bondeko, République Démocratique du Congo

École de Médecine, Université de Kinshasa, République Démocratique du Congo

Épicentre, France

Fogarty International, USA

Hôpital Général de Kikwit, République Démocratique du Congo

Institut de Médecine Tropicale, Belgium

Institut de Recherche Biologique Appliquée de Guinée

Institut Pasteur à Paris, France

Institute of Virology, Germany

Johns Hopkins School of Public Health, USA

Lassa Fever Research Projects, Guinea, Sierra Leone

Medical Emergency Relief International, United Kingdom

Médecins Sans Frontières, Belgium

National Institute of Virology, South Africa

Participants attending the CDC WHO VHF Isolation Precautions workshops held at Mumias, Kenya, and Booué, Gabon

Swedish Institute for Infectious Diseases, Sweden

Tulane University, USA

United States Army Medical Research Institute of Infectious Diseases, USA

Virus Research Centre, Kenya Medical Research Institute, Kenya

Yale University, USA

Table of Contents

Introduction	1
Viral Haemorrhagic Fevers: An Overview	3
How VHF Is Transmitted in the Health Care Setting	4
What Is in This Manual	5
Who the Manual Is For	5
Objectives	5
How to Use the Manual	6
Glossary for Use with This Manual	8
Section 1 Use Standard Precautions with All Patients	9
1.1 Use Standard Precautions	11
1.2 Establish and Maintain a Minimum Level of Standard Precautions	12
1.3 Establish Routine Handwashing	12
1.4 Handle and Dispose of Sharp Instruments Safely	14
1.5 Disinfect Reusable Needles and Syringes Safely	15
1.6 Disinfect Disposable Needles and Syringes That Must Be Reused	15
1.7 Use VHF Isolation Precautions	16
1.8 Select a VHF Coordinator	18
Section 2 Identify Suspected Cases of VHF	19
2.1 Use Information from Previous Outbreaks to Suspect a VHF	22
2.2 Begin VHF Isolation Precautions	25
2.3 Alert Health Facility Staff about Specific Risk for VHF Transmission	25

2.4	Report the Suspected Case to the Health Authorities	27
2.5	Identify Patient’s Contacts and Travel History	28
Section 3	Isolate the Patient	29
3.1	Select Site for the Isolation Area	31
3.2	Plan How to Arrange the Isolation Area	32
3.3	Gather Recommended Supplies	34
3.3.1	Plan Disinfection for VHF-Contaminated Items	34
3.3.2	Gather Supplies for the Patient Area	35
3.3.3	Gather Supplies for the Changing Room	36
3.3.4	Arrange for Storing of Supplies Outside the Changing Room	36
3.4	Set Up Changing Rooms	37
3.5	Place Security Barrier Around Isolation Area	37
3.6	Consult Family Members about Patient Care	39
	Check List: Supplies for a Changing Room	41
	Check List: Supplies for Patient Area	42
Section 4	Wear Protective Clothing	43
4.1	Specify Who Should Wear Protective Clothing	45
4.2	Gather a Supply of Protective Clothing	46
4.3	Put On Protective Clothing	53
4.4	Take Off Protective Clothing	57
Section 5	Disinfect Reusable Supplies and Equipment	65
5.1	Prepare Bleach Solutions	68
5.2	Prepare Supply of Soapy Water	72
5.3	Disinfect Gloved Hands between Patients	73
5.4	Disinfect Used Gloves before Reuse	74

5.5	Disinfect Reusable Medical Instruments	75
5.6	Disinfect Bedpan or Waste Bucket	76
5.7	Disinfect Patient's Utensils	76
5.8	Disinfect Spills of Infectious Body Fluids	77
5.9	Disinfect Infectious Waste and Non-Reusable Supplies for Burning	78
5.10	Clean and Disinfect Protective Clothing	79
5.11	Clean and Disinfect Boots	79
5.12	Clean and Disinfect Patient's Bedding	80
5.13	Give First Aid for Accidental Exposures	81
Section 6	Dispose of Waste Safely	83
6.1	What Needs Disposal	85
6.2	Select Staff to Supervise Waste Disposal and Burning	87
6.3	Train and Supervise Staff to Carry Out Waste Disposal	87
6.4	Select Site for Burning VHF-Contaminated Waste	89
6.5	Use Incinerator to Burn VHF-Contaminated Waste	89
6.6	Use Pit to Burn VHF-Contaminated Waste	92
6.7	Take Steps to Ensure Security of Burning Site	93
Section 7	Use Safe Burial Practices	95
7.1	Prepare the Body Safely	97
7.2	Transport the Body Safely	98
7.3	Prepare Burial Site	98
7.4	Disinfect the Vehicle after Transporting the Body	99

Section 8	Mobilize Community Resources and Conduct Community Education	101
8.1	Identify Key Community Resources	104
8.2	Meet with Community Leaders and Assess the Current Situation.....	106
8.3	Describe the Target Population.....	108
8.4	Describe Problems Contributing to Transmission Risk.....	108
8.5	Identify Changes or Actions Required	108
8.6	Identify Barriers to Carrying Out Recommended Changes or Actions	109
8.7	Develop Specific Messages.....	109
8.8	Select Activities for Communicating Messages.....	110
8.9	Assign Tasks and Carry Out Activities.....	110
8.10	Evaluate Activities	111
8.11	Obtain Community Feedback.....	112
8.12	Meet Regularly with the Mobilization Committee.....	112
Section 9	Make Advance Preparations to Use VHF Isolation Precautions	113
9.1	Identify a VHF Coordinator to Oversee Preparations.....	115
9.2	Assess Current Readiness for VHF Isolation Precautions.....	116
9.2.1	Monitor Routine Handwashing Practices	116
9.2.2	Assess Readiness for Identifying Suspected VHF Cases	117
9.2.3	Assess Readiness for Setting Up a VHF Isolation Area	117
9.2.4	Assess Readiness for Medical, Laboratory, and Cleaning Staff	117
9.3	Train Health Facility Staff in VHF Isolation Precautions.....	118
9.4	Plan for Community Mobilization	121
9.5	Assess Current Supplies and Equipment.....	122
9.6	Periodically Reassess Supplies	122
	VHF Isolation Precautions Supplies.....	123

Annex 1	Standard Precautions for Hospital Infection Control	133
Annex 2	Specific Features of VHFs	135
Annex 3	Planning and Setting Up the Isolation Area	141
Annex 4	Adapting VHF Isolation Precautions for a Large Number of Patients	145
Annex 5	Making Protective Clothing	149
Annex 6	Requirements for Purchasing Protective Clothing	153
Annex 7	Disinfecting Water for Drinking, Cooking and Cleaning	157
Annex 8	Preparing Disinfectant Solutions by Using Other Chlorine Products	161
Annex 9	Making Supplies: Sharps Container, Incinerator, and Boot Remover	163
Annex 10	Sample Job-Aids and Posters for Use in the Health Facility	165
Annex 11	Laboratory Testing for VHFs	171
Annex 12	Skin Biopsy on Fatal Cases for Diagnosis of Ebola	173
Annex 13	Community Education Materials	181
Annex 14	Conducting In-Service Training for VHF Isolation Precautions	185
Annex 15	Local Resources for Community Mobilization and Education	187
Annex 16	International and Regional Contacts	189
References	193
Index	197

Figure List

Figure 1	Epidemiological graph of the Ebola hemorrhagic fever outbreak in Kikwit, 1995.....	3
Figure 2	An example of a handwashing station.....	13
Figure 3	Parts of hands that are often missed during handwashing.....	13
Figure 4	Standard sharps container.....	14
Figure 5	Using plastic bottle to dispose of used needles.....	14
Figure 6	Placing the disposable needle and syringe in soapy water.....	15
Figure 7	An example of VHF Isolation Precautions poster.....	26
Figure 8	A sample layout of an isolation area.....	32
Figure 9	A sample layout for a single patient.....	33
Figure 10	A sample layout for several patients.....	33
Figure 11	A security barrier and sign.....	37
Figure 12	An example of a sign-in sheet.....	38
Figure 13	Inner layer of clothing.....	46
Figure 14	Thin gloves.....	46
Figure 15	Using plastic bags as boots.....	47
Figure 16	Storing boots.....	47
Figure 17	Gown with ties.....	48
Figure 18	Wearing a plastic apron.....	48
Figure 19	Thick gloves.....	49
Figure 20	Using plastic bags as gloves.....	49
Figure 21	HEPA-filter mask.....	50
Figure 22	Surgical mask.....	51

Figure 23	Cotton mask	51
Figure 24	Head covering	51
Figure 25	Wearing clear eyeglasses or goggles	52
Figure 26	Scrub suit	53
Figure 27	Putting on boots	53
Figure 28	Putting on the first pair of gloves	54
Figure 29	Putting on the outer gown	54
Figure 30	Putting on a plastic apron	55
Figure 31	Proper way to put on the second pair of gloves	55
Figure 32	Putting on mask	55
Figure 33	Putting on head cover	56
Figure 34	Putting on eyewear	56
Figure 35	Disinfecting the boots	57
Figure 36	Disinfecting / disposing of used gloves	58
Figure 37	Removing the apron	59
Figure 38	Removing the gown	59
Figure 39	Washing the gloved hands	59
Figure 40	Removing the eyewear	60
Figure 41	Removing the head cover	60
Figure 42	Removing the mask	60
Figure 43	A boot remover	61
Figure 44	Removing the inner gloves	61
Figure 45	Marking container for mixing 1:10 bleach solution	69
Figure 46	Preparing bleach solutions	70

Figure 47	Preparing bleach solutions during an outbreak.....	71
Figure 48	Small piece of cake soap.....	72
Figure 49	Checking gloves for holes.....	74
Figure 50	Disinfecting a spill on the floor.....	77
Figure 51	Disinfecting a spill on the wall.....	78
Figure 52	Transferring laundry to the cleaning area.....	79
Figure 53	Cleaning patient's bedding.....	80
Figure 54	A 220-litre drum.....	89
Figure 55	Making an incinerator.....	90
Figure 56	Making an incinerator.....	90
Figure 57	A completed incinerator.....	91
Figure 58	Disinfecting the vehicle after transporting the body.....	99
Figure 59	Meeting community leaders.....	107

Introduction



African countries (shaded areas) where viral haemorrhagic fevers have been documented in the past



Viral Haemorrhagic Fevers: An Overview

In Africa, viral haemorrhagic fevers (VHFs) include Lassa fever, Rift Valley fever, Marburg and Ebola haemorrhagic fevers, Crimean-Congo haemorrhagic fever (CCHF) and yellow fever. Humans initially contract an infection with a haemorrhagic fever virus through exposure to rodents or insects (for Ebola and Marburg VHFs, the natural reservoir is unknown). Person-to-person transmission of Lassa, Ebola, Marburg and CCHF viruses can occur through direct contact with VHF-infected material.

Typically, during the course of a VHF, the blood vessels and many organ systems are damaged. VHFs are often accompanied by bleeding, reflecting the widespread presence of the virus throughout the patient's body. As a result, the blood, urine, vomitus, pus, stool, semen and saliva from the VHF patient are infectious. This is why VHFs pose a serious risk to caregivers in the health care setting and in the community.

The transmission risk of VHFs in the health care and laboratory setting is well documented. During the 1995 Ebola haemorrhagic fever outbreak in Kikwit (former Zaire, and now the Democratic Republic of the Congo), one fourth of the cases were in health care workers with a history of recent patient care.¹ After barrier nursing practices (such as wearing protective clothing) were implemented, the risk of transmission was reduced. No new cases were reported among health care workers who used these practices. (Fig.1)

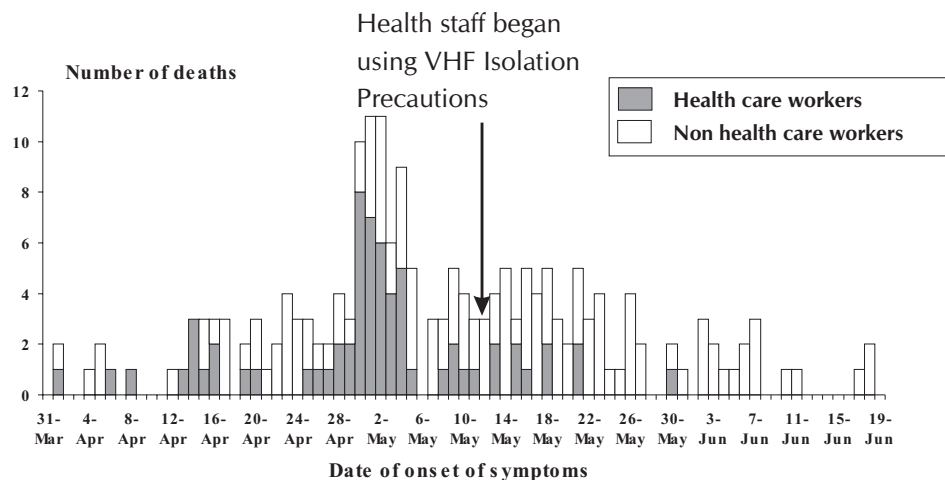
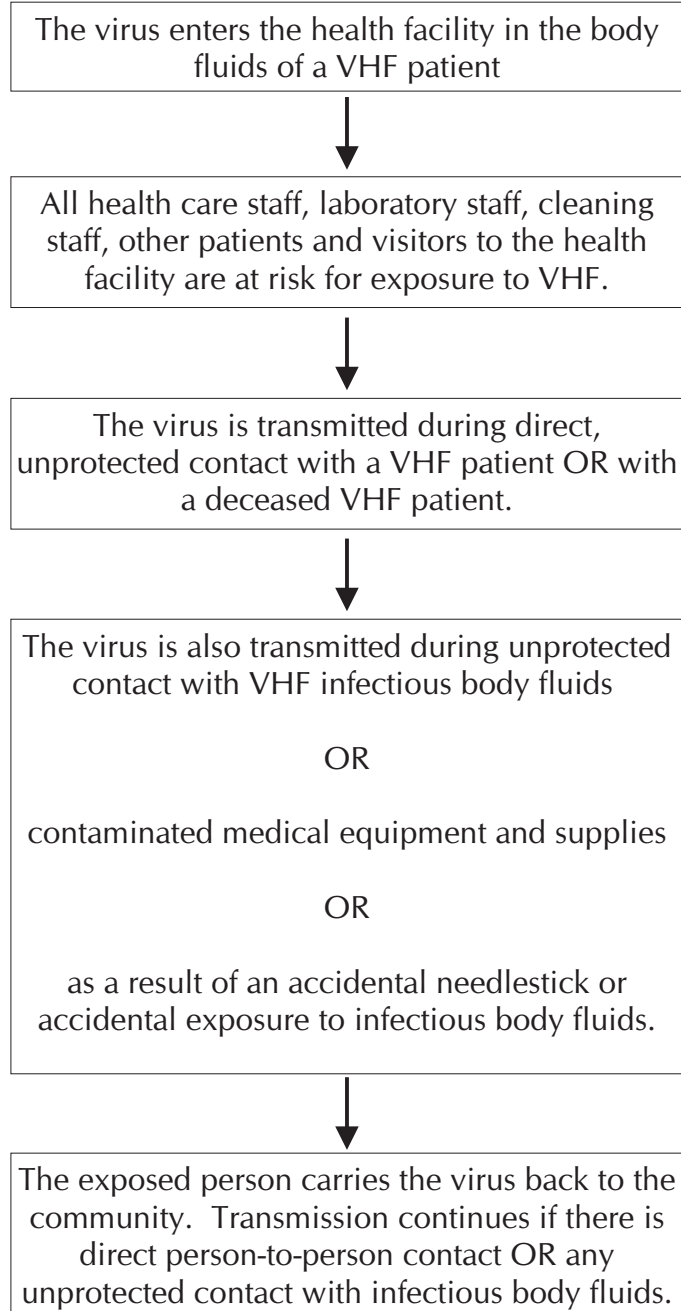

Fig. 1. The number of infected health care workers declined after barrier nursing practices were begun during the Ebola haemorrhagic fever outbreak at Kikwit, 1995. One case resulted from an inappropriate use of barrier nursing practices.

1 Khan AS et al. The Reemergence of Ebola Hemorrhagic Fever, *Journal of Infectious Diseases*, in press, 1998.



How VHF Is Transmitted in the Health Care Setting



What Is in This Manual

This manual describes a system for using VHF Isolation Precautions to reduce the risk of transmission of VHF in the health care setting. The VHF Isolation Precautions described in the manual make use of common low-cost supplies, such as household bleach, water, cotton cloth, and plastic sheeting. Although the information and recommendations are intended for health facilities in rural areas in the developing world, they are appropriate for any health facility with limited resources.

Who the Manual Is For

The manual is intended primarily for health officers who implement infection control in the health care setting, and for:

- Health facility administrators
- Hospital outbreak coordinators
- Chief medical officers
- Chief nursing officers
- Medical and nursing staff
- Medical and nursing educators
- Public health officers and programme administrators.

Objectives

The information in this manual will help health facility staff to:

1. Understand what VHF Isolation Precautions are and how to use them to prevent secondary transmission of VHF in the health facility.
2. Know when to begin using VHF Isolation Precautions in the health care setting.
3. Apply VHF Isolation Precautions in a large-scale outbreak. (When a VHF occurs, initially as many as 10 cases may appear at the same time in the health facility.)



-
4. Make advance preparations for implementing VHF Isolation Precautions.
 5. Identify practical, low-cost solutions when recommended supplies for VHF Isolation Precautions are not available or are in limited supply.
 6. Stimulate creative thinking about implementing VHF Isolation Precautions in an emergency situation.
 7. Know how to mobilize community resources and conduct community education.

How to Use the Manual

This manual can be used as a rapid reference when one or two cases of a VHF appear in a health facility and no previous preparations for VHF Isolation Precautions have been done. Administrators or hospital outbreak coordinators can use the information and instructions to set up an isolation area quickly and make adaptations from local materials so that an effective system of infection control can be implemented as soon as possible.

The manual can also be used for planning and carrying out in-service training aimed at strengthening VHF Isolation Precautions. It can be accompanied by workshop activities, in which participants discuss and practice the recommendations made in this manual.

The manual should be used to help health facilities make advance preparations for responding with appropriate precautions when a VHF case is suspected.

This manual consists of nine sections:

- Section 1** **Use Standard Precautions with All Patients** describes how to establish routine precautions for infection control. The section emphasizes the importance of using Standard Precautions consistently, especially handwashing before and after examining patients with fever.
- Section 2** **Identify Suspected Cases of VHF** lists common signs and symptoms of VHF and the immediate precautions to take when a VHF is suspected.
- Section 3** **Isolate the Patient** lists recommended supplies and describes how to set up an isolation area. It includes checklists that can be used in an emergency situation and practical suggestions for alternate equipment when recommended items are not available.
- Section 4** **Wear Protective Clothing** describes the protective clothing that should be worn when VHF is present in the health facility. It also provides information about selecting appropriate items when recommended clothing is not available.
- Section 5** **Disinfect Reusable Supplies and Equipment** describes the use of VHF Isolation Precautions during patient care and when disinfecting and cleaning contaminated surfaces, supplies and equipment. This section also presents recommended first aid for accidental exposures.
- Section 6** **Dispose of Waste Safely** describes step-by-step procedures for disposing of VHF-contaminated waste. It also lists detailed instructions for building an incinerator from available material.
- Section 7** **Use Safe Burial Practices** describes how to prepare bodies of deceased VHF patients safely for burial and how to prevent disease transmission through contact with the deceased patient.
- Section 8** **Mobilize the Community and Conduct Community Education** provides guidance for involving the community in disease prevention and control activities when VHF is suspected. It also describes how to choose a VHF Coordinator.
- Section 9** **Make Advanced Preparations to Use VHF Isolation Precautions** lists steps for preparing in advance to use VHF Isolation Precautions. If advance preparations have been carried out, and a VHF is suspected, the supplies are ready and health facility staff are trained in recommended practices. When advance preparations are not possible, VHF Isolation Precautions must be implemented in an emergency situation.

The **Annexes** provide additional details about specific topics described in the manual.

Glossary for Use with This Manual

Changing room	Area next to isolation ward where health workers dress in protective clothing, disinfect hands and gloves, and dispose of soiled and contaminated protective clothing.
Cleaning	Removal of any soiling or other material on equipment or surfaces before disinfection or sterilization.
Contamination	Presence of infectious agent in blood and other body fluids, on body surfaces and medical equipment, clothing and supplies. Contact with contaminated body fluids or items is a risk for disease transmission.
Disinfection	Elimination of <i>most</i> microorganisms from a surface, making it safe for reuse. "Sterilization" means eliminating <i>all</i> microorganisms.
Health care worker	Any person trained to provide patient care (medical, nursing, paramedical, emergency room nurses, community health workers).
Health facility	Any hospital, health centre or clinic with inpatient facilities. Also any facility providing emergency or first-service care.
Health facility staff	All patient care, laboratory, cleaning, disposal, reception, and administrative staff who are likely to have contact with suspected VHF cases, VHF infectious body fluids, and infectious waste.
Isolation area/ward	The area in the health facility used for housing suspected VHF patients. It includes the patient's room or area, isolated latrine or toilet, family entrance, and changing room.
Protective clothing	Masks, gloves, gowns, eyeglasses, caps, aprons, and boots. Provides protection against splashes or spills of infectious material when examining suspected VHF cases or handling infectious waste and laundry.
Sharps container	Puncture-resistant container for collecting used needles and syringes.
Standard Precautions	Practices for limiting or preventing disease transmission in the health care setting.
Sterilization	Elimination of all microorganisms (viral, bacteria, and fungal) through heat, using an autoclave or steam sterilizer, or other appropriate methods.
VHF Coordinator	Designated health officer who coordinates infection control and outbreak response, and provides liaison with the community and other agencies involved in outbreak control.
VHF Isolation Precautions	Barrier nursing and other infection control practices for preventing contact between VHF infectious body fluids and non-infected persons.

Section 1

Use Standard Precautions with All Patients



This section describes how to:

- Identify a minimum level of Standard Precautions for use with all patients regardless of their infection status.
- Establish routine handwashing practices.
- Establish safe handling and disposal of used needles and syringes.
- Be prepared to intensify Standard Precautions and include VHF Isolation Precautions.
- Identify a VHF Coordinator to oversee and coordinate activities associated with VHF Isolation Precautions.



Section 1

1.1 Use Standard Precautions

Health workers throughout the world are aware of the risks for transmitting human immunodeficiency virus (HIV) and hepatitis viruses in the health care setting. Many use precautions (such as wearing gloves) for preventing contact with infected blood.

Other dangerous diseases are also transmitted through contact with blood or other body fluids and pose a significant risk in the health care setting. For instance, a patient with a VHF may come to the health facility at any point in his or her illness,

- When the possibility of exposure is often highest, and
- Before the specific cause of the patient's illness is known.

Because a health worker cannot always know when a patient's body fluids are infectious, Standard Precautions² should be used with all patients in the health care setting, regardless of their infection status.

Standard Precautions are designed to prevent unprotected contact between the health care worker and

- Blood and all body fluids whether or not they contain blood
- Mucous membranes.

When a specific diagnosis is made, additional precautions are taken, based on how the disease is transmitted.³

2 See Annex 1 for more information about Standard Precautions.

3 This manual describes the Isolation Precautions to use when a patient is known to have or suspected of having a VHF. Annex 1 describes other precautions for various modes of disease transmission.



1.2 Establish and Maintain a Minimum Level of Standard Precautions

Limited supplies and resources may prevent a health facility from using all the Standard Precautions all the time. However, health facilities should establish and maintain a basic, practical level of Standard Precautions that can be used routinely with patients in their health facility.

At a minimum, consider the services in the health facility that present a risk of disease transmission due to potential contact with blood and all body fluids, broken skin or mucous membranes.

For health facility staff who work in such areas, establish at least:

- A source of clean water (Please see Annex 7)
- Routine handwashing before and after any contact with a patient who has fever
- Safe handling and disposal of sharp instruments and equipment, including needles and syringes.

1.3 Establish Routine Handwashing

Handwashing is the most important precaution for the prevention of infections.

Handwashing before and after contact with a patient who has fever should be a routine practice in the health facility — even when VHF is not present. Washing hands with soap and water eliminates microorganisms from the skin and hands. This provides some protection against transmission of VHF and other diseases.

In services where health care workers see patients with fever, provide at least:

- Cake soap cut into small pieces
- Soap dishes. Microorganisms grow and multiply in humidity and standing water. If cake soap is used, provide soap dishes with openings that allow water to drain away.
- Running water, or a bucket kept full with clean water

- A bucket for collecting rinse water and a ladle for dipping, if running water is not available
- One-use towels. Sharing towels can result in contamination. Use paper towels. If they are not available, provide cloth towels that can be used once and then laundered. If towels are not available, health care workers and health facility staff can air-dry their hands.



Fig. 2. An example of a handwashing station

Make sure health facility staff know the steps of handwashing:

1. Place a piece of soap in the palm of one hand.
2. Wash the opposite hand and forearm. Rub the surfaces vigorously for at least 10 seconds. Move soap to the opposite hand and repeat.
3. Use clean water to rinse both hands and then the forearms. If running water is not available, pour clean water from a bucket over the soapy hands and forearms. The rinse water should drain into another bucket.
4. Dry the hands and forearms with a clean, one-use towel. First dry the hands and then the forearms. Or let rinsed hands and forearms air-dry.

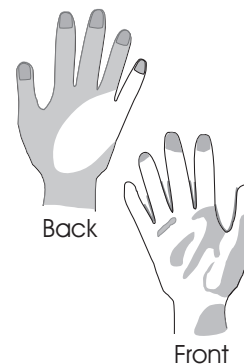

Fig. 3. The shading shows the parts of hands that are often missed during handwashing. Make sure to wash all parts of your hands: front, back, between the fingers and under nails.



1.4 Handle and Dispose of Sharp Instruments Safely

Disease transmission can occur through accidental needlestick injuries. Make sure health facility staff always handle sharp instruments safely. Do not recap needles after use.

Limit invasive procedures to reduce the number of injectable medications. This will limit the opportunities for accidental needlestick injuries.

When an injection *is* necessary, always use a sterile needle and sterile syringe for each injection.

To discard disposable needles and syringes safely: Disposable needles and syringes should be used only once. Discard the used disposable needle and syringe in a puncture-resistant container. Then burn the container in an incinerator or pit for burning.

Instructions for using incinerators and pits for burning are described in Section 6.

If puncture-resistant containers are not available, use empty water, oil, or bleach bottles made with plastic or other burnable material. Adapt them for use as puncture-resistant containers.

Detailed instructions for making a puncture-resistant container are listed in Annex 9.



Fig. 4. Standard sharps container



Fig. 5. Using plastic bottle to dispose of used needles

1.5 Disinfect Reusable Needles and Syringes Safely

Reusable needles and syringes are **not** recommended. If reusable needles and syringes are used, clean, disinfect and sterilize them before reuse, according to your hospital's policy.

Note: Needles and syringes used with VHF patients require special care. Cleaning staff should wear two pairs of gloves when handling needles and syringes used with any patient with a known or suspected VHF. See the recommendations for wearing protective clothing when handling contaminated supplies in Section 4.

1.6 Disinfect Disposable Needles and Syringes That Must Be Reused

Remember! *Whenever possible, use disposable needles and syringes only once and then discard them safely.*

In situations when disposable needles and syringes **must** be reused, make sure they are cleaned and disinfected after each use. Disinfection with bleach will reduce the risk of transmission of VHF and blood-borne diseases, such as HIV infection and viral hepatitis.

1. Obtain a jar or pan. Clean and disinfect it. Use it in Step 8 to store the disinfected needles and syringes.
2. Place the disposable needle and syringe in a pan of soapy water after use. Fill the needle and syringe with soapy water. Leave them to soak until they are cleaned.
3. Take the soaking needles and syringes to the cleaning area.
4. Clean them very carefully in soap and water. Remove any blood or other biological waste, especially from the area around the syringe fittings. Blood or other biological products may collect in these small openings.



Fig. 6. Placing the disposable needle and syringe in soapy water



5. Draw full-strength bleach into the needle and syringe.
6. Soak for 30 seconds, and then expel bleach into a container for contaminated waste.
7. Soak again by once more drawing full-strength bleach into the needle and syringe. Soak for 30 seconds, and then expel bleach into the container for contaminated waste.
8. Let the disinfected needle and syringe air-dry. Store them in a clean jar or pan that has been disinfected.

1.7 Use VHF Isolation Precautions

Section 2 of this manual describes how to identify a suspected case of VHF so that relevant health facility staff can begin using VHF Isolation Precautions. When a VHF is suspected, those health facility staff who will have contact with the patient or with the patient's blood or other body fluids should intensify Standard Precautions and use VHF Isolation Precautions.

VHF Isolation Precautions: The VHF Isolation Precautions described in this manual have been shown to be effective in reducing the transmission of VHFs in the health care setting.

As soon as a case of VHF is suspected in the health facility, alert authorities and start VHF Isolation Precautions.

To reduce the risk of VHF transmission in a health care setting:

- | USE VHF ISOLATION PRECAUTIONS | |
|--------------------------------------|---|
| 1. | Isolate the patient. |
| 2. | Wear protective clothing in the isolation area, in the cleaning and laundry areas and in the laboratory. Wear a scrub suit, gown, apron, two pairs of gloves, mask, headcover, eyewear, and rubber boots. |
| 3. | Clean and disinfect spills, waste, and reusable equipment safely. |
| 4. | Clean and disinfect soiled linens and laundry safely. |
| 5. | Use safe disposal methods for non-reusable supplies and infectious waste. |
| 6. | Provide information about the risk of VHF transmission to health facility staff. Reinforce use of VHF Isolation Precautions with all health facility staff. |
| 7. | Provide information to families and the community about prevention of VHF and care of patients. |

Regular in-service training will strengthen skills for using VHF Isolation Precautions. When a VHF is suspected, efforts will have to be focused on providing care. There will not be enough time or opportunity to provide initial training in skills for VHF Isolation Precautions.

If health facility staff already know how to use VHF Isolation Precautions when a VHF is suspected, authorities can be alerted and VHF Isolation Precautions started without delay.

If health facility staff do not know how to use VHF Isolation Precautions when a VHF case is suspected, training will need to take place immediately.

1.8 Select a VHF Coordinator

Being prepared for an emergency situation can save lives. In addition to using a basic level of Standard Precautions with all patients, health facilities can also prepare in advance for situations when protective clothing, disinfection materials, and isolation procedures are needed urgently.

Many health facilities already have an emergency coordinator or emergency team who could assume the role of a “VHF Coordinator.” The “VHF Coordinator” will:

- Oversee advance preparations and ensure that health facility staff are prepared to use VHF Isolation Precautions.
- Serve as the focal point and coordinate activities when a VHF case is suspected.
- Take the lead in mobilizing the community when an urgent situation occurs.

Once a staff person is identified to serve as the VHF Coordinator, he or she can review the recommendations in this manual and begin the preparations described in Section 9. The VHF Coordinator can also encourage efforts to strengthen and reinforce the routine practice of a basic level of Standard Precautions with all patients.

Remember! Using a minimum level of Standard Precautions routinely will prevent transmission of contagious diseases, such as HIV infection, viral hepatitis and VHF.

Section 2

Identify Suspected Cases of VHF



This section describes how to:

- In a non-outbreak situation, suspect VHF in patients with fever, severe illness, and signs of unexplained bleeding.
- Alert relevant health facility staff and begin VHF Isolation Precautions as soon as VHF is suspected.
- Report the suspected case to designated health authorities.



Section 2

Section 2

Identify Suspected Cases of VHF

In an outbreak situation, several cases occur around the same time. They may be grouped together, and there may be person-to-person transmission. An initial diagnosis of a VHF can be made based on the signs and symptoms of the specific VHF.

Suspecting a VHF during a non-outbreak situation in a single case is more difficult. The early symptoms of a VHF include high fever and headache. These are also symptoms for many infections seen at the health facility.

Most patients who present with fever do not have a VHF. Their fever is more often caused by malaria, typhoid fever, dysentery, severe bacterial infection or other fever-producing illnesses usually seen in the area.

The health worker probably will not suspect a VHF until more severe signs develop and the patient does not respond to recommended treatment for other illnesses.

However, health workers should be aware of the possibility for suspecting a VHF in a non-outbreak situation. As soon as a VHF is suspected, VHF Isolation Precautions should begin. This will help reduce the number of people exposed to the VHF.



2.1 Use Information from Previous Outbreaks to Suspect a VHF

When a patient presents with fever, use the available diagnostic tools in your health facility to identify or exclude the cause of fever. For example, do a malaria smear or take a stool culture as soon as possible.

- Treat the most likely cause of the fever according to the appropriate treatment guidelines.
- If the fever continues after 3 days of recommended treatment, and if the patient has signs such as bleeding or shock, consider a VHF.
- Review the patient's history for any contact with someone who was ill with fever and bleeding or who died from an unexplained illness with fever and bleeding.
- If no other cause is found for the patient's signs and symptoms, suspect a VHF. Begin VHF Isolation Precautions.

The flowchart on the next page shows how to

- Suspect a VHF and
- Decide to use VHF Isolation Precautions.

The flowchart applies to a non-outbreak situation. Annex 4 gives examples of VHF case definitions in outbreak situations.

Use Isolation Precautions for Suspected VHF Cases

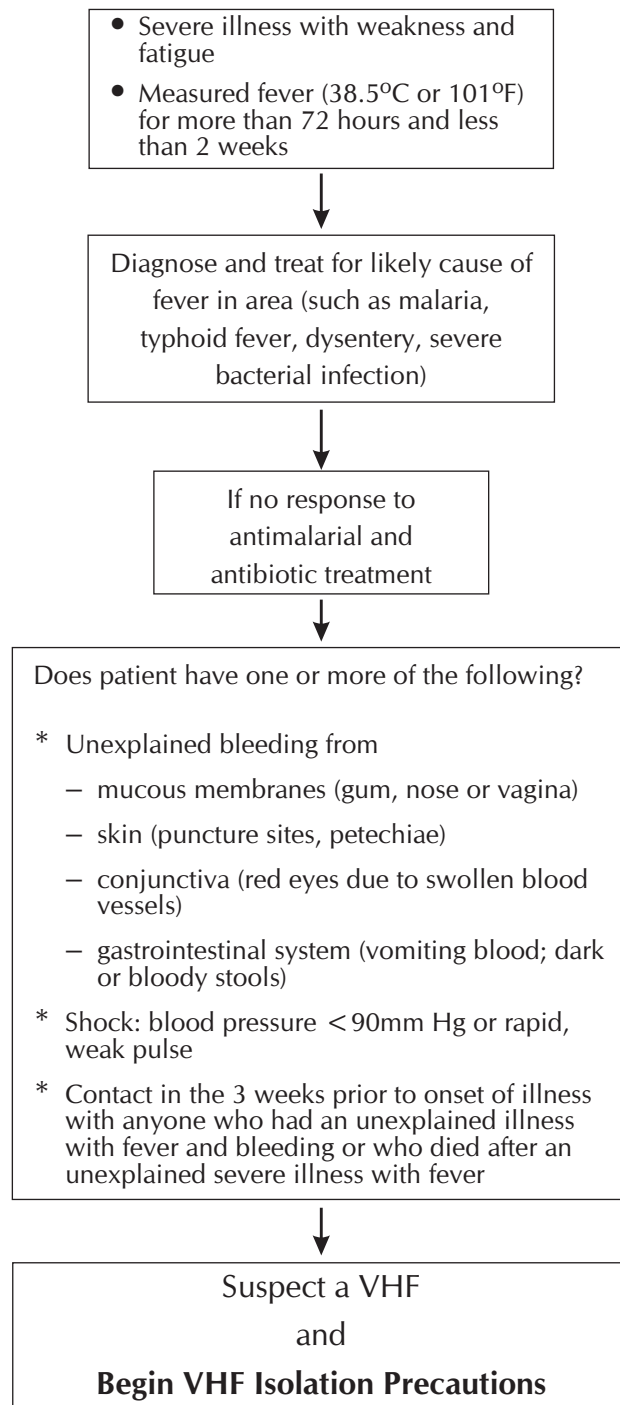



Section 2

If VHF have occurred in the area before:

Talk with the district or national surveillance officer about VHFs that have been reported in your area.⁴ Use the information when making a diagnosis of a suspected VHF case.

Record here the case definitions for VHFs that have been reported in your area:

VHF	Case Definition

4 Annex 2 provides more information about VHFs seen in the area of your health facility.

2.2 Begin VHF Isolation Precautions

Every health facility has its own procedures for responding to an urgent situation. Adapt VHF Isolation Precautions as needed. Designate the health officer who will coordinate VHF Isolation Precautions. How to select a VHF Coordinator is described in Section 9.1. As soon as a health care worker suspects a VHF, he or she should notify the health facility administrator and the VHF Coordinator who will:

- Refer the patient to the isolation area and take the necessary steps to begin VHF Isolation Precautions (See Section 3).
- Limit the number of health facility staff and visitors in the patient's room.
- Limit the use of invasive procedures and reduce the number of injectable medications.

Important! Between the time when VHF is suspected and when the patient is received in the isolation area, there is a risk for disease transmission from the patient's blood and other body fluids (stool, urine, vomit). Prevent disease transmission to other patients, visitors and health staff in the waiting area by placing the suspected VHF patient apart from other patients. Make every effort to reduce this waiting time.

2.3 Alert Health Facility Staff about Specific Risks for VHF Transmission

As soon as a VHF is suspected, alert the relevant health staff who should begin using VHF Isolation Precautions, especially:

- Doctors or nurses providing direct patient care
- Cleaning, laundry, and waste disposal staff who clean and disinfect contaminated material and supplies
- Laboratory staff who handle samples from the suspected VHF cases
- Medical or support staff who prepare or handle deceased VHF patients.



Section 2

Explain how VHF transmission can occur in the health facility and the risks to health facility staff.⁵ Remind the staff that VHF is a highly infectious disease. They must use VHF Isolation Precautions whenever they have contact with the VHF patient, the patient's blood or other body fluids, or contaminated supplies and equipment.

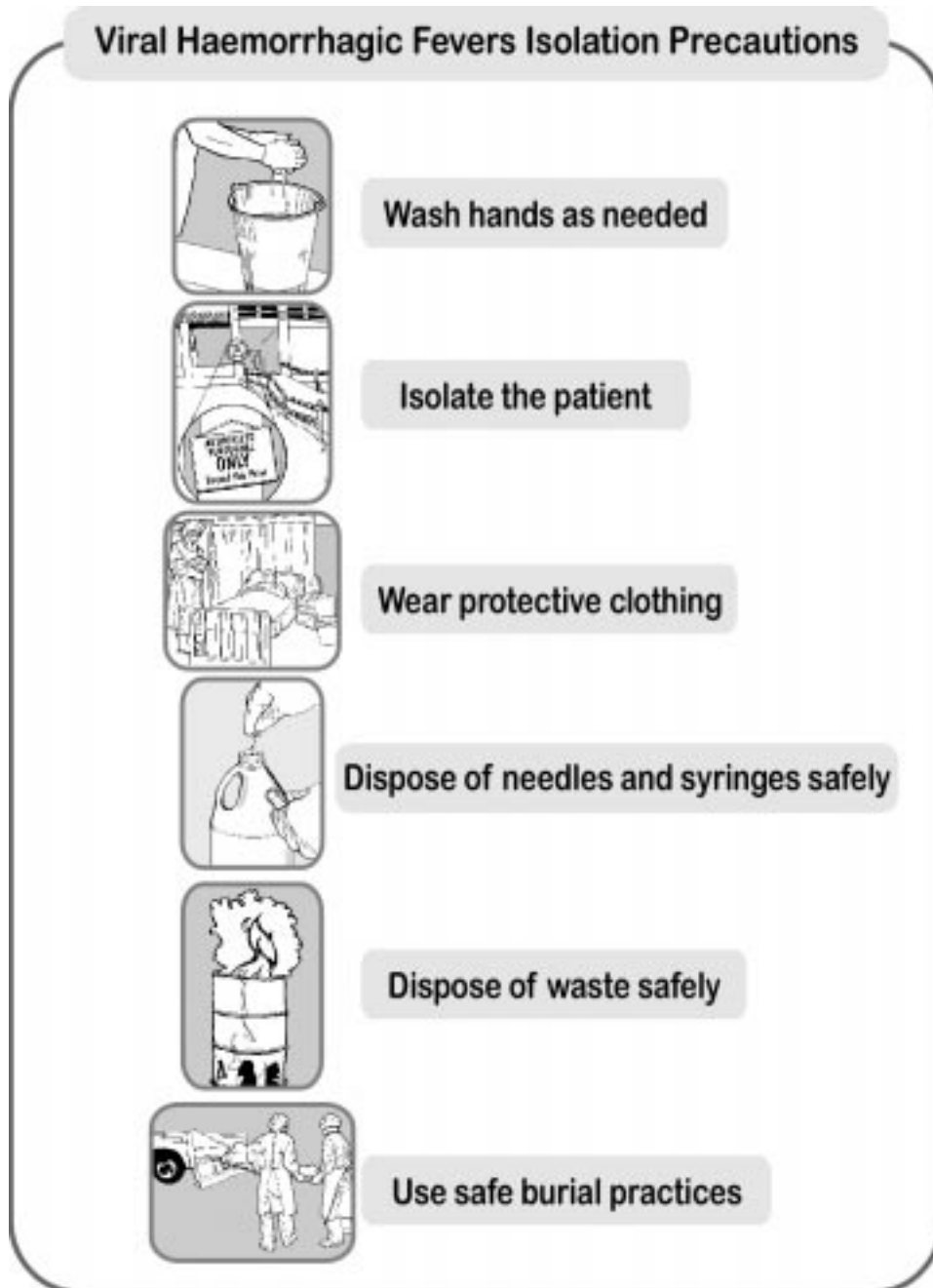

Fig. 7. An example of VHF Isolation Precautions poster.

5 The chart on page 4 of the Introduction summarizes the risk of VHF transmission in the health care setting.

2.4 Report the Suspected Case to the Health Authorities

Report suspected cases of VHF according to national level surveillance guidelines.

If your district is conducting special surveillance activities for a VHF, the district officer will provide specific information about whom you should contact and how. If serum samples are needed, the contact person will give you special instructions for collecting and shipping serum samples. The table below can be used to record information about whom to contact if a VHF is suspected.

Contact Person	Agency	Telephone and/or Fax Number	Information to Report	Samples to Collect



2.5 Identify Patient's Contacts and Travel History

Ask the patient (or a family member who can answer for the patient):

- Where do you live?
- When did the symptoms begin?
- Who else is sick in your family (or village)?
- Where have you travelled recently?

Use the answers to identify others who had contact with the patient. Provide them with information about VHF and when to seek care.

Section 8 describes the steps for giving information to the community about VHF and preventing VHF transmission.

Section 3

Isolate the Patient



This section describes how to:

- Gather supplies to set up an isolation area.
- Make a substitute item from available materials whenever a recommended item is not available.
- Select a site for the VHF isolation area and set up:
 - The patient's room
 - A changing room for health care workers to use when changing clothes
 - A changing room for other health facility staff to use near their work area
 - A family entrance, if necessary
 - A security barrier around the entire isolation area.
- Counsel family members about patient care.



Section 3

Section 3 Isolate The Patient

Isolating the VHF patient will:

- Restrict patient access to health facility staff trained to use VHF Isolation Precautions.
- Establish a barrier between the VHF patient and uninfected patients, other health facility staff, and visitors.

3.1 Select Site for the Isolation Area

Ideally, an isolation area should already be available to admit patients requiring isolation.

If an isolation area is not available or if advance preparations have not been done, and VHF is suspected, immediately identify and set aside:

- A single room with an adjoining toilet or latrine.

If a single room is not available, select one of the following in order of preference:

- A separate building or ward that can be used with VHF patients only (especially if Ebola haemorrhagic fever is suspected, or if there is a large number of patients)
- An area in a larger ward that is separate and far away from other patients in the ward
- An uncrowded corner of a large room or hall
- Any area that can be separated from the rest of the health facility (TB rooms, isolation ward for infectious diseases, private or semiprivate rooms).



Section 3

Make sure the selected site has:

1. **An isolated toilet:** If a toilet is not next to the patient's room, select and isolate a toilet near the isolation area. Use it to receive the patient's disinfected waste and other liquid waste.

If a toilet is not available, prepare a latrine for disposal of the patient's and other liquid waste.

2. **Adequate ventilation:** The isolation room should have adequate ventilation because chlorine disinfectants will be used. To prevent airborne or droplet transmission of infectious agents, avoid rooms with air conditioning.
3. **Screened windows:** If windows are left open for cooling, screen them to prevent transmission of mosquito- and other insect-borne diseases.

Restrict access. Tie a rope or line around the area outside the window to restrict the area and prevent entry through the window.

3.2 Plan How to Arrange the Isolation Area

Make use of the available space and design of the health facility to arrange the isolation area. The diagram below shows an ideal arrangement for an isolation area. The next page shows examples for a single patient's room and for a ward with several patients.

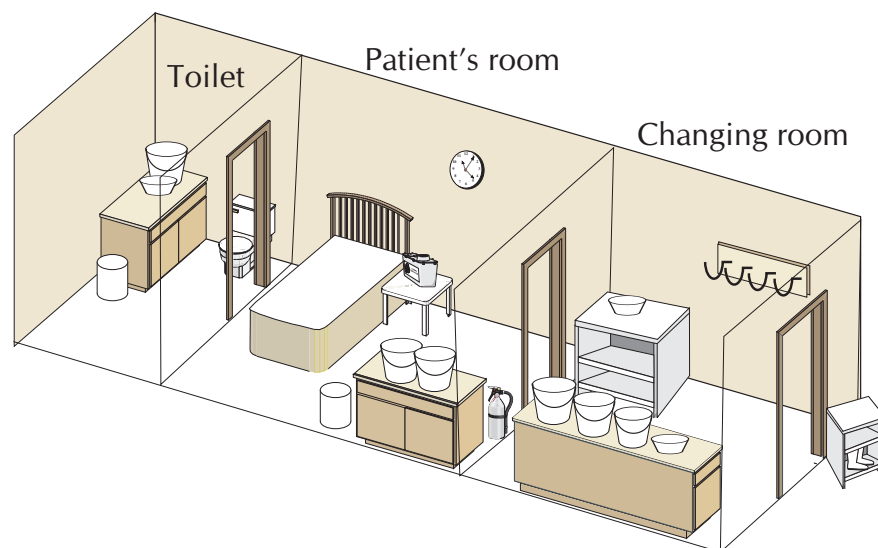

Fig. 8. A sample layout of an isolation area

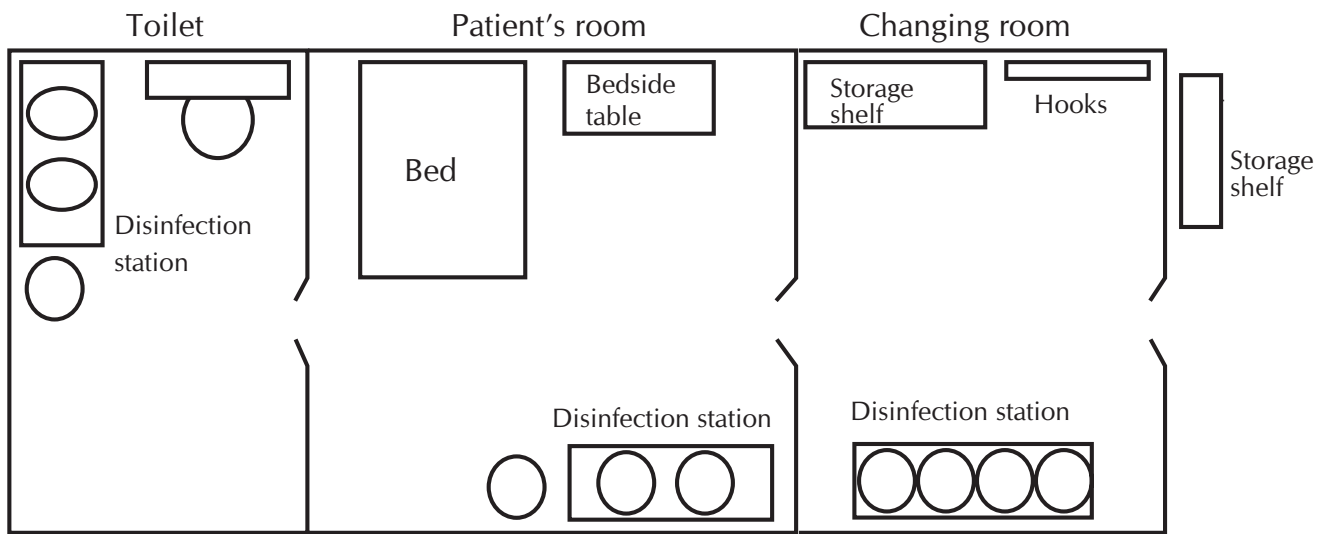

Fig. 9. A sample layout for a single patient

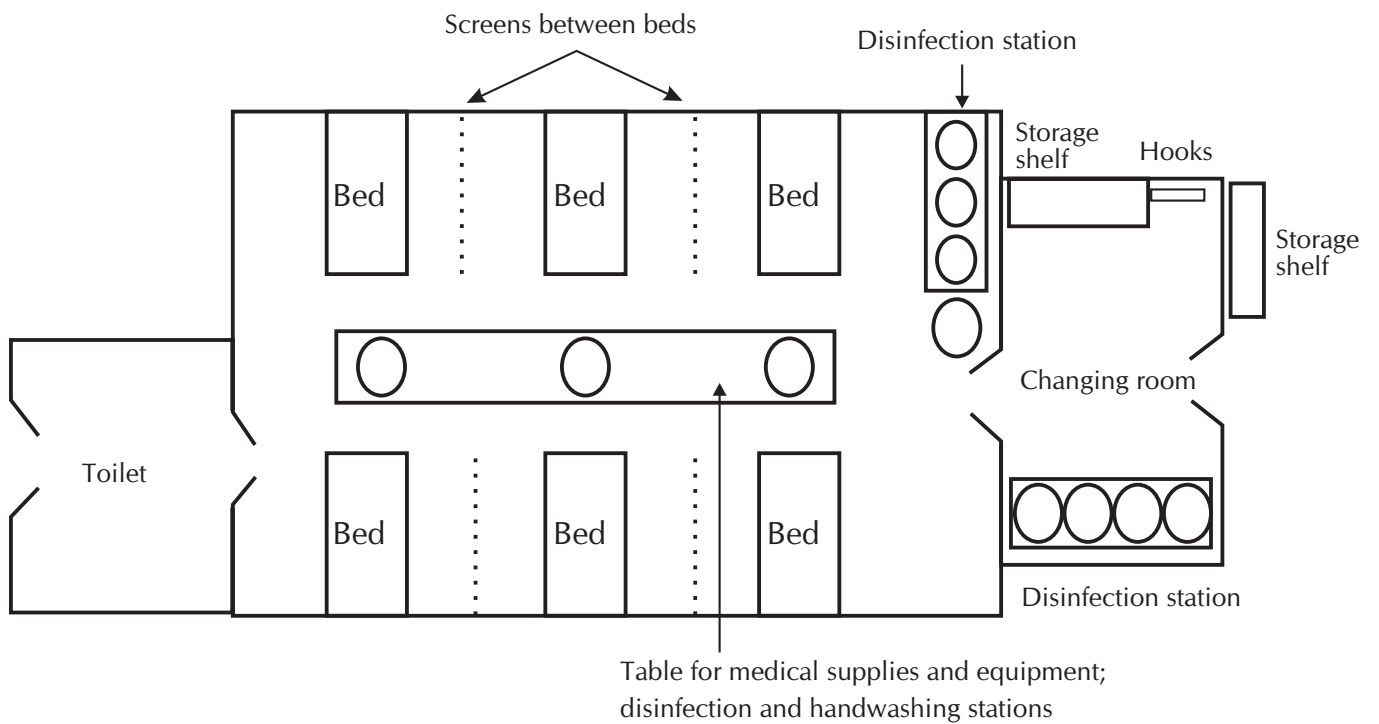

Fig. 10. A sample layout for several patients



3.3 Gather Recommended Supplies

Ideally, supplies should be available to begin VHF Isolation Precautions. If a separate emergency supply is **not** available when a VHF case is suspected, use supplies from other services in the health facility.

If a recommended item is not available, or if the quantity is limited, make a substitute item from available materials. For example, the manual recommends using plastic sheeting to cover mattresses. If plastic sheeting is not available, use plastic cloth normally used to cover kitchen tables. This is usually available in the local market.

3.3.1 Plan Disinfection for VHF-Contaminated Items

Ordinary household bleach, soap and water are useful disinfectants against viruses causing VHF.⁶ They are low in cost and commonly available.

Ordinary Household Bleach: The viruses causing VHF are very sensitive to bleach solution. This manual describes a low-cost disinfection system using two bleach solutions: a solution of 1:10 and a solution of 1:100. Detailed instructions for preparing the solutions are in Section 5.1.

Soap and Clean Water: Scrubbing with soap and water before disinfection removes infectious body fluids and other foreign matter from contaminated items. This makes bleach solutions more effective. Detailed instructions for preparing solutions of soapy water are in Section 5.2.

Sterilization: Heat sterilization requires special equipment, such as an autoclave or steam sterilizer. When this equipment is not working or is not available, boiling heat-resilient items in water for 20 minutes will kill VHF viruses.

6 VHF viruses are lipid enveloped, and this feature makes them sensitive to destruction by detergent solutions.

3.3.2 Gather Supplies for the Patient Area

Obtain the following items for use in the patient's room:

Bed and mattress or sleeping mat for each patient.

Plastic sheeting to cover the mattress or sleeping mat. This is strongly recommended. Plastic sheeting will protect the mattress from contamination. It can be easily cleaned and disinfected if it becomes contaminated with infectious body fluids.

Bedding for each bed – at least 1 blanket and a bottom sheet. If necessary, the patient or the patient's family can bring the bedding from home.

One thermometer, one stethoscope, and one blood-pressure cuff per patient. Keep them in the isolation area for reuse with the same patient.

If there is not enough equipment to supply one each of these items per patient, assign one piece of equipment for use only with the patients in the isolation area.

Covered container for alcohol or bleach solution used to disinfect thermometer and stethoscope after use with each patient.

Puncture-resistant container for collecting used disposable needles, syringes and other sharp instruments.

Puncture-resistant tray with soapy water for collecting reusable needles, syringes and instruments.

Bedside table or shelf on which to place medical instruments, puncture-resistant container, and so on.

Large wall clock with a second hand for measuring respiration rates and pulse.

Bedpan for each patient.

Screens or other barriers to place around the VHF patients' beds. This will prevent patient-to-patient transmission through spills or splashes of infectious body fluids or from aerosol routes.

If screens are not available, stretch ropes or lines from one end of the patient area to the other. Hang sheets from the ropes.

Disinfection station with buckets, sprayer, bleach solutions, soap and water, mop, and a supply of one-use towels. It is preferable to dispose of gloves after each use. However, the reuse of gloves in many health facilities is a common practice. Disinfect gloved hands between patients if there are not enough gloves for health care workers to dispose of after each patient.

Container with soapy water for collecting discarded outer gloves.

Boot sprayer for disinfecting the boots before leaving the patient's room.

Extra supply of gowns and gloves.

3.3.3 Gather Supplies for the Changing Room

Hooks, nails, or hangers for hanging reusable protective clothing.

Roll of plastic tape for taping cuffs and trousers of protective clothing.

Disinfection station with bleach solution for disinfecting gloved hands.

Handwashing station with bucket, soap, soap dish, clean water, and supply of one-use towels.

Containers with soapy water for collecting:

- Discarded gloves
- Used instruments to be sterilized.

Containers for collecting:

- Reusable protective clothing to be laundered
- Infectious waste to be burned.

3.3.4 Arrange for Storing of Supplies Outside the Changing Room

Shelf or box with a lock for storing clean protective clothing.

Supply of clean protective clothing.

Container for collecting non-infectious waste.

Covered shelf (or plastic bags which can be closed) to store disinfected boots and keep them dry.

The checklists at the end of this section can be used to gather supplies for the isolation area.

3.4 Set Up Changing Rooms

For patient-care staff:

One changing room is needed outside the patient isolation area. This area is where health care workers will put on protective clothing to protect them from spills or splashes of infectious body fluids while they are in the patient's room. After leaving the patient's room, they will reenter the changing room and remove the protective clothing. They will hang it for reuse or dispose of it appropriately.

Contaminated clothing and supplies remain in the changing room until cleaning staff trained to use VHF Isolation Precautions take the VHF-contaminated items to the laundry or disposal site.

For laboratory, cleaning, laundry, and waste disposal staff:

Set up changing rooms near the work areas for other health facility staff who will handle laboratory specimens and who will clean laundry, or dispose of contaminated items. They will also need to wear protective clothing during any contact they have with body fluids or VHF-contaminated items.

The stations in the changing room should be set up so that traffic flow is from the *least to most contaminated* area.

3.5 Place Security Barrier Around Isolation Area

Restrict access to the isolation area: Place signs around the isolation area clearly stating that access is restricted. Or tie lines or ropes around the isolation area and hang plastic sheets from them.



Fig. 11. A security barrier and sign



Section 3

Prepare a list of health facility staff and family members authorized to enter the isolation area: List the medical, nursing, laboratory, cleaning staff, and, if appropriate, those family members who are trained in the use of VHF Isolation Precautions. If an accidental exposure or incident occurs, the list can help in the prompt identification of possible contacts.

When there is a large number of patients, station a guard at the entry to the isolation area: In a large scale outbreak, station a security guard at the door of the patient isolation area outside the changing room. The guard will limit access to authorized health facility staff and family members only. This is critical for maintaining strict isolation and protecting the community.

Provide the guard with the list of authorized persons and a sign-in sheet. The guard can record who comes into the isolation area and note the time of entry and departure.

Date	Name	Service	Time In	Time Out
13.6.98	Dr. Nsango	Infectious Diseases	10:15	11:30
13.6.98	Nurse Bandari	Intensive Care	10:00	11:30
13.6.98	Nurse Ninakazi	Intensive Care	11:00	13:30
13.6.98	Masika	Cleaning	11:10	11:45
13.6.98	Madunda	Family member	11:15	

Fig. 12. An example of a sign-in sheet

3.6 Consult Family Members about Patient Care

Talk with family members and explain why the patient is being isolated. Tell them about the risk of transmission for VHF and why protective clothing is needed. Answer any questions they have.

When there is a large outbreak (more than one or two cases), identify a person to serve as a liaison between health facility staff and the patients' families. Select a health staff member, an experienced community member, or a convalescent patient.

If it is the custom for family members to provide cleaning and washing of the patient while the patient is in the health facility, help the family to select a caregiver. Select as caregiver the family member who has already had the most contact with the patient. Also select a second person who can do the patient care activities when the other caregiver is resting.

In areas where family members participate in patient care, they are likely to help the patient with:

- Feeding and giving water
- Washing the hospital gown or pyjama with soap and water
- Getting up or moving around.

When a VHF is suspected, it is likely that health care workers trained in VHF Isolation Precautions will do most of the direct patient care tasks. However, if there are family members who will assist with direct patient care, give them information and training about:

- The risk of VHF transmission and the reason for protective clothing
- How to wear gloves, gowns, and a mask
- How to take off gloves, gowns, and mask and store or dispose of them safely.

Make sure there is a changing room for family members to use that is separate from the changing room for health care workers. Provide a set of protective clothing for the family members to wear in the isolation room. At a minimum, make sure that the family members wear at least a pair of gloves.



Section 3

Provide in the family members' changing room:

- A shelf or table to store a supply of clean gloves to be worn by the family member
- Hooks to hang a set of protective clothing
- A bucket with soapy water for collecting discarded gloves after leaving the isolation area
- A handwashing station.

Arrange to monitor family members for signs of illness.

Assist family members with:

- Coordination of other family members who bring food for the patient and for the family member providing care
- Location of an area for family members to stay in while providing care that includes cooking, washing and sleeping facilities.

Note: When a breast-feeding mother has a suspected case of VHF, the child's breast-feeding should not be interrupted. Help the family to decide how to continue the child's breast-feeding when the mother is too ill to do so.

Checklist: Supplies for a Changing Room

Storage Outside the Changing Room:

1. Shelf or cabinet with lock _____
2. Supply of clean scrub suits, gowns, aprons, gloves, masks, headcovering, and eyewear _____
3. Covered shelf for storing disinfected boots _____
4. Bucket for collecting non-infectious waste _____

Inside the Changing Room:

1. Hooks, nails, or hangers for hanging reusable gowns, scrub suits _____
2. Roll of plastic tape _____
3. Handwashing supplies: bucket or pan, clean water, soap, one-use towels _____
4. Bucket or pan, 1:100 bleach solution for disinfecting gloved hands _____
5. Container with soapy water for collecting discarded gloves _____
6. Container with soapy water for collecting used instruments to be sterilized* _____
7. Container with soapy water for collecting reusable gowns, masks, sheets to launder* _____

*Place outside the changing room if the changing room is too small

If large amounts of waste on floor:

Sprayer, bucket or shallow pan with 1:100 bleach solution for disinfecting boots _____



Checklist: Supplies for Patient Area

1. 1 bed with clean mattress or sleeping mat and at least a bottom sheet and blanket for each bed _____
2. Plastic sheeting to cover mattress or sleeping mat _____
3. 1 thermometer, 1 stethoscope, and 1 blood pressure cuff for each patient or for each patient area _____
4. 1 puncture-resistant container for collecting non-reusable needles, syringes, and discarded sharp instruments _____
5. 1 bedside table or shelf _____
6. 1 large wall clock with a second hand _____
7. Pan with 1:100 bleach solution or alcohol and one-use towels for disinfecting the thermometer and stethoscope between use with each patient _____
8. Bucket or pan, 1:100 bleach solution, one-use towels for disinfecting gloved hands between patients _____
9. Supplies for disinfecting patient excreta (bedpan, urinal, 1:10 bleach solution) _____
10. Sprayer, 1:100 bleach solution, clear water, and mop for disinfecting spills on floor and walls _____
11. Container with soapy water for collecting discarded gloves _____
12. Screens (or sheets hung from ropes or lines) placed between VHF patients' beds _____
13. Extra supply of gowns and gloves _____
14. Container for collecting infectious waste to be burned _____

Section 4

Wear Protective Clothing



This section describes how to:

- Prepare a supply of protective clothing for use with VHF Isolation Precautions.
- Make adaptations from locally available materials when an item is not available, or if the supply is limited.
- Put on and take off protective clothing in the changing room.



Section 4

Section 4 Wear Protective Clothing

4.1 Specify Who Should Wear Protective Clothing

- All doctors, nurses, and health care workers who provide direct patient care to suspected VHF patients.
- All support staff who clean the isolation room, handle contaminated supplies and equipment, launder reusable supplies, and collect and dispose of infectious waste from VHF patients.
- All laboratory staff who handle patient specimens and body fluids from suspected VHF cases.
- Laboratory support staff who clean and disinfect laboratory equipment used to test VHF specimens.
- Burial teams who remove bodies of deceased VHF patients and prepare them for burial.
- Family members who care for VHF patients.

When a VHF case is suspected in the health facility, the following protective clothing should be worn in the isolation area:

- A scrub suit or inner layer of clothing (an old shirt and trousers brought from home)
- A pair of thin gloves
- Rubber boots or overshoes (only if the floor is soiled)
- A gown or outer layer of clothing (surgical or disposable gown with long sleeves and cuffs)
- A plastic apron worn over both layers of clothes
- A second pair of thin or thick gloves. Wearing a second pair of gloves provides an added measure of safety during patient care and when handling contaminated supplies
- A HEPA-filter (high-efficiency particulate air respirator) or other biosafety mask (or surgical mask if HEPA-filter or other biosafety mask is not available)



Section 4

- Cotton head covering
- Clear eyeglasses or non-fogging goggles.

Note: *When protective clothing is not available or is in short supply, adaptations must be made and used.*

4.2 Gather a Supply of Protective Clothing

Obtain and store the following items outside the changing room or in a storage cabinet inside the changing room.

Scrub suit or inner layer: Wear a scrub suit or a set of old clothes brought from home (such as a loose-fitting shirt and trousers). Avoid wearing long skirts to prevent contact between clothing and spills of infectious waste on the floor.



Fig. 13. Inner layer of clothing

Thin gloves: These permit fine-motor function when examining or caring for patients. They can be latex, vinyl, or surgical gloves; they do not need to be sterile. The gloves must reach well above the wrist, preferably 10 cm to 15 cm long (4 inches to 6 inches), measuring from the wrist up along the arm.



Fig. 14. Thin gloves

Boots: Boots or overboots must be worn over street shoes when infectious waste is on the floor. Common rubber boots are recommended. The sides of the boots should be at least 30 cm (12 inches) high and have textured soles.

If boots are not available, wear two layers of plastic bags.



Fig. 15. Using plastic bags as boots

Assign those staff who are entering the isolation area their own pairs of boots. Staff members will be responsible for storing their boots in a covered shelf or in a plastic sack between each use.



Fig. 16. Storing boots

Gown or Outer Layer: Wear a disposable surgical gown or a cotton gown over the first layer of clothes.

Disposable surgical gowns can be reused by the same staff member if they are not contaminated and are not obviously dirty and torn.

When the supply of disposable gowns is limited, wear a cotton surgical gown that can be washed and reused.



Section 4

The gown should:

- Open at the back and close with ties at the neck and waist.
- Be knee-length with collar wraps around the neck and elastic bands to close the gown around the wrist. If elastic bands are not used, sew on cotton loops. They can be hooked around the thumb to hold the sleeve in place.

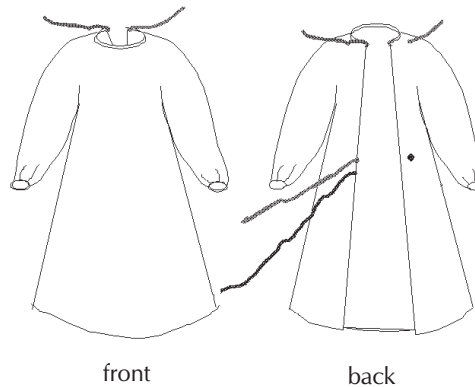

Fig. 17. Illustration of gown with ties

If the supply of cotton surgical gowns is limited, make additional gowns from local cotton fabric. Instructions for making cotton gowns are listed in Annex 5. Specifications for ordering gowns and other pieces of recommended clothing are listed in Annex 6.

Plastic Aprons: Wear a plastic apron over the outer gown. The apron prevents contact with infectious body fluids that may soak through protective clothing when the patient bleeds, coughs or vomits.

Plastic aprons should be worn by anyone who has direct contact with a suspected VHF case or infectious body fluids. These aprons are strongly recommended for:

- Nurses
- Laboratory staff
- Cleaning staff
- Staff who perform autopsies or prepare bodies for burial.



Fig. 18. Wearing a plastic apron

When a supply of commercial plastic aprons is not available, make aprons from plastic sheeting, rubber, or plastic cloth normally used to cover kitchen tables.

The apron should:

- Have hooks or ties that fasten around the neck.
- Have ties at the waist that reach around and tie at the back.
- Be long enough to cover the top of the boots and provide additional protection from spills running inside the boots.

Thick gloves: These are worn over an inner pair of thin or latex gloves. They are worn to clean spills, launder reusable protective clothing and patient bedding, handle disposable waste, and conduct autopsies and burial preparations.



Fig. 19. Thick gloves

The gloves can be made of neoprene or thick rubber. They should reach well above the wrist, about 30 cm (12 inches) up the arm. When thick rubber gloves are not available, use normal kitchen gloves as the outer layer of gloves.

If the supply of gloves is limited, wear one pair of gloves. Disinfect them after each contact with the VHF patient or with infectious body fluids and contaminated material. How to disinfect and clean gloves during patient care and for reuse is described in Sections 5.3 and 5.4.

If gloves are not available, use plastic bags to cover the hands.



Fig. 20. Using plastic bags as gloves



Section 4

If nothing is available to serve as a glove or hand covering, make sure health facility staff wash their hands with soap and water **immediately:**

- After every contact with the VHF patient
- Before leaving the patient's room
- After any contact with infectious body fluids
- After contact with any contaminated material.

How to set up handwashing stations is described in Section 1.3.

Mask: Masks protect the health care worker's face from contact with blood or droplets of infectious body fluids. Use masks that cover the mouth and nose. Use a HEPA-filter or other biosafety mask, a surgical mask, or a cotton mask made locally.

HEPA-filter or biosafety mask: A HEPA-filter mask filters the air to prevent breathing in small particles and harmful microorganisms. It provides protection from airborne transmission of microorganisms.



Fig. 21. HEPA-filter mask

A HEPA-filter or biosafety mask is lightweight and easy to use. It can be reused by the same health care worker as long as it continues to fit comfortably and the mask does not become contaminated, crushed, or splattered with body fluids.

Do not touch the mask after it has been put on. The mask may become contaminated once it is touched. To avoid the necessity for touching the mask, make sure it fits comfortably before entering the patient's room.

When handling a reused mask, hold it by the strings. Be careful that the outside surface does not touch the health care worker's face.

Surgical mask: If HEPA-filter or other biosafety masks are not available, use surgical masks. Surgical masks will not filter out small particles, but they will protect the health care worker from droplets or splashing of body fluids.



Fig. 22. Surgical mask

A surgical mask can be reused by the same health care worker as long as it is not contaminated and not obviously dirty and torn.

Cotton mask: If surgical masks are not available, use cotton masks made from four or five layers of cotton cloth sewn together.

- Use a different colour for each side of the mask. This will help health care workers quickly identify which side should be worn inside.
- The mask should have ties that are long enough to reach behind the head.



Fig. 23. Cotton mask

Cotton masks will not provide protection from breathing in particles, but they will provide protection against splashes and other droplet contact with infectious body fluids. A cotton mask can be reused by the same health care worker as long as it is not contaminated and not obviously dirty and torn.

Head covering: A head covering or cap protects the hair and head against splashes from the patient's vomit, blood, or other body fluids.

Use disposable or cotton caps. If disposable caps are not available, make cotton caps from locally available cotton fabric. Include ties so the cap does not fall off when the health care worker bends over a patient.



Fig. 24. Head covering



Section 4

If cotton caps are not available:

- Use a scarf, bandanna, or large piece of cloth.
- Fold the scarf, bandanna, or cloth and wrap it around the head.

Eyewear: Wear clear eyeglasses or non-fogging goggles to protect the eyes from splashes or spills of infectious body fluids.



Obtain clear eyeglasses from a local eyeglass shop or in the market. Place ties on the ear holders. Tie the eyeglasses around the back of the head so they will not fall off when a health care worker bends over a patient. If available, wear commercial non-fogging goggles instead of eyeglasses.

Fig. 25. Wearing clear eyeglasses or goggles

4.3 Put On Protective Clothing

Make sure the changing room (and the changing area for cleaning and other staff) contains a supply of protective clothing. Section 3.4 describes how to set up a changing room.

1. Before entering the changing room, remove jewelry, wallets and other valuables. Store them safely outside the changing room.

2. Remove street clothes and hang them on a hook. **Put on the scrub suit** or set of old clothes.



Fig. 26. Scrub suit: the first layer of clothing

3. **Enter the changing room.**

4. **Put on rubber boots.**

Put on each boot and tuck the trouser leg inside the boot. If overboots are used, tape the top of the boot to the leg with plastic tape. This will help prevent spills from running inside the boots.



Fig. 27. Putting on boots



5. **Put on the first pair of gloves.**

- Look at your hands for cut or broken skin. If the skin is cut or broken, refrain from direct patient contact.
- Put on one glove at a time. If the scrub suit or set of old clothes has long sleeves, place the edge of each glove *under* the cuff.
- When only one pair of gloves is worn, place the edge of the glove over the cuff or gown.
- If gloves are not available, use plastic bags. Put on one layer now. Attach and close the first layer with tape or elastic bands.



Fig. 28. Putting on the first pair of gloves

6. **Put on the outer gown.**

- Pick up the gown from the inside. This is especially important if the gown is being reused.
- Place arms through the armholes.
- Tie the gown in back. Or, ask another health care worker to tie the gown.



Fig. 29. Putting on the outer gown

7. **Put on the plastic or rubber apron.**



Fig. 30. Putting on a plastic apron

8. **Put on the second pair of gloves.**

- Place the edge of the second pair of gloves over the cuff of the gown.
- If using plastic bags, place the second layer of plastic bags over the first. Close ends of the bags with plastic tape or elastic bands.



Fig. 31. Proper way to put on the second pair of gloves

- Health facility staff who do cleaning, laundering, disinfecting, waste disposal or handling the body should wear thick gloves as the second pair of gloves.
9. **Put on the mask.** Tie it at the back of the neck and towards the top of the head.



Fig. 32. Putting on mask



10. **Put on a head cover.**



Fig. 33. Putting on head cover

11. **Put on the protective eyewear.** Attach the eyeglasses or goggles behind the head with string or cord to prevent the eyewear from falling off when working with patients in the isolation ward.



Fig. 34. Putting on eyewear

Remember! Make sure the mask, head cover and eyewear fit comfortably. Once gloved hands have touched a patient, do not touch the mask, headcover and eyewear.

Plan ahead to bring everything into the isolation area for examining the patient. Once protective clothing has been put on, do not re-enter the general health facility. In an emergency, ask the guard or a health assistant to go and obtain any needed items from other parts of the health facility.

4.4 Take Off Protective Clothing

The steps for removing protective clothing include disinfection with bleach solutions and washing hands with soap and water. How to set up supplies for disinfection is described in Section 3.3. How to prepare the bleach solutions is described in Section 5.1.

Outer gloves and boots are likely to have the most contact with infectious body fluids during patient care.

Before leaving the patient's room:

1. **Disinfect the outer pair of gloves.**
 - Wash the gloved hands in soap and water.
 - Dip the gloved hands in 1:100 bleach solution for 1 minute.
2. **Disinfect the apron.** Spray or wipe it with 1:100 bleach solution.
3. **Disinfect the boots.**

Note: The soles of rubber boots are difficult to clean because they are textured. Disinfect them carefully and make sure to reach all surfaces of the textured soles.

- Use a sprayer containing 1:100 bleach solution to spray boots

OR

- Hold the foot over a pan or basin and ask another health worker to pour 1:100 bleach solution over the boots

OR

- Step into a shallow pan containing 1:100 bleach solution and wipe boots on a bleach-drenched cloth.



Fig. 35. Disinfecting the boots



4. **Remove the outer pair of gloves.**

If two pairs of gloves are worn:

- Pull the edge of the glove back over the gloved hand so that the glove turns inside out as it is being pulled back.
- If gloves will be reused, place the glove in a bucket containing soapy water.



*Fig. 36.
Disinfecting used
gloves in soapy
water for reuse or
disposing of them
in waste bucket*

- If gloves will *not* be reused, discard them in a bucket for disposal of contaminated waste.
- Remove the other glove in the same way.

If only one pair of gloves is worn:

- Do not remove the gloves now.
- Rinse the gloved hands in 1:100 bleach solution for 1 minute before leaving the patient's room.

After disinfecting the boots and removing the outer gloves, go into the changing room.

5. **Remove the apron and outer gown.**

- Put the apron in a laundry container or hang it for reuse (if it will be reused).



Fig. 37. Removing the apron

- Remove the outer gown. Hang it on a hook for reuse. Make sure it is hung inside out. If the gown needs laundering, place it in the laundry container.



Fig. 38. Removing the gown

6. **Disinfect the gloved hands** after contact with apron and outer gown.

- Rinse the gloved hands in 1:100 bleach solution. Then wash them in soap and water.
- Dry the gloved hands with a one-use towel.
- If bleach is not available, wash the gloved hands with soap and water.



Fig. 39. Washing the gloved hands



7. **Remove the eyewear, head cover and mask.**

- If eyewear is heavily soiled, wash the eyeglasses in soapy water and wipe them clean. Store them in a drawer or shelf with the clean supply of eyeglasses.



Fig. 40. Removing the eyewear

- Remove the head cover and, if unsoiled, store it with the cleaned eyewear. If it is soiled, place it in the laundry container or discard it in the bucket for disposal of contaminated waste.



Fig. 41. Removing the head cover

- Remove the mask and hang it on a hook or store it for reuse.
- A HEPA-filter or other biosafety mask can be reused by the same health care worker as long as it is not soiled.



Fig. 42. Removing the mask

If the HEPA-filter or other biosafety mask is soiled, discard it in a bucket for disposal of contaminated waste.

- A locally made cotton mask can be reused as long as it is not obviously dirty and torn.

If it is soiled, place it in the laundry container.

8. **Remove the boots.**

- Place a towel that has been soaked in 1:100 bleach solution on the floor for health facility staff to stand on when removing boots.
- Use a boot remover to take off the rubber boots. Avoid touching the boots with bare or gloved hands.

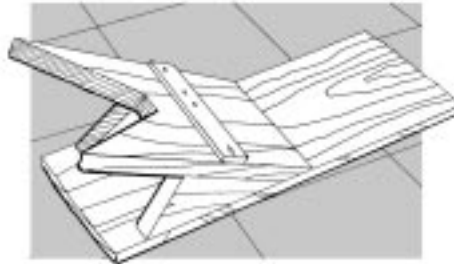

Fig. 43. A boot remover

- Store boots safely until next use. For example, store them in a plastic sack or on a covered shelf.

9. **Remove the inner pair of gloves.**

If gloves will be discarded:

- Remove the first glove with the other gloved hand. Pull the edge of the first glove back over the gloved hand so that the glove turns inside out as it is being pulled back.

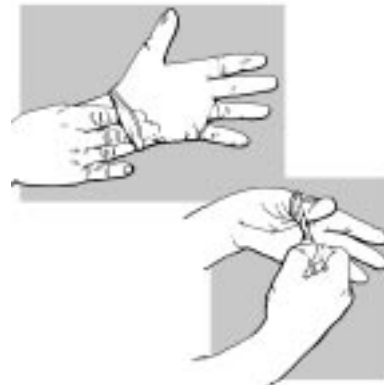

Fig. 44. Removing the inner gloves

- Place the inside-out glove in the palm of the gloved hand.
- Reach inside the glove to a clean area. Pull the glove back over the hand so that only the inside of the glove is exposed and covers the glove held in the palm. Discard the gloves in a bucket for disposal of contaminated waste.
- Wash ungloved hands with soap and water.



Section 4

If gloves will be reused:

- Reach inside the first glove to a clean area. Pull the glove back over the hand so the glove turns inside out as it is pulled back. Place the glove in a bucket of soapy water.
- Remove the second glove in the same way.
- Place the second glove in soapy water.
- Immediately wash ungloved hands with soap and water.

10. **Remove inner layer of clothes** and dress in street clothes.

- If the inner layer is not soiled, store the clothing for reuse.
- If soiled, place the clothing in the laundry container.
- If personal shower facilities are available, shower before dressing in street clothes.
- If skin has contact with soiled material, follow guidelines for accidental exposure in Section 5.13.
- Put on street clothes.

11. **Wash hands with soap and clean water** before leaving the changing room.

Note:

When gloves are in limited supply, use one pair of gloves only.
Modify the order for removing protective clothing as follows:

1. Rinse gloved hands in 1:100 bleach solution upon leaving the patient isolation room.
2. Remove apron and outer gown as described in Section 4.4.
3. Remove the gloves.
4. Wash ungloved hands in soap and water.
5. Remove the inner gown or scrub suit, mask, head cover and eyewear.
6. Wash hands again.



Section 4

Section 5

Disinfect Reusable Supplies and Equipment



This section describes how to:

- Prepare disinfectants.
- Clean and disinfect used gloves before reuse.
- Clean and disinfect used medical instruments and supplies.
- Disinfect patient waste and spills of infectious body fluids.
- Disinfect and discard infectious waste and non-reusable supplies.
- Clean and disinfect protective clothing, boots, and patients' sheets.
- Give first aid for accidental exposures.



Section 5

What to Disinfect: Disinfection kills almost all bacteria, fungi, viruses, and protozoa. It reduces the number of microorganisms to make equipment and surfaces safer for use. When VHF is suspected in the health facility, **all medical, nursing, laboratory and cleaning staff** should disinfect:

- Hands and skin after contact with a VHF patient or infectious body fluids
- Gloved hands after contact with each VHF patient or after contact with infectious body fluids (when gloves cannot be changed)
- Thermometers, stethoscopes and other medical instruments after use with each VHF patient
- Spills of infectious body fluids on the walls and floors
- Patient excreta and containers contaminated by patient excreta
- Reusable supplies such as protective clothing and patient bedding
- Used needles and syringes.

Note: All health facility staff — including cleaning, waste disposal, and laundry staff — who handle, disinfect, or clean VHF-contaminated supplies and equipment should **wear the same protective clothing as health care workers who provide direct patient care**. Wear thick gloves for the second pair of gloves. Follow the steps in Section 4 for putting on and taking off protective clothing.



5.1 Prepare Bleach Solutions

In a central place in the health facility, prepare two solutions of ordinary household bleach. Normally, ordinary household bleach has a 5.0% chlorine concentration.⁷

- 1:10 bleach solution⁸ is a strong solution used to disinfect excreta and bodies. It is also used to prepare the 1:100 bleach solution.
- 1:100 bleach solution⁹ is used to disinfect:
 - Surfaces
 - Medical equipment
 - Patient bedding
 - Reusable protective clothing before it is laundered.

It is also recommended for:

- Rinsing gloves between contact with each patient
- Rinsing gloves, apron, and boots before leaving the patient's room
- Disinfecting contaminated waste for disposal.

Bleach solutions must be prepared daily. They lose their strength after 24 hours. Anytime the odour of chlorine is not present, discard the solution.

Note: 1:10 bleach solution is caustic. Avoid direct contact with skin and eyes. Prepare the bleach solutions in a well-ventilated area.

7 The recommendations in this section assume ordinary bleach solution has a 5% chlorine concentration. Annex 8 contains a table describing quantities to use when preparing chlorine solutions from other chlorine products.

8 This is a solution with 0.5% chlorine concentration.

9 This is a solution with 0.05% chlorine concentration.

To prepare the bleach solutions

1. Gather the necessary supplies:
 - 1 container that holds 10 measures (for example, 10 litres) to make the base 1:10 bleach solution
 - 1 large or several smaller containers (1 for each station) with covers or lids to hold the 1:100 bleach solutions. These containers should be a different colour than the container holding the 1:10 bleach solution, or they should be clearly labelled "1:100."
 - Chlorine bleach (for example, 1 litre of Javel)
 - Clean water
 - A measuring cup or other container (for example, a bottle that holds 1 litre).
2. To prepare the containers for mixing the bleach solutions, determine where to mark the measurements for "9 parts" and "1 part" on each container.

- Pour 9 measures of water into the container. Mark a line where "9 parts" has filled the container. For example, use a nail to scratch a line on a metal or plastic bucket.
- Add 1 measure of water to the first 9 parts. Using a nail, mark a line at the point where the total volume has filled the container.

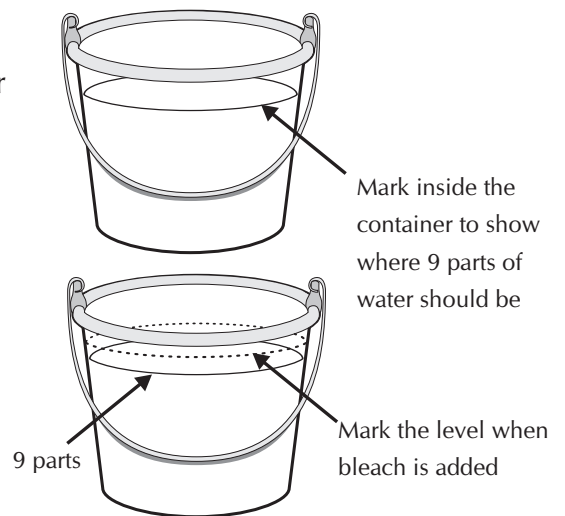

Fig. 45. Marking container for mixing 1:10 bleach solutions

3. To prepare 1:10 bleach solution:
 - Fill the marked container with water up to the mark for 9 parts.
 - Then pour the ordinary household bleach into the container up to the top mark.



Section 5

4. To prepare 1:100 bleach solution:

- Measure and pour 9 parts of water into the large container. Then measure and pour 1 part of 1:10 bleach solution into the water to make 1:100 bleach solution.

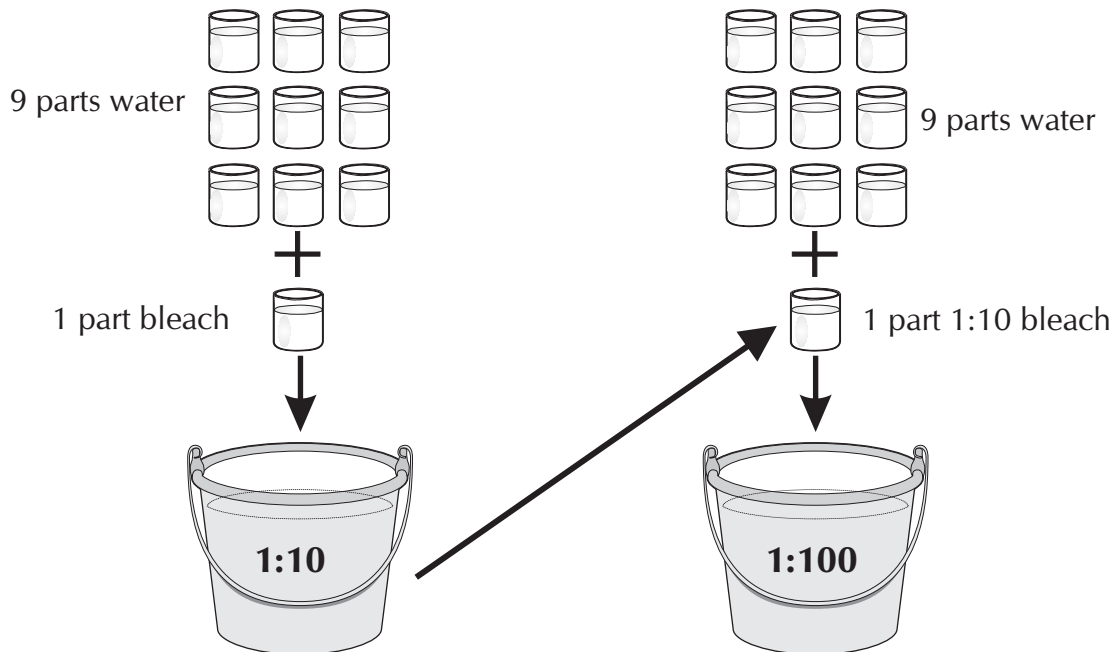

Fig. 46. Preparing bleach solutions

- Distribute a container to each station.
- Fill the container at each station in the isolation area with the 1:100 bleach solution as shown in Section 3.2.
- Place the remaining 1:10 bleach solution in the isolation area to disinfect spills and excreta.
- When there is a large outbreak, make larger quantities of bleach solutions. Prepare the disinfectants daily and distribute them as described in Section 3.
- **Remove the disinfectants everyday or whenever the solutions become cloudy or bloody.** Replace the solution with a fresh supply. Safe disposal of bleach solutions is described in Section 6.1.

- ***If you cannot smell chlorine in the bleach solution, the concentration is no longer strong enough for disinfection.*** Replace the solution with a fresh supply.
- Make a schedule for the cleaning staff so they know when to bring a fresh solution into the isolation area, when to change them, and when to remove them.

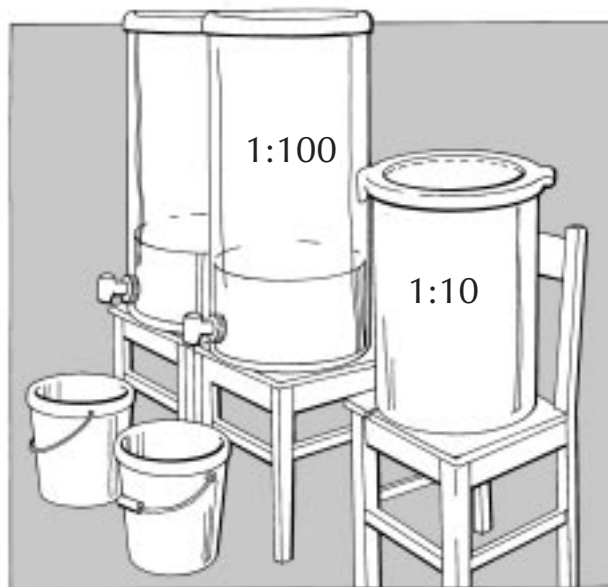

Fig. 47. Preparing bleach solutions during an outbreak



5.2 Prepare Supply of Soapy Water

Prepare a daily supply of soapy water.

1. Gather the necessary supplies:
 - Ordinary cake soap or powdered laundry detergent
 - Supply of clean water
 - Large bucket
 - Container for measuring 1 litre.
2. Cut a small piece of cake soap.

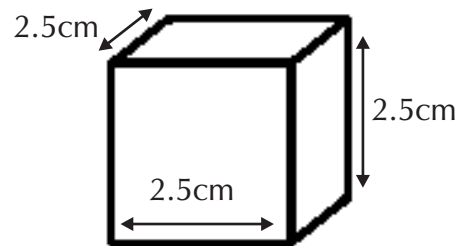

Fig. 48. Small piece of cake soap

3. Mix one piece of cake soap with 4 litres (1 gallon) of water.
4. Make sure the soap is well mixed with the water so there are suds. Pour into pan or bucket for use in cleaning (see Section 3.3).

OR

5. Mix powdered laundry detergent according to instructions on packet.

5.3 Disinfect Gloved Hands between Patients

Health care workers should change outer gloves between each patient.

If there are not enough gloves to allow health care workers to change to a new pair of outer gloves after examining or treating each patient, disinfect gloved hands in 1:100 bleach solution after working with each patient.

To disinfect gloved hands:

1. Place a bucket of 1:100 bleach solution in the isolation room.
2. If gloved hands are visibly soiled, wash them first in soap and water.
3. Dip the gloved hands into the 1:100 bleach solution for 1 minute.
4. Dry the gloved hands with a one-use (or paper) towel, or let the gloved hands air-dry.
5. If a bleach solution is not available, wash gloved hands with soap and water.
6. After several rinses in bleach solution, the gloves may become sticky and will need to be changed.
7. If gloves will be reused, place gloves in a bucket of soapy water. See Section 5.4 for instructions about washing used gloves.

If gloves are not going to be reused, discard them in the container for disposable infectious waste.



5.4 Disinfect Used Gloves before Reuse

Reusing gloves is **not** recommended. If it is necessary to reuse gloves because the supply in the health facility is limited, clean and disinfect them. Also check them for holes.

When cleaning staff handle contaminated supplies, make sure they wear the same protective clothing as health care workers. They should wear thick gloves as the second pair of gloves.

To clean and disinfect gloves for reuse:

1. Take the bucket with soaking gloves to the VHF laundry area. Carefully move the gloves to a bucket with fresh soapy water.
2. Gently rub the gloves to remove visible soiling and cover with water.
3. Soak them overnight.
4. Wearing at least an apron and thick gloves, rinse the gloves in clean water. To check for holes, fill each glove with rinse water. If any water squirts out, there is a hole in the glove. Discard any gloves with holes.
5. Air-dry the remaining gloves.
6. If available, put talcum powder in dry gloves.
7. Return clean gloves to the storage shelf in the entry to the isolation area.



Fig. 49. Checking gloves for holes

5.5 Disinfect Reusable Medical Instruments

In the isolation room, each time health care workers wash their hands between patients, they should also disinfect thermometers and stethoscopes they have used to examine the patient.

To disinfect thermometers and stethoscopes with alcohol:

1. Use rubbing alcohol (70% isopropyl).
2. Place the alcohol in a covered container and put it in the patient's room. Change the alcohol at least once a week.
3. Use a clean cloth or paper towel and dip it in the alcohol solution.
4. Carefully wipe the thermometer with the alcohol solution and hold the cloth around it for 30 seconds. Discard the cloth. Let the thermometer air-dry.
5. Use another clean cloth and dip it in the alcohol solution.
6. Carefully wipe the metal part of the stethoscope and hold the cloth against the surface for 30 seconds. Let it air-dry.
7. Discard the cloth in the laundry container. Discard paper towels in the bucket for waste to be burned.

To disinfect thermometers and stethoscopes with bleach solution:

1. Place a covered container of 1:100 bleach solution in the isolation room. Change the bleach solution each day.
2. Use a clean cloth or paper towel and dip it in the bleach solution. Never dip a soiled cloth back into the bleach solution. Use a cup or dipper to pour the bleach solution on a soiled cloth.
3. Wipe the thermometer with the cloth soaked in bleach solution. Or, soak the thermometer for 10 minutes in the bleach solution. Let the thermometer air-dry.
4. Use a clean cloth or new paper towel and dip it in the bleach solution.
5. Wipe the metal part of the stethoscope with 1:100 bleach solution. Let it air-dry.



Section 5

6. Discard the cloth in the laundry container. Discard paper towels in the bucket for waste to be burned.

How to disinfect and dispose of used needles and syringes is described in Sections 1.4 through 1.6.

5.6 Disinfect Bedpan or Waste Bucket

1. Cover the contents with 1:10 bleach. Empty the bedpan contents directly into the isolated toilet or latrine.
2. Clean the bedpan with soap and water to remove solid waste. Pour into toilet or latrine. Rinse the bedpan in 1:100 bleach solution and return it to patient's room.

If a family member is responsible for carrying out this task, make sure the family member wears protective clothing.

5.7 Disinfect Patient's Utensils

If families will assist with patient care, provide 1:100 bleach solution and soap and water so the family member can wash the patient's eating utensils. After washing the utensils, rinse them in 1:100 bleach solution, and let them air-dry.

5.8 Disinfect Spills of Infectious Body Fluids

Place a bucket containing 1:100 bleach solution in the isolation area.

To disinfect spills of infectious body fluids:

1. Use a cup or dipper to pour bleach solution on spills. Cover the spill completely with 1:100 bleach solution. If the spill is heavy or dense, cover with 1:10 bleach solution. Take care to prevent drops or splashes of the contaminated body fluid from reaching anyone when pouring bleach solution on the spill.



Fig. 50. Disinfecting a spill on the floor

2. Soak the spill for at least 15 minutes.
3. Remove the disinfected blood or spilled material with a cloth soaked with 1:100 bleach solution.
4. Discard any waste in the container for collecting disposable infectious waste or in the isolated latrine or toilet.
5. Wash area as usual with soap and clean water.



To clean the walls or other surfaces:

Surfaces such as tabletops, sinks, walls and floors are not generally involved in disease transmission. However, in a VHF patient's room, if walls are visibly soiled with blood or other body fluids, clean them as follows:¹⁰



Fig. 51. Disinfecting a spill on the wall

1. Use a sprayer or mop to wash the walls with 1:100 bleach solution. Rinse the mop in a fresh supply of 1:100 bleach solution. (If using a sprayer, apply the spray close to the surface to minimize splashing and aerosols.)
2. Wash the wall as usual with soap and clean water to remove visible soil.
3. Discard any waste in container for collecting infectious waste or in the isolated latrine or toilet.

5.9 Disinfect Infectious Waste and Non-Reusable Supplies for Burning

Place a bucket or other container containing 1:100 bleach solution in the patient's room. Use it to collect infectious waste, contaminated items, and non-reusable supplies that will be burned.

How to carry out safe waste disposal is described in Section 6.

10 Favero, MS, and Bond, WW. Sterilization, disinfection, and antisepsis in the hospital. In: Murray PR ed. Manual of Clinical Microbiology. Washinton, D.C.: American Society for Microbiology. pp. 183-200, 1991

5.10 Clean and Disinfect Protective Clothing

Set aside a special part of the laundry or cleaning area for laundry from suspected VHF patients. Make sure health facility staff who handle contaminated laundry wear protective clothing, including thick gloves as the second pair of gloves.

1. Transfer laundry as soon as possible to area set aside for VHF laundry.
2. Carefully move the laundry to a bucket with fresh 1:100 bleach solution.
3. Soak laundry in 1:100 bleach solution for 30 minutes. Be sure that all items are completely soaked.
4. Remove items from the bleach solution and place in soapy water.
5. Soak overnight in soapy water.
6. Scrub thoroughly to remove stains. Rinse and line-dry.
7. Use a needle and thread to repair any holes or torn areas.
8. The clean clothing is now ready for use. It can be ironed although this is not necessary. (It is not necessary to wear protective clothing when ironing cleaned clothing.)



Fig. 52. Transferring laundry to the cleaning area

Items that are very worn out should be discarded or used as cleaning rags.

5.11 Clean and Disinfect Boots

Place a sprayer or pan with 1:100 bleach solution at the exit of the patient's room. Change the pan often. Steps for disinfecting boots are described in Section 4.4.



5.12 Clean and Disinfect Patient's Bedding

For plastic sheeting:

1. If the plastic sheeting becomes soiled during its use with the same patient, remove liquid or solid waste with absorbent towels. Discard them in the container for collecting infectious waste for burning. Then, wash the plastic sheeting with 1:100 bleach solution.
2. Change the plastic sheeting between patients.
3. If the plastic sheeting cannot be changed between patients, wash it with 1:100 bleach solution after each patient.



Fig. 53. Cleaning patient's bedding

For patient's sheets:

1. Remove sheets from bed. Put them in a container (plastic bag or bucket) in the patient's room.
2. Take the container directly to the laundry area.
3. Soak in 1:100 bleach solution for 30 minutes. Be sure all items are completely soaked.
4. Remove items from the bleach solution and place them in soapy water. Soak overnight.
5. Scrub thoroughly to remove stains. Rinse and line-dry.

Mattresses:

If a mattress is heavily soiled, remove it from the isolation area to the outdoors and burn it. Make sure health facility staff wear protective clothing and gloves when touching and carrying the soiled mattress.

If mattresses must be reused:

1. Pour 1:10 bleach solution directly on the mattress. Let the solution soak through completely to the other side.
2. Flood the soiled area with soapy water and rinse with clean water.
3. Let the mattress dry in the sun for several days.
4. Turn the mattress often so it dries on both sides.

5.13 Give First Aid for Accidental Exposures

Accidental needlestick injury: Assume any needlestick injury is a suspected contact for VHF whether or not a break in the skin can be seen. If an accidental needlestick injury occurs, treat the exposure site.

1. Immerse the exposed site in 70% alcohol for 20 to 30 seconds, and wash with soap and clean water.
2. Flush the site in running water for 20 to 30 seconds.
3. If needed, cover with a dressing.
4. Report the incident to a supervisor or the physician-in-charge.

The purpose of notifying the physician-in-charge is:

- To identify what caused the problem
- To take corrective action to solve the problem and prevent accidental transmission
- To provide appropriate care for the possible case of VHF.



Section 5

Remind the health facility staff that accidents do happen even when every precaution to prevent them has been taken. Reassure health facility staff that reporting the accidental exposure will have no negative consequences. Explain that reporting the accidental exposure is essential for protecting themselves, their families, other health workers and patients.

Accidental contact with infectious body fluids: An accidental contact can occur if there is unprotected contact between infectious body fluids and broken skin or the mouth, nose or eye. For example, vomit may run under a glove, a patient might cough blood which runs into the health care worker's eye, or coughed blood may run underneath a health care worker's mask and get into the mouth. Treat any accidental contact as a suspected contact with VHF. As soon as the contact occurs:

1. Flush the area in the most appropriate manner with soap and clean water. If a splash occurs in the eye, flush it with clean water.
2. Leave the isolation area and remove the protective clothing as recommended.
3. Take a shower and put on street clothes.
4. Report the exposure to a supervisor or the physician-in-charge. Complete the necessary forms.

Follow up accidental exposures:

1. Monitor the condition of the health facility staff. Take a measured temperature two times per day.
2. If a fever occurs – temperature is 38.5°C (101°F) or higher – the health facility staff should not do patient care activities. Treat as a suspected case of VHF if the health facility staff's signs and symptoms meet the case definition (Please see page 23 and Annex 4).

Section 6

Dispose of Waste Safely



This section describes how to:

- Dispose of liquid waste and patient excreta in an isolated latrine or toilet.
- Use an incinerator to burn contaminated waste.
- Use a pit to burn contaminated waste.
- Maintain security of the disposal site.



Section 6

Section 6 Dispose of Waste Safely

Direct, unprotected contact during disposal of infectious waste can result in accidental transmission of VHF. For this reason, all contaminated waste produced in the care of the VHF patient must be disposed of safely. All non-reusable items should be destroyed so they cannot be used again. Burning should be carried out at least daily.

6.1 What Needs Disposal

When VHF is suspected, disinfect and dispose of:

- Infectious blood and other body fluids such as urine, faeces, and vomitus
- Disposable needles and syringes and disposable or non-reusable protective clothing
- Treatment materials and dressings
- Non-reusable gloves
- Laboratory supplies and biological samples
- Used disinfectants.

Recommended Disposal Methods: Liquid waste, including patient excreta, can be disposed of in an isolated latrine or toilet set aside for VHF cases. Burning is the recommended method for disposal of other VHF-contaminated waste. A safe and inexpensive disposal system can be made by using an incinerator or a pit for burning.

- A latrine or toilet that joins the patient's isolation room can be used to receive the disinfected bedpan contents from the VHF patient. The latrine or toilet should be isolated. Access should be restricted to health facility staff trained to work in the VHF isolation area. Isolating the patient area is described in Section 3.5.



Section 6

- Incinerators are containers with holes for ventilation to allow air to enter and exit the container. This allows the fire to reach temperatures high enough to completely destroy all biological materials. Use flammable fuel (such as diesel fuel) to speed the burning process and keep the temperatures high.

Incineration is recommended for disposal of:

- Needles and syringes
 - Used treatment materials and dressings
 - Non-reusable protective clothing
 - Laboratory supplies.
- When an incinerator is not available, burn waste in a pit. Use fuel to accelerate the burning and ensure that all waste is completely destroyed.

Use a pit to dispose of:

- Disinfected body fluids such as urine, faeces, and vomitus when no designated latrine or toilet is available.
- Used disinfectants. If it is not possible to dispose of used disinfectants in a latrine or toilet, burn the used disinfectant together with flammable items (disposable gowns or masks, for example). Burning with the flammable items will help keep the temperature of the fire hot enough to boil off the liquids.

Note: All staff who are likely to handle infectious material should know and use VHF Isolation Precautions. Reinforce with all health facility staff the importance of handling infectious waste safely.

6.2 Select Staff to Supervise Waste Disposal and Burning

Select a person with authority who will:

- Oversee all the disposal procedures, including preparation of the incinerator and pit.
- Train and supervise the staff who carry out waste disposal.
- Make a schedule for collecting and burning disposable waste.
- Supervise the collection and burning to make sure it is carried out safely.

6.3 Train and Supervise Staff to Carry Out Waste Disposal

The cleaning staff who do the disposal tasks should understand the purpose of safe disposal, know how to wear protective clothing, and know clearly how to carry out waste disposal safely.

After the cleaning staff is selected:

1. Describe the risks of VHF transmission. Explain that health facility staff who carry out waste disposal should wear protective clothing including a plastic apron and at least two pairs of gloves. Wear thick gloves as the outer pair of gloves.
2. Describe the disposal procedures that cleaning staff will carry out:
 - Bring the containers of infectious waste from the isolation and cleaning areas to the disposal site. Discard the items in the incinerator or burning pit.
 - Pour fuel on the waste in the incinerator or over the pit. Light the fire.



Section 6

- Watch the burning carefully.
 - Move waste frequently as it burns to be sure all items burn completely.
 - If any items remain, repeat the burning procedures.
 - When burning ends, remove ashes from incinerator and bury them in a pit.
 - When the pit is nearly full of ash, cover it with soil. Waste should not be near the surface. It should take about half a meter of soil to close the pit.
 - Build a new pit when the old pit is full.
3. Show the cleaning staff how to:
- Wear protective clothing with one pair of thick or kitchen gloves over an inner pair of thin gloves.
 - Collect and carry the buckets of infectious waste from the isolation area to the disposal area.
 - Collect and dispose of liquid waste in an isolated latrine or toilet. If no latrine or toilet can be isolated, burn the liquid waste in the pit.
 - Place the infectious waste in the incinerator or pit for burning.
 - Douse the infectious waste with fuel (such as diesel fuel) and burn it.
 - Watch the burning from beginning to end to make sure all the waste items are burned before letting the fire go out.

6.4 Select Site for Burning VHF-Contaminated Waste

Select a burning site on the health facility grounds. It should be located away from the normal traffic flow. To help maintain security and prevent unauthorized access, the site should not be in public view or in an area where it will attract a crowd. The ash from the burning is not infectious, and it can be placed in a pit and buried.

6.5 Use Incinerator to Burn VHF-Contaminated Waste

If an incinerator is available on the health facility's grounds, and it can be set aside for VHF-contaminated waste, use diesel fuel during burning to make sure all the waste is completely destroyed.

If no incinerator is available, make one from an empty 220-litre (55-gallon) oil or fuel drum.

1. Gather the following supplies:

- 220-litre (55-gallon) drum
- Chisel or other sharp instrument (an awl, for example) to cut metal
- Hammer
- 0.5 mm or 1.0 mm metal wire
- The piece cut out from the top of the drum or a wire screen or grill about 1 cm thick
- Metal rods or bars 4 cm or 5 cm x 2 cm.



Fig. 54. A 220-litre drum

2. Cut open the drum by removing the top in one piece. Save the top cutaway piece.
3. Hammer the edges of the drum so they are not sharp.
4. Cut three half-moon openings just below the open end of the drum.



Section 6

5. Turn the drum and put the open end on the ground. The bottom of the drum is now the top.
6. Cut four holes on the sides of the drum. These holes are for threading the two metal rods through the drum so that they form an X or cross inside the drum. The crossed rods will support a platform used for holding the infectious material to be burned.

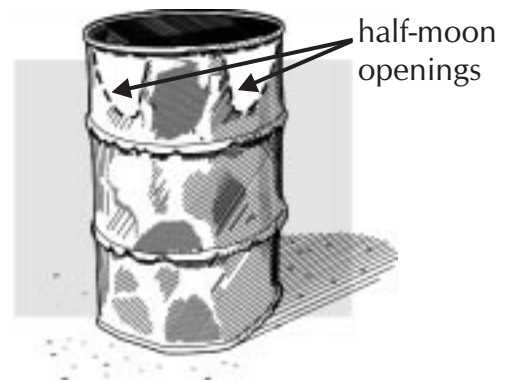

Fig. 55. Turn the drum and put the open end on the ground

To cut the holes for the rods:
Just above the half moon openings (about one-third of the height of the drum), cut a hole the same size as the diameter of the metal rod. Directly across from the hole, on the other side of the drum, cut a second hole so that a rod can be threaded through the two holes. Repeat the steps and make two more holes on opposite sides of the drum. Thread each rod through the holes to make an X or cross.

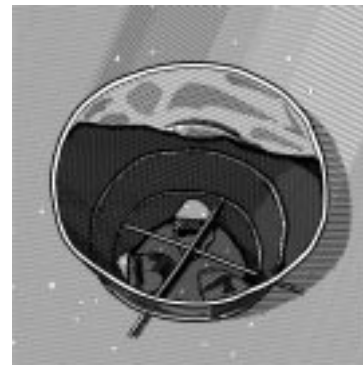

Fig. 56. Place the rods across the drum

7. Use the top piece of the drum that was cut away in step 2 to make the platform. It will rest on the crossed rods and hold the infectious material to be burned. The platform also lets air come in from the bottom of the drum so that the temperatures at the bottom are high enough to completely burn the material.

To make the platform: Punch holes in the cutaway top piece of the drum. Make enough holes so it looks like a sieve. Save the platform to use in Step 10.

8. Pierce a series of holes (about 0.5 cm in diameter) on the sides of the drum and above the crossed rods to improve the draw of the fire.

9. Cut away half of the bottom of the drum (which is now the top of the incinerator and is facing up). Attach the wire loops to the cutaway half. Attach another loop for a handle to open the trap door. Items to be burned will be put in the incinerator through this door.
10. Place the platform you made in Step 7 inside the drum on top of the rods. Replace the incinerator if, as a result of the heat, large holes appear in the sides.

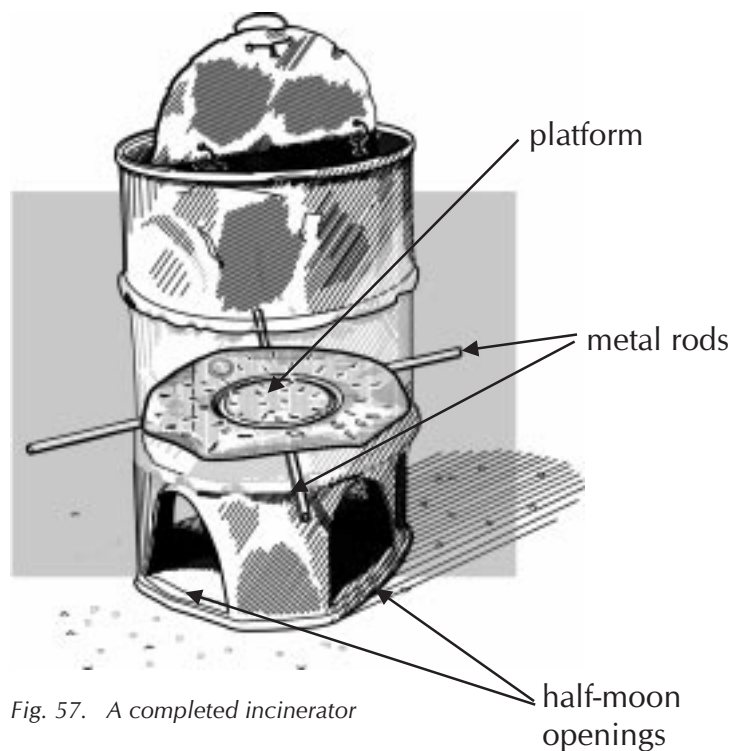

Fig. 57. A completed incinerator

To burn waste in the incinerator:

1. Place the infectious waste inside the top of the drum. Soak the waste in one litre of fuel.
2. Light the fire carefully.
3. Watch the fire and frequently mix the waste with the metal bars to be sure all of the waste is burned.
4. When the fire has gone out, empty the ashes into a pit.



6.6 Use Pit to Burn VHF-Contaminated Waste

If an incinerator is not available, make a pit for burning infectious waste.

1. Locate the pit far from the normal traffic flow of the health facility.
2. Dig a pit that is 2 meters deep. It should be wide enough to hold all contaminated waste material, including discarded liquids.

To burn waste in the pit:

1. Place the disinfected waste in the pit, including disinfected liquid waste that was not discarded in an isolated latrine or toilet.
2. Pour fuel (such as diesel fuel) on the waste. Carefully start the fire.
3. Watch the burning to make sure all the waste is completely destroyed.
4. When the fire has gone out, if any waste remains, repeat the steps for burning.
5. When no waste remains and the fire goes out, cover the ashes with soil.
6. Before the pit becomes completely full, cover it with soil so that no pieces of waste are visible or are too close to the surface. The pit should be closed when it can be covered by one-half meter of soil.
7. Dig a new pit.

6.7 Take Steps to Ensure Security of Burning Site

Maintain the security of the burning site to limit access to contaminated items. This is important since children could be tempted to pick up the interesting waste materials and use them for toys. Dogs, cats, and other animals may carry items beyond the health facility boundaries.

Tie a rope around the disposal area. Hang warning signs from the rope that tell people this is a dangerous area. Also station a guard to prevent unauthorized access to the disposal area.

Never leave unburned waste in the incinerator or the pit.



Section 6

Section 7

Use Safe Burial Practices

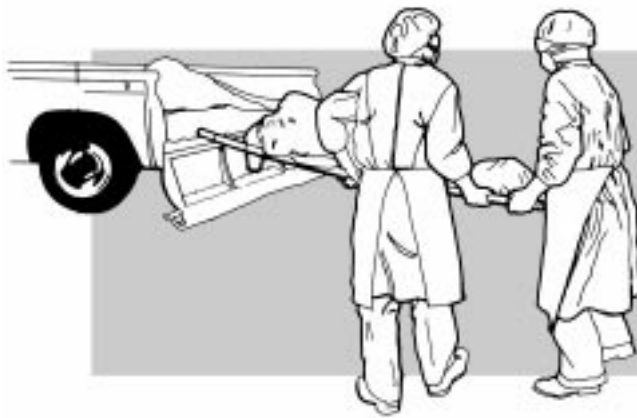

This section describes how to:

- Prepare bodies of deceased VHF patients.
- Transport the body safely to the burial site.
- Disinfect the vehicle after transporting bodies.



Section 7

Section 7 Use Safe Burial Practices

There is risk of transmission in the health facility when a VHF patient dies because the bodies and body fluids of deceased VHF patients remain contagious for several days after death. Family and community members are also at risk if burial practices involve touching and washing the body.

7.1 Prepare the Body Safely

Burial should take place as soon as possible after the body is prepared in the health facility. Health facility staff should:

- Prepare the body safely.
- Be aware of the family's cultural practices and religious beliefs. Help the family understand why some practices cannot be done because they place the family or others at risk for exposure.
- Counsel the family about why special steps need to be taken to protect the family and community from illness. If the body is prepared without giving information and support to the family and the community, they may not want to bring other family members to the health facility in the future. They may think that if the patient dies, the body will not be returned to them.
- Identify a family member who has influence with the rest of the family and who can make sure family members avoid dangerous practices such as washing or touching the body.

To prepare the body in the health facility:

1. Wear protective clothing as recommended for staff in the patient isolation area. Use thick rubber gloves as the second pair (or outer layer) of gloves.
2. Spray the body and the area around it with 1:10 bleach solution.
3. Place the body in a "body bag" (mortuary sack) and close it securely. Spray the body bag with 1:10 bleach solution.



Section 7

4. If body bags are not available, wrap the body in two thickness of cotton cloth and soak with 1:10 bleach solution. Then wrap the body in plastic sheeting. Seal the wrapping with plastic tape. Spray the body bag as in Step 3. Place the body in a coffin if one is available.
5. Transport the body to the burial site as soon as possible. Assign a health officer or health facility staff person to accompany the body to ensure that the safety precautions remain secure during the journey.

7.2 Transport the Body Safely

VHF Isolation Precautions should remain in force when the body is being transported to the burial site.

1. Plan to take the shortest route possible for security purposes and to limit any possibility of disease transmission through accidental contact.
2. Any health facility staff who must touch or carry the body during transport should wear the same protective clothing as is worn in the isolation area. **Note: *The driver does not need to wear protective clothing if there is no contact with the body.***
3. Take a closed container or sprayer with 1:10 bleach solution in the event of any accidental contact with the body or infectious body fluids. Also use it to clean up spills in the transport vehicle.

7.3 Prepare Burial Site

1. The grave should be at least 2 meters deep.
2. Explain to the family that viewing the body is not possible. Help them to understand the reason for limiting the burial ceremony to family only.

7.4 Disinfect the Vehicle after Transporting the Body

1. The staff person who disinfects the vehicle must wear protective clothing.
2. Rinse the interior of the vehicle where the body was carried with 1:10 bleach solution.
3. Let it soak for 10 minutes.
4. Rinse well with clean water and let the vehicle air-dry. Be sure to rinse well because the solution is corrosive to the vehicle.



Fig. 58. Disinfecting the vehicle after transporting the body



Section 7

Section 8

Mobilize Community Resources and Conduct Community Education



This section describes how to:

- Organize community resources to develop and provide information about prevention and control of VHF in the community.
- Identify key messages and communication channels.
- Evaluate communication activities and take action to improve them as needed.



Section 8

Section 8

Mobilize Community Resources and Conduct Community Education

When VHF is suspected:

- Make sure that the community knows about the VHF outbreak and how it is transmitted.
- Involve the community in identifying the source of the epidemic and controlling it.
- Reduce fear and rumours in the population.

To develop community education in an urgent situation:

- Describe the extent of the current health problem.
- Identify and mobilize key community members who will plan and lead the education efforts.
- Describe the target population and develop health messages.
- Plan and conduct activities to communicate messages.
- Conduct ongoing evaluation of the activities and make improvements as needed.



8.1 Identify Key Community Resources

Identify key community organizations who already know the community and have access to it. Describe their expertise and available resources that could be useful in responding to the outbreak. Consider organizations such as:

- Local governments
- Local non-governmental organizations (NGOs)
- Religious groups (missions, churches, mosques, temples)
- Businesses
- Schools
- Sports clubs and other recreational clubs
- Service organizations
- Volunteer organizations and community service groups.

For each organization, gather and record information about:

- The organization's expertise
- The representative or leader to be contacted
- Available human resources
- Available material resources (such as vehicles, office supplies, and communication equipment).

Record the information on a chart such as the one below. Use it for planning and refer to it when VHF cases occur.

Organization or Group	Expertise	Representative or Leader and Locating Information	Human Resources	Available Equipment	Contacted?	Tasks Assigned
Red Cross	Emergency response; Disaster relief	Amadu Barrie House next to hotel	35 trained volunteers	2 pickup trucks		
Catholic Mission of St. Francis	Teaching Child care	Sister Frances Use short-wave radio at the Catholic Mission	6 sisters 4 novices 165 students residing	1 Land Cruiser 1 storage room 1 photocopy machine 1 short-wave radio		
Merchants Association	Marketing & community relations	Kira Talitha General store on main road	12 members well known in community 41 delivery workers with knowledge of customers' residence	Wagon Supplies of fabric, plastic cloth, buckets, household bleach		
Farmers Cooperative Organization	Economic development	Daoudou Maliki Government Centre Building Telephone: 21246	2 workers fluent in language of rural population	1 short-wave radio 1 car office supplies		



8.2 Meet with Community Leaders and Assess the Current Situation

Invite representatives from each organization to a meeting.

Explain that the goal is to develop a Mobilization Committee that will help halt an outbreak. Together with the VHF Coordinator and health facility staff, the Mobilization Committee will:

- Plan and describe how communication will take place between the Mobilization Committee and the VHF Coordinator. The purpose is to keep the health staff informed about the outbreak status in the community.
- Make sure the community leaders understand:
 - The signs and symptoms of a VHF.
 - How the disease is spread.
 - Personal precautions to use to prevent contact with infectious material and body fluids.
 - The person to notify when a VHF is suspected (for example, station a Red Cross volunteer at the health facility to take reports from community members about unexplained deaths or suspected VHF cases).
 - The importance of handwashing, decontamination of surfaces, careful laundering of clothes, bedding, and other home infection control measures such as trying to keep the sick person in a separate corner of the house.
 - Careful decontamination of the bedding and room where the patient has died.
 - The need for limited contact between the sick person and other family and community members.
 - The need to follow up family or community members who have had contact with the sick person. The duration of the follow up will vary according to the incubation period for the VHF.

- When to send a sick person to the hospital. The VHF Coordinator, community liaison person, or Red Cross volunteer can facilitate this move if the community has been adequately prepared. For example, they can assist in transporting the patient safely to the health facility, help disinfect the area where the patient was cared for at home.
- How to care for VHF patients at home before they have been diagnosed and also after they have been released from the health facility.
- What is expected of families when the patient is in the hospital.
- Why burial practices may need to be changed during the outbreak.
- Deliver health messages using a variety of communication methods that will reach as many people as possible in the community.
- Conduct community surveillance including reporting deaths, conducting case finding activities and planning case follow-up.



Fig. 59. Meeting with community leaders



8.3 Describe the Target Population

To prepare a complete description of the target population, gather and present information about:

- Maps of the town
- The size of the population
- Major ethnic groups in the town
- Locations of any special populations such as refugees or squatter settlements where the risk of disease transmission may be particularly high
- How many people may be affected by the outbreak
- The populations at greatest risk.

Ask the members of the Mobilization Committee for any additional information they might have about the target population. For example, they may know about nearby villages and recent travel by the local population to other areas.

8.4 Describe Problems Contributing to Transmission Risk

Identify the likely transmission risks for this community.

For example, does the community know how disease is transmitted and how it can be prevented? Is it customary to visit the sick in their homes? During mourning, are individuals expected to lay hands on the body or touch the body to show their grief? Are there new skills to teach? Is bleach available?

8.5 Identify Changes or Actions Required

Specify the behaviour changes and actions that are required to solve the problems. For example, if traditional burial practices involve touching or washing the body, the community will need to adapt burial practices.

8.6 Identify Barriers to Carrying Out Recommended Changes or Actions

Talk with members of the Mobilization Committee about what could prevent individuals from doing the recommended changes or actions. Discuss, for example, if individuals:

- Know about the relevant VHF precautions and how to follow them?
- Have the skills to do the recommended changes or actions?
- Have the correct resources to carry out the recommended changes or actions?
- Understand that some caretaking and burial practices must change during the outbreak even though they involve traditional beliefs or cultural practices?

8.7 Develop Specific Messages

Review the information collected by the Mobilization Committee. Select messages that match the specific risks for transmission of VHF. Consider how to solve the obstacles that might prevent individuals from taking the recommended precautions.

For example, the custom in the community may be to visit the sick when they are at home. Plan a message about limiting visitors. Also include information about how diseases are transmitted. This will help the community understand why they must change their customary practice.

After selecting the messages, decide if some activities should take place before others.

For example, give basic information about VHF and its transmission before telling the community about not touching the body of a relative who has died.

In addition, the community may have heard rumours that everyone in the hospital is dying. To reduce fear and rumours, give information as soon as possible about VHF transmission. Discuss the precautions being taken in the hospital to protect the patients, the health facility staff, and the community.



8.8 Select Activities for Communicating Messages

List all available methods of communicating with the community. More than one method should be used to reach the maximum population with the necessary information. For instance, consider:

- Existing communication channels in the community (church, mosque, temples and other religious networks; traditional healers, personal communication)
- Door-to-door campaigns
- Radio messages
- Short-wave radio to reach outlying areas
- Banners and posters.

Contact the person responsible for each communication method. Ask for their support and availability.

8.9 Assign Tasks and Carry Out Activities

Look at the list of community resources prepared in Section 8.1. Determine who should undertake which activity. For example:

- Religious leaders will make announcements in their services. They can also prepare messages to deliver to small groups and in personal communications.
- The Red Cross will be trained to evacuate the bodies and safely perform burials.
- The Red Cross volunteers and student volunteers will be trained by a member of the health facility staff skilled in VHF Isolation Precautions. A training schedule will be set up and the Mobilization Committee will work out the information needed.
- The governor or village chief can make public announcements with a loudspeaker to tell people to stay calm, to listen to the information, and to attend information sessions.
- Student clubs will make banners to put across the road to give a specific message, design leaflets, pass out leaflets, and go door to door and answer questions.

Elicit ideas from the Mobilization Committee about possible problems and creative solutions. Describe the problems that have occurred in previous outbreaks or that might occur in a future outbreak. Explain that meetings with the group will continue throughout the outbreak and new problems will be discussed as they arise.

If funding and human resources are limited, set priorities. Select specific activities that will make the most impact. Work with the Mobilization Committee to coordinate and communicate with all the resources in the community. There may be ways to accomplish all the activities if groups can be mobilized and understand the need.

Use the community information sheet to organize the specific tasks and assign organizations to do them.

8.10 Evaluate Activities

Evaluation of the community education efforts should be ongoing. Keep records of activities accomplished, any problems, and their solutions. Use the evaluation results to make improvements. When problems occur, find out why and solve them. Develop new solutions to identified problems and implement these solutions.

For example, in the 1995 Ebola haemorrhagic fever outbreak in Kikwit, community education was a key element in halting the epidemic. However, no one predicted that survivors would not be accepted when they returned into the community. Community members believed survivors still carried the disease. A new education activity had to be developed so that the survivors and surviving children would not be abandoned.



8.11 Obtain Community Feedback

The Mobilization Committee should identify a representative from the community or from each area of the community (for example, a representative from each neighbourhood or *quartier*) to attend community meetings and obtain feedback from the community. Explain to the community the purpose of the Mobilization Committee. Describe the activities that have been planned or that are already being done. Reinforce the critical role of the community representatives in providing information from the Mobilization Committee to their own communities. Community representatives are also important sources of information about possible transmission risks and prevention activities.

Be alert to feedback from the community that can affect the outcome of the community education efforts. For example, are there areas where health messages do not reach community members?

8.12 Meet Regularly with the Mobilization Committee

Set up regular meetings with the Mobilization Committee. Keep them well informed of what is happening. Encourage and support them to help continue enthusiasm for the efforts. Provide new messages and information they need. Work together to identify new problems and plan solutions.

Section 9

Make Advance Preparations to Use VHF Isolation Precautions



This section describes how to:

- Identify health facility staff person to coordinate VHF activities.
- Assess current readiness for VHF Isolation Precautions.
- Identify and train key staff who will work with VHF cases.
- Plan for community mobilization.
- Assess current supplies and obtain what is needed for VHF Isolation Precautions.
- Use substitutions when supplies are limited or not available.



Section 9

Section 9

Make Advance Preparations to Use VHF Isolation Precautions

When a VHF case is suspected, VHF Isolation Precautions must begin immediately. All efforts must be focused on meeting patients' needs. There is no time to give initial training in VHF Isolation Precautions.

Being prepared for an emergency can ultimately save lives. Health care workers will know how to use VHF Isolation Precautions, and adequate supplies will already be available. Disease prevention in the health facility setting will be more effective.

This section describes how to prepare for VHF Isolation Precautions.

9.1 Identify a VHF Coordinator to Oversee Preparations

Someone in the health facility may already serve as a coordinator for emergency situations. This person can also serve as the VHF Coordinator. If the emergency coordinator cannot assume the VHF activities, select a staff person with authority who can serve as VHF Coordinator. Discuss the tasks the coordinator will need to do for VHF activities:

- Oversee all the preparations for VHF Isolation Precautions.
- Serve as the focal point for information and leadership when a VHF case is suspected.
- Inform all health facility staff about VHF and the risks associated with them.
- Organize training in VHF Isolation Precautions for medical, nursing, and laboratory staff who will work directly with VHF patients or infectious body fluids.
- Assign responsibility to medical, laboratory, and cleaning staff for ensuring that all the necessary precautions, treatment protocols and cleanup procedures are carried out within their areas.



- Hire or reassign and train additional cleaning staff for work with disinfection of waste, clothing, and equipment.
- Make sure that teams are trained to prepare and transport bodies for burial.

9.2 Assess Current Readiness for VHF Isolation Precautions

Be prepared to use VHF Isolation Precautions by identifying problems and actions to solve them. Make sure relevant staff know how to suspect a VHF, especially those who:

- See patients when they arrive at the health facility and decide where they are next seen
- Work in the outpatient department
- Work in the emergency room.

9.2.1 Monitor Routine Handwashing Practices

Routine handwashing practices should be part of the minimum level of Standard Precautions used with all patients in the health facility.

To reinforce consistent handwashing practices, regularly monitor the practices and improve them as needed. For example:

- Has handwashing been identified as a routine practice in the health facility?
- Do all staff wash their hands after contact with each patient, especially new patients with fever?
- Are there reliable supplies of soap and running water or buckets with clean water available in areas where health workers should use them?
- Are posters reminding health workers to wash their hands placed in areas where health workers can see them?

9.2.2 Assess Readiness for Identifying Suspected VHF Cases

Assess the need for training your health staff to suspect a VHF. For example:

- Do health care workers know the case definition for identifying VHF cases that have occurred in your area?
- Do health care workers know the procedure for informing the emergency or VHF Coordinator when a VHF is suspected?
- Do health care workers in the relevant areas know the level of Standard Precautions identified for the health facility? Do they use them all the time to prevent health facility transmission of VHFs and other contagious diseases such as HIV and hepatitis B?

9.2.3 Assess Readiness for Setting Up a VHF Isolation Area

- Has an area been selected for VHF isolation that meets the criteria described in Section 3.1?
- Has a map been drawn showing where to locate the changing room, the patient room, the changing room for the cleaning staff, and a changing room for family members (if needed)?

A map that is prepared in advance can be used as a reference for setting up a VHF isolation area in an urgent situation.

9.2.4 Assess Readiness of Medical, Laboratory, and Cleaning Staff

Key staff should be identified and informed about what will be expected of them when a VHF case is suspected. For example:

- Is there a family liaison officer who will:
 - Provide information and help families to care for the patient
 - Help families find a place near the hospital where cooking, sleeping, and sanitary facilities are available
 - Talk with family members about their concerns?



- Have the health care workers who will have access to the isolation area if a VHF case is suspected been identified? While all health facility staff should know and use Standard Precautions consistently, identify the health care workers who must also know how and when to use VHF Isolation Precautions.
- Have laboratory staff been designated to work with VHF samples? Laboratory staff are at particular risk of disease transmission because they handle biological samples. They do not see the patients and cannot know if the sample is infected with a dangerous disease. When a VHF case occurs, limit work on VHF samples to one laboratory staff person who will do all testing of body fluids from VHF patients. Make sure the designated person knows when and how to use protective clothing and safely disinfect spills and waste.
- Have cleaning staff been selected and trained to use VHF Isolation Precautions? Cleaning staff have close contact with infectious spills and equipment. They are at high risk of transmission if VHF Isolation Precautions are not used. Select the cleaning staff who will be responsible for cleaning in VHF isolation areas, laundry areas, and the body preparation area.
- Have body disposal teams been identified and trained to use VHF Isolation Precautions? The health facility staff or Red Cross volunteers who prepare corpses before families claim them are at risk for VHF. The VHF patient is still contagious for several days after death.

The VHF Coordinator should also meet with each group to explain the risk of health facility transmission and the training schedules and to answer any questions they have.

9.3 Train Health Facility Staff in VHF Isolation Precautions

Learning to use a new skill takes time and practice. Health facility staff who do not know how to use VHF Isolation Precautions will need information about the new tasks, see them demonstrated and practice doing them. Staff who are not familiar with protective clothing should practice putting them on and working in them before a VHF case presents.

Include information about VHFs and using VHF Isolation Precautions during in-service training.¹¹ Discuss topics such as:

General information about VHFs:

- A VHF can be caused by several different viruses, which are transmitted to humans by animals or arthropods.
- Each virus causes a different disease, but all attack the small blood vessels that carry blood through the body.
- The virus is usually in all organs and can cause bleeding from the nose, mouth, and intestine, as well as under the skin.
- Common presenting complaints are fever, body aches, weakness persisting after rehydration, diarrhoea, muscle pain and back pain.
- Clinical examination may reveal only conjunctival injection (red eyes), mild hypotension (low blood pressure), flushing, and haemorrhages.
- The course of VHF leads to shock, generalized mucous membrane bleeding, reduced sensitivity to pain, and signs involving the nervous system.
- Examples of VHFs include:
 - Africa:** Lassa fever, Rift Valley fever, Marburg and Ebola haemorrhagic fevers, Crimean-Congo haemorrhagic fever, and yellow fever.
 - South America:** Argentine haemorrhagic fever, Bolivian haemorrhagic fever, Venezuelan haemorrhagic fever, haemorrhagic fever with renal syndrome (rare), yellow fever, and dengue haemorrhagic fever.
 - Asia:** Haemorrhagic fever with renal syndrome and dengue haemorrhagic fever.¹²

11 Annex 14 contains a suggested agenda for training during in-service meetings. It can be adapted by individual health facilities.

12 See Annex 2 for more information about VHFs reported in your area.



VHF Transmission Risk in the Health Facility:

Give information about VHF, its transmission, and previous outbreaks in the area listed in the Introduction and Section 2 of this manual. Explain that:

- The virus is present in the patient's body fluids.
- It is transmitted through unprotected contact between an infectious patient or their body fluids and a non-infected person.
- While VHF is not a common diagnosis, it is a dangerous disease and poses significant risks in the health care setting.

VHF Isolation Precautions:

When a VHF case is suspected, the health facility will immediately take steps to limit its transmission. These include steps to:

- Create an isolation room for VHF patients.
- Limit contact with VHF patients to a small number of specially trained staff and, in some areas, a family member who has received information and training in VHF Isolation Precautions.
- Limit the use of invasive procedures as much as possible in treatment of VHF patients.
- Use protective clothing for all staff who have contact with VHF patients or their body fluids.
- Use safe disinfection and waste-disposal methods.

Procedures for Accidental Exposures:

Provide information about how to respond when accidental exposures occur. These procedures are detailed in Section 5.13 of this manual.

9.4 Plan for Community Mobilization

Section 8 describes how to mobilize the community in an urgent situation. However, community mobilization will be easier and occur quickly if it is planned in advance.

Now is the best time to establish a Mobilization Committee. The following steps can be done in advance.

- Identify key community resources.
 - Identify key organizations and record them on the Community Information Sheet (page 105).
 - Identify the representative or leader for each organization.
 - Contact the representative or leader for an initial meeting.

- Meet with identified community leaders.
 - Give information and educate them on VHF's.
 - Explain the purpose for a Mobilization Committee.
 - Discuss and clarify each organization's expertise.
 - Discuss and clarify the human resources available from each organization.
 - Discuss and clarify equipment available from each organization.
 - Establish methods for communicating between the Mobilization Committee and the VHF Coordinator.
 - Record the relevant information on the Community Information Sheet.

- Annually update the information on the Community Information Sheet.

Then, when a VHF case is suspected, the committee can meet and take action to mobilize resources and carry out community education.



9.5 Assess Current Supplies and Equipment

Use the checklist at the end of this section to assess which supplies are already available in the health facility. If these supplies are available, can they be set aside for use when VHF Isolation Precautions are needed? If they are not available, could they be borrowed from another service if an outbreak occurred?

If the supply is limited or unavailable, identify practical, low-cost substitute items. When an item or equipment is not available, consider what could be used in its place that will serve the same function. Obtain the substitute item now. Set it aside for use when VHF Isolation Precautions are needed.

For example, assess the present system for waste disposal. Find out what is needed to carry out safe waste disposal when a VHF case is suspected. Ask health facility staff to prepare an incinerator (if none is available) so it is ready in advance. Let health facility staff practice using it before cases occur.

The checklist that starts on the next page lists the necessary items and recommended quantities. Use it to assess whether an item is available. Also list what needs to be done to be prepared for VHF Isolation Precautions.

9.6 Periodically Reassess Supplies

Periodically, for example, every 4 months, make sure the supplies are dry, clean, and ready to be used.

VHF Isolation Precautions Supplies: Standard Precautions
 Recommendations for handwashing and safe disposal of sharps*

Recommended Item	Recommended Amount	Amount Available	Amount to Obtain	Local Adaptations	Tick if Item is Ready for Use
Source of clean water	prepared as needed				
Container for daily supply of water for handwashing (if running water is not available)	1 or 2 large containers				
Ladle	several				
Bucket or pan for use with handwashing	1 for each location in the health facility where handwashing is required				
Pieces of soap	several bars cut in pieces				
Soap dishes	1 for each handwashing station				
One-use towels	1 roll per health worker per week				
Sharps containers	1 for each location where sharp instruments are used				
Pans with soapy water to collect needles and syringes to be cleaned and disinfected for reuse	1 for each location where sharp instruments are used				
Pans with full-strength bleach	1 for cleaning area				
Supply of clean water for rinsing needles and syringes	1 - 5 litres				
Clean and disinfected jar for storing disinfected needles and syringes	1 for each patient isolation area				

* This is a recommended minimum level of Standard Precautions for use with all patients regardless of their infectious status.

VHF Isolation Precautions Supplies: Patient Isolation

Recommended Item	Recommended Amount	Amount Available	Amount to Obtain	Local Adaptations	Tick if Item is Ready for Use
Bed	1 per patient				
Mattress or sleeping mat	1 per patient				
Plastic sheet to cover mattress	1 per bed				
Bedding: bottom sheet and blanket	1 each per patient				
Thermometer	1 per patient isolation area (1 per patient if available)				
Stethoscope	1 per patient isolation area				
Blood pressure cuff	1 per patient isolation area				
Covered container for alcohol or bleach solution used to disinfect thermometer and stethoscope after use with each patient	1 per patient isolation area				
Sharps container or plastic pan with bleach solution in it for disposal of used needles and syringes	1 per patient isolation area				
Bedside table or shelf	1 per patient				
Large wall clock with a second hand	1 per patient isolation room				

VHF Isolation Precautions Supplies: Patient Isolation

Recommended Item	Recommended Amount	Amount Available	Amount to Obtain	Local Adaptations	Tick if Item is Ready for Use
One-use towels	1 roll per patient per week or stay				
Bed pan	1 per patient				
Screens (or sheets hung from ropes or lines) placed between VHF patients' beds	enough length to go around isolation area				
Signs saying "Isolation Area: No Access"	10				
Poster describing Isolation Precautions	1				

VHF Isolation Precautions Supplies: Protective Clothing*

Recommended Item	Recommended Amount	Amount Available	Amount to Obtain	Local Adaptations	Tick if Item is Ready for Use
Scrub suits	1 - 2 reusable scrub suits per health staff				
Surgical gowns	3 reusable gowns per health staff 4 disposable gowns per health staff per week				
Plastic aprons	1 reusable apron for each health staff who needs one 3 disposable aprons per health staff per week				
Thin gloves	3 dozen disposable pairs per health staff per week				
Thick or heavy-duty kitchen gloves	2 pairs per health staff				
HEPA-filter or other bio-safety mask	1 - 2 per health staff who needs one				
Cotton mask	3 - 4 per health staff				
Rubber boots	1 pair per health staff				
Headcovering	1 - 2 per health staff who needs one				
Eyewear	1 pair of goggles or clear spectacles per health staff in isolation area				
Shelf or cabinet with lock	1 outside the changing room				

VHF Isolation Precautions Supplies: Protective Clothing*

Recommended Item	Recommended Amount	Amount Available	Amount to Obtain	Local Adaptations	Tick if Item is Ready for Use
Covered shelf for storing disinfected boots	1 outside the changing room				
Hooks, nails or hangers for hanging reusable gowns and scrub suits	1 for each health staff				
Boot remover	1 per changing room				
Rolls of plastic tape	1 per changing room				
Extra supply of clean protective clothing (for patient isolation area)	1 - 3 sets (depending on staffing)				
Extra supply of clean protective clothing (for the changing room)	1 - 3 sets				

* All health facility staff – including cleaning, waste disposal, and laundry staff – who handle, disinfect or clean VHF-contaminated supplies and equipment should **wear the same protective clothing as health care workers who provide direct patient care.**

VHF Isolation Precautions Supplies: Disinfection

Recommended Item	Recommended Amount	Amount Available	Amount to Obtain	Local Adaptations	Tick if Item is Ready for Use
Supplies for preparing disinfectants					
Plastic bucket with lid or cover for preparing 1:10 bleach solution	1				
Containers for preparing 1:100 bleach solution	1 large container or several small ones				
Measuring cup	1 with measurements marked on it				
Bleach	1 litre bleach yields 100 litres of 1:100 bleach solution				
Supplies for disinfection station (changing room and patient room)					
Pan or bucket with 1:10 bleach solution	1 per each disinfection station				
Pan or bucket with 1:100 bleach solution	1 per each disinfection station				
Pan or bucket with 1:100 bleach solution for collecting reusable gloves	1 per changing room				
Bucket or bag for collecting contaminated, reusable protective clothing	1 per changing room				
Bucket or bag for collecting patient's contaminated laundry	1 per patient isolation area				
Pan with soapy water for collecting used needles and syringes	1 per patient isolation area				

VHF Isolation Precautions Supplies: Disinfection

Recommended Item	Recommended Amount	Amount Available	Amount to Obtain	Local Adaptations	Tick if Item is Ready for Use
Sprayer, bucket or shallow pan with 1:100 bleach solution for disinfecting boots	1 for the disinfection station in patient room				
Sprayer, 1:100 bleach solution, clean water for disinfecting spills on floor or wall	1 per each disinfection station				
Mop	1 per each disinfection station				
Supplies for laundry					
Bucket with 1:10 bleach solution					
Buckets with 1:100 bleach solution	2 - 3 (10 - 30 litres of bleach solution is needed daily)				
Buckets with soapy water	2 - 3 (10 - 30 litres of soapy water is needed daily)				
Source of clean water for rinsing the laundry	10 - 30 litres/day				
Needles and thread for repairing holes in protective clothing	5 spools and 5 needles				
Talcum powder to put in washed gloves	1 tin				
Line to air-dry reusable clothes					

VHF Isolation Precautions Supplies: Waste Disposal

Recommended Item	Recommended Amount	Amount Available	Amount to Obtain	Local Adaptations	Tick if Item is Ready for Use
Containers with 1:100 bleach solution for collecting infectious waste	1 per patient isolation area				
Pit or incinerator for burning infectious waste*	1 per facility, pit should be 2 meters deep				
Kerosene or petrol	1 litre per week				
Wood for burning					
Rope to make barrier around the waste disposal site	enough length to go around the waste disposal site				

* If no incinerator is available, make one from an empty 220-litre (55-gallon) oil or fuel drum.

VHF Isolation Precautions Supplies: Safe Burial Practices

Recommended Item	Recommended Amount	Amount Available	Amount to Obtain	Local Adaptations	Tick if Item is Ready for Use
Supply of 1:10 bleach solution	prepared as needed				
Sprayer	1				
Body bags (cotton cloth, plastic sheeting, plastic tape)	as needed				

VHF Infection Control Supplies: Others

Recommended Item	Recommended Amount	Amount Available	Amount to Obtain	Local Adaptations	Tick if Item is Ready for Use
Supply checklist	as needed				
Patient record forms	as needed				
Accidental exposure record forms	as needed				
Training materials for staff training in VHF Isolation Precautions	as needed				

ANNEX 1 Standard Precautions for Hospital Infection Control¹³

Standard Precautions aim to reduce the risk of disease transmission in the health care setting, even when the source of infection is not known. Standard Precautions are designed for use with all patients who present in the health care setting and apply to:

- Blood and most body fluids whether or not they contain blood
- Broken skin
- Mucous membranes.

To reduce the risk of disease transmission in the health care setting, use the following Standard Precautions.

1. Wash hands immediately with soap and water before and after examining patients and after any contact with blood, body fluids and contaminated items — whether or not gloves were worn. Soaps containing an antimicrobial agent are recommended.
2. Wear clean, ordinary thin gloves anytime there is contact with blood, body fluids, mucous membrane, and broken skin. Change gloves between tasks or procedures on the same patient. Before going to another patient, remove gloves promptly and wash hands immediately, and then put on new gloves.
3. Wear a mask, protective eyewear and gown during any patient-care activity when splashes or sprays of body fluids are likely. Remove the soiled gown as soon as possible and wash hands.
4. Handle needles and other sharp instruments safely. Do not recap needles. Make sure contaminated equipment is not reused with another patient until it has been cleaned, disinfected, and sterilized properly. Dispose of non-reusable needles, syringes, and other sharp patient-care instruments in puncture-resistant containers.
5. Routinely clean and disinfect frequently touched surfaces including beds, bed rails, patient examination tables and bedside tables.
6. Clean and disinfect soiled linens and launder them safely. Avoid direct contact with items soiled with blood and body fluids.

13 Adapted from Garner JS, Hospital Infection Control Practices Advisory Committee. *Guideline for Isolation Precautions In Hospitals*, January 1996. Centers for Disease Control and Prevention, Public Health Service, US Department of Health and Human Services, Atlanta, Georgia.

7. Place a patient whose blood or body fluids are likely to contaminate surfaces or other patients in an isolation room or area.
8. Minimize the use of invasive procedures to avoid the potential for injury and accidental exposure. Use oral rather than injectable medications whenever possible.

When a specific diagnosis is made, find out how the disease is transmitted. Use precautions according to the transmission risk.

- *If airborne transmission:*
 1. Place the patient in an isolation room that is not air-conditioned or where air is not circulated to the rest of the health facility. Make sure the room has a door that can be closed.
 2. Wear a HEPA or other biosafety mask when working with the patient and in the patient's room.
 3. Limit movement of the patient from the room to other areas. Place a surgical mask on the patient who must be moved.
- *If droplet transmission:*
 1. Place the patient in an isolation room.
 2. Wear a HEPA or other biosafety mask when working with the patient.
 3. Limit movement of the patient from the room to other areas. If patient must be moved, place a surgical mask on the patient.
- *If contact transmission:*
 1. Place the patient in an isolation room and limit access.
 2. Wear gloves during contact with patient and with infectious body fluids or contaminated items. Reinforce handwashing throughout the health facility.
 3. Wear two layers of protective clothing.
 4. Limit movement of the patient from the isolation room to other areas.
 5. Avoid sharing equipment between patients. Designate equipment for each patient, if supplies allow. If sharing equipment is unavoidable, clean and disinfect it before use with the next patient.

ANNEX 2 Specific Features of VHFs¹⁴

Geographical and epidemiological characteristics of VHFs			
Disease	Geography	Vector/Reservoir	Human Infection
Crimean Congo HF	<ul style="list-style-type: none"> • Africa • Balkans • China (Western) • Former Soviet Union (Southern) • Middle East 	Ticks. Tick-mammal-tick maintenance.	<ul style="list-style-type: none"> • Tick bites. • Squashing ticks. • Exposure to aerosols or fomites from slaughtered cattle and sheep (domestic animals do not show evidence of illness but may become infected when transported to market or when held in pens for slaughter). • Nosocomial epidemics have occurred.
Dengue HF, Dengue Shock Syndrome (DHF/DSS)	All Tropic and subtropical Regions	<i>Aedes aegypti</i> mosquitoes. Mosquito-human-mosquito maintenance. Transmission occurs with the frequent geographic transport of viruses by travellers.	Increased world-wide distribution of the mosquito and the movement of dengue viruses in travellers is increasing the areas that are becoming infected.
Ebola HF and Marburg HF	Africa	Unknown.	<ul style="list-style-type: none"> • Virus is spread by close contact with an infected person. • Route of infection of the first case is unknown. • Infected non-human primates sometimes provide transmission link to humans. • Aerosol transmission is suspected in some monkey infections.
Lassa Fever	West Africa	Mice. The <i>Mastomys</i> genus of the mouse.	<ul style="list-style-type: none"> • Transmitted by aerosols from rodent to man. • Direct contact with infected rodents or their droppings, urine, or saliva. • Person-to-person contact. <p>Note: The reservoir rodent is very common in Africa and the disease is a major cause of severe febrile illness in West Africa.</p>

14 Peters CJ, Zaki SR, Rollin PE. Viral Hemorrhagic Fevers, Chapter 10 in Atlas of Infectious Diseases, vol 8, vol ed Robert Fekety, book ed GL Mandell. Philadelphia: Churchill Livingstone. 1997: pp10.1-10.26.

Geographical and epidemiological characteristics of VHFs

Disease	Geography	Vector/Reservoir	Human Infection
Rift Valley Fever	Sub-Saharan Africa	Floodwater mosquitoes. Maintained between mosquitoes and domestic animals, particularly sheep and cattle.	<ul style="list-style-type: none"> • Mosquito bite. • Contact with blood of infected sheep, cattle, or goats. • Aerosols generated from infected domestic animal blood. • No person-to-person transmission observed.
Yellow Fever	<ul style="list-style-type: none"> • Africa • South America 	<i>Aedes aegypti</i> mosquitoes. Mosquito-monkey-mosquito maintenance. Occasional human infection occurs when unvaccinated humans enter forest. In an urban outbreak, virus maintained in infected <i>Aedes aegypti</i> mosquitoes and humans.	<ul style="list-style-type: none"> • Mosquito bite. • In epidemics, mosquitoes amplify transmission between humans. • Fully developed cases cease to be viremic. Direct person-to-person transmission is not believed to be a problem although the virus is highly infectious (including aerosols) in the laboratory.

Common clinical features of VHF

Disease	Incubation Period	Case Fatality	Characteristic Features
Crimean Congo HF	3-12 days	15% - 30%	Most severe bleeding and ecchymoses (a purplish patch caused by blood coming from a vessel into the skin) of all the HF.
Ebola HF and Marburg HF	2-21 days	25% - 90%	<ul style="list-style-type: none"> • Most fatal of all HF. • Weight loss. • Exhaustion and loss of strength. • A maculopapular (a lesion with a broad base) rash is common • Post infection events have included hepatitis, uveitis and orchitis.
Lassa Fever	5-16 days	Approximately 15%	<ul style="list-style-type: none"> • Exhaustion and loss of strength. • Shock. • Deafness develops during recovery in 20% of cases.
Rift Valley Fever	2-5 days (uncomplicated disease; incubation for HF may differ)	50% of severe cases (about 1.5% of all infections)	<ul style="list-style-type: none"> • Shock. • Bleeding. • Reduced or no urine production. • Jaundice. • Inflammation of the brain. • Inflammation of the blood vessels in the retina of the eye.
Yellow Fever	3-6 days	20%	<ul style="list-style-type: none"> • Acute febrile period followed by a brief period of remission. • Toxic phase follows remission with jaundice and renal failure in severe cases.

Specific clinical findings in different VHF

Disease	haemorrhage	Thrombocytopenia ¹	leukocyte count ²	rash	icterus ³	renal disease	pulmonary disease	tremor ⁴ , dysarthria ⁵	encephalopathy ⁶	deafness	eye lesions
Crimean Congo HF	+ + +	+ + +	↓↓ ranging to ↑		++		+		+		
Ebola HF and Marburg HF	+ +	+ + +	data not available	+ + +	+ +		+		+ +	+	Retinitis
Lassa Fever	+ ranging to S	+	no change	+ +			+	+	+ ranging to S	+ +	
Rift Valley Fever	+ + +	+ + +	data not available		+ +	+	data not available		E		Retinitis
Yellow Fever	+ + +	+ +	no change ranging to ↓↓		+ + +	+ +	+		+ +		

¹ abnormally low number of platelets in the circulating blood

² white blood cell count

³ jaundice

⁴ shaking

⁵ difficulty speaking and pronouncing words due to problems with the muscles used for speaking

⁶ disease of the brain

+ occasional or mild

+ + commonly seen and may be severe

+ + + characteristic

S characteristic and seen in severe cases

↑ occasionally or mildly increased

↓↓ commonly decreased

E May develop true encephalitis

A summary of prevention and treatment of VHF

Disease	Prevention	Treatment
Crimean Congo HF	<ul style="list-style-type: none"> • Tick avoidance. • Avoid contact with acutely infected animals, especially slaughtering. • Use VHF Isolation Precautions when a case is suspected. 	<ul style="list-style-type: none"> • Ribavirin is effective in reducing mortality. • Ribavirin should be used based on in vitro sensitivity and of limited South African experience.
Dengue HF, Dengue Shock Syndrome (DHF/DSS)	<ul style="list-style-type: none"> • Mosquito control of <i>Aedes aegypti</i>. • Vaccines currently under investigation for probable use in travellers but unlikely to be a solution to hyperendemic dengue transmission that leads to dengue HF. 	<ul style="list-style-type: none"> • Supportive care. It is effective and greatly reduces mortality.
Ebola HF and Marburg HF	<ul style="list-style-type: none"> • Standard Precautions including needle sterilization in African hospitals are particularly important. • Use VHF Isolation Precautions when a case is suspected. • Avoid unprotected contact with suspected patients or infectious body fluids. • Avoid contact with monkeys and apes. 	<ul style="list-style-type: none"> • None other than supportive care, which may be of limited utility. • Antiviral therapies urgently needed.
Lassa Fever	<ul style="list-style-type: none"> • Rodent control. • Use VHF Isolation Precautions when a case is suspected. 	<ul style="list-style-type: none"> • Ribavirin is effective in reducing mortality. • Use Ribavirin in higher risk patients, e.g. if aspartate aminotransferase (AST) is greater than 150.
Rift Valley Fever	<ul style="list-style-type: none"> • Vaccination of domestic livestock prevents epidemics in livestock but not sporadic, endemic infections of humans. • Human vaccine safe and effective, but in limited supply. • Veterinarians and virology workers in sub-Saharan Africa are candidates for vaccine. 	<ul style="list-style-type: none"> • Supportive care. • Use Ribavirin in haemorrhage fever patients (based on studies in experimental animals).
Yellow Fever	<ul style="list-style-type: none"> • Mosquito control of <i>Aedes aegypti</i> would eliminate urban transmission but forest transmission remains. • Vaccine is probably the safest and most effective in the world. 	<ul style="list-style-type: none"> • Supportive care.

History of Viral Haemorrhagic Fevers Seen in Your Area	Major Signs and Symptoms	Transmission Route

ANNEX 3 Planning and Setting Up the Isolation
Area

Checklist: Supplies for a Changing Room

Storage Outside the Changing Room:

1. Shelf or cabinet with lock _____
2. Supply of clean scrub suits, gowns, aprons, gloves, masks, headcovering, and eyewear _____
3. Covered shelf for storing disinfected boots _____
4. Bucket for collecting non-infectious waste _____

Inside the Changing Room:

1. Hooks, nails, or hangers for hanging reusable gowns, scrub suits _____
2. Roll of plastic tape _____
3. Handwashing supplies: bucket or pan, clean water, soap, one-use towels _____
4. Bucket or pan, 1:100 bleach solution for disinfecting gloved hands _____
5. Container with soapy water for collecting discarded gloves _____
6. Container with soapy water for collecting used instruments to be sterilized* _____
7. Container with soapy water for collecting reusable gowns, masks, sheets to launder* _____

*Place outside the changing room if the changing room is too small

If large amounts of waste on floor:

Sprayer, bucket or shallow pan with 1:100 bleach solution for disinfecting boots _____

Checklist: Supplies for Patient Area

1. 1 bed with clean mattress or sleeping mat and at least a bottom sheet and blanket for each bed _____
2. Plastic sheeting to cover mattress or sleeping mat _____
3. 1 thermometer, 1 stethoscope, and 1 blood pressure cuff for each patient or for each patient area _____
4. 1 puncture-resistant container for collecting non-reusable needles, syringes, and discarded sharp instruments _____
5. 1 bedside table or shelf _____
6. 1 large wall clock with a second hand _____
7. Pan with 1:100 bleach solution or alcohol and one-use towels for disinfecting the thermometer and stethoscope between use with each patient _____
8. Bucket or pan, 1:100 bleach solution, one-use towels for disinfecting gloved hands between patients _____
9. Supplies for disinfecting patient excreta (bedpan, urinal, 1:10 bleach solution) _____
10. Sprayer, 1:100 bleach solution, clear water, and mop for disinfecting spills on floor and walls _____
11. Container with soapy water for collecting discarded gloves _____
12. Screens (or sheets hung from ropes or lines) placed between VHF patients' beds _____
13. Extra supply of gowns and gloves _____
14. Container for collecting infectious waste to be burned _____

Use the grid on the next page to draw the layout of an isolation area in your own health facility. Be sure to include:

- Area for patient isolation
- Changing room for health care workers to use for changing clothes
- Area for cleaning and laundering VHF-contaminated supplies
- Changing area for cleaning staff who handle VHF-contaminated waste but who do not do direct patient-care activities.

Planning Grid: Layout for Isolation Area in Your Health Facility

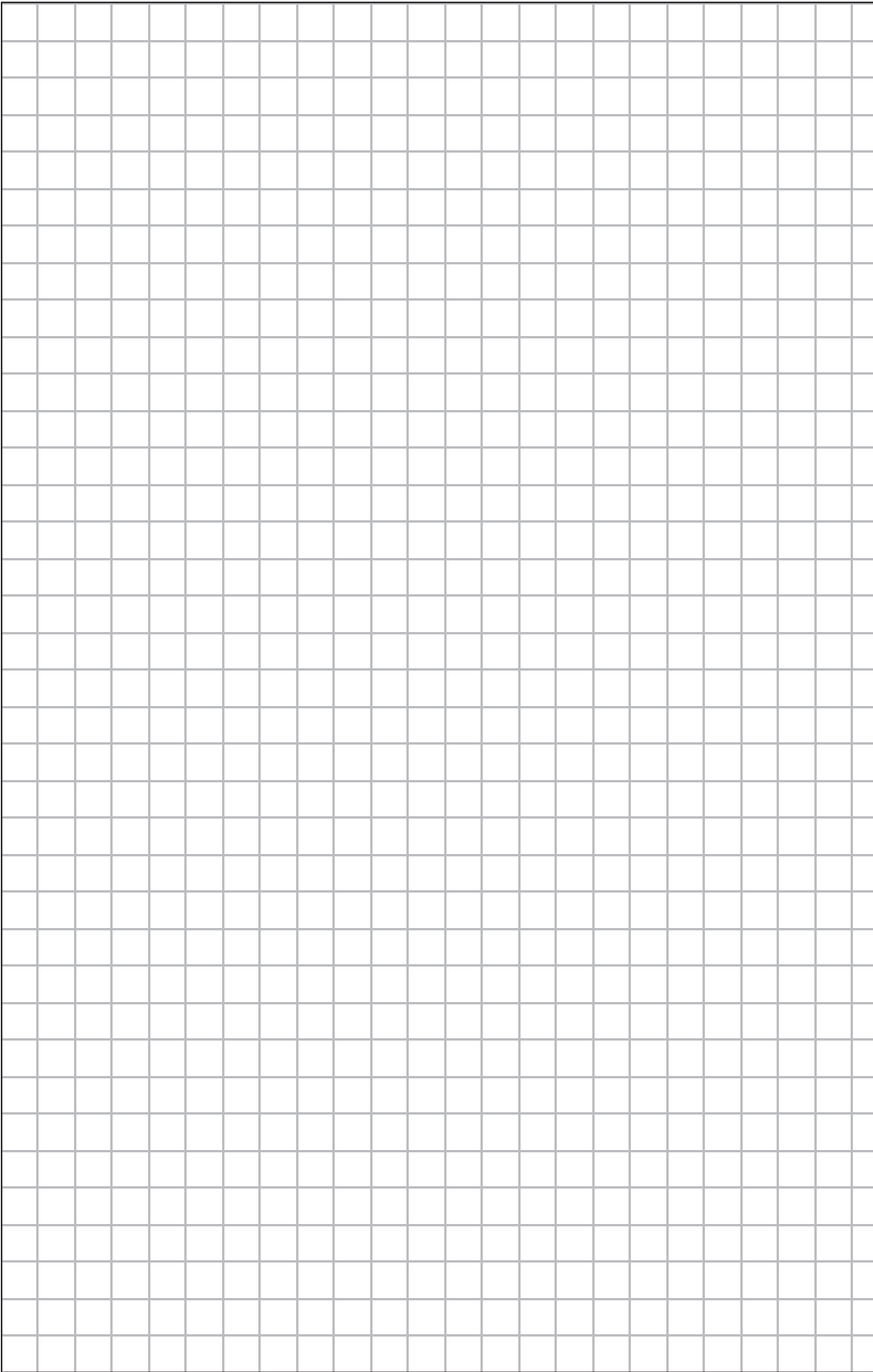

ANNEX 4 Adapting VHF Isolation Precautions for a Large Number of Patients

The recommendations in this manual assume 1 or 2 VHF cases have occurred in a non-outbreak situation. When more than 1 or 2 VHF patients present in the health facility, additional precautions need to be taken. When Ebola haemorrhagic fever occurs, initially there may be as many as 10 cases.

When a VHF is suspected, develop a case definition based on the VHF that has occurred. Use it to identify new cases during the outbreak. For example, the current case definition for suspecting Ebola haemorrhagic fever (EHF) is:

Anyone presenting with fever and signs of bleeding such as:

- Bleeding of the gums
- Bleeding from the nose
- Red eyes
- Bleeding into the skin (purple coloured patches in the skin)
- Bloody or dark stools
- Vomiting blood
- Other unexplained signs of bleeding

Whether or not there is a history of contact with a suspected case of EHF.

OR

Anyone living or deceased with:

- Contact with a suspected case of EHF **AND**
- A history of fever, with or without signs of bleeding.

OR

Anyone living or deceased with a history of fever **AND** 3 of the following symptoms:

- Headache
- Vomiting
- Loss of appetite
- Diarrhoea
- Weakness or severe fatigue
- Abdominal pain
- Generalized muscle or joint pain
- Difficulty swallowing
- Difficulty breathing
- Hiccups

OR

Any unexplained death in an area with suspected cases of EHF.

The current case definition for suspecting Lassa fever is:

Unexplained **fever** at least 38°C or 100.4°F for one week or more.

And 1 of the following:

- No response to standard treatment for most likely cause of fever (malaria, typhoid fever)
- Readmitted within 3 weeks of inpatient care for an illness with fever

And 1 of the following:

- Edema or bleeding
- Sore throat and retrosternal pain/vomiting
- Spontaneous abortion following fever
- Hearing loss following fever

Prepare Your Health Facility

If there are more than 2 suspected VHF patients, take steps immediately to adapt the VHF Isolation Precautions for a large number of patients.

1. Reinforce the use of Standard Precautions — especially handwashing — throughout the health facility. Make sure there is a reliable supply of soap and clean water in areas where health facility staff have contact with patients suspected as having a VHF.
2. Make sure adequate supplies of protective clothing are available.
3. Set up a temporary area that is separate from the rest of the facility where febrile patients can wait to be seen by a health care worker. Also use this area for patients who have been seen by a health care worker and who are waiting to go to the isolation area.

Make sure the temporary admission area contains a supply of protective clothing, buckets with disinfectants in them for collecting disposable waste, and disinfectants for cleaning and disinfecting spills of infectious materials.

4. Identify a family liaison person from the health facility staff who can spend time with families to answer questions, provide information about the VHF and its transmission. If family members help provide care when relatives are in hospital, make sure they know how to use protective clothing when they are with the patient in the isolation area. Help families with arrangements for cooking, washing and sleeping.
5. Designate a separate building or ward for placing patients with the same disease together in a single isolation area. Select and isolate a toilet or latrine for disposal of disinfected patient waste and other liquid waste.
6. Restrict access to the building or ward set aside as the isolation area. Set up walkways from the temporary area to the isolation area by tying ropes along the walkway and hanging plastic sheets from them.
7. Prepare a list of health facility staff authorized to enter the isolation area. Station a guard at the entry to the isolation area, and provide the guard with the list of authorized persons. The guard will use the list to limit access to the isolation area to authorized health facility staff and, if necessary, the caregiving family member.
8. Provide the guard with a sign-in sheet for recording who goes into the isolation area and the time of entry and departure.
9. Prepare a large quantity of disinfectant solutions each day (bleach solutions and detergent solutions). Store the disinfectants in large containers. Ask cleaning staff to change the disinfectants when they become bloody or cloudy or when the chlorine odour is no longer detectable.
10. Obtain additional patient supplies. Make sure each patient has a bed and mattress or sleeping mat. Designate medical equipment for use with each VHF patient (for example, a thermometer, a stethoscope, and a blood-pressure cuff for each patient). If there are not enough items available to provide one per patient, be sure to clean and disinfect the items before use with the next patient.
11. Make sure schedules are carried out as planned for collecting, transporting and burning infectious waste daily. Make sure that burning is supervised and that security of the burning site is maintained.
12. Initiate community education activities.

ANNEX 5 Making Protective Clothing

Instruction on Making Headwear

Materials needed:

Elastic $\frac{3}{4}$ meter

Cotton cloth 51 cm^2 (20 square inches)



A homemade head cover

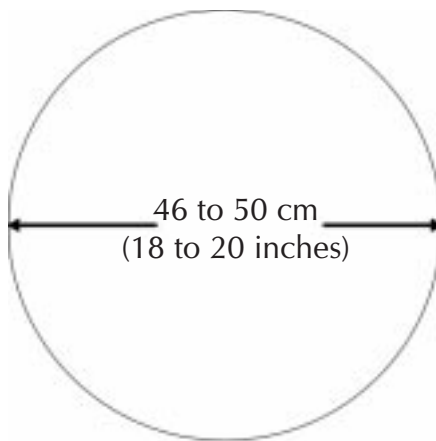

1. Cut a round piece of cotton cloth that is 46 to 50 cm (18 to 20 inches) in diameter.

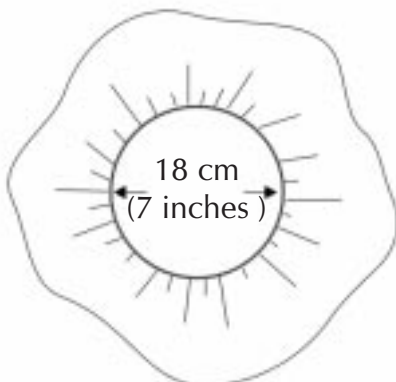

2. Sew elastic on the edge and shape a circle 18 cm (7 inches) in diameter.

Instruction on Making Gown

Materials needed:

1.5 meters cotton cloth to make one gown

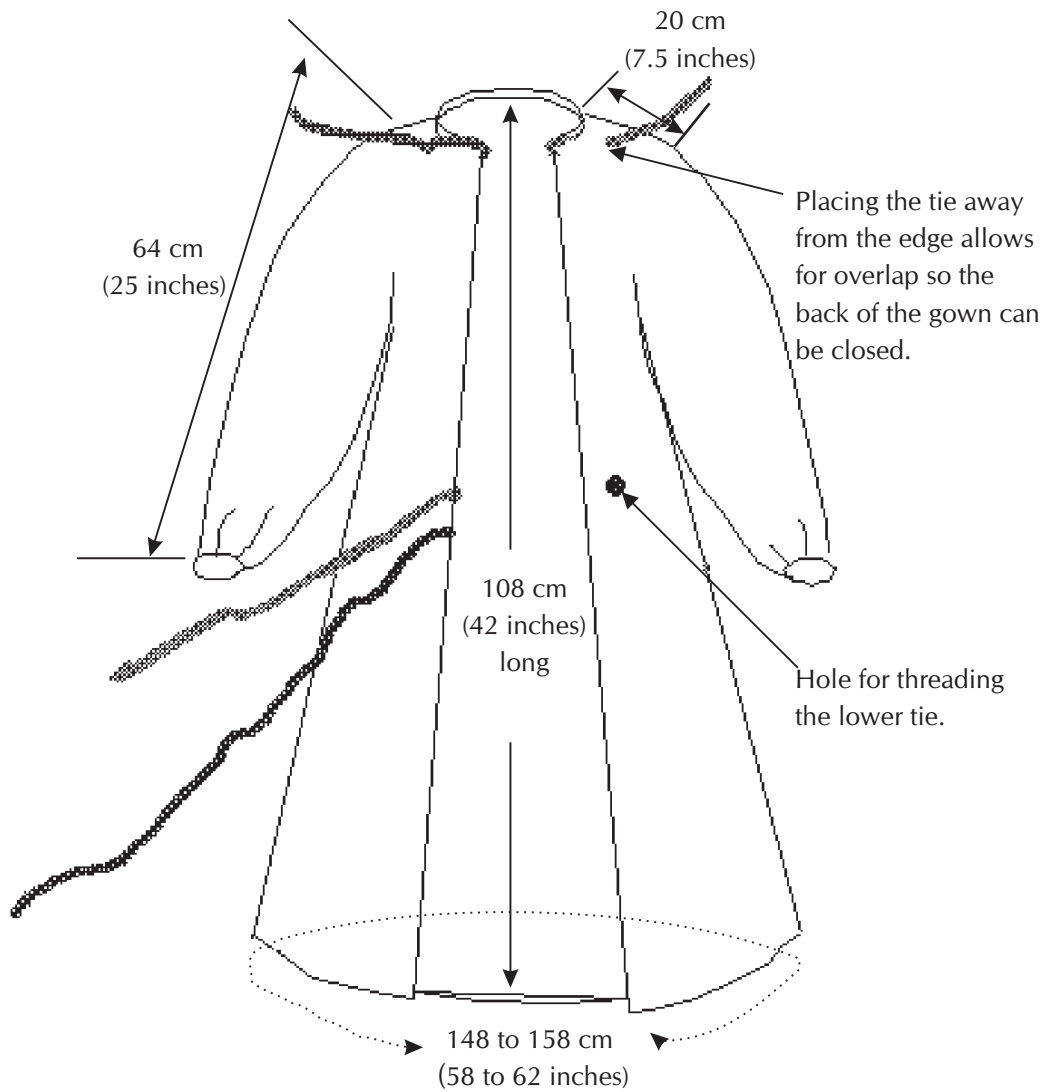

Instruction on Making Aprons

Materials needed (to make 2 aprons):

1 ¼ meters plastic sheeting or plastic cloth used for covering tables

91 cm (36 inches) sewing tape

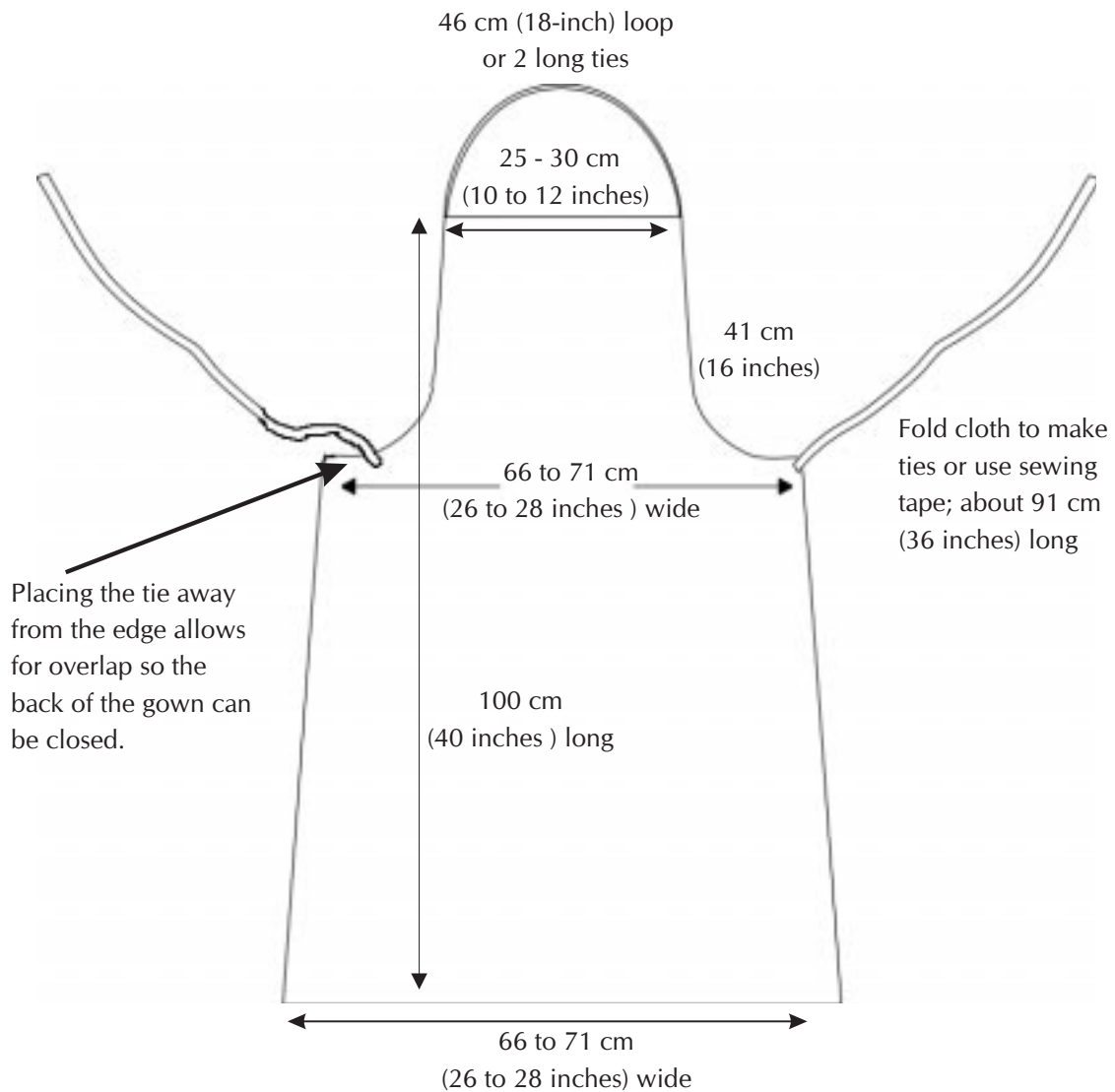

Instruction on Making a Cotton Mask

1 meter cotton cloth to make at least 2 masks

50 cm in second colour to make the inside of the masks

1. Cut 4 pieces of cotton cloth to the size shown.

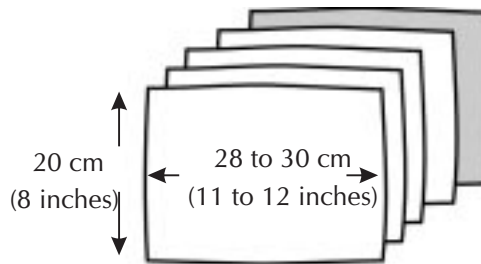

2. Cut 1 piece from a different colour. Use it as the inside of the mask.

3. Sew the 5 pieces together and gather or pleat the vertical sides to 13 cm (5 inches) long. Sew all pieces in place.

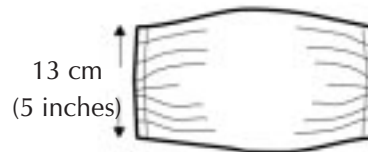

4. Sew on ties.



Specifications for Items of Protective Clothing:

This list describes the generic requirements for ordering or purchasing protective clothing from commercial vendors. Record the amounts needed on this list of specifications. The list can be photocopied and provided to donors to make sure that vendor specifications match the recommended specifications. Determine the quantities needed from the recommendations on the chart in Section 9.

Gowns	
Requirements	<p>Made from cotton cloth, cotton blend, or disposable fabric. The requirements are the same for both disposable <i>and</i> reusable gowns.</p> <p>Gowns should have the following requirements:</p> <ul style="list-style-type: none"> — Open at the back with ties at the neck, waist and middle of the back. — Ribbed or elasticized cuffs. — Be long enough to reach the knees. — If only large size is available, larger size can be cut and altered to fit smaller people. <p>If elasticized or ribbed cuffs are not available, attach thumb hooks to the end of the gown's sleeves. The thumb hooks can then be covered with the long wrist-sleeve of the gloves.</p>
Quantity needed	Number of disposable gowns _____ Number of reusable gowns _____

Apron	
Requirements	<p>Aprons are worn if there is risk of direct exposure to body fluids. The aprons are worn by physicians, nurses, corpse carriers, and cleaners. The requirements for the apron are the same for disposable or reusable models.</p> <p>Aprons should have the following requirements:</p> <ul style="list-style-type: none"> — Rubber or plastic apron with hooks or ties around the neck and with ties at the back. — Made from disposable plastic or heavy plastic which can be disinfected for reuse. — Able to fit over gown.
Quantity needed	Number of disposable aprons _____ Number of reusable aprons _____

Caps	
Requirements	To prevent contamination of hair and head from patient's vomit or blood: <ul style="list-style-type: none"> — Use disposable caps. — If disposable caps are not available, use cotton caps that can be laundered and reused.
Quantity needed	Number of disposable caps _____ Number of cotton caps _____

Masks	
Requirements	Worn to protect mouth and nose from splashes or droplets of patient's body fluids. Masks should offer appropriate protection. <ol style="list-style-type: none"> 1. 3M HEPA or N Series Mask: <ul style="list-style-type: none"> — Has preferable exhalation valve — Lightweight — Easy to use 2. Biosafety mask that limits 0.3-μm particles 3. Dust-mist masks 4. Surgical masks only protect from droplets splashed in the face. They are not HEPA rated.
Quantity needed	HEPA mask _____ Biosafety mask _____ Dust-mist mask _____

Thin gloves	
Requirements	Thin gloves to permit fine motor function. They can be surgical glove quality but do not need to be sterile. <ul style="list-style-type: none"> — Must reach well above the wrist, preferably 10 to 15 cm (4" to 6") long, measuring from the wrist up along the arm. — Should be tested for pinholes. — May be powdered or non-powdered.
Quantity needed	Number of pairs _____

Thick gloves	
Requirements	<p>Thick gloves for handling bodies, disinfection, and disposal of infectious waste.</p> <ul style="list-style-type: none"> — Should be made from neoprene or other thick rubber material. — Must reach well above the wrist, preferably about 30 cm (12"), measuring from wrist up along the arm.
Quantity needed	Number of pairs _____

Boots or overboots	
Requirements	<p>The requirements are the same for both latex overboots which can stretch over street shoes, and regular rubber boots</p> <ul style="list-style-type: none"> — Should be 30 cm (12") high and have textured soles. — Provide several sizes to meet size requirements of anyone who might use them (for example, obtain pairs of boots in sizes medium, and large). <p>Overboots are preferable to regular boots. They take up less space, fewer sizes are needed, and they are less expensive.</p>
Quantity needed	<p>Total number of pairs of overboots _____ (medium ____ large ____)</p> <p>Total number of pairs of rubber boots _____ (medium ____ large ____)</p>

Protective eyewear	
Requirements	<ol style="list-style-type: none"> 1. Use non-fogging goggles that are vented at the sides. 2. If non-fogging goggles are not available, purchase clear spectacles locally. <ul style="list-style-type: none"> — Should have ties extending from ear holders that can be tied around the back of the head so glasses will not fall off when health care worker leans over patient.
Quantity needed	<p>Number of pairs of non-fogging goggles _____</p> <p>Number of pairs of clear spectacles _____</p>

Annex 6

Other recommended equipment	Quantity needed
Sprayers: backpack style with hose to use for cleaning and disinfecting spills, rinsing boots, and other decontamination procedures.	
Plastic sheets for mattresses and barriers: can be purchased locally.	
Waterproof mattresses	
Front lamps: to fit over the physician's head to provide light when physician is examining patients.	
Kerosene lamps	
Body bags	

ANNEX 7 Disinfecting Water for Drinking, Cooking and Cleaning

The Standard Precautions and VHF Isolation Precautions described in this manual recommend using a source of clean water. In an emergency situation, health facility staff may not have access to clean running water. For example, if the power supply is cut off, water cannot be pumped to the health facility. Other sources of water could be contaminated.

This Annex describes how to use household bleach to disinfect water when clean running water is not available in the health facility.

Adding a small amount of full strength household bleach to water will disinfect it enough so that it can be safely used for drinking, cooking, and cleaning.¹⁵

1. Locate several containers for storing the disinfected water. They should have:
 - A narrow mouth (to prevent hands being put into the water)
 - A screw top or attached lid
 - A spigot, if possible.



An example of a water container

- Examples include jerry cans, large plastic jugs, or buckets with spigots and lids that can be firmly closed.
2. Make available:
 - At least 1 litre of full strength household bleach. Use the instructions on the package to prepare a full-strength concentration.
 - Pieces of bar soap or powdered soap.
 3. Clean and disinfect the containers. To disinfect the containers, wash them with soap and water, or rinse them with 1:100 bleach solution.
 4. Collect water from the available source (for example, a river, stream, or well used by the village).

15 World Health Organisation: Cholera and other diarrhoeal diseases control – technical cards on environmental sanitation. Document *WHO/EMC/DIS/97.6*. Geneva: 1997.

5. Place the water into the disinfected containers, and add 3 drops of full strength household bleach per litre of water.

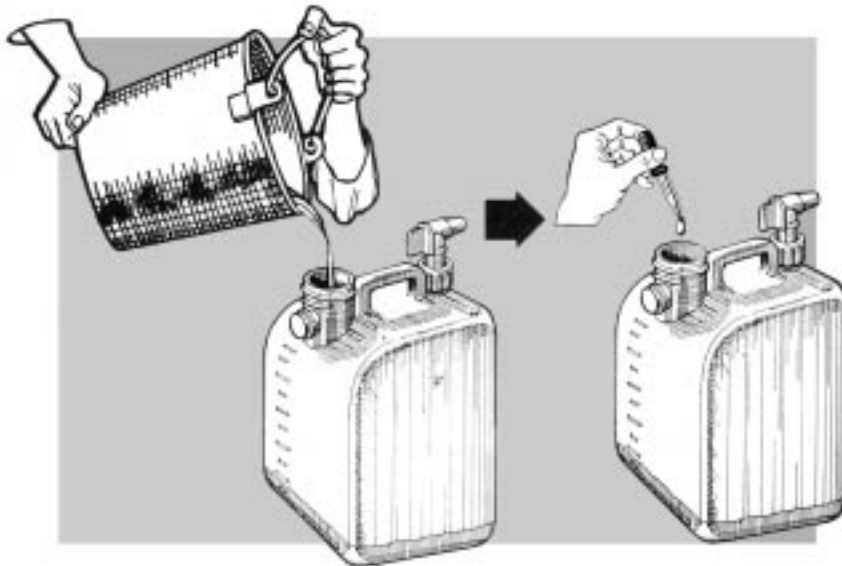

Preparing drinking water

6. Mix the water and bleach drops together.

Let the water stand for 30 minutes. This water is now safe to drink and to use for preparing meals. Clearly label the containers so that the health facility staff will know that the water is for drinking and is available for use. Use a marking pen to write *DRINKING WATER* on the container, or put a sign on it that says *DRINKING WATER*.

7. Provide clean water for the:

- Handwashing stations in areas where health workers are likely to have contact with patients who have fever or with infectious body fluids.
- Disinfection station where reusable needles and syringes are cleaned and disinfected.

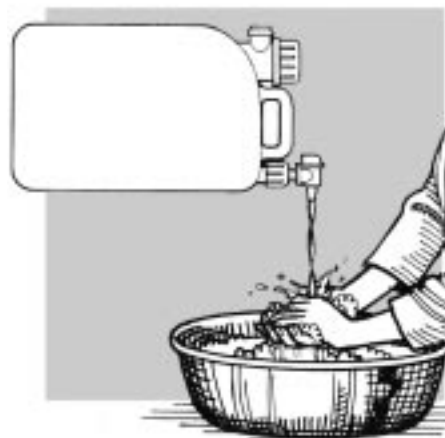

Using stored clean water for handwashing

8. Assign the job of collecting and disinfecting water to a specific health facility staff person. Give the health staff person information about how to do the task and why it is important. Make a schedule for collecting and disinfecting water routinely.

To disinfect a large quantity of water:

1. Determine how many litres the container holds.
Example: 25 litres
2. Calculate the amount of bleach that is needed to disinfect the specified quantity of water.
Example: Use 3 drops of bleach per litre of clear water.
 $3 \text{ drops} \times 25 \text{ litres} = 75 \text{ drops}$.
3. Find a spoon, cup or bleach bottle cap that can be used to measure the required amount of bleach. Count the number of drops that the measuring spoon, cup or bottle cap will hold.
Example: 75 drops of bleach = 1 teaspoon
4. Use the measuring spoon or cup to measure the amount of bleach each time the large quantity of water is disinfected.

ANNEX 8

Preparing Disinfectant Solutions by Using Other Chlorine Products

The disinfectants recommended in this manual are made with household bleach. This table describes how to make 1:10 and 1:100 chlorine solutions from other chlorine products.

Preparation and Use of Chlorine Disinfectants

Use a chlorine product to make :	1:10 solution For disinfecting: <ul style="list-style-type: none"> • Excreta • Cadavers • Spills 	1:100 solution For disinfecting: <ul style="list-style-type: none"> • Gloved hands • Bare hands and skin • Floors • Clothing • Equipment • Bedding
Household bleach 5% active chlorine	1 litre bleach per 10 litres of water	100 ml per 10 litres of water or 1 litre 1:10 bleach solution per 9 litres of water
Calcium hypochlorite powder or granules 70% (HTH)	7 grams or ½ tablespoon per 1 litre of water	7 grams or ½ tablespoon per 10 litres of water
Household bleach 30% active chlorine	16 grams or 1 tablespoon per 1 litre of water	16 grams or 1 tablespoon per 10 litres of water

ANNEX 9 Making Supplies: Sharps Container, Incinerator, and Boot Remover

Making a Sharps Container:

If a puncture-resistant container is not available for collecting used disposable needles, syringes and other sharp instruments that have penetrated the patient's skin, make a container using these instructions.

Materials:

- Plastic bottle or container made from burnable material (empty plastic water bottles, for example)
 - Cardboard box to serve as a stand for holding the plastic bottle
 - Plastic tape.
1. Gather several plastic bottles and boxes made from cardboard or other sturdy, burnable material.
 2. Tape the sides and lid of the cardboard box together so the top side is closed.
 3. Draw a circle on the top of the box that is the same diameter as the plastic bottle.
 4. Cut out the circle and leave a hole in the top of the box.
 5. Place the bottle inside the hole. Fill the bottle 1/3 full with 1:10 bleach solution.
 6. Place the bottle with its stand in the patient's room or where disposable skin-piercing equipment is used.
 7. At the end of the day, when disposable waste is collected, carry the bottle and its stand to the site for burning infectious waste. Place the bottle and box in the pit for burning.

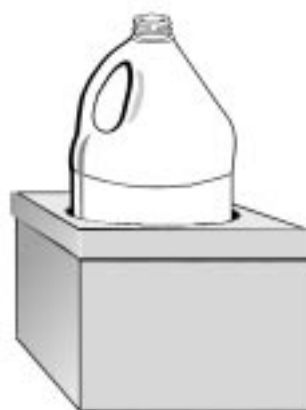

An adapted sharps container

Making an incinerator: See Annex 10.

Making a boot remover:

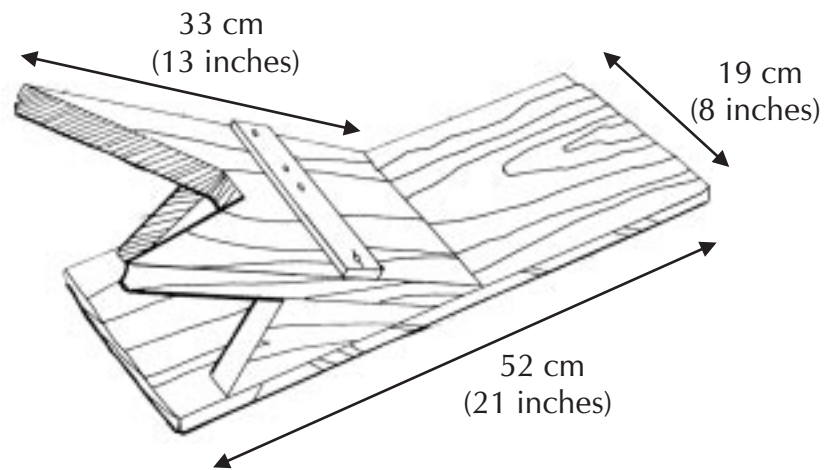

Please bring this picture to the local carpenter.

ANNEX 10 Sample Job-Aids and Posters for Use in the Health Facility

This section includes a series of sample posters that can be photocopied or hand-copied for use in health facilities. The sample posters and job-aids are pictorial explanations of how to do the steps described in various sections of this manual. For example, posters will remind health workers about:

- Using VHF Isolation Precautions
- How to put on and take off protective clothing
- How to build an incinerator.

Viral Haemorrhagic Fevers Isolation Precautions



Wash hands as needed



Isolate the patient



Wear protective clothing



Dispose of needles and syringes safely



Dispose of waste safely



Use safe burial practices

Steps for Putting On Protective Clothing



- 1 Wear scrub suit as the first layer of protective clothing.



- 2 Put on rubber boots.



- 3 Put on the first pair of gloves.



- 4 Put on the outer gown.

- 5 Put on the plastic apron.



- 6 Put on the second pair of gloves. Place the edge of gloves over the cuff of the gown.



- 7 Put on the mask.



- 8 Put on a head cover.



- 9 Put on the protective eyewear.



Steps for Taking Off Protective Clothing



1 Disinfect the outer pair of gloves.



2 Disinfect the apron and the boots.



3 Remove the outer pair of gloves.



4 Remove the apron.



5 Remove the outer gown.



6 Disinfect the gloved hands.

7 Remove the eyewear.



8 Remove the head cover.



9 Remove the mask.



10 Remove the boots.



11 Remove the inner pair of gloves.

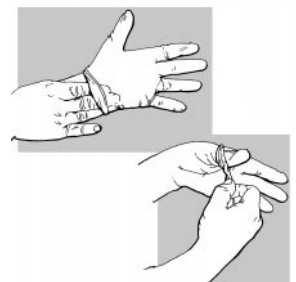

12 Wash hands with soap and clean water.

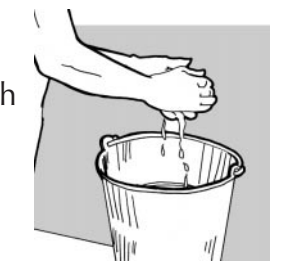

Steps for Building an Incinerator



1 Find a 220-litre (55-gallon) drum.

6 Cut 4 holes on the sides of the drum. Thread 2 metal rods through these holes so that they cross inside the drum.

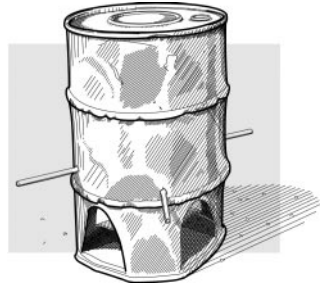

2 Cut open the drum. Remove and save the top cutaway piece.

7 Punch holes in the top cutaway piece to make a platform.

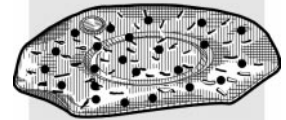

3 Hammer the edges of the drum so they are not sharp.

8 Pierce a series of holes on the side of the drum and above the crossed rods to improve the draw of the fire.

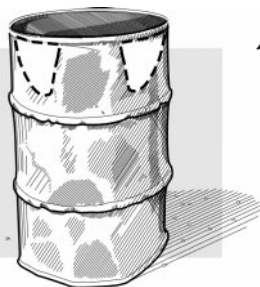
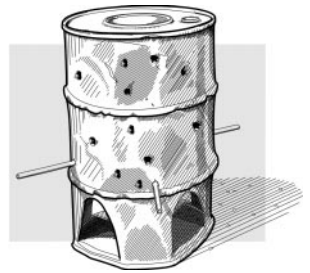

4 Cut 3 half-moon openings just above the top end of the drum.

9 Cut away half of the top. Attach the wire loops to the cutaway half to make a trap door. Attach another loop for a handle to open the trap door.

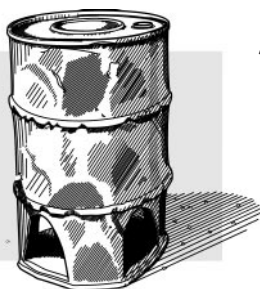
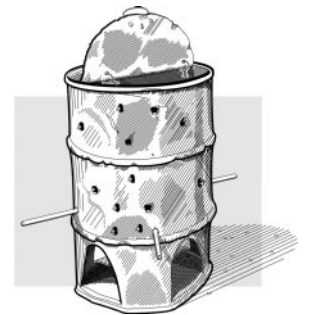

5 Turn the drum upside down. The bottom of the drum now is the top.

10 Place the platform inside the drum on top of the rods.

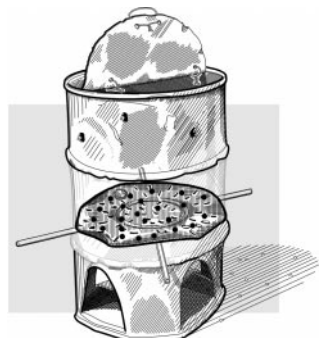

Always wear protective clothing when handling specimens from suspected VHF cases. Label all tubes carefully with name, date of collection and hospital number. Provide a patient summary or fill out a clinical signs and symptoms form (Annex 12). Contact your district officer for special instructions about collecting and shipping specimens.

Diagnostic Test	Samples required	Preparation & Storage	Shipping	Viruses to be confirmed
ELISA (Serology) Detects: — Viral antigen — IgM and IgG antibody	Whole blood* Serum or plasma Acute and convalescent**	Freeze or refrigerate (as cold as possible)	Frozen on dry ice or ice packs or both****	Ebola Lassa CCHF Rift Valley Marburg Yellow fever
PCR Detects: DNA, RNA (genetic material) from virus	Whole blood or clot*** Tissues (fresh frozen) Serum/plasma	Refrigerate or freeze Freeze	Frozen on dry ice or ice packs or both****	Ebola Lassa CCHF Rift Valley Marburg Yellow fever
Immunohistochemistry (liver) Detects: Viral antigen in cells	Liver biopsy from fatal cases	Fix in formalin (can be stored up to 6 weeks)	Room temperature (Do not freeze)	Ebola Lassa CCHF Rift Valley Marburg Yellow fever
Immunohistochemistry (skin) Detects: Viral antigen in cells	Skin biopsy from fatal cases (any site)	Fix in formalin (can be stored up to 6 weeks)	Room temperature (Do not freeze)	Ebola Lassa
Immunohistochemistry (other tissues) Detects: Viral antigen in cells	Tissue biopsy from fatal cases (other tissues, spleen, lung, heart, kidney)	Fix in formalin (can be stored up to 6 weeks)	Room temperature (Do not freeze)	<i>Possible detection of</i> Ebola, Lassa, CCHF, Rift Valley, Marburg, Yellow Fever

- * Whole blood can be used for enzyme-linked immunosorbent assay (ELISA) and may be frozen. Do not centrifuge suspected VHF specimens because this increases risk to the lab worker. If serum specimens have already been prepared these can be used. Place specimens in plastic tubes for shipping and storage and be sure that the tubes are sealed and properly labelled.
- ** Collect acute-phase specimen when patient is admitted to hospital or diagnosed as suspected case and collect convalescent-phase specimen at death or when discharged from the hospital.
- *** Whole blood or tissue is preferred, although serum or plasma may provide results.
- **** Use both ice packs and dry ice to provide best results. If dry ice or ice packs are not available, sample may be shipped at room temperature and still provide valid results in most cases.

ANNEX 12 Skin Biopsy on Fatal Cases for Diagnosis of Ebola

Ebola virus can be detected in fatal cases from a skin specimen using an immunohistochemistry test developed by the Centers for Disease Control and Prevention (CDC) Infectious Diseases Pathology Activity. The skin specimen is fixed in formalin which kills the virus. The specimen is no longer infectious once it is placed in formalin and the outside of the vial has been decontaminated. This vial can be shipped by mail or hand carried to the lab without risk. Results are available within a week after the specimen arrives at the CDC.

CDC provides Skin Biopsy Kits for the collection of skin samples in formalin. If these are available in your area, follow the simple instructions that are provided in the kit. An example of the instructions is on the following pages.

If a kit is not available, the biopsy can still be collected and sent for diagnosis to:

Dr. Sherif Zaki
Centers for Disease Control and Prevention
Infectious Diseases Pathology G-32
1600 Clifton Road, NE
Atlanta, GA 30329-4018



Viral Haemorrhagic Fever

Skin Biopsy Kit For Surveillance

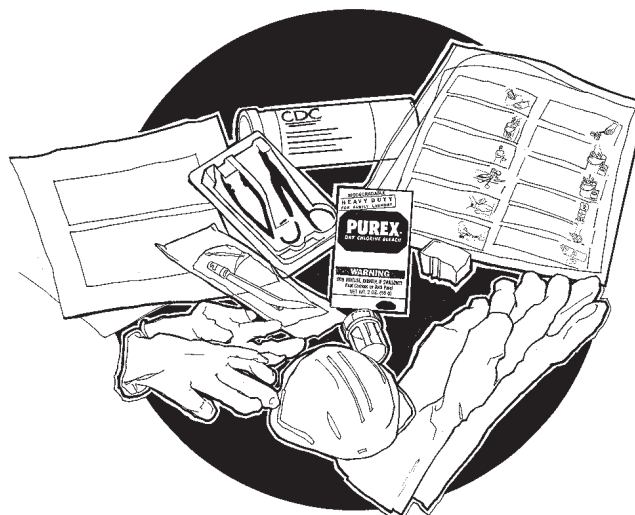

Check the list of equipment and make sure everything is in place before beginning.

Kit Equipment List:

1. Instruction sheet
2. Selection criteria and surveillance forms
3. (1) box powdered bleach
4. (4) pairs latex gloves
5. (2) pairs heavy-duty gloves
6. (2) masks
7. (1) biopsy tool
8. (1) tweezers and scissors set
9. (1) vial with formalin
10. (1) piece hand soap
11. (1) mailing tube
12. (1) set mailing labels

Other items needed:

1. 1 or 2 buckets for disinfectant and handwashing
2. Gowns or plastic aprons
3. 10 litres water

Shipping Instructions:

Be sure to fill out the forms with the name of the patient on each page. Number the vial and put the number on the form. This is very important especially if you have more than one specimen to send. Use a pencil to write on the lid of the vial.

The formalin fixed specimen is not infectious. The vial can be sent by normal mail, carried on a plane or delivered to the U.S. Embassy **without risk** to the carrier.

Put the forms and the vial containing the specimen into the mailing tube. Close the lid tightly and seal with tape if available. Put the label on the tube and send it to CDC either by the U.S. Embassy or by the post. It can be mailed in your country or if someone carries it to the U.S., it can be placed in any U.S. Mailbox.

Please remember to put stamps on the package.

Surveillance for Ebola Haemorrhagic Fever

INSTRUCTION FOR USING THE SKIN BIOPSY KIT

IMPORTANT: For security, all of the equipment used in the biopsy is for one use only and must not be reused.

1 Fill out the patient forms with the patient information. Include your address for sending the results. Check the equipment and make sure you have everything you need.



7 Place the sample in the formalin. Close the cap tightly to prevent leaks.



2 Prepare the disinfectant solution. Mix the contents of the box of bleach in 10 litres of water.



8 Dip the vial in the disinfectant for 1 minute. Set it aside to dry.



3 Put on the protective clothing. Begin with the gown, next the latex gloves, then the kitchen gloves and the mask. Use a plastic apron if one is available.



9 Then place the rest of the equipment in the disinfectant. If you need to move the cadaver, do so while you are still wearing the protective clothing. When you are finished, rinse your exterior gloves in the disinfectant, remove them and drop them in the disinfectant bucket.

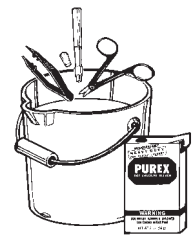

4 Take the equipment to the work site. Open the vial of formalin. Open the two packets of instruments: the scissors and the tweezers, and the biopsy tool. Take the cover off the biopsy tool and arrange the equipment for use near the body.



10 Wearing the interior gloves, remove all of the disinfected material and place in the plastic sac. Burn the sac in the incinerator. Remove your gloves and burn.



5 Gently turn the head of the cadaver to expose the nape of the neck. Place the biopsy tool perpendicular to the neck and press down into the skin up to the guard. Rotate gently. Remove the biopsy tool.



6 With the tweezers, gently lift out the core you cut in the skin and use the scissors to cut the piece away if necessary.



11 Wash your hands with soap and water. The specimen is not infectious after it is placed in formalin and the outside of the vial is disinfected.



12 Place the vial and the patient forms in the mailing tube and send to CDC, Atlanta. Do not freeze the sample.

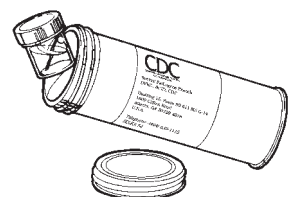

Haemorrhagic Fever Surveillance Form

Name and location of Health Centre:

Vial Number:

Name of physician or nurse:

Contact address (**Important: to receive results, give a very specific contact address**):

Telephone /Facsimile number:

Patient data

Hospital Number:

Name:

Age:

Sex: Male Female

Address:

Profession or occupation:

Date of first symptoms:

Date of admittance:

Date of death:

Date of biopsy:

If patient was not hospitalized, who cared for the patient?

Are any other family members ill? If yes, relationship:

Symptoms of family member:

If the patient was hospitalized, use the table on the back to mark the symptoms which you observed and any other important observations.

Clinical Signs and Symptoms Form

Name of Patient: _____

Symptoms (Check each one present)	Date of appearance:
<input type="checkbox"/> Fever	
<input type="checkbox"/> Diarrhoea	
<input type="checkbox"/> Extreme weakness after rehydration	
<input type="checkbox"/> Nausea	
<input type="checkbox"/> Vomiting	
<input type="checkbox"/> Sore throat	
<input type="checkbox"/> Headache	
<input type="checkbox"/> Loss of appetite	
<input type="checkbox"/> Muscle pain	
<input type="checkbox"/> Joint pain	
<input type="checkbox"/> Hiccups	
<input type="checkbox"/> Cough	
<input type="checkbox"/> Conjunctivitis (red eye)	
<input type="checkbox"/> Chest pain	
<input type="checkbox"/> Rapid respiration	
<input type="checkbox"/> Recent loss of hearing	
<input type="checkbox"/> Burning sensations of the skin	
Bleeding , specify below:	Date of appearance:
<input type="checkbox"/> Black or bloody vomit	
<input type="checkbox"/> Black or bloody stool	
<input type="checkbox"/> Mouth	
<input type="checkbox"/> Nose	
<input type="checkbox"/> Urine	
<input type="checkbox"/> Skin or puncture site	
<input type="checkbox"/> Other bleeding: specify	
<input type="checkbox"/> Other observations	Date of appearance:

Selection criteria for testing of suspected Ebola haemorrhagic fever (EHF)

Patient's last name, first name: _____

When to take a skin biopsy for testing:

The patient had the following symptoms within two weeks preceding death:

- Fever and
- Diarrhoea and
- One of the following signs:
 - Headache
 - Intense weakness after rehydration
 - Muscle pains
 - Joint pain
 - Back pain

Treatment was given with antibiotics and antimalarials for a minimum of three days.

The patient failed to respond to treatment and died

Or

Died with at least 3 of the following symptoms and no definitive diagnosis:

- Sore throat or difficulty in swallowing
- Red eyes
- Skin eruptions
- Hiccups
- Burning sensation of the skin
- Bleeding: nose, mouth, urine, stools (black or bloody), or vomit (black or bloody)
- Rapid respiration

The diagnosis of haemorrhagic fever is possible and even probable if the patient is bleeding.

If the patient reports another similar death in the family recently, the diagnosis of EHF is even more likely. Measures should be taken to put the family and contacts under surveillance.

Take a skin biopsy, following the instructions given in this annex.

The biopsy is not infectious once in formalin.

Send it to CDC for testing at the address on the back of this form.

Dr. Sherif Zaki

Centers for Disease Control and Prevention

Infectious Diseases Pathology G-32

1600 Clifton Road, NE

Atlanta, GA 30329-4018

Examples of posters used to provide information to family members of Ebola patients. Kikwit, 1995.

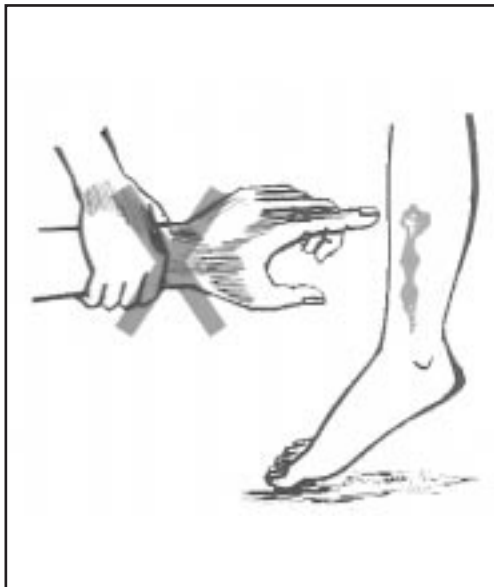

Avoid contact with the patient's blood, urine, and vomit.



Do not touch or wash the bodies of deceased patients.

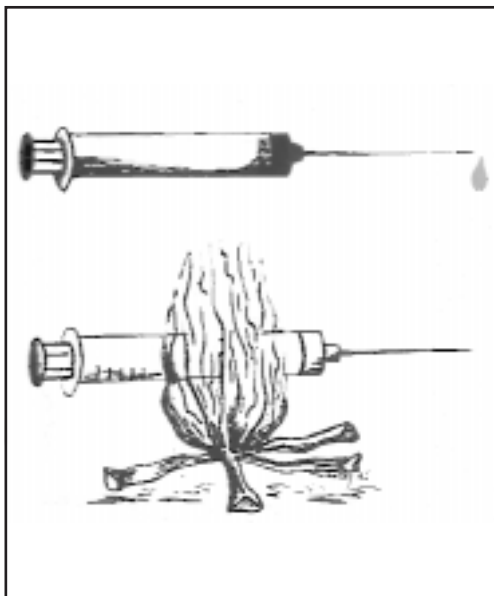

Burn needles and syringes immediately after use.



Use gloves to handle the patient's clothing. Boil soiled clothing before washing it.

Examples of posters or teaching aids for viral haemorrhagic fevers

Protect yourself.

Never touch urine, blood, vomit from a patient with fever.

Wash spills with bleach solution or soap and water.

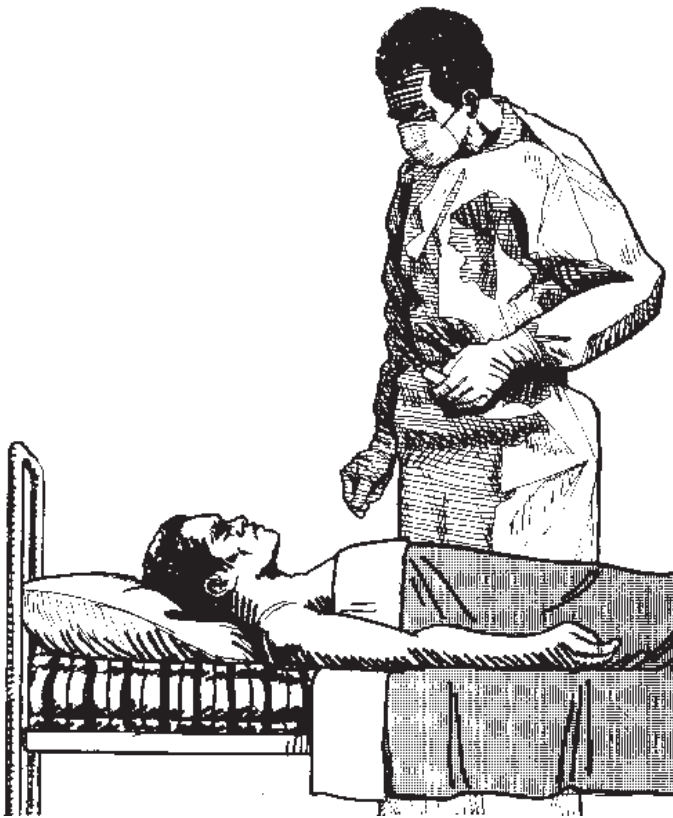

To prevent transmission of Lassa fever, wear a gown, gloves and mask.

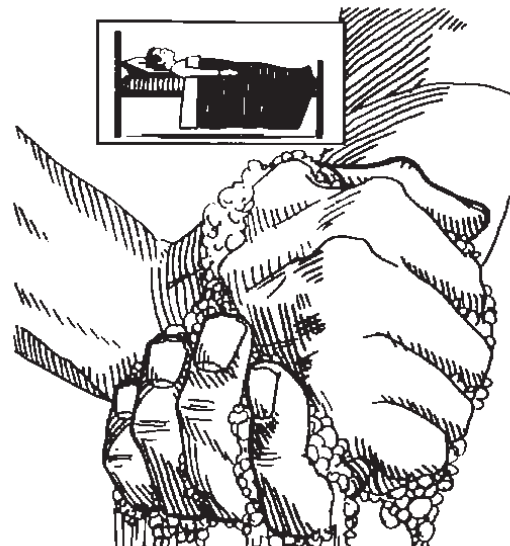

Wash your hands if you take care of a patient with fever.



In addition to fever, Lassa fever patient may have: sore throat, back pain, cough, headache, red eyes, vomiting, or chest pain.



You can get Lassa fever by touching the blood, urine, or vomitus of another person with Lassa fever.



To prevent Lassa fever, keep your food and water covered.



There is no injection or vaccine to prevent Lassa fever. To prevent Lassa fever, we must prevent its spread by rats.

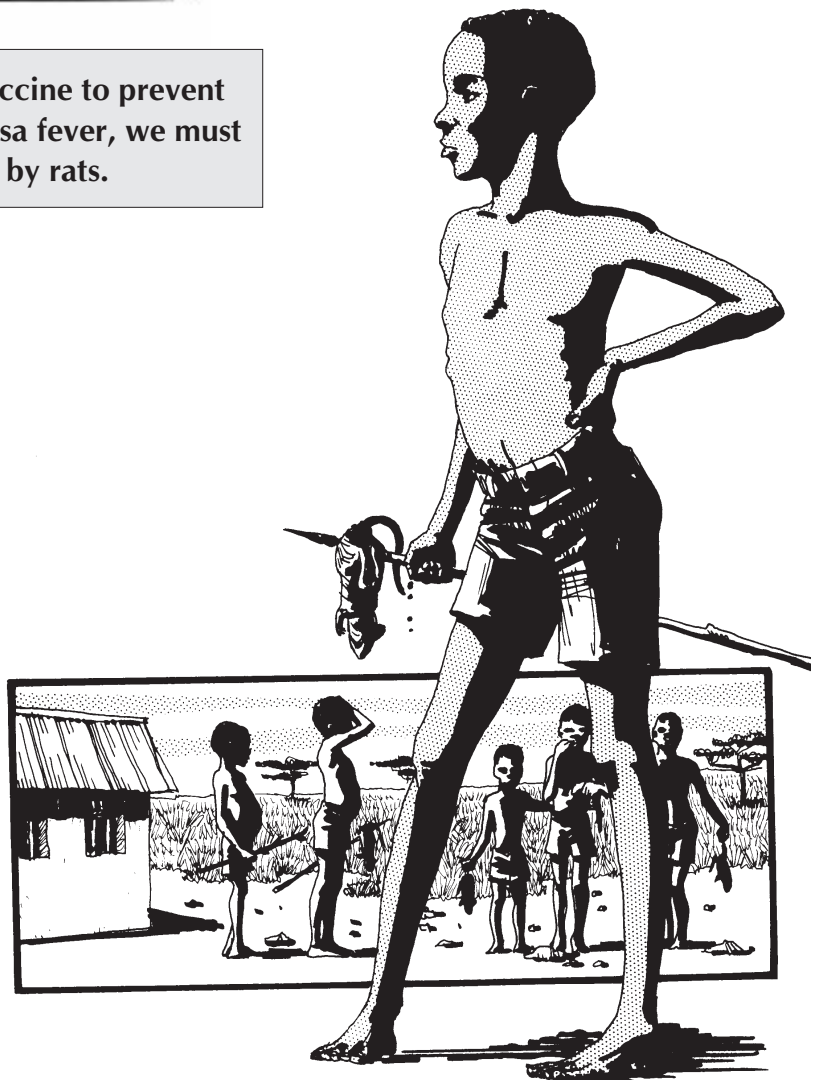

You can get Lassa fever by touching, playing with, or cutting up a rat's dead body.

ANNEX 14 Conducting In-Service Training for VHF Isolation Precautions

In-service training for VHF Isolation Precautions should be ongoing. Provide training about VHF Isolation Precautions during supervisory visits, staff meetings or conferences. Also use other channels such as newsletters, bulletins and job-aids to provide health facility staff with information and reinforce the use of VHF Isolation Precautions.

Training in skills is most effective if health staff receive information, see examples, and have an opportunity to practice the skills they are learning. Make sure that training sessions for each topic include relevant examples and opportunities for meaningful practice.

Conduct training sessions in small groups with each category of health worker.

- Present **information** with charts, pictures, posters or information written on a flipchart or chalkboard. Use drawings from this manual to illustrate the topic you are presenting.
- Give **examples** of the skills you would like the health staff to use. For example, demonstrate the steps for handwashing as you explain aloud what you are doing.
- Provide the materials and supplies that health staff need to **practice** the skill. For example, provide two buckets of clean water, soap and clean, one-use towels. Ask health workers one at a time to practice washing their hands. Ask for feedback from the rest of the group about what was done well and where improvement is needed.
- Provide **feedback** to the health staff and answer questions. Conclude the training by summarizing the steps presented in the session. Provide a job-aid or handout to tape on a wall to remind health facility staff about the skills they learned in the session.
- Routinely monitor supplies and equipment to make sure that the supplies for doing the desired skill are available. During supervisory visits, be sure to acknowledge when you see health staff using the skills well. When problems occur, find out what has caused them, and take steps to solve them so that health staff can continue to use the practices consistently.

The following is a sample agenda for in-service training. It describes how to include topics about VHF Isolation Precautions during monthly staff meetings. Adapt it to the schedule for your health facility.

Month	VHF Isolation Precautions Topic
January	<ol style="list-style-type: none"> 1. Disease Transmission in the Health Care Setting 2. Identifying Viral Haemorrhagic Fevers: When to Suspect a VHF 3. General Information about Standard Precautions 4. Handwashing
February	<ol style="list-style-type: none"> 1. Recommended Protective Clothing for VHF 2. Practice Putting On and Taking Off Protective Clothing
March	<ol style="list-style-type: none"> 1. Preparing Disinfectants 2. Using Disinfectants
April	<ol style="list-style-type: none"> 1. Selecting Disposal Sites and Planning Security Barriers 2. Building an Incinerator
May	<ol style="list-style-type: none"> 1. Maintaining an Incinerator 2. Preparing a Pit for Burning Infectious Waste
June	<ol style="list-style-type: none"> 1. Safe Use and Disposal of Sharp Instruments 2. Making a Sharps Container
July	<ol style="list-style-type: none"> 1. Assessing Inventory of Protective Clothing 2. Identifying Items to Use When Recommended Protective Clothing is not Available
August	<ol style="list-style-type: none"> 1. Sites for Isolation Area (Patient Room and Changing Room); Security Barriers 2. Planning to Set Up an Isolation Area
September	<ol style="list-style-type: none"> 1. Assessing Available Supplies for Isolation Area 2. Identifying Items to Use When Recommended Supplies are not Available
October	<ol style="list-style-type: none"> 1. Selecting and Training Caregiving Family Members: VHF, Protective Clothing
November	<ol style="list-style-type: none"> 1. Using VHF Isolation Precautions during Patient Care 2. Disinfecting Thermometers, Stethoscopes and Blood Pressure Cuffs 3. Disinfecting Used Needles and Syringes
December	<ol style="list-style-type: none"> 1. Procedures for Responding to Accidental Exposures 2. Standard Precautions – Especially Handwashing after Examining Patients with Fever

ANNEX 15 Local Resources for Community Mobilization and Education

Section 8 of this manual describes how to develop community education in an urgent situation. The first step is to identify key community resources such as groups who know the community and already have access to it. Information about each key community resource can be recorded on the following chart. Use the chart as a reference to identify appropriate community resources that can be called upon when a VHF occurs.

Local Resources for Community Mobilization and Education

Organization or Group	Expertise	Representative or Leader and Locating Information	Human Resources	Available Equipment	Contacted?	Task Assigned

ANNEX 16

International and Regional Contacts

SWITZERLAND	<p>World Health Organization (WHO) Division of Emerging and other Communicable Diseases Surveillance and Control (EMC) Dr David L. Heymann 20 Avenue Appia, CH-1211 Genève 27, Switzerland Tel: 41-22-791-2660/41-22-791-2661 Fax: 41-22-791-4198 E-mail: HEYMANND@WHO.CH</p>
ZIMBABWE	<p>WHO Regional Office for Africa Dr D. Barakamfitiye Director, Prevention and Control of Diseases Medical School, C Ward, Parirenyatwa Hospital, Mazoe Street P.O.Box BE 773, Belvedere, Harare, Zimbabwe Tel: 1-407-733-9236 Fax: 1-407-733-9360 E-mail: BARAKAMFITIYED@HTSD.COM at INET</p> <p>Dr A. Ndikuyeze, Regional Adviser, Prevention and Control of Diseases Medical School, C Ward, Parirenyatwa Hospital, Mazoe Street P.O.Box BE 773, Belvedere, Harare, Zimbabwe Tel: 1-407-733-9240 Fax: 263-479-1214 E-mail: NDIKUYEZE@SERVER.WHOAFR.ORG</p>
WHO Collaborating Centres for Viral Haemorrhagic Fevers	
UNITED STATES OF AMERICA	<p>Centers for Disease Control and Prevention (CDC) National Center for Infectious Diseases Division of Viral and Rickettsial Diseases Special Pathogens Branch 1600 Clifton Road, MS G-14 Atlanta, Georgia 30329-4018, USA Telephone: 1-404-639-1115 Fax: 1-404-639-1118 E-Mail: CJP0@CDC.GOV</p>

UNITED STATES OF AMERICA	US Army Medical Research Institute of Infectious Diseases (USAMRIID) Fort Detrick, Maryland 21702-5011, USA Telephone: 1-301-619-4608 Fax: 1-301-619-4625
CENTRAL AFRICAN REPUBLIC	Institut Pasteur de Bangui Boite Postale 923 Bangui, Central African Republic Telephone: 236-614-576 Fax: 236-610-109
FINLAND	University of Helsinki Haartman Institute Department of Virology P.O.Box 21 SF-Helsinki, Finland Telephone: 358-0-434-6490 Fax: 358-0-434-6491
FRANCE	Institut Pasteur à Paris 28, rue du Dr Roux 75724 Paris Cedex 15, France Telephone: 33-1-4061-3088 Fax: 33-1-4061-3151
GERMANY	Philipps-University Institute of Virology Robert-Koch-Str. 17 D-35037 Marburg, Germany Telephone: 49-6421-28-6253 Fax: 49-6421-28-8962
KENYA	Kenya Medical Research Institute Mbagathi Road P.O.Box 54628 Nairobi, Kenya Telephone: 254-2-722-541 Fax: 254-2-725-950

NIGERIA	University of Ibadan College of Medicine Department of Virology Ibadan, Nigeria
SOUTH AFRICA	National Institute for Virology Special Pathogens Unit Private Bag X4 Sandringham 2131, Zaloska 4 Republic of South Africa Telephone: 27-11-882-9910 Fax: 27-11-882-0596
SWEDEN	Swedish Institute for Infectious Disease Control S-105 21 Stockholm, Sweden Telephone: 46-8-735-1300 Fax: 46-8-735-6615
UNITED KINGDOM	Centre for Applied Microbiology and Research Division of Pathology Porton Down, Salisbury, United Kingdom Telephone: 44-198-061-2224 Fax: 44-198-061-2731

References

Viral haemorrhagic fevers

Baron RC, McCormick JB, and OA Zubier. Ebola virus disease in southern Sudan: hospital dissemination and spread. *Bull WHO*: 61: 997-1003, 1983

Centers for Disease Control and Prevention. Update: Outbreak of Ebola viral hemorrhagic fever, Zaire, 1995. *MMWR*: 44: 468-469, 475, 1995

Feldmann H, Klenk HD, and A Sanchez. Molecular biology and evolution of filoviruses. *Archives of Virology*: 7suppl: 81-100, 1993

Gear JH. Clinical aspects of African viral hemorrhagic fevers. *Reviews of Infectious Diseases*: 11suppl: s777-s782, 1989

Gear JS, Cassel GA, Gear AJ, Trappler B, Clausen L, Myers AM, Kew MC, Bothwell TH, Sher R, Miller GB, Schneider J, Koornhoh HJ, Gomperts ED, Isaacson M, and JH Gear. Outbreak of Marburg virus disease in Johannesburg. *British Medical Journal*: 4: 489-493, 1975

Johnson KM. African hemorrhagic fevers caused by Marburg and Ebola viruses. In: Evans AS, ed. *Viral Infections of Humans, Epidemiology and Control*. New York: Plenum Medical Book Company. pp. 95-103, 1989

Khan AS, et al. The reemergence of Ebola hemorrhagic fever. *Journal of Infectious Diseases*: 1998, in press.

Peters CJ, Sanchez A, Feldmann H, Rollin PE, Nichol S, and TG Ksiazek. Filoviruses as emerging pathogens. *Seminars in Virology*: 5: 147-154, 1994

Peters CJ, Johnson ED, Jahrling PB, Ksiazek TG, Rollin PE, White J, Hall W, Trotter R, and N Jaxx. Filoviruses. In: Morse SS, ed. *Emerging Viruses*. New York: Oxford University Press. pp. 159-175, 1991

Peters CJ, Zaki SR, and PE Rollin. Viral hemorrhagic fevers. In: Fekety R, vol. ed. Mandell GL, book ed. *Atlas of Infectious Diseases*, vol 8. Philadelphia: Churchill Livingstone. 10.1-10.26, 1997

World Health Organization. Ebola haemorrhagic fever in Sudan, 1976. Report of a WHO/International Study Team. *Bull WHO*: 56: 247-270, 1978

World Health Organization. Ebola haemorrhagic fever in Zaire, 1976. Report of an International Commission. *Bull WHO*: 56: 271-293, 1978

Sanchez A, Ksiazek TG, Rollin PE, Peters CJ, Nichol ST, Khan AS, and BWJ Mahy. Reemergence of Ebola virus in Africa. *Emerging Infectious Diseases*: 1: 96-97, 1995

Sureau PH. Firsthand clinical observations of hemorrhagic manifestations in Ebola hemorrhagic fever in Zaire. *Reviews of Infectious Diseases*: 11suppl: s790-s793, 1989

Patient Management

Centers for Disease Control. Management of patients with suspected viral hemorrhagic fever. *MMWR*: 37(suppl 3): 1-16, 1988

Garner JS, Hospital Infection Control Practices Advisory Committee. Guidelines for Isolation Precautions in Hospitals. Hospital Infections Program, Centers for Disease Control and Prevention. January 1996

Peters CJ, Johnson ED, and KT McKee Jr. Filoviruses and management of patients with viral hemorrhagic fevers. In: Belshe RB, ed. *Textbook of Human Virology*. St. Louis: Mosby-Year Book. pp. 699-712, 1991

Paverd, Norma. Crimean-Congo haemorrhagic fever: A protocol for control and containment in a health care facility. *Nursing RSA Verpleging*: 3(5): 22-29, (6): 41-44, (7): 33-38, 1988

Disinfection

Favero MS and WW Bond. Sterilization, disinfection, and antisepsis in the hospital. In: Murray PR, ed. *Manual of Clinical Microbiology*. Washington, D.C.: American Society of Microbiology. pp. 183-200, 1991

Haverkos HW and TS Jones. HIV, drug-use paraphernalia and bleach. (Review) *Journal of Acquired Immune Deficiency Syndromes*: 7: 741-742, 1994

McCoy CB, Rivers JE, McCoy HV, Shapshak P, Weatherby NL, Chitwood DD, Page JB, Inciard JA, and DC McBride. Compliance to bleach disinfection protocols among injecting drug users in Miami. *Journal of Acquired Immune Deficiency Syndromes*: 7: 773-776, 1994

Ohio State University Extension Service and US Department of Agriculture. Emergency Disinfection of Water Supplies, AEX-317.
<http://www.ag.ohio-state.edu/~ohioline/aex-fact/317.html>

Watters JK. Historical perspective on the use of bleach in HIV/AIDS prevention. *Journal of Acquired Immune Deficiency Syndromes*: 7: 743-746, 1994

Watters JK, Jones TS, Shapeshak P, McCoy CB, Flynn N, Gleghorn A, and D Vlahov. Household bleach as disinfectant for use by injecting drug users (letter: comment). *Lancet*: 342: 742-743, 1993

World Health Organization. Cholera and other diarrhoeal diseases control - technical cards on environmental sanitation. Document *WHO/EMC/DIS/97.6*. Geneva: 1997

Suggested Readings in French

Baudon D. Virus Ebola et fièvre jaune: les leçons à tirer des épidémies. *Médecine Tropicale*: 55: 133-134, 1995

Bausch DG et PE Rollin. La fièvre de Lassa. *Annales de l'Institut Pasteur*: 8: 223-231, 1997

Feldmann H, Volchkov VE, et HD Klenk. Filovirus Ebola et Marburg. *Annales de l'Institut Pasteur*: 8: 207-222, 1997

Ingold FR, Toussirt M, et C Jacob. Les modes de prévention du sida: intérêt et limites de l'utilisation de l'eau de Javel. *Bulletin de l'Académie Nationale de Médecine*: 178: 279-291, 1994

LeGuenno, B. Le point sur l'épidémie de fièvre hémorragique à virus Ebola au Gabon. *Bulletin Épidémiologique Hebdomadaire*: 3: 3, 1997

Prehaud, C et M Bouloy. La fièvre de la vallée du Rift - Un modèle d'étude des fièvre hémorragiques virales. *Annales de l'Institut Pasteur*: 8: 233-244, 1997

World Health Organization. Fièvre hémorragique à virus Ebola / Ebola haemorrhagic fever. *Weekly Epidemiological Record / Relevé Épidémiologique Hebdomadaire*: 70: 149-151, 1995

World Health Organization. Fièvre hémorragique à virus Ebola: Résumé de la flambée au Gabon / Ebola haemorrhagic fever: A summary of the outbreak in Gabon. *Weekly Epidemiological Record / Relevé Épidémiologique Hebdomadaire*: 72: 7-8, 1997

World Health Organization. Lutte contre les zoonoses. Fièvre hémorragique de Crimée-Congo / Zoonoses control. Crimean-Congo haemorrhagic fever. *Weekly Epidemiological Record / Relevé Épidémiologique Hebdomadaire*: 71: 381-382, 1996

World Health Organization. Une flambée de fièvre de la vallée du Rift en Afrique orientale, 1997-1998 / An outbreak of Rift Valley fever, eastern Africa, 1997-1998. *Weekly Epidemiological Record / Relevé Épidémiologique Hebdomadaire*: 73: 105-109, 1998

Zeller H. La fièvre hémorragique de Crimée Congo. *Annales de l'Institut Pasteur*: 8: 257-266, 1997

Index

- Accidental exposure **81-82**, 120
- Advance preparation for VHF Isolation
Precautions
Assessing readiness 116-118
In-service training 185-186
Preparing for outbreak 146-147
Staff training 118-119
Supplies checklists 41-42, 123-131, 141-142
- Burial 45, 48, 49, **97-99**
- Community mobilization 103-112
- Diagnostic testing
Laboratory testing 171-172
Skin biopsy 173, 175-179
- Disinfectants
Bleach solutions 34, 41-42, **68-71**, 128-129, 141-142, 161
Other chlorine products 161
Soapy water solution 34, 41-42, **72**, 141-142
- Disinfection
Bedding 80-81
Bedpan 76
Body of deceased patients 97-98
Boots **57**, 79
Gloved hands 73
Gloves, reusable 74
Infectious waste 78
Laundry 79
Needles and syringes
 Disposable 15-16
 Reusable 15
Patient's utensils 76
Spills 77-78
Thermometers and stethoscopes 75-76
Vehicles, after transporting bodies 99
Water, drinking and cleaning 157-159
What to disinfect 67
- Family
Role in patient care 39-40
Burial 97
- Glossary 8
- Isolation area 117
Plan 32, 143-144
Purpose 31
- Requirements 31-32
Security 37-38
Supplies 34-36
- Isolation area (changing room)
Checklist of supplies 41, 141
Sample layout 32, 33
How to set up 37
- Isolation area (patient area)
Checklist of supplies 42, 142
Sample layout 32, 33
- Posters 26, 165-169, 181-184
- Protective clothing
Making protective clothing 149-152
Order for putting on clothing 53-56
Order for taking off clothing 57-62
Purchasing protective clothing 153-155
Recommended items 45-46
 Apron 48-49
 Boots 47
 Eyewear 52
 Gloves 46, 49-50
 Gown 47-48
 Head cover 51-52
 Mask 50-51
 Scrub suit 46
Who needs to wear protective clothing 45
- Standard Precautions 11
Handwashing 12-13, 116, 133
Minimum level for your health facility 12
Disposal of sharp instruments 14-16, 133
Precautions 133-134
- Viral haemorrhagic fevers
Case definitions 145, 146
Clinical features 137, 138
Epidemiology 135-136
General 3, 119
Prevention 139
Reporting 27
Suspecting 21-23
Transmission 3, 4, 120
- VHF Coordinator
Role 18, 115-116
Selection 18, 115-116

VHF Isolation Precautions

- Adapting for a large number of patients 145-147
- Recommended precautions 17, 120
- Reducing risk of transmission 17, 25-26
- When to begin using 22, 23, 25, 26
- Who needs to use 16, 25, 117-118

Waste disposal

- Incinerator 86
- Items to be disposed of 85
- Methods 85-86
- Pit 92
- Making an incinerator 89-91
- Selecting and training staff 87-88
- Selecting site 89
- Security 93