

Roof Monitoring in Limestone Mines-Experience with the Roof Monitoring Safety System (RMSS)

Thomas E. Marshall, Engineering Technician
Lou J. Prosser, Research Physical Scientist
Anthony Iannacchione, Deputy Director
NIOSH - Pittsburgh Research Laboratory
Pittsburgh, PA

Michael Dunn, General Superintendent
Conco Western Stone Company
North Aurora, IL

ABSTRACT

During the past few years, the Pittsburgh Research Laboratory of the National Institute for Occupational Safety and Health (NIOSH) examined and characterized conditions at a majority of the underground stone mines in the United States. Observations at these mines revealed a limited degree of roof monitoring beyond visual inspection and sounding. When monitors are used, they typically require the miner to measure movement at the roof. If conditions are unstable, the miner may be in a hazardous situation while recording data. Based on this scenario, researchers surmised that a simple, inexpensive monitor with the capability of recording data at a distance from the mine roof would be a safer way to gain the information. Additionally, more widespread use of monitors could potentially lead to better understanding of roof movement in general.

A monitor to meet this need was designed, tested, and subsequently improved as experience was gained in its' use at a number of underground stone mines. The Roof Monitoring Safety System (RMSS) can provide an initial indication of movement in roof beams. By understanding and measuring roof movement in underground mines, the potential for injuries and fatalities to mine workers from falls of ground can be reduced. Also, officials at a mine with a history of data are better prepared to make a decision on remedial actions in the event of ground falls. This paper will outline the evolution of the RMSS and how it can be used in a comprehensive pro-active ground control safety program. Also included is a case history describing how the RMSS was used in an evaluation of the effectiveness of a mechanical impact scaling machine at an operating limestone mine.

INTRODUCTION

Falls of roof and rib rock are responsible for a high number of mining injuries and fatalities. Visual inspections and the sound of breaking or cracking rock are typically the most relied

upon indicators of unstable roof conditions. In some mines, roof bolt holes are checked for separations or gaps with a scratch tool providing further information about the stability of the roof. Using monitors such as the Roof Monitoring Safety System (RMSS) can confirm roof movement that was surmised only by eye or ear, or potentially detect movement that was missed by these means. An added safety feature of the RMSS is the capability of locating the measurement station at a distance from where the monitor is placed in the roof.

It must also be noted that stone, as well as other industrial minerals, are the basic raw materials used in construction. Continuing economic growth and highway building in particular have resulted in record level demand for stone. Constraints to surface mining and the availability of resources are increasing the development of new underground stone mines. These new mines, in many cases will be employing new and inexperienced miners. The knowledge and ability of experienced miners that rely on sight and sound for detection of unstable ground conditions may not exist.

MONITOR USAGE

Control of roof and rib rock under ideal conditions where competent rock exists free of high stresses, can be accomplished by following some straight forward procedures for sizing rooms and pillars (1). However, in most mining operations and as is the case in the underground stone mining sector, ideal conditions are seldom present (2). Generally, underground mines use "hands-on" information to provide a daily assessment of the general picture related to roof conditions. However, this type of knowledge can be lost through changes in employment or other circumstances. Many mines supplement visual inspections and knowledge gained through hands-on experience with various types of observational and monitoring techniques. Based on observations and discussions with personnel at 48 mines, 49 observational and monitoring techniques beyond basic visual inspections were used at 26 different mines (table 1) (3). This

suggests that additional information is useful in maintaining a ground control program.

Table 1. Number of mines using observational and monitoring techniques.

Observation or monitor type	Number of mines
Sounding	9
Observation hole	11
Wedge	5
Borescope	6
Scratch tool	4
Extensometer	2
Miner's Helper	7
Guardian Angel	4
Telltale	1

To date, observational techniques are used more than monitoring techniques. The data shows that in 14 instances mines used or have available commercial mechanical monitors such as the Miner's Helper, Guardian Angel or Telltale (figure 1).



Figure 1. Photograph of the commercially available Miners Helper, the Guardian Angel, and the RMT's Dual Height Telltale roof mechanical extensometer monitoring devices.

The scratch tool and wedge are all used as a means of detecting rock movement. The wedge and scratch tool are simple devices that typically can be fabricated from materials used at a mine site. Wedges or spikes are driven into the roof and painted or marked so as if they move it can be noticed. A scratch tool is inserted into a roof bolt or observation hole. The end of the scratch tool is bent so that as it is pushed in and out of the hole a crack or separation can, in a sense, be felt. The commercially available mechanical monitors are more sophisticated. The Miner's Helper or Guardian Angel are similar in that if roof movement occurs a reflecting flag drops from the roof line. The Telltale is used extensively in coal mines in the United Kingdom. The Telltale is a rigid bar anchored in the roof and slightly protruding from the borehole at the roof line. The protruding end is covered with different colored bands of reflective tape each indicating more pronounced movement.

Recently, at a mine in West Virginia the Miner's Helper was used to monitor stability in a main haulage road. At one station a significant increase in the rate of roof movement was measured, at another some movement occurred and at third no movement was detected. This was very helpful information, as the extent of the bad area was identified. Upon further investigation, it was found that a significant separation had developed at the 5 ft (1.52 m) bedding plane and it was in an intersection aligned with the prominent jointing, meeting all the criteria for another roof fall. It was determined the area was unsafe to use and, if it did not fall on its own in a reasonable amount of time, it would be shot down. In the meantime, the haul road was re-routed around this area (4).

Despite this one example, a relatively low number of mines use monitors. A comprehensive ground control plan not only includes the basic observational, visual and hands-on components, but also uses supplemental observational and monitoring techniques, and regularly reads, analyzes and displays information gained from these efforts. When this type of information is logged or mapped it provides a documented history of ground conditions. This information can be analyzed and prepared by either consulting firms or with in-house expertise. The availability of this information at the time of a major ground fall or when unstable geologic conditions are encountered is extremely useful in deciding a course of action or alteration of the mining plan. Mines that follow these practices and that promote open communication and participation from everyone at the site are the mines with the most pro-active approaches towards ground control safety (3).

DEVELOPMENT OF THE RMSS

The RMSS was introduced at a National Institute for Occupational Safety and Health (NIOSH) "Safety Seminar for Underground Stone Mines" in Evansville, IN, USA in December 1997. During the first half of 1998, monitors were installed at five mines—one in Illinois, three in Kentucky and one in Pennsylvania. From the initial introduction of the RMSS it was anticipated that improvements and modifications would occur, assuming that once miners and operators were exposed to the monitor suggestions would evolve. In one case, the RMSS was used to determine if an impact hammer used on a mechanical scaler was causing or increasing instability of roof rock. In another instance, an operator with high ceilings, as a result of benching needed to monitor roof stability along a haulage way. The RMSS requires a 2-in (5.08-cm) diameter hole for installation, however only roof bolt holes of a smaller diameter were available and it was impossible to drill new holes at that height. The operator attached a 2-in (5.08-cm) collar at the roof line and was able to install the RMSS. These examples illustrate the potential for even further enhancements of this tool.

Also during the first 6 months of RMSS use it became apparent from field testing that exposure to water was a problem. Monitors installed at "wet" mines were not functioning. The spur gear became locked-up thus precluding movement. As a

result of this field testing the RMSS was revamped and the inner workings were enclosed in plastic pipe. At the same time, the anchoring method was also improved and simplified to facilitate installation.

HOW THE RMSS WORKS (and when it did)

The new RMSS, cable and read-out box are shown in figure 2. The read out box has a green light that stays lit until battery replacement is needed. The red light is set to come on to indicate movement. When the red light comes on can be adjusted for increments of movement as low as 0.001 in (0.003 cm). It is important to recognize that the RMSS red light should not be considered as a primary or only means of determining the stability of roof or rib. It is intended to serve as a supplement to existing methods or procedures for determining the stability of conditions.

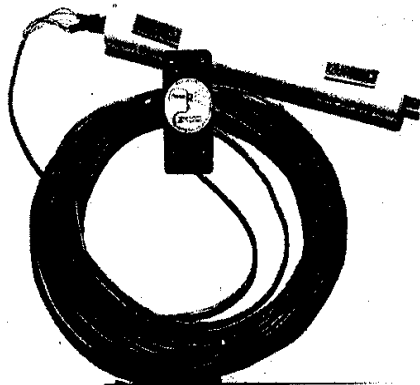

Figure 2. RMSS, cable and read-out box.

An overview of the RMSS components is shown in figure 3. When rock begins to move, shift or separate, the setting rod is affected. The setting rod which is anchored in the top of the hole moves the potentiometer as the rack and spur gear react to the movement. Movement of rock layers within the mine roof is measured relative to a fixed-point calibration at the monitor housing. The housing contains a potentiometer, roller switch, plastic rack, and spur gear. Movements are detected by the transfer of electromotive forces through the rack of the spur gear, which is attached to a 5,000-ohm potentiometer. Movement is precisely measured by comparing the output of the potentiometer to a control level calibration (set with a screw). Cable is attached to stereo plugs and extended from the roof to ground level. If the RMSS is located at an active face the cable can be unplugged during blasting and reconnected afterwards and readings can be taken. The readings are taken with a ohm meter. The monitor requires a 2-in (5.08-cm) diameter hole extending 12 to 18 ft (3.6 to 5.4 m) into the roof.

Related below is the communication that occurred pertaining to a ground fall at a mine with RMSS's installed.

"The mine foreman called today at about 9:00 am and said that the monitor (RMSS) at 39-A was showing movement that amounted to 0.255 in (0.648 cm) over two days. The Red warning light started to flash as soon as the movement occurred. The roof where the monitor was located did not look bad to the eye prior to the roof fall according to the mine foreman. He said he would danger off the area and work at some other faces since he could hear the roof working and the monitor (RMSS) showing movement. At 12:40 pm the area caved in taking the monitor (RMSS) with it. This monitor (RMSS) had a data logger attached to it which was in working order and recorded data."

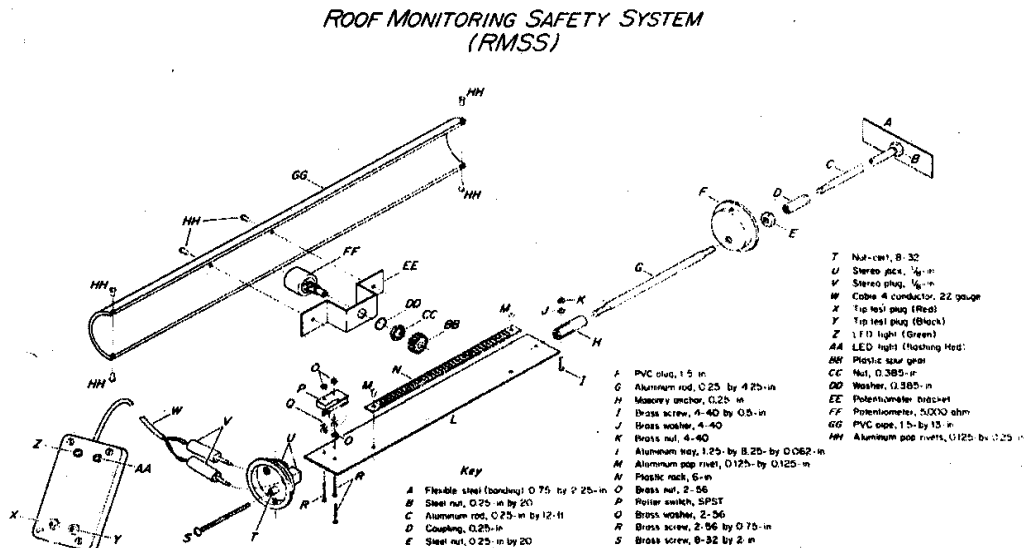

Figure 3. Overview of the Remote Monitoring Safety System (RMSS) components.

In this particular case, the RMSS performed as intended. It should be noted that sound and sight also contributed to the decisions made during this process. As in any comprehensive ground control program all elements of information are used and this time were instrumental in preventing a possible injury. Subsequent to this event another fall occurred. This time, however the results were the reverse. A RMSS located near this fall area was slightly too far away and the red light indicator did not trigger. It is important to remember that the RMSS or any monitor will not show movement if the rock layer it is anchored in does not move. Fortunately, the sound of breaking rock and recent history of falls in this section of the mine provided sufficient warning and the area was inactive at the time of the fall. Again the key to a comprehensive ground control program is combining all elements of information.

DATA ANALYSIS

To read the RMSS, a multimeter is required. Multimeters come in a variety of price ranges depending on resolution and accuracy and built-in functions. The most important factors in choosing a meter for this application are the meter resolution and accuracy. Resolution (or precision) is the ability of the meter to resolve a change in resistance; accuracy indicates how close the measurement is to the true resistance. Generally, meter resolution is better than meter accuracy, but fortunately the resolution is more important to making a measurement, provided that the same meter (or meters) is used to make all the measurements from a single RMSS. Several meters between 100 and 350 dollars were purchased and, as might be expected, the resolution and accuracy of the meters were generally proportional to their price. The low-cost meters had resolutions and accuracies in the range of 2 ohms and 0.5%, respectively; the highest priced meters sampled had resolutions and accuracies in the range of 0.1 ohms and 0.07%, respectively. A resolution

of 1 ohm represents the ability to resolve approximately 0.004 in (0.01 cm) of movement.

The best resolution and accuracy are usually found in the portion of the meter range above 1,000 ohms and below meter midrange; this can vary, however, with meter type, and meter specifications should be carefully read so that instruments can be set to take advantage of the meter's most accurate range. The minimum meter resolution and accuracy acceptable for use with the RMSS are 1 ohm and 0.2%, respectively. This means that the minimum cost for an acceptable meter for RMSS use can be expected to be about \$200.

To measure and record sag, two graphs and a data sheet must be kept. These are:

1. *Data Sheet* - Record of readings of the monitor, with times and dates (figure 4).
2. *Resistance Conversion Chart* - Converts multimeter resistance readings to sag (figure 5).
3. *Sag Graph* - Plot of sag versus time (figure 6).

Careful detailed records are essential for effective use of the roof monitor. The following information should be included on the Resistance Conversion Chart and on the Data Sheet:

- Monitor identification number.
- Monitor location.
- Date and time of monitor installation.
- Model and serial number of the multimeter used to make the measurement.

In addition all other data collected such as gaps detected with a scratch tool and other observations about conditions should be included with these records.

Instrument No. _____ Installation date _____ Depth of anchor _____
 Mine _____ Multimeter type _____
 Location _____

Date	Resistance	Sag, inches	Date	Resistance	Sag, inches

Figure 4. Data sheet.

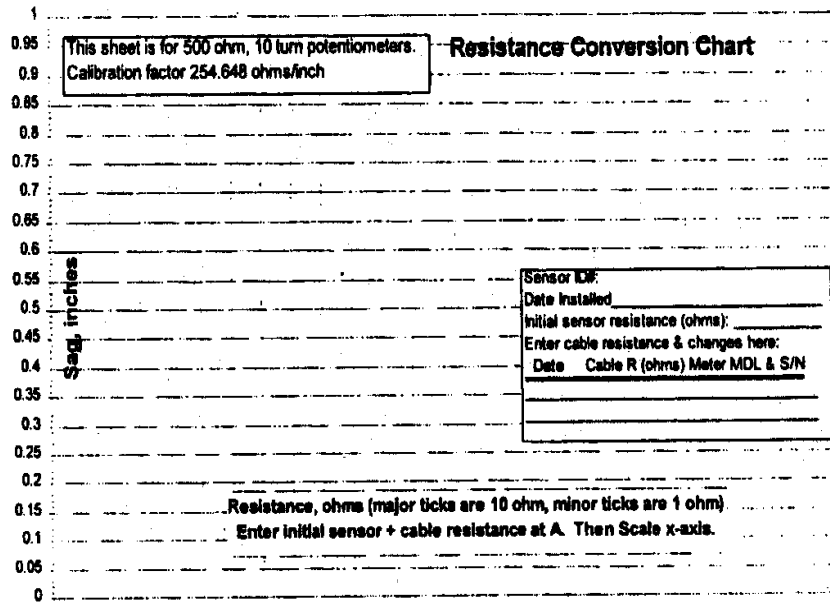

A

Figure 5. Resistance conversion chart.

Initial Resistance Measurements

Proper resistance measurements must also be recorded on the Resistance Conversion Chart immediately after the monitor is installed. The following readings are required:

- Monitor resistance - before the wire(s) are connected.
- Total resistance - after the wire(s) are connected, including wires and monitor.
- Wire resistance - computed from the difference of the total and monitor resistances.

To begin data collection, connect multimeter to wire leads on RMSS to read monitor resistance. Then connect wires to the monitor and connect the multimeter to the end of the wires to obtain the total resistance.

Initial Chart Layout

Before the Resistance Conversion Chart can be used to convert resistance to sag, it must be scaled for each individual monitor. The procedure is as follows:

- Write the total resistance from the first monitor reading at the left side of the horizontal axis of the chart (at the point marked A). For this demonstration, use 1,204 ohms.
- Write in the resistances as shown on the horizontal axis label. Each major tick mark on the chart represents 10 ohms; each minor tick mark represents 1 ohm for a 5,000-ohm potentiometer.

If the initial total resistance is 1,204 ohms, the large divisions on the horizontal axis will read 1,204, 1,214, 1,224, etc.

Conversion of Resistance to Sag

This process converts resistance readings to measurements of movement or sag of roof.

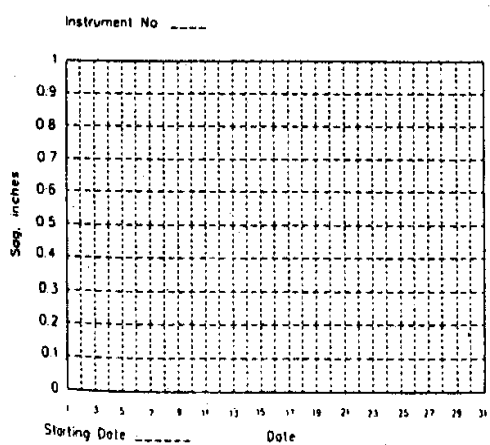

Figure 6. Sag graph.

1. The multimeter is connected to the monitor wires and the resistance is then read.
2. On the data sheet, record the time, date, multimeter model and serial number, and the resistance reading.
3. The resistance readings are converted to a sag by finding the resistance on the horizontal axis of the Resistance Conversion Chart, moving up the chart perpendicular to the horizontal axis to the diagonal line, and then moving left to the vertical axis. The number on the vertical axis is the sag in inches.
4. Enter the sag on the data sheet.
5. Plot the sag on the sag versus time graph.

NOTE: If the wire is shortened, added to, or replaced, the change should be noted, a measurement of the new cable resistance made, and the new resistance recorded on the Resistance Conversion Chart. Wire resistance may be determined by shorting the two cable wires together at the monitor and reading the resistance of those two wires at the other end of the cable. The new wire resistance is the resistance of both wires (5).

MECHANICAL SCALING EXPERIMENT

As mentioned previously, an operator used the RMSS to devise an experiment to determine the affect on roof conditions when using an mechanical impact scaler. A summary of that test is outlined below.

Mechanical scaling has dramatically improved underground mine safety over the last two decades. Two types of mechanical scalers include a prying pick design and a hydraulic impact hammer. Their effectiveness is high although some operators say they are easy to "mine" with or may do more roof damage by creating cracks and causing falls.

To help assess any potential harm to the roof, a test was undertaken using the NIOSH developed RMSS and a hydraulic impact hammer. This procedure allowed the collection of real-time rock movement data during the scaling operation. The experiment was designed to quantify rock movement induced by a mechanical impact hammer used for scaling in an underground mine. A RMSS was installed in a 2-in (5.08-cm) diameter vertical drill hole 14 ft (4.2 m) deep. A newly blasted face requires some degree of scaling to stabilized the area before mining can continue. This can be done by hand with a scaling bar or by mechanical means with an impact hammer or a pick, shown in figures 7 and 8. The pick type machine uses leverage to pry loose rock from the roof. The chassis is rubber-tire-mounted for easy mobility. These machines are often used as "battering rams" where loose rock is difficult to pry free. Where the pick is applied is the only area where rock falls, making more frequent setups than with a hydraulic hammer whose energy

usually causes loose rocks to fall in and around the vicinity of the scaling.

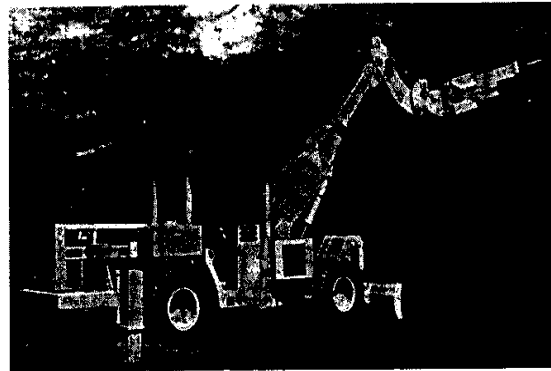

Figure 7. Hammer-type scaler.

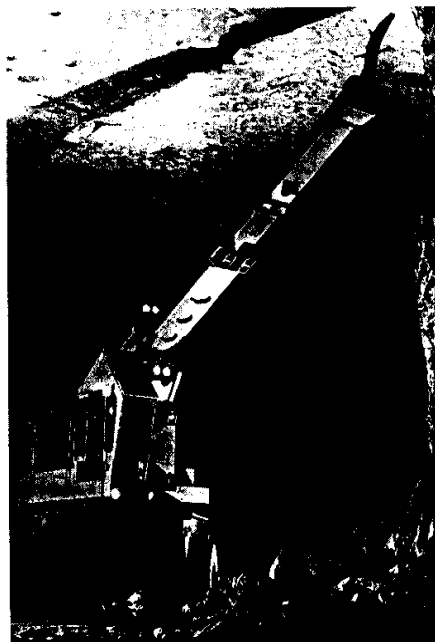

Figure 8. Pick-type scaler.

The scaling hydraulic hammer is identical to those used to break boulders in quarries or in crusher feeders, only a smaller scale, usually. These hammers can be mounted on track excavators or rubber tired units when used underground. Hammer differences, other than internal design, reflect either a high-energy low frequency (blows per minute) or lower energy higher frequency breaking philosophy. These hammers are rated by class relative to ft-pounds; classes range from 175 to 11,000 ft-pounds.

This experiment was conducted in an underground dolomite mine at a depth of 257 ft (78.3 m) below the surface with a 1,500-ft-pound class hammer. A RMSS was installed in the center of a 36-ft (10.8-m) wide drift in a 2-in (5.08-cm) hole

drilled 14 ft (4.2 m) into the roof. This roof acts as a sill between two mine levels, having a thickness of 26 ft (7.9 m). Figure 9 shows the monitor's location relative to 5-ft (1.5-m) mechanical anchor roof bolts at 5- to 6-ft (1.5- to 1.8-m) spacing. The figure also shows the bedding planes intercepted by these bolts.

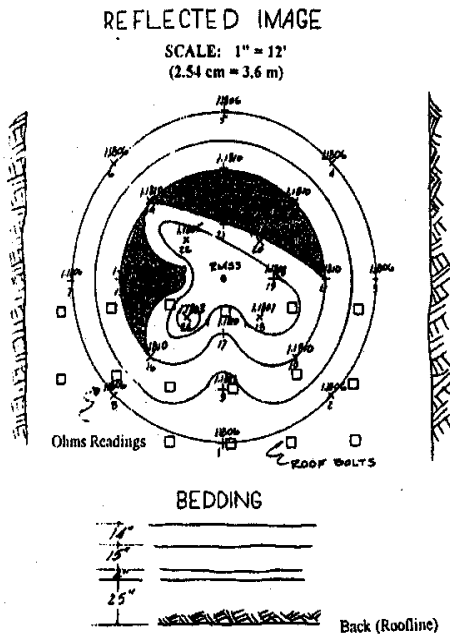

Figure 9. Monitor location.

Twenty-four test points were marked on the roof emanating radially from the RMSS at about 5-ft (1.5-m) centers (figure 9). While the hammer was hitting each point, ohms were read on the RMSS. These data were plotted for each location relative to the initial RMSS reading and a contour map based on the ohms read was generated. The increase in ohms, used to measure rock movement was so low, however, that rock movement was negligible. The conversion rate is 254.648 ohms to about 1 in (2.54 cm) of movement. The maximum ohms read was 0.0004 during the test.

As expected, the roof movement increased as the hammering grew closer to the RMSS. In this location, roof bolts had no positive effect, as rock movement was nearly uniform independent of bolt location. The final reading at steady state (no hammering) was 1.1804 K Ω 0.0002, or 0.2 ohms less than initial. This could be due to the connection of the ohm meter to the cable during readout. Also when reading such low level resistance some slight deviation is not uncommon. It is also possible but not likely that the RMSS slipped slightly in the hole; however, this small difference has little impact on the results. (Slippage has not occurred at other field sites even a year after installation.) Finally, the roof was inspected closely for cracks; none were found.

It seems that a properly sized hammer can scale a mine roof with minimal adverse impact. For completeness, the test should be repeated with a much larger hammer.

SUMMARY

The RMSS is intended to serve as an engineering tool that will improve safety by better understanding of roof behavior. An understanding of the complex behavior associated with roof and rib instabilities is expected to provide a method for developing the "safest" decisions in concert with the existing mining practice. This proactive strategy allows for a quick and timely response in relation to existing conditions.

A critical point to realize is that hazardous roof beam sag is dependent on site-specific geologic, stress, and mining characteristics. Therefore, use of the RMSS or any type of monitor must be suited for local conditions. There are also many technical issues that need to be further addressed, such as: (1) what are critical sag rates, (2) how much sag occurs prior to a roof fall, (3) at which locations in the roof does the failure occur, (4) how often should monitors be read, (5) where should monitors be placed within the entry, (6) when should monitors be used, and (7) how should the monitor data be analyzed? If enough site-specific information is collected, then general guidelines can be established and a meaningful safety tool will have been developed. The only way this can occur is if industry, mine workers, and Government work together to gain the required data and knowledge.

The NIOSH's Pittsburgh Research Laboratory will attempt, as resources allow, to assist the end users in utilizing this technology.

REFERENCES

1. Obert L, Duvall WI. Rock Mechanics and the Design of Structures in Rock. John Wiley and Sons, Inc., New York, NY, 1967, pp. 638.
2. Parker J. Everything Goes Underground Eventually. *Aggregates Manager*, June 1996, pp. 30-35.
3. Iannacchione AT, Prosser LJ, Grau III RH, Oyler DC, Dolinar DR, Marshall TE, Compton CS. Preventing Injuries Caused by Unrecognized Stone Mine Roof Beam Failure with a Pro-Active Roof Control Plan. SME preprint 99-87. Littleton, CO: Society for Mining, Metallurgy, and Exploration, Inc., 1999, 9 pp.
4. Aggman. Operations Section, January 2000. <http://www.aggman.com/pages/agg%200100/Operationa0100.html>, 2000.
5. Iannacchione AT, Prosser LJ, Marshall TE, Compton CS, Dolinar DR, Oyler DC, Pappas DM. An Instruction Booklet for the Remote Monitoring Safety System (RMSS). National Institute for Occupational Safety and Health Internal Publication, Dec. 10, 1997, 21 pp.