

INVESTIGATION OF THE CHALLENGER ACCIDENT (Volume 1)

HEARINGS BEFORE THE COMMITTEE ON SCIENCE AND TECHNOLOGY HOUSE OF REPRESENTATIVES NINETY-NINTH CONGRESS SECOND SESSION

JUNE 10, 11, 12, 17, 18, 25, 1986

[No. 137]

Printed for the use of the
Committee on Science and Technology



U.S. GOVERNMENT PRINTING OFFICE

64-295 O

WASHINGTON : 1986

For sale by the Superintendent of Documents, Congressional Sales Office
U.S. Government Printing Office, Washington, DC 20402

COMMITTEE ON SCIENCE AND TECHNOLOGY

DON FUQUA, Florida, *Chairman*

ROBERT A. ROE, New Jersey
GEORGE E. BROWN, Jr., California
JAMES H. SCHEUER, New York
MARILYN LLOYD, Tennessee
TIMOTHY E. WIRTH, Colorado
DOUG WALGREN, Pennsylvania
DAN GLICKMAN, Kansas
ROBERT A. YOUNG, Missouri
HAROLD L. VOLKMER, Missouri
BILL NELSON, Florida
STAN LUNDINE, New York
RALPH M. HALL, Texas
DAVE McCURDY, Oklahoma
NORMAN Y. MINETA, California
MICHAEL A. ANDREWS, Texas
BUDDY MacKAY,** Florida
TIM VALENTINE, North Carolina
HARRY M. REID, Nevada
ROBERT G. TORRICELLI, New Jersey
RICK BOUCHER, Virginia
TERRY BRUCE, Illinois
RICHARD H. STALLINGS, Idaho
BART GORDON, Tennessee
JAMES A. TRAFICANT, Jr., Ohio

MANUEL LUJAN, Jr.,* New Mexico
ROBERT S. WALKER, Pennsylvania
F. JAMES SENSENBRENNER, Jr.,
Wisconsin
CLAUDINE SCHNEIDER, Rhode Island
SHERWOOD L. BOEHLERT, New York
TOM LEWIS, Florida
DON RITTER, Pennsylvania
SID W. MORRISON, Washington
RON PACKARD, California
JAN MEYERS, Kansas
ROBERT C. SMITH, New Hampshire
PAUL B. HENRY, Michigan
HARRIS W. FAWELL, Illinois
WILLIAM W. COBEY, Jr., North Carolina
JOE BARTON, Texas
D. FRENCH SLAUGHTER, Jr., Virginia
DAVID S. MONSON, Utah

HAROLD P. HANSON, *Executive Director*
ROBERT C. KETCHAM, *General Counsel*
REGINA A. DAVIS, *Chief Clerk*
R. THOMAS WEIMER, *Republican Staff Director*

CHALLENGER ACCIDENT REPORT STAFF TASK GROUP

ROBERT C. KETCHAM, *General Counsel*
RADFORD BYERLY, Jr.
RONALD E. WILLIAMS
PATRICIA G. GARFINKEL
CAROLYN C. GREENFELD
DAVID D. CLEMENT
SHIRLEY J. WATSON

ROBERT E. PALMER
GEORGE S. KOPP
HARRY S. DAWSON, Jr.
HARRIET J. SMITH
NELSON L. MILDER
CAROLYN J. RADABAUGH
JAMES PAUL
GLORIA J. DUNDERMAN

*Ranking Republican Member.

**Serving on Committee on the Budget for 99th Congress.

CONTENTS

WITNESSES

	Page
June 10, 1986:	
Hon. William P. Rogers, Chairman, Presidential Commission on the Space Shuttle Challenger Accident, accompanied by Neil Armstrong, Vice Chairman.....	24
June 11, 1986:	
Dr. James C. Fletcher, Administrator, NASA.....	114
Rear Adm. Richard H. Truly, U.S. Navy, Associate Administrator for Space Flight, NASA.....	123
June 12, 1986:	
Dr. James C. Fletcher, Administrator, NASA; Rear Adm. Richard H. Truly, Associate Administrator for Space Flight, NASA; Arnold D. Aldrich, Manager, National Space Transportation System, NASA; J. R. Thompson, Vice Chairman, NASA Task Force, NASA; representatives from NASA's Task Teams: Dan Germany, Thomas Holloway, Jack Lee, John Thomas, Thomas Utsman, Col. Edward O'Connor, USAF.....	218
June 17, 1986:	
Charles S. Locke, chairman of the board and chief executive officer, Morton Thiokol, Inc.; U. Edwin Garrison, president, Aerospace Group, Morton Thiokol, Inc.; Joseph C. Kilminster, vice president, Morton Thiokol, Inc.; Carver G. Kennedy, vice president, space booster programs, Morton Thiokol, Inc.; Allan J. McDonald, director, SRM Verification Task Force; Roger M. Boisjoly, staff engineer; and Arnold R. Thompson, supervisor, structures design, Morton Thiokol, Inc.....	326
Dr. William R. Graham, Deputy Administrator, NASA, accompanied by Thomas Moser, Deputy Administrator, Office of Space Flight and Rear Adm. Richard H. Truly, Associate Administrator for Space Flight.....	390
Dr. William Lucas, Director, Marshall Space Flight Center, accompanied by J. Wayne Littles, Deputy Director of Science and Engineering, Lawrence Mulloy, Assistant to the Director for Science and Engineering, Gerald W. Smith, Manager, Solid Rocket Booster Project, Stan Reinartz, Manager, Special Projects Office, and Bill Sneed, Assistant Director, Policy and Review.....	391
June 18, 1986:	
U. Edwin Garrison, president, Aerospace Group, Morton Thiokol Co.; Joseph C. Kilminster, vice president; Carver G. Kennedy, vice president, Space Booster Program; Allan J. McDonald, director, SRM Verification Task Force; Roger M. Boisjoly, staff engineer; and Arnold R. Thompson, supervisor, Structures Design.....	484
June 25, 1986:	
Maj. Donald "Deke" K. Slayton, USAF (retired); Brig. Gen. James A. McDivitt, USAF (retired); Capt. John W. Young, USN (retired); Col. Henry W. Hartsfield, Jr., USAF (retired); and Comdr. Robert L. Gibson, USN; Lt. Gen. Thomas Stafford.....	544

APPENDIXES

June 11:	
1. Letter from Congressman Scheuer to Congressman Roe report on probability estimates for space shuttle failure—July 15, 1986.....	625
2. Response to additional questions submitted to NASA from Congressman Roe.....	628

IV

	Page
June 12:	
1. Letter from NASA to Congressman Roe clarification of Dr. Fletcher's testimony on June 12-August 5, 1986	660
2. Material requested for the record by Mr. Roe at June 12 hearing—presentations of members of NASA's task teams	662
3. Response to additional questions submitted to NASA from Congressman Roe.....	754
June 18:	
1. Response to additional questions submitted to Morton Thiokol from Congressman Roe.....	758

INVESTIGATION OF THE CHALLENGER ACCIDENT

(Volume 1)

TUESDAY, JUNE 10, 1986

HOUSE OF REPRESENTATIVES,
COMMITTEE ON SCIENCE AND TECHNOLOGY,
Washington, DC.

The committee met, pursuant to notice, at 9:38 a.m., in room 2318, Rayburn House Office Building, Hon. Robert A. Roe (acting chairman of the committee) presiding.

Mr. ROE [acting chairman]. Good morning, ladies and gentlemen. The House Science and Technology Committee will now convene.

And, without objection, television broadcasts, radio broadcasts, still photography, or other means of coverage will be permitted during the full committee hearings this week on the Rogers Commission report.

Today the House Science and Technology Committee begins an intensive series of congressional hearings into the causes and the ramifications of a great national tragedy—the explosion of the space shuttle *Challenger* and the loss of seven true American heroes.

These hearings will take a three-pronged approach. First, we will look at the technology and the hardware that caused the accident. Second, we will closely examine the management problems and decisionmaking problems within NASA. And the last focus of our hearings, and perhaps the most important phase, will deal with the future of our Nation's space program, and the question we must answer is "Where do we go from here?"

The Presidential Commission on the Space Shuttle Accident has made its report to the American people. The distinguished Chairman of the Commission, the Honorable William P. Rogers, whom we will hear from shortly, has done an outstanding job in presenting to the Nation a remarkable document which fully, truly details the entire story of the failures in technology and human error that ultimately led to the shuttle disaster.

I would like to take this opportunity to congratulate Chairman Rogers and the other members of his Commission for a job well done.

It is not the intention of this committee to simply rehash what the Rogers Commission has so ably accomplished. We must instead utilize the Rogers report as the basis for a new start in America's space efforts.

I would like to quote from the Commission's concluding thought, and I quote:

The commission urges that NASA continue to receive the support of the administration and the nation. The agency constitutes a national resource that plays a critical role in space exploration and development. * * * The findings and recommendations presented in this report are intended to contribute to the future NASA successes that the Nation both expects and requires as the 21st century approaches.

It is very clear that because of its great success story Congress has been too shy in finding fault with NASA. As the result of the *Challenger* accident, Congress and NASA must begin a new era, one in which Congress must apply the same strong oversight to NASA that it does to any other Government agency.

There can be no doubt that we are at a critical turning point in our space program. The *Challenger* accident combined with the recent failures of our Titan and Delta rocket systems has raised deep concern and some doubts as to what the future holds for us.

The central theme, again, of these hearings must be, Where do we go from here? The Rogers Commission has answered the basic question of what happened to the *Challenger*. But it also leaves many other cogent questions unanswered: Do we need a new fourth orbiter or a space station? Should future space efforts be centered on unmanned rather than manned flights? What needs to be done to get us back on track?

I think it is basically clear that when we discuss where this country is going in space, we are talking about the very future of our potential growth in science, technology, national security, and communications. These and other key areas will be affected by how we respond to these recent failures.

It is the intent of these hearings to uncover some of the answers to lead us back to our role of supremacy in space and the advancements of high technology associated with that leadership to the future benefit of all mankind.

The Chair now recognizes the distinguished chairman of the Science and Technology Committee, the Honorable Don Fuqua from the State of Florida.

Mr. FUQUA. Thank you, Mr. Roe, and for your remarks.

And I want to join you in praising the work of the Commission. I believe that the investigation will serve as a model for its thorough and comprehensive and deliberate approach to a most difficult undertaking.

And to the chairman, Secretary Rogers, and Vice Chairman Armstrong, both of you can take great pride in your leadership and that of the Commission in producing an inclusive report. The Nation is still suffering from the effects of a very terrible tragedy, but I believe that your report will stand the test of time.

As a member of this committee, I have been involved in the development of NASA programs for the past 24 years. And, consequently, it's especially painful for me to participate in a hearing such as this today. I have witnessed the joys and the triumphs of all the manned spaceflight programs and suffered through the tragedy of the Apollo 204 fire and now the space shuttle mission designated as 51-L. To say the least, it has been a roller coaster of emotions. But through the analysis of what went wrong in the

Apollo fire, we found the confidence and fortitude to go forward with that historymaking program.

We're now again facing the test of what direction this Nation takes in its future manned spaceflight programs. I am confident that the Congress, with the support of the American people, will make the right decisions.

The Commission report is bluntly critical. It is an indictment of both management and technical arrogance brought about by the mindset caused by a period of spectacular successes. If we fail to remind ourselves that space is a very hostile environment, to be conquered only by constant vigilance and continuing attention to detail, we will again someday have another catastrophic failure. We in Congress, as well as NASA and the aerospace industry, must never again be lulled into a sense of overconfidence that could contribute to such a tragedy. While history does not repeat itself, unfortunately people can repeat history.

And so I suggest today a new beginning, a new era in the history of NASA, one that does not forget the past but profits from it to build on a stronger space program. After the Apollo fire, we accepted the fact that we had erred and we conquered those problems and made NASA a much stronger institution.

We must and will make the changes necessary to come out of this tragedy with a better and stronger program. And to do otherwise is to shirk our responsibility and commitment to those seven brave individuals who gave their lives in pursuit of our national goal.

Thank you, Mr. Chairman.

Mr. ROE. I thank the distinguished chairman.

The Chair now recognizes the distinguished ranking minority member, the Honorable Manuel Lujan from New Mexico for an opening statement.

Mr. LUJAN. Thank you, Mr. Chairman.

Chairman Fuqua and Chairman Roe, I welcome this report, and I congratulate Chairman Rogers and Vice Chairman Armstrong on the way in which they conducted their investigation and set forth their findings. They've been tough and fair at a time when both were called for.

I would also like to compliment each of the other commissioners and staff members on their individual contributions and dedication to this effort. They have fulfilled the mandate given them by President Reagan with great dedication in a highly compressed time period while under enormous pressure. All have done an admirable job in accomplishing a very difficult task.

On the surface the Commission's conclusions appear devastating to those who thought that our space agency could do no wrong. While the Commission's words are strong and its criticism of NASA blunt, I believe its findings will ultimately be constructive in nature. Because the scope of the Commission's mandate was limited to investigating the cause of the accident and related safety issues, it necessarily left many of the basic policy questions unanswered.

It is now this committee's responsibility to address those broader issues. In the weeks and months ahead we will call on NASA and its contractors to fully respond to our questions. We must continue

to investigate this accident and the full range of operational, management, and policy issues it raises.

Our work will not be complete until we're fully satisfied with the answers we get. We must continue to probe until we're sure that the chain of events which led to this tragedy will never again be repeated. NASA, its contractors, and outside experts will all have an opportunity to add their views.

As a committee, we must conduct our investigation with an open mind. Our hearings must be honest, frank, and fair, but we will draw our own independent conclusions. Should we find evidence of mismanagement, poor judgment, or even negligence, we must take appropriate action.

In the future we must never allow the previous successes of our space program to breed overconfidence. As a committee, we may have been too trusting in the past when NASA gave us glowing, optimistic reports about our space program. Hindsight suggests that NASA's view of the space shuttle program was not realistic.

This Nation cannot abandon its space program. The *Challenger* accident and its aftermath mark a new beginning, not an end. In the past 4 months this Nation has lived through a very difficult time. The time has now come for all of us to put the national nightmare of *Challenger* behind us. Seven brave men and women who reached for the stars, in the words of the poem, "touched the face of God" deserve no less.

Thank you very much, Mr. Chairman.

Mr. ROE. I thank the gentleman from New Mexico.

In view of the limited amount of time, without objection, all remaining opening statements of the members will be included in the record at this point.

[The prepared opening statements by members of the committee follow:]

Statement of
Hon. Bill Nelson
June 10, 1986

Now that the Presidential Commission on the Space Shuttle Challenger Accident has completed its work, it is time for the Congress to begin its efforts to grasp the causes of the accident and to determine what hardware and management changes should be made in the program.

I believe that the Rogers Commission has done an excellent job and that their report provides us with a firm basis to begin our investigation into the matter.

In the 24 successful flights prior to the accident, the Space Shuttle demonstrated what a marvelous and invaluable tool it can be in helping this country develop and use space for the benefit of all mankind.

It is now clear, however, that engineering and management mistakes have been made in the Shuttle program. Our task, therefore, is to pinpoint where in the program these mistakes originated and then to work closely with NASA to ensure that all of these problems are fully corrected so that the Space Shuttle can return safely to flight operations and resume making its valuable contributions to the American space program.

OPENING STATEMENT
BY
HON. MANUEL LUJAN, JR. (R-N.M.)

RANKING REPUBLICAN MEMBER

COMMITTEE ON SCIENCE AND TECHNOLOGY
AT THE PRESENTATION OF THE
REPORT OF THE PRESIDENTIAL COMMISSION ON THE
CHALLENGER ACCIDENT

JUNE 10, 1986

CHAIRMAN FUGUA AND CHAIRMAN ROE, I WELCOME THIS REPORT. I CONGRATULATE CHAIRMAN ROGERS AND VICE CHAIRMAN ARMSTRONG ON THE WAY IN WHICH THEY HAVE CONDUCTED THEIR INVESTIGATION AND SET FORTH THEIR FINDINGS. THEY HAVE BEEN TOUGH AND FAIR AT A TIME WHEN BOTH WERE CALLED FOR. I WOULD ALSO LIKE TO COMPLIMENT EACH OF THE OTHER COMMISSIONERS AND STAFF MEMBERS ON THEIR INDIVIDUAL CONTRIBUTIONS AND DEDICATION TO THIS EFFORT. THEY HAVE FULFILLED THE MANDATE GIVEN THEM BY PRESIDENT REAGAN WITH GREAT DEDICATION IN A HIGHLY COMPRESSED TIME PERIOD WHILE UNDER ENORMOUS PRESSURE. ALL HAVE DONE AN ADMIRABLE JOB IN ACCOMPLISHING A VERY DIFFICULT TASK.

ON THE SURFACE, THE COMMISSION'S CONCLUSIONS APPEAR DEVASTATING TO THOSE WHO THOUGHT OUR SPACE AGENCY COULD DO NO WRONG. WHILE THE COMMISSION'S WORDS ARE STRONG AND ITS CRITICISM OF NASA IS BLUNT, I BELIEVE ITS FINDINGS WILL ULTIMATELY BE CONSTRUCTIVE IN NATURE, BECAUSE THE SCOPE OF THE COMMISSION'S MANDATE WAS LIMITED TO INVESTIGATING THE CAUSES OF THE ACCIDENT AND RELATED SAFETY ISSUES. IT NECESSARILY LEFT MANY BASIC POLICY QUESTIONS UNADDRESSED. IT IS NOW THIS COMMITTEE'S RESPONSIBILITY TO ADDRESS THOSE BROADER ISSUES.

IN THE WEEKS AND MONTHS AHEAD, WE WILL CALL ON NASA AND ITS CONTRACTORS TO FULLY RESPOND TO OUR QUESTIONS. WE MUST CONTINUE TO INVESTIGATE THIS ACCIDENT AND THE FULL RANGE OF OPERATIONAL, MANAGEMENT AND POLICY ISSUES IT RAISES. OUR WORK WILL NOT BE COMPLETED UNTIL WE ARE FULLY SATISFIED WITH THE ANSWERS WE GET. WE MUST CONTINUE TO PROBE UNTIL WE ARE SURE THAT THE CHAIN OF EVENTS WHICH LED TO THIS TRAGEDY WILL NEVER AGAIN BE REPEATED. NASA, ITS CONTRACTORS AND OUTSIDE EXPERTS WILL ALL HAVE AN OPPORTUNITY TO AIR THEIR VIEWS.

AS A COMMITTEE, WE MUST CONDUCT OUR INVESTIGATIONS WITH AN OPEN MIND; OUR HEARINGS MUST BE HONEST, FRANK AND FAIR. BUT WE WILL DRAW OUR OWN INDEPENDENT CONCLUSIONS. SHOULD WE FIND EVIDENCE OF MISMANAGEMENT, POOR JUDGMENT OR EVEN NEGLIGENCE, WE MUST TAKE APPROPRIATE ACTION.

IN THE FUTURE, WE MUST NEVER AGAIN ALLOW THE PREVIOUS SUCCESSES OF OUR SPACE PROGRAM TO BREED OVERCONFIDENCE. AS A COMMITTEE, WE MAY HAVE BEEN TOO TRUSTING IN THE PAST WHEN NASA GAVE US GLOWING, OPTIMISTIC

REPORTS ABOUT OUR SPACE PROGRAM. HINDSIGHT SUGGESTS THAT NASA'S VIEW OF THE SPACE SHUTTLE PROGRAM WAS NOT REALISTIC.

THIS NATION CANNOT ABANDON ITS SPACE PROGRAM. THE CHALLENGER ACCIDENT AND ITS AFTERMATH MARK A NEW BEGINNING, NOT AN END. IN THE PAST FOUR MONTHS, THIS NATION HAS LIVED THROUGH A VERY DIFFICULT TIME. THE TIME HAS NOW COME FOR ALL OF US TO PUT THE NATIONAL NIGHTMARE OF THE CHALLENGER BEHIND US. THE SEVEN BRAVE MEN AND WOMEN WHO REACHED FOR THE STARS AND--IN THE WORDS OF THE POEM--"TOUCHED THE FACE OF GOD" DESERVE NO LESS.

THANK YOU.

OPENING REMARKS OF
REPRESENTATIVE ROBERT S. WALKER
RANKING REPUBLICAN MEMBER
SUBCOMMITTEE ON SPACE SCIENCE
AND APPLICATIONS
UNITED STATES HOUSE OF REPRESENTATIVES

JUNE 10, 1986

Good morning, Mr. Chairman. This morning marks a tragic day for the committee and for the nation. Just over four months ago the people of the world were shocked to see the space shuttle Challenger lost with her crew of seven gallant Americans.

Today we begin the difficult duty of reviewing the work of the Rogers Commission to determine if we do, in fact, fully understand the cause of the Challenger accident. Once we satisfy ourselves that we understand exactly what happened, and why, then this committee will have to determine what our national policies will be in the wake of that disaster.

I must say that it appears that the Rogers Commission has done an excellent job and has set a new standard for Presidential Commissions. Considering the complexity of the Space Transportation System it was a major accomplishment for this commission to move as rapidly as they did to conduct a major investigation which isolated the field joint of the right SRB as the sole cause of this accident.

From a technical point of view I believe that we can be assured that the findings of the Commission are correct. I also fully support the recommendations of the Commission.

Specifically, I fully endorse the recommendations to:

- * Redesign the field joints;
- * Restructure management to be more responsive;
- * Review fully the Critical Items List;
- * Establish a meaningful safety organization; and
- * Reduce the tremendous pressure on flight rates.

Mr. Chairman, NASA is an agency that has given this nation some of our most remarkable technical achievements. I have great confidence that we can solve the problems that caused this tragic accident. As we learned last week at the

Kennedy Space Center, the technical solutions are ones that we can resolve without too much difficulty. It will take time and money to fully understand the mechanics of the SRB joints, and to design a joint that we will all have confidence in. But we can clearly meet that requirement.

On the other hand, Mr. Chairman, it appears to me that some of the management difficulties that this commission has identified will take some time to resolve. Our Subcommittee on Space Science and Applications has already undertaken a major series of oversight hearings on some of these management issues. I am particularly concerned with the lack of an effective organization within the agency to guard safety, reliability and quality assurance. There are indications other than the Challenger accident that lead me to believe that this is an area of major concern.

Mr. Chairman, I would like to commend Secretary Rogers, and the members of his commission, for a remarkable job which was accomplished under very trying circumstances. He has given us some clear guidelines which indicate the areas which we will have to concentrate on in the coming weeks.



OPENING STATEMENT

HON. F. JAMES SENSENBRENNER, JR.

FULL COMMITTEE HEARING

JUNE 17, 1986

THANK YOU, MR. CHAIRMAN, FOR THIS OPPORTUNITY TO MAKE AN OPENING STATEMENT.

FIRST, I WELCOME MR. ROGERS AND MEMBERS OF THE COMMISSION WHO DILIGENTLY SERVED OUR COUNTRY IN THIS TIME OF NATIONAL TRAGEDY. THE COMMISSION HAS SET A NEW STANDARD OF EXCELLENCE IN CONDUCTING THIS COMPREHENSIVE INVESTIGATION OF THE CHALLENGER ACCIDENT. THE COMMISSION REPORT WAS PENETRATING, OBJECTIVE, AND CONCLUSIVE AS WELL AS PROMPTLY DELIVERED.

I THINK THE COMMISSION HAD THE PROPER OBJECTIVE WHICH WAS TO PREVENT ANY RECURRENCE OF THE FAILURE RELATED TO THIS ACCIDENT AND ALSO TO REDUCE OTHER RISKS IN FUTURE FLIGHTS. FROM THESE FINDINGS, I HOPE WE LEARN FROM OUR MISTAKES AND MOVE AHEAD TO OUR FAMILIAR POSITION AS THE WORLD'S LEADER IN SPACE. AS RONALD REAGAN SAID WHEN REFERRING TO THE CHALLENGER ACCIDENT "THE FUTURE IS NOT FREE: THE STORY OF ALL HUMAN PROGRESS IS ONE OF A STRUGGLE AGAINST ALL ODDS. WE LEARNED AGAIN THAT THIS AMERICA, WHICH ABRAHAM LINCOLN CALLED THE LAST, BEST HOPE OF MAN ON EARTH, WAS BUILT ON HEROISM AND NOBLE SACRIFICE. IT WAS BUILT BY MEN AND WOMEN LIKE OUR SEVEN STAR VOYAGERS, WHO ANSWERED A CALL BEYOND DUTY, WHO GAVE MORE THAN WAS EXPECTED OR REQUIRED AND WHO GAVE IT

LITTLE THOUGHT OF WORLDLY REWARD." MR. CHAIRMAN, THE ONLY FITTING TRIBUTE TO THE CREW OF SEVEN AND THEIR FAMILIES IS TO MOVE AHEAD TO FUTURE CHALLENGES IN SPACE.

OPENING STATEMENT
HON. SHERWOOD BOEHLERT (R-NY)
HEARING ON THE REPORT OF THE PRESIDENTIAL COMMISSION ON THE
CHALLENGER ACCIDENT

JUNE 10, 1986

MR. CHAIRMAN:

I WANT TO APPLAUD SECRETARY ROGERS AND THE ENTIRE COMMISSION FOR THEIR PAINSTAKING EFFORTS TO UNCOVER THE CAUSE OF THE CHALLENGER TRAGEDY. THE COMMISSION HAS QUITE DESERVEDLY WON THE ADMIRATION OF THE CONGRESS AND THE AMERICAN PEOPLE FOR ITS THOROUGHNESS, ITS INTELLIGENCE AND ITS INTEGRITY. THE COMMISSION'S RECOMMENDATIONS, WHEN IMPLEMENTED, SHOULD RESTORE FAITH IN THE SPACE PROGRAM AND PREVENT FUTURE LOSS OF LIFE.

THE COMMISSION WAS SO EFFECTIVE PRECISELY BECAUSE IT AVOIDED THE FAULTS IT EXPOSED IN NASA. WHILE NASA HAD BECOME ALMOST CAVALIER ABOUT FACTS, THE COMMISSION PAID ATTENTION TO EVERY DETAIL. WHILE NASA HAD BEGUN TO SUBORDINATE SAFETY TO OTHER CONCERNS, THE COMMISSION MADE SAFETY THE FOCUS OF ITS INVESTIGATION. WHILE NASA'S PROCEDURES HAD BECOME COMPRESSED AND RUSHED, THE COMMISSION TOOK CARE TO BE THOROUGH AND DELIBERATE. AND WHILE NASA'S INTERNAL COMMUNICATIONS HAD BEGUN TO DETERIORATE, THE COMMISSION SET A STANDARD FOR RESPONSIBLE DEBATE.

OUR COMMITTEE MUST ASPIRE TO MEET THE EXACTING STANDARDS
EPITOMIZED BY THE ROGERS COMMISSION. WE MUST REVIEW IT FINDINGS
FULLY. WE MUST RESTORE FAITH IN AMERICA'S SPACE PROGRAM BY
RESTORING ITS QUALITY AND ITS SAFETY. THAT WILL TAKE MORE THAN
WORDS.

I LOOK FORWARD TO WORKING WITH MY COLLEAGUES TO MEET THAT
CHALLENGE.

THE HONORABLE TOM LEWIS
STATEMENT
HEARING ON CHALLENGER INVESTIGATION
JUNE 10, 1986

THE COMMISSION HAS FINISHED ITS WORK AND I BELIEVE IT IS NOW APPROPRIATE FOR CONGRESS TO REVIEW THEIR FINDINGS AND RECOMMENDATIONS. I WANT TO COMMEND CHAIRMAN FUQUA FOR HIS LEADERSHIP DURING THESE TRYING TIMES. THIS COMMITTEE HAS HAD MORE THAN A CASUAL INTEREST IN DETERMINING THE CAUSE OF THE CHALLENGER ACCIDENT; HOWEVER, IT WAS IMPORTANT THAT THE COMMISSION BE ALLOWED TO CONDUCT ITS INVESTIGATION WITHOUT CONGRESSIONAL INTERFERENCE.

I HAVE READ THE COMMISSION'S REPORT, AND IT APPEARS THAT THEY HAVE BEEN THOROUGH AND PROFESSIONAL IN THEIR INVESTIGATION OF THE ACCIDENT AND THE EVENTS LEADING UP TO IT. IT IS WITH GREAT SADNESS THAT I HAVE TO CONCLUDE THAT SERIOUS PROBLEMS EXISTED WITHIN NASA, AND THIS TERRIBLE TRAGEDY PROBABLY DID NOT HAVE TO HAPPEN.

BUT BEFORE WE RUSH TO JUDGEMENT, I THINK WE ALSO NEED TO ASK OURSELVES WHAT PART WE PLAYED IN THIS TRAGEDY. AREN'T WE AT LEAST PARTLY RESPONSIBLE FOR HELPING TO CREATE THE ENVIRONMENT WHERE SERIOUS PROBLEMS SUCH AS THE FAULTY DESIGN OF THE SOLID ROCKET BOOSTER COULD BE OVERLOOKED ----- OR EVEN COVERED UP?

I BELIEVE WE WERE LULLED INTO A SENSE OF OVERCONFIDENCE IN NASA'S ABILITY TO ACCOMPLISH THE SPECTACULAR AND MAKE IT LOOK ROUTINE. NASA CREATED FOR ITSELF A REPUTATION FOR EXCELLENCE THAT WE FOUND DIFFICULT TO CHALLENGE. PERHAPS WE WANTED TOO MUCH TO BELIEVE IN NASA'S INVINCIBILITY, OR PERHAPS WE FELT INCOMPETENT TO CRITIQUE OUR HEROES. WHATEVER THE REASONS, WE MUST ACCEPT PART OF THE RESPONSIBILITY AND RECOGNIZE THE NEED FOR A MORE CRITICAL OVERSIGHT ROLE IN THE FUTURE. THE LEADERSHIP OF DR. FLETCHER WILL BE TESTED MANY TIMES OVER THE COMING MONTHS, BUT I AM CONFIDENT HE WILL MEET THE CHALLENGE.

I APPLAUD OUR CHAIRMAN'S POSITIVE SPIRIT IN CALLING FOR A NEW BEGINNING, AND I SHARE HIS CONFIDENCE THAT WE CAN LEARN FROM THIS TERRIBLE TRAGEDY AND BUILD AN EVEN STRONGER SPACE PROGRAM. TO DO LESS WOULD BE AN INSULT TO THOSE BRAVE ASTRONAUTS WHO GAVE THEIR LIVES FOR THIS PROGRAM.

OPENING REMARKS OF
HONORABLE DON RITTER

COMMITTEE ON SCIENCE AND TECHNOLOGY
U.S. HOUSE OF REPRESENTATIVES

JUNE 10, 1986

Good morning, Mr. Chairman. I want to join my colleagues in welcoming Secretary Rogers and Mr. Armstrong before the Committee today. I, too, believe that the Rogers Commission has done an excellent job in their investigation of the tragic loss of Challenger and her gallant crew.

I believe that it is crucial that the White House and the Congress move quickly to resolve the issues raised by the Rogers Commission so that we may return to flight status as quickly as possible.

A few days ago I had the pleasure of hearing Scott Carpenter, one of our original seven astronauts, who was speaking in my district. I was quite impressed with his memories of space flight and with his point that from space there are no national boundaries. I have heard that virtually all space voyagers return to our fragile spaceship Earth impressed with the concept that space is an area that needs to be peacefully opened to everyone for science and commercialization.

The United States has built a solid international reputation as the world leader in manned space exploration. With the current situation in which we are temporarily unable to launch the shuttle for manned space flight, or either our Air Force Titan unmanned rocket, or NASA's highly dependable Delta unmanned rocket, we are in real danger of losing our international leadership position in space.

I think that it is important that this committee act quickly to complete our review of the Rogers Commission report, and then to give NASA the direction it needs to return us to flight. Let us learn from the lessons of the past, and get on with the future.

HONORABLE RON PACKARD
OPENING STATEMENT ON THE
CHALLENGER ACCIDENT
COMMITTEE ON SCIENCE AND TECHNOLOGY
JUNE 10, 1986

I COMMEND SECRETARY ROGERS AND THE OTHER MEMBERS OF THE PRESIDENTIAL COMMISSION INVESTIGATING THE CHALLENGER ACCIDENT FOR THEIR DILIGENCE, THOROUGHNESS AND OBJECTIVITY.

IN REVIEWING THE COMMISSION'S REPORT AND IN SPEAKING WITH NASA OFFICIALS, I AM STRUCK BY THE FEELING THAT THERE IS A SIGNIFICANT DIFFERENCE BETWEEN THE COMMISSION'S AND NASA'S PERCEPTION OF THE TECHNICAL AND MANAGEMENT EVENTS THAT LED TO THE ACCIDENT. NASA'S ATTITUDE DURING THE INVESTIGATION HAS CONVEYED THE MESSAGE THAT THE ACCIDENT WAS UNAVOIDABLE. I STRONGLY DISAGREE. I SUPPORT THE COMMISSION'S FINDING THAT THE CHALLENGER ACCIDENT WAS PREVENTABLE. I AM GRAVELY CONCERNED THAT NASA MAY NOT EVEN YET REALIZE THE SERIOUS MANAGEMENT PROBLEMS THAT HAVE DEVELOPED OVER THE YEARS AND PERMITTED SUCH AN ACCIDENT TO OCCUR. MY GREATEST FEAR IS WONDERING HOW MANY OTHER ACCIDENTS ARE WAITING TO HAPPEN;

IN THE SAME WAY, CONTRACTORS WITHIN THE PROGRAM MUST BE HELD ACCOUNTABLE AND LEARN THE HARD LESSONS OF THE PAST FIVE MONTHS. IT IS NOT ENOUGH FOR US TO ESTABLISH CULPABILITY; WE MUST RESTORE

THE FAITH THAT HAS BEEN LOST IN RECENT MONTHS BY CHANGING THE MANAGEMENT POLICY.

IT IS NOW THIS COMMITTEE'S RESPONSIBILITY TO ASSESS THE COMMISSION'S FINDINGS AND RECOMMENDATIONS, REVIEW THE ENTIRE NATIONAL SPACE TRANSPORTATION SYSTEM, AND IMPLEMENT COMMISSION AND COMMITTEE RECOMMENDATIONS TO ENSURE THAT NO MORE "PREVENTABLE" ACCIDENTS WILL OCCUR. FURTHER, THE COMMITTEE MUST BE MORE DILIGENT IN ITS OVERSIGHT.

OUR MANNED SPACE PROGRAM HAS GREATLY BENEFITED THIS NATION AND THE WORLD. AS THIS COMMITTEE REVIEWS AND FURTHER INVESTIGATES THE ACCIDENT AND NASA, WE MUST NOT, IN OUR ZEAL TO REPRIMAND AND CORRECT PROBLEMS, DESTROY NASA. RATHER, WE MUST REPAIR AND RESTORE NASA TO THE GREAT ORGANIZATION THAT IT HAS BEEN AND IS CAPABLE OF BEING AGAIN. THE CONFIDENCE AND HIGH LEVEL OF SUPPORT FOR NASA AND THE SPACE PROGRAM BY THIS COMMITTEE, THE CONGRESS, AND THE NATION AT LARGE MUST BE RETAINED.

OPENING REMARKS OF REPRESENTATIVE ROBERT C. SMITH (N.H.-1)
SCIENCE AND TECHNOLOGY HEARINGS ON THE REPORT OF THE PRESIDENTIAL
COMMISSION ON THE SPACE SHUTTLE CHALLENGER ACCIDENT
JUNE 10, 1986

The First Teacher chosen for Space Flight, Christa McAuliffe, is deeply missed in our home state of New Hampshire. As we commence this series of hearings on the Challenger accident, I believe that there could be no finer tribute to the memory of Christa and her six fellow Challenger crew members than to rededicate ourselves to the pursuit of space flight.

We must find the problem, fix it and go on. Chairman Rogers and the Presidential Commission on the Space Shuttle Challenger Accident have had a difficult, challenging task and they have done outstanding work. The Rogers Commission report is a critical, but fair, document. Its clarity and findings will prove of great assistance to this Committee as we determine how to fix serious safety and communications problems and continue with the Space Shuttle Program.

As a relatively new member of the Space Science and Applications Subcommittee, I am extremely concerned with the previous lack of testimony by NASA witnesses in subcommittee hearings on problems of safety and the effect of budget constraints on this crucial aspect of the Shuttle Program. I want to see future Space Science and Applications Subcommittee hearings prioritize improved safety oversight. Particularly disturbing is that Shuttle launches were not delayed voluntarily by NASA when the design of the Solid Rocket Motor joint was suspected as faulty, and the fact that, as members of the Committee which has jurisdiction over NASA, we were never made aware of this design deficiency by NASA. In addition, I am stunned that this design concern might even have failed to reach the appropriate NASA management officials. If this is the case, then Congress must oversee a restructuring of NASA's communication system.

We must translate our attitude of concern for the lives and complex hardware at risk every time we launch into real safety precautions and careful management decisions, or we might as well stay on the ground. The greatest good which could come out of this and future Congressional oversight is to see that success in space does not again lead to compromises in safety.

OPENING COMMENTS OF CONGRESSMAN JOE BARTON
SCIENCE AND TECHNOLOGY COMMITTEE HEARING
REPORT OF THE PRESIDENTIAL COMMISSION ON THE CHALLENGER ACCIDENT
JUNE 10, 1985

Mr. Chairman, I commend the work of Chairman Rogers and the other members of the Presidential Commission on the Space Shuttle Challenger Accident. In the aftermath of the worst disaster in the history of space exploration, the Presidential Commission has pursued its mandate with hard work and determination.

All too often, commissions and blue ribbon panels which are established are paper organizations which meet infrequently to approve work done by staff. This commission, under the leadership of Chairman Rogers, has been an actual working group utilizing the exceptional talents of its membership to discover the cause of the shuttle tragedy and make recommendations to prevent its recurrence. There is no doubt that the commission has determined the cause of the explosion and made a number of insightful recommendations to insure that this never recurs again.

The findings and recommendations of the Commission are an excellent starting point from which to begin efforts to solve the problems at NASA and the Shuttle program. The design of the Solid Rocket Motor joint is an obvious area which deserves our greatest attention and efforts. Involving the astronauts in the design and management of the shuttle programs is also a needed reform. The Apollo program was characterized by close cooperation between the engineers and the Astronaut office. It is no coincidence that the

Apollo program was a paragon of excellence which NASA would do well to emulate today.

I would like to see the Science and Technology Committee address other issues as we conduct our oversight hearings of the Rogers Commission report. The first is the issue of NASA leadership. It is clear that NASA has moved from an organization focused on research and development oriented towards single missions to an organization focused on operations and multiple missions. In doing so, it has failed to maintain the standards of excellence which marked its earlier days.

The Rogers Commission has detected a pattern of behavior at NASA that overlooked known potential safety problems. The list of components on the shuttle which were assigned "Criticality 1" (that is components with no backup whose failure would cause the loss of life or vehicle) is staggering. 748 items are listed as Criticality 1! The question which comes to mind is not why the tragedy occurred, but why it did not occur sooner.

One problem that has dogged NASA from the beginning of the shuttle program is that it was oversold to Congress. At one point prior to beginning shuttle flights, NASA estimated that they could eventually fly one shuttle flight a week. NASA later downgraded this estimate to two flights per month. The most flights that NASA has ever flown in a 12 month period, however, is nine. Combined with cost figures which have been consistently underestimated, it is not surprising that there has been tremendous pressure on NASA to increase the number of flights to justify the tremendous investment in the shuttle.

The multiple pressures on NASA — budgetary, scheduling, personnel, and

payload needs — will not decrease in the years ahead. For this reason, NASA needs strong and effective leadership beginning at the top and extending down through the entire organization. This type of leadership will help insure that NASA regains the excellence which was once the hallmark of the agency.

Another major area of concern is the replacement for the shuttle. It is certain that we need a replacement for the orbiter. Some have testified before this Committee that "the taxpayer should pay for the next shuttle." I cannot support this viewpoint. I will be working to discover innovative means to finance the next shuttle. I hope that we can gather a coalition of public and private groups willing to work together to fund and build the next shuttle. With public tax dollars becoming increasingly precious, now is the time to seriously address partial private financing.

An additional issue is what level of technology to utilize in the new orbiter. Short term considerations would seem to dictate building a replacement orbiter identical in most respects to the existing three orbiters. However, it might be wise to employ the next generation of technology in a replacement orbiter. I look forward to discussing these concerns with NASA officials and other experts in the coming weeks.

The shuttle tragedy has forever changed the way we perceive our space program. We can no longer not take our access to space for granted. We must critically review the space program and insure that a disaster such as this is never repeated. The American space program is essential for the future of this country. Our national pride and world technological leadership are resting on the resumption of space flight and a strong national space program.

The Chair wants to advise the members that our plan for the conduct of the hearings will be to hear from our distinguished witnesses today, this morning until noontime. We will reconvene tomorrow with representatives testifying from NASA. We will reconvene again on Thursday with Secretary Rogers and his associates coming back here, and we'll reconvene again on Friday with NASA to follow up from there. That is the plan for the week, so you can plan your schedules accordingly.

The Chair would like to again welcome Secretary Rogers and Mr. Armstrong, the vice chairman, to our hearings, and Dr. Keel, and again compliment you on the extraordinary work that you have done.

And we defer directly to you, Mr. Secretary, for your opening statements and any comments you may wish to make. Mr. Secretary?

STATEMENT OF HON. WILLIAM P. ROGERS, CHAIRMAN, PRESIDENTIAL COMMISSION ON THE SPACE SHUTTLE "CHALLENGER" ACCIDENT, ACCOMPANIED BY NEIL A. ARMSTRONG, VICE CHAIRMAN

Mr. ROGERS. Thank you, Mr. Chairman, members of the committee.

First, I would like to begin by expressing my gratitude and the gratitude of—

Mr. ROE. Mr. Secretary, could you please pull that microphone closer? It's a little bit hard to hear.

Mr. ROGERS. How's that?

Mr. ROE. That's better.

Mr. ROGERS. Is that OK now?

Mr. ROE. Fine. Thank you.

Mr. ROGERS. I'll start again.

I would like to express my gratitude and that of the Commission for your support and cooperation throughout this investigation. You have allowed the Commission the opportunity to proceed with its very important and very often difficult task without interference of any kind, and you deserve acknowledgment and recognition for doing so.

As you know, from time to time I briefed the members of the committee about our work. I am pleased to say that those briefings were conducted in private session. All of the information that we conveyed was held by the committee. There were no leaks from the committee. And all of us appreciate the fact that you cooperated as you did.

And we recognize that it's now the right and the responsibility of Congress—and you see in our preface we point that out—to conduct the hearings that you deem appropriate. We fully support and welcome such hearings.

I have a prepared statement here which in a sense is a summary of the recommendations in the report itself. I don't think it's necessary for me to read that statement. I'll be glad to submit it for the record. I thought the committee should have it for the record, but I don't think it's necessary because it's pretty much repetitious.

Mr. ROE. With no objection, so agreed.

[The prepared statement of Mr. Rogers follows:]

Testimony of

William P. Rogers
Chairman, Presidential Commission on the
Space Shuttle Challenger Accident

on the

Report to the President by the
Presidential Commission

before the

House Committee on Science and Technology

June 10, 1986

Mr. Chairman, I would like to begin by expressing my gratitude and appreciation to you and your Committee for your support and cooperation throughout the Commission investigation. You allowed the Commission the opportunity to proceed with its very important, and often difficult task, without interference of any kind. You deserve acknowledgment and recognition for doing so. The Commission recognizes that it's now the right and responsibility of Congress in its oversight role to conduct hearings as it deems appropriate. We fully support and welcome such hearings.

I would like to begin, Mr. Chairman, by providing the Committee a sense of the scope of our investigation and a description of the Commission approach to the investigation as events unfolded.

I will then give you a brief description of the accident and explanation of the cause as determined by the Commission. I will relate our findings regarding the launch decision process, and the history of concerns about the design and flight experience with the Solid Rocket Booster joints and O-ring seals. Finally, I will discuss Commission findings regarding the NASA safety organization, launch pressures on the system, and other future safety concerns -- including those brought to the Commission's attention by the Astronaut office.

I will conclude with a summary of our recommendations to avoid a future recurrence of a tragedy such as the Challenger accident, and to return our nation to safe space flight.

Scope of Investigation

We believe the investigation and report is one of the most comprehensive and complete of its kind.

- Seventy witnesses testified before the full Commission, providing 2,800 pages of transcript.
- More than 160 individuals were interviewed and 46 Commission panel sessions were conducted, yielding 12,000 pages of transcript.
- Over 6,300 reports and documents were reviewed, totaling more than 122,000 pages.
- 33 NASA Task Force Reports were prepared -- in part by Commission Panel members -- and submitted to the Commission for review and analysis.

All materials relating to the investigation, including private correspondence, were documented, reviewed, and evaluated and made

a part of the computerized data base. Commission materials will now become part of the permanent public record.

The Commission Report is a complete and careful presentation of the facts revealed by the investigation and of the Commission findings and recommendations based on those facts. Four additional volumes of supporting information are being published: two volumes of supplemental reports, including the six NASA Team Reports; and two volumes of Commission Hearing Transcripts.

Commission Activities

*President Reagan, seeking to ensure a thorough and unbiased investigation of the Challenger accident, announced the formation of the Commission on February 3, 1986. The mandate given by the President, contained in Executive Order 12546, required Commission members to:

- (1) Review the circumstances surrounding the accident to establish the probable cause or causes of the accident; and
- (2) Develop recommendations for corrective or other action based upon the Commission's findings and determinations.

Following its swearing in on February 6, the Commission immediately began a series of hearings during which NASA officials outlined agency procedures covering the Shuttle program and the status of NASA's investigation of the accident.

Shortly thereafter, on February 10, Dr. Alton G. Keel, Jr., Associate Director of the Office of Management and Budget, was appointed Executive Director. Dr. Keel began gathering a staff of 15 experienced investigators as well as administrative personnel from various government agencies and the military services.

Eventually, 42 permanent staff personnel, including administrative and writing support were assembled. Over 100 additional contract personnel were assembled to staff the Commission document control center -- to enter documents into the computer data base, and to assist Commissioners and staff in conducting computer searches of Commission documents.

During a closed session on February 10, 1986, the Commission began to learn of the troubled history of the Solid Rocket Motor joints and seals. Moreover, it discovered the first indication that the contractor, Morton Thiokol, initially recommended against launch on January 27, 1986, the night before the launch of 51-L, because of concerns regarding low temperature effects on the joint and seal. To investigate this disturbing development,

additional closed sessions were scheduled for February 13 and 14 at Kennedy. The February 13, 1986, session was an extensive presentation of film, video, and telemetry data relating to the Challenger accident. It provided the Commission the first evidence that the Solid Rocket Motor joint and seal may have malfunctioned, initiating the accident.

The session on February 14 included NASA and contractor participants involved in the discussion on January 27, 1986, not to launch 51-L. After testimony was received, an executive session of the Commission was convened. The following statement was subsequently issued on February 15, 1986, reflecting the conclusion and view of the Commission.

"In recent days, the Commission has been investigating all aspects of the decision making process leading up to the launch of the Challenger and has found that the process may have been flawed. The President has been so advised.

"Dr. William Graham, Acting Administrator of NASA, has been asked not to include on the internal investigating teams at NASA, persons involved in that process.

"The Commission will, of course, continue its investigation and will make a full report to the President within 120 days."

The role of the Commissioners thus changed from that of overseers to that of active investigators and analysts of data presented by NASA and its contractors.

By February 17, the Commission had divided itself into four investigative panels. Working groups were sent to Marshall, Kennedy, and Thiokol to analyze data relating to the accident and to redirect efforts. NASA's investigation was also reorganized to reflect the structure of the Commission's panels.

The Accident Analysis Panel, chaired by Major General Donald Kutyna, made several trips to both Kennedy and Marshall and traveled to Thiokol facilities in Utah to review photographic and telemetric evidence as well as the results of the salvage operation and to oversee the tests being conducted by NASA and Thiokol engineers.

Early in March, at my request, this group assembled and directed the Commission's independent team of six technical observers with extensive experience in Solid Rocket Motor technology and accident investigation to validate and interpret the tests and analyses performed on the Thiokol motor by NASA and Thiokol.

The Development and Production Panel, chaired by Joseph Sutter, centered its investigation on the production and testing activities of the Shuttle element contractors.

The Pre-Launch Activities Panel, chaired by David Acheson, concentrated on activities at Kennedy where the Shuttle elements are assembled and all other final launch preparations are completed.

The Mission Planning and Operations Panel, chaired by Dr. Sally Ride, focused its efforts on mission planning and crew preparation for STS 51-L and on details of NASA's safety, reliability, and quality assurance programs.

While the work of the individual panels and their investigative staffs was ongoing, the Commission's general investigative staff began a series of individual interviews to document fully the factual background of various areas of the Commission's interest, including the telecon between NASA and Thiokol officials the night before the launch; the history of joint design and O-ring problems; NASA safety, reliability and quality assurance functions; and the assembly of the right Solid Rocket Booster for STS 51-L. Subsequent investigative efforts by this group were directed in the area of the effectiveness of NASA's organizational structure, particularly the Shuttle program structure, and allegations that there had been external pressure on NASA to launch on January 28th.

In addition to the work of the Commission and the Commission staff, NASA personnel expended a vast effort in the investigation. More than 1,300 employees from all NASA facilities were involved and were supported by more than 1,600 people from other government agencies and over 3,100 from NASA's contractor organizations. Particularly significant were the activities of the military, the Coast Guard and the National Transportation Safety Board in the salvage and analysis of the Shuttle wreckage.

Description of the Accident.

Based on film, video and telemetry data, the Commission determined that the sequence of events leading to the accident was as follows:

- Liftoff began with the ignition of the Solid Rocket Boosters, (6.6 seconds after ignition of the Space Shuttle Main Engines).
- At .678 seconds after liftoff, the first puff of smoke was observed emanating from the right Solid Rocket Booster in

the vicinity of the aft field joint between the booster and the External Tank, near the External Tank attach strut.

- By 2.5 seconds after liftoff the generation of the smoke stopped. About nine puffs of smoke had been generated.
- During the ascent -- beginning at about 37 seconds and lasting until about 64 seconds -- heavy wind shears were encountered that, although not producing excessive loads, did provide a "bumpy ride" that could have had an effect on an already damaged system; namely, the seal in the aft field joint.
- Everything looked normal until about 59 seconds after liftoff. At this time flame started coming out of the right booster in the area where smoke had been seen before.
- The flame and hot gas plume grew in size during the next 14 to 15 seconds. It was impinging on the aft (hydrogen tank portion) of the External Tank close to where the tank is connected to the Solid Rocket Booster.
- At about 64 to 65 seconds the structural integrity of the External Tank was breached and hydrogen began leaking from the aft region near a welded seam.
- Beginning at about 72 seconds, a rapid sequence of events began. The heat and flame weakened connection (strut) to the lower part of the External Tank failed. At about 73 seconds, the bottom portion of the External Tank (hydrogen tank) failed.
- Failure of the bottom of the External Tank caused the pressurized liquid hydrogen to be released rapidly, which in turn propelled the hydrogen tank, with about 2.8 million pounds of force, into the intertank area (between hydrogen and oxygen tanks), and probably into the bottom of the oxygen tank (upper portion of External Tank).
- At about the same time, the forward part of the booster (frustum) impacted with the forward part of the External Tank, which contained the oxygen tank. Failure of the aft booster attachment strut had allowed the bottom part of the booster to move away from the External Tank, rotating about its forward attachment point.
- This nearly instantaneous mixing of hydrogen and oxygen, in an environment of sparks produced when the hydrogen tank was propelled into the intertank area, caused a fire, or nearly explosive burning of these propellants. The Orbiter, under

severe aerodynamic loads, broke into pieces within fractions of a second.

The Shuttle was going at nearly twice the speed of sound (Mach 1.92) and was passing through 46,000 feet of altitude. There were no alarms sounded in the cockpit. The crew apparently had no indication of a problem before the rapid break-up of the Space Shuttle system. The first evidence of an accident came from live video coverage. Radar then began to track multiple objects. The flight dynamics officer in Houston confirmed to the flight director that "RSO (range safety officer) reports vehicle exploded," and 30 seconds later he added that the range safety officer had sent the destruct signal to the Solid Rocket Boosters. During the period of flight when the Solid Rocket Boosters are thrusting, there are no survivable abort options. There was nothing that either the crew or the ground controllers could have done to avert the catastrophe.

Cause of the Accident

The consensus of the Commission and participating investigative agencies is that the loss of the Space Shuttle Challenger was caused by a failure in the joint between the two lower segments of the right Solid Rocket Motor. The specific failure was the destruction of the seals that are intended to prevent hot gases from leaking through the joint during the propellant burn of the rocket motor. The evidence assembled by the Commission indicates that no other element of the Space Shuttle system contributed to this failure.

In arriving at this conclusion, the Commission reviewed in detail all available data, reports, and records; directed and supervised numerous tests, analyses, and experiments by NASA, civilian contractors and various government agencies; and then developed specific failure scenarios and the range of most probable causative factors.

Throughout the investigation three critical questions were central to the inquiry, namely:

- What were the circumstances surrounding mission 51-L that contributed to the catastrophic termination of that flight in contrast to 24 successful flights preceding it?
- What evidence pointed to the right Solid Rocket Booster as the source of the accident as opposed to other elements of the Space Shuttle?
- Finally, what was the mechanism of failure?

Using mission data, subsequently completed tests and analyses, and recovered wreckage, the Commission identified all possible faults that could originate in the respective flight elements of the Space Shuttle which might have the potential to lead to loss of the Challenger. Potential contributors to the accident examined by the Commission were the launch pad, the External Tank, the Space Shuttle Main Engines, the Orbiter and related equipment, payload/Orbiter interfaces, the payload, the Solid Rocket Boosters and Solid Rocket Motors.

In a parallel effort, the question of sabotage was examined in detail and reviewed by the Commission in executive session. There is no evidence of sabotage, either at the launch pad or during other processes prior to or during launch.

As the investigation progressed, elements assessed as being improbable contributors to the accident were eliminated from further consideration. This process of elimination brought focus to the right Solid Rocket Motor. As a result, four areas related to the functioning of that motor received detailed analysis:

- Structural Loads
- Failure of the Case Wall (Case Membrane)
- Propellant Anomalies
- Loss of the Pressure Seal at the Case Joint

Through analysis, supporting data based on the investigation and tests, the Commission concluded that structural loads at launch or during flight, that flaws in the case membrane, or propellant anomalies were not the cause of the accident.

In contrast, joint seal failure was suspect. Enhanced photographic and computer-graphic positioning determined that the flame from the right Solid Rocket Booster near the aft field joint emanated at about the 305-degree circumferential position. The smoke at lift off appeared in the same general location. Thus, early in the investigation, the right Solid Rocket Booster aft field joint seal became the prime failure suspect. This supposition was confirmed when the Salvage Team recovered portions of both sides of the aft joint containing large holes extending from 291 degrees to 318 degrees.

Based on extensive tests and analyses, the investigation has shown that the joint sealing performance is sensitive to the following factors:

- (a) Damage to the joints/seals or generation of contaminants as joints are assembled.
- (b) Tang/clevis gap opening due to motor pressure and other loads.

- (c) Static O-ring compression.
- (d) Joint temperature as it affects O-ring response and hardness and formation of ice in the joint.
- (e) Use of putty as a thermal barrier as it relates to O-ring pressure actuation timing and O-ring erosion.

The Commission concluded that the joint/seal design was faulty, and overly sensitive to the above factors, and that as a consequence the joint malfunctioned, initiating the Challenger accident. In summary, the specific findings of the Commission with aspect to the cause of the accident are as follows:

- (1) A combustion gas leak through the right Solid Rocket Motor aft field joint initiated at or shortly after ignition eventually weakened and/or penetrated the External Tank initiating vehicle structural breakup and loss of the Space Shuttle Challenger during STS Mission 51-L.
- (2) The evidence shows that no other STS 51-L Shuttle element or the payload contributed to the causes of the right Solid Rocket Motor aft field joint combustion gas leak. Sabotage was not a factor.
- (3) Launch site records show that the right Solid Rocket Motor segments were assembled using approved procedures. However, significant out-of-round conditions existed between the two segments joined at the right Solid Rocket Motor aft field joint.
- (4) The ambient temperature at time of launch was 36 degrees Fahrenheit, or 15 degrees lower than the next coldest previous launch. The calculated joint and O-ring temperature was 28 degrees or 25 degrees colder than any previous launch.
- (5) Experimental evidence indicates that due to several effects associated with the Solid Rocket Booster's ignition and combustion pressures and associated vehicle motions, the gap between the tang and the clevis will open as much as .017 and .029 inches at the secondary and primary O-rings, respectively.
- (6) A compressed O-ring at 75 degrees Fahrenheit is five times more responsive in returning to its uncompressed shape than a cold O-ring at 30 degrees Fahrenheit. As a result, it is probable that the O-rings in the right solid booster aft field joint were not following the opening of the gap between the tang and clevis at time of ignition.

- (7) Experiments indicate that the primary mechanism that actuates O-ring sealing is the application of gas pressure to the upstream (high pressure) side of the O-ring as it sits in its groove or channel. A tang-to-clevis gap of .004 inches, as probably existed in the failed joint, would have initially compressed the O-ring to the degree that no clearance existed between the O-ring and the walls and bottom surface of the channel. At the cold launch temperature experienced, the O-ring would be very slow in returning to its normal rounded shape and it would remain in its compressed position in the O-ring channel unable to follow the gap opening. Thus, it is probable the O-ring would not be pressure actuated to seal the gap in time to preclude joint failure, resulting from blow-by and O-ring erosion from hot combustion gases.
- (8) Experimental evidence indicates that temperature, humidity, and other variables in the putty compound used to seal the joint can delay pressure application to the joint by 500 milliseconds or more.
- (9) Of 20 launches with calculated joint temperatures of 66 degrees Fahrenheit or greater, only three showed signs of O-ring thermal distress; i.e., erosion or blow-by and soot. Each of the four launches with joint temperature at 63 degrees or below resulted in one or more O-rings showing signs of thermal distress.
- (10) At time of launch, it was cold enough that water present in the joint would freeze. Tests show that ice in the joint can inhibit proper secondary seal performance.
- (11) A small leak could have persisted throughout the flight and grown to breach the joint in flame at a time on the order of 58 to 60 seconds after lift off. Alternatively, the O-ring gap could have been resealed by deposition of a fragile buildup of aluminum oxide and other combustion debris. This resealed section of the joint could have been disturbed by thrust vectoring, Space Shuttle motion and flight loads induced by changing winds aloft.

In conclusion, in view of the findings, the Commission concluded that the cause of the Challenger accident was the failure of the pressure seal in the aft field joint of the right Solid Rocket Motor. The failure was due to a faulty design unacceptably sensitive to a number of factors. These factors were the effects of temperature, physical dimensions, the character of materials, the effects of reusability, processing, and the reaction of the joint to dynamic loading.

Contributing Cause: Flawed Decision Process

In addition to analyzing all available evidence concerning the material causes of the accident on January 28, the Commission examined the chain of decisions that culminated in approval of the launch. It concluded that the decision to launch the Challenger was flawed. Those who made that decision were unaware of the recent history of problems concerning the O-rings and the joint and were unaware of the initial written recommendation of the contractor advising against the launch at temperature below 53 degrees Fahrenheit and the continuing opposition of the engineers at Thiokol after the management reversed its position. They did not have a clear understanding of Rockwell's concern that it was not safe to launch because of ice on the pad. If the decision makers had known all of the facts, it is highly unlikely that they would have decided to launch 51-L on January 28, 1986.

Commission testimony reveals failures in communication that resulted in a decision to launch 51-L based on incomplete and sometimes misleading information, a conflict between engineering data and management judgments, and a NASA management structure that permitted internal flight safety problems to bypass key Shuttle managers.

Specifically, the launch decision makers for flight 51-L were not made aware of the lengthy discussion during teleconferences of the concerns of Thiokol engineers relative to the effects of the cold temperatures predicted for launch on the ability of the O-rings in the Solid Rocket Motor joints to respond rapidly enough to seal the joints. They were unaware that Thiokol, including management officials, originally recommended not to launch and then, when pressed by NASA, that Thiokol management reassessed and recommended to launch.

The Commission consequently concluded that the launch decision process was seriously flawed. Had the concerns of most Thiokol engineers, and some Marshall engineers, been conveyed to launch decision makers, it seems likely that the launch of 51-L might not have occurred when it did.

The Commission is troubled by what appears to be a propensity of management at Marshall to contain potentially serious problems and to attempt to resolve them internally rather than communicate them forward. This tendency is altogether at odds with the need for Marshall to function as part of a system working toward successful flight missions, interfacing and communicating with the other parts of the system that work to the same end.

The Commission also concluded that the Thiokol Management reversed its position and recommended the launch of 51-L, at the urging of Marshall and contrary to the views of its engineers in order to accommodate a major customer.

Also, the investigation revealed that although the freeze protection plan for the launch pad was "implemented," the water system was not drained because of the imminent launch of 51-L. In order to prevent pipes from freezing, a decision was made to allow water to run slowly from the system. This had never been done before, and the combination of freezing temperatures and stiff winds caused large amounts of ice to form below the 240-foot level of the fixed service structure, including the access to the crew emergency egress slide wire baskets.

These conditions were first identified by the Ice Team at approximately 2:00 a.m. on January 28 and were assessed by management and engineering throughout the night, culminating with a Mission Management Team meeting at 9:00 a.m. At this meeting, representatives for the Orbiter prime contractor, Rockwell International, expressed their concern about what effects the ice might have on the Orbiter during launch.

The decision was made to launch pending a final ice team review of the launch complex in order to assess any changes in the situation. This inspection was completed following the Mission Management Team meeting and the ice team report indicated no significant change.

An analysis of all the testimony and interviews establishes that Rockwell's recommendation to launch at the 9:00 A.M. meeting was ambiguous. The Commission finds it difficult, as did NASA, to conclude that there was a no-launch recommendation.

The Commission is concerned, however, about the NASA response to the Rockwell position. While it is understood that decisions have to be made in launching a Shuttle, the Commission is not convinced Levels I and II appropriately considered Rockwell's concern about the ice. However ambiguous Rockwell's position was, it is clear that they did tell NASA that the ice was an unknown condition. Given the extent of the ice on the pad, the Commission finds the decision to launch questionable under those circumstances. In this situation, NASA appeared to be requiring a contractor to prove that it was not safe to launch, rather than proving it was safe.

An Accident Rooted in History: A Faulty Design and Ignored Warnings

The Space Shuttle's Solid Rocket Booster problem began with the faulty design of its joint and increased as both NASA and

contractor management first failed to recognize it as a problem, then failed to fix it, and finally treated it as an acceptable flight risk.

Morton Thiokol, Inc., the contractor, did not accept the implication of tests early in the program that the design had a serious and unanticipated flaw. NASA did not accept the judgment of its engineers that the design was unacceptable, and as the joint problems grew in number and severity NASA minimized them in management briefings and reports. Thiokol's stated position was that "the condition is not desirable but is acceptable."

Neither Thiokol nor NASA expected the rubber O-rings sealing the joints to be touched by hot gases of motor ignition, much less to be partially burned. However, as tests and then flights confirmed damage to the sealing rings, the reaction by both NASA and Thiokol was to increase the amount of damage considered "acceptable." At no time did management either recommend a redesign of the joint or call for the Shuttle's grounding until the problem was solved.

The Commission's review of the Marshall and Thiokol documentary presentations at the various Flight Readiness Reviews prior to Shuttle flights revealed several significant trends. First, O-ring erosion was not considered a problem early in the program when it first occurred. Second, when the problem grew worse after STS 41-B, the initial analysis of the problem did not produce much research; instead, there was an early acceptance of the phenomenon. Third, because of a belief that in-flight O-ring erosion was "within the data base" of prior experience, later Flight Readiness Reviews gave a cursory review and often dismissed the recurring erosion as within "acceptable" or "allowable" limits. Fourth, both Thiokol and Marshall continued to rely on the redundancy of the secondary O-ring long after NASA had officially declared that the seal was a non-redundant single point failure. Finally, in 1985 when temperature became a major concern after STS 51-C and when the launch constraint was applied after 51-B, NASA Levels I and II were not informed of these developments in the Flight Readiness Review process.

The Commission concluded that the genesis of the Challenger accident -- the failure of the joint of the right Solid Rocket Motor -- began with decisions made in the design of the joint and in the failure by both Thiokol and NASA's Solid Rocket Booster project office to understand and respond to facts obtained during testing.

The Commission also concluded that neither Thiokol nor NASA responded adequately to internal warnings about the faulty seal

design. Furthermore, Thiokol and NASA did not make a timely attempt to develop and verify a new seal after the initial design was shown to be deficient. Neither organization developed a solution to the unexpected occurrences of O-ring erosion and blow-by even though this problem was experienced frequently during the Shuttle flight history. Instead, Thiokol and NASA management came to accept erosion and blow-by as unavoidable and an acceptable flight risk. Specifically, the Commission has found that:

- The joint test and certification program was inadequate.
- Prior to the accident, neither NASA nor Thiokol fully understood the mechanism by which the joint sealing action took place.
- NASA and Thiokol accepted escalating risk as they began to consider flight "anomalies" as part of their "data base."
- The O-ring erosion history presented to Level I at NASA Headquarters in August 1985 was sufficiently detailed to require corrective action prior to the next flight.
- A careful analysis of the flight history of O-ring performance would have revealed the correlation of O-ring damage and low temperature.

The Silent Safety Program

The Commission was surprised to realize after many hours of testimony that NASA's safety staff or safety organization was never mentioned. No witness related the approval or disapproval of the reliability engineers, and none expressed the satisfaction or dissatisfaction of the quality assurance staff. No one thought to invite a safety representative or a reliability and quality assurance engineer to the January 27, 1986, teleconference between Marshall and Thiokol. Similarly, there was no representative of safety on the Mission Management Team that made key decisions during the countdown on January 28, 1986.

The unrelenting pressure to meet the demands of an accelerating flight schedule might have been adequately handled by NASA if it had insisted upon the exactingly thorough procedures that were its hallmark during the Apollo program. An extensive and redundant safety program comprising interdependent safety, reliability and quality assurance functions existed during and after the lunar program to discover any potential safety programs. Between that period and 1986, however, the program became ineffective. This loss of effectiveness seriously degraded the checks and balances essential for maintaining flight safety.

On April 3, 1986, Arnold Aldrich, the Space Shuttle program manager, appeared before the Commission at a public hearing in Washington, D.C. He described five different communication or organization failures that affected the launch decision on January 28, 1986. Four of those failures relate directly to faults within the safety program. These faults include a lack of program reporting requirements, inadequate trend analysis, misrepresentation of criticality and lack of involvement in critical discussions. A properly staffed, supported, and robust safety organization might well have avoided these faults and thus eliminated those communication failures.

NASA has a safety program intended to ensure that the communication failures to which Mr. Aldrich referred do not occur. In the case of mission 51-L, that program fell short.

Relative to the safety function, the Commission found that reductions in the safety, reliability and quality assurance work force at Marshall and NASA Headquarters have seriously limited capability in those vital functions. The independence of the safety organizations at Kennedy and Marshall is compromised, since those organizations are under the supervision of the very organization and activities whose efforts they are to check.

Pressures on the System

With the 1982 completion of the orbital flight test series, NASA began a planned acceleration of the Space Shuttle launch schedule. One early plan contemplated an eventual rate of a mission a week, but realism forced several downward revisions. In 1985, NASA published a projection calling for an annual rate of 24 flights by 1990. Long before the Challenger accident, however, it was becoming obvious that even the modified goal of two flights a month was overambitious.

In establishing the schedule, NASA had not provided adequate resources for its attainment. As a result, the capabilities of the system were strained by the modest nine-mission rate of 1985, and the evidence suggests that NASA would not have been able to accomplish the 15 flights scheduled for 1986.

One effect of NASA's accelerated flight rate and the agency's determination to meet it was the dilution of the human and material resources that could be applied to any particular flight. The part of the system responsible for turning the mission requirements and objectives into flight software, flight trajectory information and crew training materials was struggling to keep up with the flight rate in late 1985, and forecasts showed it would be unable to meet its milestones for 1986. With respect to the flight rate pressures the Commission found:

- The capabilities of the system were stretched to the limit to support the flight rate in the winter of 1985/1986.
- The Shuttle program made a conscious decision to postpone spare parts procurements in favor of budget items of perceived higher priority. Lack of spare parts would likely have limited flight operations in 1986.
- Stated cargo and crew manifest policies are not enforced. Numerous late manifest changes have been made to both major payloads and minor payloads, and in payload specialists, throughout the Shuttle program.

Outside Pressure to Launch

After the accident, rumors appeared in the press to the effect that persons who made the decision to launch mission 51-L might have been subjected to outside pressure to launch. Such rumors concerning unnamed persons, emanating from anonymous sources about events that may never have happened, are difficult to disprove and dispel. Nonetheless, during the Commission's hearings all persons who played key roles in that decision were questioned. Each one attested, under oath, that there had been no outside intervention or pressure of any kind leading up to the launch.

One rumor was that plans had been made to have a live communication hookup with the 51-L crew during the State of the Union Message. Commission investigators interviewed all of the persons who would have been involved in a hookup if one had been planned, and all stated unequivocally that there was no such plan.

The Commission thus concluded that the decision to launch the Challenger was made solely by the appropriate NASA officials without any outside intervention or pressure.

Other Safety Considerations

In the course of its investigation, the Commission became aware of a number of matters that played no part in the mission 51-L accident but nonetheless hold a potential for safety problems in the future.

Some of these matters, those involving operational concerns, were brought directly to the Commission's attention by the NASA astronaut office. They were the subject of a special hearing.

Other areas of concern came to light as the Commission pursued various lines of investigation in its attempt to isolate the cause of the accident. These inquiries examined such aspects as

the development and operation of each of the elements of the Space Shuttle - the Orbiter, its main engines and the External Tank; the procedures employed in the processing and assembly of 51-L, and launch damage.

The Commission examined potential risks in two general areas. The first embraced critical aspects of a Shuttle flight; for example, considerations related to a possible premature mission termination during the ascent phase and the risk factors connected with the demanding approach and landing phase. The other focused on testing, processing and assembling the various elements of the Shuttle.

Ascent: A Critical Phase. The events of flight 51-L dramatically illustrated the dangers of the first stage of a Space Shuttle ascent. The accident also focused attention on the issues of Orbiter abort capabilities and crew escape. Of particular concern to the Commission were the current abort capabilities, options to improve those capabilities, options for crew escape and the performance of the range safety system.

It was not the Commission's intent to second-guess the Space Shuttle design or try to depict escape provisions that might have saved the 51-L crew. In fact, the events that led to destruction of the Challenger progressed very rapidly and without warning. Under those circumstances, the Commission believes it is highly unlikely that any of the systems discussed, or any combination of those systems, would have saved the Challenger crew.

The Space Shuttle System was not designed to survive a failure of the Solid Rocket Boosters. There are no corrective actions that can be taken if the boosters do not operate properly after ignition; i.e., there is no ability to separate an Orbiter safely from thrusting boosters and no ability for the crew to escape the vehicle during first-stage ascent. Neither the Mission Control Team nor the 51-L crew had any warning of impending disaster. Even if there had been warning, there were no actions available to the crew or the Mission Control Team to avert the disaster. Nevertheless, the Commission did conclude that other escape systems and abort options should receive intensive review and made specific recommendations in this regard.

Landing: Another Critical Phase. The consequences of faulty performance in any dynamic and demanding flight environment can be catastrophic. The Commission was concerned that an insufficient safety margin may have existed in areas other than Shuttle ascent. Entry and landing of the Shuttle are dynamic and demanding with all the risks and complications inherent in flying a heavyweight glider with a very steep glide path. Since the Shuttle crew cannot divert to any alternate landing site after

entry, the landing decision must be both timely and accurate. In addition, the landing gear, which includes wheels, tires and brakes, must function properly.

These considerations were examined by the Commission for both normal and abort landings. It found that although there are valid programmatic reasons to land routinely at Kennedy, there are concerns that suggest that this is not wise under the present circumstances. For example, the realities of weather cannot be ignored. With the capabilities of the system today, the Shuttle cannot afford to operate outside its experience in the areas of tires, brakes, and weather. Pending a clear understanding of all landing and deceleration systems, and a resolution of the problems encountered to date in Shuttle landings, the most conservative course must be followed in order to minimize risk during this dynamic phase of flight.

The Commission, therefore, made specific recommendations to restrict Shuttle landings and improve Shuttle landing systems.

Shuttle Elements. The Space Shuttle Main Engine teams at Marshall and Rocketdyne have developed engines that have achieved their performance goals and have performed extremely well. Nevertheless, the main engines continue to be highly complex and critical components of the Shuttle that involve an element of risk principally because important components degrade more rapidly with flight use than anticipated. Both NASA and Rocketdyne have taken steps to contain that risk. An important aspect of the main engine program has been the extensive "hot fire" ground test program. Unfortunately, the vitality of the test program has been reduced because of budgetary constraints. The number of engine test firings per month has decreased over the past two years. Yet this test program has not yet demonstrated the limits of engine operation parameters or included tests over the full operating envelope to show full engine capability. In addition, tests have not yet been deliberately conducted to the point of failure to determine actual engine operating margins.

The Orbiter has also performed well. There is, however, one serious potential failure mode related to the disconnect valves between the Orbiter and the External Tank. The present design includes two 17-inch diameter valves, one controlling the oxygen flow, and the other the hydrogen flow from the tank to the Orbiter's three engines. An inadvertent closure during normal engine operation would cause a catastrophe due to rupture of the supply line and/or tank. New designs are under study, incorporating modifications to prevent inadvertent valve closures. Redesigned valves could be qualified, certified and available for use on the Shuttle's next flight.

Processing and Assembly. During the processing and assembly of the elements of flight 51-L, various problems were seen in the Commission's review which could bear on the safety of future flights.

During the 51-L processing, waivers were granted on 60 of 146 required Orbiter structural inspections. Seven of these waivers were second-time waivers of inspections.

Furthermore, throughout the Commission's review of the accident, a large number of errors were noted in the paperwork for the Space Shuttle Main Engine/Main Propulsion System and for the Orbiter. The review showed, however, that in the vast majority of cases the problem lay in the documentation itself and not in the work that was actually accomplished. The review led the Commission to conclude that the Operations and Maintenance Instructions are in need of an overall review and update, and the implementation of Operations and Maintenance Instructions needs to be improved.

At the time of launch, all items called for by the Operational Maintenance Requirements and Specifications Document were to have been met, waived or excepted. The 51-L audit review revealed areas where such requirements were not met and were not formally waived or excepted.

Another aspect of the processing activities that warrants particular attention is the Shuttle Processing Contractor's policy of using "designated verifiers" to supplement the NASA quality assurance force. Due to reduced manpower, NASA quality assurance personnel now inspect only areas that are considered more critical. Thus the system of independent checks that NASA maintained through several programs is declining in effectiveness. The effect of this change requires careful evaluation by NASA.

Finally, technicians interviewed by Commission investigators said that accidental damage is not consistently reported, when it occurs, because of lack of confidence in management's forgiveness policy and the technicians' consequent fear of losing their jobs. This situation has obvious severe implications if left uncorrected.

Development Nature of Program. The Space Shuttle program, like its predecessors Mercury, Gemini, Apollo, Skylab and Apollo-Soyuz, is clearly a developmental program and must be treated as such by NASA. Indeed, the chief differences between the Shuttle and previous developmental programs are that the Shuttle is principally a transportation system and employs reusable hardware. Reusability implies a new set of functions such as logistics support, maintenance, refurbishment, component lifetime

evaluation and structural inspections that must be accomplished by the program.

In order to enhance post-flight "turnaround" schedule and efficiency, NASA is striving to implement processing procedures accepted by the transportation industry. While this effort is useful, there is not an exact industry analogy to the Orbiter vehicles' flight operations, because each successive Shuttle mission expands system and performance requirements. Consequently, the Shuttle configuration is evolving as design changes and improvements are incorporated. These developmental aspects make significant demands, which can be met only by the following strategies:

- Maintain a significant engineering design and development capability among the Shuttle contractors and an ongoing engineering capability within NASA.
- Maintain an active analytical capability so that the evolving capabilities of the Shuttle can be matched to the demands on the Shuttle.

In short, the Shuttle's developmental status demands that both NASA and all its contractors maintain a high level of in-house experience and technical ability.

Recommendations

The Commission conducted an extensive investigation of the Challenger accident to determine the probable cause and necessary corrective actions. Based on the findings and determinations of its investigation, the Commission unanimously adopted recommendations to help assure the return to safe flight.

Recommendation One

Design. The faulty Solid Rocket Motor joint and seal must be changed. This could be a new design eliminating the joint or a redesign of the current joint and seal. The Commission established specific criteria for evaluation, certification and testing of the new design.

Independent Oversight. The Administrator of NASA should request the National Research Council to form an independent Solid Rocket Motor design oversight committee to implement the Commission's design recommendations and oversee the design effort.

Recommendation Two

Shuttle Management Structure. The Shuttle Program Structure should be reviewed. A redefinition of the Program Manager's

responsibility is essential. This redefinition should give the Program Manager the requisite authority for all ongoing STS operations. Program funding and all Shuttle Program work at the centers should be placed clearly under the Program Manager's authority.

Astronauts in Management. The Commission observed that there appears to be a departure from the philosophy of the 1960s and 1970s relating to the use of astronauts in management positions. These individuals brought to their positions flight experience and a keen appreciation of operations and flight safety. NASA should encourage the transition of qualified astronauts into agency management positions. The function of the Flight Crew Operations Director should be elevated in the NASA organization structure.

Shuttle Safety Panel. NASA should establish an STS Safety Advisory Panel reporting to the STS Program Manager. The charter of this panel should include Shuttle operational issues, launch commit criteria, flight rules, flight readiness and risk management. The panel should include representation from the safety organization, mission operations, and the astronaut office.

Recommendation Three

Criticality Review and Hazard Analysis. NASA and the primary Shuttle contractors should review all Criticality 1, 1R, 2, and 2R items and hazard analyses. This review should identify those items that must be improved prior to flight to ensure mission success and flight safety. An Audit Panel, appointed by the National Research Council, should verify the adequacy of the effort and report directly to the Administrator of NASA.

Recommendation Four

Safety Organization. NASA should establish an Office of Safety, Reliability and Quality Assurance to be headed by an Associate Administrator, reporting directly to the NASA Administrator. The office should be assigned the work force to ensure adequate oversight of its functions and should be independent of other NASA functional and program responsibilities.

Recommendation Five

Improved Communications. The Commission found that Marshall Space Flight Center project managers, because of a tendency at Marshall to management isolation, failed to provide full and timely information bearing on the safety of flight 51-L to other vital elements of Shuttle program management. NASA should take

energetic steps to eliminate this tendency whether by changes of personnel, organization, indoctrination or all three.

In addition, a policy should be developed which governs the imposition and removal of Shuttle launch constraints. Flight Readiness Reviews and Mission Management Team meetings should be recorded. The flight crew commander, or a designated representative, should attend the Flight Readiness Review, participate in acceptance of the vehicle for flight, and certify that the crew is properly prepared for flight.

Recommendation Six.

Landing Safety. NASA must take actions to improve landing safety. The tire, brake and nosewheel steering systems must be improved. The specific conditions under which planned landings at Kennedy would be acceptable should be determined. During unpredictable weather periods at Kennedy, program officials should plan on Edwards landings.

Recommendation Seven

Launch Abort and Crew Escape. The Commission recommends that NASA:

- Make all efforts to provide a crew escape system for use during controlled gliding flight.
- Make every effort to increase the range of flight conditions under which an emergency runway landing can be successfully conducted in the event that two or three main engines fail early in ascent.

Recommendation Eight

Flight Rate. The nation's reliance on the Shuttle as its principal space launch capability created a relentless pressure on NASA to increase the flight rate. Such reliance on a single launch capability should be avoided in the future.

NASA must establish a flight rate that is consistent with its resources. A firm payload assignment policy should be established to include rigorous controls on cargo manifest changes.

Recommendation Nine

Maintenance Safeguards. Installation, test, and maintenance procedures must be especially rigorous for Space Shuttle items designated Criticality 1. NASA should establish a system of analyzing and reporting performance trends of such items. NASA

should restore and support the Orbiter maintenance and spare parts programs and stop the practice of removing parts from one Orbiter to supply another.

Concluding Thought

The Commission closed its report with the following concluding thought which I believe is a fitting way, Mr. Chairman, to conclude the testimony:

The Commission urges that NASA continue to receive the support of the Administration and the nation. The agency constitutes a national resource that plays a critical role in space exploration and development. It also provides a symbol of national pride and technological leadership. The Commission applauds NASA's spectacular achievements of the past and anticipates impressive achievements to come. The findings and recommendations presented in this report are intended to contribute to the future NASA successes that the nation both expects and requires as the 21st century approaches.

Thank you very much, Mr. Chairman. I will be glad, along with the Commission Vice Chairman, Neil Armstrong, to answer any questions you may have.

Mr. ROGERS. I also want to point out a little bit about the scope of our investigation because I know one of the things the committee will be interested in is the scope of it. It was a very intensive investigation. It lasted really 3 months. The last month was pretty much involved in preparing the report because we had to get the report to the printer about 2 weeks before it could be published. So after we had hearings for about 2 months—pardon me; you can see we've had a long investigation. So we spent the last month preparing a report and getting it to the printer.

And I point out here that we had about 70 witnesses who testified. There are about 2,800 pages of testimony, about 160 individuals we interviewed. There were 46 Commission panel sessions that were conducted. I point that out because we broke up into panels. We had four panels. Each of the panels conducted their own private investigation—or maybe private isn't the word—investigation on special aspects of the investigation.

We have about—there were 6,800 reports of documents we reviewed, totaling more than 122,000 pages. Thirty-three NASA task force reports were prepared in part in cooperation with the Commission panel members and were submitted to the Commission for review and analysis.

So the investigation is a very comprehensive investigation, and all the information will be available to this committee. It will be automated, and you can retrieve any aspect of it as you want. We'll make it completely available to the staff of the committee.

We have provision made so all the material will be at the Archives, and you will be able to get any part of the work of the Commission that you want to.

I think you will find, Mr. Chairman, that it may be the most complete and thorough investigation of its kind that's been done, and I want to take this opportunity to say that the members of the Commission really were amazing in the dedication and hard work that was involved.

I also want to pay particular tribute to Dr. Keel and his staff, who did really a marvelous job. I'm sure that if you've had a chance to look at this report, you will realize how thorough it is. How we were able to turn it out, I don't know. I sure couldn't have done it except with people like Dr. Keel. I enjoy all the credit I'm getting, but I didn't have much to do with it.

Well, I thought the best thing to do, Mr. Chairman, in the interest of time, is to merely go to the questions.

Let me say that I think everything that we can think of that we could properly say is in this report. I don't have anything else to say.

In fact, if I don't get my voice back, I won't say it. [Laughter.]

I think the report is a very thorough one, and it was written deliberately with the idea that you can't read any one part of it and get an answer. You have to read all the report. And I think the impact of it comes from the total reading of it.

There's no doubt about it that serious mistakes were made. There were failures. We set them all out. You may find others that we haven't discovered, but I doubt it. I doubt that you'll find very much that is not covered by the report.

And I think that the problem that the Nation faces, in part your committee faces, is, What do we do from now on? Where do we go from here? And we were not asked to deal with that subject. That's really a subject for this committee.

And with that, I'll go to questions.

Mr. ROE. Is there any further comments to be made by Mr. Armstrong at all?

Mr. ARMSTRONG. No, sir; I would just like to make one correction. I would just like to—

Mr. ROE. You have to pull that closer [referring to microphone]. It's hard to hear.

Mr. ARMSTRONG [continuing]. Make one correction to the chairman's comments. Contrary to what he said, he had a great deal to do with the report, and no one on the Commission worked longer or harder, and you'll see his impact on every page.

Mr. ROE. We appreciate that comment.

Now let's proceed from there. What we're going to do is give the members an opportunity—and realize we're not going to be able to complete today—to propound any questions or observations they may have, and then we'll go from side to side so those points can be brought forward.

And I would just like to open up with two short comments and any suggestions or response you may wish to make.

I have had the opportunity—last night, if I look a little sleepy, I read the whole report from cover to cover. And I think you're totally right, Mr. Secretary, when you say that the report has to be read in context. I think that's true, and it comes more clearly to the point as to the issues involved.

Again I think from the members' point of view, there's many issues that the Commission has raised in their report and some that have deliberately been left, what would you say, not complete, so to speak, and that's left to the committee to decide what they want to do in the future on that.

But the thought occurred to me in two directions in your observations or review: really how safe is the shuttle? When you read the section particularly with the failure and the history behind the failure of the O-ring area, it does bring into point the safety critical items list and the number of items on that list. And I wonder if you've had a chance to evaluate leaving out the accident cause vis the O-ring issue and the other peripheral matters relating thereto—how safe is the shuttle in your judgment, considering I believe there's close to 2,000 items that are listed on the critical items list, as I recall?

Mr. ARMSTRONG. Mr. Chairman, we did not complete a total evaluation of the shuttle, nor was it our mandate, nor would it have been possible in the 4 months we had available.

We concentrated on what was the cause of the accident, but in the pursuit of those—that cause or causes certain additional items did come to our attention which the Commission was persuaded were of substantial interest from a safety perspective, and to the extent we were able to, through our panel work and through NASA teams, investigate those areas as they came to our attention, we did so.

Each of the things in that arena that we felt to be significant and felt needed additional work we tried to identify, with helpful suggestions, as to how that might be done without infringing on the responsibilities of the agency.

We, as a commission, are not in a position to be able to assure you or anyone that all the areas of the shuttle are safe. We can say that certainly the solid rocket booster needed attention, and we spelled that out in a good deal of detail in the report, and several other areas.

At the same time, I think we can say that we found a lot of work was exceptionally well done. We found outstanding design, processing, and execution within the shuttle itself. So we do not in any way imply that everything needs a careful examination.

Mr. ROE. Would it be a fair commentary to say, though, that one of the key items of safety is the key issue, one of the key issues we're speaking to, that certainly where the safety critical items list is involved, that that ought to have a total re-review from top to bottom by NASA? Would that be a fair—in process, in management, quality control, cost evaluation, cost relating thereto? Is that a fair comment?

Mr. ARMSTRONG. Yes, Mr. Chairman; we have specified that we recommend that review be done, and it's our understanding that Admiral Kruly is in the process of conducting such an evaluation at this time.

Mr. ROE. I appreciate that.

One other short—

Mr. ROGERS. Mr. Chairman, can I say, on— recommendation No. 3 covers that, and I would just like to add to what Neil said that we recognize that there's never complete safety to be assured in the shuttle system, but I think in answer to your basic question, yes, I think it's possible to continue the program safely, with reasonable safety. And I think that if the recommendations of the commission are followed that we can do that as a Nation.

Mr. ROE. I agree with you.

Let me just ask one other quick question. One of the questions you have risen in your report was the process and the thought process in reference to emergency escape system or a crew bailout. You didn't get into too much depth on that. Could you elucidate further to the committee what your observations were?

Mr. ROGERS. Well, I think this would be more appropriate for Mr. Armstrong to answer.

Mr. ROE. Mr. Armstrong.

Mr. ARMSTRONG. Mr. Chairman, studies in the area of crew escape have been conducted by NASA since the instigation of the shuttle program. For various reasons that are detailed to some degree in the report, those systems were not implemented.

We're persuaded that a complete crew—all situation crew escape system is not practical nor desirable, but we do think that limited escape possibilities might be providable and should be investigated.

Mr. ROE. So you're saying fundamentally it should be re-evaluated?

Mr. ARMSTRONG. Yes, sir.

Mr. ROE. Is that fair?

The Chair recognizes the distinguished gentleman from Florida, Mr. Chairman.

Mr. FUQUA. I'll defer at the present time, Mr. Chairman.

Mr. ROE. The Chair recognizes the distinguished minority leader, Mr. Lujan, from New Mexico.

Mr. LUJAN. Thank you very much, Mr. Chairman.

And I want to again say that I'm very impressed with the report. I think the Commission did an excellent job, and of course one of the things that I look forward to, and the full committee looks forward to, is the other reports that we get that go more into detail, because my concern is what you spoke of just a few minutes ago, Mr. Secretary—where do we go from here? And that's our responsibility.

In that regard, I'm looking forward to further details. And I wonder if they might appear in those reports that we'll get further.

What I'm referring to is on the section entitled "An Accident Rooted in History." There are a number of generalities that say the joint test and certification program was inadequate. "Neither NASA nor Thiokol fully understood the mechanism by which the joint sealing action took place."

Everything worked because they got away with it, and they continued to do it, and on and on and on.

"The O-ring erosion history presented to level I at NASA headquarters in August 1985 was sufficiently detailed to require corrective action prior to the flight."

Now, I understand your reasoning that it wasn't your mission, but you have been quoted as saying, "Well, we didn't want to point any fingers." And I suppose none of us wants to get into that sort of thing.

But as a function of our oversight, we need to know what positions to zero in on to change the way that things were done, and in that respect we do need to know who was responsible or at least what position was responsible for not changing the design, for not getting on Thiokol for not doing testing that they were supposed to do, for failing to make the change testing upright rather than sideways, those kinds of things.

Will those things be in your followup report or is there anything that you could add to it at this point?

Mr. ROGERS. Well, first let me address the question about our jurisdiction. We felt that we were not required, nor should we, to make any judgments about who was responsible individually for what happened. In other words, our job was to find out the cause of the accident, make recommendations about future safety. Now in that process a lot of information developed as to individuals. A lot of it is cited in the report. So the committee will have available a lot of information about particular individuals, many of whom have been transferred already.

You will also find in our records that we have all of the answers, I believe, to the questions you want. We have very detailed information which will be in our appendix that were submitted by NASA about who attended meetings, and so forth.

But I think you'll probably not find that any one individual was responsible or any group of individuals. It was sort of a systems failure. Maybe some individuals were more responsible than others,

but I don't believe it's going to be the type of thing that a grand jury would look into. And I think we've attempted to say in our report all of the things that we think will give this committee and the American people a way of judging what happened.

It was a system failure. And when you look at the report, you ask yourself, How could it have happened? I notice several comments by Members of Congress who read this over. They say they just don't understand how it happened, and we don't either for sure.

But I guess our job now, as I see it, is to get on with the work of how do we make it work in the future. Obviously there are lessons to be learned. We're not talking about that, but I'm not sure assessment of blame is going to be that beneficial to the future program.

I think the new Administrator of the program has that responsibility. He has to decide what management changes he wants and how he wants to deal with people that may have not performed up to their full responsibility. But I'm not sure that it does the Nation any good to undertake that—to try to answer that question.

What is going to be difficult for the Congress and for the administration, and for everybody, is: Where do we go from here? How do we correct it?

And I must say that Jim Fletcher's got a tough job, and I think he deserves the support of all of us. And these are difficult questions to answer in the future. And it's the responsibility of all of us.

Fortunately, we're—after today, I hope, or tomorrow we can step back into private life, but the problem is going to be with this committee and with the Congress and with Jim Fletcher and the administration.

I hope I haven't talked too long, but—

Mr. LUJAN. No; that's fine. I had one other—one question of Mr. Armstrong because he's had all kinds of experience through NASA—of course in the Apollo Program and you were a member of the President's Commission that Tom Paine had, plus this Commission. You've just been through the whole thing.

And we read sometimes that it's a different NASA today than it was perhaps in the Apollo days where safety was the prime consideration then. In other words, prove to me that it's unsafe would be what some people say is today the method of operation of NASA. Do you find a difference between now and then—then and now?

Mr. ARMSTRONG. Yes, sir, I do find some differences, but it's difficult to quantify what the effects of those differences might be, aside from the fact that we are involved in this particular investigation.

I suppose, at the risk of oversimplifying, in the Apollo days we always expected everything would go wrong and were surprised when it didn't, and in the current situation, at least the American public expects the shuttle to fly right and is surprised when it doesn't.

Mr. ROE. The Chair recognizes the distinguished gentleman from New York, Mr. Scheuer.

Mr. SCHEUER. Thank you, Mr. Chairman.

Mr. Rogers and Mr. Armstrong, we're very grateful for the time and the expertise and the real character definition that you've

given this report. You've rendered a great, great service to the American people.

And nobody up here wants to continue trashing NASA in any purposeless way, but there are some difficult questions that we have to answer. And one difficult question is this whole attitude, this whole new culture that grew up in NASA and perhaps in the Marshall Center, this culture that's been called arrogance, conceit that they knew it all; they didn't need to include in the information circle outside experts. They didn't need to listen to the Rockwell fears, expressed fears of the subzero temperatures. They pressured Morton Thiokol not to bother with a lot of chintzy concerns about safety. They excluded the astronauts themselves from the information circle. They had the feeling that they knew it all and didn't need any outside information. They didn't want anything to interfere with the schedule. The schedule seems to be the thing and not the safety and efficacy of the mission.

How do you change this? This is the job that you're directed us to solve, that you've given so much energy and emotion and intellect to. It's hard to sum up in a thumbnail sketch. How do you change that attitude? How do you institutionalize better information circles? How do you institutionalize access by all of these experts to very tough decisionmaking channels, if they had deeply seated concerns about safety, even in the last moments before the takeoff? And how do you legislate humility? How do you legislate openness? How do you legislate concern for safety?

These are tough questions for legislators. It's not susceptible to legislation, but we've got to get back to that old "can do" spirit where there was a team and safety and efficacy of the mission was No. 1; and that they wouldn't have dreamed of being—in the early years of being pressured by anybody, not that there's any evidence that I can see of pressure, unless it was self-imposed pressure.

How do we get back to the original driving commitment that safety to success with individual egos taking a second place and a whole new openness of attitudes?

Mr. ROGERS. I think you've put your finger on a key question the Commission talked a good deal about. I hope that that will be accomplished, in part by the report and in part by the investigation, in part by the fact that all of this became public.

And I—to illustrate your point, after we had the hearings which disclosed the opposition of the launch and the failure to communicate that to those people who made the decision to launch, we were all—I don't know whether shocked is too strong a word or not, but we were very concerned about that as a commission. And right at that time the people in Marshall who were involved had a press conference at which they sort of took issue with us, that we were making too much out of it, which to me illustrated the points you're making.

I mean, they have to vastly change this mindset. You can't go on this way as if nothing happened. This was a major, major mistake, a tragic accident, and it was witnessed by everybody in the world either at the time or subsequently on television. So there has to be a change of attitude.

And I'm not sure how it can be—we have the same problem you do, but I think it will be done by—first, by the fact that we've had

this investigation. We didn't pull any punches. All of the facts were laid out on the table, and we think that that will in itself be very salutary.

Second, it will be required of the leadership of NASA. You've got Jim Fletcher, a new Administrator. You have Admiral Truly that worked very well and hard with the Commission and I think will do an excellent job in that capacity in charge of the shuttle program. He himself is an astronaut. And he is just as concerned as all of us are about what happened.

In fact, he told us yesterday, which I think illustrates the point, that he flew on the second shuttle flight, STS-2, and on that flight they had difficulty with this joint. And he didn't know it, and he didn't know it until after this accident. And you know what kind of an effect that will have on his thinking, and his attitude toward what happened is just the same as the Commission's attitude. And I think that will be reflected in the whole program, and certainly that's what we hope.

Nobody could be sure that everything is going to be safely done. Everybody should know about the risks involved. If you're proceeding with a joint that isn't going to work, everybody should know it. You should say, "We're all going to take a chance on this joint not working." That may be necessary.

The problem here was people didn't know about it. If you read the report, you see the key people in the program didn't really know about the joint or didn't know about the seriousness of the problem. And I hope that the result of this investigation will be to correct that.

Mr. ROE. The Chair recognizes the distinguished gentleman from Pennsylvania, Mr. Walker.

Mr. WALKER. Thank you, Mr. Chairman.

Chairman Rogers, at any time was the Commission pressured by anyone not to fully report on the problems it discovered?

Mr. ROGERS. No, nobody—we had no discussion with anybody about that at all. In fact, we didn't have any discussions with anybody outside that I know of about anything, except the work that we were doing. We were moving so fast we hardly were able to take phone calls.

Mr. WALKER. So, in other words, the report as you published it represents your best thinking on what went wrong on everything that went wrong?

Mr. ROGERS. Yes; absolutely.

Mr. WALKER. With all—I spent some time going through the report last night, and I congratulate you. I think it really is a job well done. But with all of this going wrong, did you get any hint of why Congress wouldn't have seen at least some of these problems at some point before we had a tragedy?

Mr. ROGERS. No, I didn't. I'm not sure I would have answered if I did, but we didn't see any. [Laughter.]

We didn't see anything like that, Congressman.

Mr. WALKER. Well, but doesn't it strike you that in the oversight process that some of the problems that are revealed here should have in some way come out prior to having a tragedy?

Mr. ROGERS. Well, I said yesterday that—at the press conference we had after the ceremony that I think everybody's in part to

blame. I mean I think the administration, several administrations, took it for granted everything was working well. I think Congress probably thought the same thing and maybe didn't perform their oversight functions as well as they should. The press is in part responsible. I heard Mr. Hotz, one of the members of the Commission, on television this morning saying he was then the editor of Aviation Week, and he said he thought the press was in part responsible. I guess the American people themselves were in part responsible. We were all too optimistic about it.

And, as I say, I don't know if it serves any purpose to point fingers. I think Congress has to share the blame in part; so do the rest of us.

Mr. WALKER. I think that's a reasonable way of looking at it, but I guess my concern is that, as someone who has sat and listened to testimony over the years, a lot of these things were happening, they were knowingly happening, and nobody was mentioning it. Now is there anything that in your opinion was being done that was kind of a longstanding systematic coverup of some of these problems?

Mr. ROGERS. No, I didn't see anything like that.

Mr. WALKER. Well, then, how can we—how is it that we can be developing basically systematic problems, problems of management that are systemic, and yet nobody have a hint that a lot of these things were going wrong?

I mean, are we in a position in the space program where we are only going to be able to react to crisis?

Mr. ROGERS. No, I don't think so. I think that we have to keep in mind that we had 24 successful flights, and we were the most successful nation in the world in what we've done. So we can't just look at the dark clouds. There were a lot of successes.

Look at Neil Armstrong—a lot of successes, and we can't forget that. And we don't want to blame our Nation or ourselves too much. On the other hand, we don't want to overlook the seriousness of this problem.

I hope that our commission work will have accomplished that purpose. I hope that it's balanced enough so that it takes into account the successes of NASA and successes of our Nation and at the same time points the way for future progress in space.

Mr. WALKER. Well, at least one of the commissioners was reported this morning as stating that, if the *Challenger* accident hadn't happened, the program would be shut down now anyhow because that the resources are not compatible with the flight rates, and so, therefore, there would not have been enough spare parts availability; there would not have been enough resources available to keep the program flying.

Now obviously problems of that kind of a systemic nature didn't just develop overnight, and that has nothing to do with the public perception of the program. It has a lot to do with OMB. It has a lot to do with the Congress.

And I guess my concern is, after reading all of this, it seems to me that there was a fairly significant failure in the people who were providing policy direction to NASA, because I gather in the report NASA was doing a pretty good job of following the policies dictated to it; is that not true?

Mr. ROGERS. Well, as I say, I don't really want to get into the business of whether Congress was to blame or the administration was to blame or NASA was to blame. It's all there. When you read it, you can form your own conclusions.

I think Congress bears some of the responsibility. I think you will do a better job in the future. I think your oversight responsibility is great. It's going to be greater in the future, but I hope it's not negative. I hope it's all positive. We have to have the program. We need to have men in space. We don't need maybe such an optimistic program. We need some more ELV's, but we have to weigh very carefully what part of the program is going to involve humans and what part need not involve humans, but those are problems you have to decide, and they're not easy.

And I think we've laid out the problems that have occurred, what happened, and now it's up to Congress and the administration to try to deal with it.

Mr. ROE. The Chair recognizes the distinguished lady from Tennessee, Mrs. Lloyd.

Mrs. LLOYD. Thank you very much, Mr. Chairman.

I'm certainly glad to have you distinguished gentlemen with us, and we thank you for your time and all of your efforts on behalf of this country.

The *Challenger* accident, of course, is a real modern tragedy, and I'm reminded of the timeless dramatic tragedy MacBeth. Remember the humbling lines, "An eagle towering in its pride of place was a mousy owl popped at and killed."

It seemed to me that this modern tragedy of NASA, which is always the eagle to this committee, has not been killed, but it's certainly been wounded by pride, and our legendary high technology agency has become arrogant and careless.

Now I worry that public reaction could permanently cripple this eagle unless we do act constructively. And as members of this committee, we always believed that this bird would always soar and alight again unharmed. We want to know how you think that this committee could best aid in this process—to heal the wounded eagle. What do you think this committee can best do to aid the process of getting NASA to fly again, Mr. Chairman?

Mr. ROGERS. Well, that's a pretty tough question. I don't know as I have any advice. I think that the new administrator has a tough job, and I think Admiral Truly is very experienced, an astronaut himself, highly regarded by all the astronaut community and by, in particular, NASA, and will do an excellent job.

And I think that probably the function that this committee can perform is to pay a lot of attention, to be thoughtful about the problems of the future, try to determine the extent of financial support that is required and how it best can be used, to be sure that there is a reinvigoration of NASA; that there is a method that is devised to attract some of the leading engineers, the younger engineers.

I think to get back—it's going to be difficult to get back and have the same inspirational drive that NASA had to begin with because this has been a very traumatic experience for NASA, and in a way it may be that our Commission's work is going to make it tougher.

Mrs. LLOYD. Mr. Secretary, would you—

Mr. ROGERS [continuing]. But I hope not. I hope that what we've done will make it better, and I hope it will—everybody will say, "We made a bad mistake. We've got to correct it, and let's get on with the job." And I think this committee, if it supports NASA in that respect, will perform a real public service.

Mrs. LLOYD. Mr. Secretary, other members have alluded to the fact that maybe Congress didn't really assume the proper oversight role, maybe we were a little neglectful in really evaluating the programs of NASA. Would you recommend, or you, Mr. Armstrong, that we assume a larger oversight role; that we try to micromanage, or would you prefer that we try to back off and leave NASA some room to really bring in new procedures in the oversight? Would you comment on that, Mr. Armstrong?

Mr. ARMSTRONG. I'm not certain I'm prepared to give a well-reasoned answer to that, but just let me say—and it will also bear on Mr. Walker's question—that there's some evidence to indicate there was an imbalance between the goals and resources over a fairly long period of time, starting in the early seventies through the late seventies and into the early eighties. And the agency was trying to do amazing things, and did, and were pressed to do it with less resources in terms of people and financing, and so on. And they tried very hard to make—and did a remarkable job of making a remarkable machine with probably less technical insurance than they should have paid the premiums on.

Mrs. LLOYD. We've also alluded to the similarities of Apollo V two decades ago. Would you gentlemen like to comment on the similarities of these, of the two tragedies?

Mr. ROGERS. Here, again, I think Mr. Armstrong should answer that.

Mrs. LLOYD. Mr. Armstrong.

Mr. ARMSTRONG. I think many members of this committee were struck with the similarities, probably some differences, too, but similarities in that there were typical inadequacies that eventually caught up with the program and paid a severe price in time schedule and prestiges at the time, but Americans did what they do best—they stepped up to that kind of a problem and fixed it. I certainly hope, I believe, we can do it again.

Mrs. LLOYD. Again, I thank you distinguished gentlemen. Thank you.

Thank you, Mr. Chairman.

Mr. ROE. The Chair recognizes the distinguished gentleman from Wisconsin, Mr. Sensenbrenner.

Mr. SENSENBRENNER. Thank you, Mr. Chairman.

Mr. Secretary, I, too, would like to add my commendation to you and the other members of the commission for approaching this task with objectivity and calling them as you saw them. And I believe that the country is much in your debt as a result of the efforts that you made.

I hope that this set of hearings is used to put to rest all of the unanswered questions about the space shuttle disaster because I believe that the Nation and the space program can ill afford to have people second guessing the work of your Commission like we've seen second-guessing of the work of the Warren Commission into the assassination of President Kennedy.

In line with that, I agree with the fact that you didn't make any inquiry into individual responsibility, but during the course of your investigation did you come up with any evidence that you believe should be referred to the Justice Department for an investigation into criminal negligence?

Mr. ROGERS. No, I did not.

Mr. SENSENBRENNER. It's my understanding that Morton Thiokol did not meet the required spec limits on the solid rocket motor. Did your investigation reach this conclusion and, if so, why didn't NASA require them to meet specs?

Mr. ARMSTRONG. I don't think the Commission made the judgment on review of that particular fact and passed—and made a finding, Congressman.

Mr. SENSENBRENNER. I've been given some information that the specs for the solid rocket motor indicated that it was supposed to be functional between 31 and 99 degrees Fahrenheit. The chronology that your Commission has published as a result of your investigation indicated that at least at the middle, the upper middle level management engineers at Thiokol, the initial determination was not to launch because it was so cold in Florida at the time when the shuttle and the orbiter were on the launch pad, and that that was reversed—that decision was reversed as the discussions went on, and there was a recommendation made by Morton Thiokol to launch the night before the tragedy occurred.

Given the fact that Morton Thiokol was supposed to have built the SRB's to be launched at above 31 degrees Fahrenheit and there was some reluctance that the O-rings would crack by some of the engineers out there, what conclusions did you reach relative to the management decisions at Morton Thiokol and how that got reversed, and whether the reversal was caused by a fear of them having to admit that they did not meet the specifications that were set forth by NASA when they constructed the SRB's?

Mr. ROGERS. Mr. Chairman, can you hear us? I gather you're having a little problem.

Mr. ROE. We're having difficulties. I guess it's just the microphones, but go ahead.

Mr. ROGERS. I don't believe that that was the conclusion—

Mr. ROE. Much better [referring to microphones].

Mr. ROGERS. The conclusion that the Commission reached was they changed their minds—is that better?

Mr. ROE. Yes, much better [referring to the microphones].

Mr. ROGERS [continuing]. They changed their minds because we think that they were trying to accommodate a major customer. We say that in the report. In other words, they originally recommended against the launch unless the temperature was 53 or above, and after long, off-the-record—I mean off-the-telecom conference, they decided to recommend in favor of the launch. That was the management group, and the management group—one of the managers told the engineer, the chief engineer who had been against the launch, he should change his hat, go down—he should take off his engineer's hat and put on his manager's hat, and so they changed their mind and they sent a telex saying, "Go ahead and launch." And the Commission concluded that was done because they wanted to accommodate their major customer.

Mr. SENSENBRENNER. But here Thiokol delivered the solid rocket boosters for NASA allegedly meeting specs that were supposed to be functional over 31 degees Fahrenheit, and there were folks within the Thiokol organization that said you shouldn't do it if the temperature was under 53 degrees Fahrenheit. And I think that this is a major gap relative to the management decisions of this major contractor for NASA. Our oversight can fix up NASA's management by review. I'm wondering whether we really can fix up the management review of a contractor like Thiokol.

Mr. ROGERS. Mr. Armstrong had a comment on my last answer.

Mr. SENSENBRENNER. Yes.

Mr. ARMSTRONG. I don't recall the details of all the specifications on the original contract, but it's quite clear that the motor was obliged to operate under specification at temperatures greater than 40 degrees Fahrenheit. That was a low temperature of the propellant and, indeed, the low temperature of the propellant in this case had a temperature substantially above 50.

I do not recall whether there were specific requirements for ambient temperature, but there were launch commit criteria under which the spacecraft was obliged to fly at temperatures above 31 degrees, as you specified.

It should have been the responsibility of any contractor, in my view, if their particular piece of equipment that they were providing was not able to perform within that launch criteria to so identify that fact so that it could be factored into the launch commit criteria. We did not find evidence that that had been done in this case.

Mr. ROGERS. Dr. Keel might have elaboration on that point.

Dr. KEEL. I think, Congressman, there has been a lot of confusion about the various temperature specifications for the boosters. Part of that was brought about by the testimony that conflicts with the actual documents. I think that just came about over a period of time where the—with references to temperatures and the certification requirements was loosely referenced, if you will.

The 31-to-99 degree temperature requirement that's actually in the contract specifications refer to a storage temperature requirement for the solid rocket boosters and their propellant. During the program there were people who referred to that as actual performance specification requirements, but that's not what the documents support.

Mr. ROE. The Chair recognizes the distinguished gentleman from Florida, Mr. Nelson.

Mr. NELSON. Thank you, Mr. Chairman.

I might say that my understanding—that the actual design specs for the solid rocket booster was to go down to a temperature of 25 degrees Fahrenheit and be operational. And, indeed, that part of the evidence that was delivered to you all from the NASA investigatory team found that Thiokol had never tested down to 25 degrees, and that when asked why, nobody knew the reason—not in Thiokol nor in NASA—why it, in fact, had not been tested down to that design specification. And, therefore, that's one of the things that we'll continue to look at as we try to backstop your report.

And, Mr. Chairman, you have done an admirable service to your country, and I appreciate it.

Let me ask Mr. Armstrong just a quick question here. One of your recommendations in the design recommendation is "Full consideration should be given to conducting static firings of the exact flight configuration in a vertical attitude."

Our best estimate is that if you were to design a vertical test stand and instrument it and then go and build it, that you'd be looking upwards of 2 years, maybe a little less than 2 years, particularly if you're going to fire in the vertical position as it sits on the launch pad because you've got to have plenty of room underneath for the flame to get out, so you've got to get the SRB at least 80 feet into the air. I suppose if you turn it the other way, nozzle up and fire it with the flame up, but if you get it exact configuration, as you have recommended here, you're looking at upwards of 2 years before you can actually go out and test fire it in that configuration.

Do you have any insight, Mr. Armstrong, with all your background as to what you intended with regard to that specific recommendation?

Mr. ARMSTRONG. Yes, Mr. Nelson. It has been brought to the attention of the commission that several built facilities be modifiable to handle this very large test firing.

In addition, proposals have been made by some, including those within the agency, that the vertical firing be done in free flight.

And we did not have the opportunity to test the possibility of devising such a test, but the desirability is certainly there and we thought we should identify it, and there are those who believe it can be done without building a new facility.

Mr. NELSON. All right. You didn't come to a conclusion that, in fact, we should. You're just saying consider that as one of the options as you try to get the reliability on the SRB?

Mr. ARMSTRONG. Yes, sir, all consideration should be given.

Mr. NELSON. OK. Mr. Chairman, I'll reserve the balance of my time.

Mr. ROE. I thank the gentleman.

The Chair recognizes the distinguished gentleman from New York, Mr. Boehlert.

Mr. BOEHLERT. Thank you, Mr. Chairman.

Mr. Secretary, at the outset I'd like to say that the commission which bears your name and has benefited from your enlightened leadership does our system proud. I can't think of any place in the world where a failure of a national program, an inquiry into that failure, would be as thorough and as public as this one is. So I want to thank you and your colleagues, first of all.

But, second, let me say that I'm a natural for this committee. I got a D in high school physics and haven't taken a science or technical course since. [Laughter.]

But the benefit of that is that I would ask of you the same questions that I think the people I'm privileged to represent would ask if they were given the opportunity. And I note in your report that section which refers to the silent safety program. My concern is that it's a near invisible safety program.

For example, I understand that NASA does not have a specifically labeled risk management program. Further, I understand that from 1970 to 1985 the quality assurance personnel dropped from a

high of 1,689 in 1970 to 505 in 1985. And, further, when we're dealing with payload, I understand that while NASA audits the certification process, it does not perform any visual inspection of the payload for performance-to-safety standards.

It seems to me that with missions becoming a lot more complex, the risks are greater, we should have a dramatic increase in safety, and yet it seems to be moving in the other direction. Is that an area of particular concern, Mr. Secretary?

Mr. ROGERS. It is, and we address that in our report. As you see, we spent a lot of time on that, that subject. I think you're absolutely right—there has to be a lot more emphasis. And we recommended that a single person, an assistant to the administrator, be at headquarters with sole responsibility of safety—to devote himself directly and fully to that problem. And then we have set up—recommended some safety panels be set up which were consistent with the way the Apollo program used to work and consistent with the way the astronauts think it should work.

So you're absolutely right, and although some people point out that safety is the responsibility of everybody in the program, which is obviously correct, the fact is that in this case, whereas everybody said they were concerned about safety, they weren't going to fly unless everything was safe, the fact was it fell between the chairs. There was nobody that really was paying full attention to that subject.

And when people were briefed about the weakness of this joint, it was always in fine print or the footnotes, hardly noticeable. So we feel that you're absolutely right, and the thrust of our recommendation is that there has to be a lot more attention given to safety.

Mr. BOEHLERT. Mr. Secretary, did budget reductions have anything to do with the compromise on safety?

Mr. ROGERS. Well, I'm not sure I can answer that, but I would think so, yes.

Mr. BOEHLERT. Let me ask you another question. Did the commission have some difficulty in reconstructing some of the conversations that occurred between Morton Thiokol, for example, and the NASA people prior to the launch? Would one of your recommendations be that there be tapes of these conversations so that we can have for history a very accurate record?

Mr. ROGERS. Yes; that is one of our recommendations.

Mr. BOEHLERT. Let me ask something else of Mr. Armstrong, if I may. I think in your opening statement you made some reference somewhere along the line to crew escape. You said a bailout or an ejection system might not be practical or even desirable. Could you expand upon that?

Mr. ARMSTRONG. Yes, sir. What I—escape systems take a variety of forms from very simple jump-out-the-door to very complex systems in which an entire section of the vehicle is removed and ejected by rocket propulsion or some other means and recovered as a unit.

We think these more exotic systems are probably not practical to incorporate in this design at this stage, but the ones on the simple end deserve additional examination because as the system exists now for significant parts of the envelope there really is no method

of survival, and we believe some additional method of survival is possible.

Mr. BOEHLERT. But am I correct in assuming that this whole thing occurred within 73 seconds, so that any escape mechanism, any ejection system that might be conceived by man wouldn't have been enough to save the crew?

Mr. ARMSTRONG. Yes, sir, you're quite correct. We do believe that none of the systems that we've looked at, to the extent we've been able to look at them, would have been able to save the crew in this circumstance.

Mr. BOEHLERT. Thank you.

Mr. ROE. The Chair recognizes the distinguished gentleman from North Carolina, Mr. Valentine.

Mr. VALENTINE. Yes, Mr. Chairman.

I want to say to you I hope that this committee does not with your committee get any kind of NASA problem. You know you have received a lot of flowers since you have come in here, and I'm sure we won't make that same mistake.

I want to say to you seriously that I want to congratulate you, sir, and other members of this committee not only for what you have done, but for living lives that would equip you to be selected to serve on this committee. I think it's a credit to our country and to each of you, because what you have said I think in the work of the committee is perhaps some of the most important work to be accomplished in the history of the Republic.

And I just would like to ask you mainly one question. You have been very complimentary in what you said about this committee, and I think it reflects on the leadership, the chairman, the ranking Republican member, the subcommittee chairmen, and so on.

Do you feel that you received complete cooperation from all of the people at NASA with whom you came into contact, you and other members of the committee, whom you interrogated, and do you feel that you received full and complete cooperation from the contractors and subcontractors?

Mr. ROGERS. If you don't mind, let me take just a moment to answer that because it does divide itself into two parts.

After a week or so when it appeared to the commission that the decisionmaking process was flawed and there were a lot of people in that decisionmaking process who might have in some way failed to perform properly, we asked that they be excluded from any part of the investigation. And at that point NASA put in charge of the investigation Admiral Richard Truly who is going to continue in his work at NASA, and they cooperated with the commission fully in every respect. They responded to every request. They volunteered information that sometimes was embarrassing, and that cooperation on the part of the investigative panels of NASA under his leadership could not have been better.

And that was true generally throughout NASA. And you will see from the work of these panels, which is very voluminous, that they did a hell of a good job.

Now as far as—there was one aspect of it that we were not satisfied with, and that was failure of the people at Marshall to tell us some facts about their constraints, launch constraints. That was not known to the Truly people, and the Marshall people gave an

excuse why that had not been done, but we were not satisfied with that aspect about it. And I made some comments in the hearings about that, saying that they had almost been able to cover that up. Fortunately, we were able to find out that there had been launch constraints in five previous flights previous to 51-L, and that constraints had been removed without any particular reason, it appeared on the surface, and we were upset by the fact that the commission had not been advised of those constraints earlier on.

But as far as NASA as a whole is concerned, they cooperated fully, and they did one excellent job in all respects in giving us the information. And it's all available for your committee to look, and your subcommittee has worked very well with us. We've worked with your staff, and your staff will have access to all of our records. And Dr. Keel will be able to help your committee staff in that regard.

Mr. VALENTINE. Thank you, sir.

Thank you, Mr. Chairman.

Mr. ROE. The Chair recognizes the distinguished gentleman from Florida, Mr. Lewis.

Mr. ROGERS. Dr. Keel—excuse me just a minute—Dr. Keel just pointed out I have not answered your question, Mr. Valentine about contractor cooperation.

I think that in Morton Thiokol's case they did cooperate fully with us in providing documents. They were very cooperative. We had a lot of people out there from time to time, and they did give us the documents and they volunteered.

Initially in the conference, Mr. Locke, who is the chief executive officer, had with Dr. Keel—that they would cooperate fully, and I think it's fair to them to say that they did provide all the information we wanted.

Mr. ROE. Mr. Lewis.

Mr. LEWIS. Thank you, Mr. Chairman.

Mr. Secretary, let me also offer my words to thank you for the tremendous job you and your Commission have done in this tremendous report.

In the report the level III imposed a launch constraint on joints but waived that constraint. And the Commission recommendation is that a policy should be developed which governs the imposition and removal of launch constraints.

Now since the Marshall project manager, specifically Mr. Mulloy, which I'm reading in your report, the SRB manager, didn't feel inclined to communicate problems to the program manager, wouldn't the effect of requiring him to inform the program manager of a launch constraint, especially if this resulted in taking away the authority to remove that constraint, simply be for him not to impose a constraint in the first place?

Mr. ROGERS. Well, I'm not sure. I think the problem we have is that there seemed to be no criteria for—in the first instance in placing the constraint and no criteria for removing it. And what we have recommended is that they have a thorough review of that system, and if they have a constraint on a launch, then there should be a finding by a group or someone that they're going to launch anyway.

I mean, the idea of the constraint was don't launch until you fix it. "There's something wrong here, we find, and there's a constraint on this launch until something is done about it. It has to be corrected."

That appeared to be not the case. In other words, the man that put the constraints on just took it off, and the others in the system didn't even know about it. And, as you will see in the report, a lot of the key people in the system didn't even know there was a constraint on the launch, so the constraint was meaningless.

Now actually the constraint was a correct constraint. They shouldn't have launched until they fixed that joint.

Mr. LEWIS. That's the point, Mr. Secretary. It was clear that Mr. Mulloy really didn't think that he had a problem or a life-threatening problem with the—at this time, and he was the most qualified person, he felt, to make this decision on the SRB.

So could this be simply a poor engineering judgment? How would a change in the system affect that?

Mr. ROGERS. Well, I really don't want to zero-in on Mr. Mulloy especially. If he thought it wasn't life threatening, why did he have the constraint on in the first place? That's the whole point of the constraint—was there's something seriously wrong and it's got to be fixed before we fly.

Now if it's just placed on and then taken off willy-nilly, it's meaningless. It loses all significance. So what we recommend is the system has to provide, if there is a constraint, why did you put the constraint on, and then there has to be a judgment by the system why you take it off. Why do you risk the lives of the crew until something's been done to fix it?

So I think that NASA—I think that this report will have the result of being sure that the whole system knows about a constraint on a launch and it won't be taken off until it's either fixed or—I mean, you could imagine a situation where everybody says it's impossible to fix this; nonetheless, we have to fly; we have to take a chance, and we all know that we're taking a risk; let's go ahead anyway. Well, that's understandable.

What's not understandable is not having the knowledge that goes with it in having uninformed decisions made. Informed decisions are one thing, and everybody can accept that, I suppose, in a program that's dangerous. What you can't accept is to have ignorance be the controlling factor.

Mr. LEWIS. That's a good point, Mr. Secretary, and I think if the SRB's had run their quality test to full specifications as required, then a better judgment could have been made at that time, or the judgment wouldn't even have had to have been made; it would have been made on the quality test.

Let me ask you before my time runs out—I'd like to talk about level I and level II managers that didn't know of Thiokol's telephone calls the night before, and it had been suggested and known that Thiokol had concerns over the temperatures—my time is up. I'll come back and ask the question later. Thank you.

Mr. ROE. The Chair recognizes the distinguished gentleman from New Jersey, Mr. Torricelli.

Mr. TORRICELLI. Thank you, Mr. Chairman.

Mr. Rogers, you offered the judgment previously and answered questions from the gentleman from Wisconsin—in your judgment criminal negligence has not occurred and that a prosecution would not be in order. That is certainly a judgment that I share—that in the national interest it would—it does not make any sense to proceed in seeking a case of criminal judgment.

I have to, however, inquire whether your conclusion and my hope is not somewhat at variance with elements of the report. The threshold for criminal negligence in our country is not high. There has been a loss of life. It would appear on the facts that such a loss of life was not only possible but probable, given certain information; that that information by individuals in a position to halt the launch either was known or should have been known. Those are the elements of a criminal negligence case.

While I do share your hope and belief that such a case is not necessary or warranted, nevertheless, that is not a decision for us to make. I wonder if you could comment on those facts and the legal statements that I've made.

Mr. ROGERS. Yes, I'll be glad to. Well, first let me say that my answer was in response to a question, and I gave it individually. This was not a matter considered by the Commission.

Mr. TORRICELLI. Let me ask it on that basis to you, then, as well, individually given your own legal background as well as your chairmanship.

Mr. ROGERS. Well, as I say, I haven't spent a lot of time thinking about this, but I am satisfied that it would be unwise to proceed criminally. I don't believe there was any venality here.

And I don't really believe there was gross negligence. I think there was misunderstandings about what each person was responsible for.

In the case of NASA, it's such a big organization, so many people, that it has all the evils of a bureaucracy. Responsibility is pretty diffuse. In this case, the Marshall people felt that they had the right to make decisions because they were level III, that they had the right to make final decisions that dealt with this.

The others at level II did not think that was the case. They felt they should have been told about this. Mr. Aldrich so testified. He's head of level II, and his testimony was to the effect that we are responsible for improvements in all these aspects and we didn't know it and we should have been told, and that was the mistake of the system.

But in terms of criminal negligence, you can certainly say that the people at Marshall thought that they had the right to, what they call, close out this problem; they had the right to decide it, and they decided it.

And there were a lot of people involved in that decision. It wasn't just Mulloy, Mr. Mulloy. There were a lot of other people, too, as you will see from the record.

So I think it would be very difficult to prove the willfulness or even gross negligence that's required for a criminal prosecution. And, as you say, I don't think it would be in the national interest.

Mr. TORRICELLI. As a matter of policy, I agree with you. It just appeared to me that legally it might be an open question.

Mr. Rogers, the majority of the members of this committee have now cosponsored legislation to rebuild the orbiter. We did so, and it was introduced, in the belief as we followed your hearings that the basic shuttle technology was sound; that the accident was more of a failure of management than a limit on technology. And, therefore, the platform as a vehicle—our Nation's hope should at least in part continue to rest with the shuttle and we should proceed.

I'd like you to react to those conclusions since they were largely reached on the basis of things we were learning from your Commission—that those things that need to be repaired can be repaired, but that the basic technology remains sound and a good investment for the United States.

Mr. ROGERS. Well, I think we all agree with that, or at least I think the members of the Commission agree with that. And we've so stated—that we think that NASA deserves the support of the administration and the American people.

But I guess I should add that we did not deal specifically with the question of whether Congress should support a fourth orbiter or not.

Mr. TORRICELLI. Nor, Mr. Rogers, am I asking you to get to that question, but, rather, that the basic shuttle technology is sound. There are failures in the system, but they can be addressed and can be corrected. The United States can continue to rely on the shuttle technology. That's the only conclusion that I want to make certain that all members of the Commission are on accord.

Mr. ROGERS. I think that's correct. Certainly I feel that way, and I'm sure that Mr. Armstrong does.

Mr. TORRICELLI. Thank you, Mr. Chairman.

Mr. ROE. The Chair recognizes the distinguished gentleman from Pennsylvania, Mr. Ritter.

Mr. RITTER. Thank you, Mr. Chairman.

I would like to commend Attorney Rogers and former astronaut Armstrong and the whole team for one incredible report.

They say a picture speaks a thousand words, and I just turned to page 113, and I look at the system during the day of the launch and they've got icicles that are a foot long or more. They've got instrument boxes encased in ice.

Now I—you know, we're talking about the theory of a decision process, but it would seem to me that if this picture had ever been conveyed by those on the scene to other higher levels of management, in no way, shape, or form would a decision have been made to go ahead, given the O-ring problems, the temperature problems with the O-ring, the design specifications for the O-ring. It went down to 8 degrees that night, and they say the ambient temperature was in and around 30 or so that—at the time of the launch. It's very conceivable that the O-ring itself was well below the ambient temperature.

It's really hard to believe. I mean, it is almost outrageous, but I guess we go forward.

I'd like to ask some specific questions here. You've recommended many safety-related changes. You recommend institutional and organizational changes, changes on the equipment side—main engines, landing systems, joint redesigns and tests, et cetera. Do you have a feeling as to whether or not these changes could be satisfac-

torily resolved in time for a July 1987 resumption of shuttle flights? I think everybody wants the shuttle to move forward, but, boy, there's a lot in there, in these recommendations, prior to—

Mr. ROGERS. I think they can be implemented. I think they can be implemented quickly. I think they have to be.

And I think, as one of the other members of the committee suggested, it's a matter of mindset. I hope that the mindset of a lot of people at NASA has changed. We've got to get moving and there have to be changes made, and they have to be made quickly, I think.

I think one thing that we detected early on in the investigation which has changed was there almost was an attitude on the part of some people at NASA, based on their public statements, that the accident never happened; that the Commission was causing the problem. And I pointed out to some of them in private that we didn't have anything to do with the accident; we just came on later on, and it was a NASA problem. That's what caused the accident. That's where it happened. Those were the ones responsible.

Mr. RITTER. I'd like to ask astronaut Armstrong at this time—are we dealing with a climatological situation in this particular area of the country which is not conducive to an expeditious and efficient launch capability? I mean, I don't want to raise any hackles here, but there are a lot of people from Florida around—

Mr. FUQUA. I have to raise a point of personal privilege, Mr. Chairman. [Laughter.]

Mr. ROGERS. I forbid anybody on the Commission to answer that question. [Laughter.]

Mr. RITTER. Well, Mr. Fuqua, the distinguished chairman, and Mr. Lewis, my distinguished colleague are here, but you know we've just seen so many weather problems and so many temperature problems. At some point you want to say, "Is this the right spot?"

Mr. FUQUA. Will the gentleman yield?

Mr. RITTER. If the chairman allows me to take additional time, I certainly will to the distinguished chairman.

Mr. FUQUA. Well, maybe the Commission can explain where the ice came from because it didn't come from—it was cold weather, but it was not raining there. It came from an emergency shower that was left on to keep it from freezing, and the drain plug froze up and spilled all over and caused the icicles. So it was not necessarily a weather problem. Well, it was a weather problem that caused it, but it was not a—

Mr. RITTER. I would suspect that the weather kept the icicles there. [Laughter.]

Mr. FUQUA. Yes, it did. [Laughter.]

Mr. RITTER. If I could just reclaim my time and go on to the—you didn't comment, astronaut—I'm sorry, could you please?

Mr. ARMSTRONG. Well, with respect to your last question, it appears that the freeze protection system as implemented was imperfect and needs some changing, and I think NASA's fully aware of that and certainly will change that system that made the icicles.

The Florida weather has great advantages and its location has great advantages for launching. We've taken advantage of that for many years.

In the winter clearly the disadvantages that might be inherent were not well understood in this case; I certainly think they are now.

We've commented in the report about the vagaries of Florida weather at particular times of year with respect to recovery and made some recommendations in that regard.

With regard to your earlier question, which the chairman—to which the chairman replied, the safety recommendations with respect to tires, brakes, nose, wheel, steering, main engine, orbiter valves, et cetera, are not new problems. These are problems that have been well understood by NASA for many years. There's been active work going on in all these arenas, and those areas—those are tough technical problems, but there are proposals to do something about them, and we support their efforts to do that.

Mr. RITTER. I would ask the Chair for additional time for one further question.

Mr. ROE. The Chair will allow the gentleman extra time.

Mr. RITTER. I thank the gentleman from New Jersey.

Scott Carpenter gave a speech up in my district not long ago, and he went through the views of an astronaut from outer space seeing spaceship Earth, understanding that you can't see any of the artificial boundaries, thinking about the family of man, and then he jumped to the conclusion—and it was the end of the speech and the question wasn't asked, but he jumped to the conclusion that the United States must be first in space. And I think I understand why, but I would like to get for the record your views, having been so closely associated with the program in its entirety. Could you tell us briefly why the United States must be first in space?

Mr. ARMSTRONG. Who did you say made that speech?

Mr. RITTER. Scott Carpenter, your resident philosopher for many years, as I understand. But he didn't really explain it.

Mr. ARMSTRONG. Well, not having the advantage of specifically what he said, it would be difficult for me to comment on his remarks.

Mr. RITTER. He didn't explain why. I guess that's why I'm asking you. He sort of took it for granted, but I wonder if the American people take it for granted. And maybe a brief explanation would be helpful.

Mr. ARMSTRONG. Well, I do believe this Nation does enjoy a pre-eminent position in spite of these recent difficulties in the past several months. Our technology is remarkable and has served our country very well over these past 30 years. I personally have had the privilege of participating in that, and all the advantages which I have received serving on this Commission have stemmed from my—the gift of my country to me in allowing me to participate. So it's not really for me to defend that, but just note that I'm happy it's happened.

Mr. ROE. The Chair recognizes the distinguished gentleman from California.

Mr. PACKARD. Thank you, Mr. Chairman. I was expecting someone from the other side.

I, too, simply want to compliment—

Mr. ROE. We happen to startle people that way once in a while. [Laughter.]

Mr. PACKARD. Well, I appreciate the chairman's consideration.

I want to add my compliments to the chairman and to the Commission and all of you for the responsible work you've done.

When we spoke of attitudes, I had to make a note because I just returned, along with some of my colleagues on the committee, from Friday at the NASA—at the Kennedy Space Center where we were briefed by the NASA team of investigators. A distinct impression we got at that briefing was that there was no preventable way or no means of preventing the accident. In fact, in their major findings and conclusions they state that there was no action possible that could have resulted in survival of the STS 51-L crew.

And you have made it very clear in our briefings previous to this and in your report, I believe, it was a preventable accident, and that attitude still distresses me and disturbs me, and certainly I feel that arrogance and independence in any part of NASA's organization must be changed because it interferes, I think, with the communication systems that you have very carefully addressed in terms of leading to the problem, or part of the problem.

In followup of my colleague, Mr. Ritter's, questions, your report clearly identifies the O-ring joint as the problem, as the cause of the accident, with other related problems in combination with that design problem and flaw. They've known that for 9 years, and yet nothing was done about it.

Did the Commission uncover other major flaws in the total system that have potential of creating another accident, may not have been contributory to this accident but have potential of creating other accidents, that have gone uncorrected on the same basis?

Mr. ROGERS. I wouldn't say on the same basis, but we did uncover other problems that we think could cause a future accident. We refer to those and we suggest that they should be considered and improved upon. And you will see in this last part of the report a lot of discussion about that.

Yes, I don't think we found anything of a similar nature, if that's what you mean. I don't think we found that other things that were serious and had been called to the attention of the top people where nothing had been done.

On the contrary, we found—I guess probably the thing we found most—and I'm talking really, and Neil should be talking because he knows so much more about the system than I do, but one of the things that always concerned NASA was the main engines. And they realized that there was potential for failure there right from the beginning, and they dealt with it pretty well, and it's been surprising I think to everybody that the main engines have worked as well as they have.

And we have encouraged NASA people to continue to look at all aspects of each one of these components to be sure that they were dealt with properly. Obviously one of the things concerning the astronauts—the brakes and tires and landing facilities, and particularly at Kennedy because of the weather—

Mr. PACKARD. Do you—

Mr. ROGERS [continuing]. So these things are all referred to in our report, and I hope that while NASA's in the process of redesigning the joints that they will be able to deal with some of these other problems which are also very serious.

Mr. PACKARD. Do you recommend that we do not fly until these other potential problems are corrected?

Mr. ROGERS. Not as such, because I don't think that was our task. I think the Administrator, the new Administrator of NASA, has to make these judgments. I don't think we should make the judgments in advance, but we certainly have pointed out areas of serious concern.

Mr. PACKARD. Another question, Mr. Chairman—the flight readiness review program requires that all of the decisionmakers sign off 2 weeks, I think, in advance of flight, literally sign that the systems are go. Beyond that 2-week period, advanced period, there is no signoff procedure up to flight time but simply an opportunity for them to make comments, but there is no ability for them to cancel the flight or to sign that they feel that the flight ought not to go.

Are you recommending that that system be changed to where the contractors and other major decisionmakers would have some input right up to flight time in terms of whether the flight should go or not go?

Mr. ROGERS. Yes. We recommend that all conversations of that kind be recorded from now on and that, in the case of Rockwell, for example, where they recommended—where they thought they recommended against launch, and the NASA people said they didn't understand it that way, that all those conversations be recorded, so that everyone in the loop will have the opportunity to vote no launch, and the vote should be clear and concise. It either should be we vote launch or no launch, and there should be no ambiguity.

Mr. PACKARD. Thank you, Mr. Chairman.

Mr. ROE. The Chair recognizes the distinguished lady from Kansas, Ms. Myers.

Ms. MYERS. Mr. Chairman, I was very interested in your recommendation for a safety advisory panel, and I don't know—what role you envision them playing or how it should be made up, but I would like to say in all seriousness I think that there would be an excellent role for members of the Commission on this safety advisory panel. Your background at this point, your understanding of the problems that went into the attitudes that developed, I think would mean that you would serve very well.

You made a comment at the beginning about how you are looking forward to returning to private life, but I'd like to say that I in all seriousness am suggesting that as a new job for you.

Mr. ROGERS. Well, thank you. I would like to suggest Mr. Armstrong. [Laughter.]

Ms. MYERS. I guess my question is, Could maybe both of you expand on the role of this safety advisory panel, because I think it's key to a—as a preventive measure, so that this won't happen again? Who do you envision serving and how? Would they actually be onsite? Would they be advisory only? And could you expand on that?

Mr. ARMSTRONG. Thank you. It's intended that this panel be a working panel; that is, not a full-time job but people that are actively and intimately involved in the organization and the day-to-day activities. As such, it would prevent—or I shouldn't say prevent, but it would certainly minimize the possibility of unexpected

problems surfacing without an adequate safety review, similar to the question that we just previously asked about main engines and nose wheels, and so on.

We had intended that this be—although we were not specific about the membership, we indicated that it should have professional safety people, and we're thinking about NASA safety people, people out of the astronaut office, people out of the flight crew operations group and mission operations, the flight directors, and so on, people that are intimately involved everyday, and it will give a forum for anyone who has safety concerns about specific systems to have a court of appeals to get to and say, "Look, we're worried about this. We think it should be considered prior to flight."

It appears as though in past instances sometimes safety concerns were reviewed, evaluated, and, as NASA likes to say, dispositioned. But the people who had those concerns were unsatisfied. We think this court of appeals will give them a chance to have those concerns again reviewed.

Mr. ROGERS. Could I just also say that this recommendation resulted in large part from the concern of the astronaut office, and particularly Dr. Sally Ride, and I think it is, as you point out, a very important recommendation. We think the astronauts should be more actively involved in these decisions. Although on paper they seem to have proper recitement of responsibility, in fact they have not been as intimately involved in the program as they were at the time that Neil was in the program.

This is designed to be sure that there onhand—an in-house, onhand group of people available right there to deal with any of these things that might happen, and their voice will be very important and be listened to.

Ms. MYERS. I think, Mr. Chairman, in that if there is a villain in this, it seems to me that pressure is the villain, and I think you have identified that.

The attitude seems to have changed from one of total safety and "if you're in doubt, don't launch" to one of "we have to launch." The pressures were commercial, military, press, and I think Congress played a role in this pressure. Part of the pressure was for money; part of it was again a role that was referred to earlier—we've got to be first in space; we've got to get the payloads up.

My question is, did you determine how we can keep this pressure from building again? Because it will build again. The attitudes are still all there. And I sense it's starting already. We have already started talking about building a replacement orbiter. We've talked about we've got to get back into space again. So the pressures are beginning to build again.

How can we as a Congress keep this from happening?

Mr. ROGERS. I think that the oversight responsibility of the Congress is awfully important, but I think we also have to be careful, though, in our discussion of our pressures. In some ways pressures are what makes the American system work as well as it does. Everybody's under pressure of one sort or another, and I think it does create a lot of success, a certain amount of pressure.

I guess what we have to be careful about is undue pressure or pressure that overcomes your considerations of safety. And I think in an organization of this kind, where a lot of people are responsi-

ble, that's one of the risks, because you sort of are able to divide the responsibility. Here when you have so many people in the decisionmaking process, it's very easy for everybody to succumb to the pressure and say, "Well, we all agreed to it."

So I guess in answer to your question, I think Congress has a very important role to play in its oversight role, and I think don't the people are going to succumb to the pressure for a few years, but I think you're correct that as this program gets going again and is successful, and everybody begins to be optimistic, I think we have to be careful about that. And I would assume that Congress will be a major factor in seeing that doesn't happen.

Mr. ROE. The Chair recognizes the distinguished gentleman from Michigan, Mr. Henry.

Mr. HENRY. Thank you, Mr. Chairman.

Secretary Rogers, I'm wondering if in anticipating NASA's response if we might, first of all, divide the findings of the report from the recommendations. Are there any of the substantive findings of the report with which you believe, or have reason to believe, NASA is in substantive disagreement?

Mr. ROGERS. I don't believe so. I heard Mr. Fletcher this morning on television. He said he hadn't seen, been able to read all of it carefully, but he didn't seem to take issue with the report.

There may be people who, after they study it carefully, will have some reservations about it, but I rather doubt it.

Mr. HENRY. In the area of the recommendations of the report, are there any which you have reason to believe or your judgment would suggest would be bureaucratic or institutional resistance to the recommendations, any in particular, for example?

Mr. ROGERS. I don't think so. As I say, based on what we now know, I do not anticipate that, but it's always possible.

Mr. HENRY. On the issue of the kind of dilemma that NASA got itself into of increasing commitments in an environment of dwindling resources, to quote Mr. Armstrong, is NASA the innocent victim, or to what extent might this have been deliberate NASA bureaucratic strategy, as it were, to derive funds from the Congress by deliberately overcommitting and overextending in order to derive funds that were absolutely necessary to meet the commitments which had been made without cost levels being known to the Congress?

Mr. ARMSTRONG. I was not an employee of NASA during any of the years in question and cannot speak from personal experience there. I think it would be—it would be improper for me to try to make a judgment in that area.

Mr. HENRY. The gentleman from New Jersey mentioned that there are a number of people who have signed a bill appropriating funds for beginning a replacement *Challenger* shuttle type of vehicle. Without questioning the validity and the continuing need for a *Challenger* or Shuttle Orbiter Program, would it be prudent in your mind to commit these kinds of funds for a replacement or new vehicle until the fundamental questions posed and recommendations in your report are resolved, and above and beyond policy issues which your report raises, which in many respects are beyond the purview of the Commission relative to the role of expendable

launch vehicles in meeting mission demands as opposed to shuttle orbiters?

I'm just wondering whether each of you would give me—at least I guess you can't perhaps speak for the Commission, but individually what your judgment would be on the wisdom of appropriating funds for a new *Challenger* until those fundamental programmatic policy issues are resolved.

Mr. ROGERS. I want to address—answer your question, if I may, first. I don't think we should make any judgments on the fourth orbiter because that was not our job. And I don't think we can disassociate ourselves from the Commission. The reason you're having us here this morning is because we're on the Commission, and I want to try as much as possible to be sure that we speak as a Commission, not as individuals. And we think that role is one that should be performed by Congress, not by this Commission.

Mr. HENRY. Let me rephrase the question, because I think it's very critical, given the kind of political climate that we face. And I think you're aware of that from looking at the history of the program, the public nature of the program, and—which obviously has been one of the factors which got us to where we are, both in a positive sense and a negative sense, but generally a positive sense. It's been a very important issue here.

And when we have this talk about being first in space, is it really irresponsible to suggest that commitments, a \$3, \$4 billion replacement issue, ought to be—the commitments ought to be withheld until we're resolved some of these fundamental issues which were inherent in some of the bureaucratic positioning that apparently was taking place in NASA—to try to handle all launches, all role missions in manned vehicles, the contest between NASA and the military as opposed to ELV's and manned shuttles? Aren't these policy issues that ought to be resolved before we preresolve them by committing vast resources of money?

Mr. ROGERS. I don't think we necessarily have to do it in that timeframe. I think that the recommendations of the Commission can be put into effect fairly quickly, and I also agree that—with your suggestion that some of these safety matters should be dealt with right away. I think that there should be a reassessment of the brakes and the tires and some of these other aspects, and I think that that should be done. And if it requires more money, I think the money should be provided.

The thing I do not want to get involved in is the decision about the fourth orbiter. That's a function I think Congress should perform, and I don't think the Commission is prepared to make a statement on that.

Mr. HENRY. It's my understanding that roughly about 748 kinds of issues—[bell rings signaling time of the gentleman has expired].

Mr. ROE. Finish your question.

Mr. HENRY. Thank you.

There are some 748 issues on the criticality 1 list; that at one point the O-ring problem was on that list and was removed. Given some earlier comments you made that there are no known or discovered kind of safety flaws, kind of marginal risks equivalent to that, how could it be that the one most outstanding criticality prob-

lem of the list of then 749, to speak metaphorically, that that one item most critical should be removed from the list?

Mr. ROGERS. We can't answer that really.

Mr. ARMSTRONG. It was not. It was—permit me to—

Mr. ROGERS. Sure.

Mr. ARMSTRONG [continuing]. Make a technical correction. It was removed from the launch constraint list rather than the criticality 1. It was waived from the constraint list. It was not removed from the criticality 1. It was moved from criticality 1R to 1, properly so.

Mr. HENRY. Thank you.

Mr. ROE. The Chair recognizes the gentleman from Utah, Mr. Monson.

Mr. MONSON. Thank you very much, Mr. Chairman.

And I, too, would like to join with the others in expressing appreciation for the work that you've done and for the terrific service that it's been and for the excellent way that you've carried out that assignment.

I would like to know if you made any determinations as to whether or not there are any criteria that should be considered prior to a launch or in the design of any aspect of the shuttle or its components that are not now included as criteria to determine whether or not a launch should take place or in the design aspects.

Mr. ROGERS. I think, if I understand the question, we did in our first recommendation set forth some criteria on redesign of the joint, but I think that was the only one specific recommendation on a redesign—

Mr. MONSON. I'm referring to weather criteria or anything like that. Were there any—are there any factors that are not now included that you determined should be included in determining whether a launch should go forward or whether any design criteria should be met?

Mr. ROGERS. Well, as far—no other as redesign criteria. I think we have discussed with the NASA people—and I can't remember for sure whether it's in here or not—but that we felt that there should be more specific criteria for launches, particularly at Kennedy due to the weather. We feel that there should be specific questions, and they shouldn't be resolved on the eve of the launch, the day of the launch. They should be in place so that you would say—we didn't want to spell out exactly what they should be, but we did discuss whether any launch should occur at Kennedy, say, within 24 hours after freezing. That would be one way to do it. If there was a—if freezing conditions existed, you shouldn't have a launch for another 24 hours.

So I think NASA's aware that they have to look into those aspects of the weather, and I think we have made some references to the weather.

Mr. MONSON. Well, more specifically, we talk about ambient air temperature, but are there other temperatures that should be taken before a decision should be made to go forward with a launch? Wind conditions? I'm given to understand that perhaps one factor that entered into this was the violent wind shears that existed as the flight progressed that perhaps exceeded any previous experience. Is there any way to detect that, and should that be—have entered into the decision prior to the launch?

Mr. ROGERS. Well, we did—we had a lot of discussion about that, and we talked to the weather people. And they are going to try to get more accurate predictions about the weather. One of the problems is that they have some difficulty in determining wind shear at high altitudes, and they are improving the system of balloons that they have. They launch balloons so many minutes before the launch, and so forth, to determine that. And they are quite aware of that problem and I think will deal with it. It's not an easy problem, though. It's a very tough problem—to judge wind shears.

As you know, even in commercial aviation they have trouble with that, in predicting them in airports.

Mr. MONSON. Mr. Armstrong, did you have anything to add?

Mr. ARMSTRONG. I think the chairman hit the important points with respect to our criteria recommendations. They were first in the area of the joints, should the new design have joints, and, second, in the area of launch and recovery, particular emphasis on recovery at Kennedy and the criteria that should be established for that.

Mr. MONSON. With regard to your comments that NASA shouldn't have any more flights than their resources allow, given the resources that now are there with three orbiters and such, did you draw any conclusions as to how many flights are reasonable?

Mr. ROGERS. No; we discussed whether we should or not and we decided that we should not because it depends so much on developments. We certainly made it clear that we think they have to be more conservative. You probably read that Admiral Truly has made a statement, a policy, that they are going to be much more conservative in the future and they're going to limit the launches to the ones that seem realistic.

But we didn't think it was quite appropriate for us to run the program or to suggest. That will depend a little bit on developments, but I think they're going to be careful about it.

Mr. MONSON. Thank you very much, Mr. Chairman.

Mr. ROE. The Chair recognizes the distinguished gentleman from Idaho, Mr. Stallings.

Mr. STALLINGS. Thank you, Mr. Chairman.

Mr. Rogers, I've not looked at the report as thoroughly as I'd like to, but I'm interested in the civilian in space. Did your commission discuss that question at all? And, to the best of your understanding, will that program continue?

Mr. ROGERS. Here, again, the NASA people have said that they are going to—for the next few flights they're going to have just astronauts on the launches.

We discussed whether we should make a recommendation on that. We finally decided against it because there were a lot of different opinions on the subject.

Up to the present time I don't believe that the civilians in space program has been an adverse safety factor. I don't think that's entered into—it certainly didn't enter into this accident. And we didn't think it quite appropriate to decide—I mean, I notice that some people say we shouldn't have anybody except astronauts unless you have the press or—and others that say, well, you shouldn't have anybody except astronauts except scientific people

or somebody else. And I think that has to be a policy decision made by NASA.

I—speaking for myself, I think that the idea of teacher in space was an excellent idea. I think it would have been an inspiration for youngsters, teachers, and so forth. As it turned out, of course, it was very unfortunate, but I don't believe we as a Commission should make that policy decision.

Mr. STALLINGS. Perhaps Mr. Armstrong could talk about this, but I'm wondering if this is more of a public relations ploy, the teacher in space or some of the other civilian space programs, or if there is actual merit to those experiences.

Mr. ARMSTRONG. Mr. Stallings, I share the chairman's view. It was my sincere belief that this was a policy matter and it was beyond the purview of the Commission, and I prefer not to take a position on it.

Mr. STALLINGS. Thank you, Mr. Chairman.

Mr. ROE. The gentleman from Illinois, Mr. Fawell, please.

Mr. FAWELL. Thank you, Mr. Chairman.

I haven't had the opportunity—I suppose not many of us have—to fully digest what is before us here. And I know that basically of course you're dealing with the specific facts and don't want to get into policy.

Mr. Armstrong, you did make the statement, I think, at the commencement of these hearings that—and correct me if I'm wrong—that there has been a switch in philosophy, you feel, from a “can do” attitude, one where a launch was presumed unsafe until rebutted, until now it would appear that perhaps that mindset is that it's presumed safe until rebutted, which is an attitude of mind or a basic policy certainly.

When, in your opinion, was a switch made? Can you pinpoint it at all as to when this might have occurred?

Mr. ARMSTRONG. No, sir; I wish I could, but I only saw snapshots in the sixties, in the middle sixties, and now in the middle eighties. And I was not aware of what happened in between.

There are some differences, but there are many similarities, and I know that, for example, the management structure of the agency changed a number of times during the intervening period. The responsibilities, lines of communication, changed as Administrators and Associate Administrators, and so on, entered and exited the agency. Clearly, in the process of that, some of the procedures changed, but I am unable to be specific.

Mr. FAWELL. Mr. Rogers, do you have any comments in that regard?

Mr. ROGERS. No; I have less contact with NASA than Mr. Armstrong for sure.

Mr. FAWELL. At one time—and I haven't found this in the report—in fact, I must confess I heard it on TV last night, so that's how good my source is—but the statement was made that at one time there was a policy out of the White House that was unilaterally disbanded by order of President Nixon, and this particular observant said that this was quite a loss because we had some top lions that gave some policy and attitudes that perhaps we're deeply missing now.

And certainly the person at the top does an awful lot in setting attitude and policy.

Mr. ARMSTRONG. You're quite correct, sir. The act, as you will recall, provides—the act establishing NASA provides for the possibility of such a committee, and it did exist for some years and does not at the present time, and it's something that your committee may want to review.

Mr. FAWELL. Did the commission discuss this at all, the lack of such a committee in helping the unfortunate mindset, for instance, which we now apparently have at NASA not to develop or to rectify it?

Mr. ARMSTRONG. No, sir; this Commission did not look at that, but the Payne Commission did and I believe made a recommendation in that regard, the National Commission on Space.

Mr. FAWELL. Do you believe—again, this is perhaps out of your orbit—but the growing entry of the military into the use of shuttles, do you believe that this had anything to do with the increased pressure more than perhaps it should? Have you discussed—what about the future now that the military is certainly banging at the gates and very impatient about moving ahead?

Mr. ROGERS. Well, we discussed, of course, the idea that—the fact that the military payloads which were included in the space shuttle increased the pressure for launches. And we also pointed out that having sort of total reliance on the shuttle was not a wise judgment, and that will be changed in the future, because there are going to be more ELV's now in the picture.

So, to that extent, the answer to your question is, yes, we did consider that, and we think that will be changed now.

Mr. FAWELL. I just have one other—I think several people have expressed themselves in regard to the question of negligence or willful wantonness or whatever. The one phrase uttered by you, Mr. Rogers, which certainly caught me was your comment that Thiokol apparently changed their minds because they were trying to accommodate a major client. To me, if that is so, that flirts with willful wantonness, wouldn't you say so?

Mr. ROGERS. As I say, I don't—I've been out of the role of being a prosecutor for a long time, and I don't—so I don't want to be an authority on willfulness or gross negligence. I don't—it doesn't seem to me that prosecution would be successful of anybody in this tragic accident.

It's not beyond the realm of possibility that some ambitious prosecutor would think it was a desirable thing to do and make an attempt to do it. I don't think it would be successful. I don't think it would be in the national interest, and I hope it doesn't happen.

Mr. FAWELL. Thank you very much.

Mr. ROE. The Chair recognizes the distinguished gentleman from Virginia, Mr. Slaughter.

Mr. SLAUGHTER. Thank you, Mr. Chairman.

On the matter of pressure, with reference to the number of flights that NASA was planning, did the Commission find any definite indications of detrimental effects of the number of flights that were being planned and worked on?

Mr. ROGERS. I'm sorry, I don't think I understood the question, Mr. Slaughter.

Mr. SLAUGHTER. Well, I understand that one of the pressures that NASA was under was the number of flights it had scheduled; that they had cut back a number of times. But did the Commission find any definite detrimental effects of that heavy schedule that, originally, NASA had decided upon that had any effects upon this accident?

Mr. ROGERS. Well, you know, you can't trace those things specifically, but I think that the fact that NASA could not maintain its schedule, was quite conscious of the fact of a lot of delays in their schedule, it wasn't meeting the schedule, must have played a part in the psychology of the people involved, so there would be a natural tendency to say, "Gosh, we don't want to slip up. We want to try to get these launches off as quickly as possible."

Now nobody said to himself, "Let's take a chance. This is going to—we've got to meet the schedule and, therefore, we're willing to take a chance that this going to be a catastrophe." Nobody said that, but it's quite possible that, being human beings, that they would react to the feeling that they had to meet the schedule.

Mr. SLAUGHTER. Thank you.

Mr. ROE. The Chair recognizes the gentleman from Pennsylvania, Mr. Walgren, the distinguished Representative.

Mr. WALGREN. Thank you, Mr. Chairman.

I would like to say at the outset how important a document, I think, and service you've provided to the Nation. My greatest fear at the moment of this accident was that we'd never have any idea what on earth happened, and at least now we have a very clear definition of cause and a very solid evidentiary framework from which to work.

Mr. ROGERS. Thank you.

Mr. WALGREN. Let me ask—is it the belief of the Commission that the O-ring failure and the failure of the joint was the real cause of this accident?

Mr. ROGERS. Yes. There is no doubt in our minds about that. I think everybody that worked on this has come to the same conclusion, and I hope that there will be no way to change that conclusion. I think it's a solid conclusion that is not subject to controversy.

You not only have initial puffs of smoke, eight puffs of smoke within the first 2 seconds, 2½ seconds, which coincide with the twang of the shuttle itself that has a—it's like a tuning fork, and those puffs of smoke coincided with that twang. So it's pretty clear that the joint failed at the initial stage, and then you see the plume and that comes about at the same spot on the joint, so you can identify that the smoke came from about a 300-degree mark on the joint. When you see the plume appearing, it's at the same spot, and it's clear that that plume means that that joint failed again, partly because of the wind shear, and that then acted like a blow torch and destroyed the strut, probably breached the external tank, the external—

Mr. WALGREN. Can you evaluate the contribution of the wind shear to the question or is the joint itself a sufficient cause?

Mr. ROGERS. Well, you can't be—you know, you can't say for certain that if it had been a totally calm day—

Mr. WALGREN. They might have made it through?

Mr. ROGERS [continuing]. They might have made it. But there's no doubt that the joint failed, and there's no doubt that the joint caused the accident. And we were concerned as a commission that we might come to that conclusion based on the evidence I just cited. Incidentally, the top part of the external—on the external—I mean of the booster hit the external tank, so there was a breach at the bottom probably caused by a strut breaking, and the collision at the top which indicated to all of us that that's what caused the explosion. So probably there were two breaches.

But then we were concerned that we might decide that and conclude that and then the debris would somewhere later on be discovered and it would turn out that our conclusion somehow wasn't correct. As it turned out, the debris confirmed exactly what happened because it's still at the same spot. So there can be no doubt—

Mr. WALGREN. I would like to emphasize at this point and note that you used words in the report like "the genesis of the accident," because I think that we have to follow that cause to really understand the responsibility for this accident in the long run.

And I am concerned that we, because of the emotions and the investment that we all have in the space program, that we will not define the responsibility in a way that it will change the attitude that you have pointed out in NASA, and that must change.

And I just would like to raise my little flag of warning that there's every indication that it's going to be a very, very difficult thing to change, and that the necessary degree of caution to be built into this problem shows every sign of yielding to the pressure and the emotions and the forces that would push beyond safe operation. And I hope this committee can play a role in preventing, to the ultimate degree that that's possible, that very thing from happening.

Thank you.

Mr. ROE. I thank the gentleman.

The Chair recognizes the distinguished Representative from California, Mr. Mineta.

Mr. MINETA. Thank you very much, Mr. Chairman.

Mr. Secretary, I first want to join all of my colleagues in expressing my gratitude for your work on the commission, as well as the other commissioners, not only in terms of the results here, but also the great public service that you have rendered to the American public.

Mr. ROGERS. Thank you.

Mr. MINETA. Mr. Secretary, I'm anxious to have a more thorough understanding of the relationship between contractors and NASA. One question I have in this regard is, Is there a standard operating procedure pertaining to the launch readiness procedures that was woefully ignored in the 51-L mission and perhaps many times before?

In the case of SRB's, Thiokol was talking to level III people in NASA. On the other hand, it appears that Rockwell was talking directly to Level I people. Moreover, Thiokol was asked for written affirmation of their consent to fly. Rockwell was asked for no such assurances. And it is unclear to me that anyone spoke to the exter-

nal tank contractors about the ice situation or, if so, what was the procedure.

Aren't there procedures, Mr. Secretary, which need to be established or perhaps newly adhered to in order to make this process less erratic and, more importantly, more reliable?

Mr. ARMSTRONG. If I may, sir, first, I think the flight readiness procedure as conceived and executed by NASA in general is a very good and comprehensive one. It really permits and requires every element at the foundations of the system, both contractors and Government agencies, to voice their approval in a formal fashion, in a pyramid style, until all elements are completely covered. I think it is a very good system.

We've revealed a few times when it worked imperfectly. I believe that we can say that in this case all the elements were interrogated and asked to provide their—any dissatisfaction they might have with the conditions forthcoming at the launch the day before. And both contractors did so, but as the report points out, in an imperfect fashion.

Mr. MINETA. You're careful to inform us that the level I decision-makers were not informed about the O-ring problem and the temperature hazards. Now O-ring problems have been mentioned in reports in the past, and that full-scale briefings were conducted among top agency people.

I raise this point not to affix blame. I'm just trying to understand the information flow. It appears that the information flows upward in flight readiness reports which are naturally abbreviated, given the closeness to launch time, but is there a mechanism between launches where past readiness reports or past problems are reviewed to demand accountability for efforts to fix recurring problems or to explain repeated waivers?

Why do I have the impression that information only percolates upward at the will of middle management people without a corresponding accountability operating in reverse?

Mr. ARMSTRONG. You bring up a very good point, Mr. Mineta.

It was the commission's view that the information did probe—proceed forward, but was shortcuted. In the case of Rockwell, that information was conveyed directly on the moment of launch in response to the temperature concerns. That was level I because Level I happened to be at the meeting on the day before launch.

Mr. ROGERS. But also, just so we don't get confused about the levels, it's what—the point you're making is a good point, and that is, there was responsible level I, II for knowing things about this joint which they didn't do much about, so we don't want to put all the responsibility all level III.

But in the case of both contractors, they had plenty of opportunity to make their views known right up to the time of the launch. Morton Thiokol had already changed its view, so it didn't have anything to report. In the case of Rockwell, they did express views which turned out to be misunderstood, I guess.

Fortunately, from the standpoint of the Commission, fortunately, that did not contribute to the accident. Now there was a breakdown generally in how they dealt with the information about the past failures of this joint, and we try to point out in the report how

that happened and we try to make recommendations to be sure it won't happen again.

Mr. MINETA. Thank you, Mr. Chairman.

Mr. ROE. The Chair recognizes the distinguished gentleman from Texas, Mr. Andrews.

Mr. ANDREWS. Thank you, Mr. Chairman.

I want to first join my colleagues in complimenting you, Mr. Rogers and Mr. Armstrong, and the other members of the commission for the job you've done. It's thorough, definitive, and very well done.

The irony of all this is that as we view, I suppose, man's worst space disaster, we stand right on the threshold of some of man's greatest achievements in space. And I think, Mr. Rogers, your comments in your opening statement are very true. The real charge of this committee should be where do we go from here. How do we insure the safety of future crews and how do we make this system work for the future?

Specifically, you mention and recommend three things relative to the astronauts themselves—that they have a larger role in the decisionmaking process. You've recommended that astronauts become part of the management systems of NASA. You've recommended that they participate on the safety advisory panels, and that the flight commander himself have some say in the decision to launch or not to launch.

I wonder if you characterize the problem as it exists, or as you found the problem, as to the lack of input on the part of the astronauts and how you came to evolve in these specific recommendations for the astronaut corps.

Mr. ROGERS. Well, let me take them one at a time. In terms of management, we realize that there really are not very many astronauts in management now. Earlier on in the program there were some.

And we also learned that Admiral Truly, who has turned out to be really a superb executive, was in NASA and left because he really didn't feel he had an opportunity in management. So after this accident, he's been asked to come back and serve in NASA, which suggested to us that there probably are a lot of other astronauts who might like to go into management who would be superb at it and haven't had the opportunity. So we've urged NASA to consider the astronaut community as a source of excellent management material. Some may not want to, but there's excellent people there, well educated, experienced, knowledgeable. They know all the risks.

Second, we—although the astronaut office has been a useful office, we think that they have not had direct access to the top to the point that they should. There's sort of an intermediate level there. We want that office to have direct access to decisionmakers in all respects.

Third, we want them to be involved in the panel so they'll have immediate impact on launches and things of that kind, and we spell it out in the report.

So these are things that we have learned from our investigation. We worked very closely with the astronauts and the astronaut

community, and I think they all feel that their views have been fully taken into consideration.

Mr. ANDREWS. You know, one of the things in testimony in the last few months—one of the astronauts testified that they have a procedure where the astronauts themselves overfly the site the morning of the launch to get a personal feel for the weather. And when they were asked what kind of input do you have, if you made that decision not to launch after that flight or during that flight—your senses, your instincts told you that the weather was not right, what kind of input do you have as to not to launch? And the response was that they did not know. They did not know how much impact their decision, their judgment, would play in that decision-making process.

Mr. ROGERS. And that's why, one of the reasons, we have the safety panel setup, and I'm sure that it will work. Everybody now is going to pay attention.

Mr. ANDREWS. Thank you, Mr. Chairman.

Mr. ROE. The Chair recognizes the distinguished gentleman from Texas, Mr. Barton.

Mr. BARTON. Thank you, Mr. Chairman.

I made a statement the day after the accident, the *Challenger* accident, that I would go up in the shuttle that day. Contrary to Mr. Boehlert, I'm trained as an engineer, have worked as an engineer in quality control, and have always had this absolute confidence that NASA and its procedures and its people were first rate and that safety was paramount.

Well, after following through the press and the briefings and your commission report and findings, and going over them, I don't have that confidence. I wouldn't go up in the shuttle today. Quite frankly, I'm not sure that we ought to be even thinking about continuing our shuttle flights until we're absolutely certain that everything is first rate again.

I think it starts at the very top. I think NASA's leadership has not intentionally, but just through time and the pressures that you referred to, begun to overload some of the safety problems, and I think safety has just not even become an issue.

In your report you talk about the silent safety program, and I think that's what it was.

So I am going to try to participate very fully in these hearings an insist that we reestablish leadership and that we reestablish safety as a critical importance.

With that as where I'm coming from, it's my understanding that one of your commissioners, Dr. Feynman, had some recommendations that were thought to be too inflammatory and so are not in the report. Now I have no problem with the recommendations that are in the report, but I would like to know what his recommendations are and why they're not in the report.

Mr. ROGERS. Well, I don't know whether you saw him on television last night. He was on the "MacNeil-Lehrer Report," and he explained that and said that he's perfectly satisfied with the report as written; he supports it. He wrote a paper which is going to be in the appendix to be labeled personal observations on reliability of the shuttle, and there really wasn't any problem with him. He said so.

This piece that he's done deals with—largely deals with probabilities of accidents, failures, and it's an interesting paper and should be in the report, and we all agree with it.

It didn't fit into the flow of the report very well, and it wasn't something that the whole commission considered as such, but there really wasn't any problem with it, and he said so last night.

Mr. BARTON. Well, if I could just quote from the New York Times, it says:

At least one commission member, Dr. Richard Feynman, a Nobel prize winning physicist from Cal-Tech, is said to have objected to the deletion of some phraseology highly critical of NASA and to have complained that the commission has little evidence to support some of its praise of the agency.

Although Dr. Feynman would not describe the nature of his objections, he said, "Mr. Rogers is worried that all of our recommendations and findings are so negative it will look like we're vindictive or carping or trying to kill NASA. I, myself, believe that's just the way the investigation came out."

I've read what has come out. I don't view it to be negative or carping. I think we need to have all the facts before us. And as you so well indicated yourself, you have conducted the investigation; it's up to us to set the policy, but we need to know all the findings.

Mr. ROGERS. I agree with that. And, as I say, we're pleased that all commissioners support this report, and Dr. Feynman support it enthusiastically. I think that it's quite remarkable that this group of people with such diverse backgrounds and so many talented people all came to the same conclusion unanimously without any exception, and we did try to present a balanced report. We've certainly not been easy on anybody. We haven't—

Mr. BARTON. I understand that. Well, let's go on. I assume at some point in time, Mr. Chairman, we will have Mr. Feynman before our committee and we can ask him about his recommendations.

Mr. ROGERS. Well, I hope that you—there's no reason not to have Dr. Feynman here. I would hope, though, that it doesn't—these things don't ever develop into such minutia. I think it's too important for the Nation.

We have—obviously in a commission of this kind we had numerous discussions about language, how do we state things, and we sat together for about 10 days and went over this report page by page and word by word, and there were all kinds of views expressed. To me, the remarkable thing is that we all agreed.

Mr. BARTON. Mr. Chairman, can I ask one question of Mr. Armstrong?

Mr. ROE. Yes; go ahead.

Mr. BARTON. If you had been the commander of the spacecraft on launch day and known about all the discussion that had gone on the day before, the night before, with regards to the O-ring, would you have made the decision to fly?

Mr. ARMSTRONG. I would have hoped that I would have been involved and aware much longer before, than just the night before, and had a chance to evaluate the problem and pass my own judgment on it.

It's hypothetical, and I don't know how I might have ruled had I been provided that information, but I certainly would have wanted to have had it.

Mr. BARTON. Thank you.

Mr. ROE. The Chair recognizes the distinguished gentleman from New Hampshire, Mr. Smith.

Mr. ARMSTRONG. Mr. Chairman—

Mr. ROE. The gentleman—

Mr. ARMSTRONG [continuing]. May I interrupt, sir?

Mr. ROE. Yes.

Mr. ARMSTRONG. I'd like to—Mr. Mineta asked a question, and I failed to answer it and I would like to acknowledge that I did and give him the answer, if I may, sir.

Mr. ROE. Of course. If the gentleman would withhold from New Hampshire for a minute, go ahead.

Mr. ARMSTRONG. He asked a question about the FRR's and the trend of information from previous flights, and that is an important point. And the FRR procedure is primarily to go back only to the immediate previous flight and review that information in a closeout of all open items since that time. And it neglected the exact point that you mentioned—what is the trend of events over a number of previous flights.

And in our report you'll find some recommendations with respect to trend analysis, and we suggest that that properly should be the function of a good safety organization and they should be doing that monitoring as a part of the FRR process. And I wanted to get that point in because I thought it was significant and—

Mr. MINETA. That is encouraging, Mr. Chairman, if I might add, because I Chair the Aviation Subcommittee. And when FAA goes over the reports of the airlines, when you have these deferred items carried over from one report, from one airplane, from the same airplane, from one time period to another, then you can see why things like the Eastern Airlines and the \$9.5 million fine and 78,000 violations occur, because they have deferred maintenance items that have just stayed there consistently over a long period of time.

Mr. ARMSTRONG. Thank you, Mr. Chairman.

Mr. ROE. I thank the gentleman from California.

The gentleman from New Hampshire.

Mr. SMITH. Thank you, Mr. Chairman.

Mr. Secretary, I'd like to join the chorus of those who have been commending you. I think the President chose wisely, and I commend you and your entire committee for the work that you have done.

I, as a layman in this matter, both in a congressional oversight responsibility as well as just a private citizen—I find a strange inconsistency in this thing about safety over the past several years, and I don't know many—was it 50-some-odd manned space flights—we get down to countdown and we have countless delays, postponements, sometimes cancellations, and safety always seemed to be the thing on the front page—we didn't fly because something wasn't right.

What was different this time? Were we lucky for the past 20 years or so? Were these flights—were we just plain lucky and we were doing things wrong all along or, if not, what was different this time?

Mr. ROGERS. Well, it's difficult to answer that in a word. What we are trying to do in this report is to answer it. I mean, we would hope that the American people are interested in it, would read the report, and I think the report does answer that question. I don't think it's possible to answer it in a word or in a sentence or in a chapter. I think you have to read it all to come to your conclusion. And I think the report does answer that question.

Mr. SMITH. All right. You made a statement which kind of jumped out at me and caught me by surprise, frankly. And I'd like you to just make sure you meant it and—

Mr. ROGERS. I probably didn't.

Mr. SMITH. No, you made a statement which—I wrote it down—you said, "Budget cuts probably did impact safety at NASA."

My question—

Mr. ROGERS. Excuse me. I couldn't quite hear you.

Mr. SMITH. "Budget cuts probably did impact safety at NASA."

And my question is this: we've sat here over the past several months, several years for many of us, and never heard that from NASA, never heard that from a countless number of witnesses who have come before this committee.

Can you give me some specifics as to why you might come to that conclusion?

Mr. ROGERS. Well, I guess you can—you can always argue that you have more money, you can do a better job. So maybe my answer was premised on that thought, but I think that there's more to it than that.

In this case we examined two aspects that—specifically, one was the fact that they're cannibalizing the orbiters; in other words, taking parts from one shuttle, putting them in another because they don't have spare parts and they don't have enough orbiters. So cannibalization is a very dangerous process. You have to make all kinds of adjustments when you do it.

So certainly if they had—they'd asked originally for five orbiters and they didn't get them. So if you cannibalize, take parts from one to the other, put it in the other, it obviously is dangerous. It has some tough aspects.

Furthermore, they are running short of spare parts. Now why they were running short, I'm not sure, but they say that they're running short because of budgetary considerations. And there's testimony before the Commission that if they would have had to continue the program at full speed, that they were going to be running out of spare parts, and it would have been dangerous. And that's in the report, too.

So I think my answer was based on those facts. I can't say that specifically it was budgetary in this case, in the case of the *Challenger*, but you certainly could say over a period of time, maybe if they had had five orbiters and a little more money, it would have been a safer operation.

Mr. SMITH. did anyone that you spoke to in the course of your investigation from NASA or from any other witness—any other witness that you asked that question, did anyone give you a yes to that question? Did they say, yes, budget cuts did impact safety? Did anyone say that?

Mr. ROGERS. I'm not sure they used that word, but they—and they didn't say it in connection with the *Challenger*, but they said it in generally speaking, yes, sure; the astronauts did.

Mr. SMITH. Because I think from a congressional oversight responsibility, Mr. Chairman, I think my concern here would be when we have the experts coming before this committee not ever saying that to us, my concern is I think we should be interested more in priorities. We certainly would have canceled some other mission, not necessarily dealing with the orbiter, but perhaps some other project in the whole scope of the budgetary process with the whole program of science and technology perhaps to focus in on safety. And so I think—it is not meant to be directed at your committee, but I think that at the congressional oversight level, I think we have a lot of work to do, because I have some real concern about this being almost a—we were caught up, as somebody said before, in the momentum here of everything's going well, all these successes, and now we're—just keep moving. And I think this committee, frankly, this congressional committee has been caught up in that, and I was very much surprised to hear that, but I think that will certainly change my attitude.

Mr. ROGERS. I want to be sure, if I may, make one more response—want to be sure that I'm not suggesting that budgetary considerations played a part in this accident. I wouldn't want to leave that impression.

Mr. SMITH. May I ask one quick, followup question? I know we're out of time—but just one quick question.

Mr. ROE. The gentleman from New Hampshire?

Mr. SMITH. Did you have any evidence that the crew would have had any inkling of this O-ring problem in the flight? I have not read your report in its entirety, so if it's in there, I could go back. But was there any inkling at all in that 70-some seconds that the crew—would the pilot have had any possible ability of knowing what was going on?

Mr. ROGERS. I don't think so.

Mr. SMITH. Thank you.

Mr. ROE. The Chair recognizes the gentleman from Illinois, Mr. Bruce.

Mr. BRUCE. Thank you.

Mr. Rogers and members of the Commission, I join with the others in commending you for the fine work that you've done in determining the cause and recommending corrective actions for Congress. Now we have to evaluate and fund many of your recommendations, and so my questions really are some questions that deal with the power of the purse that we have.

It seems that eight of the nine recommendations that you have made to us entail increased cost, and at least in two of the recommendations, recommendation No. 1 on design and No. 7 on crew escape, you ask NASA, and indirectly the Congress, to take a different look at how we consider cost. You've observed through your review a number of wasteful practices at NASA. And can enough waste and mismanagement be eliminated at NASA as it presently is formulated to make a mission acceptably safe within the current budget levels?

Mr. ROGERS. Mr. Bruce, I really don't have the capability of answering that. I don't know enough about the subject to answer it.

Mr. BRUCE. In your review did you find any practice at NASA that should be brought to our attention, that we should look at in the way of waste within NASA, problems they have with overexpenditure?

Mr. ROGERS. I didn't. Possibly Mr. Armstrong—see, we really didn't have the mandate of looking at everything. We were not an oversight committee to review everything about the shuttle. We were asked to deal with the accident, how to prevent future accidents. We didn't go into whether they were doing it in an extravagant way or not. So I just don't—I don't have the ability to answer it.

Mr. ARMSTRONG. I have to agree with the chairman. I don't think we have the basis for passing a judgment, but as a footnote to that comment, let me just say that it seems to me that it's important not only to ask, can you do this job with this kind of money, but, secondarily, can you do this job with what level of confidence with this kind of money. Because the additional funds that are provided to do a particular program are used to pay premiums on additional insurance policies basically, doing additional testing, getting additional confidence in the abilities of the systems to do the jobs, and so on. And so I suggest that you demand agencies, when they come before you, to try to in some way quantify what level of confidence they might have with that level.

Mr. BOEHLERT. Will my colleague yield on that for just a moment, please?

Mr. SMITH. I'd be happy to yield.

Mr. BOEHLERT. Mr. Secretary, I'm glad you said that budget considerations did not appear to play a part in this accident, because, according to a staff report we have—and I would like to just read a portion of it—

"NASA engineers and management were aware of the joint problem in 1978 and had observed O-ring failures in the form of erosion and bypass during tests and after flight; yet, NASA procedures were ineffectual in correcting the problem prior to the STS 51-L accident."

So that doesn't seem to be directly related in any way, shape, or manner to budgetary constraints. As a practical matter, for the last 5 years we've increased the budget for NASA, although I understand because of inflation it really boils down to level funding. But I think that's important to have that on the record, Mr. Secretary, and I'm glad you emphasized that. Thank you.

Mr. ROE. The gentleman from—

Mr. BRUCE. One question on safety: your recommendation, your second recommendation is that we would establish a shuttle safety panel. Your fourth recommendation that we start an office of safety with an associate administrator.

I also saw the program MacNeil-Lehrer last night, and the discussion that occurred in that program concerned me in that at least one former astronaut indicated that he thought that was a mistake, that the recommendation of an office of safety would allow people up and down the line to say:

Safety is not my watch. That's someone else's problem, so let's—the safety office is in charge of that. As long as they sign off on this, my rear end is covered so let's not worry too much about it.

Was there any discussion within the Commission about that particular aspect of safety? And I'm also concerned about, What is going to be the coordination between the office of safety and the shuttle safety panel?

Mr. ARMSTRONG. I believe that was Dr. Hans Mark, Associate Administrator, that made that comment. And his concern was that which was stated by the chairman earlier; namely, safety has to be everybody's business, and you can't delegate the responsibility for safety to some organization off to the side and expect safety to be done. And we certainly as a Commission agree with that approach.

It's felt, however, and the organization that the Commission has suggested is one in which the safety organization would act like an independent audit function in the business world; that is, an outside, independent audit or an internal audit firm that has not line responsibility or sale of products or services, or whatever. And we believe that's important.

The safety panel, on the other hand, is a completely animal. It's intended to be an organization within the line, although it will have safety individuals in it, that acts on day-to-day safety concerns of individuals, contractors, and Government agencies, NASA organizations wherever they occur, and gives them a court of appeals to bring their concerns and have a hearing.

But they would not be within the office—they would not be a part of the safety stream, which would be the independent audit; no, sir. It's a working level.

Mr. ROGERS. Can I also say that I heard that "McNeil-Lehrer Report," too, and I heard what he said. I don't—I disagree with him, quite strenuously disagree with him.

At the present time the chief responsibility for safety, granted that everybody has to be responsible in part for safety, but if everybody's responsible you end up with nobody's responsible.

The chief engineer at the present time at headquarters is now responsible for safety. He's the man that is looked to as the safety officer for NASA. He said—and we cited in the report—"If I had known, I'm sure that in the 1982 time period when we first came to the conclusion that the seal was not redundant, I would have insisted that we get busy right now on a design change and also look for any temporary fix we could do to improve the operation of the seal."

He didn't know about any of these things. He was the chief engineer. What we are saying is that there should be one person in headquarters who is primarily, all of his responsibility has to do with safety. Now even that system can break down, but there should be some responsible person that should know about these things. They should know all about them. They should have known all of the problems they had with the seal over a period of a long—a period of years.

As a matter of fact, there were aspects of this seal where they had been—or these seals, whether they're in the field joint or the nozzle joint, which is somewhat the same—there had been problems with them, out of the 24 flights, problems on 14 of the flights.

And what we're saying is there should be some person at the headquarters whose job it is to say, "My God, it's my problem. I want to know what's going on. You've got to let me know it. If you don't let me know, it's your scalp. I'm the man that's going to be responsible at headquarters."

And we think that's an important recommendation.

Mr. BRUCE. May I make one final—I take it from what you say this is very important not only to create that office, but we elevate it to the level of Assistant Administrator?

Mr. ROGERS. Absolutely.

Mr. BRUCE. OK. Thank you.

Mr. ROE. The Chair recognizes the gentleman from—the distinguished gentleman from Ohio, Mr. Traficant.

Mr. TRAFICANT. Thank you, Mr. Chairman.

As the only member from Ohio, I want to welcome not only the Commission members for the fine job you've done, but give a real hello from Ohio to Mr. Armstrong who helped America before tremendously and is helping now, and we appreciate it.

You know, as we look back—and now we're talking about the fault and the causations of this tragedy, and we talk about the O-ring. I'm going to offer my opinion and then I'm going to ask you for your opinions. I don't believe the problem was the O-ring. I believe the problem was the management of NASA. I believe everybody should take off the gloves and do what we can to correct the problem before this type of an incident could occur again.

Now this is very unpopular in America—to question NASA. It's been up on that ivory tower, but now we've come to see that some of the management perspectives that loom within NASA are as regular as some of the other more mundane types of agencies such as the IRS and others. And, my God, we can't afford that.

I refer specifically now to something that I consider to be very, very important in this report. It's on page 10, approximately half-way down, and it refers to the launch decisionmakers not being made aware of certain things.

I want to quote something from this report and then ask that opinion and make a recommendation, Mr. Chairman. I quote:

"These launch decisionmakers," the statement says, "were unaware that Thiokol, including management officials, originally recommended not to launch and then, when pressed by NASA"—when pressed by NASA—"that Thiokol management reassessed and recommended to launch."

My point is we live in a time of government where the outside contractors almost sometimes overly influence the agencies, sometimes illegally.

Here's a case where at least at the subordinate level the engineer says, "My God, we've got a problem. Let's not take this thing on." But it was NASA and NASA who pressed that ultimately brought about this launch. I find that to be the cause of the problem and the cancer there.

Now in your opinion, what can this committee and the House do, what can we do as elected officials and the representatives of the people here—what can we do to deal with the management perspective within NASA to try and bring this ship to order, and what

are those specific recommendations that you might make to us in that regard?

Mr. Rogers, Mr. Chairman?

Mr. ROGERS. Thank you. Let me say, first, that in one respect the question you ask is even worse than you made it seem because originally it wasn't just the engineers in Thiokol that recommended against the launch; it was everybody in Thiokol, including management. It was a unanimous recommendation not to launch, and that recommendation, unless the temperature was 53 degrees or more. So it wasn't just the engineers fighting management; it was a unanimous decision by that company that that shuttle should not be launched.

Now the change occurred not—the engineers didn't change their mind, except Mr. Lund who happened to be part of management, but they changed their mind because NASA said that they were appalled at the recommendation and, if the recommendation stood, they might not be able to launch until April. And after those things were said, Thiokol management changed—made a change—changed its mind. And they signed the telefax that said that it was okay to launch.

Now I—in answer specifically to your question, I think it's a matter of changing the attitude on the part of everybody, and certainly in the case of NASA. I think that contractors have to be aware of their responsibility; NASA has to be much more aware and take it into consideration, and I think our report, would hope our report, will serve that function.

We hope that the new leadership in NASA will understand the risks of proceeding on any situation that's not safe. And we hope that everybody who has the responsibility of deciding to launch the shuttle in the future will know all the facts before they make the decision.

They still may make a mistake. It's quite possible. But they certainly should make the decisions based on known facts at the time. We hope that the work of our Commission will serve that purpose.

Mr. TRAFICANT. For the purpose of time—it's very limited, Mr. Armstrong—I'd like to ask you to maybe move off another quick question.

It is always the key question that deals with morale. No matter what the element you deal with, the attitude of the people within has much to do with the intended outcome. What is the morale of NASA? In your opinion, what is it going to take to involve the—all elements to make them into one key, cohesive unit that has some decisionmaking input?

Mr. ARMSTRONG. I haven't taken any kind of a formal survey and can't really give an enlightened response to that, but I have had the opportunity to talk to a number of individuals during the course of the investigation, and I'm encouraged. The people I talked to are—were pleased that the Commission was taking an aggressive approach to uncover the facts, and they were disturbed by some of the things that we found and that they found as a result of the inquiry. But they all universally—those that I talked to generally felt they wanted to get on with the job, make the fixes, and they'd feel a lot better when the fixes were in and they were back in flying.

Having said that, I don't want to imply that there probably aren't those who will change their mind about their participation in some way or other, because there probably will be, but I just do not have those facts.

Let me make one additional comment with respect to your previous question. I wouldn't want this committee to feel that the Commission thought that, had we in fact waited and always launched at temperatures greater than 53 degrees, or some number, that this would have been a safe design. In fact, the Commission concluded the opposite—that there was inherent design deficiencies in this joint and they need to be fixed, no matter what temperature it's flown in.

Mr. TRAFICANT. Thank you.

Mr. Chairman, I have a recommendation for the Chair, whether it's in order or not. I would recommend the Investigation and Oversight Subcommittee of this committee look into the management perspective and the decisionmaking that had gone on along with this particular launch, if necessary behind closed doors, and take a real good look at it and try to get to the bottom of that management aspect.

Mr. ROE. If the distinguished gentleman would yield, tomorrow we're going to have before us the leadership of NASA, and we're going to get into these program problems in the same kind of depth, and I trust you'll be here to propound your excellent questions.

The Chair recognizes the distinguished Representative from Kansas, Mr. Glickman.

Mr. GLICKMAN. Thank you.

Mr. Rogers, years and years ago you were at George Washington University Law School the judge of a moot court argument I made and I lost it. [Laughter.]

So now that you're back—

Mr. ROE. You'd better quit while you're ahead. [Laughter.]

Mr. GLICKMAN. I'm not sure what that means.

Mr. ROGERS. Somebody was looking for a thorn in the flowers we were getting; maybe you're it. [Laughter.]

Mr. GLICKMAN. No, I'm—actually the country owes you a great deal of gratitude.

Before I ask you two questions, I'd just like to again make public reference to a couple of points: one on page 201, one of your recommendations is reliance on a single launch capability should be avoided in the future. That is a very significant recommendation and one that will cause us a great deal of major public policy choices, whether we go transatmospheric vehicle, expendable launch vehicles, no fourth orbiter, cut the shuttle totally, more unmanned spaceflights, and let us hope that the legislative process and executive process can deal with those questions rationally and independently, because you've raised them here and they are truthfully public policy questions.

Second of all, while it's been touched before, the role of Congress—I also agree, we have not approached this from an adversarial or at least from an independent role, but it's no different here than it is with almost anything we're involved with. When we're involved too closely, we lose the independence.

I recall a number of times NASA took me down on airplanes to see the space launch, and that was all very nice. Then I think to myself, but the whole idea was, on both of our sides, to establish cozier relationships so maybe we wouldn't be as independent as we should be. And I think that that has to be part of it.

But let me go to a couple of questions. After reading this report, I don't see one darn word about contractors. It almost looks to me like you have neglected any reference to the contractors—to Morton Thiokol, to all the other contractors who were involved in the situation.

And I'm just wondering, Is there some reason why you have seemed to have left them out of this chain? And maybe I haven't read the report as well as I should have, but what about the contractors? What about the relationship between the contractors and NASA? Should they expect something new and do you recommend something new as a result of this?

Mr. ROGERS. Well, I do think that you missed some of the comments in the report, but we do single out Morton Thiokol particularly. We have a lot of discussion in here about them. And we say something that's judgmental, I guess. We say that the contributing cause of the accident—we say, "The Commission concluded that the Thiokol management reversed its position and recommended the launch of 51-L at the urging of Marshall and contrary to the views of its engineers in order to accommodate a major customer."

Mr. GLICKMAN. OK, that's true, but there's nothing in your recommendations to recommend any structural changes in the relationship between the contractors and NASA, and I think that goes to at least part of the heart of what happened here. And I'm wondering why.

Mr. ROGERS. Well, I'm not sure that I understand the term "structural change." NASA has the responsibility of making contracts with contractors that perform their functions properly. And we did—we reviewed the Martin Marietta performance on the external tank, and we had testimony from them, and we were quite impressed with the fact that they were very thorough. They did what appeared to be a good job over the 24 previous flights, and we also reviewed and have some references here to other contractors.

Now I don't think we undertook to try to determine whether NASA made the right choice of contractors because I don't believe that was our—

Mr. GLICKMAN. That's not my question. My question is that NASA operates very much like the Defense Department and to some extent like the FAA in terms of its relationship with major, substantial, outside contractors, and clearly in this case that relationship affected the lack of success of this flight. Now part of it was the flaw on the management, but part of it may have been the flaw in the relationship between management and the contractor. And I'm just, frankly, at this stage disappointed why there wasn't any specific reference. Maybe that wasn't in your frame of reference at all, and—

Mr. ROGERS. It really wasn't. As I say, my thought was that we were pretty rough on Thiokol. I mean, they certainly think we were.

Mr. GLICKMAN. Well—

Mr. ROGERS. I think that when you read this carefully, you'll see that we didn't recommend any change be made. We think that's a matter for Congress, and Congress already has had some discussions about that.

Mr. ROE. Will the gentleman yield?

Mr. GLICKMAN. I will be glad to yield. I just have one more—

Mr. ROE. I think it's important to point out for the gentleman—I know you were a little late in getting here—I think it's important to point out to the gentleman that in the overall scoping of the efforts to be performed by this committee and all its members, we are listening to the distinguished representatives in Secretary Rogers vis-a-vis their work. We will be calling in NASA tomorrow to respond, and there's plethora of questions that members have propounded that only NASA can direct its attention to.

Third, if the gentleman will yield, we will be calling in an astronaut corps, both retired and present astronauts, to get their particular point of view and their observations, using the basis of the Rogers report.

And then, fourth, we definitely will be calling in the private sector vis-a-vis the manufacturers of all phases of this work to get their reaction.

I think in fair play it's important that each one has their chance at the morale justice of the—

Mr. GLICKMAN. I appreciate that. I guess my only point is that these recommendations on pages 198 to 201 are going to be the ones that are copied and sent and disseminated all over the place, and not once is there a reference to that kind of structural relationship between NASA and the contractor.

Mr. ROE. If the gentleman would yield again, if the gentleman would read very carefully what the charge of the President of the United States was to the Commission, that would help to clarify his concern, I think.

The responsibility of the Commission was to thoroughly review and exhaust and recommend their exact findings as they relate to the accident per se. I think one of the great achievements of the Secretary and his colleagues in forming their report is that they have uncovered in a very scholarly manner a number of items which we have to look into. And the one you're mentioning I'm not—and you'll get another minute or two—

Mr. GLICKMAN. OK, thank you.

Mr. ROE. I'm not denigrating your observations. I'm just simply saying that that avenue is open. I mean, we can't explore the regrets of—

Mr. GLICKMAN. OK. And I'm not saying that you ignored it intentionally—not to deal with it.

Mr. ROGERS. No, we didn't.

Furthermore, I think you should have won the debate. [Laughter.]

Mr. ROE. On that basis—

Mr. GLICKMAN. Boy, didn't you soften me up. [Laughter.]

Now this is the last question.

Mr. ROE. On that basis, I think you just lost the debate.

The gentleman from Kansas?

Mr. GLICKMAN. It seems to me another issue has to do with the relationship between management in the NASA Program and management in the Defense Department.

For example, it almost seems to me that what we've seen here is that the people who worked at the center were more concerned about the center than they were about the program. And it looks to me like DOD management is geared just toward the opposite—that DOD management is more geared toward the program and not the center.

And you've talked about some of these things generally. I wonder if you might comment on that and also comment on a possible suggestion as to whether the Department of Defense—this may be heresy, but I'm going to ask you to comment on it anyway—whether the Department of Defense should take over the operations of the shuttle and/or the operations of NASA and operated, it being in charge.

Mr. ROGERS. Here, again, I really do think that's outside of our mandate. We did not address that and I don't think we should.

Mr. GLICKMAN. OK.

Mr. ROGERS. I think that's—those questions really are policy questions that Congress has to decide.

Mr. GLICKMAN. All right. Now what about the first part of the question about the way the management structure was oriented people were more concerned about the center they worked for rather than the program that they worked for, where there was a delineation of goals?

Mr. ROGERS. We do make reference to that. We recommend that more responsibility be given to headquarters, and particularly we think that the center at Marshall is probably too autonomous and needs to be looked at very carefully.

Mr. GLICKMAN. Thank you, Mr. Chairman.

Mr. ROE. I thank the gentleman from Kansas.

If there are no further questions, the time has become—we've come to the end of our time.

Mr. Secretary, I want to thank you and your vice chairman, Mr. Armstrong, for very adroit, candid, upfront testimony. We think you did a splendid job.

We've exhausted our work for today. I know your work is not exhausted for today.

I want to thank you very much. We're not sure whether we'll be wanting you back on Thursday, but we'll keep in touch with you.

Mr. ROGERS. We hope you don't, very much. We want to get back to private life.

Mr. ROE. I understand.

Mr. ROGERS. Thank you very much.

Mr. ROE. Thank you very much.

The meeting stands adjourned.

[Whereupon, at 12:37 p.m., the committee recessed, to reconvene the following day.]

INVESTIGATION OF THE CHALLENGER ACCIDENT

(Volume 1)

WEDNESDAY, JUNE 11, 1986

HOUSE OF REPRESENTATIVES,
COMMITTEE ON SCIENCE AND TECHNOLOGY,
Washington, DC.

The committee met, pursuant to recess, at 9:35 a.m., in room 2318, Rayburn House Office Building, Hon. Robert A. Roe (acting chairman of the committee) presiding.

Mr. ROE. The committee will come to order.

Good morning, ladies and gentlemen. This is the second day in a series of hearings that the Science and Technology Committee is holding to investigate the shuttle *Challenger* explosion.

Our Nation has a commitment to space exploration and space development, and we must maintain these objectives even as we examine the causes of the shuttle accident.

As I mentioned yesterday, our approach will be three pronged. First, we will examine the accident in terms of technology and hardware, which is the process we're on now—really, what went wrong. Second, we will scrutinize the role of NASA's management and decisionmaking process in the accident scenario. And finally, we will use this knowledge to help us make the decisions and judgments necessary for the future stability and success of our Nation's Space Program.

Yesterday we heard from the Honorable William Rogers, Chairman of the President's Commission on the Space Shuttle Accident. The Commission has provided the Nation with an outstanding documentation of the technology failures and also management problems that led up to the January 28 accident. Today, NASA Administrator James C. Fletcher is with us to respond to the findings and recommendations of the Rogers Commission report, as well as to present his views on changes and ideas and suggestions on NASA's future structure and operations. And I understand that with Dr. Fletcher will be Dr. William Graham, Deputy Administrator, NASA; Rear Adm. Richard Truly, Associate Administrator for Space Flight; Mr. Arnold D. Aldrich, manager of the National Space Transportation System of NASA; Capt. Robert L. Crippen, astronaut, NASA; and Mr. Dan Germany, leader, photo and TV analysis team, from NASA, in due course as they fit into the testimony.

[The prepared opening statement of Mr. Roe follows:]

OPENING REMARKS
OF
HON. ROBERT A. ROE
HEARINGS ON CHALLENGER ACCIDENT
JUNE 11, 1986

THIS IS THE SECOND DAY IN THE SERIES OF HEARINGS THAT THE SCIENCE AND TECHNOLOGY COMMITTEE IS HOLDING TO INVESTIGATE THE SHUTTLE CHALLENGER EXPLOSION. OUR NATION HAS A COMMITMENT TO SPACE EXPLORATION AND SPACE DEVELOPMENT AND WE MUST MAINTAIN THESE OBJECTIVES EVEN AS WE EXAMINE THE CAUSES OF THE SHUTTLE ACCIDENT.

AS I MENTIONED YESTERDAY, OUR APPROACH WILL BE THREE-PRONGED. FIRST WE WILL EXAMINE THE ACCIDENT IN TERMS OF TECHNOLOGY AND HARDWARE. WHAT WENT WRONG? SECOND, WE WILL SCRUTINIZE THE ROLE OF NASA'S MANAGEMENT AND DECISION-MAKING PROCESS IN THE ACCIDENT SCENARIO. FINALLY, WE WILL USE THIS KNOWLEDGE TO HELP US MAKE THE DECISIONS AND JUDGMENTS NECESSARY FOR THE FUTURE STABILITY AND SUCCESS OF OUR NATION'S SPACE PROGRAM.

YESTERDAY, WE HEARD FROM WILLIAM ROGERS, CHAIRMAN OF THE PRESIDENT'S COMMISSION ON THE SPACE SHUTTLE ACCIDENT. THE COMMISSION HAS PROVIDED THE NATION WITH AN OUTSTANDING DOCUMENTATION OF THE TECHNOLOGY FAILURES AND ALSO MANAGEMENT PROBLEMS THAT LED UP TO THE JANUARY 28TH EXPLOSION.

TODAY, NASA ADMINISTRATOR JAMES C. FLETCHER IS WITH US TO RESPOND TO THE FINDINGS AND RECOMMENDATIONS OF THE ROGERS' COMMISSION REPORT, AS WELL AS TO PRESENT HIS VIEWS ON CHANGES IN NASA'S STRUCTURE AND OPERATIONS.

WITH DR. FLETCHER ARE DR. WILLIAM GRAHAM - NASA DEPUTY ADMINISTRATOR AND NEWLY DESIGNATED SCIENCE ADVISOR TO THE PRESIDENT, REAR ADMIRAL RICHARD TRULY - NASA ASSOCIATE ADMINISTRATOR FOR SPACE FLIGHT, MR. ARNOLD ALDRICH - NASA MANAGER OF THE NATIONAL SPACE TRANSPORTATION SYSTEM, AND CAPTAIN ROBERT CRIPPIN - NASA ASTRONAUT.

WE INTEND ALSO TO CALL UPON NASA'S SHUTTLE CONTRACTORS AT A FUTURE DATE.

THE ROGERS' COMMISSION, NASA, AND THE CONTRACTORS ARE THE THREE MAJOR COMPONENTS THAT WILL PROVIDE THE COMMITTEE WITH THE COMPREHENSIVE PERSPECTIVE IT IS SEEKING IN THIS INVESTIGATION. HOWEVER, THIS DOES NOT PRECLUDE ANY DECISION WE MIGHT MAKE TO CALL UPON OTHER INDIVIDUALS OR GROUPS WHO MAY SHED FURTHER LIGHT ON OUR INQUIRIES.

GENTLEMEN, WE ARE PLEASSED TO HAVE YOU WITH US TODAY.

NOW I WANT TO RECOGNIZE CONGRESSMAN LUJAN, RANKING REPUBLICAN MEMBER OF THE SCIENCE COMMITTEE.

Mr. ROE. Before I call on our distinguished witnesses today, I defer to our ranking minority member, Mr. Manny Lujan from New Mexico for any opening statement he may wish to make.

Mr. LUJAN. Thank you very much, Mr. Chairman, and I join you in welcoming Dr. Fletcher and Admiral Truly before this committee today. I look forward to hearing their initial responses to the conclusions and recommendations made by the Rogers Commission as a result of its investigation into the *Challenger* accident.

I was glad to hear that Dr. Fletcher has agreed to study the recommendations of the Rogers Commission with an open mind and without reservations. That certainly is, in my opinion, the first step in the right direction. A lot of other steps must follow to fully implement the tough changes required by the Commission's findings and recommendations.

The Rogers Commission has made it abundantly clear that a serious, thoughtful, and thorough review of NASA, its policies and practices, is overdue. It is unfortunate that it took a tragic accident and the loss of seven lives to get our undivided attention.

Mr. Chairman, I cannot help but express a deep personal frustration at this time. In the aftermath of the *Challenger* accident, I grew increasingly tired of seeing NASA again and again adopt a defensive attitude, and generally less than cooperative posture toward the inquiry and constructive criticism. However, I believe that Dr. Fletcher has recently committed to changing this attitude, and I welcome this initiative. I hope he is successful in implementing this change at all levels of NASA management. All of us are anxious to get on with the business of rebuilding the space program.

I intend to lend my full support to that effort. There is, however, a string of issues which continues to concern me greatly. I am particularly troubled by NASA's organizational management structure as it applies to the space transportation system, its policies for certifying hardware, and the agency's approach toward criticality one and two items in risk analysis. I'll pursue these issues during the course of our hearings.

Dr. Fletcher, the bad news is that you have your work cut out for you, and it won't be easy. The good news is that I believe you'll have the full support of this committee as you begin the task of fixing the critical problems and to rebuild our space program. Thank you very much.

[The prepared opening statement of Mr. Lujan follows:]

OPENING STATEMENT
BY
HON. MANUEL LUJAN, JR. (R-NM)

RANKING REPUBLICAN MEMBER

COMMITTEE ON SCIENCE AND TECHNOLOGY
NASA'S RESPONSE TO THE ROGERS COMMISSION REPORT
JUNE 11, 1986

MR. CHAIRMAN, I JOIN YOU IN WELCOMING DR. FLETCHER AND THE OTHER NASA WITNESSES WHO COME BEFORE US TODAY. I LOOK FORWARD TO HEARING THEIR INITIAL RESPONSES TO THE CONCLUSIONS AND RECOMMENDATIONS MADE BY THE ROGERS COMMISSION AS THE RESULT OF ITS INVESTIGATION INTO THE CHALLENGER ACCIDENT.

I WAS GLAD TO HEAR THAT DR. FLETCHER HAS ALREADY AGREED TO STUDY THE RECOMMENDATIONS OF THE ROGERS COMMISSION--AND I QUOTE--"WITH AN OPEN MIND AND WITHOUT RESERVATIONS." THAT CERTAINLY IS THE FIRST STEP IN THE RIGHT DIRECTION, BUT MANY OTHER STEPS MUST FOLLOW TO FULLY IMPLEMENT THE TOUGH CHANGES REQUIRED BY THE COMMISSION'S FINDINGS AND RECOMMENDATIONS.

THE ROGERS COMMISSION HAS MADE IT ABUNDANTLY CLEAR THAT A SERIOUS, THOUGHTFUL AND THOROUGH REVIEW OF NASA, ITS POLICIES AND PRACTICES IS LONG OVERDUE. IT IS UNFORTUNATE THAT IT TOOK A TRAGIC ACCIDENT AND THE LOSS OF SEVEN LIVES TO GET OUR SPACE AGENCY'S UNDIVIDED ATTENTION.

MR. CHAIRMAN, I CANNOT HELP BUT EXPRESS A DEEP PERSONAL FRUSTRATION AT THIS TIME. IN THE AFTERMATH OF THE CHALLENGER ACCIDENT, I GREW INCREASINGLY TIRED OF SEEING NASA AGAIN AND AGAIN ADOPT A DEFENSIVE TONE AND A GENERALLY LESS THAN COOPERATIVE POSTURE TOWARDS OPEN INQUIRY AND CONSTRUCTIVE CRITICISM. I BELIEVE THAT DR. FLETCHER HAS RECENTLY COMMITTED TO CHANGING THIS ATTITUDE AND I WELCOME HIS INITIATIVE. I HOPE THAT HE IS SUCCESSFUL IN IMPLEMENTING THIS CHANGE AT ALL LEVELS OF NASA MANAGEMENT. ALL OF US ARE ANXIOUS TO GET ON WITH THE BUSINESS OF REBUILDING THE SPACE PROGRAM.

I INTEND TO LEND MY FULL SUPPORT TO THAT EFFORT. THERE IS, HOWEVER, A STRING OF ISSUES WHICH CONTINUES TO CONCERN ME GREATLY. I AM PARTICULARLY TROUBLED BY NASA'S ORGANIZATIONAL AND MANAGEMENT STRUCTURE AS IT APPLIES TO THE SPACE TRANSPORTATION SYSTEM, ITS POLICIES FOR CERTIFYING HARDWARE, AND THE AGENCY'S APPROACH TOWARD CRITICALITY 1 AND 2 ITEMS AND RISK ANALYSIS. I WILL PURSUE THESE ISSUES DURING THE COURSE OF OUR HEARINGS.

DR. FLETCHER, THE BAD NEWS IS THAT YOU HAVE YOUR WORK CUT OUT FOR YOU--AND IT WON'T BE EASY. THE GOOD NEWS IS THAT I BELIEVE YOU WILL HAVE THE FULL SUPPORT OF THIS COMMITTEE AS YOU BEGIN THE TASK OF FIXING THE CRITICAL PROBLEMS TO REBUILD OUR SPACE PROGRAM.

THANK YOU.

Mr. ROE. I thank the distinguished gentlemen.

If there are any other members of the committee that have an opening statement that they want to issue today, please put it in the record.

Mr. VOLKMER. Mr. Chairman, I have a statement I'd like to have inserted in the record at this point.

Mr. ROE. At this point. No objection; so ordered.

[The prepared opening statement of Mr. Volkmer follows:]

STATEMENT BY

HON. HAROLD L. VOLKMER
Chairman, Subcommittee on Investigations
and Oversight

11 June 1986

Mr. Chairman, this is an uncommon and unwanted position we find ourselves in today. We have met many times in this room to welcome back astronaut crews and learn of the work that they have been performing in space. We have watched satellite repairs and orbital construction projects with fascination. Today, we have the sad duty to find out why we cannot extend to the brave crew of Space Shuttle mission 51-L the same privilege.

Mr. William Rogers and the other members of the commission appointed by the President to investigate this tragedy have done a thorough and comprehensive job. I salute them for their dedication and perseverance in tracking down the information necessary for us to understand how this accident occurred and what we will need to do in order to guarantee that our astronauts take no further unnecessary risks.

The Commission's report has raised some serious questions in my mind and I intend to start asking those questions today. I believe the answers will be critical in NASA's effort to redesign the flawed systems identified by the Rogers Commission and to develop a management structure that does not allow the agency to ignore problems of such a critical nature again.

We saw after the Apollo fire in 1967 that NASA is able to accept tough criticism and emerge stronger for it. I have no doubt that the agency's new Associate Administrator for Space Flight, Admiral Truly, will take whatever steps are necessary to assure Congress and the Nation that when the Shuttle flies again, it will do so safely.

Mr. ROE. Any others?

Mrs. LLOYD. Mr. Chairman, I have a statement.

Mr. ROE. The gentelady from Tennessee. No objection; so ordered.

[The prepared opening statement of Mrs. Lloyd follows:]

STATEMENT OF
HON. MARILYN LLOYD

JUNE 11, 1986

MR. CHAIRMAN, THIS HEARING MARKS A NEW BEGINNING FOR NASA AND THE COMMITTEE BECAUSE OF THE IMPACT OF THE CHALLENGER ACCIDENT. WE HEARD FROM THE ROGERS' COMMISSION THAT THE DESIGN OF THE SOLID ROCKET BOOSTER IS POOR AND IT MUST BE FIXED. WE ALSO HEARD THAT THE MANAGEMENT PROCESS WITHIN NASA IS SERIOUSLY FLAWED, AND IT WILL BE THIS COMMITTEE'S RESPONSIBILITY TO SEE THAT THE PROPER FIX IS MADE. I DO NOT THINK THAT WE SHOULD UNDERESTIMATE THE DIFFICULTY SINCE MANY PERCEIVE AN "INSTITUTIONAL HARDENING OF THE ARTERIES" AT NASA HEADQUARTERS AND THE FIELD CENTERS. COMMISSIONER ROGERS TALKED ABOUT CHANGING THE "MIND SET" AMONG MANAGEMENT, AND I AM SURE THAT DR. FLETCHER UNDERSTANDS THAT THAT WILL TAKE A SIGNIFICANT EFFORT ON HIS PART.

I WAS DISTURBED ABOUT THE FACT THAT MANY MEMBERS AND THE ROGERS' COMMISSION FOCUSED SO HEAVILY ON SAFETY INADEQUACIES BECAUSE OF THE TRAGIC CONSEQUENCES OF THE CHALLENGER ACCIDENT. IT SEEMS TO ME THAT

THE ISSUE IS THAT OF A QUALITY PRODUCT AND ACHIEVING A LEVEL OF EXCELLENCE; ONCE AGAIN. IF NASA DOES ITS JOB EXCEEDINGLY WELL IN DESIGN AND TESTING AND OTHER ACTIVITIES, SAFETY WILL BE ASSURED. THE ISSUE HERE IS NOT SIMPLY SAFETY -- IT IS NASA'S PRODUCT, AND I AM AFRAID THAT PRIDE AND TECHNICAL ARROGANCE HAVE ALLOWED THE PRODUCT TO ERODE IN QUALITY.

CERTAINLY, IT WILL BE AWKWARD AT FIRST FOR THE COMMITTEE TO MAINTAIN AN ARMS LENGTH WITH THE AGENCY, BUT THAT IS CRITICAL BOTH IN TERMS OF SUBSTANCE AND PERCEPTION. WE CAN NO LONGER BE THE SPACE CADETS OF YESTERYEAR. ALSO, I FOR ONE HAVE NO REGRETS ABOUT SUPPORTING THIS GREAT AGENCY THROUGH ITS MANY TRIUMPHS. LOOKING BACK TO ANOTHER TRAGEDY, THAT OF THE APOLLO 204 FIRE, I THINK WE CAN LEARN FROM BOTH THE SIMILARITIES AND DIFFERENCES. AT THAT TIME, THE SCIENCE COMMITTEE RALLIED TO SUPPORT THE PROGRAM AND CARRIED OUT AN INTENSIVE INVESTIGATION TO IDENTIFY WHAT NEEDED FIXING. HOWEVER, THE POLICY CHOICE WAS A RATHER SIMPLE ONE IN 1967. THAT IS, AT WHAT PACE TO PROCEED WITH THE APOLLO PROGRAM IN THE WAKE OF THE FIRE ACCIDENT. TODAY, DR. FLETCHER AND HIS LIEUTENANTS ARE FACED WITH A COMPLEX SET OF TRADE-OFFS AMONG POLICY ISSUES, AND THE AGENCY IS MUCH MORE CONSTRAINED BY ALLOCATION OF RESOURCES. I, FOR ONE, HAVE AN OPEN MIND

ON THIS DIFFICULT SET OF CHOICES BEFORE US. BUT I WOULD EMPHASIZE THAT THE ACCIDENT HAS MADE THE NASA BUDGET A WHOLE NEW BALLGAME FOR THIS COMMITTEE. I DO NOT BELIEVE THAT THERE ARE ANY SACRED COWS IN TERMS OF PREVIOUS COMMITTEE POSITIONS ON SPACE COMMERCIALIZATION, SHUTTLE-DERIVED VEHICLES, ORBITER REPLACEMENTS, ETC. IT SEEMS TO ME THAT ONE COMMITTEE POSITION THAT SHOULD CARRY OVER TO THE NEXT CONGRESS IS THAT WE MUST DO RESPONSIBLE OVERSIGHT AND SATISFY OURSELVES INDEPENDENTLY THAT NASA IS ON THE RIGHT TRACK INSTITUTIONALLY. I HAVE AN OPEN MIND ON THE PROGRAMMATIC FUNDING ISSUES, BUT I WILL NOT SUPPORT ANY DECISION WHICH LOOKS LIKE IT IS AIMED AT A QUICK FIX. THE IMPORTANT THING IS TO MAINTAIN THE BEST PEOPLE IN THE AGENCY, ENCOURAGE THEM TO PROVIDE A QUALITY PRODUCT, AND SAFETY WILL BE TAKEN CARE OF.

MR. CHAIRMAN, I LOOK FORWARD TO THIS NEW BEGINNING AND EXPECT TO WORK CONSTRUCTIVELY WITH NASA TO RECAPTURE THOSE GOLDEN DAYS OF SUCCESS. MY HOPES AND PRAYERS GO WITH DR. FLETCHER AND HIS TEAM.

Mr. ROE. The gentleman from New York. No objection; so ordered. In fact, everybody, no objection; we'll put them in at this time, and that will solve that problem.

[The prepared opening statements of other members follow.]

GEORGE E. BROWN, JR.

STATEMENT

COMMITTEE ON SCIENCE AND TECHNOLOGY

REVIEW OF THE REPORT OF THE

ROGERS COMMISSION ON THE

CHALLENGER ACCIDENT

JUNE 11, 1986

Mr. Chairman, I would like to welcome Dr. James Fletcher and other representatives of NASA to this Committee hearing in the spirit of sober discussion. Today, and in the days that follow, we will review and evaluate the findings and recommendations of the Presidential Commission on the Challenger Accident. The Commission, commendably chaired by William P. Rogers, has presented a thorough and comprehensive document. Based on the Rogers Commission report, Congress will be able to make vital decisions on how to proceed with the future of the space program.

I look forward to the conclusion of these hearing--to when we can put the accident behind us so NASA can get on with the work that it had been doing for nearly three decades. I am confident that NASA will make the fixes in both system design and operating procedures that are necessary to resume shuttle flights. It is a matter of national importance that we carry on with a vigorous space program.

As we begin our evaluation of NASA's technical and managerial practices associated with the Challenger accident, we should recognize that fault for the shuttle disaster does not lie solely with NASA. Congress and the Executive Branch also deserves criticism. As much as anything else, the problems at NASA are a product of our flawed oversight. In the past two decades, we have sent NASA on a budgetary roller coaster ride which tested the limits of its highly complex infrastructure. Congress and the Administration made ambitious demands on NASA, without always being forthcoming with adequate funding.

This Committee, in particular, has perhaps been overly cordial to NASA in the past. This cozy relationship does not serve the interest of NASA or the American people. Clearly, some distancing between this Committee and NASA will occur. From now on NASA must be prepared to undergo the same scrutiny as any other federal government agency.

The U.S. space policy is a patchwork quilt of space projects, with the Space Shuttle being the center-piece. Although these programs are individually meritorious, there exists no overall goal. We approve NASA budget year after year without a clear vision of what the ultimate goal in space should be. I believe NASA has suffered for lack of a comprehensive national space policy, and to some extent this contributed to the Challenger disaster.

We need the leadership to establish a set of long-term goals in space which will guide NASA. If we have a set of long-term objectives to work toward, then Congress and the President can make intelligent decisions on the interim steps for getting there. I bring to my colleagues attention the recently released report by the National Commission on Space which outlines a set of ambitious goals worthy of serious consideration. I believe that the recommendations of this Commission, headed by Thomas Paine, can be used as the basis for a truly comprehensive National Space Policy.

Mr. Chairman, we have a difficult job ahead of us as we conduct these hearing and prepare our own report. This Committee must be decisively critical of NASA, yet leave room for encouragement so we can move forward. On the one hand, we must not be timid about asking embarrassing or uncomfortable questions. On the other hand, we must not damage the essence of the space program and foster the dedicated continuation of our nation's noblest venture. With the talent that exists on this Committee, I know we can strike a balance between criticism and encouragement of NASA.

OPENING REMARKS OF

REPRESENTATIVE ROBERT S. WALKER
RANKING REPUBLICAN MEMBER
SUBCOMMITTEE ON SPACE SCIENCE
AND APPLICATIONS
U.S. HOUSE OF REPRESENTATIVES

JUNE 11, 1986

Good morning, Mr. Chairman. Today marks a major step in our recovery for the tragic loss of Challenger and her gallant crew.

Today we will begin the process of reviewing the accident and the recommendations of the Rogers Commission with the management of NASA. I suspect that we have a very rocky road to traverse this morning, and, perhaps, for many days to come.

This committee has been accused by the media of not being sufficiently critical of NASA in the past. In many ways that is unfair. But, there is some truth to the claim. I suspect that most other members of the committee would agree with me that in the future we will no longer serve as cheerleaders for NASA, but from here on out we will actually be in the huddle with them.

Yesterday we heard from the Rogers Commission and they brought forth an indictment of the agency. There are a number of areas which this committee needs to look into before we even consider returning to flight status. I am particularly concerned about the lack of a functioning safety system within NASA. The Rogers Commission refers to it as a

"silent safety system." My own view is that it is non-existent. This is an area which must be addressed by the Administrator and the highest levels of NASA management.

I am also deeply concerned that the agency continues to keep people who played key roles in the multiple management failures which led to the accident in key management roles in the manned space program. I am not looking for scapegoats, and I do not want to see a witch hunt. However, I have lost confidence in those who were repeatedly told of the problems with the o-rings, and who neither solved the problem themselves, nor took it to their superiors.

We are told that the top managers would not have launched if they had been aware of the concern at lower levels, but they were unaware of the problem. I think that it is essential to keep those people who were responsible for the data not reaching to top out of the management of the manned program in the future.

I think we also must find out why the Congress was never told of the problems that the Rogers Commission has uncovered. We cannot approve of a return to flight status until all of the questions that the commission raised have been fully answered to our satisfaction.

Mr. ROE. Now, for the benefit of the members of the committee, we have planned on working with Dr. Fletcher and Admiral Truly and the members of their team as I announced before. During the day, today, and tomorrow there will be ample time to develop the issues involved and to get the facts before the committee as we unfold the second phase of our examination, which really has to do with not only what happened—which we had from the testimony yesterday—but what is the observations and the findings and the references that will be developed by the NASA leadership and management under Dr. Fletcher.

Dr. Fletcher has to visit with the President; they've got a program that's laid on this morning—I think it's around 11 a.m., if I'm not mistaken—but as he concludes that program, he'll be back here thereafter to continue on through the afternoon. So again, for the benefit of the members, there will be ample time. We'll go through the 5-minute process to get organized and get started. So as you are developing your areas of interest, I think you ought to develop them in continuity so that we are carrying through any particular issue in a continuity so it makes sense as far as the record is concerned and as far as getting the work done.

Now, having said that, I want to welcome our full committee chairman, Hon. Don Fuqua from Florida. Don, is there any comment you want to make before we begin?

Mr. FUQUA. Well, thank you, Mr. Chairman. I just want to welcome Dr. Fletcher back. I think he's not been before this committee in this capacity in about 9 years.

Welcome back, Dr. Fletcher, and we look forward to working with you.

Mr. ROE. All right. Having said that, Dr. Fletcher, again we want to welcome you and Admiral Truly and your team. If you would go ahead—I know you have your formal statements, but I do think that they're of such sufficiency that we should review the entire full statements, so to set the framework for today's hearings. So, Dr. Fletcher, if you would proceed, I'd appreciate it.

STATEMENT OF DR. JAMES C. FLETCHER, ADMINISTRATOR, NASA

Dr. FLETCHER. Thank you, Mr. Chairman, members of the committee. I welcome this opportunity to appear before you to address the Rogers Commission report; not because it's easy, or pleasant for me, or for NASA, but because it is a necessary and appropriate step in a democratic society.

The *Challenger* accident, in full sight of the American people and the world, raised many questions about what we, as an agency, were doing, and certainly, how we were doing it. After a long period of many successes, we at NASA are brought back to Earth, both literally and figuratively, for a time of reassessment.

Mr. Chairman, the American people seek answers and you, as its elected representatives of this committee, do, too. We are prepared today to begin to give you our best current information, plans, and responses to questions and recommendations. We do not have all the answers yet, and we expect our dialog with you to continue often during the coming months. We are dealing with very complicated problems. Simple answers, quick and easy answers are just

not honest or reasonable. The Commission report urges me, as NASA Administrator, to report to the President 1 year from now on our progress. I intend that both you and he have interim reports as we work to reclaim the excellence that has been our hallmark.

I said last Monday that NASA was prepared to study the Rogers Commission report with an open mind and without reservations, and that is absolutely true. I said that we had already been at work—indeed, had begun to seek answers to the disaster—even before the Commission was appointed, and that is also true. And I promised that where NASA management was found to be weak, we would strengthen it; where engineering or design or process needed improvement or change, we would do what was needed; and where our internal communications—and that includes decisionmaking—were poor, they would be made better.

It seemed to me that the Rogers Commission report not only was painstaking as it looked back, but cleared the air in a sense for us to move on. The Rogers Commission, in short, not only analyzed the failure of the *Challenger* launch and made recommendations for change, it also reaffirmed our goal.

Mr. Rogers, in his letter of transmittal to the President, said, "The Nation's task now to move ahead to return to safe space flight and to its recognized position of leadership in space, there could be no more fitting tribute to the *Challenger* crew than to do so."

We intend to do so. No tribute may be sufficiently worthy, considering the sacrifice of the *Challenger* crew; but we shall do all we can to make space flight safe and to maintain American leadership in space.

Mr. Chairman, that is not an idle statement, and I would like to review briefly why I believe that is so.

First, I believe this body will take an active role in redefining our national space effort for the decade ahead and into the next century, continuing a role this committee has had from the beginning of the American space program.

Second, NASA, virtually from the moment of the accident, has been deeply involved in finding out what went wrong so that we could plan for a safer future.

Third, the Rogers Commission has performed in an exceptional way, without posturing, without placing blame in a vindictive manner, without seeking to destroy a program that has brought knowledge, pride, and glory to this Nation.

Let me begin with NASA's relationship with Congress. There are those who have seized on our mistakes to question your oversight, the legitimacy of longtime cooperation and, indeed, possibly the space program itself. The fact is, Mr. Chairman, that Congress has always maintained a careful and thoughtful balance between a critical and sometimes skeptical view of space plans, even as it supplied support and encouragement when that seemed justified.

In the 1960's, getting to the Moon was a national policy; and with the American people's hearty endorsement, the Congress responded with program and financial support to match the public's almost unlimited enthusiasm. But those days are long gone. What has remained is a close working relationship and, I hope, mutual respect. I intend to maintain and improve both. I intend, with Con-

gress, to look carefully at our programs; and, with OMB, to make sure that every request to you is a responsible one. We will set priorities with full disclosure and discussion, and we will carefully spend the moneys that you authorize.

The American people have a nonpartisan pride in the accomplishments of the space program and in American preeminence in this field. I do not believe they want a timid program that doesn't maintain leadership. I do believe they want this committee and NASA to move with assurance together in seeking new goals.

Let me now review some of NASA's own activities in the weeks since the *Challenger* accident shook our confidence. We were forced to look at everything we had done, from design to the process of our decisionmaking. Part of this was the responsibility of a task force under Admiral Truly's leadership and with day-to-day direction by his associate, J.R. Thompson. It involved a development and production team, a prelaunch activity team, a mission planning and operations team, an accident analysis team, a salvage support team, and a photo and TV team. Much of its activity was aimed at helping the Rogers Commission. The NASA task force reports were made to the Commission in mid-April; the data is still being gathered, analyzed, and pursued by appropriate NASA leaders.

I also asked Gen. Sam Phillips, who was Apollo Program Director when we were on our way to the Moon, to study every aspect of how NASA manages its programs, including relationships between our various space centers, with each other, and with NASA Headquarters. General Phillips' review is not limited to the *Challenger* accident, and operates with broad authority from me to question every aspect of our activities. The review and report to me is being done without a deadline and will probably take the rest of this year for completion; but, as I become aware of things that need to be done, they will be implemented at that time.

The period from the *Challenger* accident until our next launch will be a time of reevaluation for NASA. Our work will not stop; it will only be more intense than ever.

Mr. Chairman, during the past several weeks—and particularly during the past several days—the question of when we will fly a space shuttle has been raised. I have said that our target date is July 1987; but I want that goal placed in its proper context, and that context is safety. We will fly in 1987 if it is safe to do so. We will not fly if it is not. In the complicated, interrelated situation in which we must function, a target date is necessary, particularly to potential users. But the date is not a fixed and inflexible one.

We are realistic about our problems, some of which the Rogers Commission noted, and we know there may be delays in design, testing, and manufacturing. You will hear more about all of that from Admiral Truly in a moment. For the moment, we keep the date of summer of 1987 as a goal which may change; what is not changeable is our commitment to fly again only when it is safe to do so. We will fly when we know clearly that we have dealt with the problems which led to the *Challenger* disaster.

Finally, while Admiral Truly will deal with the specific recommendations of the Rogers Commission report and what we are al-

ready doing or have done, I want to make several observations about the report itself.

I said on Monday that the report of a Presidentially appointed independent body carries with it special status and the compelling obligation to study its conclusions with an openness and willingness to change. That is particularly so with this report. It was done thoroughly and with care, with both toughness and understanding, and—I repeat—it was done with our cooperation. In its preface, it was noted that NASA established several teams of people, not involved in the *Challenger* launch process, to support the Commission and its panels.

I think it is important for the committee, the House, and the American people to understand that NASA and the Rogers Commission have worked closely together, even as each maintained its independence during the many weeks of the Commission's work. The preface of the report said, "These NASA teams have cooperated with the Commission in every aspect of its work. The result has been a comprehensive and complete investigation. That investigation will have profound effects on NASA and the space programs of the United States. Changes have already been made; more will come. Yet, Mr. Rogers said, "you don't want to punish; you just want to make sure it doesn't happen again." That is the goal, I think, we all share. That is certainly NASA's goal, beyond question.

I have said, speaking for the employees of an agency that has given this world not only lasting knowledge and moments of excitement and joy, that we have reached, with the Rogers Commission report, a day of resolve, a time of beginning, a time of rededication. I think you will see the truth of that in Admiral Truly's testimony that will follow.

After Admiral Truly's statement, we will be pleased to respond to any questions the committee may have.

Thank you.

[The prepared statement of Dr. Fletcher follows:]

HOLD FOR RELEASE UNTIL
PRESENTED BY WITNESS

JUNE 11, 1986

Statement of
Dr. James C. Fletcher
Administrator
National Aeronautics and Space Administration
before the
Committee on Science and Technology
United States House of Representatives

Mr. Chairman and Distinguished Members of the Committee:

I welcome this opportunity to appear before you to address the Rogers Commission Report, not because it is easy or pleasant for me or for NASA, but because it is a necessary and appropriate step in a democratic society.

The Challenger accident, in full sight of American people and the world, raised many questions about what we as an agency were doing and certainly how we were doing it. After a long period of many successes, we at NASA are brought back to Earth, both literally and figuratively, for a time of reassessment.

The American people seek answers and you, as its elected representatives, do, too. We are prepared today to begin to give you our best current information, plans and responses to questions and recommendations. We do not have all the answers yet and we expect our dialogue with you to continue often during the coming year.

We are dealing with very complicated problems. Simple answers... quick and easy answers ...are just not honest or reasonable. The Commission report urges me, as NASA Administrator, to report to the President one year from now on our progress. I intend that both you and he have interim reports as we work to reclaim the excellence that has been our hallmark.

I said on Monday that NASA was prepared to study the Rogers Commission's report with an open mind and without reservations and that is absolutely true.

I said that we had already been at work; indeed, had begun to seek answers to the disaster even before the Commission was appointed, much less had a chance to study, question, conclude, and report to the President. And that is also true.

And I promised that where NASA management was found to be weak, we would strengthen it; where engineering or design or process needed improvement or change, we would do what was needed; and that where our internal communications, and that includes decision-making, were poor, they would be made better.

It seemed to me that the Rogers Commission Report not only was painstaking as it looked back, but cleared the air, in a sense, for us to move on.

The Rogers Commission, in short, not only analyzed the failure of the Challenger launch and made recommendations for change, it also reaffirmed our goal. Mr. Rogers, in his letter of transmittal to the President, said, "The nation's task now is to move ahead to return to safe space flight and to its recognized position of leadership in space. There could be no more fitting tribute to the Challenger crew than to do so."

We intend to do so. No tribute may be sufficiently worthy, considering the sacrifice of the Challenger crew, but we shall do all we can to make space flight safe and to maintain American leadership in space.

That is not an idle statement and I would like to review briefly why I believe that it is so. First, I believe this body will take an active role in redefining our national space effort for the decade ahead and into the next century, continuing a role it has had from the beginning of the American space program.

Second, NASA, virtually from the moment of the accident, has been deeply involved in finding out what went wrong so that we could plan for a safer future.

Third, the Rogers Commission has performed in an exceptional way, without posturing, without placing blame in a vindictive manner, without seeking to destroy a program that has brought knowledge, pride, and glory to this Nation.

Let me begin with NASA's relationships with Congress. There are those who have seized on our mistakes to question your oversight, the legitimacy of long-time cooperation, and indeed, possibly the space program itself.

The fact is that Congress has always maintained a careful and thoughtful balance between a critical, and sometimes skeptical, view of space plans even as it supplied support and encouragement when that seemed justified.

In the sixties, getting to the Moon was a national policy and with the American people's assent, the Congress responded with program and financial support to match the public's almost unlimited enthusiasm. But those days are long gone.

What has remained is a close working relationship and, I hope, mutual respect. I intend to maintain and improve both. I intend with Congress to look carefully at our programs and with OMB to make sure that every request to you is a responsible one. We will set priorities with full disclosure and discussion and we will carefully spend the monies you authorize.

The American people have a non-partisan pride in the accomplishments of the space program and in American preeminence in this field. I do not believe they want a timid program that doesn't maintain leadership. I do believe they want this Committee and NASA to move with assurance, together, in seeking new goals.

Let me now review some of NASA's own activities in the weeks since the Challenger accident shook our confidence. We were forced to look at everything we had done...from design to the process of our decision-making.

Part of this was the responsibility of a task force under Admiral Truly's leadership and with day-to day direction by his associate, J.R. Thompson. It involved a development and production team, a prelaunch activity team, a mission planning and operations team, an accident analysis team, a salvage support team, and a photo and TV team.

Much of its activity was aimed at helping the Rogers Commission. The NASA task force reports were made to the Commission in mid-April, but data is still being gathered, analyzed and pursued by appropriate NASA leaders.

I also asked General Sam Philips, who had been Apollo program manager when we were on our way to the Moon, to study every aspect of how NASA manages its programs, including relationships between our various space centers and NASA Headquarters.

General Phillips' review is not limited to the Challenger accident and operates with broad authority, from me, to question every aspect of our activities. The review and report to me is being done without a deadline and will probably take the rest of this year for completion but as I become aware of things that need to be done they will be implemented at the time.

The period from the Challenger accident to our next launch will be a time for re-evaluation for NASA. Our work will not stop. It will only be more intense than ever.

Mr. Chairman, during the past several weeks and particularly during the past few days, the question of when we will next fly a space shuttle has been raised. I have said that our target date is July 1987, but I want that goal placed in its proper context and that context is safety.

We will fly in 1987 if it is safe to do so. We will not fly if it is not. In the complicated, inter-related situation in which we must function, a target date is useful, particularly to potential users. But the date is not a fixed and inflexible one.

We are realistic about our problems -- some of which the Rogers Commission noted -- and we know there may be delays in design, testing and manufacture. You will hear more about all of that from Admiral Truly.

For the moment, we keep the date as a goal which may change. What is not changeable is our commitment to fly again only when it is as safe to do so as we can make it. We will fly when we know clearly that we have dealt with the problems which led to the Challenger disaster.

Finally, while Admiral Truly will deal with the specific recommendations of the Rogers Commission Report and what we are already doing or have done, I want to make several observations about the Report.

I said on Monday that the report of a Presidentially appointed, independent body carries with it special status and the compelling obligation to study its conclusions with an openness and willingness to change.

That is particularly so with this Report. It was done with care and thoroughly, with both toughness and understanding. And, I repeat, it was done with our cooperation. In its Preface, it was noted that NASA established several teams of people not involved in the Challenger launch process to support the Commission and its panels.

I think it is important for the Committee, the House, and the American public to understand that NASA and the Rogers Commission have worked closely together, even as each maintained its independence, during the many weeks of the Commission's work.

The preface said, "These NASA teams have cooperated with the Commission in every aspect of its work. The result has been a comprehensive and complete investigation." That investigation will have profound effects on NASA and the space programs of the United States. Changes have already been made. More will come.

Yet, Mr. Rogers said, "You don't want to punish. You just want to make sure it doesn't happen again."

That is the goal I think we all share. That is certainly NASA's goal beyond question. I have said, speaking for the employees of an agency that has given this world not only lasting knowledge and moments of excitement and joy, that we have reached, with the Rogers Commission Report, a day of resolve, a time of beginning, a time of rededication.

I think you will see the truth of that in Admiral Truly's testimony that will follow. After Admiral Truly's statement I would be pleased to respond to any questions which the Committee may have.

#####

Mr. ROE. I thank you, Dr. Fletcher.

Admiral Truly, would you go ahead with your formal testimony, please?

**STATEMENT OF REAR ADM. RICHARD TRULY, U.S. NAVY,
ASSOCIATE ADMINISTRATOR FOR SPACE FLIGHT, NASA**

Admiral TRULY. Mr. Chairman and distinguished members, during the months since our return to duty with NASA following the tragic loss of *Challenger*, I, along with my entire organization, have spent many hours in support of the Rogers Commission. We have done our best to assist them in the conduct of their investigation, and I have reviewed the Commission's report to the President.

I personally found it to be extremely thorough and comprehensive. I am in general agreement with all of the findings and all of the recommendations, and I am pleased to say that because of our close association with Chairman Rogers and their work, I've been able to anticipate the corrective actions required to safely return the space shuttle to flight.

These actions were initiated by my memorandum of March 24, 1986, and a subsequent one by Mr. Arnie Aldrich on March 28, which directed the shuttle program to undertake this task.

I would like to now briefly take each of the Commission's recommendations and provide you with a summary status of my work.

The first recommendation of the Commission had to do with the design of the faulty solid rocket motor joint. On March 24, I directed the Marshall Space Flight Center to form a SRM redesign team. The team was to include participation not only from Marshall, but from other NASA centers, as well as individuals outside of NASA. It is headed by Mr. John Thomas as its leader; it includes personnel from the Johnson Space Center, the Kennedy Space Center, the Langley Research Center, and the Astronaut Office; and, in addition, has an expert advisory panel of 12 people, half of whom are from industry.

As a result of the early suggestion from the Commission, Dr. Fletcher has requested the National Research Council to appoint an independent oversight committee to review the activities of our redesign team. The National Research Council has agreed, and the members of that committee have recently been announced.

The team is pursuing a number of options for the redesign of the joint, and we intend to have a preliminary design review later this summer. Let me assure you that safety, and not schedule, is and will continue to be our primary concern. We will not return to flight status without a safe, tested, and certified design. I welcome the assistance of the oversight committee and I intend to work very closely with them, just as I did with the Rogers Commission, to assure full and complete consideration of all of their recommendations.

The second of the major recommendations of the Rogers Commission has to do with shuttle management. In that same memorandum of March 24, I initiated a detailed review of our management structure to determine those changes, both technically and philosophically, that are required. I wholeheartedly support the recommendations to reassess and define the responsibilities of the STS

program manager, and to ensure that he has the specific type of authority that the Commission recommends in their report. I intend to reevaluate the shuttle's level I, level II, and level III management structure, and to implement any changes that are necessary to strengthen that structure and to reduce the potential for conflict between the program organization and the institution, whether it be at headquarters or at our field centers.

Another recommendation had to do with the utilization of present and former members of the Astronaut Office, and we will give that proper consideration for management positions within the Agency.

I want to tell you that I concur completely with the concept of a shuttle safety panel reporting to me, and I will initiate action to implement this concept and I will leave my door open to them at all times.

As you know, Dr. Fletcher has mentioned that he has asked General Phillips to review all aspects of NASA program management, and this internal shuttle review will be done in coordination with General Phillips.

The third recommendation of the report has to do with the criticality review and hazard analysis. Again, in March, Mr. Aldrich—who is the level II program manager of the space shuttle system—initiated a thorough review of all items on the critical items list. As the first step in that review, every criticality and criticality 1-R item waiver was canceled, and NASA is in the process of a complete review of every one of those items—not just the solid rocket motor joint—and if we find those that are not revalidated by this review, they will be redesigned and fixed and recertified prior to flight. Further, the criticality 2 and 3 items are being reviewed to make sure that they are properly categorized. So this, again, by understanding what the Commission was doing, we got almost a 3-month head start on getting going again.

The fourth major recommendation has to do with NASA's safety organization. And although safety, reliability, and quality assurance is not my personal responsibility within the agency, I am vitally concerned about this activity and I pledge to work closely and do what I can to strengthen this most important element of our program.

The shuttle program does perform many of the activities that relate to program safety, and all of these are under our review. Each person in the Agency has an obligation to put safety first, and this will be reiterated many times over the next month. I intend to ensure that the management structure and its system is modified so that reporting requirements are clearly defined and rigidly enforced, and management at all levels is informed of all significant issues and their status.

The fifth major recommendation has to do with improved communications within our system. I personally think that this recommendation may be the most important work of the Presidential Commission. It applies not to one part of our system, but to all of our people and their organizations. As a part of our review, both internal and external communication will be given a primary consideration. This activity will include the Marshall Space Flight Center and all of the other shuttle program organizations and cen-

ters, and will ensure that the specific recommendations of the Commission will be considered.

Mr. Chairman, I would like to depart just for a moment from my prepared statement and tell you that of all the recommendations in the Commission's report, the two that I had not formally moved out on—and purposely so—until the report was in our hands had to do with the assessment of program management and communication. But now that we have that report, I feel that it is time to move out.

I have asked Capt. Bob Crippen, who has completed his work at the Kennedy Space Center as a full-time member of our task force since the *Challenger* accident, to head a small group which will examine the overall shuttle program management and report to me. Where changes to existing organization or lines of authority are deemed appropriate, this group will recommend solutions and options to myself and Dr. Fletcher.

Mr. ROE. Would the gentleman hold at that point? I think it would be profitable, because we have a continuity I don't want to lose—

Admiral TRULY. Yes, sir.

Mr. ROE [continuing]. And I see we've been called to the floor, so why don't the Members take the next 10 minutes. We'll recess, go to the floor and vote, and please return as quickly as possible because we are going to continue our work within 10 minutes.

And I want to keep your continuity going.

Admiral TRULY. Yes, sir.

Mr. ROE. I think you'll have to reiterate this part so that it's clear what you're trying to report.

Admiral TRULY. Yes, sir.

Mr. ROE. We'll recess for 10 minutes to vote and then return.

[Recess.]

Mr. ROE. The committee will come to attention and reconvene.

When we broke up for the vote we were hearing from Admiral Truly, and you were adding some added information in reference to the communications methodology and management. So maybe it would be best if you recap that for us again—

Admiral TRULY. Yes, sir.

Mr. ROE [continuing]. So we don't lose the continuity.

Admiral TRULY. Thank you, Mr. Chairman.

As I was saying, there are two recommendations in the Commission's report—the fifth recommendation, which has to do with improved communication, and the second recommendation, which is the program management structure review that I elected not to take a firm action on until we had the Commission report in our hands so the action would be appropriate. As I mentioned, Capt. Bob Crippen, who has been stationed at the cape since the accident and has been a part of the task force, is being called to headquarters for a period of time to head a small group which will examine the overall shuttle program management. Where changes to our existing organizational lines of authority are deemed appropriate, this group will recommend solutions for approval.

I'd like to quote from my memorandum on this subject from March 24:

The National Space Transportation Program management, philosophy, structure, reporting channels, and decisionmaking process will be thoroughly reviewed and those changes implemented which are required to assure confidence and safety in the overall program, including the commit-to-launch process.

Captain Crippen's group will review the findings and conclusions of the Rogers Commission; as a matter of fact, that's the first chore that they will have to do, is to go through this entire report with a fine-toothed comb.

Mr. ROE. Are you reading from that memorandum now, Admiral Truly?

Admiral TRULY. No, sir.

Mr. ROE. Or just referring to it?

Admiral TRULY. No, sir; just referring to it.

Mr. ROE. All right. Well, why don't we move to make that a part of the record at this point? If there is no objection, so ordered.

Admiral TRULY. Thank you, sir.

[Material referred to follows:]



National Aeronautics and
Space Administration

Washington, D.C.
20546

Reply to Attn of M

MAR 24 1986

TO: Distribution

FROM: M/Associate Administrator for Space Flight

SUBJECT: Strategy for Safely Returning the Space Shuttle to Flight Status

This memorandum defines the comprehensive strategy and major actions that, when completed, will allow resumption of the NSTS flight schedule. NASA Headquarters (particularly the Office of Space Flight), the OSF centers, the National Space Transportation System (NSTS) program organization and its various contractors will use this guidance to proceed with the realistic, practical actions necessary to return to the NSTS flight schedule with emphasis on flight safety. This guidance is intended to direct planning for the first year of flight while putting into motion those activities required to establish a realistic and an achievable launch rate that will be safely sustainable. We intend to move as quickly as practicable to complete these actions and return to safe and effective operation of the National Space Transportation System.

Guidance for the following subjects is included:

- o ACTIONS REQUIRED PRIOR TO THE NEXT FLIGHT
- o FIRST FLIGHT/FIRST YEAR OPERATIONS
- o DEVELOPMENT OF SUSTAINABLE SAFE FLIGHT RATE

ACTIONS REQUIRED PRIOR TO THE NEXT FLIGHT:

Reassess Entire Program Management Structure and Operation

The NSTS program management philosophy, structure, reporting channels and decision-making process will be thoroughly reviewed and those changes implemented which are required to assure confidence and safety in the overall program, including the commit to launch process. Additionally, the Level I/II/III budget and management relationships will be reviewed to insure that they do not adversely affect the NSTS decision process.

Solid Rocket Motor (SRM) Joint Redesign

A dedicated SRM joint design group will be established at MSFC, with selective participation from other NASA centers and external organizations, to recommend a program plan to quantify the SRM joints problem and to accomplish the SRM joints redesign. The design must be reviewed in detail by the program to include PDR, CDR, DCR, independent analysis, DM-QM testing, and any other factors necessary to assure that the overall SRM is safe to commit to launch. The type and content of post-flight inspections for the redesigned joints and other flight components will be developed in detail, with criteria developed for commitment to the next launch as well as reusability of the specific flight hardware components.

Design Requirements Reverification

A review of the NSTS Design Requirements (Vol. 07700) will be conducted to insure that all systems design requirements are properly defined. This review will be followed by a delta DCR for all program elements to assure the individual projects are in compliance with the requirements.

Complete CIL/OMI Review

All Category 1 and 1R critical items will be subjected to a total review with a complete reapproval process implemented. Those items which are not revalidated by this review must be redesigned, certified, and qualified for flight. The review process will include a review of the OMI's, OMRSD's, and other supporting documentation which is pertinent to the test, checkout, or assembly process of the Category 1 and 1R flight hardware. KSC will continue to be responsible for all OMI's with design center concurrence required for those which affect Category 1 and 1R items. Category 2 and 3 CIL's will be reviewed for reacceptance and to verify their proper categorization.

Complete OMRSD Review

The OMRSD will be reviewed to insure that the requirements defined in it are complete and that the required testing is consistent with the results of the CIL review. Inspection/retest requirements will be modified as necessary to assure flight safety.

Launch/Abort Reassessment

The launch and launch abort rules and philosophy will be assessed to assure that the launch and flight rules, range safety systems/operational procedures, landing aids, runway configuration and length, performance vs. TAL exposure, abort weights, runway surface, and other landing related capabilities provide an acceptable margin of safety to

the vehicle and crew. Additionally, the weather forecasting capability will be reviewed and improved where possible to allow for the most accurate reporting.

FIRST FLIGHT/FIRST YEAR OPERATIONS

First Flight

The subject of first flight mission design will require extensive review to assure that we are proceeding in an orderly, conservative, safe manner. To permit the process to begin, the following specific planning guidance applies to the first planned mission:

- o daylight KSC launch
- o conservative flight design to minimize TAL exposure
- o repeat payload (not a new payload class)
- o no waiver on landing weight
- o conservative launch/launch abort/landing weather
- o NASA-only flight crew
- o engine thrust within the experience base
- o no active ascent/entry DTO's
- o conservative mission rules
- o early, stable flight plan with supporting flight software and training load
- o daylight EDW landing (lakebed or runway 22)

First Year

The planning for the flight schedule for the first year of operation will reflect a launch rate consistent with this conservative approach. The specific number of flights to be planned for the first year will be developed as soon as possible and will consider KSC and VAFB work flow, software development, controller/crew training, etc. Changes to flight plans, ascent trajectories, manifest, etc., will be minimized in the interest of program stability. Decisions on each launch will be made after thorough review of the previous mission's SRM joint performance, all other specified critical systems performance and resolution of anomalies.

In general, the first year of operation will be maintained within the current flight experience base, and any expansion of the base, including new classes of payloads, will be approved only after very thorough safety review. Specifically, 109 percent thrust levels will not be flown until satisfactory completion of the MPT testing currently being planned, and the first use of the Filament Wound Case will not occur with the first use of 109 percent SSME thrust level. Every effort will be made to conduct the first VAFB flight on an expeditious and safe schedule which supports national security requirements.

DEVELOPMENT OF SUSTAINABLE SAFE FLIGHT RATE

The ultimate safe, sustainable flight rate, and the buildup to that rate, will be developed utilizing a "bottoms-up" approach in which all required work for the standard flow as defined in the OMRSD is identified and that work is optimized in relation to the available work force. Factors such as the manifest, nonscheduled work, in-flight anomaly resolution, mods, processing team workloads, work balancing across shifts, etc., will be considered, as well as timely mission planning, flight product development and achievable software delivery capability to support flight controllers and crew training. This development will consider the availability of the third orbiter facility, the availability of spares, as well as the effects of supporting VAFB launch site operations.

THE BOTTOM LINE

The Associate Administrator for Space Flight will take the action for reassessment of the NSTS program management structure. The NSTS Program Manager at Johnson Space Center is directed to initiate and coordinate all other actions required to implement this strategy for return to safe Shuttle flight.

I know that the business of space flight can never be made to be totally risk-free, but this conservative return to operations will continue our strong NASA/Industry team effort to recover from the Challenger accident. Many of these items have already been initiated at some level in our organizations, and I am fully aware of the tremendous amount of dedicated work which must be accomplished. I do know that our nation's future in space is dependent on the individuals who must carry this strategy out safely and successfully. Please give this the widest possible distribution to your people. It is they who must understand it, and they who must do it.

Richard H. Truly

Mr. ROE. The gentleman will proceed.

Admiral TRULY. Captain Crippen's group will be a small one, and he will visit with people inside and outside of the shuttle program, including former NASA managers such as former Associate Administrators, Center Directors, and people entirely outside of NASA.

After discussing this at some length with Dr. Fletcher, I think that Crip is an ideal choice for this assignment. He's the commander of four space shuttle flights; he's had extensive experience in several NASA programs, including the shuttle, and I look forward to having him to give me a hand in this most critical area. If I could introduce Crip to your committee, I would appreciate the opportunity to do so.

To return to the specific recommendations of the Rogers Commission, the sixth recommendation has to do with landing safety, which I have been involved with for quite a while because landing safety has been a significant concern of our program since the 1970's during the approach and landing tests which I flew, using the space shuttle *Enterprise*. We're going to review all of the shuttle hardware and systems in design reviews to ensure compliance with specifications in our concern for safety. Tires, brakes, and nose-wheel systems are included in this activity, and I want to tell you that funding for new carbon brakes has already been approved by me. Tire and brake testing is continuing and scheduled for this summer. KSC runway surface testing has been underway for some time prior to the accident, and is continuing. We're looking at better methods of weather forecasting and weather-related support for the Kennedy complex specifically; and, as you know, the potential for increased landings at Edwards Air Force Base was recognized prior to the accident. Frankly, that will be a dominant factor in our schedule as we return to flight status. We are also going to look very hard at the need for a dual ferry capability for the system, and we will consider that and decide when to come forward to you for your support.

The seventh major recommendation has to do with launch abort and crew escape. As the Commission noted in its report, crew escape was not possible in the 51-L accident. It has been looked at numerous times in the past; nevertheless, prior to the report being issued, we have started—or Arnie Aldrich in Houston—has started a comprehensive crew egress and escape review.

We are looking at our capabilities of escape throughout launch and of the landing environment, and we are relooking at all those possibilities that we've looked at before. We are going to continue to do that. The study is already in progress, and we're looking further at things such as launch commit criteria, flight rules, range safety systems, runway configurations and lengths, and all those complex things that go into the equation.

The bottom line is, we are re-reviewing and we desperately want to provide the best possible margin of safety for our vehicle and our crew.

The eighth recommendation of the Rogers Commission has to do with flight rate. We've already taken some action on this. We are participating with other governmental agencies in a comprehensive review of our Nation's ability to assure access to space.

I want you to know that I personally concur with the mixed fleet concept to avoid reliance on a single vehicle for our Nation. Development of a NASA flight rate which maximizes safety dictates that we fly at a rate consistent with our resources, and I intend to develop a schedule that achieves such a rate.

Within my office is the responsibility for payload assignment and for manifesting, and I can assure you that our manifesting procedures that are noted in the Commission's report—for example, late changes, et cetera, that require additional work in our mission planning organization—are under my personal review, and I intend to change those procedures if they are required to be changed, but more importantly, assure that we have the discipline to reduce the late changes which cause such an upheaval in the flight planning process.

The ninth and final major recommendation of the Commission's report has to do with maintenance safeguards. We are reviewing our maintenance philosophy and its implementation, particularly with regard to our spares inventory. This has been under review since shortly following the accident, and I want to tell you that the results of this activity will be combined with the results of our safety, reliability, and quality assurance review to make sure that we have an overall plan for vehicle processing and maintenance, trend analysis using flight data, good structural inspections, and adequate spare parts.

Mr. Chairman, I came to this job in the weeks following this tragic accident with the resolve and the duty to assist the Presidential Commission in finding the cause. The Commission has done their work; I embrace their report and believe I have set into motion the initial steps to return the space shuttle to safe and effective flight. Their report is a road map for me, and I intend to use it as my mandate for action.

Thank you very much for the opportunity to testify before your committee today, for NASA needs your support and guidance as our Nation returns to space flight.

Thank you, sir.

[The prepared statement of Admiral Truly follows:]

HOLD FOR RELEASE UNTIL
PRESENTED BY WITNESS

June 11, 1986

Statement of

RAADM. Richard H. Truly

Associate Administrator
Office of Space Flight

National Aeronautics and Space Administration

before the

Committee on Science and Technology
House of Representatives

Mr. Chairman and Distinguished Members of the Committee:

During the months since I returned to duty with NASA following the tragic loss of Challenger, I, along with my entire organization, have spent many hours in support of the Rogers Commission. We have done our best to assist them in the conduct of their investigation, and I have reviewed the Commission report to the President. I find it to be extremely thorough and comprehensive. I am in general agreement with all findings and recommendations and am pleased to say that because of our close association with their work, I have been able to anticipate the corrective actions required to safely return the Space Shuttle to flight. These corrective actions were initiated by my memorandum of March 24, 1986, and a subsequent memorandum by Mr. Aldrich on March 28, 1986, which directed the Shuttle program to undertake this task. These memoranda are included as enclosures to this statement. I would now like to briefly take each of the Commission's recommendations, and provide you with a summary status of my work.

SOLID ROCKET MOTOR (SRM) DESIGN

On March 24, I directed Marshall Space Flight Center (MSFC) to form a SRM joint redesign team to include participation from MSFC and other NASA centers as well as individuals from outside NASA. This team was formed with Mr. John Thomas as its leader. The team includes personnel from JSC, KSC, LaRC, industry, and the astronaut office. In addition, an expert advisory panel was appointed to assist the redesign team. This panel includes 12 people of whom half are from industry. As a result of an early suggestion from the Commission, Dr. Fletcher requested the National Research Council (NRC) to appoint an independent oversight committee to review the activities of the redesign team. The NRC has agreed and the members of the committee have recently been announced.

The redesign team is currently pursuing several options for redesign of the joint with a tentative date for the Preliminary Design Review this summer. Let me assure you that safety, not schedule, is and will continue to be our primary concern. We will not return to flight status without a safe, tested and certified design. We welcome the assistance of the NRC oversight committee, and I intend to work very closely with them, just as I did with the Rogers Commission, to assure full and complete consideration of their recommendations.

SHUTTLE MANAGEMENT STRUCTURE

The Presidential Commission recommended a thorough review of the Shuttle program structure. On March 24, I initiated detailed review of the NSTS management structure to determine those changes both technically and philosophically that are necessary in order to make the STS a more effective organization. I wholeheartedly support the recommendations to reassess and redefine the responsibilities of the STS Program Manager and to ensure that he has the specific type of authority suggested in the commission report. I intend to reevaluate the Level I/II/III program management concept and to implement any changes necessary to strengthen that structure and to reduce the potential for conflict between the program organization and the institution both at Headquarters and in the field. Utilization of present and former members of the astronaut office will be given proper consideration in that process. I concur completely in the concept of a Shuttle Safety Panel reporting to me and will initiate action to implement this concept and personally leave my door open to them as we move forward.

As you know, Dr. Fletcher has asked General Phillips to review all aspects of NASA program management and this internal Shuttle overview will be accomplished in close coordination with General Phillips.

CRITICAL ITEMS REVIEW AND HAZARD ANALYSIS

In response to my direction, on March 28 Mr. Aldrich initiated a review of all items on the Critical Items List. As a first step, all CRIT 1 and 1R item waivers were cancelled and NASA is in the process of a complete review and reevaluation activity for all items on the list. Those CRIT 1 and 1R items which are not revalidated by the review must be redesigned, certified, and qualified for flight. All other CRIT 2 and 3 items are being reviewed to ensure proper categorization. This review has been under way for some time.

SAFETY ORGANIZATION

Although Safety, Reliability, and Quality Assurance (S,R& QA) is not my direct responsibility, I am vitally concerned about this activity and pledge to work closely and do what I can to strengthen this most important element of our program. The NSTS program does perform many of the activities that relate to program safety and all are under thorough review at this time. Each person in the agency has an obligation to put safety first and this will be reiterated many times over the next months. Within the STS program I intend to ensure that the management structure and its system is modified so that reporting

requirements are clearly defined and rigidly enforced, and management at all levels is informed of all significant issues and their current status.

IMPROVED COMMUNICATIONS

I think this may be the most important part of the Commission's work, and that it applies to all our people and organizations. As part of my overall review and restructuring of the management system for the STS, internal and external communication will be given primary consideration. This activity will include MSFC and all other shuttle program organizations and will ensure that the specific recommendations of the Commission will be considered.

LANDING SAFETY

Landing safety has been a significant concern of the program from the days of our approach and landing tests of the "ENTERPRISE." All shuttle hardware and systems are undergoing design reviews to insure compliance with the specifications and concern for safety. The tire, brakes, and nose wheel steering systems are included in this activity, and funding for a new carbon brakes system has been approved. Specifically tire and brake testing is currently scheduled for this summer. KSC runway surface testing had been underway for sometime prior to the accident and is continuing. Better methods of weather forecasting and weather related support are being evaluated at this time. The potential for increased landings at Edwards Air Force Base was recognized prior to the accident and will be a dominant factor in our schedule as we return to flight status. Dual ferry capability has been a desire for some time and will be thoroughly considered during the upcoming months.

LAUNCH ABORT AND CREW ESCAPE

On April 7, Mr. Aldrich initiated a STS Crew Egress and Escape review. The scope of this analysis includes egress and escape capabilities from launch through landing and will provide analyses, concepts, feasibility assessments, cost and schedules for pad abort, bailout, ejection systems, water landings, and powered flight separation. In conjunction with this activity we are also reviewing all launch and launch abort rules and philosophy to ensure that launch commit criteria, flight rules, range safety systems and procedures, landing aids, runway configurations and lengths, performance versus abort exposure, abort and end of mission landing weights, runway surfaces, and other landing related capabilities provide the proper margin of safety to the vehicle and crew.

FLIGHT RATE

NASA is actively participating with other governmental agencies in a comprehensive review of the nations ability to assure access to space. I concur with the mixed fleet concept to avoid reliance on a single vehicle. Development of a NASA flight rate which maximizes safety dictates that we fly at a rate consistent with our resources and I intend to develop a schedule which achieves such a rate. Our payload assignment policy and flight

manifesting are under my personal review, to assure both that our rules are clear and that we have the discipline to reduce the late changes which cause such an upheaval in the flight planning process.

MAINTENANCE SAFEGUARDS

The STS maintenance philosophy and its implementation, particularly with regard to our spares inventory, is currently under review since shortly following the accident. The results of this activity will be integrated with the results of our S, R, & QA review to develop an overall plan for vehicle processing, maintenance, trend analysis, structural inspections, and spare parts.

Mr. Chairman, I came to this job in the weeks following this tragic accident with the resolve and duty to assist the Presidential Commission in finding the cause. The Commission has done their work; I embrace their report and believe that I have set into motion the initial steps to return the Space Shuttle to safe and effective flight. Their report is a roadmap for me, and I intend to use it as my mandate for action. Thank you for the opportunity to testify before your Committee today, for NASA needs your support and guidance as our Nation returns to space flight.

Admiral TRULY. Mr. Chairman, if possible, I would like to invite Captain Crippen and Mr. Aldrich to the table to assist if there are questions that committee members have that they could help us answer.

Mr. ROE. OK, why don't we do that right now? That's a good idea, so if Captain Crippen and the others would come up to the table.

Before we go into the question period—again, for the benefit of the members of the committee—the teams, the support task force teams that both Dr. Fletcher and Admiral Truly spoke to during their testimony will be visiting with us this afternoon, and tomorrow, particularly, so that they will have—tomorrow, I believe it is—we'll have the opportunity, in view of the fact that they were a bridge or a catalyst between the agency and the Commission, we'll have the chance to review their work and question their work and any part or piece that we might be specifically interested in. I think that's going to be profitable tomorrow, so I think some of those points that will be made can be best handled at that point.

I have a couple of specific questions that I would like to ask, but I'm going to defer now to our distinguished chairman, the distinguished Representative from Florida, Mr. Don Fuqua.

Mr. FUQUA. Thank you, Mr. Chairman.

Dr. Fletcher, you mentioned in your prepared statement about the relationship between Congress and NASA. I noticed that while fingers are being pointed, it's pointed at Congress, and I think probably we should share the blame.

But I might point out, those who have said that we are too cozy with NASA, I think, need to look at the record. And maybe you are familiar with that from your days prior in NASA. I think when you look at the record, and particularly the gentleman that served in the last number of years as chairman of that subcommittee, at the number of days of hearings that they hold in extreme detail of the NASA budget and the questions that are asked—not only that, but the field trips that are made to the NASA centers and even the contractors, for that matter, to try to get a better grasp and ask questions about what's going on—so I would like to, not in a defensive manner, but to say, check the record before you start saying that. Maybe some of us are guilty of being supporters of the Space Program, and I plead guilty. But that doesn't mean that we have always agreed—and you even mentioned, sometimes with a skeptical view—with some of the decisions that NASA has made, and there hasn't always been unanimity of agreement in all of the things that have taken place. Sometimes NASA hasn't liked the way we've redistributed money, and sometimes we have not agreed with the way that NASA proposed to spend the money. But I think if you also look back, you'll find that never—that I recall—we've ever reduced money for flight training and operations and safety during the course that I have remembered. We have made other changes; maybe you can elaborate from your memory, which is probably hazy like mine is, when you were serving before. I think we have tried to work and support and be proponents of the Space Program. I think it's very important to the Nation.

But I think that those that say that need to go back and check the hearing records and so forth. I think they'll come away with somewhat of a different perspective about that.

Dr. FLETCHER. Mr. Chairman, you are absolutely right. Over the years that I remember and also I've followed NASA in the years since then, in some detail, this is perhaps the most thorough and most critical oversight group of any that NASA deals with in Congress, although Congress as a whole has provided plenty of oversight. On the other hand, having said that, they've been supportive of us when we were doing the right thing and critical of us when we were doing the wrong thing.

Mr. FUQUA. I want to mention to Admiral Truly—I noticed you were talking about the landings, safer landing in your report, landing safety. And in addition to the tires, brakes, and nosewheel systems, I had even—2 days before—as a matter of fact, on January 26, I had a conversation with then-Acting Administrator Graham about the possibility of installation of a doppler radar system in the KSC area that could be used for more instant weather prediction. Is that included in your plans, to pursue that? They're planning to put one in Florida, and it would be an excellent test or demonstration facility, located in that area to give more accurate weather prediction for launch and landing.

Dr. FLETCHER. I might ask Arnie to comment. He may know a little more about where we are there, but I can assure you we are looking at advanced weather forecasting capability down there and we are also looking at some of our own internal NASA work out at the Ames Research Center on advanced systems. We've stood down on that cape runway many times and watched the weather change, and it's been a concern to me and to the crew a number of times. We intend to improve our capability during this downtime.

Arnie, could you elaborate at all?

Mr. ALDRICH. Yes, Mr. Fuqua.

Mr. Fuqua, that system is under investigation, both for application in Florida and on the west coast at Vandenberg, where it would be particularly useful for the kind of conditions there. In addition, we are also proceeding with augmentation of the worldwide capability for weather reporting and analysis at the Johnson Space Center in Houston to advance our capabilities and coverage. So we're looking at all of the ideas we know to make our weather forecasting as up-to-date and as capable as possible for the future.

Mr. FUQUA. Well, I would highly recommend that that be pursued. We are moving into some demonstration projects of the doppler radar system, and I think it cannot only serve as an excellent demonstration area but also serve a very valuable purpose in our space program.

Another point that you mentioned, Admiral Truly, was spare parts. I know every year this committee has added additional money in for spare parts; we've had to twist noses, kick, scream to get NASA to use it, and most times they have not used it for spare parts as it was intended.

I was told by one of the persons—I shall not name—that they had pirated one of the spaceships so much that he could carry in his suitcase what was left of it. I don't think that's good policy when we do that, and I'm glad that the Commission made specific

note of that in their recommendations and I'm glad to see that NASA is getting the proper attention. And I might point out, this all happened before you came on board, so I'm not directing this at you; but I just want to, while you and Dr. Fletcher are here, express my concern that spare part money that we have put in—never asked for, the committee put in—was never spent in the proper fashion that we had directed it to be. And that caused a lot of pirating of one vehicle to another vehicle, and I'm glad that the Commission noted that. That is not, in my view, a very good way; I'm glad the Commission realized it, and I'm glad to see you make that point in your statement.

Admiral TRULY. Thank you, Mr. Fuqua. Again, Arnie has been dealing directly with this problem for some time. Frankly, I'm concerned about this and I'm looking forward to having the time and the opportunity to really get with Arnie and look over this whole problem. I'm a little puzzled by it, frankly; my concept of spare parts is not people working on spare parts, but spare parts in the bins to support our airplanes and, in this case, the shuttle. But I can assure you that during our downtime we're going to take a hard look at it and make sure that the flight rates that we build up to after this accident are supportable by the logistics system that we have in place.

Mr. FUQUA. Thank you, Mr. Chairman.

Mr. ROE. You have to leave at 11, do you not?

Admiral TRULY. Mr. Chairman, I believe it's about 10 minutes of 11.

Mr. ROE. Well, we've got a few minutes here. I think I want to—well, we'll take it up later.

Let me suggest the following. I think to set the stage here, both Dr. Fletcher's testimony, which I think was a reaffirmation and a first real, good, strong policy position you have presented so far. I think you have done a splendid job as to where you want to go from there.

Mr. PACKARD. Mr. Chairman, would you yield for just a moment?

I think it would be productive if we alternated going to vote and keep the hearing going.

Mr. ROE. That's exactly what we're going to do.

So therefore, where I'm coming from, I think you've set that stage.

The second point is that Admiral Truly has expanded further, which was our natural question, which was, what have you done under Dr. Fletcher's direction? What have you done now to go ahead and implement, not waiting for further, elucidations to come from the Commission because they made a number of very solid recommendations, and you have now brought us up to date as to what you are doing in that direction, as I understand your testimony.

Let me ask you a question. It wasn't clear to me, and I think we ought to get it on the record—I think you developed it more firmly, Admiral Truly, that we were going to follow—NASA will follow the recommendations, all the recommendations, of the Commission? Is that the committee's understanding? Is that the statement that's being made?

Dr. FLETCHER. Mr. Chairman, we will certainly study all of the recommendations, and I see no reason that nearly all of them can't be followed in detail. But, as you recall, some of the recommendations said "consider" certain things. We will certainly consider them in great depth. They did not say to do certain things.

Mr. ROE. I understand that. But I want to get on the record, because that's the beginning point.

Dr. FLETCHER. We will certainly deal with all of the recommendations and have a report for you in a timely fashion.

Mr. ROE. And we'll be asking that.

So, for the following point, is there any recommendations that have been presented that you seriously, from a management point of view, would question at this point in their recommendations? Anything that they have presented that you don't think is the right direction to go? I think that's a fair statement to ask at this point.

Dr. FLETCHER. I think that all of the recommendations are things that are proper recommendations, and we should seriously consider them. I don't know any of them that are not worth considering or, even, maybe the right way to go.

Mr. ROE. OK. I just want to get that on the record. So, as far as you're concerned, the recommendations that have been made will be reviewed in toto and someplace along the line, as the committee calls back for an overview of what you're doing on those recommendations, you'll be able to give us a better idea as to what the substance would be and where we would go from there. Is that right?

Dr. FLETCHER. That is correct, Mr. Chairman.

Mr. ROE. Let me clarify for the record another point. It seems to me that the fundamental, upfront issue is the safety issue which you both spoke to eloquently, and that is first and foremost in your minds in your administrative approach, as it is as far as this committee is concerned. And then Admiral Truly spoke to the issue as far as the critical list, the criticality 1 and the criticality 1-R items were concerned. And again to reiterate for the record, is it my understanding and the understanding from your testimony that you are saying that all of those critical items will be reviewed individually?

Admiral TRULY. That's correct.

Mr. ROE. Totally?

Admiral TRULY. Every single one. And not just those on the solid rocket motor, but on all the elements of the system.

Mr. ROE. And is it the intent to have the process—and I notice that you've abrogated all waivers, so that everything will be looked at, and they will be recertified, each and every critical item on the list; is that a correct understanding?

Admiral TRULY. That is correct. And, as a matter of fact, that process had been set in work by Arnie Aldrich even before I issued the memorandum that was discussed in my testimony. But when I did issue the memorandum that charted a course for us to safely get back to flight, that was a major part of it, and you are exactly right. Every single criticality 1 and 1-R element or specific element of the shuttle system is being relooked at and, if it's found wanting, it will be redesigned and requalified prior to the next flight.

Mr. ROE. And therefore, our first and foremost observation—the first point of management is safety, and that's the direction which you intend to go, which leads me to my final question on safety.

In part of Admiral Truly's testimony, on page 2 at the bottom, safety organization, you mentioned that—

Although safety responsibility and quality assurance is not my direct responsibility, I am vitally concerned about these activities and pledged to work closely and do what I can to strengthen.

It would seem to me, regardless of what the chain of command is or specific assignment, that safety, No. 1, goes fundamentally to Dr. Fletcher and then second to you, whether it's a direct responsibility or not. So could we clarify that for the record?

Dr. FLETCHER. Mr. Chairman, the reporting responsibility for R&QA, as you know, is to the Administrator of NASA. But we will make that study for all of NASA.

Having said that, however, I don't think it should be said minimally that Admiral Truly is going to take a very hard look at R&QA for the shuttle program. I don't think he meant to imply that he was not going to do that.

Mr. ROE. That's why I wanted to get it clarified. And I think the relationship between yourself and Admiral Truly, being one of your appointees, is critically important that there's no breach in the safety communications point that you were making.

Dr. FLETCHER. Oh, no.

Mr. ROE. That is not what the intent was, and there will be a very close liaison. We understand that.

Let me ask one more question. You spoke of General Phillips being assigned, Dr. Fletcher, to review all aspects of the NASA program management in their internal shuttle overview. That indicates to me—is not—General Phillips was formerly with NASA, and then left? And is he coming—you called him back again? Is that what—

Dr. FLETCHER. General Phillips, Mr. Chairman, has been gone from NASA since the days of the Apollo Program, I believe in 1969 or 1970, and has been with TRW and has just retired as a group vice president. Like a lot of folks that were anxious to help NASA get back on its feet, he agreed to come back almost full-time and pursue this assignment. This assignment, as you properly indicated, is to look at the overall management structure of NASA, which impacts, sometimes directly, sometimes indirectly, on the shuttle management program. Having said that, however, Admiral Truly again will look at the management structure and the communications and the procedures for the space shuttle program as part of his assignment, and I suspect that's one of the things—

Dr. ROE. Well, what I'm leading up to, would it be profitable—and we don't have to make that decision now, or whatever—but I'd like you to consider one point. Sometimes, when we're cleaning our own house, we can't see what's in the corner simply because we're used to seeing it. And it seems to me that we are bringing an eternal—and no effrontery whatever, because General Phillips has an extraordinary, wonderful reputation; I don't mean that at all—but would it be profitable for the agency to also consider looking to the private management groups for re-review from an outside point of

view? In other words, if we're just going to review internally what happened to us, even though there's added expertise that General Phillips brings, would it not be a good idea to give some consideration to over-viewing this whole operation with some outside consulting private management groups? From the universities, and so forth?

Dr. FLETCHER. Mr. Chairman, when I said General Phillips was heading that effort, he has a series of consultants from all over the country involved with him making that review, all of whom are outside of the NASA organization.

Mr. ROE. Splendid. Could you, Dr. Fletcher—for the record, could you give us a little update response on that, a little bit of a broader view of what General Phillips will be doing? And also, that we have these different experts and expertise throughout the country, from universities and so forth, helping us to make this indepth, solid review? I think it will help a great deal on credibility.

Dr. FLETCHER. We'll supply that for the record, Mr. Chairman.
[Material to be supplied follows:]

Material requested for the record on page 46, line 967 by Acting Chairman Roe during the June 11, 1986, hearing.

General Samuel C. Phillips, USAF, (Ret.), is leading a study of NASA's systems and processes for managing its programs, personnel, and facilities. The study will draw upon expertise in the scientific, technical, and management communities.

Support for the study is being provided by the National Academy of Public Administration. In keeping with its regular practice, the Academy is forming a panel of outside experts in both the study and practice of management to advise and critique the project staff.

We will inform you of the make-up of the panel as it is completed.

Mr. ROE. Those are the questions I want to ask at this point.

Now, who is next? I guess I'm about the only one left. Suppose we take 10 minutes while I go do my duty and vote, and then we'll reconvene. You'll be leaving us, but then you'll return immediately thereafter?

Dr. FLETCHER. That's correct, Mr. Chairman.

Mr. ROE. I know there's a number of questions the members want to ask you.

We will recess for 10 minutes.

[Recess.]

Mr. ROE. The committee will reconvene.

Dr. Fletcher, as you know, has left us for about an hour, and then he will return, and Admiral Truly is leading this team. Therefore, I have concluded my first group of questions and I defer to the distinguished minority leader from New Mexico, Mr. Lujan.

Mr. LUJAN. Thank you very much, Mr. Chairman.

Admiral, let me tell you I'm sorry that Dr. Fletcher left, but I'm real pleased with the direction of NASA. As you know, many of us were concerned about what the attitude would be to accept those changes that need to be done, the fact that there were some errors, and let's move on to fix them. At the beginning, it appeared like NASA was rather defensive and, in that mode, it's very difficult to make the changes if you don't recognize that something was wrong. So I'm real pleased to see your statement and the Administrator's statement, moving in a positive direction and saying, let's go. I think, perhaps, we may have some little problem on down the line, and it's necessary that management impart that feeling all the way through NASA, but I think that's moving pretty good.

Let me ask you, particularly in terms of your testimony on improved communications, both the Commission and your statement mention, in the communications context, Marshall—not in any specific way, but everybody kind of alludes to Marshall when communications problems are discussed. Is that the basic problem? Is Marshall the basic problem as NASA sees it in this whole thing of communicating information up and down the line?

I notice that the Commission says—it talks about the tendency at Marshall to management isolation. I'd like to pursue that a little bit with you, Admiral, if I may.

Admiral TRULY. Yes, sir. I would answer that question in two ways, looking backward and forward. We had a terrible accident, and it was a part of the shuttle system that the Marshall Space Flight Center was responsible for. They have been under a terrific amount of criticism in the report and throughout the investigation. The reason that I mentioned the Marshall Space Flight Center in my testimony was because of the way the Commission had written that particular recommendation. But in looking forward, I would answer that question as absolutely not. Communication through the system, through our flight readiness reviews and our L minus 1 reviews and our change control boards has got to be looked at. And it's not a Marshall Space Flight Center problem; it's a problem that starts in my office and goes right down to the crews, once they're in orbit. It's throughout the system. I don't intend, and I know that Captain Crippen, when he looks at the program relationships that are required to be looked at, is not going to look at the

Marshall Space Flight Center any more or any less than the others. We have had problems; we did have a terrific communications problem on this launch, and I think in the launches preceding it, and it's covered in great detail in that report. But as we look forward, we're going to look through our entire system, just as in the hardware we're looking not only at the solid rocket motor but all of the hardware that's aboard.

So, if that helps you, sir.

Mr. LUJAN. Yes. In reading the reports and in reading all of the different things, it just appeared to me like Marshall was in need of some special attention, but that's not the way you look at it; is that right?

Admiral TRULY. No, I think as we look at it in the future, I envision a program management of the shuttle program that flows just the way the paper says it flows, and that is from me at level 1 to Mr. Aldrich at level II, and then to any level III program office, whether it be at Marshall or at Johnson. Whatever the problems have been in the past, that's the way the program is going to work in the future.

Mr. LUJAN. OK. We'll be looking, anyway, at the additional reports of the Commission and follow through where those bugaboos occurred.

One other thing that kind of stood out in this whole process, as far as I'm concerned, is the question of critical items. I don't know if I misunderstood or what, that under criticality 1 you have some 746 or 748 items, which means that any of those could cause the loss of the shuttle, the loss of life, and all of those things, very serious things. It's impossible to assess 746 items without going back and saying, OK, we've got to decide that, out of those 746, what are the probabilities of accident and what is the severity? Am I correct in that, in my analysis of that?

Admiral TRULY. No, I don't think you are. I think that Mr. Aldrich could comment better than I because he's running that review—even though the number is large, it is finite. The space program is used to dealing with extremely complex designs, and I would disagree that we cannot take each of those one by one. We have a great advantage now. Although we have a mountain of work to do, we have a great advantage to looking at those items now because we have had 24 successful flights, and we have a lot of flight data on those critical items. And so, we can look at the histories of each one. It takes a lot of people; it takes a lot of time. It's not going to be quick. There are some that we were concerned about before the accident, and those are the ones we're looking at first because they're the most likely ones that we might have to make a change to. But before we fly again, we will have looked at every last one, and I would disagree that we cannot do that. I'm sure we can.

Mr. ROE. The Chair recognizes the distinguished gentleman from New York, Mr. Scheuer. Mr. Scheuer from New York.

Mr. SCHEUER. Admiral Truly, you were on the second shuttle, which experienced the worst O-ring erosion of any fuel joint in the history of the program, I believe. In fact, it's ironic, it seems to me, that the erosion on the second shuttle occurred on the same right-

hand fuel joint, which is the same joint which caused the *Challenger* accident.

Prior to the *Challenger* accident, the tragic accident and the investigation, had you been informed by NASA management about the O-ring erosion on the second shuttle and other shuttles?

Admiral TRULY. No, sir.

Mr. SCHEUER. Well, how do you feel in retrospect, having flown other shuttle missions without having been informed by NASA of this known, demonstrably evident, life-threatening condition on those shuttles? How do you feel, having been sent up in the air on this extraordinarily dangerous mission without having vital information about the safety of the flight, the crew, the mission, that was there in NASA headquarters, was there in Marshall headquarters?

Admiral TRULY. I think that our investigation and this report clearly shows that the failure of communication of that problem, or the proper recognition of it, was a major failure and led to the cause of the accident. And frankly, personally, I am more concerned not that I as an astronaut and did not know, but that the total program through the level III, then to the level II, then to the level I didn't work that problem for that flight and others.

When I was in the astronaut office I frankly felt, and I do today, that the astronauts themselves deserve to be involved in those issues that are critical and are being worked. But I'm much more worried that the issue didn't get worked in the program than I was that I personally didn't know about it.

Mr. SCHEUER. Well, I totally agree with you. But don't you think if you and other flight crew members had known of the existence of that problem, you would have made damn well sure that it had been worked on and solved before the next shuttle event, whether you were on that shuttle or not?

Admiral TRULY. Yes.

Mr. SCHEUER. Wouldn't it have had a mighty prophylactic effect? I don't wish to embarrass you at all.

Admiral TRULY. No.

Mr. SCHEUER. But isn't the greatest assurance to the public and to the Congress, and even to NASA officials themselves, full and complete knowledge by the shuttle team on every aspect of the program? Where their own lives and safety are involved, they would insist on proper, prudent steps being taken. They're all risk-takers. You're a risk-taker; of course you are. But you're a prudent risk-taker.

Admiral TRULY. Yes, we should have known. In answer to your question, we should have known before—the way we should have known is that it should have been worked as a major technical problem, on the top of the table, with everybody concerned. And if it had, I'm sure we would have corrected the problem.

Mr. SCHEUER. It would have been corrected, would it not, after the second shuttle when it first appeared? It would have been corrected before the third shuttle? You wouldn't have launched a third shuttle—

Admiral TRULY. Well, that would be speculation on my part. If you go back to that flight and looked at that particular incident, what the decision would have been, I don't know. But I do know

that if it had been worked properly earlier, I believe this accident could have been avoided.

Mr. SCHEUER. If you had been a member of the crew on the third shuttle and you knew of the existence of the O-ring failure on the second shuttle, would you have acquiesced that all signals are go, a launch, a green light on the launch until you were sure that they had solved that problem of the O-ring failure?

Admiral TRULY. If I had known then what I know now, I think the proper thing would have been to stop the program and fix the problem.

Mr. SCHEUER. After the second shuttle, when the O-ring failure was evident?

Admiral TRULY. Whenever the joint design proved that it was not working as it was intended.

Mr. SCHEUER. Right. Right.

In other words, this is not just a failure of communication; this is a failure of decisionmaking. Isn't that evident? It's not just that the information didn't filter to the decisionmakers; it did. But they didn't act on it. They permitted the shuttle crew to take what we all see in retrospect as unacceptable risks. Wouldn't you think that's a reasonable conclusion? And that's what we want to avoid.

Admiral TRULY. I think somewhere, in the various levels of program management, there was a failure in decisionmaking and in communications.

Mr. SCHEUER. Between 1980 and 1985 NASA and the Air Force conducted three studies predicting the probability of failure of the shuttle. Two of these three studies predicted that a booster failure was likely before all of the 500 manned missions were completed. The Sierra study indicated an estimated failure rate of 1 in 70, and the Sandia National Laboratory study indicated a failure rate of 1 in 210. There was another one that indicated 1 in 1,000. But then, by some process of rationalization that I don't understand, NASA Headquarters came up with a failure prediction rate of 1 in 100,000, which was 100 times more optimistic than the most optimistic of these three studies that NASA and the Air Force commissioned.

Didn't these three studies—two of which indicated failure before the end of the series of manned shuttle flights—didn't they sort of send up an early warning signal to some of you? Totally apart from this wildly optimistic of 100,000-to-1 estimate of NASA?

Admiral TRULY. I'm sorry, I'm not familiar with any of those studies and just can't comment. Perhaps Mr. Aldrich might be familiar, but I'm not.

Mr. ALDRICH. No, I'm sorry, I'm not familiar with those studies.

Mr. SCHEUER. Would Mr. Fletcher be familiar with the history of these predicted failure rates?

Admiral TRULY. I don't know, sir.

Mr. ROE. Will the gentleman yield for a moment?

Mr. SCHEUER. Sure.

Mr. ROE. I know you've done quite some research on this. These studies were commissioned by NASA?

Mr. SCHEUER. By NASA and the Air Force, three of them; one that came in with one failure out of 70, one came in with one failure out of 210, the third came in with one failure out of 1,000. And

on top of these, NASA predicted one failure out of 100,000, which is 100 times more optimistic than the most optimistic of the three.

Mr. ROE. I think the gentleman, if he would yield further, is striking upon an extremely important, nagging point that every member of this committee, without exception, is concerned about. How could there possibly be 14 incidents, as we understand the issues involved, with some kind of a problem relating to those O-rings, and nothing was given urgency to immediately get at that? I think that's where the gentleman is coming from.

Mr. SCHEUER. Yes, and I'd like to know, was the shuttle designed—each of the components designed—to achieve a probability of success in 99,999 cases out of 100,000?

Mr. ROE. Would the gentleman—

Mr. SCHEUER. And I'd also like to ask them at some point in time, what do they consider a reasonable, expected, predicted failure rate? I think the Congress ought to know what the acceptable failure rate is.

Mr. ROE. I understand. If the gentleman would yield—I don't want to lose this train of thought because I think you're on a very important one.

Mr. SCHEUER. Yes.

Mr. ROE. We're going to be breaking sometime around 12:30. We would like to be able to give you the information that Mr. Scheuer speaks to, vis-a-vis these two or three studies that were commissioned by—what do you call it—NASA, and did that go to the chief engineer, what happened, and how come we don't know about that. I don't mean that unfairly or unkindly. In other words, why don't we—here's an example; and again, I know that we're coming back, being called back, new people involved, but we don't know that those were commissioned. What did they say and what did they do?

So I would suggest to the gentleman from New York, if he will, that we—

Mr. FUQUA. If the gentleman will yield?

Mr. ROE. Yes, of course.

Mr. FUQUA. Those were studies that were commissioned by the Department of Energy in relation to a power system called the RTG that would be used in some upper stages. I don't remember exactly when they came back, but they were also commissioned for the President's evaluation of approval of those launches. They were not commissioned by NASA; they were not commissioned by the Air Force, to my understanding. They were commissioned by the Department of Energy.

Mr. ROE. Where the Chair—I respect the gentleman's enormous background and knowledge—where the Chair is coming from, we are going to get, as we unfold our efforts and energies over the next 3 or 4 weeks, we're going to get people making statements and different presentations that are made that we have to deal with up front for the legitimacy of that particular question. I think that's where the chairman is coming from.

What I'm simply suggesting, in the line of questioning that Mr. Scheuer is pursuing, is that we ought to look into those facts, check with your chief engineer, so we can elucidate as the chairman said.

What we are trying to do here is establish the facts as they are—not hypothetical, what may have happened. What are the facts?

That's what we've got to get at, and this is one of those issues that we have to deal with. Is that a fair commentary?

Mr. SCHEUER. Sure.

Mr. ROE. And we'll take this matter up first.

Mr. SCHEUER. I thank the chairman.

Mr. ROE. The Chair now recognizes the distinguished gentlelady from Rhode Island, Ms. Schneider.

Ms. SCHNEIDER. Thank you, Mr. Chairman.

Admiral Truly, I'd like to focus on some of NASA's supervision of quality control and safety concerns that have come into question, and specifically I'd like to focus on the elements of personnel and also of procedures.

In one of the reports I was looking at here it says that the number of quality assurance personnel dropped from 1,689 people in 1970 to 505 people in 1985, which is a 71-percent decrease in the number of people who are responsible for quality control. And last October, an Air Force study had indicated that they found a shortage of engineers and technicians, so much so that it led to an average of 2,200 work requirements by ground processing personnel that had not been dealt with. And of all of those requirements, only 26 percent of them were scheduled for work.

Now, my question to you is, are we reaching a conclusion that perhaps part of the reason for the accident was a deficiency in not only workmanship but also oversight due to the fact that there were not enough personnel involved to do the kinds of checking and double-checking that should have been done?

Admiral TRULY. If I might respond first with a comment, and then get to your question.

The numbers that you referred to, I believe, have been corrected by the chief engineer, Dr. Silveira, which I can provide for you for the record.

[Material to be supplied follows:]

Material requested for the record on pages 59 and 60, lines 1301 through 1306 by Acting Chairman Roe on June 11, 1986.

It is important to discuss the reduction in R&QA personnel in the proper perspective. Please note that the highly publicized "reduction" concerns only R&QA personnel. The "70% reduction" over the past 15 years included many functions such as metrology/calibration, parts, assemblies and systems testing, material testing, chemical analysis, etc. which were in the 1970 R&QA organizations but transferred to other organizations within the NASA centers. Also, included in the "70% reduction" were in-house flight programs such as Viking, Saturn launch vehicles, and Skylab Apollo Telescope Mount which require NASA inspection/verification on manufacturing, assembly and test operation. The termination of these in-house flight programs, along with the transfer of certain functions, accounts for much of the "70% reduction."

Using the same functional baseline, the number of R&QA personnel in 1970 was approximately 1,030 out of a total population of 32,500. In 1985 we had approximately 580 R&QA personnel out of 22,300 employees. Over the 15 years, NASA had a decrease of approximately 10,200 employees of which 450 were in R&QA.

However, this total reduction of 450 R&QA people includes the reduction in program content for the Agency which is represented by the overall population decrease from 32,500 to 22,300 as well as an effective real decrease in R&QA coverage on the remaining programs. This effective real decrease in coverage can be determined by comparing the percentage of NASA R&QA of the total population in 1970 versus 1985. In 1970 we had 3.2% of the employees in R&QA, while in 1985 we had 2.6%. The decrease in R&QA was 0.6% or approximately 135 people. This means that of the 450 drop, 135 represents a decrease in coverage while the remainder of the 450 (315) represents a decrease because of total program content reduction.

Even though we had a reduction in R&QA personnel, our detail review of the quality operation did not reveal that we missed any of the quality control check points which may have contributed to the accident. We firmly believe that the checks and double checks by NASA personnel, our Government QA Specialists, and our contractor QA personnel were adequate. We are reassessing the entire quality operation for the purpose of identifying ways we can strengthen the system. This reassessment will include a study of the staffing in SR&QA.

Admiral TRULY. However, that is not to say that the safety, reliability, and quality assurance program in NASA was not a major focus of the Commission's recommendations. And as I said in my statement, I can assure you that I will personally join that effort to take a look throughout the agency, and particularly in my responsibility throughout the Space Shuttle Program, to make sure we have the right kind of people on the job.

To answer specifically your question, I think that that was something that the Commission discovered in its investigation and was not a direct cause of this accident. But it is something that was uncovered, and I'm sorry there was some confusion on the numbers that became public, and we should straighten those facts out for you. But I don't think it was a direct cause of the accident. It was something that the Commission ran into. It's something we should fix, and we will do that.

Ms. SCHNEIDER. So what you're suggesting is that there are an adequate number of personnel available for monitoring and quality control supervision?

Admiral TRULY. I can't say that. I have not had the opportunity personally to go through the detail. What the chief engineer is going to have to do is go through all of our contractors, look at what industry standards are for systems that are complex like this, make sure that we have not only the right numbers but the right kind of trained people, that we have the right sort of supervision, and we look at it from the top of NASA. That's what the Commission recommended, and I'm sure that is precisely what we're going to do.

Mr. ROE. Will the gentlelady yield?

Ms. SCHNEIDER. I'd be happy to yield, Mr. Chairman.

Mr. ROE. I think for clarity for the record, the gentlelady is striking on a very important point. And if I can relate her question back to the earlier comments that Admiral Truly made in his presentation, we did pursue that. We came back and said that one of the key critical issues that NASA had to do was to investigate and inspect all of the critical items that were involved, of the 700-some-odd items that were involved.

The logical question that the lady is asking, I believe, or that our colleague is asking, is, what is it going to take to do that? And you yourself made the point of view that there is an extensive number of people that would be involved.

And then, on a legitimate, followup question, if the lady would yield further—our gentlelady and colleague would yield further—is, is NASA going to use their people, quality assurance people, to review and inspect these critical parts? Or are they going to use outsiders? Or a combination of both? How do we get the assurance that you have enough personnel? What process will you be following, as I understand the basic question? Is that a fair analysis of the question?

Ms. SCHNEIDER. Yes. That's it.

Mr. ROE. That's the question I think she's asking.

Admiral TRULY. I agree that is the question, and that is precisely the study that needs to be looked at to determine where we are in the quality assurance area.

Within the Office of Space Flight, I have looked at just the numbers. I have not had an opportunity yet to put my name behind the report because I've just seen it. But I know that for two of our major contractors, the numbers of quality assurance personnel on the job appear to be quite adequate, at Rocketdyne with the main engines and also the numbers that I've seen at the Rockwell plant. The numbers have changed over the years because we have been out of production. You need more quality people when you're producing hardware.

Mr. ROE. If the gentlelady would yield further?

Ms. SCHNEIDER. Yes.

Mr. ROE. I think it would be profitable by tomorrow if you could respond to this question as to some thought process that you may have developed that your people will think about in the following direction.

The question before us is the deepest of concern and the paramount issue of safety; I think we all agree to that. The second point that the gentlelady is asking is that, in order to ensure that issue in the first step as far as technological hardware is concerned, you and your colleagues have testified that they are up front, and priority No. 1 is to get your inspection and reassurance. You've cancelled the waiver positions on the critical items, and those are all going to be gone through again because the question was asked by other members that some of those critical items—all of those critical items—in effect, if they were defective, could create a problem and a serious one. That's the question.

Now, the second question we're asking, there was some question as to whether or not the contractors alone should be the ones who do the quality assurance as working for NASA, or does NASA consider the issue to be important enough and serious enough to have their own cadre of expertise to double-check on the contractors? Particularly, looking at part of the testimony that was given yesterday where they came back and said, one of the contractors did not perform their contract within the ambient levels that they had to perform it in.

So what we simply want to nail down, if I'm correct for the gentlelady—

Ms. SCHNEIDER. You are.

Mr. ROE [continuing]. Is nail down the point of view as to what process is NASA going to invoke to be able to review the critical list to improve the quality assurance issue. Will you rely more upon NASA personnel working directly for you, the Government? Or are we going to put off more and more of that to the private contractors who are working for us? How do we get that balance, and what do we do to test?

Is that a fair appraisal of what the gentlelady said?

Ms. SCHNEIDER. That's it.

I appreciate my interpreter doing such a fine job. [Laughter.]

Mr. ROE. The gentlelady from Rhode Island.

Ms. SCHNEIDER. Well, I would like to continue on part C of my questioning; and due to my magnanimous nature in enabling the chairman to clarify this, there are some other points that I would like to have clarified. And if you don't have this information, I

would appreciate that we obtain this for the record, perhaps at a later time.

But it seems to me that, at the same time that we were watching the levels of personnel decline since 1970, I'd like to know what the percentage was in increase/decrease or maintenance of status quo insofar as public information and public relations was for NASA over that same period. Do you happen to have the answer to that on hand?

Admiral TRULY. No; but I'll be pleased to provide it.
[Material to be supplied follows:]

Material requested for the record on page 66, line 1439, by Ms. Schneider during the June 11, 1986, hearing.

As of the end of FY 1970 NASA had 131 employees in public information and public relations functions. The following table shows the comparable end fiscal year totals and the number and percentage change from FY 1970 in two year increments through May 31, 1986.

	<u>Number of Employees</u>	<u>Difference From FY 1970</u>	<u>Percentage Change From FY 1970</u>
FY 1970	131		
FY 1972	98	-33	-25%
FY 1974	97	-34	-26%
FY 1976	98	-33	-25%
FY 1978	92	-39	-30%
FY 1980	87	-44	-34%
FY 1982	101	-30	-23%
FY 1984	116	-15	-12%
May 31, 1986	112	-19	-15%

Admiral TRULY. As a matter of fact, I can provide the corrected numbers that were testified to by Dr. Silveira, for the quality assurance people.

Ms. SCHNEIDER. In addition to the quality assurance personnel, I am interested in looking at the budget that has been utilized over that same period of time because it appears to me, Mr. Chairman, that we have been seeing over that time period a very aggressive public relations campaign in support of the shuttle program. And I certainly understand the favorable publicity and the campaign that was helping to create an atmosphere which would lead to support of this program, but I am concerned about that.

I'm just going to ask part D of my questioning, here, which relates also to procedures of those personnel.

The General Accounting Office had indicated that NASA had cut or delayed one-half billion dollars in spending on safety testing, design, and development from the time the shuttle began until the *Challenger* disaster. Now, the reasons, I understand, that those procedures were eliminated was because they were proven—or it was indicated—that they were not cost-effective. I would appreciate it if you could elaborate on the decisionmaking discussion that indicated that it was no longer cost-effective, unlike the Apollo space program where various procedures were tested and they design it, and then they build the prototype, and that prototype was then tested.

The idea of eliminating this procedure because it was not cost-effective, I'd like some more justification for that, please.

Admiral TRULY. Again, I'm going to have to respond for the record on that. Those happened in years that I'm not personally aware of. I will be pleased to try to get you the information for the record.

[Material to be supplied follows:]

Material requested for the Record on page 68, line 1478, by Ms. Schneider, from the hearings held on June 11, 1986

We reviewed the NASA historical records and found that there was a series of review meetings held in the mid-1970's to realign the Shuttle development testing programs due to the prevailing budget constraints. During these reviews and the subsequent development program, some testing was deleted, which ultimately resulted in significant cost savings.

The prior Apollo program concepts of dual development efforts to obtain a single end item (component or system) were not implemented.

Some component testing was deleted by relying on the development testing of larger assemblies which included those components.

Some testing of noncritical items was deferred to the development flight tests.

The total-orbiter acoustic/vibration tests and some subsystem thermal vacuum tests were deleted by (1) relying on our knowledge of materials and designs performance in space as gained from preceding NASA program experience and, (2) depending on vehicle flight tests. Full confirmation was achieved by flying the Shuttle, while heavily instrumented, through a series of progressively more difficult flight tests to actually measure the operational acoustic/vibration, thermal and other environmental effects, and performance.

It is clear, however, that NASA did not delete any safety items or systems, or the planned or expected testing of the safety systems or related safety concepts or practices. Safety related systems were thoroughly tested even where they were redundant.

Ms. SCHNEIDER. Thank you, Mr. Chairman. I, for the record, would just like to say that in looking at various pieces of information, there seems to be a trend between the number of dollars spent, the personnel, and the procedures, and I'm curious to know what kind of conclusions we might be able to draw by looking at all three of those aspects. If I had more time, I'd ask how that could be looked at in an even larger picture insofar as NASA's budget versus the Defense budget for space purposes.

Mr. ROE. You will have time for that because we're going to go around again.

Ms. SCHNEIDER. Thank you.

Mr. ROE. We'll start with our next colleague, Mr. Boehlert, the distinguished Member from New York, and we'll go until the second bell rings and then you'll have your time when we come back. You can start now, yes.

Mr. BOEHLERT. Thank you, Mr. Chairman.

Part E of my colleague's question, and I think she addresses a very important and critical point.

The information provided us by staff indicates, for example, that in June of 1970, Marshall had 615 people assigned to reliability and quality assurance; and in August of 1985, that number was down to 88, which is an 86 percent decrease. So I think it's important, Admiral Truly, that we do have those figures because I think we all agree that safety is first and foremost.

If I may, I'd like to address something that I addressed yesterday with Secretary Rogers. And the reason I want to do so is because a great many people have asked me—and I'm sure they have asked our colleagues—about the crew of the *Challenger*. A great many Americans think that if Congress had provided more dollars, or NASA had established different priorities, it might perhaps have been possible to save the crew.

Is there any bail-out system or ejection system now operational, or even in the conceptual stage, that if part of the *Challenger*—would have permitted the saving of the crew?

Admiral TRULY. I believe in this accident, there is no system that is in development that could have saved the crew—

Mr. BOEHLERT. Because of the time factor, 73 seconds, the thrust and—

Admiral TRULY. The issue of egress and escape has been studied and argued in the shuttle program since its inception. The decision was made that the way to provide the best safety was to put that money, those dollars, into the reliability of the system during the first stage. The only sort of system that I, frankly, am aware of that could possibly be of use during the first stage would involve a combination of thrust termination on the solid rocket motors and, essentially, a detachable pod as part of the cockpit of the shuttle. That was determined just not to be a feasible trade in the early days of the shuttle program.

As we look at the issue now—and as I said in my testimony—we are reopening all of those possibilities, which vary from a major change to the system which could be accommodated all the way down to the possibility, at least, of a bailout capability in controlled gliding flight. We're just going to have to get those studies in and make the risk and gain trade-offs to decide what to do. In every

study when we made those tradeoffs before, particularly after we had gotten started in the program, the gains in the system to make a change did not balance out against the risks involved in modifying the hatch or putting in ejection seats or so forth.

Mr. BOEHLERT. But in this instance, the answer is clearly no to that question?

Admiral TRULY. That's correct.

Mr. BOEHLERT. OK.

Mr. ROE. Would the gentleman yield on that point?

Mr. BOEHLERT. I would be glad to yield, Mr. Chairman.

Mr. ROE. By the same token, I think you are developing a more positive approach. And the idea of balancing the system—and forgive me for being, not emotional, but what kind of a figure do we assign to a life? I mean, if we were dealing in equipment and material and things that we make with our hands as part of the system, and we evaluated that, what kind of cost evaluation did we make when we had seven lives involved? And I don't mean to come down on you.

Now, I just wonder what weight we put to a life in this engineering system we're figuring versus the point of view of whether we can or cannot afford it. And I don't mean to mislead anybody and second-guess your initial point when you talk about this particular flight, but it seems to me in a systems evaluation—and I don't want to belabor the point—that we ought to be talking about—and I think you're moving in that direction—we're going to take a very serious look at this and a very indepth look at what we may be able to do to be able to help astronauts in different modes, acts and potential modes. Is that a fair statement?

Admiral TRULY. We are looking at that specific question. The review studies of what the possibilities are with the shuttle system today are not in. When they are evaluated, first by Mr. Aldrich at level II, a recommendation will be made and we'll deal with it.

Mr. ROE. If the gentleman will yield further, and you'll have your time when we return, but we will be looking in our next oversight—because our oversight will be based continually on safety—we're going to be looking to that particular issue as to how we put the systems cost-analysis benefit ratio to the loss of a human life. And I think you would agree with that.

Mr. BOEHLERT. Mr. Chairman, if I could follow up on that, and you had promised me some additional time after this—

Mr. ROE. Yes, we'll give you more time.

Mr. BOEHLERT [continuing]. I'm just wondering on what level of safety we're looking for before we decide to put people in space. For example, just the other day Dr. Fletcher is quoted as saying that NASA remains committed to the civilian in space concept. But he also has said that will be delayed until shuttle flights are deemed safe enough for them, for the civilians. Are we going to have two levels, one level of safety for the astronauts, another level of safety for the civilians? And that's—I'll ask Dr. Fletcher to expand upon his response to that when he does get here, but I'm wondering where the dividing line is going to be.

Admiral TRULY. To me, a life is a life.

Mr. BOEHLERT. It is to all of us.

Admiral TRULY. The question is, in the shuttle system, are there things that we could do that would improve the crew escape posture that makes the risk less than it is today? I want to make sure that you realize that in many cases, things that are approved enter new risks into the system; for instance, pyrotechnics that would blow a hatch away, that would save you in a certain situation and kill you in another.

So it is a subjective question, and the question of citizens in space is a policy question. But the same protection will be provided at whatever level to whoever the occupants of the shuttle are.

Mr. SCHEUER. Mr. Chairman, I think it is relevant to note at this point, in amazement or disbelief, I might say, that while the NASA authorities have been using a figure of one predicted accident out of 100,000 flights, we had the testimony just yesterday of George McKay, a project engineer at the Marshall Space Center, who said yesterday that 20 years ago, Marshall safety engineers predicted a flight failure in every 20 to 25 manned flights. And he said, "We didn't tell anybody about it at that time because it would have scared the hell out of everybody."

Getting to your question, Mr. Chairman, of the value of a single life, when we have an ongoing program where the top safety officials know in their heads that there's likely to be a failure every 20 or 25 flights, when we have a series of 500 manned flights planned, they don't rate human lives very highly if they proceed on that intellectual risk assumption.

Mr. ROE. Well, if both gentlemen would yield, because we have to vote, we will suspend. But where I'm coming from on this question, which I realize is a sensitive, emotional question as both our colleagues do, is part of the policy decision that will follow as we unfold our observations over the next 2 days in discussing with you the details and facts. They're going to be based as to what ratio the manned space flight should play to unmanned space flight; that's where we're coming from in those questions.

So we'll suspend for the moment and return in 10 minutes.

[Recess.]

Mr. ROE. The committee will reconvene.

If I can have the attention of the Members and our guest witnesses, what we plan on doing is recessing from 12:30 to 1:30. And when we return, we think it would be profitable to demonstrate for the Members the motion picture that's there, and then we'll continue on. That will give them a good insight, I think, into what happened, those who haven't had a chance to see that before.

When we broke up it was Mr. Boehlert's time, and we defer to Mr. Boehlert.

Mr. BOEHLERT. Thank you, Mr. Chairman.

Hindsight is always 20/20, and I think all of us agree as we look back that had the conversation between the officials of Morton Thiokol and NASA at Marshall been reviewed at the very top, there probably would have been a decision not to launch.

Now, I note in Secretary Rogers' report that he is recommending—and it's a recommendation that I fully support—that in the future, prelaunch conferences be recorded so that we have a permanent record. But we don't want just a permanent record to review sometime in the future, God forbid, should another tragedy

occur. What we would like is a permanent record so at the very top, these conversations can be reviewed. Had that occurred in this instance, the decision not to launch probably would have been made.

So, Admiral Truly, could you address that point? No. 1, do you support the recommendation that these pre-launch conferences be recorded? And No. 2, can we go a step further and receive some assurances that, at least at your level and hopefully Dr. Fletcher's level, that will be reviewed so that you will have the benefit of discussions like the one that occurred with respect to the O-ring?

Admiral TRULY. This is specifically the kind of recommendation in the report that I'm going to ask Captain Crippen to lead a group and take a look at; that is improved communications and the very structure of the process in the decision to launch.

I might ask if Mr. Aldrich would have a comment to your question since he has participated directly in the flight readiness process far more than I have personally.

Mr. BOEHLERT. Fine. Mr. Aldrich?

Mr. ALDRICH. Yes. Well, I would comment that we have been looking precisely at those kinds of augmentation to the formality of the flight readiness process. Prior to the Commission's report, in anticipation of that finding on their behalf, both the recording of the meetings and the more formal requirement for participation from all organizations and formal structure of the timing of those meetings. What I have done is instituted some specific proposals.

Mr. ROE. Can the gentleman pull that microphone closer, please?

Mr. ALDRICH. I'm sorry.

I've instituted some action to provide a series of specific proposals on the readiness review process to provide to Admiral Truly and now to Bob Crippen as a basis for starting some of the re-look and final decisions in those areas following the Commission's report based on the experiences we have been through and our understanding of them.

Mr. BOEHLERT. And one final question, if I may, Mr. Chairman.

Dr. Graham, in your new role as science advisor to the President, could you expand a little bit on the role you envision for yourself in that office in connection with direct liaison with NASA? And I'm assuming the Senate will be generous in their confirmation.

Dr. GRAHAM. Yes. As you know, I'm subject to confirmation and wouldn't want to intrude on the prerogatives of the Senate to speak to that position until I'm confirmed. However—

Mr. BOEHLERT. Incidentally, when you're talking about the Senate, you're now in the bleachers. That's the grandstand over there. We're after the facts, and they're doing a lot of—if yesterday is any indication of what's going to happen during this proceedings—a lot of showmanship over there. I think you're seeing, in this committee, a determined effort to get at facts and have a good exchange.

Dr. GRAHAM. I will certainly continue, if I am confirmed to that position to take a deep and consistent interest in the national space program and in NASA's activities, both the program of returning to flight and the other activities that NASA will be involved in, as a major contributor to the national space program and as the leadership within the Administration in the civil space program.

Mr. BOEHLERT. Well, as a practical matter, when you were Acting Administrator of NASA did you have steady and frequent contact with the Office of Science Advisor? I recognize it's been vacant for several months now.

Dr. GRAHAM. Yes. First through Dr. Keyworth and his staff, and then through Dr. Mateg, and now Dr. Johnson. There is a steady flow of traffic and discussion between NASA and that office, and I believe it's very constructive and should be continued.

Mr. BOEHLERT. OK. Thank you very much.

Thank you, Mr. Chairman.

Mr. ROE. The Chair recognizes the distinguished gentleman from Missouri, Mr. Volkmer.

Mr. VOLKMER. Thank you very much, Mr. Chairman.

I'd first like to ask, this committee has been told by NASA in recent briefings that induced environment criteria for the SRB were signed off before the STS-1 in verification compliance notice 12A11. I'd like to know if NASA can provide us with the documentation supporting this decision.

Admiral TRULY. Yes, sir, we will.

[Material to be supplied follows:]

Material requested for the record on page 79, line 1747, by Mr. Volkmer during the June 11, 1986, hearing.

There was no SRB induced environment verification waiver pre STS-1. Enclosed find a copy of VCN 12A11 which shows that to be the case. (Note that the copy is a composite of multiple, identical forms which were processed in parallel by different functional areas. The individual copies are on file at JSC. The composite was prepared for Shuttle program level sign off prior to STS-1.) On the second page of the VCN, there are three incomplete requirements. None were SRB related and as the resolution section indicates, all were scheduled to be complete prior to STS-1. A check with the System Integration Office on July 16, 1986, confirmed that no waivers to the JSC 07700 Volume X induced environment verification requirements were in effect at the time of the STS-1 launch.

Enclosed supporting data also includes some documentation which will clarify the VCN. This data also includes page 3-40 of JSC 07700, Volume X which establishes the general requirements for each Shuttle element to be compatible with defined induced environments. The six pages (10.11 to 10.11-12) are from Appendix 10 of the same volume. These pages provide definition of those induced environments and provide applicable references.

Mr. VOLKMER. All right. Thank you. I'd like to have it within a week, if at all possible.

There is also, in reviewing the Commission's report, a great deal of confusion involving the, say, environmental criteria, temperature, wind, everything else, rain, that the solid rocket motor was expected to meet. And can you tell us what these criteria are, especially the ambient temperatures expected and the safety factor and the design? Or can you provide us documentation from the contract between NASA and Morton Thiokol stating the exact temperature criteria that the motor would be required to meet?

Admiral TRULY. If I might, if I would pass that question to Mr. Aldrich, who is the level II program manager.

Mr. ALDRICH. Mr. Volkmer, my understanding in reviewing this from the level II organization is that early in the program, an environmental criteria for launch performance for all elements of the shuttle system was established at a range of 26 degrees Fahrenheit to 99 degrees Fahrenheit. This was initially put on contract, or it was applied through my level II organization formally to all projects in the shuttle system for them. In turn, to apply directly to the contracts of their contractors who provide the hardware for the system.

In the evolution of the program the lower limit, the 26 degrees Fahrenheit was subsequently raised to 31 degrees Fahrenheit but was carried forward as the requirement from that time forward and has not only been on requirements for each project to design to, but also been in the launch commit criteria document that we have used for every flight as criteria for flight performance.

My understanding of the formal documentation is that that was applied to each project, including the Marshall projects, and that formal certification was provided back from all projects in the program, that elements had been designed and certified to perform within those ranges.

Now, within the solid rocket booster it does not break the booster further, as an overall requirement, down into subelements or subcomponents; it merely specifies that it can perform within its design spec, within those temperature ranges for those temperatures at launch from either east or west coast launch sites.

Mr. VOLKMER. And the SRB was supposed to be certified down to a temperature—overall temperature of the SRB—of 31 degrees?

Mr. ALDRICH. For launch, yes, sir.

Mr. VOLKMER. For launch.

Mr. ROE. Would the gentleman yield for a moment on that point?

Mr. VOLKMER. Well, could I ask my next question first? Then I will yield. And that is that I would like to be provided the documentation for that certification for the SRB, including all the testing that was done by the contractor to arrive at that certification.

Mr. ALDRICH. Mr. Volkmer, the documentation that I would have direct familiarity with would be response from the Marshall project to the level II program that says that those requirements have been fully met. The details of the contract and the certification testing between the Marshall Space Flight Center and the Thiokol Corp. would be a direct question, I think, appropriate to Mr. Jack Lee of the task force that has investigated in detail that aspect of the certification. He will have more direct knowledge of that than

I, although I am sure we can provide what documentation the task force has put together on that subject.

Mr. NELSON. I have that documentation right here.

Mr. VOLKMER. All right; fine.

Mr. ROE. I think it would be profitable if I understand where the gentleman is coming from. Were actual physical tests made, or were these determinations made by computer model analyses? In other words, where did these temperatures come from?

Mr. ALDRICH. In terms of the requirement?

Mr. ROE. Yes.

Mr. ALDRICH. An analysis of the expected range of performance that the shuttle system would be required to perform at was determined. Some of it was determined by analysis, and a wide range of environmental conditions are determined in order to provide the design specifications for the shuttle systems each to meet. The temperature criteria for launch was, as I understand, a fairly direct assessment of the likely conditions that we would expect to see during the norm of the program in terms of design requirements and launch conditions.

Mr. ROE. Well, the gentleman—I have other questions to ask on this issue, but it's your time. I defer back to you.

Mr. VOLKMER. I'd just like to ask—I know my time is about to run out, but I would like to ask either Mr. Aldrich or Admiral Truly, in your review of the critical items list—as I understand it, you are reviewing all parts, the 1, 1-R's, the 2's, the 3's, all of them—is there going to be, or will you have the National Research Council, an audit panel, be implemented during this review or utilized in any extent? As I understand it, the Commission made that recommendation.

Admiral TRULY. I was not aware they were going to make that specific recommendation, but I frankly welcome it. We will have to, obviously, talk to the National Research Council and work out an appropriate context in which they can perform the audit to this review that we're conducting.

I think that at some point it might be very helpful on this criticality 1 and 1-R review that we invite Mr. Aldrich to give you a good description of it because it's come up several times in the questions, and I think that in the hearings it might be very helpful to get a better and more detailed description of what that review is.

Mr. VOLKMER. Mr. Chairman, if I may comment, I would like to have a little more detail of how that review is taking place and who is doing the actual review, especially as a result of reviewing the Commission's report in regard to the SRB and the fact that the joint was put on the 1-R list and then put on the 1 list, and then we end up having nothing but waivers. So I have some questions in regard to that. From the outside, I think that—it's not that I don't trust everybody, but maybe it would be better to have someone on the outside actually doing this audit, as well.

My last question has to do—what was the actual temperature at time of launch, the ambient temperature?

Mr. ALDRICH. Well, again, I think it would be better, perhaps, to ask someone from the task force, perhaps Bob Crippen. My knowledge of that is that there were several readings for the tempera-

ture at launch, depending on how high above the ground on the service structure, and my understanding is it was in the range of 36 degrees Fahrenheit to 38 degrees Fahrenheit.

Mr. ROE. If the gentleman would yield, that's a legitimate question and you're suggesting, Mr. Aldrich, that we would ask them.

Those team leaders are going to be here tomorrow, Hal, and please propound the question again at that point to get it on the record. And I agree with you, because I want to add to that line of questioning. I will give you a copy of these three or four questions that we want to get into the record, to respond this afternoon. I want you to think about them a little bit. For example, we're saying that in general, all Government procurements require a qualification of test, or an equal test, as a condition of acceptance, and assures that it is designed to meet and will operate in the expected environment. That's the fundamental question. Then we're going to ask you, was there a qualification test call on the design specs for the joint? What were the quality test specs for the joint? Did the joint and seals pass the quality test? And four, was the 51-L flight environment within the equal test envelope?

We'll give you that to take a look at so that we can ask those questions of you this afternoon, and that will be more helpful, I think, in responding along the line of what Mr. Volkmer is speaking to.

Any further questions, Hal?

Mr. VOLKMER. No, that's all. Thank you, Mr. Chairman.

Mr. ROE. All right.

The next person—the next member is Mr. Fawell from Illinois.

Mr. FAWELL. Thank you, Mr. Chairman.

Yesterday I propounded a question to Neil Armstrong, and it had to do with his statement that there had been a change of attitude or mindset or policy, or I guess call it what you may, at NASA in regard to, just in general, the "can do" attitude as he described it which prevailed at one time, and the idea that a launch would be presumed to be unsafe and would have to be rebutted, to an attitude now that would be best described as saying that a launch is safe and you're going to have to rebut the safety features of that. And I asked him the question as to when that mindset or when the policy appeared to change, and he couldn't pinpoint it, nor necessarily get too specific, but I did make reference to an act which, at that time, I didn't know the correct name, but it's the National Aeronautics Space Council, or what is called the White House Space Council which at one time was in effect; and I believe in 1973 President Nixon unilaterally, by Executive order, disbanded that.

I've had several who have mentioned to me they felt that NASA thereafter was described by one as a headless agency and didn't have that guidance from on top which certainly sets broad, subjective policies such as safety and other subjective policies.

Could I have some response, Admiral Truly, from you in that regard? Do you think the abrogation of the White House Space Council did have a detrimental effect on the basic attitude and positive, can do attitude and presumptions to which I've made reference?

Admiral TRULY. I'm afraid that I'm like Mr. Armstrong, Neil, who I'm sure responded to that question yesterday. I frankly don't think that the absence or presence of that body watching over the space program was a specific act that changed an attitude within the agency. As a matter of fact, I think in general, the attitude within the agency hasn't changed. I know as short as 2½ years ago, when I was at full-time duty in the shuttle program in the Astronaut Office, a large percentage of our time was spent in the office—and also in the control boards, and so forth—in safety, and I think that continued right up to January 28.

The chain of events that led to this accident, though, undoubtedly did include subtle pressures that caused the workload to go up and to steal from the attention that people were able to pay. However, I don't think that those were the cause of this accident. I think this accident was caused by a specific failure within the system to see a problem that was quite apparent, and was waving a flag and should have been caught. And I think the body of this Commission report concludes the same thing. It is my duty and goal to make sure that before we fly again, that whatever led to this tragic event will not happen because of any problem of attitude within the agency.

Mr. FAWELL. Would you agree——

Dr. GRAHAM. May I add one comment to that, please?

Mr. FAWELL. Certainly.

Dr. GRAHAM. Of course, as you know, Mr. Fawell, this administration has had a very strong interest in the space program over the last several years and has, in fact, conducted frequent White House-level reviews of space policy. But the thing to remember here is that the involvement of the Executive Office of the President in the space program has been at the policy level; and President Reagan has, in fact, provided strong policy guidance for the program. The implementation of that policy rests with the agencies, which is NASA. Today, the generation of the policy is done through an interagency process which is led by representatives from the National Security Council at the working level, and finally by the President at the top level. And that process has generated strong policy for the space program over the last 5 years.

Mr. FAWELL. Now, you are talking about the Senior Interagency Group on Science?

Dr. GRAHAM. In fact, the hierarchical structure starts with the Interagency Group, which involves a number of agencies of the Government. And today, more agencies than ever before are involved in the space policy because space has become such an integral part of the activities of so many agencies, from Justice Department, Commerce, Transportation, NASA, and on.

After that is the Senior Interagency Group; after that is either the Cabinet or the National Security Council, and finally, the President himself.

Mr. FAWELL. Now, I have only hearsay to report; I am by no means an expert. I have had people tell me that there is bureaucratic entanglement insofar as this particular Senior Interagency Group and that, as a result, NASA has been left in a rather independent status so that it can make many of its decisions without

real strong policy coming down. I don't know how accurate that is, and I realize that that has not been in being for any length of time.

My feeling, though, is that basic policy on emphasis of safety comes from on top, and I've had a number of people express to me that the White House Space Council, which was abandoned roughly in about 1973, was doing a very fine job in giving that on top guidance, and that its guidance—especially in terms of emphasis on safety and the presumption being that it's unsafe and it must be rebutted, being, as Neil Armstrong has indicated, somehow that concept was lost and reversed, that the White House Council had a great deal in putting that kind of emphasis from on top onto NASA. That's the reason I have propounded those questions, and I am seeking only to see if we indeed need that kind of—and I think there is legislation pending that will reinstate the White House Council, as I understand it. It would appear to me that that may be something that did contribute to what Neil Armstrong, I think rather aptly, referred to yesterday.

Thank you, Mr. Chairman. My time has expired.

Dr. GRAHAM. May I just respond, Mr. Chairman, briefly?

Mr. ROE. Dr. Graham, of course.

Dr. GRAHAM. The interagency process dealing with space issues today is considerably more complex than the process was in the early 1970's. I view that as a tribute to the space program, to this committee, and other Members of the Congress who have, in fact, helped to make the space program an integral part of so many of the activities of the Government, and so many of our international activities, as well. That necessarily leads to a more complex process because many more interests are involved now than they were a decade or a decade and a half ago.

Nevertheless, there has been a continued strong leadership through this administration in the space program and in the policy of the space program which has been generated in the White House. NASA's task in the civilian area is to implement that policy; and if we have encountered a difficulty in the safety area in the last two decades, as we clearly have with respect to the *Challenger*, I don't believe it has been lack of sound policy concerning safety; it has been too much the assumption that safety is inherently wired into the system, and can't leak out, no matter what we do. That's not a correct assumption. We have to work every day to keep safety in the system, and one of the consequences of the *Challenger* accident—as, in fact, was the consequence of the Apollo fire nearly two decades ago—will be to rededicate the agency to making its implementation of space policy based on an active pursuit of safety in all activities undertaken.

Mr. FAWELL. All right. Thank you.

Mr. ROE. Doctor, I appreciate your comment and I don't feel as if I got an answer to my earlier question that I asked.

One of the recommendations under four of the Commission said that the safety organization—"NASA should establish an Office of Safety, Reliability, and Quality Assurance, to be headed by an Associate Administrator, reporting directly to the NASA Administrator." Do you subscribe to that point of view?

Dr. GRAHAM. Yes, Mr. Chairman. And certainly, along with the other recommendations of the Commission, we'll look at that one very carefully.

At the present, that responsibility for safety, reliability, and quality assurance does lie with an Associate Administrator reporting directly to the Administrator. That Associate Administrator is the chief engineer.

Mr. ROE. Well, what's bothering me a little bit—just so we get clarification for the record, to know where you fellows are coming from—part of the discussion that came from Dr. Fletcher came back and said, well, remember, those things were not specific recommendations or other specific directions; they were recommendations for consideration. In this instance, that's not a recommendation for a consideration. They use the words, "NASA should establish." So do we consider any of these areas where we come down, in the recommendations, where it says "should" as compared to "may" or "maybe" to be something that would have a stronger balance in your thought process—and, boy, am I being sensitive to this issue right now.

Mr. GRAHAM. I think there is a difference in the recommendations in the various areas, and we are paying attention to that. But I would add that we already have an Associate Administrator who has among his responsibilities safety, reliability, quality assurance. I believe the question before us is, should there be an Associate Administrator position dedicated only to those functions? And we'll certainly consider that as we go forward in implementing the recommendations of the Commission.

Mr. ROE. Well, I don't want to belabor it, but I would suggest the point of view that obviously the Commission certainly must have known that, or they wouldn't have put the recommendation in, No. 1. I'd be astounded if they didn't.

I think, No. 2, they're saying that we should be creating an Office of Safety, Reliability, and Quality Assurance. Part of what you were responding to the gentleman from—Mr. Fawell from Illinois—a few minutes ago was based upon your concern with the transmission of safety information through the whole structure, and I applauded that approach. I just want to nail down for the record that there seems to be a hesitancy of saying—are we saying that we've already done that, that NASA has in place an Office of Safety, Reliability, and Quality Assurance that's headed up by somebody? Or is it effective? Why did the Commission recommend that or put it in their response at all?

Dr. GRAHAM. Mr. Chairman, we're saying that that recommendation has, in fact, been in place in one particular form. The fact that it is a recommendation there indicates to me that the Commission is suggesting that that form may not be adequate, and we are going to go back and look at that very hard and make sure we understand exactly what the Commission was trying to get at and what it recommended, and consider that as we go forward. We will give that the most serious consideration.

Mr. ROE. Well, making the point on the record so that when we call you back shortly we'll be looking for what your response is going to be to that.

I thank the gentleman from Illinois.

The next colleague is Mr. Slaughter, our distinguished colleague from Virginia.

Mr. SLAUGHTER. Thank you, Mr. Chairman.

When can we expect NASA to have a schedule for shuttle flights over the next years?

Admiral TRULY. We have a preliminary schedule for the earliest possible flight of July of 1987. During that year, we have already planned that the maximum rate will be either six or seven flights, and that will depend on specifically which vehicles we will fly. I hope within the next few weeks to be able to recommend a manifest for specific flights throughout that period, and it would be available at that time.

Mr. SLAUGHTER. I have no further questions.

Mr. ROE. I thank the gentleman.

The Chair recognizes the distinguished gentleman from Florida, Mr. Nelson.

Mr. NELSON. Thank you, Mr. Chairman.

Mr. Chairman, I have three questions for this round of questioning.

First of all, I want to follow up in my discussion yesterday with Chairman Rogers and Vice Chairman Armstrong on what we learned when we were with you, Admiral Truly, last Friday down at the Kennedy Space Center on the question of the verification for the contract specifications of how the SRB was to operate under natural temperature and also under the induced temperature. And the contract specs are contained in a document that was prepared for Marshall by Thiokol dated February 17, 1984, in which—the temperatures have been mentioned here earlier—from 99 to 31 degrees, and with an induced temperature that goes down to 25 and, in another case, 21 degrees.

I have the documentation here of the verification that was signed off by all the parties for the flight of STS-1 and then I have the documentation also on the verification for STS-5. What can you tell us that you know about why was this verification given if, in fact, as you and I learned at the Cape on Friday, that testing in fact was not done? What do you know about it? Just share that with us.

Admiral TRULY. I'm going to have to take that question for the record or ask you to ask it again when we have our test team members here tomorrow, that they can help answer that.

Mr. NELSON. Well, let's ask Mr. Aldrich. Since these Level III folks at Marshall would be reporting to you as the program manager, what do you know about why wasn't the testing done?

Mr. ALDRICH. Mr. Nelson, I know very little about the details of the testing and the response between the level 4 contractor organization and the Marshall level III project organization. I have not participated with the task force and have not delved into that in detail. I have researched the feedback to the space shuttle program to the level II from Marshall indicating full compliance with that requirement for induced requirements as part of the certification that was reported prior to STS-1 and has continued forward since that time.

Mr. NELSON. All right. So you're telling me, nobody knows the answer to the question? The question is, does anybody have a clue

as to why, under the obligations of the contract, the testing was not done? And why NASA signed off on two occasions that the testing, in fact, had been complied with—the contract had been complied with? Is there anybody here that could address that question now?

Admiral TRULY. No.

Mr. NELSON. OK.

After we heard that on Friday, what did you ask, Admiral Truly, to be done with regard to providing information to you on this particular question?

Admiral TRULY. At this point, I have not asked for any action, but I certainly will, since as you know, at that point we were waiting for the Commission report. I do not know what that task team concluded in its report, or precisely what the Commission staff developed on that issue. But I certainly understand the line of your question, and I would like to take it for the record to supply the answer as best we can put it together.

[Material to be supplied follows:]

Material requested for the record on page 97, line 2191, by Mr. Nelson during the June 11, 1986, hearing.

There are no qualification test specified in the design specifications for the joint per se. There are, however, design specification and verification requirements for the performance of pressure seals and the structural elements (i.e., case and nozzle). The case joint pressure seals are to be redundant and verifiable through an external test port. Natural environment specification, to be certified by analysis, are 31°F to 99°F (JSC 07700, Vol. X, Appendix 10.10). Induced environment specification, to be certified by analysis, are 25°F to 120°F (SD74-SH-0144, ICD 3-44003). The lowest established joint temperature in test was 40°F during one of four demonstrations and three qualification static test firings.

Mr. NELSON. OK. When will those folks that you're talking about attend?

Mr. ROE. Tomorrow afternoon. Tomorrow.

Mr. NELSON. Tomorrow? OK.

The other question that I would like to address specifically on this issue is, since everybody is saying that it was not complied with, in addition to why wasn't it complied with, is there some contractual breach here that we need to know from a legal standpoint? So let's address that.

Admiral Truly, earlier today Dr. Fletcher had indicated again that the earliest possible date that we might fly is July 1987, and I'm wondering about that date by virtue of a report that was given to NASA before you came back to NASA last August, August 1985. It was a Thiokol briefing to Mr. Weeks at headquarters, and it was talking about a redesign of the joints—in fact, putting a capture feature—and it said that “the earliest possible implementation”—and I'm reading right from their report to NASA—“was on STS-81N,” which, under the manifest, was scheduled for August 1988. Now, if that report would have said that in a redesign for a capture feature—and this is a report that was given last summer—why do we have reason to believe now that we could come up with an opportunity to fly incorporating some of the same redesign, but to be some 12 or 13 months earlier than what was projected?

Admiral TRULY. I'd like to briefly address that question and then ask again that it might be directed tomorrow to Mr. John Thomas, who is head of our SRM redesign team at Marshall.

We have recognized that in order to get into tests with the new design, we've had to expedite the delivery of the case segments in order to get them into a test program that could meet a flight date whenever it may be. The capture feature is one of the various features that is being considered. The early indication that I have is that alone, probably not an adequate design. But that's what the redesign team is for, to look at the various redesigns.

So I think the specific answer to your question is, we've had to spend money and effort in bringing those case segments forward as quickly as we can.

I should point out at this time that those various case segments that have enough metal to have a capture feature on them are a threat to the schedule of the summer 1987, as is the tooling that is required at the manufacturer's plant to machine them. And we will continue to evaluate those schedules and try our best to meet them, but within the context of what Dr. Fletcher said in his statement, and that context is flight safety.

Mr. NELSON. OK. I'll follow up on that tomorrow.

Mr. Chairman, if I might, the third question that I wanted to lay out here—let me get Admiral Truly's response on this.

In the report, the Commission notes that—

Numerous contract employees have worked 72 hours per week, and frequent 12-hour shifts.

And then it goes on to cite—

The potential implications of such overtime for safety were apparent during the attempted launch of STS-61C on January the 6th, when fatigue and shift work were cited as major contributing factors to a serious incident involving a liquid oxygen depletion that occurred less than five minutes before the scheduled liftoff.

You and I have talked about that draining of the LOX from the tank. They're saying that that was due to fatigue and excessive work shifts. Do you agree with the Commission? And if you do, what is the plan for action to alleviate such fatigue in the work shifts in the future?

Admiral TRULY. Well, I must tell you that I've been very concerned about looking at some historical data part of the flight of the overtime that was required in the year and a half or so before the flight. If you plot overtime at the Cape versus the number of vehicles in flow, it was increasing. And I think what we plan to do in the future is to make a major effort to take a look at what a reasonable industry standard is and with our shuttle processing contract down at the Cape, what our actual capability is to make sure that the flight rates that we choose do not require overtime above some level that we choose through study and work to be proper. In other words, we're going to look at the overtime; when we get back to flight, we're going to agree on what the sort of level is, and we're going to manage to that and not allow pressures to increase the flight rate to get ahead of our resources, our people resources, to do those jobs.

Mr. NELSON. Mr. Aldrich, you were right there at the Cape in January. That's sort of an unfair question to Admiral Truly, because he wasn't back with the organization. Do you agree with the Commission statement? And if you do, what do you plan to do about it in the future?

Mr. ALDRICH. I agree with the Commission statement in general, that large amounts of overtime were required for the pace of schedule that we were seeing during the latter half of 1985 and leading into 1986. I'm not sure I would draw that conclusion about 61-C, however; if you will recall, we were scheduled to launch on December 19, and had a problem where we were not able to launch on that day, and the mission team made the decision to wait until after the Christmas holidays, with one of the major considerations being allowing the team to have time off for that period, and pick up again in readiness to launch on January 6. So that might be one of the periods more prone to, in fact, allowing relief and a break for the team, although I'm also sure that maybe specific individuals might have been involved in a way that caused them not to get the full break during that period.

Mr. ROE. In the future, there's no question that that consideration needs to be addressed directly? We understand the work we're requiring the teams to do. And also, the spread across the number of people on the team and make sure no single element of it is overloaded beyond the point of our understanding of the total team schedule. And we'll be looking into that in depth.

Mr. NELSON. If you took this recommendation, Mr. Chairman, to its logical conclusion, it would mean that there would have to be either much less frequency of flights or, as the buildup of the frequency occurs, a greater work force in order to more evenly distribute the workload so that the stress and fatigue factor did not come in here. And therefore, that has imminent budgetary implications which we're going to have to get onto as we get into the authorization for appropriations legislation that's coming on down the pike.

Mr. ROE. If the gentleman would yield, I think that your line of questioning this morning goes in the direction which the Chairman has been trying to direct this, which is the safety aspect. And it seems to me that as we—I know it takes time and a great deal of energy—but as we are developing these specific points, they are all leading towards ultimate policy decisions, funding, priorities, and the points of safety that you're mentioning. So I think your contribution is extraordinarily important; especially having been there, it is very important.

Now, if we would now take our break as we had discussed, and we will return at 1:30 to begin our program this afternoon. I want to thank everybody, and we'll see you at 1:30.

[Whereupon, at 12:33 p.m., the committee recessed, to reconvene at 1:30 p.m. the same day.]

AFTERNOON SESSION

Mr. ROE. The committee will reconvene.

When we took our recess we were in the middle of questioning by our distinguished Representative from Florida, Mr. Nelson, and then we were going to now welcome back Dr. Fletcher, and Mr. Germany, however, has joined us now; right?

So I now defer to Rear Adm. Richard Truly. Begin again, if you will, for the record, to introduce and give us some background on Mr. Germany, and then we'll—and then go ahead and outline what our plan is for—your plan for right now.

Admiral TRULY. Thank you, Mr. Chairman.

On the makeup of the NASA task force, we had six major teams, and one of those teams was the photo and TV analysis team. And Mr. Dan Germany from the Johnson Space Center was the leader of that team.

That team supported the Commission and all of the other teams with all the thousands of frames of individual photography, television shots, and so forth, and has pulled together a short TV look at the accident itself, and I think, without further ado, it would be helpful for me to just turn it over to Mr. Germany and let him talk for a moment with this model of the space shuttle here to my right, and then allow him to narrate the TV.

Mr. ROE. Splendid.

We have Dr. Fletcher and some folks sitting up here to see this film because they haven't seen it before.

Mr. Germany, if you would go ahead.

Mr. GERMANY. OK. Thank you, Mr. Chairman and members.

The photo-TV support team concentrated all of its efforts on taking the products that we received that day from the flight—

Mr. ROE. Would the gentleman yield? This is one of five teams; correct?

Mr. GERMANY. Six teams, sir.

Mr. ROE. One of six teams?

Admiral TRULY. One of six teams. Four of the teams paralleled in a one-for-one relationship the four teams on the Commission.

Mr. ROE. If the gentleman would yield, it might be profitable—I'm sorry to interrupt you—it might be profitable to—for the members of the committee that didn't have an opportunity to visit with

you, together with the folks that are here and other witnesses—it might be well to give us a little rundown on the six teams, the six teams that served, because they're going to be testifying, as I believe, some of them, tomorrow, are they not? They will be with us tomorrow. So why don't you just give a quick overview of that?

Why don't you give an overview and then we'll revert back to Mr. Germany so he can pick up this one team, and then we'll have—

Admiral TRULY. Thank you, Mr. Chairman. That might be very helpful.

The NASA task force was organized with myself as the chairman and Mr. J.R. Thompson, who will be here tomorrow, as the vice chairman. I remained in Washington during the conduct of the investigation, and Mr. Thompson was located at the Kennedy Space Center.

As I pointed out a moment ago, we had six teams on the NASA task force. Four of the teams, four of the six, paralleled on a one-for-one relationship the four teams on the Commission, and I'll speak to them in a minute.

We had the two additional teams of the NASA task force. The first one was the search, recovery, and reconstruction team, which was the team that managed the salvage effort to get the actual physical evidence and debris of the *Challenger* from the ocean floor and then examined that physical evidence in large hangars at Kennedy Space Center.

The second team is the team that Mr. Germany headed, which is the photo and TV support team.

The four teams that paralleled the Commission teams were the development and production team headed by Mr. Jack Lee, who is the Deputy Director of the Marshall Space Flight Center. He looked at the development process, the part of the investigation that had to do with the buildup of the solid rocket motors, for example, in the factory.

The second was a team called the prelaunch activities team, headed by Mr. Tom Utzman, who is the Deputy Director of the Kennedy Space Center, and the prelaunch activities team looked at the flow of the vehicle and the buildup of the 51-L *Challenger* spacecraft as it approached the path.

The third team of those four was called the Accident Analysis Team, and it was actually headed up by Mr. J.R. Thompson, as well as his job as the vice chairman of the task force. That was the team that supported the Commission in the elimination of the various problems that were postulated; for example, a problem in the external tank in the orbiter. And, as you know as you read the Commission's report, finally narrowed down the final cause of the accident, which was the fatal joint in the solid rocket motor.

And, finally, the last team was mission planning and operations team, which looked at things like manifesting, workload it caused at the Johnson Space Center, training, things like that.

In tomorrow's hearing we will have each of those team leaders here as well as Mr. Thompson, and Mr. Germany, then, was one of the six key leaders of our six teams.

Mr. ROE. The Chair recognizes Mr. Germany.

Thank you very much, Admiral Truly.

Mr. GERMANY. Thank you, Mr. Chairman.

As the admiral said, the photo team consisted of people from each of the three major centers—Johnson, Marshall, and KSC. We had approximately 100 people including contractors and some photo facilities, processing facilities, outside the Agency that helped us with our analysis of the products that we received that day.

There were roughly 108 film cameras and roughly 69 TV cameras, for a total of 177 cameras from which we got products that we analyzed, and represented about 13 million frames of film.

What I'm going to do today is to narrate a TV film that we put together that is a compilation from several of the cameras that we had. But before I do that, I'd like to use this model to try to orient you just a little bit, so that when you do see the film, perhaps it will be a little bit easier for you to pick some of these things up.

A lot of times it happens so fast on the film it is very difficult to pick it up the first time you see it with your eyes, so a little bit of orientation here—

Mr. ROE. Are you able to—when there is a specific area that you want to highlight, are you able to stop the film at that point?

Mr. GERMANY. We have used stop action with the way we put the film together, and it turns out that that's not—

Mr. ROE. You can?

Mr. GERMANY. I'm going to answer for you.

Mr. ROE. I'm sorry.

Mr. GERMANY. We've used stop action to put the film together. Some of that is stopped as it's moving. If it's not really clear to you, then we can stop it and run it back.

Mr. ROE. OK.

Mr. GERMANY. However, with this recorder we have here, when we stop it, you lose everything and you've got to punch the buttons back and forth. All right. So you may get tired of that if we have to do it, but I'll be glad to.

The model as you know, the shuttle when it takes off—Admiral Truly told me not to pick the model up because he doesn't want me to break it. When the shuttle takes off and flies like so—so this is the righthand SRB, and the points of interest will be the leak that developed was right on this side and around the 300 degree point. Actually when—the recovered hardware that we got back, the burnthrough was from that 296 degrees to 316 degrees, 294 to 316.

So you'll see the flames and the smoke actually come from this part of the vehicle. When you see the film, it will be obvious to you what I'm talking about there.

The other thing that happened, first of all, there are three main segments of activities, I guess you could say, that occurred with respect to the anomalous events we saw with the photography. The first took place at 0.678 seconds when we saw the puffs of smoke that occurred, and you'll see those.

At 0.836 seconds up to 2.5 seconds there were multiple puffs of smoke, and I believe Mr. Rogers mentioned that yesterday when he was here. It was like eight or something like that. And then at 3.4 seconds you stop seeing any smoke. That was the last time we saw smoke.

Then there's a period of time in which there are no anomalous events in the photography. About 58 seconds is when the first flicker of flame appears in the same area from which we saw the smoke. And that goes from a flicker of flame all the way up to a large flame that you'll see that resulted in the LH₂ tank leak which occurred about 64 seconds.

Now, a point of orientation for you: this is the external tank. The lox tank is on top and the hydrogen tank is on the bottom. So that LH₂ tank leak I'm talking about occurred right around here, which is what we call the 2058 ring frame. And 2058 is just a station location as you move up and down the tank. But that's just for simplistic sake we call it a 58 ring frame. That's when the lead occurred, about 64 seconds. And then there's a period of time, about 9 seconds, when nothing really happens that we see on the photography.

Then at 73 seconds into flight, 73.124 to be exact, is when we have an LH₂ tank failure, and you'll be able to see the LH₂ liquid as it comes out.

At the same time this righthand SRB starts to move, because what's happened is either the strut was burned into or we had breach of the tank where it came loose. When it came loose and it moved out this way, and this part of the SRB crushed into or hit the intertank area—intertank means that space between the lox tank on top and the LH₂ tank on the bottom. And when that happened, essentially losing the integrity of the external tank structure, the significance of that is this whole vehicle configurationwise is tied together through this external tank. You've got the SRB's that tied to this ring frame I mentioned. At the far point there's a large truss structure that goes across the intertank area. So when you lose the LH—the ET tank structure, then the whole thing we call structure breakup occurs.

And that—from the point that we saw the LH₂ tank failure, which is 73.124 seconds, then at 73.327 is when structure breakup occurred. So that's only 0.2 seconds or like 200 milliseconds.

OK? So with that, then, what I'm going to do is roll this film, but before you do it—what I'm going to have to do, Mr. Chairman, to help you is I'm going to come up there and use the monitor and to use the mike. So it will take me a second to get my props set up.

Mr. ROE. I understand they have to leave this one spotlight on.

Mr. GERMANY. We've got that all squared away.

[Pause to begin film.]

Mr. GERMANY. Let's see. Someone's going to get the lights in the back.

OK, Tommy, are you ready to roll? OK, go.

[Film being shown.]

Mr. GERMANY. We're starting with the first sequence that shows the smoke.

This is one of the TV cameras. You'll see the smoke coming right there. We're going to show some isolated views in a second so you can see a little bit clearer, but that's the first time.

This is engineering camera 60.

You can see it coming right there. We say multiple puffs. You can actually see it kind of billowing out as it goes. You're going to see that clear in just a second.

OK, this will be a little bit clearer because of the background here. See the black smoke going right there? There you go.

Then it disappears at that 3.3 seconds and then we don't see it anymore.

This is a combination view. Here and here.

This is a data camera that's kind of looking to the side. You can see it.

But we said it moved initially in the plus X direction, meaning it's moving like so.

This is attach point that goes around the SRB to the 2058 ring frame. The joint itself is right above there, right about in there.

This is later on in the flight where we first see the flame development, and we're going to show you several views here. You can start seeing a little bit of the flickering that goes—see right there.

We'll go back and isolate this and you can see it. There are several frames here to give you a perspective of it.

You can't see much from the camera because we purposely darkened the background so it would highlight the flame when it appears. That will show up in a second.

There you go. That's that 58 second point I was talking about.

So essentially what happened, you had the smoke; then it tended to heal itself a little bit; and then later on it started developing. Once that flickering starts, then it gets progressively larger as it goes.

You can see it isolated on this shot over here.

As the flame gets larger, the plume gets larger, the aerodynamic effect makes it tend to move to the rear.

And as that's large enough, what that means is the hole is just getting larger as it grows. Then the whole thing is constant.

And after that occurs, then the flame is impinging upon the LH₂ tank—is what caused the leak to develop.

There right there.

I can see it just getting progressively worse. At that point the R rates here is what helped us to understand that their right-hand SRB was starting to move.

This is a computer-aided design picture here, and what we have done is accentuated the motion and we rock it back and forth. Actually it did not rock back and forth, but that's just to let you get an idea—is that motion I was talking about earlier in the model occurred here.

Then once it started to move away is when it collapsed into the intertank area forward.

You'll be able to see the LH₂ tank failure because the flame will start to look different here.

There you go right there—when it just changed that color there, that was when the tank failure occurred.

This first hint of vapor at the intertank area is an indication that that lox tank on top was leaking after the SRB moved into it; that's right.

These are taken from 70 millimeter frames, and they are clearer on my tape, but when you make it into a TV like this, you lose a lot of the clarity.

Then you can see a flash in here.

Due to aerodynamics, when this hydrogen is leaking here and the lox is leaking here, the hydrogen actually tends to move up the side of the vehicle, and when it did, it combined and then from the heating you got the flash there.

This is what I meant by us using stop action, when we made this, to help you to see it.

This intense white flash is when we believe the total structure breakup occurred.

The greatly increased intensity of the white flash—that was just the way we indicated that was when the structure breakup occurred because it appeared to the large explosion occurred here.

Oh, the vehicle came apart. OK, the SRB's and the orbiter and the ET just all came apart.

We call it structure breakup rather than a real explosion because a lot of people argue whether or not it was really technically an explosion, but we know it was structure breakup.

What this series of frames is—this goes back and repeats what you've just seen.

You're going to see the chute here in a second and nose cap, the right-hand SRB. There's that nose cap going. It'll stop here in a second.

There's the chute and there's the nose cap there.

Then you're going to see range safety destruct to the right-hand SRB, and then on the left in a second.

Here's the left.

Now you're going to see a frame of them side by side a little further distance away. Here and here.

It was going out of the limits that the range safety officer had, so he went on and destructed. It turns out it really helped, because if those things are burned to completion, they probably would have been out in such deep water it would have really been tough for recovery.

[Film stops temporarily because projector is unplugged.]

Mr. GERMANY. Tommy, would you stop that and just back up for a few frames because I want to get the header of this? Just push rewind and just—Mr. Chairman, stand by. We're going to have to replace on this because I want to see the first of this.

OK. Because of the interest in the crew cabin, we've included some filmage here. You're going to see this several different sequences, so we'll start with the larger picture first and then we'll zoom right in on what we're able to see.

There's some pieces that were coming out here. This was the wing that was going off in that direction.

We'll zoom it back in in a moment, but in the second smoke trail is where the crew module ended up going. We're going to show you some details of that.

This is from camera 202.

It's going to be coming right through there. I'm going to show you some more details in a second.

This one right here is the one that did the dippy-doodle which was left; right?

Now when we did this, we took some TV and enhanced in on a frame-by-frame basis.

That was not it right there. No, it was another piece.

Coming up. See, right there? It's going to cross through that smoke in just a second.

There it is right there. OK? We think this is the remainder of the SS and these burning in the aft compartment there.

Mr. BOEHLERT. How did you identify it? Did you enlarge the frames?

Mr. GERMANY. These have been enlarged a little bit; yes, sir.

You can see it a lot better on a light tobe when you have a 70 millimeter, and it just stood there and just stayed at it for a long time.

Now it's coming down here. That's the crew compartment, yes.

In a moment you're going to see one more series. It looks like it's moving up, but that's just the way we did it when we put it together. It's actually not moving up, but this just gives you an idea of what it looked like.

And that completes the film, Mr. Chairman. In fact, that completes what I've got for you today. I guess tomorrow we're going to use a cam line, and the cam line I can show you what's happening on the vertical side as well as from the photography point of view.

Are there any questions?

Mr. ROE. Well, does any particular member have any questions on this particular issue at this time?

The gentleman from California?

Mr. PACKARD. Just one came to my mind. Is there any significance as to the black puffs of smoke, the color of the smoke, because there was black and white smoke together there?

Mr. GERMANY. The color of the smoke would tend to indicate there's hydrocarbons burning which could represent the erosion of the O-ring that's taking place as well as there's grease in there as well.

OK. Thank you, Mr. Chairman.

Mr. ROE. Thank you very much, Mr. Germany.

All right. Well, we want to welcome you back, Dr. Fletcher and your other colleagues. And I think that was a very descriptive presentation made that helps the members a great deal to understand the sequence of events which I'm sure will be helpful when we get into the additional questions and answers.

Now we had just finished before lunch with Mr. Nelson—I'm sorry, Mr. Nelson from Florida, and now we have our next colleague, Mr. Valentine from North Carolina.

The gentleman from North Carolina is recognized.

Mr. VALENTINE. Thank you, Mr. Chairman.

We have had to leave here so often and we've been in and out, and this might have been covered by your—

Mr. ROE. Will the gentleman pull the microphone closer, please.

Mr. VALENTINE. This might have been covered by your testimony. If so, I apologize, but we are discussing the findings of the Rogers Commission, and I would like to know whether or not there is now or has been an ongoing, internal investigation by NASA and—or if, after the Rogers Commission was constituted and went to work, whatever was contemplated in that area kind of merged with the Rogers Commission. That may be more than one question, but—

Admiral TRULY. NASA did participate fully in the investigation as a part of the NASA task force and those six teams that I described a few moments ago in support of the Commission.

All of our investigation was done essentially in their support. We met with them many times. I'm not aware of another internal investigation that has gone on. Naturally during the progress of investigation there were thousands, literally, of things that were looked at, but it was done under the NASA task force in support of the Presidential Commission.

Mr. VALENTINE. So what you're saying was that what we have at this point is one investigation, that there was not any kind of parallel effort?

Admiral TRULY. That's true.

Mr. VALENTINE. I'm not talking about whether or not there was an effort to look at problems of communication, the things that have been addressed here, but whether or not there was another internal investigation of the tragedy, the explosion, that might have reached a different conclusion or might have been compatible with the results which have been explained, or if there was anything of that kind that might be of interest to this committee.

Admiral TRULY. No. I would say that it was a single investigation conducted by the Commission. There were many parallel efforts as we chased down possibilities of failure as the weeks went on. There was plenty of technical controversy as we got more and more data. For example, the film that you just saw was not all developed in the first day or looked at. It took many, many weeks. But, nevertheless, those were all facets of one investigation that came to the answer as reported in the commission's report.

Mr. VALENTINE. Thank you.

Thank you, Mr. Chairman.

Mr. ROE. The Chair recognizes Mr. Lewis from Florida.

Mr. LEWIS. Thank you, Mr. Chairman.

Dr. Fletcher, I think you're going to have some very trying moments over the next few months, but I'm sure you'll be up to the challenge. I think it's excellent that we see those who go out on a razor's edge—Admiral Truly and Captain Crippen—in the positions that they're in.

I was reading U.S. News & World Report, and you probably saw it yourself, and talking about what you're going to be doing and that you're an interim director. I think anybody that takes over the administration of NASA is an interim director. They're not going to stay there forever.

But how are you going to be able to cut through the layers of bureaucracy and really get to the meat of some of the problems? What is your plan on doing that?

Dr. FLETCHER. Mr. Lewis, I didn't use the term "interim director." I think that was the newspaper's term. I plan to stay the remainder of the current administration.

Dealing with this problem is not a trivial matter. This is a very complicated piece of machinery. We have a very large team of people that are involved in putting NASA back together. It's not only the 20-some-odd-thousand NASA employees, but there are all the contractors that we work closely with. That's going to take

some weeks, months, and probably the full 18 months' delay that was caused by the accident to deal with it.

I know of no better way, Mr. Lewis, than to talk to the people at middle management levels, at top management levels and, to the extent that it is possible for an administrator, talk to the people who are at the working level. That, as you know, is difficult to do, but, nevertheless, somehow or other you've got to feel you know how the troops are feeling, because motivation is a key element in making this complicated piece of machinery work, and it's important that by the time we fly again the team is properly motivated.

Mr. LEWIS. Do you plan any shakeups in this point in time? Are you going to get a new broom and do some sweeping?

Dr. FLETCHER. Mr. Lewis, we'll do whatever is required to make the management team and the whole organization function better. When people need to be replaced, we will replace them. When we need to reorganize with different people or the same people, we will do that. It will happen not all at once, but we'll be observing it as time goes on and we'll keep you informed as we do it.

Mr. LEWIS. In the Rogers report it points out that you should have some sort of quality review and quality management, and I'm just wondering if you're looking to have a quality review and design review board with the head of that board that can get directly to you, as the report suggests, by either an Associate Administrator or what have you, and cuts through the lower levels of management, either arc them or go straight through or sit on the boards, someone, say, like Admiral Truly or Captain Crippen or someone that has been there and knows that something must be done, so they don't have a lack of application on quality tests and things of that nature or redesign and they can get to you.

Dr. FLETCHER. Mr. Lewis, that, of course, is going to be one of Admiral Truly's high priority items to look at all of the safety, reliability, and quality assurance aspects, and I'm sure he's going to have such groups reporting directly to him.

In addition, as you probably know, SR and QA, as we call it, reports directly to the Administrator. And we have such a group now. The important thing is that they're able to get the information from where it is necessary to come, and so the free access to that safety board will be possible.

In addition to that, as you know, we have a statutory safety review board which was set up after the Apollo fire in 1967, and that also reports to the Administrator. Both of those functions will have to be tightened up considerably from my point of view, but I imagine Admiral Truly will want to do the same for his part of the organization.

Mr. ROE. If I could ask you to suspend at this point, we'll return in about 15—10 minutes. We'll recess for 10 minutes.

[Recess taken.]

Mr. ROE. Today we'll reconvene.

When we recessed to go to vote, we were having a line of questioning being presented by the gentleman from Florida.

The gentleman from Florida, please?

Mr. LEWIS. Thank you, Mr. Chairman.

I would like to ask Admiral Truly a couple of questions about the role that Captain Crippen will play. You mentioned that he will

head the Shuttle Management Review Board for the various agencies or various groups. Is that what his title will be?

Admiral TRULY. I don't know what his title will be. I haven't figured that out yet, but specifically—

Mr. LEWIS. Well, will you clarify what his role is?

Admiral TRULY. Yes, sir.

There are two specific Commission recommendations. One is the second one which deals with shuttle management structure, and the second, which is No. 5, involves improved communications. Those are complicated issues that I'm going to have to decide what recommendation to make to Dr. Fletcher so that we can do two things: first of all, look at the total shuttle program management structure and revalidate that large portion of it that I'm sure will be revalidated, but change and streamline a portion, if necessary. I need someone to help me pull that together, and it is specifically that that I'm going to ask Captain Crippen and whoever he needs to help him to pull together the options and look at it and see where the system could be made better.

Mr. LEWIS. I see. Do you have any idea at this point who will be working with him?

Admiral TRULY. We have not selected individuals. But I would rather have a small group of maybe three to five people that would be the core group, so that they wouldn't be a large committee. However, they will have full access not only to all the management within the shuttle system and our centers, but also people outside the agency.

Mr. LEWIS. I see. Will there be people from Marshall? Will Marshall have representation on this team?

Admiral TRULY. We just haven't selected the individuals that will help Captain Crippen do this task. However, the Marshall management team will certainly be a part of the review as he goes around and takes a look at what we have now and where we ought to go.

Mr. LEWIS. How will Crip's activities interface with what General Phillips' activities are?

Dr. FLETCHER. Well, General Phillips is going to look at the overall NASA agency, and it's anticipated that when the time comes and Crip's task force is put together, they will interact frequently. But, of course, it's more important that we get on with the shuttle management and communications aspect. That's why the first task is what Admiral Truly described—get on with the shuttle communications and management. We haven't quite got to that point in General Phillips' review.

Mr. LEWIS. I see. One final inquiry for Dr. Graham: Dr. Graham, you partially answered this this morning, and I'm interested. Now that you have been associated with NASA and you're going over to the Office of Science and Technology as the President's advisor, how do you visualize your role now and working in intra-activities with NASA, with Dr. Fletcher and Admiral Truly in getting this program moving and back up in the air—space?

Dr. GRAHAM. Mr. Lewis, I have not yet focused on the specific actions that I would undertake if I'm confirmed to that job. However, there has been a strong working relationship between the Office of Science and Technology Policy and the Science Advisor to the

President in the recent past while I've been at NASA. I would like to continue that close working relationship and strengthen it, certainly in the scientific and the technology area where it's historically been. But also try to maintain a close cooperation with NASA in the area of the larger U.S. Space Program to return to space-flight and moving forward with NASA generally.

Mr. LEWIS. Thank you, Doctor and gentlemen.

Thank you, Mr. Chairman.

Mr. ROE. OK. The Chair recognizes the distinguished gentleman from California, Mr. Mineta.

Mr. MINETA. Thank you very much, Mr. Chairman.

And welcome, Dr. Fletcher.

Dr. Fletcher I wonder if you could maybe put me at ease a little bit. You've been quoted as saying if the U.S. Space Program is in turmoil, most of the chaos is external to NASA, and here we are in a position of having to sort of look at ourselves as Congress, inward at NASA, and wondering whether we have the ability to reform ourselves, and I'm just wondering whether or not I'm maybe unduly alarmed in terms of taking a statement, and am I taking it out of context or am I saying—when you say that most of your chaos is external to NASA, I'm just wondering whether or not I'm being unduly alarmed about your statement.

Dr. FLETCHER. Mr. Mineta, I don't remember having made that statement, but it's probably true that, if it were made, it was made before I was nominated for the job.

Mr. MINETA. This was in last week's Newsweek.

Dr. FLETCHER. Oh, then, I don't remember making that, but let me go on and say that there is not chaos within NASA. There's some uncertainty, as you might expect there to be. We are undergoing management reviews and probably management changes. People are uncertain as to when we'll be able to fly safely again. People are uncertain about when their missions as scientists, for example, will fly again. So I would say rather than chaos within NASA, it's uncertainty, and there is some evidence that we need to reassert our goals within NASA, and we are in the process of doing that.

Mr. MINETA. You're not saying, then, that NASA's OK but the chaos is external to NASA?

Dr. FLETCHER. I don't remember saying chaos, but I can't really speak for the outside world, Mr. Mineta.

Mr. MINETA. The office of—is it Safety, Reliability, and Quality Assurance that's now being talked about to be created within NASA? I believe that's been recommended by the Commission.

I'm just wondering whether you've had an opportunity to take a look at this, as to whether or not this might be—this recommendation is going to be accepted.

And I chair the Aviation Subcommittee for the Public Works and Transportation Committee. The FAA, for example, has an office for airline safety and creates standards for airline safety, but it doesn't try to fly the airplanes or adhere to schedules or make money. And I'm wondering if this internal office is going to be insulated from the kind of, I guess—or the relationships that that would have, that office would have with other parts of NASA to be able to be really an office of Safety, Reliability, and Quality Assurance.

Dr. FLETCHER. Mr. Mineta, that's an extremely important function in NASA. The Safety, Reliability, and Quality Assurance Program is currently under the chief engineer, and reporting to him are the Safety, Reliability, and Quality Assurance directors of each of the centers. We think that whole process needs reviewing. It's important how well it's done and to make sure that communication channels are good and that people at both the receiving and sending end of those communication channels are competent, and it's competence and good judgment that counts in reliability and quality assurance. And we will certainly take a look at that whole program both NASA-wide and also within the space shuttle program, and that will truly, undoubtedly start our enthusiasm already.

Mr. MINETA. Among other findings of the Commission, they stated very explicitly that the Thiokol management had reversed its position and recommended the launch of 51-L at the urging of Marshall and contrary to the views of engineers in order to accommodate a major customer. Elsewhere the Commission talked about the sluggishness on the part of Thiokol in addressing the O-ring problems, notwithstanding memos from engineers and even from NASA itself on other occasions. And it's only in the aftermath of the accident that we're getting the sense that Thiokol is devoting total commitment to this redesign and only now are projecting the can-do attitude about fixing the SRB's.

I'm wondering, is it possible that we have a morale responsibility maybe to look elsewhere for the redesign and the resupply of the SRB's given Thiokol's interest in making the SRB's, and I'd say to the extent of even making money over safety, given some of their actions since the accident that I would even call unrepentant attitude, and so—and also because of what they've done to their two dissenting engineers who testified before the Rogers Commission.

And I'm just wondering whether or not we should be looking elsewhere for the redesign supply of SRV's.

Dr. FLETCHER. Mr. Mineta, you probably know we have asked the National Academies of Science, a body called the National Research Council, to form a very high-powered task force to not only review the various ideas or suggestions for design, for improvement of the seals, but also to certify that the tests on whatever designs we come up with are adequate and they're going to follow these tests as we proceed over the ensuing months.

By the way, I should say that, in addition to Thiokol, we have people at Marshall, from the Johnson Space Center, and probably other places that Mr. Aldrich and Admiral Truly will want to mention, all involved in that redesign effort. So it's not just Thiokol that's involved. I guess the expertise of the entire Nation is involved in that redesign.

Mr. ROE. Will the gentleman from California yield?

Mr. MINETA. Of course.

Mr. ROE. As we have been unfolding our hearing process, without too much reiteration, we spent yesterday analyzing and digesting the response from the Commission, and then we've invited you folks to come in today to bring us up to date as to what your plans are, where you're at, and then specific questions that are being asked by different members. But obviously there's certain areas where the committee has concentrated on in their observations,

such as the safety area, the assurance area, the critical items list, and so forth and so on.

I think that the key is safety, as was brought out by so many members—and now I believe that Mr. Mineta is striking at a very important point that has to be aired, in my judgment, and I'm sure the rest of the members, publicly. And I think it's important for me to interject at this point what our plan is after we review with you tomorrow and bring us all up to date on the technical task force working.

Starting next Tuesday, our plan is to start to bring in outside witnesses; namely, the manufacturers. And I think it's a fair comment to say at this point the first one we plan on calling on Tuesday is Thiokol. Now Thiokol centers upon the whole O-ring issue and the whole joint issue, I should say. But as the gentleman from California is developing, whether we agree or not and without trying to pin blame, because that's not what the Commission did nor is it what the committee intends to do, certainly not at this point, it seems to me that the response from Thiokol, their observations, what happened on the way to the forum, so to speak, and what they've been directed to do as of now, is an extremely important, vital point of the whole issue that we're speaking to, not only from the accident point of view, but down the road—where do we go from here; what is our next step?

But that also intimately relates to the Marshall Center, as I understand it, because they're the ones who are the overseers, so to speak, and working on that issue. Now I think what may be very, very profitable would be—there's an old saying that's written that I have on my wall in my office, and it says that more mistakes are made from lack of facts than from poor judgment. More mistakes are made from lack of facts than from poor judgment.

I think it would be to the advantage of the committee, which we'll take up amongst ourselves a little later on, to consider bringing in the Marshall Space key people, technical people I'm talking, engineering people, at the time that we are interfacing with the Thiokol Co. I think that might be extremely profitable, so that we can get this matter up on the deck, No. 1, upfront, and deal with it; first of all, to dispel any lack of facts, bring the facts forward as they are—if the gentleman would yield further from California—

Mr. MINETA. Absolutely.

Mr. ROE [continuing]. Which is the process I believe you're following, so that there can be a response in both directions on that issue, rather than a time lag and all kinds of conjecture or false concerns, or whatever, emerge. Does that sound reasonable?

Dr. FLETCHER. It sounds quite reasonable, Mr. Chairman.

Mr. ROE. Yes; well, then, I just wanted to make that point, if the gentleman will yield further. So that is the direction I would choose to go next Tuesday so that you can develop in more depth your whole line of questioning.

I thank the gentleman for yielding.

Mr. MINETA. Mr. Chairman, if I might, I'd like to ask a little more about the relationship between contractors and NASA. One question I have in this regard is this: Is there a standard operating procedure pertaining to the launch readiness procedures that was

woefully ignored in the case of 51-L and perhaps many times before?

In the case of the SRB's, Thiokol was talking to level III people in NASA. On the other hand, it appears that Rockwell was talking directly to level II people. Moreover, Thiokol was asked for a written affirmation of their consent to fly; Rockwell was asked for no such assurance. And it's unclear to me if anyone spoke to the external tank contractors about the ice situation or, if so, what was the procedure at the time.

And I guess what I'm asking is, Are there procedures which need to be established or perhaps have to be newly adhered to in order to make this process less erratic and, frankly, more importantly, more reliable?

Dr. FLETCHER. Mr. Mineta, I'd like to start to answer that question because it pertains to what we're really not doing very intensively, and then I'd like to ask Admiral Truly and his associates to respond to the specific point.

Obviously we've got to tighten up our procedures and, when we say communications, we mean communications and procedures. Communications have to fit procedures, and vice versa. You can't communicate one way and your procedures say something different. That has to be tightened up all up and down the line, from the lowest level to the highest level.

Having said that, I think Admiral Truly will have to answer, but we really have just started that process, and that's one of the reasons that Captain Crippen is here today.

Dick, do you want to—

Admiral TRULY. The review that you have suggested and Dr. Fletcher referred to is the very reason that when I wrote into my strategy for returning to safe flight under what we're going to do in a program management context, I specifically wrote in there that we were going to review a number of things and put in the words "including the launch commit process."

Certainly, looking to the future, we're going to have one system, which I frankly think that we do now, and I'm going to ask Mr. Aldrich in a moment to describe it, although he was not a part of the task force that did the investigation, but he at least I think can describe that process very clearly.

But I can assure you that for the future that we're going to have one procedure used by everybody and known to all.

If I might ask Mr. Aldrich to comment about what the process and what the requirements are today, I would like to do that.

Mr. ALDRICH. Mr. Mineta, we spoke earlier about some of the formality in this area in our review that we would add, including recording and including a more formal list of people for each type of meeting.

The process, as it has worked up to now, however, is documented and is fairly clearly laid out in terms of responsibility. The flight readiness review process starts within the contractor, which could be called level IV. It's the contractor for each element of hardware who does its own internal review of flight readiness and then reports to a similar flight readiness review at level III, which is the individual center project elements.

A level II review commences following that at the program level where each of the projects reports their readiness, and it's finally culminated in a review to Admiral Truly, the Associate Administrator for Space Flight, in a level I flight readiness review, and at that time there are formal, documented signoffs by both the NASA project elements involved and the contractors with regard to readiness, including any constraints or ongoing work in addition to the detailed presentations to describe their readiness. That's about 2 weeks before launch.

And then either 1 or 2 days prior to launch there is a final meeting to tie off any loose ends or to look at any new developments that have occurred. That's normally called the launch minus 1-day meeting, but it might on some occasions be launch minus 2 days.

There, again, there's a formal presentation by each of the projects to the combined levels II and I management, and at the end of each of those presentations there is again a signoff that says the contractor and the project element is ready.

Downstream of that review there is then an operation put in place as the actual countdown proceeds where issues are brought forward to unscheduled but planned-for and documented procedures which constitute an organization called a mission management team with formal membership. Those meetings are the ones which are characterized in our earlier discussions as perhaps not having the formality that we would like to see in the future. Although they are formal meetings, they are not recorded and there are not usually additional signoffs involved. Specific issues that come up, as they are required to be treated, are treated as close to real time as is possible by that group.

And each of the discussions you mentioned with the two contractors were treated in these mission management kinds of sessions, although the one with Thiokol was at a meeting at level III and was not really involved with the total team as I've described it here.

Mr. MINETA. Mr. Chairman, if I might ask very quickly—

Mr. ROE. The gentleman from California?

Mr. MINETA. It appears that the information flows upward in flight readiness reports, as you've mentioned, as those are abbreviated because of the closeness of launch time, but is there a mechanism between launches where past readiness reports or past problems are reviewed in order to demand accountability for efforts to fix recurring problems or to explain repeated waivers?

I get the impression that information only percolates upward at the will of middle management people without corresponding accountability operating in reverse.

Mr. ALDRICH. Could I answer that one also?

Dr. FLETCHER. I think Mr. Aldrich should answer that. On the other hand, Mr. Mineta, I want to remind everyone that information has to flow both ways. Communications is a two-way system.

Mr. MINETA. That's my point.

Dr. FLETCHER. The procedures are written in one way, but this is a collegial, if you like the system that we work in. Unless all members of the team at levels I, II, III, and IV respect each other and communicate well with each other, this system won't work well.

Now having said that as a broad generalization, I'll turn to Mr. Aldrich for the specifics.

Mr. ALDRICH. The specific answer to problems that occur in tracking from flight to flight, we have a formal and, again, a documented structure for the process which logs every flight pre- and post-flight anomaly which occurs with each of the elements. It tracks that element or that problem to a resolution by the project element. It is then signed off at that level and brought forward to level II again for signoff. And for each flight, those that are not closed from the past flight are reviewed and specifically identified.

So, again, the intent is strong that we, in fact, do have a process of the kind that you brought up, and we will certainly be attempting to strengthen that as we go forward also.

Mr. ROE. Will the gentleman yield again?

Mr. MINETA. Of course.

Mr. ROE. You, know, again, I don't like to monopolize other members' time, but one of the key issues that is gnawing at many, many people in the process is, How could it possibly be that the information did not get up to the higher levels? Therefore, somebody had to make a decision in between. They didn't either consider it important or they felt that they had the authority at that level to make that definitive decision. It's just extraordinary that the top of the heap didn't know. And that's what gnawing at us.

And I think what the distinguished gentleman from California is developing is not only a two-way street back and forth, but should there not be a mechanism in management that demands a two-way street where management at top is also asking, or is management waiting for memoranda to come up through the lines to be checked off, and so forth. I don't mean to simplify it.

And I think that if you could give us—if the gentleman would yield further—just a little bit of your overview there—we're really coming back and saying there's got to be some methodology that devised in management where management can handle particularly that kind of a issue. Is that reasonable?

Dr. FLETCHER. Mr. Roe, if I may interject, Admiral Truly, at least as long as he's Associate Administrator for the Space Transportation, is not a shy person, and he is going to ask questions all up and down the line both before the launch and also in between launches.

Mr. ROE. But that's now, you see, and we're glad that Admiral Truly is with us because we have a shoulder to rest on. I'm looking as to what happened before Admiral Truly got here.

Dr. FLETCHER. Yes. I just wanted to assure you that in the future you will have two-way communication, and I and Admiral Truly will see to that.

Mr. ROE. But someplace along the line there's got to be review. As you know, we're going to be looking into that to see what progress we're making.

The gentleman from California.

Mr. ANDREWS. Would the gentleman yield?

Mr. MINETA. I'd be pleased to yield.

Mr. ANDREWS. I'd just like to follow up, Dr. Fletcher.

I think what concerns us, all of us, is that we've seen this report and it apparently—the finding and conclusions of the report is

simply that information seemed to flow freely down from the top from levels I and II, but in rare circumstances did it flow the other direction. And I think all of us would like to get a sense of your view of that conclusion. What specifically do you think was wrong with the decisionmaking? Is that a conclusion that you agree with?

Dr. FLETCHER. I have not participated in this back and forth with the Commission. I've read the report.

Mr. ANDREWS. But what is your view of the report?

Dr. FLETCHER. It is quite apparent after reading the report that there was some failure in communications somewhere along the line. Just where it was and how it fit procedures, and so forth, I'll have to leave to the people that were involved at the time, but—

Mr. ANDREWS. You do not have an opinion as to where that breakdown took place after reading the Commission report?

Dr. FLETCHER. I would like to reserve that opinion until I've learned more about it. This is my fifth week on the job and I have talked to the people on the Commission, and I've talked to our own people. I haven't visited the Marshall Spaceflight Center.

Mr. ANDREWS. Do you agree with their conclusions?

Dr. FLETCHER. Yes, I agree with their conclusions.

Mr. MINETA. Thank you, Mr. Chairman.

Mr. ROE. The Chair recognizes the distinguished gentleman from Wisconsin, Mr. Sensenbrenner.

Mr. SENSENBRENNER. Thank you very much, Mr. Chairman.

I am particularly concerned that NASA has not been insistent that contractors comply with the specs in the construction of various items in the shuttle, specifically the solid booster rockets.

We've seen some information that there was specs relating to ambient temperature that have been completely ignored by Thiokol, and also the gentleman from Florida, Mr. Nelson, came up with information that Thiokol claimed to have tested the solid booster rocket at 21 degrees when in fact that was not the case.

What do you intend to do to insure that the specs are complied with in the future?

Dr. FLETCHER. I think I'd like to turn to Admiral Truly in a moment. I only became aware of that statement today.

The first thing we need to do is take the statement in the context in which it was given, and then we need to respond in some depth because that's a serious allegation.

Mr. SENSENBRENNER. Before Admiral Truly responds, the Armed Services Committee has been frustrated repeatedly about the DOD not requiring defense contractors to comply with specs, and it ended up that they got so frustrated that the DOD authorization law was amended to allow for outside testing of new weapon systems that were delivered to the Defense Department. I think that unless this committee gets some assurance that NASA is going to require that the specs be complied with, we ought to consider legislation similarly to take the spec compliance from you and have someone from the outside make sure that the contractors are delivering what they're supposed to be delivering.

Dr. FLETCHER. Mr. Sensenbrenner, we are going to see that the contractors comply with the specs. I think that the specific instance that you mentioned we really have to research further, and I don't know to what extent Admiral Truly's people have looked at

that particular item, but we insist on strict compliance with the specs with our contractors.

Mr. SENSENBRENNER. Well, obviously something big fell through the cracks as far as the solid booster rockets are concerned, and I hope that doesn't happen again.

So, Admiral, why don't you tell us how it won't happen again?

Admiral TRULY. Well, I can only echo what Dr. Fletcher said. I can assure you as part of our review of every critical item on the shuttle program, we are looking at design requirements, the testing history, the flight history of that particular article, and it is absolutely necessary that when we have a program requirement that an item is tested to a certain temperature or to a certain condition, and certified that way, that that in fact is the case and we will undertake whatever effort that we have to assure that.

Mr. SENSENBRENNER. Does that mean telling the contractor that, "You didn't comply with specs and go over and do it again at your own expense."?

Admiral TRULY. Sure. I mean, whatever it takes. Let me also say that I'm not personally familiar with this particular point that was apparently developed by the Commission's investigation. I'm going to get familiar with it as quickly as I can. Until I do, I would have to say that you have not heard all the evidence from the Marshall Space Flight Center which ran that level III or from the contractor. We certainly deserve to hear that, and we will get there. But for the future, I can assure you that we will have launch commit criteria that we know that the certification is proper.

Mr. ROE. Will the gentleman yield?

Mr. SENSENBRENNER. I yield to the gentleman from New Jersey.

Mr. ROE. As the afternoon progresses after morning, people appear to become a little tired, a little testy, and neither is the case here.

What the committee is interested in developing is the earlier discussion—if the gentleman would yield—that manifested our concern with the critical items, the 1 items and the 1R items. And in our course of discussion this morning we made the point of view that—and Admiral Truly did very well on that, and so did Dr. Fletcher—that there's just no question about rehashing. We're going to see that those particular elements are thoroughly reviewed from top to bottom. We have—you've already vitiated and negated all of the waiver system, and so forth. I applaud. I think that's fine.

One of the questions we came back and said, however, that developed from other folks was we were concerned—I believe it was Mrs. Schneider from Rhode Island—made the point of view that it appeared that there was a substantial reduction in the number of quality control people, at least numerical bodies. That doesn't necessarily mean that that's denigrated or reduced the quality control. There may be parts that you don't need anymore. We respect and understand that. But it was rather a substantial drop.

Now the gentleman from Wisconsin is developing the point of view—it's an extremely important point of view which I think you ought to use the advantage to expand upon technically. I'm going to ignore that.

Mr. SENSENBRENNER. Thank you.

Mr. ROE. That's all right.

Now the point then goes to the point of view that if contractors—and we don't know how widespread this is—if contractors are not meeting their requirements that are under their contract that they agreed to, then obviously they are—I don't want to say defrauding the Federal Government, but they are if they're not producing goods. If I'm asking for a bone, I don't want a dog. I mean, that's what I'm paying for and that's what I expect them to deliver to me, and I don't mean to be facetious, which leads to this point—if the gentleman would yield further:

How widespread is that? If I'm going to come back and I'm going to inspect a critical part 1 and I'm going to say we're going to review that whole thing, query, if I find any fallacies in the—not the design—in the manufacturing, did that manufacturer meet the requirements that initially were put on that product or that part or piece—to meet the requirements that NASA required.

Now you ought to come back and say to us the following, if I may. You ought to get into the discussion we're moving in that direction. We're not sure how far that went. But, however, if we're constantly called upon to provide upgraded and improved parts to get from critical 1 to critical R1, or whatever the case may be, or get the very best part we can, we're changing the terms and conditions and the specifications. Is that reasonable to say?

If I have piece A that is not totally A No. 1 and we found that we shave that a little bit or put a little more candor in it, it's going to be a better piece, then you have to issue a new specification—is that not correct—for somebody to make that part? Do you understand where I'm coming from?

Dr. FLETCHER. Mr. Chairman, I think I understand what you're saying. And, of course, that's the whole purpose of the reliability and quality assurance [R&QA] organization, that we have, which consists of not only our own R&QA, but we have contract monitors and DCAS is done sometimes. That's a Defense Department organization. But whatever is the case, it's absolutely necessary not only that contractors comply with the specifications, but that we know that they comply with the specifications.

In addition to that, your second point is, if we change the specs to tighten it up or to loosen it, as the case may be, we have to make absolutely sure that that contractor complies with that changed spec. That's part of the R&QA—

Mr. ROE. But come Tuesday morning we're going to go beyond the Government's—Commission's and the Government's representatives of NASA, including this committee, and we're going to be calling in the private sector. The private sector has already been convicted in the press. They've already been convicted in the press. Who was the bad guy?

Now it's essential for us to be able to assure the credibility of the future of the space program, but where all of the facts are involved, they must be on the table. And what we're—and I'm not admonishing you or being pedantic, and I think that the question of the gentleman, the line of the questioning of the gentleman, is very important.

Thiokol is the bad guy. That's what's out in front on the deck right now. They have a right to defend themselves in the heart of

public opinion and what the facts are—is the reason we want the Marshall people in here, too, at the same time.

Now the evil that's floating here is—and yours, because of a document to that particular company, that they did not meet the plans and specifications that they were chartered to do and paid to do. That is what is before us, which is what people have been alluding to.

Now the gentleman from Wisconsin comes back and he expands on that because, if there is one area that the specs haven't been met, clearly have the specs been met in all the areas? And then the question is—it's not that we're going to do better. What specifically are we going to do to deal with that, because if the specifications aren't being met, and that's the finest bit of engineering on the part is made from the engineering, and those specs aren't being made, we have immediately denigrated the safety factors involved.

So what—if the gentleman will forgive me further—what the gentleman is simply saying is someplace—I hope by tomorrow or when we continue on—that we will be able to ferret out that process. And is there anything we're planning on doing to determine how wide a range this idea of not meeting specifications has gone? Is it in every area? Is it just in that area? It leaves a doubt—is where I'm trying to come from.

Dr. FLETCHER. I think you're right, Mr. Chairman. The first thing we have to do is ascertain the extent of the specific error that was made. Of course, as you properly point out, we need to look at the whole system to make sure that there aren't a lot of errors, if that was one, similar to that one.

Mr. ROE. The gentleman from Wisconsin?

Admiral TRULY. Mr. Chairman, Mr. Aldrich would like to make a comment, if he might, at this point.

Mr. ROE. Yes; of course.

Mr. ALDRICH. In that specific regard, one of the actions for returning to spaceflight that Admiral Truly had in his direction to the program and which we have acted on is a complete review of design certification for each element of the space shuttle program. That is in process now at each of the contractors and each of the project elements at the NASA centers, and it is a detailed review of every element, what the requirements are and how those requirements were verified to be met, either by test or analysis, whichever was appropriate.

In addition, we're also reviewing the environments that the shuttle must fly through and be exposed to, as they are the basis for establishing the design requirements for the hardware. So a parallel activity also in process is revalidating and reaffirming the induced environments and then the process at each element, contractor and NASA, to verify that the design certification is in fact still valid, based not only on any changes that might have occurred, but, as Admiral Truly pointed out, we now have a number of flights of experience in the performance of the specific hardware, and factoring that into the analysis as well.

I think this is an important piece of the total amount of work we're doing, and it's complementary to the critical items list review which I discussed earlier.

Mr. BOEHLERT. Will the gentleman yield?

Mr. SENSENBRENNER. May I reclaim my time? I have one more line of questioning I would like to pursue.

Mr. ROE. The gentleman from Wisconsin has the time.

Mr. SENSENBRENNER. Apparently the Rogers Commission is not all that trusting of NASA, at least insofar as the redesign of the solid rocket motor to make sure that the specs are complied with and that the safety factors are adhered to, because on the bottom of page 198 of the Commission report it does specifically suggest and recommend independent oversight in terms of the design recommendations and the effort that the Commission has suggested in terms of the SRM's.

Does NASA intend to have independent oversight as the Commission has suggested?

Dr. FLETCHER. Mr. Sensenbrenner, we have set up a team appointed by the National Academy of Science and Engineering, which we call the National Research Council, headed by Dr. Guy Stever, one of the officers of that organization, and they have been busily involved in helping with the redesign of that seal, I would say, for the last 3 weeks. We've got advanced warning of that particular recommendation and have implemented it.

Mr. SENSENBRENNER. I don't think that that's what the Commission had in mind—that the National Research Council would be in on the redesign, because, you know, that makes them part of the team. I think what the Commission had in mind from reading the paragraph that's in the report was that after the redesign took place that the independent oversight made sure that the Commission's recommendations were adhered to. And while I was not able to be here this morning because the Judiciary Committee was marking up the immigration bill, the report that I got of this morning's hearing was that you all were less than precise in terms of saying which part of the Commission's recommendations you would adhere to. And I'm just very concerned that at least this part of the Commission's recommendations be adhered to and that somebody from the outside look at the redesign of that solid booster rocket motor so that we won't have another cozy arrangement that apparently led to the disaster.

Dr. FLETCHER. That particular recommendation—there's no question about it. We accept it and we are implementing it.

Mr. SENSENBRENNER. OK. Thank you very much.

I'll yield to the gentleman from New York, if he wishes to—

Mr. BOEHLERT. Yes.

Mr. Aldrich, you said you're reassessing to make certain that the design specs are valid. What I want to know is, who makes certain that the design specs are met? Is it the reliability and quality assurance people?

Mr. ALDRICH. I'm sorry, I meant to specifically indicate not only that the specs were valid, but also that the design of the hardware and the testing and analysis of that hardware assures compliance in an engineering sense. That's done by the full engineering elements available to each of the projects, both NASA and Government, not only the R&QA organizations in each organization, but also their primary design engineer organization and their project management as well.

Mr. BOEHLERT. Fine. Thank you.

Mr. ROE. The Chair recognizes the gentlelady from Tennessee, Mrs. Lloyd.

Mrs. LLOYD. Thank you very much, Mr. Chairman.

Dr. Fletcher, it certainly is a privilege to meet you, to be able to welcome you back. I feel like I'm a real oldtimer that we're here together after all these years; and also to see your colleagues here with you. We appreciate your time and the attention that you're giving this matter.

I'm really playing hopscotch back and forth. I'm attending hearings across the hall on some of the problems that the TVA has. In this hearing we're trying to assess the tragedy and across the hall we're trying to prevent a tragedy. But in the two hearings it seems to me that there are so many parallels, that there are so many matters that were not brought to the top managerial level. There was a lack of communication. There was a lack of focus on really design perfection.

And one of the statements that really brought home to me in one of the—in testimony from across the hall—"Management's overriding concern for cost and schedule has led to the faulty design and construction of TVA's nuclear power plants."

Well, this is bad, but to me what is even worse is that I really think that safety in itself is superficial. I think that we're talking about something that's so much broader than safety. I think that safety is something that happens. I think what we're talking about is quality workmanship and management, and a level or performance in this agency.

Now it seemed to me that the NASA of the seventies was really known for its excellence and that this high degree of safety was something—it was part of the picture. It was something that happened, whether the agency is designing or engineering manned or unmanned systems. And wouldn't you agree that if we put the proper picture in, if we put the proper perspective in and demand the quality and excellence, that safety will be the byproduct?

Dr. FLETCHER. Well, I think that safety, of course, is the primary concern, but the things that you mentioned, Mrs. Lloyd, are absolutely essential to safety. You've got to not only have high quality and high reliability on all the parts, but you've got to have confident judgment on all these things with people involved, and there has to be good communications, as was mentioned earlier, between the people. So if there is a question about some item, everyone is free to raise the question with his associate or compatriot and resolve the issue. That's all part of what we mean by safety. But certainly reliability and quality of design is an essential part of safety, yes.

Mrs. LLOYD. It seems to me there is a blatant disregard for communication between your levels. But another thing that really disturbs me is the distinction that we've heard yesterday and today between technical people and the management people.

Now what really happened—I don't really to delay this, Dr. Fletcher, but what happened to the technical manager in aerospace that made these decisions? We had people that had the sufficient data to act upon. We had people like George Lowe and Werner VonBraun, Abe Silverstein. Why don't we have people like that today that are technical managers?

Dr. FLETCHER. Mrs. Lloyd, it's interesting that you should raise those names. Of course, Werner VonBraun is gone and George Low is gone, but we did have Gen. Sam Phillips and Dr. Eberhart Reiss and Brainerd Holmes and Abe Silverstein, some of the old-time veterans, we call them—they didn't like to be called "old-timers"—

Mrs. LLOYD. They were technical managers.

Dr. FLETCHER [continuing]. In about 2 weeks ago and had an interchange with the current people. And I think that the main difference, if I might summarize what we came up with, is that there was a collegiality in that group which has to be redeveloped among our own people and is in the process of being so. They had no questions about the competence of our people. Those, of course, were giants because they were the people who put us on the moon and brought our astronauts back safely, but we have giants, potential giants, in NASA now. We have to make them work together properly as a team.

Mrs. LLOYD. I referred to NASA as a wounded eagle yesterday. I really think that if we are going to fly again we're going to have to make the demand for excellence and the quest for excellence uppermost in the NASA program, and we want to be a part of that, that we will not settle for less.

And this committee and the oversight functions as well as, I'm sure, you and Admiral Truly and Captain Crippen share my goals.

Yesterday we also learned that hindsight is a lot easier than oversight, but I would like to review the comparison between the Apollo 204 fire and the accident. It seems to me that the flaws are so much broader now than they were 20 years ago and that certainly our resources are more limited than they were 20 years ago.

And it seems like that we're going to have to make some policy issues where we're going to go in our program, such as we decided to go ahead with the Apollo program. Where do you think that we are going? What is—what do you think is going to be our main goal?

Dr. FLETCHER. Well, Mrs. Lloyd, that's a broad question, but let me give you some broad—

Mrs. LLOYD. I realize it is.

Dr. FLETCHER [continuing]. Answers—

Mrs. LLOYD. It allows for your perspective.

Dr. FLETCHER [continuing]. The best I can.

Our first and foremost goal is to return the space shuttle to safe flight as soon as we feel it is safe to fly. We will carry the missions that have been assigned to us to carry. Admiral Truly and his colleagues are going over the proposed manifest very carefully.

Following that, then we plan to launch the payloads that we talked so much to you about over the years, the crucial scientific payloads—for example, the Hubble Space Telescope and the various Centaur missions: Galileo, Ulysses, Magellan, and so forth, and the Spacelab. So following return to flight, we'll pursue those programs.

The little longer term goal—you also are aware of—is to get to the space station. We need to have an adequate transportation system, both to carry men and equipment back and forth to that space station, and also to assemble the space station. So we have to have a reliable space transportation system to do that.

Beyond that, we make studies. We have no commitments. We have some guidelines that have come to us from the Tom Paine Commission. He proposes several alternatives—an advanced transportation system to replace the shuttle, for example, is one. A national aerospace plane is another possible direction to go, which is already in the process of being implemented.

And, finally, we can't forget that our long-range mission is to move out into space with men and women and equipment and do useful things, and that includes the Moon and Mars and places like that. That may have to wait until the turn of the century, or at least until there is a change in the budgetary environment.

Mrs. LLOYD. Thank you very much.

Thank you, Mr. Chairman.

Mr. ROE. I thank the gentlelady.

The gentleman from California, Mr. Packard?

Mr. PACKARD. Thank you, Mr. Chairman.

Welcome back to NASA, Dr. Fletcher, the fiery furnace at the present time anyway.

I'd like to follow the same common thread of questioning this afternoon. I'm still not satisfied that we have all of the commitments that I would be looking for.

The Commission found that the joint testing and the certification process was inadequate. What is your understanding of what the Commission means by those inadequacies?

Dr. FLETCHER. Well, I would have to refer to Admiral Truly and his colleagues, if you don't mind, Mr. Packard.

Mr. PACKARD. Please.

Admiral TRULY. Let me give you my view, and I would suggest that that would be a good question tomorrow for the head of the accident team.

I think what the Commission was saying is that, if we had had prior to the first flight of the shuttle the experience of the—about a thousand tests that we have done since January 28 on the joint performance of the solid rocket motor, we would have not have flown that design. We'd know far more about it, and we can credit that to hindsight if we want to, but the commission concluded, and so did the task force, and so did I think the technical people, both at Thiokol and Marshall, that we did not understand the performance of that joint. I think that's what the commission meant.

Mr. PACKARD. And I do not wish to dwell on hindsight, either, but I certainly want to profit in where we go from here in developing that process so that there are not those inadequacies in our redesign of this joint plus the looking at other inadequacies in the system that have already been identified.

I think what distresses me and disturbs me the most is that we do not have in these areas, some of which are very critical areas—we have ongoing rethinking and redesigning of those areas, but we do not have a good flow of those redesign factors into the system, the launching system.

A good illustration is the brakes, which we know that there are flaws there. We've had problems. It's almost like the joints. They have manifested themselves in mission after mission, and yet we have not moved in to a new design to correct that problem. And I'm not suggesting that we stop all flights until we correct that

problem. Sometimes—it certainly would have been beneficial to have done that with this—with the joints. But that's not, I suppose, what we would expect.

But there ought to be a time when the new design is moved into the system over a period of a long-term picture without having to delay flights. And yet we still see that we have brake problems, we have tire problems, we have steering problems, we have main engine motor problems or main motor problems. And I'm not persuaded that we are making the kind of progress on these other weak areas to the point where we won't end up with another accident caused not by an improved design on the joint, but on a weakness in the main motor or some other problem.

I was at the landing where those three tires blew, and that was alarming. And I think it is critical and could cost life and equipment.

I guess my question is, are we going to see the redesign of these other areas that we know are weak moved into the system without delay and at the same time without rescheduling the launches?

Dr. FLETCHER. Well, Mr. Packard, Admiral Truly and his colleagues can give you a better answer, but let me just say very quickly that, since we are down because of the seals in the solid rocket booster, we are taking a look at all of those items, particularly the ones you mentioned, but a longer list of items.

Mr. PACKARD. And some may come up with Mr. Aldridge's point that he made—

Dr. FLETCHER. They may very well.

Mr. PACKARD [continuing]. To review all of your specs.

Dr. FLETCHER. And so I think that at least is being addressed. The first part of your question—suppose there are new things that come up during future flights; isn't there a way to phase those new redesigns into the space shuttle transportation system, so that we can fix it as we go along? And I think that will be part of our plan in the future.

I don't want to speak for Admiral Truly, but that's my opinion.

Admiral TRULY. Well, I was going to request the opportunity—as an example, on the brakes, to ask Mr. Aldrich to say a word, because I view the brake problem as an entirely different sort of a thing than what caused this accident.

It is true that we have had brake problems over the years. As I matter of fact, I flew the second flight of the *Enterprise* on approach and landing test in 1977, and that was the first indication—it was the second flight of the shuttle and it was the first indication of a problem with brakes.

However, from the time that that happened until today, the program has worked the brakes very hard. We have moved out and had planned to move out prior to this accident on a redesigned brake that will be accomplished during this period. And we need to do that.

But there is a big difference in working difficult, complicated, and contentious technical problems on top of the table, and having a problem where a breakdown in communications doesn't elevate the severity of it so that we do work as a system. We will never make spaceflight totally risk free.

Mr. PACKARD. I know.

Admiral TRULY. It can't be done or we just ought to quit and not try.

But those other concerns in the Commission's report—and in no way do I want to say that I don't go along with those concerns, because I do, but those are concerns that have been worked in a different manner, I think, than this solid rocket motor joint. And, to me, that's a big difference.

Mr. PACKARD. One very quick question, if I may, Mr. Chairman, that I hope will just require a short answer.

At no place in your report or in our discussion have you indicated that you would report and brief this committee or parts of this committee on redesign submissions and considerations of the joint. I presume that we would become a very important part of that review before there was any money, although obviously we would not allocate funds for those redesigns until we were satisfied that they would meet the requirements.

True, the National Research Council and a variety of other in-house organizations will look at them. I've not seen any commitment that they would come back to us before they were approved.

Dr. FLETCHER. Mr. Packard, that is our intention—to bring before this committee design changes, improvements, gradual steps toward the eventual reflight as we go along.

Mr. ROE. If the gentleman would yield?

Mr. PACKARD. Yes.

Mr. ROE. I assure the gentleman from California, as long as the gentleman from New Jersey is in the Congress of the United States, along with the other people on this committee, there will be no flights around here until this committee is satisfied that the requirements are met, and I think that that's what Dr. Fletcher is saying. And I think that point ought to be made abundantly clear, because—if the gentleman would yield—the point has been out, "Well, shall Congress take a closer oversight," and I think that's—as you are doing things in NASA to revamp NASA, that's already been decided. So the answer, sir, is not only the funding; it's the action of this committee through oversight and then through allocation of authorizations.

If the gentleman would yield further—I want to back up a little bit on Mr. Packard's comment on the landing gear and the tires and the other areas. Now I hope—and I think that's the point you were developing—I hope that when we spoke of critical—let me ask a question, if the gentleman will forgive me: Is the problem of the landing gear a critical item? Is that in any one of—is that critical 1 or 1R?

Mr. ALDRICH. Yes, it is. Yes, it's criticality 1.

Mr. ROE. It's criticality 1. Now, to me, criticality means that, "Hey, guys, that's as bad as anything else on that criticality 1." Is that a reasonable point? We don't have any diversification. We say that if it's critical 1, to me that's critical 1; it's go or no go. Is that—am I wrong in understanding your nomenclature?

Mr. ALDRICH. It's criticality 1 in that failure can be catastrophic.

Mr. ROE. That's the point I'm making.

Mr. ALDRICH. However, design margins can be enhanced tremendously, and that's what we're attempting to do with the brake redesign.

Mr. ROE. Yes, but that's not the point I'm making, and I think it's terribly important because I want our hearings to have been thorough and not spongy, and there's nothing personal in what I say. I'm not as articulate as some other people in getting their point across.

But it seems to me basically when the Commission spoke to the critical areas, they said "must." Now to me that means—you know, that can be translated into legislation, too. I'm sure you're aware of that.

If it's a critical item and you take X items and you put it on the No. 1 list, now the No. 1 list, as you say, that could be a list—anything that would happen on that particular part or piece could be critical to the extent of causing a severe accident or even death. Is that what critical 1 is about?

Mr. ALDRICH. Yes.

Mr. ROE. Well, now, how can we, then, take the point of view that, as important as the O-ring is, which is the heart of this particular process that we're going through now, certainly the landing gear is critical, and anything else that's critical, what is also critical—would we say that, and I'm thinking down the line in this direction—we have three orbiters that we have to retrofit. And any decision that's made ultimately by Dr. Fletcher's folks and your people, if you're going to take a critical item 1 on that has to be redone, it means it's got to be redone on all the orbiters; isn't that correct? Wouldn't you'd say that would be correct?

Mr. ALDRICH. Yes, the design—

Mr. ROE. Basically. Otherwise, what do we—we're not going to fix up one and let the other three sit there and do nothing. I mean, you know, we don't want to get too testy today, but we're talking about taking parts from here, there, and whatever. If we're going to provide you with the tools to do the job, Congress is equally as important and responsible to provide the resources which we expect NASA to come back and tell us and say, "If you want the totally safe system, this is what it's going to cost you." Now if Congress wants to play the games and not provide the funding, then they are not doing their job to the American people, either. It's not up to NASA to tell Congress what they should or should not be doing. It's up to us to understand from you—if I were king, what would I do as the best thing in the country? That's what's before us today. That's what we're trying to decide.

We want to be able to go back to the full Congress and say:

If you're really serious about being in space, and we've crystallized the safety issue, which we've done, we're coming back and saying, "We need these assurances. We need this testing. This is what we need."

Now it's up to us from a management point to determine what you need and how you're going to do it. You tell us that.

Now I go back to the criticality issue. If we're going to fly anything, it would seem to me that the critical items are first and foremost in this committee's mind. And anything that would not meet those needs, the O-rings notwithstanding, we consider that to be important, including those landing gears.

Now does somebody want to respond?

Pardon my enthusiasm, but I get enthusiastic.

Dr. FLETCHER. Admiral Truly, having flown the orbiter, ought to respond at least about the brakes.

Mr. ROE. I would hope so.

Admiral TRULY. Well, I want to tell you that what you just said, I'm a thousand percent in agreement with.

Mr. ROE. All right, then, we'll vote. [Laughter.]

Admiral TRULY. That's what this review that Mr. Aldrich is heading up is precisely doing, and that is looking at those items, relooking at the design. If they require fixing, we're going to fix them before we fly.

However, there may be a case where we could put restrictions on the flights and fly three flights under restrictions because of the leadtime and do it. So there's a lot of things in that—

Mr. ROE. We flew 24 flights. I don't want to beat this horse to death, but what I'm trying to get across—we said that as far as NASA—and the eloquent presentation Dr. Fletcher made in the beginning I just loved because he said let's get on with it. But it seems to me that if we're going to get the answers back from you folks now and we're going to get the answers tomorrow from the technical, all we'll know is the facts.

We're coming back and we're saying, "Yes, sir, those things have to be repaired. We're not going to gamble anybody at this point until they are repaired."

And Congress ought to be able to say to NASA in response, "If we're going to need these funds and these kinds of resources to be able to the best we know how in America as far as safety is concerned, that's No. 1."

Now we don't want to talk about necessarily redundancy in every part. That's not practicable. We understand that. But we are coming back and saying, "Yes, we could fly if the temperature was a little here and we didn't have that ice"—and I don't want to—the answer is no. We're coming back and saying that everything that's on that critical list to us is critical, and everything that's on it—that's why I want to be able to say when we finish our work.

Admiral TRULY. Yes, sir; and I agree with you.

Mr. ROE. OK.

Mr. VOLKMER. Would the gentleman yield? Would the gentleman yield for just a moment on the brake question?

Mr. PACKARD. Before I yield, let me make a comment on what the chairman has just said, and that was the whole point of my question. We had 9 years of forewarning on the joint, that it was a flawed joint. There should have been redesign going on during that period of time and a phasing in so that, as long as we stayed within the parameters that made even a flawed joint fly safely for 24 missions, that was acceptable. But we should have corrected that joint long before the 9 years was up.

I'm saying the brakes, the main motors, and other critical areas that we already know have got some flaws in the design and need to be corrected, we ought to be on about doing that and phasing it in and not wait for an accident to force it to phase it in.

Mr. VOLKMER. Would the gentleman yield?

Mr. PACKARD. Now I'll be happy to yield.

Mr. VOLKMER. Yes; and along that line of redesign, I'd like to know if the redesign includes eliminating it from the criticality list

for abort missions where you have an abort, which is a lot different in that you've unloaded the payload bay.

Admiral TRULY. Are you speaking again about the brakes or the landing gear?

Mr. VOLKMER. Yes; and, of course, the—

Admiral TRULY. Yes. Criticality 1 items are items that must not fail because they would cause the loss of vehicle or crew.

In the case of the brakes incidentally, Mr. Aldrich has approved the new brake design and money, and I have approved it at level I, and it is being turned on, and we're going to do it.

That will not take, however, the brakes out of being a criticality 1 or 1R item. They are still that critical, and they are that critical for aborts or end-of-mission landings, whenever we would land the shuttle.

Mr. PACKARD. Thank you, Mr. Chairman. I have no further questions.

Mr. ROE. Just to clarify that point, I think we understand exactly what you're saying. You're saying, "Look, we're going to be able to present the best we know how, but it still stays on criticality 1 because if anything happened to it, we'd still have a problem."

But if we know something's wrong—do you understand where I'm coming from?

All right, the gentleman from Texas, Mr. Andrews.

Mr. ANDREWS. Thank you, Mr. Chairman.

I would like to go back to Mr. Mineta's line of questioning. I think the issue of the decision to launch or not to launch is so fundamental to these hearings and certainly to the Commission's findings. I'd like to know Dr. Fletcher if you concur with the view that I believe the Commission is saying that the information flows downhill pretty easily, but coming back in the other direction there has been some serious problems with breakdown in communication. Is that a fair assessment of the situation?

Dr. FLETCHER. Mr. Andrews, of course, I've only been here a short time, but I accept the committee's views on that. They have worked with our own people, and they've worked long and hard, so I have to accept the fact that their conclusion is correct.

Mr. ANDREWS. What do you think the largest problem is?

Dr. FLETCHER. I think there's a large number of problems, Mr. Andrews, all of which have to be looked at.

Mr. ANDREWS. What are those problems.

Dr. FLETCHER. It has to do with the procedures. It has to do with the definition of the procedures that are written down so that people can follow them. When they're not followed, we have to have a way to check on any deviation from those procedures. But that's not the only thing. You have to have two-way communications, as we mentioned before. You have to be able to interrogate people all the way up and down the line from level IV.

Mr. ANDREWS. What has been the most serious problem with that?

Dr. FLETCHER. In the past? I really can't comment. I've been gone for 9 years. I think somebody else that was involved in the investigation would have to answer that. But that in the future is the thing that we're talking about, when we say tighten up procedures and communications.

Mr. ROE. Will the gentleman from Texas yield for a moment?

Mr. ANDREWS. Yes.

Mr. ROE. I think what we, in our enthusiasm today, and I'm probably the most guilty one of the whole group that are here, that we have to recognize that the leadership that's visiting with us today and testifying are all relatively new. They've had, you know, years and years of experience, but they're back into the stream now.

And I think that part of what the Commission is saying to us that these are the group—the broad-based areas where these major problems are resolved, and then are looking down the road for this new team to resolve them. And it would seem to me that—if the gentleman would yield further—that I would hope that from our committee's point of view, that after we finish with this particular phase we're going through and you get back to work, then we will call you in from time to time to bring us up to date as to exactly what management improvements are being made, what exact technical improvements are being made, and so forth and so on, for what that's worth for the gentleman's line of questioning.

Mr. ANDREWS. Well, then, let me ask that question to Dr. Graham.

Dr. Graham, what do you think the most serious flaw has been in the decisionmaking process to launch or not to launch?

Dr. GRAHAM. I have more time at NASA during this tour than Dr. Fletcher because he has weeks and I have months, but I wouldn't represent that as comprehensive. Nevertheless, in my experience there I believe that there has been a serious problem in the information flow upward, as you identify, and I believe that goes up to the top of NASA, to the Administrator's office itself, and certainly to level I and I believe to level II as well.

That's to some extent an issue of the entire internal environment in NASA and the way it functions, the way information is received at the upper levels of the organization, the way it's understood, and the feedback that's provided.

I have tried to establish a policy of not shooting the messenger when information comes up, even though the information may not be information that goes in the direction that you would like the program to take, but rather to try to change the program and give the appropriate guidance and feedback to the system, but to encourage the flow of information.

I believe that has to be done over a substantial period of time and at a number of levels for information to come up through the system. As you know, that's caused some problems as well. In fact, I had to change the internal organization to remove one person out of the information flow line to make sure it came to me more quickly after the accident.

I think that and other things are beginning—we're beginning to set a tone inside NASA to encourage information flow, and I believe Dr. Fletcher's extremely receptive to information of all sorts coming up through the system. That, I think, is an absolute mandate on the Administrator's office in order to have the information flow to run a system such as the shuttle.

Mr. ANDREWS. Captain Crippen, would you comment on that? What, in particular—it appears obvious that the astronauts have

not had adequate input themselves into the decision to launch or not to launch, and what specific steps do you think need to be undertaken right away by NASA to change that?

Captain CRIPPEN. Mr. Andrews, if I may comment on the initial problem—of course, what the Commission was addressing was the fact that the information regarding all of the failures within the O-ring itself had not flowed forward over the years adequately such that it was emphasized as to its criticality, and then when we got down to the actual launch and we had temperatures that were low and certain engineers were concerned about that, that information did not flow up.

I do not think that that means that the whole system was not flowing information properly. I think it does point out a specific flaw, and we probably had others, but it does say that we have to go back and reexamine our information flow.

People have emphasized that the astronauts did not know. Just telling the astronauts is not going to solve the problem, although if somebody came and whispered in our ear we had a problem there, we would have probably brought it forward. But the proper way to bring it forward is through our program managers, and that is the way the astronaut office normally performed, and I believe that's the proper case.

For the tasks that Admiral Truly has assigned to me, I am going to try to propose an organization that does give us information flow, smooth information flow both up and down. I think we said that the information flow down is good. Maybe information down was not communicating properly to the people down in the trenches that, yes, we were interested in flying at an accelerated rate, but we were still interested in doing it safely. Maybe that information wasn't conveyed properly.

Anyway, those are the kinds of things. Up and down flow has to be smooth and has to be simplistic to do that. That also follows over directly to the launch decision process. The closer you get to a flight, the faster it has to flow, and it has to flow very smoothly and people have to know who can call the signals, and those are the kinds of things that we're going to be working on over the next few weeks to try to see if we can come up with a proposal that will at least make that work better.

Mr. ANDREWS. Thank you.

Thank you, Mr. Chairman.

Mr. ROE. I thank the gentleman.

The gentleman from Michigan, Mr. Henry.

Mr. HENRY. Thank you, Mr. Chairman.

I regret I missed about 1 hour of the hearing early this afternoon, but an unanswered or unasked question continues to trouble me, so I'll ask it even though it's simple and basic. And I'll begin, I think, with Admiral Truly, if I may.

In your opening statement you suggested—you said that you were in general agreement with the findings and recommendations of the Rogers Commission report. Do I take it that that leaves you some leeway to suggest you're not in complete agreement or—

Admiral TRULY. No. I want to make it clear that there are some choices that the Commission left us, very appropriately. And, as a matter of fact, even though I did not see a single one of the specific

recommendations until the report was published and was not privy to them, I discussed them many times with commission members and with Chairman Rogers, including, incidentally, the oversight of our SRM redesign. I think that is very appropriate, and I'm glad he recommended it.

I don't know of a single recommendation in here that I am not in agreement with. However, there are some choices in it. For example, the choice of where in the organization the person that runs safety, reliability, and quality assurance is a choice that the Administrator will have to consider and make.

The choice in the redesign of horizontal versus vertical testing the Commission, you notice, did not direct us to test vertically. They directed us to assure that we looked at it and made a reasonable decision. I forget exactly what the words are, and we're already quite a ways along that track to do so.

But I am in agreement with his approach. As far as I'm concerned, this is a great roadmap to get started with, and I'm very happy with it.

Mr. ROE. Will the gentleman yield?

Mr. HENRY. Yes.

Mr. ROE. I think we also ought to get on the record that through Dr. Fletcher and yourself and Dr. Graham that there's a host of other things that are emanating from NASA itself in its own program. It's not just this group you're looking at. There's all other things that the new management group is looking at. Is that a fair comment to make?

Dr. FLETCHER. Yes, Mr. Chairman, that's what I tried to indicate in my opening remarks. Having said that, though, I think I want to reiterate what Admiral Truly said; namely, that we're taking this Commission report very seriously as an important part of what we're doing to fix the shuttle.

Mr. HENRY. At this point, if I may, Mr. Chairman—we're all taking it seriously. I just want to have on the record that the agreement is complete, not equivocal, acknowledging obviously that in a number of areas, particularly technical areas, discretion was given to you.

The reason I raised the question was because you chose the word "general agreement" in your written testimony but also when Mr. Aldrich was responding to one of the earlier questions, I think by Mr. Scheuer or Mr. Nelson, relative to the safety appeals outside safety process, he suggested, "Well, I'm in general agreement but not in particular agreement."

And what I would like to have as clearly as possible to those areas in which complete agreement doesn't mean unequivocal agreement some guidelines. I mean that clearly to me as a layman—this report is going to be my handle in trying to follow what you're doing, what else you're doing.

May I follow with another question? I'm concerned that we deal with the recommendations that at some point the agency makes available to the members of the committee some establishment of written, objective criteria by which it believes it will, once having implemented it, satisfy the recommendation.

I'm concerned a little bit about getting caught in a little bit of a mish-mash. This is particularly because most of us here are not en-

gineers and technically qualified and yet we bear responsibility to oversee.

For example, when we had the earlier testimony by Mr. Aldrich that each subsystem was devised and certified to be 31 degrees Fahrenheit workable on the low end temperaturewise, and yet to find out that the subcomponent parts were not so certified, I don't know how you have a subsystem without the parts meeting that criteria. That obviously was one of the issues here.

Can we get some assurance that you're going to give us some working definition along the way as to what you mean by measurable, objective criteria, whether it be the brakes, the O-seal problem, what have you, so we have something when we go back and we talk to commercial engineers or other engineers and say, "Does that do the job?"

Dr. FLETCHER. You mentioned several things, but let me comment on one of them. As far as taking the report seriously, as you know, we are obliged to respond to that report in a number of months. That will be a written response and done in some depth.

We are trying to give you a general feeling about our reactions to the response, which are positive. We think the recommendations are right on target, something that I would have done had I been as smart as that Commission. And so that part I think we can assure you that you will get a very definitive response.

With regard to the other issues that we ourselves are looking at in the criterion for what is safe and what is not safe—guidelines, as you call them—I think you're entitled to have a feel for that but we haven't yet developed them. After all, we just started the response.

Mr. HENRY. Thank you.

Mr. ROE. Don, you are up next. Do you want to wait until we return from this vote? This is the second call.

Chairman Fuqua, I say you're up next, but would you rather wait—

Mr. FUQUA. I'm trying to find out what type of quorum call we have.

Mr. ROE. It's a vote. It's the last part of the second call.

The committee will recess for 10 minutes while we go vote. Bear with us.

[Recess taken.]

Mr. ROE. The committee will come to order.

And when we broke up for the vote the last time, we were about to defer to our distinguished chairman, the Honorable Don Fuqua from Florida.

Mr. FUQUA. Thank you, Mr. Chairman.

And I know that Dr. Fletcher and all his associates, that this has been a long day and probably they need to spend some time back trying to solve some of the problems.

I was going to ask of Admiral Truly—in the previous colloquy with one of the members—I think maybe it was Packard or maybe Volkmer—a subject came up of brakes and the criticality of brakes, and that is—that that could be a critical 1 on an airplane or an automobile. I know many times when I've landed at National Airport, particularly under adverse weather conditions, I was very glad that the brakes worked because otherwise I'd go into the Poto-

mac River on one end of the runway or the other, depending on which way you were landing.

But would not you classify that as a critical 1 item?

Admiral TRULY. That's right. I think that's a good way to understand criticality 1 and 1-R, as a matter of fact, as just an automobile. Your right front wheel is a criticality 1 item. It falls off; you have the chance of losing your vehicle and you. If you have a problem with it and redesign it, recertify it, it's still a criticality 1 item.

Your brakes, depending on your car model, may be criticality 1R. You may have a disc brake system that has a separate front brake system and rear brake system, and you would have to lose both of those to get in the same situation. But to me that's a good way to understand it, but, nevertheless, even after you certify it properly, your right front wheel still is criticality 1, no matter how long you drive your car.

Mr. FUQUA. I was going to point out to Dr. Fletcher—reference was made earlier about where are the giants in NASA. Do we have the giants as we had in the past?

I remember sitting in this room in 1967 when we were investigating why pure oxygen was designed to go into the Apollo capsule, and that's fine as long as you have no electrical fire or any sparks. We found that out in a very tragic manner. NASA found that out, and some of those giants of NASA found that out that participated in that. And I don't mean in any way to besmirch their record; it's a fine record. I think we have some very excellent people in NASA today. Many of them are sitting right at that table. Many of them are in this room or have been here or will be here tomorrow, and are scattered throughout the whole NASA system.

Sometimes success breeds complacency. I think that might be what happened in this particular case. But it's unfortunate we had to find out the way we did, but I think we do have some very bright and talented people in the NASA organization and in the industrial team. And I hope that we never lose sight of that fact—that they made some great contributions over the years, and I don't think it means we have an erosion of talent in this country.

I remember the early days, too, when Mark Russell, the political humorist here in Washington, referred to the Vanguard as a civil service. He said you couldn't fire it and couldn't get it to work. [Laughter.]

That was his remarks, not mine. But the—so we had our lumps in the early days of the program. It's still a very difficult thing to do.

But I would just like to set the record that there are some very talented and bright people in NASA and in the industrial team that can contribute, and have contributed, and will contribute to our Space Program—not only the shuttle where we are today, but also the space station and the many other scientific—the feat earlier this year of the Voyager spacecraft was certainly a great credit to a lot of very fine people. It's not very easy to transmit or get a vehicle to go as far as that vehicle has, and the project of Galileo and some of the others that are—and the Hubble telescope which had its problems along the way.

But I think we ought to also sometimes look at the good side, and I think the Commission did in their closing comment that we

should move forward with the program. There are a lot of fine and talented people and a great organization, and I—while we've had a bump in the road, I certainly hope that people within NASA do not become discouraged and think that Congress or the American public is down on them as being incompetents and people who are not capable of the task. They are capable of the task, and I'm sure that they'll prove that, given an opportunity.

Thank you.

Mr. ROE. I thank the gentleman.

We now recognize the distinguished gentleman from Utah, Mr. Monson.

Mr. MONSON. Thank you, Mr. Chairman.

Dr. Fletcher, being from Utah and knowing that you've been absent for a long time, we still consider you one of us, and we are proud of the work that you have done and commend you for the public service that you're showing at this time and the spirit of that public service that you're showing, and wish you all the best as you go about these responsibilities.

I have developed a concern throughout this process over whether or not we're doing enough to determine and gather enough data prior to launch as to whether or not weather conditions are suitable and such. Do you—have you gone far enough in the process yet to know whether or not it would be necessary to check more areas of temperature, more—whatever can be done to determine the effects of wind at higher altitudes and such? And I know that technology is not fully developed in that area yet, but what do you anticipate happening in that regard, if anything, at this point in time?

Dr. FLETCHER. Mr. Monson, that's an awfully good question. The only reason I'm responding instead of Admiral Truly—we had a very detailed discussion about that with Captain Crippen yesterday. That's one of the difficult things to do because you have to predict weather not only at the one site before taking off, but you have to be able to predict the weather at the alternate landing sites in case of an abort.

We have improved some over the years our weather prediction generally, but local weather predictions are still very difficult, not quite a science, and we're in the process of looking at better ways of making those forecasts.

Having said that, it may be that Captain Crippen or Admiral Truly would indicate what progress we have made.

Admiral TRULY. I don't have much more to add to that other than the fact that we recognize very clearly that we need better technology, frankly, in the country for weather forecasting and, very specifically, in the space shuttle program, we need the best technology that we can get at the Cape. Precisely where that has gone I am not familiar with, but we are going to sure pursue it and make sure that we have the technology to do the best we can and, then, the mission rules and the discipline to make sure we obey our rules when we get back to flight.

Mr. MONSON. I am not only concerned about forecasting; I am concerned about actual conditions and our ability to measure them. It is one thing to know the temperature 1,000 feet from the vehicle but right up at the vehicle itself, are we going to be doing more in

that regard? Are we going to know more about the effects on the different parts of the vehicle and such in advance of what we have done in the past?

Admiral TRULY. I am sure that we will but, again, we just aren't far enough in the design process. I would comment that even though the cold weather that morning was not found to be the cause of the accident, it certainly was a possible contributing factor in the failure of the joint. It has made the entire system very aware of environmental effects.

On the joint redesign, itself one of the requirements that the redesign team will very likely choose is that even if could withstand cold temperatures, it probably will be environmentally controlled with heaters. If that is the case, we may very well have direct instrumentation on the pad, but that is a detail best left to the redesign and certification group.

Mr. MONSON. With regard to redesign, you expressed a short time ago that there was a lot about the joint we didn't understand even in the early launches. I understand that effects of rotation and such caused the parts in that joint to respond differently than it was anticipated they would when they were originally designed.

What can we do to make sure that we understand enough before we have gone through the process of several launches before we gain the knowledge that we need to to understand exactly how these parts are working and whether or not they are working the way we thought they would when we designed them?

Admiral TRULY. Well, I don't have a pat answer, but I can tell you that I am a great believer in ground testing and understanding the systems through test and then operating systems more toward the middle of the envelope. We have done that in the main engine program in the past years. I haven't had the opportunity to take a look at that program, but, in general, I would say that I am an advocate of spending money to do testing of critical parts on the ground. We may very well find in the program that we make recommendations to have a more robust test program, particularly on criticality 1 items.

Mr. MONSON. Thank you, Mr. Chairman.

Captain CRIPPEN. Could I add just a little bit to that, that the main reason that we are smarter about the way the joint performs now was not just the accident. That told us we had a problem. But we have done a number of subsystem tests that have made us smart about the way the actual joint operates.

John Thomas from Marshall who was the man that, although he was a deputy, actually did the lead on the accident analysis was the prime driver behind most of those tests. He is now the lead on the redesign effort. Consequently, I am certain that he is going to use that same fundamental rule in the design of the new joint.

Mr. MONSON. May I follow up, Mr. Chairman?

Mr. ROE. Yes, of course.

Mr. MONSON. It causes me concern, though, when I hear that what we originally anticipated would happen may have been exactly opposite of what actually happened when the rocket was fired in certain parts of that, especially surrounding the joint in this instance, not this particular launch, but the performance of the joint overall. I guess you can never be 100 percent sure that you have all

knowledge, but I assume that from your statements, those tests will include making sure that what we thought we were designing is actually the way it performs.

Admiral TRULY. Well, if I understand your comment properly, personally, I am going to gain the confidence to go fly again not from the design but from the testing, the certification and the test program. That is why choices like the manner in which we test, the configuration in which we test, the analysis of the test data, that is the real data. We want to go fly again and the Nation desperately needs us to get back in the air, but the proof of the pudding is in the test program, and, as a matter of fact, no matter whether it is July 1987 or any other date, it is primarily the scheduling of that test program with enough time for the system to analyze it that will give us the confidence.

And when we get started flying again, we are going to have enough time in between the flights so that we can take the motors apart, analyze them at the factory, and before we commit to the next flight make sure that we have no evidence of a problem in the joints.

So, in general, the confidence that we all gain in this redesign will be through the test programs. It is a very important part of it.

Mr. MONSON. Thank you.

Mr. ROE. The Chair recognizes the distinguished gentleman from Pennsylvania, Mr. Walker.

Mr. WALKER. Thank you, Mr. Chairman.

Not in the report but attested to by several Commissioners since the report has come out is the fact that some of them claim that if the accident had not happened, the system would be shut down by now anyhow because of a lack of spare parts and a lack of resources. Do you agree with that?

Dr. FLETCHER. Mr. Walker, I am not sure you are addressing the question to me.

Mr. WALKER. Whoever might know.

Dr. FLETCHER. I have read the same statement. I think, however, there has been a rather thorough look at that by Admiral Truly and his associates, but I don't know which one is best qualified to answer it.

Admiral TRULY. Well, in a word, I don't agree with that, but I would rather Arnie speak to it, Mr. Aldrich.

Mr. ALDRICH. Two of the areas along that line that are brought out in the Commission's report deal with the availability of the flight software for the flights in 1986 and time for adequate crew training and the spare parts question. In leading into the flights for 1986 that were planned, we knew that we had a very, very tight schedule. We had packed into it all that we thought we could achieve, and we realized there was some risk of meeting all the milestones.

One of those areas which we spent a lot of time on was, in fact, the mission preparation and flight software schedules. We knew they were tight. We had touched all the bases, however, and had a map that said we could get there. I will be the first to admit that we might have run into delays and, rather than be shut down, we would have been delayed.

I think the same situation is true with the spare parts. There are shortages in some areas but not in others. Depending on which parts were needed and exactly what the configuration of the orbiter situations were, we again could have been delayed for parts, but I really doubt that we would have been completely shut down.

Mr. WALKER. But you would have been pushed very, very hard to complete anywhere close to the schedule that you had manifested.

Mr. ALDRICH. I think we would have been pushed hard to complete the schedule we had manifested, but we might have been close. We had some very demanding things in 1986.

Mr. WALKER. Why didn't somebody admit that to the Congress, then, when we were looking at some of these problems in the coming year when you were before us?

Mr. ALDRICH. Well, I can't respond to what was reported to Congress because I was not here on that subject. I did go at lengths in the program in support of the spare parts budget, particularly for the orbiter which is where the question is, and we were able to achieve the budget we achieved through the process we went through.

Mr. WALKER. We kept being assured over and over and over again that these manifested schedules and so on not only could be met but you were confident that we were moving ahead and that we were not going to have problems. Now, we find out that there may indeed have been problems.

Here is where it fits in, then, it seems to me, the overall part of the Commission. We have heard testified about today and we heard at that time that safety is always No. 1, that throughout this that you were being pushed hard, that you weren't sure you could make the manifest, and yet safety was always No. 1.

You said it, we believed it, and you had a flight record to prove it. In large part, it seems to me that what transpired then was that having had that on the record, we then get the Presidential Commission report that talks about the silent safety program. They specifically talk about things which are very disturbing:

"Organizational structures at Kennedy and Marshall have placed safety reliability and quality assurance offices under the supervision of the very organizations and activities whose efforts are their's to check."

That is not a safety program.

"Problem reporting requirements are not concise and fail to get critical information to the proper levels of management."

That is not a safety program.

"Five weeks after the 51-L accident, the criticality of the solid rocket motor field joint was still not properly documented in the problem reporting system at Marshall."

That is an atrocity.

It seems to me it is not only a silent safety program, it is an invisible safety program at that point. In the problem reports—and you, Mr. Aldrich—it says in the report that your office and the entire Johnson safety reliability and quality assurance directorate were not even on the distribution list for the problem reports. That is not a safety program.

What are we going to do to correct that?

Dr. FLETCHER. I don't know who should start, but that is an important element of the investigation that we are going to look into, both NASA-wide and in the shuttle program. We do have a safety program that we have to respond specifically to those comments that you just made, but I think, more important, we have to make sure that the appropriate safety program is implemented in the future.

Mr. WALKER. But let me just follow up on that. That is a general systemic breakdown. I mean, the things I am citing here are particulars, and you may address the particulars, but what you have got is a systemic breakdown. When you have got those kinds of problems, when the top level management isn't even on the distribution list for the problem reports, that becomes then a program on paper but not in reality.

What I am asking is, what are we going to do to solve that problem?

Admiral TRULY. Mr. Walker, I think that long journeys start with a single step. We have a lot of things in work to solve those specific problems. Frankly, even though the Commission did characterize it as a silent safety program and I accept every single one of their findings, they just have to be addressed. As someone said earlier, you can't do it with paper. You know, people who have thousands of flying hours aren't alive because the papers said for them to preflight their airplanes. They are alive because they preflighted their airplanes.

We do have a number of problems, but I think that we also have a system that was spending a great deal of time on safety. But somehow, through organizational changes and lack of discipline in some places, it needs to be shored up. I don't know how to answer your question except to have the commitment to redo it during this down time where it needs redoing, revalidate it where we deem it to be OK, and get to work on it. And that is what we are pledged to do.

Mr. WALKER. Well, let me just suggest that it seems to me that in reading the report that we got to a place where you had said to yourselves over and over again safety was No. 1 with you. You said it to us, as I pointed out before, and you had a flight record to prove it. And you began to believe that everybody up and down the line was concerned with safety, as we would hope they would be.

But as a result of believing that everybody was concerned about it, there was no one who had it as their primary concern. Ultimately, that led to a breakdown in the system.

So, it seems to me the correction somewhere along the line has to be that there has to be a primary concern about safety at some point in the system all the time. Would you agree with that?

Dr. FLETCHER. Mr. Walker, you are absolutely right. There needs to be a central point, not only in NASA but in each of the centers, in which safety is the primary concern. As a matter of fact, that should be the case with each element of this decision process, for example, starting with level 1 down to level 4. We do have a central safety location in headquarters in the chief engineer's office.

Mr. WALKER. If I may, Mr. Chairman—

Dr. FLETCHER. The fact that it wasn't communicated properly down at one of the centers, if that was the case, was a glitch and shouldn't have happened.

Mr. WALKER. Well, Mr. Chairman, if I might just take a little more time, the headquarters person—that is Dr. Silveira's office—he has one person who spends one-quarter of his time on safety, reliability and quality assurance. And he has one other guy who spends 10 percent of his time on shuttle safety. Now, that is not really much of a commitment on the part of the agency.

Dr. FLETCHER. I am not familiar with those numbers. We have safety in the R&QA office.

Mr. WALKER. As I understand, they are in the report. Those figures are in the Presidential Commission report.

Dr. GRAHAM. Mr. Walker, I would like to check that against the current status. I believe the Commission may have been reporting on the status at the time of the accident which is very germane to the accident and very appropriate for them to report on. Some changes have taken place there already. But as Dr. Fletcher and Admiral Truly said, more changes are anticipated and certainly contemplated in that area.

I believe you are exactly right that there is a systematic problem there. The safety function can too easily become mixed with other functions inside an organization. When that happens, the results can be very serious.

At this point, it is the task before us to make sure that there are safety channels which don't cross over the program channels in such a direct way that issues which are safety issues coming up through the system become unidentifiable with program issues which have to be worked in their own way and in their own framework.

Mr. WALKER. Or, when you are trying to meet a manifest schedule that you know you can't meet anyhow, become the things that get shunted aside because they do not fit with what you have got to get done on the schedule that you have set for yourself which is an impossible schedule.

Dr. GRAHAM. Yes. That is exactly what I mean by a programmatic issue. A programmatic issue is meeting cost, meeting the budget, meeting the schedule, and safety cannot be traded off against that. Risk management has to be a discipline of its own. And those have to come together very, very high in the organization and not be suppressed.

If the *Challenger* accident has reminded us of anything it is the importance of keeping these functions separate and distinct.

Mr. WALKER. And at least the program managers have to get problem reports, right?

Dr. GRAHAM. That, certainly, and many other things as well.

Mr. WALKER. Thank you, Mr. Chairman.

Mr. ROE. The Chair recognizes the distinguished gentleman from Missouri, Mr. Volkmer.

Mr. VOLKMER. Thank you very much.

I would first like to ask Bob and Dick somewhere along the line in reading the things I have read in the last few days, there is an impression in my mind that there is some concern—assuming that we didn't have the disaster of 51-L and we were going for 16 mis-

sions this year—that the question of whether we had a sufficient astronaut corps in order to handle that 16 missions and also to do the administrative work, et cetera. Would you comment on that?

Captain CRIPPEN. Yes, sir. I am not aware that anybody had a concern regarding whether we had an adequate corps. We had crews assigned for all the flights and in training, the same question had arisen that Mr. Aldrich alluded to earlier that was getting all of the software, the computer programs, out and delivered on time such that those could be put in our simulators and everybody could be adequately trained. Those were some of the things that were stacking up on us.

It wasn't a question of whether we had people; it was a question of whether we had time and facilities to get it all done.

Mr. VOLKMER. There was concern, though.

Captain CRIPPEN. There was concern.

Mr. VOLKMER. All right. Thank you.

That will, of course, have to be addressed, Dr. Fletcher, somewhere along the line if we plan to go back once into operation in the numbers that we plan to do with the number of shuttles that we have, will it not?

Dr. FLETCHER. Mr. Volkmer, even if I didn't pay any attention to Admiral Truly and Captain Crippen, that would certainly be a concern that would be fixed. But having two astronauts that have been in the program, I am certain it will be fixed.

Mr. VOLKMER. Now, the other matter I would like to address is—and it gets back to where we are now. We now have three shuttles. There is a question of whether we are going to have a fourth. I don't think anybody today can answer that question with assurance.

The statement in the recommendations of the commission in roman numeral VIII says, "The Nation's reliance on the shuttle as its principal space launch capability created relentless pressure on NASA to increase the flight rate." The next sentence is the one I was to address today, at least, Mr. Fletcher, if you could give us some idea of when we could see some activity, if any, on it. "Such reliance on a single launch capability should be avoided in the future."

Dr. FLETCHER. I think that—

Mr. VOLKMER. First, what does that mean to you, that sentence?

Dr. FLETCHER. Well, to me, it is very clear what they mean. We have already taken some action, Mr. Volkmer. They mean that we need to have a mixed fleet, a mixture of space shuttles—

Mr. VOLKMER. Expendables?

Dr. FLETCHER. Large expendables like the Defense Department what they call CELV's—we used to call it a T34D-7. Then also perhaps additional medium-sized launch vehicles like something similar to the Atlas-Centaur or Thor Delta. That is what I think is meant by that. We call it a mixed fleet, other transportation systems besides the shuttle.

Mr. VOLKMER. Now, are you addressing the question when you get into the mixed fleet and into the expendables, or are you addressing the question of whether that should be in the private sector producing those or providing those or whether it should be

done through the Government as we have done in the past with NASA again furnishing the expendables?

Dr. FLETCHER. Mr. Volkmer, we are part of an interagency group which is dealing with that. It is called the Commercial Space Working Group, I believe. It is under the Economic Policy Council of the White House. We and the Department of Transportation, the Department of Commerce, and I think Defense also are working that problem very hard to decide not whether there will be commercial launch vehicles but when that should occur. It is very likely that sometime in the future we will begin to have commercially supported launch vehicles.

Mr. VOLKMER. Assuming that we do not have the fourth shuttle, we do not get it, what would you predict would be the flight rate, let's say, by 1989 with three?

Dr. FLETCHER. Mr. Volkmer, first of all, all I want to say is I don't like the thought of having only three orbiters because that is kind of a marginal fleet. It is not just the flight rate that is of concern, but it is the problem, suppose you have a brake difficulty and you want to fix it or some other problem with one or the other of the orbiters, the pressure to launch with only three might cause another accident. I don't want that to happen. Having said that, though, I think Admiral Truly can answer the specific question you asked.

Admiral TRULY. We have a fairly major effort within the program that Mr. Aldrich is running to take a look specifically at flight rate. The present status of that is we have taken an initial look without having all the data in, and I believe that we can safely build up to a flight rate with a three-orbiter fleet of 12 to 15 flights.

But I would like to make an important point to that. The difference in 12 and 15 is not a push on safety or what. It is primarily the sorts of flights you choose. For example, if you fly Spacelab, it requires a longer vehicle flow. Frankly, with the manifest that I see today, we are going to have those kinds of vehicle flows in there. So, I think we are going to be on the low end of that scale after 3 or 4 years into the program.

In the outyears, I am sure we will get smarter. There may be ways to build it up somewhat, but at least on my watch, it will be planned, as I said, and as the Commission stated in that very paragraph that you referred to, we will have a flight rate that is commensurate with our resources, be they people or dollars or work shifts at the Cape or whatever.

Mr. VOLKMER. Thank you very much. Thank you, Mr. Chairman.

Mr. ROE. I thank the gentleman. What I plan on doing is having one more colleague ask some questions, and we will cut around 5, but there is a statement I want to make before we quit to get ready for tomorrow.

The Chair recognizes the distinguished gentleman from Florida, Mr. Nelson.

Mr. NELSON. Thank you, Mr. Chairman.

The Commission has a finding, Captain Crippen, that training simulators may be the limitation on the flight rate. Do you agree with that particular assessment of the Commission?

Captain CRIPPEN. Mr. Nelson, I think that finding is associated with the statement I made earlier that it is not the simulator so much as it is the software programs that end up feeding those simulators and how fast we can get those developed and fed in. We were saturated with what we were facing this year, and there is an effort being made to streamline that. Part of it is not necessarily just the flights that you have out in front of you. It is the fact that we were also contending with manifest changes. A manifest change in effect begins to look like another flight even though you don't execute it. It was those kinds of things that we are now trying to smooth out so that we aren't faced with those kinds of problems. But that is why you are hearing rates quoted by Admiral Truly that are more along the lines of about four flights per orbiter. With that kind of thing, we can do it.

If we had some additional simulators, it would certainly help, because they are full. Also, our simulators right now, the actual basis for them preceded the approach and landing test program. Consequently, we are in need of new computers to support them, so we have some problems in those areas that you will see probably addressed in future budget requests.

Mr. NELSON. You are referring to one of the first parts of the findings in which it says that capabilities of the system were stretched to the limit to support the flight rate over the winter of 1985-86. If I recall, I saw one statistic that had STS-61C that compared to other training hours in the simulator that that crew was particularly low. If I recall, it was something like 50 hours of training in the last so many days compared to others that had 20 percent more training hours.

Is that an example of what you are talking about on the crew software?

Captain CRIPPEN. I am not familiar with the statistic you just quoted. It was an example that we were faced with more and more of the specific mission training coming later and later in flight. It was because the programs to support that training were coming later and later. I would assume that the figure that you just quoted was part of the total problem that we were addressing and why it was continuing to get tighter through this particular year when we were looking at it.

Mr. NELSON. The commission report goes on to say in addition to the software problem that you have identified, "The two current simulators cannot train crews for more than 12 to 15 flights per year."

Captain CRIPPEN. That is just the physical amount of time that you can put into simulators themselves. They can only produce so much training time, and that was why I said that if we were going to go and talk about flight rates exceeding that, it would certainly be desirable to get supplementary simulators to support it.

Mr. NELSON. Dr. Fletcher, yesterday, I took the occasion while Chairman Rogers and Vice Chairman Armstrong were here to get a clarification on their interpretation of the following recommendation: "Full consideration should be given to conducting static firings of the exact flight configuration in a vertical attitude." And that has come up here a couple of times today.

The answer that we got back from Mr. Armstrong was that that was not a requirement. It was a recommendation for consideration. In other words, they were not mandating in their recommendations that you test in the vertical attitude, but they certainly wanted you to give consideration to simulate all of the factors in the exact flight configuration.

What is your reaction to that at this point and recognizing that you don't have all the facts at this point?

Dr. FLETCHER. Well, since you addressed the question to me, it just turns out that we have had a lot of discussions with Admiral Truly and his colleagues on that subject. That is a reasonable thing to request. By the way, it has been looked at in some depth ever since I have been here and probably long before.

It is a reasonable thing to do, particularly if you test it vertically right side up. Of course, that is a little difficult because you have to have a holddown system of some kind. To test it upside down, I am not sure that is a reasonable test. Then, of course, the thrust goes up in the air.

Having said that, we are still looking at the problem and giving it the study that it deserves, and I can tell you this, that if Admiral Truly and his colleagues have come up with any good scheme for doing that, I would be surprised, but I hope I am surprised. Go ahead, Dick.

Admiral TRULY. If I could, let me tell you briefly where we are, and we can go into it in more detail tomorrow if you would like. We are already doing precisely what the Commission report said. I spoke yesterday on the phone to a couple of the Commissioners so that when we get to our recommendation, we can get to the individuals on the Commission who discussed this from a technical point of view and try to get it together.

The most important part of that recommendation is not really the difficulty of doing the test because even though it is going to cost a lot of money and take a lot of time and probably slow us down, but which is the proper configuration on the basis of technical merit that we should do the full-scale testing.

In preparation for this hearing, I spent a good bit of time on the telephone with the people who are doing that work and it is not complete, but that is precisely what they are doing. They are looking at, for example, between the horizontal and the two vertical configurations, they are looking at things like how well can you measure thrust, what sort of a range can you vector the TVC, the gimbling of the nozzle in the two configurations and, most importantly probably in this situation, the loading on the joints in the two, actually, the three configurations, what would be the best from the point of view of joint dynamics.

Beyond that, you sort of drift into the problems of it. For example, there is one other, and that is the assembly, in other words, which of the two configurations would be the proper one or the most conservative one as compared to the failure that we had.

So, I am confident that we are very fairly looking at that, and we are going to look hard at it. I believe that vertical testing could be done. We have looked at approximately 10 sites around the country that I can tell you about. We have a preliminary estimate of what we could do at each of them. It would be a mighty effort to do it,

but if it is necessary to do, we will do it. But the first question is, should we do it, and that is the way we are approaching it.

Mr. ROE. The Chair recognizes the gentleman from Pennsylvania, Mr. Walgren.

Mr. WALGREN. Thank you, Mr. Chairman, and I realize it has been a long day for everybody, and I have had to be absent as well. I apologize for raising points that might have been covered, but I feel I should and I am troubled by one area.

That is this balance between looking back with recrimination or blame versus going forward. What I am concerned about is that apparently there is widespread agreement that the mindset in NASA has to change. I am concerned that the new start won't have that much of a difference unless we really do assess responsibility. I wonder whether NASA is prepared to look at this sequence of events and assess the kind of responsibility that I think would be needed to change a mindset and change an attitude.

The head of the Commission, Mr. Rogers, said that in talking to someone at NASA it was like there hadn't been any accident, and that is a direct quote from him here before this committee yesterday, and that is what I am trying to get at.

I wanted to ask, Dr. Fletcher, you said in your press release in response to the Commission's report that the criticism was not, and I think I quote, "completely undeserved." You don't mean to imply that there was an undeserved criticism in the report by that qualification, do you?

Dr. FLETCHER. Mr. Walgren, remember that that statement was made after having received the report only a few hours. I think there was maybe at most 4 hours between the time I received the report and the time I made the statement. And, naturally, you want to cover yourself. As far as I know now, there is no part of that report that wasn't deserved.

Now, that isn't to say that I have read it so much in detail that every word and adjective and so forth I agree with, because I can't really say that, but by and large, the report and the harsh criticism is deserved by NASA.

Mr. WALGREN. One of the recommendations was that there be tape recordings of some of the conferences where the decisions to launch might be made and where reservations should be made. Mr. Boehlert made the point that certainly that would create a record that you would be able to go back on, and heaven forbid that we should ever have to.

I think one of the most interesting things about that is that I sense that somehow or other the shuttle and its mission are so overwhelming that it is hard for a mere individual to get in the way. I think when I look back on some of this record, I can see the size of the project, the momentum of the project, and the importance of the project, having a kind of momentum that seems to override the individual.

I wanted to ask that that recommendation of tape recording be very deeply considered by NASA because I think the one thing it would do is it would elevate the individual and encourage them to play their role at whatever point to the fullest knowing that someone might look back on it, but not so much as a tracking device but as a mechanism to empower the individuals that are making these

kinds of decisions because of the psychological momentum of the program itself. Do you have any thoughts on that?

Dr. FLETCHER. Mr. Walgren, one thing that you said earlier, I think, really is important to say again, and I will say it a different way. If we haven't learned by that tragic mistake, we haven't done our job. That is the way we learn. I am sure there were places in the organization where there was not the appropriate motivation or, as you say it, the appropriate sense of responsibility. We can't make this very complicated machine work without everybody in the decision loop feeling that responsibility and being motivated not to make a mistake.

A recording of his conversations is possibly one way we should consider to make sure that people do feel that responsibility. There are a lot of other things we have to look at as well.

Mr. WALGREN. If I might, one other question, Mr. Chairman, and that would be in one of the Thiokol memos, they talk about the possibility of a near-term fix of the O-seal problem or the O-ring problem and being based on shimming the joint differently than apparently it was planned originally. The Thiokol memo is dated August 20-something, and they say we ought to do the near-term shim fix on the flight that is scheduled after STL-25 which was scheduled to go August 22 at the time.

My point is that there was indication that there was a very near-term interim improvement that could be made on the O-ring problem. The question is whether that improvement was made on this shuttle flight that took off some 8 months later and, if not, why not?

Admiral TRULY. Do you know?

Captain CRIPPEN. To the best of my knowledge, it was not. The proper gentleman to probably answer that question is John Thomas tomorrow who did lead the accident analysis—

Mr. ROE. Well, if the gentleman would yield at that point and the gentleman from Pennsylvania would indulge me, I think that it is important to keep our continuity. I know you were at two other hearings. We are bringing those folks in tomorrow who are directly related to that. So, I think it would be more profitable to get the factual information rather than conjecture, if that is reasonable. We will take that up first thing tomorrow. I think it is appropriate.

Mr. WALGREN. I appreciate that, Mr. Chairman. Thank you very much.

Mr. ROE. I think it would be more productive. I thank the gentleman from Pennsylvania again for his excellent participation.

We are going to quit now. I want to thank you all for being extraordinarily patient and very understanding and very up front. I like that. I think there have been some difficult questions today, and I think we have all been pursuing them, and I think you have equated yourselves very, very well in the new management team that is heading up NASA.

I would hope that tomorrow, as we had discussed, we will meet at 9:30. It would be again very desirable to have Dr. Fletcher and Dr. Graham and Admiral Truly and all of you here tomorrow as we go through the next step. The next step now is to detail through the task forces you have set up and go through that drill. I think it

is important for members to understand exactly what happened there which we are talking about.

I would like for you to think about this for tomorrow afternoon. I know that it would be inappropriate for you to be in a position of making policy decisions because it is not your prerogative. It is certainly not this day anybody's until all the facts are unfolded.

However, I think that as we go through the phase that we are going through now in dealing with the technological factors, safety factors, and beginning to mature some thought processes as it relates to improving the management efforts which have been discussed in depth today that the final leg of our journey is going to be what the policy positions are going to be.

There are different people, of course, who have different views as to what policy should be. Some people say we should have a balanced fleet, some people say we should not build the fourth orbiter, some people say what do we do with three if we don't build the fourth, will we be able to do the space station, what about the satellites that are sitting in warehouses now, and so forth. So, there is a universe of knowledge and fundamental basic information that has not yet been presented into the debate. Most of it has been conjecture to this point and, rightfully so, the Commission took the point of view that that was not their charge under the President's directive. I think that is a statement of fact as to where we are now.

However, I would hope that as the members unfold their questions tomorrow, those are some of the questions that should be asked so that we can begin to see in both a short-range policy point of view and a long-range policy point of view what are the facts before the Congress. In other words, it would be things such as if we have the three orbiters, why three? Why not two? Why not ten? I don't mean to be facetious. I think that is something that ought to be laid out before the American people.

I think the next point is, what is the relationship when we start talking about time and cost as it relates to the space station, the experimental phases, and the different things we are looking to achieve in the space station situation per se? The idea if you are going to be limiting, if we only have a fleet of three shuttles or four shuttles, what does that mean from an objective point of view as far as payloads are concerned, particularly in light of the safety factors and the re-review that you so well testified to here today.

So that we could get some observations, at least, factual observations based upon the information that is available to us that we can at least have some foundation for a thought process to develop by the committee as far as long- and short-range policy would be concerned.

So, I wanted to alert you to that for consideration, because some of those questions will be propounded by different members tomorrow afternoon.

I want to thank you very much for being with us. The committee will stand adjourned, and we will meet again tomorrow at 9:30.

[Whereupon, the committee recessed, to reconvene at 9:30 a.m., on Thursday, June 12, 1986.]

INVESTIGATION OF THE CHALLENGER
ACCIDENT
(Volume 1)

THURSDAY, JUNE 12, 1986

HOUSE OF REPRESENTATIVES,
COMMITTEE ON SCIENCE AND TECHNOLOGY,
Washington, DC.

The committee met, pursuant to recess, at 9:35 a.m., in room 2318, Rayburn House Office Building, Hon. Robert A. Roe (acting chairman of the committee) presiding.

Mr. ROE. The committee will come to order.

Good morning, ladies and gentlemen. This is the third day in the Science and Technology Committee's series of hearings to investigate the shuttle *Challenger* accident. We have had 2 very productive days so far, the first with Hon. William Rogers, Chairman of the President's Commission on the Space Shuttle Accident, and the second with NASA Administrator, Hon. Jim Fletcher and Admiral Truly and his staff. Dr. Fletcher is back today and we appreciate his joining us again, accompanied by Adm. Richard Truly, Mr. Arnold Aldrich, and joining the NASA group for this hearing is Mr. J.R. Thompson, Vice Chairman of the NASA Task Force. In addition, we will be hearing today from the six NASA task teams that supported the Rogers investigation.

That means we're going to have 12 reports this morning, I think.

I believe that our initial progress and pace has been good, and I look forward to continuing our momentum. The committee's task is to conduct an incisive and comprehensive inquiry into the *Challenger* crash, using the report of the Rogers Commission as an important basic foundation. Our objective in doing so is to provide for a constructive change in the Nation's space operation to ensure its future progress.

So again, we want to thank you, Dr. Fletcher and Admiral Truly and Mr. Thompson and Mr. Graham—Dr. Graham, rather—for your excellent cooperation yesterday. We've gotten good reports. Members feel comfortable with the progress we're making. And then, as we had planned yesterday, our program would be to take and now review in a little more depth, from a technical point of view, the work that your task force had done in coordination with the Commission to kind of close that gap between our review and your presentation. And then we would continue this afternoon on additional questions and answers, and see if we can conclude that phase of the work today.

[The prepared opening statement of Mr. Roe follows:]

OPENING REMARKS OF HON. ROBERT A. ROE

This is the third day in the Science Committee's series of hearings to investigate the Shuttle *Challenger* accident.

We have had two very productive days—the first with the Hon. William Rogers, Chairman of the President's Commission on the Space Shuttle Accident—the second with NASA Administrator, James Fletcher.

Dr. Fletcher is back today, accompanied again by Admiral Richard Truly and Mr. Mr. Arnold Aldrich. Joining the NASA group for this hearing is Mr. J.R. Thompson, Vice Chairman of the NASA Task Force. In addition we will be hearing today from the six NASA Task Teams that supported the Rogers investigation.

I believe that our initial progress and pace have been good, and I look forward to continuing our momentum.

The Committee's task is to conduct an incisive and comprehensive inquiry into the *Challenger* crash, using the report of the Rogers' Commission as an important foundation. Our objective in doing so is to provide for constructive change in the nation's space operations to insure its future progress.

America needs a sound and successful space program to carry it into the 21st Century. We are here to assure that this will happen.

Gentlemen, welcome.

I want to recognize Congressman Lujan, the Ranking Republican on the Science Committee.

Mr. ROE. Without further ado, I recognize the distinguished gentleman from New Mexico, the Honorable Mr. Manuel Lujan.

Mr. LUJAN. Thank you, Mr. Chairman. I don't have an opening statement. I'd like to move right on.

Mr. ROE. Very fine.

Dr. Fletcher, we defer to you.

STATEMENTS OF DR. JAMES C. FLETCHER, ADMINISTRATOR, NASA; REAR ADM. RICHARD H. TRULY, ASSOCIATE ADMINISTRATOR FOR SPACE FLIGHT, NASA; ARNOLD D. ALDRICH, MANAGER, NATIONAL SPACE TRANSPORTATION SYSTEM, NASA; J.R. THOMPSON, VICE CHAIRMAN, NASA TASK FORCE, NASA; REPRESENTATIVES FROM NASA'S TASK TEAMS: DAN GERMANY, THOMAS HOLLOWAY, JACK LEE, JOHN THOMAS, THOMAS UTSMAN, COL. EDWARD O'CONNOR, USAF

Dr. FLETCHER. I'd like to defer at this time to Admiral Truly, who will introduce his associates.

Mr. ROE. Admiral Truly.

Admiral TRULY. Thank you, Mr. Chairman.

Shortly after the accident, I recognized very quickly that what was needed was a good organization within the NASA task force, which I briefly mentioned yesterday, and I needed some full-time help from someone who could pull the task force's day-to-day activities together, and quickly came upon Mr. J.R. Thompson to my right, here. Mr. Thompson was a former employee at the Marshall Space Flight Center during the development phase; he was a project manager for the space shuttle's main engine project; and is now at the Plasma Physics Laboratory at Princeton University. J.R. Thompson agreed to come on with the task force full time and just recently, with our conclusion, is now back up at Princeton and is here today to take you through an overview of the technical investigative activities that the task force did in support of the Presidential Commission.

So I would like to turn it over directly to him.

Mr. ROE. Dr. Thompson.

Mr. THOMPSON. Mr. Chairman—

Mr. ROE. You're going to have to pull those mikes in. They're not quite as sensitive; you have to get pretty close.

Mr. THOMPSON. By way of introduction to today's agenda, I'd like to highlight and summarize the organization that Admiral Truly put together in support of the investigation conducted by the Commission. So if I could have the first chart.

With myself and Admiral Truly providing the overview, with Bob Crippen from the Johnson Space Center, Col. Nate Lindsey, Joe Kerwin, and Walt Williams, the NASA task force was structured as you see on the chart with six teams, four of which were direct analogs of teams supporting the Commission. The development production team, headed by Jack Lee of Marshall Space Flight Center; the prelaunch activities team by Tom Utsman at the Kennedy Space Center; the accident analysis team—I provided the overview leadership for that, but the driving motivator and worker in terms of getting the job done at Marshall Space Flight Center was John Thomas; the mission operations team, by Tommy Holloway of Johnson Space Center; and the search, recovery, and reconstruction team by Col. Ed O'Connor from the Air Force; and the photo and TV support team, by Dan Germany of Johnson Space Center, that you heard yesterday.

Just in terms of the end product of the work that was done by the task force, we delivered to the Commission on April 18 some 47 volumes of reports. We completed the answer to some 247 action items that were formalized by the Commission. Col. Ed O'Connor and his recovery team with the Navy, and a rather outstanding force, recovered some 215,000 pounds of debris, which represents slightly over 25 percent of the shuttle vehicle.

During the course of our support work with the Commission, we conducted some 20 different, separate, individual tests—rigs—which ended up being over 2,000 tests in terms of analyzing the data and what went wrong during the mission. This was not done just by the task force. Including many NASA people throughout the various centers and the contractor personnel at any one time, there were approximately 6,000 people directly supporting the task force, which was then supporting the Commission. So a lot of people certainly put on a lot of long hours to support this activity.

I think we came to the right conclusion. Certainly, the task force embraces the conclusions drawn by the Presidential Commission; and to get into that data, we would like to start with a summary of the time line. I think you heard from Dan Germany more yesterday on that, but we would like to summarize that, which I believe would be a natural lead-in to the accident analysis team. That presentation is going to be given by John Thomas, followed by Jack Lee and the production development team, and then the mission operations team and the prelaunch activities.

We will not present a presentation today unless you require one from the search team because of your extensive review of that hardware at the cape, but we stand by to answer any questions that you have in that area and have some backup material if you need it.

If there are any questions of me—if not, then we will proceed directly with a summary of the time line by Dan Germany.

Mr. ROE. Well, you might want to clarify for the record—if the gentleman will yield for a moment—as was explained yesterday by

Dr. Fletcher and Admiral Truly, this high-level team—teams—of expertise in these particular various assignments worked in coordination between NASA, the agency per se, and under the direction of the Commission so that the Commission's reports, efforts that we have received, is a product of these particular coordinated activities. And that, I think, we have to get on the record. I want to close that gap; isn't that what we're doing here?

Mr. THOMPSON. Yes, sir. Let me speak for the task force; that is very much true. We worked very closely with the Commission, answered, to my knowledge, any action that they gave us, and provided them quite a bit of data.

Mr. ROE. Dr. Fletcher.

Dr. FLETCHER. Mr. Chairman, Dr. Graham, of course, was here when this was going on, and I think he can clarify the relationship between the task force and the Rogers Commission. He was closer to the Rogers Commission during that time.

Mr. ROE. OK. Dr. Graham.

Dr. GRAHAM. Yes, Mr. Chairman.

When the Presidential Commission was set up, we had discussions with them as to how NASA was going to support their investigation. It became clear in those discussions early on that they intended to break their activities into a number of subcommittees. This was within the first week of their establishment. At that point, we worked with them to follow the identification of specific subcommittees and specific tasks that they were going to put together. Then when we put together our formal support teams, we mirrored the intentions and the areas that those Presidential Commission task force subcommittees were going to pursue as closely as we could. So we tried to make a structure within our own work which was closely enough a reflection of what the Presidential Commission was going to do that we could have easy and direct channels of communication between each of our groups and the subcommittees of the Presidential Commission. That was reflected in the first four working groups or task force groups that you see on the chart; the other two were then support to the entire operation, and we maintained direct communications across those under the specific arrangements that Admiral Truly set up throughout the investigation.

Mr. ROE. So therefore, the work that we're about to review now closes the gap between the expertise and the work that the NASA task force teams did for themselves and for the Commission? There's no gap between those two, no information gap between those two?

Mr. GRAHAM. There was no information gap, Mr. Chairman. We responded to all requests of the Commission. In addition, when we felt there was an area of investigation or study that needed to be done that the Commission hadn't specifically recommended, we went ahead and pursued it anyway in the technical and accident investigation area. We made the results available to them and, from time to time, we suggested to them specific issues or areas that they might wish to pursue. So we attempted to keep as close a coordination between the two activities as we possibly could.

Mr. BOEHLERT. Mr. Chairman, if I may?

Mr. ROE. The gentleman from New York.

Mr. BOEHLERT. If I just may, I'd like to ask Admiral Truly a quick question.

Was there any limitation placed on the resources that were made available to you for this important assignment?

Admiral TRULY. No, sir, there were not.

Mr. BOEHLERT. Thank you.

Mr. ROE. Dr. Thompson, you may proceed.

I just want for the members'—for the record, and for the members' information—that we've closed—there's no gap that lies between this testimony and the Commission's testimony. That's the point I want to make.

Dr. Thompson, if you would be so kind?

Mr. THOMPSON. At this point, then, we would like to proceed directly with the time line summary by Dan Germany of the Johnson Space Center.

Mr. ROE. Mr. Germany.

Mr. GERMANY. Mr. Chairman and members of the committee—the first chart, please.

This is really the second piece of the activities that the photo and TV Team worked with during the accident investigation. Yesterday you saw the film that we had, so today I want to just briefly run through the time line that goes along with that particular film that you saw, really for two reasons; one, for the record, and then to provide you some information as you go through your deliberations, and it can help you understand better some of the activities that you'll be seeing from the other teams.

Next chart, please.

This is a chart of the vehicle coordinate system that we used, and the X axis is the axis that runs along the vehicle itself. As you can see, in the front part of that, any time you have a roll maneuver, it's about that X axis. And then, the Y axis is the horizontal one that you see there. And any time you see a pitch maneuver on the vehicle, it's going to be about that particular Y axis. And then the Z axis of the vehicle is the vertical one on the chart there, and any time you have a yaw maneuver it's about that particular Z axis.

Next chart.

Now, this time line—I've got four charts that we're going to summarize for you. And let me kind of walk through the graphics of the chart before I get into the details of it.

The bar column in the middle is time, and you read it from the bottom of the chart to the top of the chart. So zero at the bottom is ignition command of the solid rocket motors, and it goes all the way up on this chart—we show 22 seconds. And each of the columns that you see, starting on the left, the column entitled "camera," just gives you an idea what each of the camera numbers are for which we've pulled the sequences which you saw yesterday. And then the next column, "photographic event," is a verbal description of what we saw from the particular—either TV or films.

The next column, MET—MET means Mission Elapsed Time—and that's referenced back to the zero ignition command. We've got that on both sides of the vertical bar because on the left side of the chart is "photographic activities"; on the right-hand side of the chart is the instrumentation that went along with the particular photography that we saw.

Now, this chart is the first one that shows the first activities that were anomalous from a photographic point of view that has to deal with the smoke, and at 0.678 seconds there, you see we confirmed smoke. And then we talk about the multiple puffs of smoke that

happened. And after that, at 2.7 seconds and 3.3 was the last time we saw the smoke.

Next chart.

Mr. ROE. Would it be profitable for the people that are here, if somebody had a pointer and was just pointing this out as we went along? I think that might be helpful, because everybody doesn't have the advantage of having a copy of your—

Mr. GERMANY. OK. Crip, would you mind pointing?

Now, this particular chart indicates that, really, nothing was happening in that second period of time from the 3.3 seconds up to 58 from a photographic point of view.

Mr. ROE. Mr. Germany, can I interrupt you again?

Mr. GERMANY. Sure.

Mr. ROE. Let's go back to the first chart and start over again.

Mr. GERMANY. All right.

Mr. ROE. I think it's very important because the first phase on the left-hand side, where we're talking about the photographic events, you're in effect following in sequence here, in chart form, what we viewed yesterday by photography.

Mr. GERMANY. That is correct, sir.

Mr. ROE. And it might be well just to reiterate that as we're going on because it gives a sequence that's very important to later-on conclusions, if you don't mind doing that over again.

Mr. GERMANY. OK.

At 0.678 seconds is where the first time that we saw the smoke. And then, from 0.8 up to 2.4 is where we saw the multiple puffs that you saw on the film yesterday. And then at 2.7 seconds was the last time we saw smoke above the right SRB ET attach ring. And what that is telling you is that, if it was no longer above it, that means essentially the smoke was not replenishing itself, so the joint was tending to heal itself.

So the next point up, at 3.3 seconds is when you see the last positive visual indication, and it's below the ETF dome. So now the vehicle is moving, and you no longer see anything going in the plus-X direction; so therefore, the joint has essentially healed itself for this particular time period.

OK, next one.

So during this period of time here, from 35 up to 54, we're seeing nothing from an anomalous point of view.

Next one, Tommy.

OK. From 58.7 up to 64.7 is where we see the next series of events that occurred. And what's happening in this series is, the first evidence of flame occurred at 58.7 seconds. And let me just kind of verbally describe what this chart is going to tell you here.

The flame started, the first time we saw it, and then it started to flicker a little bit. And as it—from a flickering point, it became continuously and well defined at 59.2 seconds, so that's telling you the flame is progressively getting larger and is becoming constant. And then, later on, at the 60.2 second period is where it is attaching itself to the ET 2058 ring frame. Now, what this is telling you is that now the flame is impinging upon the ET, and from this point on is when you're going to start to do the damage to the external tank itself.

The result of that is shown at 64.6 seconds—Crip, if you could—right there, is the first indication of the leak at the 2058 ring frame. So this is telling you now that the external tank is beginning to leak as a result of the impingement of the flame upon the tank, OK?

Next chart, please.

So the leak has started now, and we didn't really see anything else from an anomalous point of view from that point until we get to the 73.1 second point, and that is the LH-2 tank failure. When the LH-2 tank failed—and if you'll look at the right-hand side of the chart, Crip, at 72.2, start the divergent yaw rates—the R means right and the L means left—the difference between the right-hand booster and the left-hand booster. Now, the right-hand booster is starting to move away as it broke off, and you saw—you remember the CAD picture yesterday, when we saw it rotating like that? So the booster is breaking away, and the LH-2 tank has failed.

Now, here's what's happening. When that LH-2 tank fails, you have a large—the hydrogen itself is coming out of the bottom of the tank. You get a little bit of an extra thrust rippling up through that structure. The right-hand SRB is starting to move, and it crunches into the inner tank area, as you saw yesterday; and when that happens, you lose the structural integrity of the external tank. And when that occurs, there's nothing to hold the vehicle together, essentially, because it's all tied together through the external tank. So that point on is when we get the—the structural breakup occurred, which we call the point at 73.3 seconds, greatly increased intensity, the white flash. This is where we feel the structural breakup occurred.

And I believe that's the last of the charts, and that's just a brief summary for you, Mr. Chairman. Are there any questions?

Mr. ROE. Are there any members that have a specific question on this first phase?

Mr. WALKER. Yes, Mr. Chairman.

Mr. ROE. Mr. Walker from Pennsylvania.

Mr. WALKER. First of all, Mr. Chairman, I do have a statement here that I would like unanimous consent to put in the record.

Mr. ROE. No objection; so ordered.

[The prepared opening statement of Mr. Walker follows:]

OPENING REMARKS OF
REPRESENTATIVE ROBERT S. WALKER
RANKING REPUBLICAN MEMEBER
SUBCOMMITTEE ON SPACE SCIENCE
AND APPLICATIONS
U.S. HOUSE OF REPRESENTATIVES

JUNE 12, 1986

Good morning, Mr. Chairman. Today we move into a more detailed analysis of the Challenger accident. We have now heard from Secretary Rogers and have had the opportunity to read the report his commission has submitted to the President. We have also heard from the highest level of NASA management that they endorse the commission report.

Last night the President of the United States indicated that he will seek a new orbiter to replace Challenger. That is good news for those of us who firmly support our space program.

Having sat through several days of hearings and having read a great deal of material to get ready for these hearings, let me share some very important observations with you.

"Any program, and particularly the largest and most complex research and development program ever undertaken by man ... must have schedule goals. The schedule is an essential and significant management tool -- without it the program would require more and more time and more and more money."

"Safety must be considered of paramount importance in the manned space flight program even at the expense of target dates. The earnest declaration that 'safety is our prime consideration' must be transfused into watchfulness so that people do not again stumble into the pitfall of complacency. NASA's creation of a Flight Safety Office with broadened capabilities and better lines of communication is a step in that direction. The Congress, in the National Aeronautics and Space Administration ... authorization act, directed the Administrator to appoint an Aerospace Safety Advisory Panel to review NASA's operational plans and advise the Administrator with respect to the hazards of proposed or existing facilities, proposed operations, and on the adequacy of proposed or existing safety standards."

"It is not our intention to have the committee intrude unnecessarily in NASA's daily management responsibilities or to substitute congressional judgement on the innumerable matters requiring decision by the program managers. It is a practical impossibility for the committee to review all communications between NASA and its contractors. Clearly NASA must exercise discretion in determining what information it will call to the attention of Congress."

"Nevertheless, the committee's investigation demonstrated that NASA must make a more concerted effort to alert Congress to major problem areas as the space program evolves. The serious contractor deficiencies noted ...

should certainly have been reported to the committee at the time of the ... budget hearings, if not before."

"We are disturbed at the possibility that, had there been no disaster, important shortcomings in the management, scheduling, design, production, and quality control might never have come to light."

Mr. Chairman, those observations are important because they are direct quotations from the report of the Senate Committee which investigated the Apollo 204 Accident which occurred on January 27, 1967.

Mr. Chairman, I am astounded how accurately those words from two decades ago apply to the situation we face today. Just a few short blocks from NASA headquarters is the building that houses our national archives. Engraved on the face of that building are the words of the philosopher who wrote, "Those who do not learn from the past are doomed to repeat it."

My concern, Mr. Chairman, is that history does not repeat itself, but people can repeat history. The Congress, and more specifically, this committee, has a duty to search into the institution memory of NASA that these errors cannot, and must not be repeated.

Mr. ROE. Do you want to turn those lights on for the moment?

Mr. WALKER. There is that long period of time, or a fairly substantial period of time, between the first puff of smoke and then the visible flame. Do we have a theory about what happened there? You said the joint appeared to heal itself. Do we have a theory about what that process was, of the healing? And then what ruptured the joint again at approximately the 62 second point?

Mr. GERMANY. Mr. Walker, let me do this for you. I'm going to give you a little bit of an answer, and then Mr. Thomas, who is going to be following me on the accident analysis team, will go into it in more detail. But since you ask it now, I'll give you part of the answer right now.

As the smoke occurred and the erosion started of the O-ring, we believe that what happened, a combination of the exhaust products and the vehicle dynamics stopped the twang in the vibrations after that first three seconds. It tended, then, to seal. And then, as it went later into flight, if you go through the MAX-Q region, which is maximum dynamic pressure, the vehicle starts the oscillation and the vibration again—

Mr. WALKER. When does that start?

Mr. GERMANY. Well, MAX-Q occurred—let me just, so that I won't have to guess the exact answer for you—MAX-Q occurred at 59 seconds, maximum dynamic pressure. After that point, then we feel the erosion began again, and that accounts for that. Now, Mr. Thomas will go into more details for you if that satisfies you right now.

Mr. WALKER. Thank you, Mr. Chairman.

Mr. ROE. Further questions? The gentleman from California.

Mr. PACKARD. Thank you, Mr. Chairman.

I think we've understood that the crew had no way, nor did ground control, have any way of knowing the progress of this 73 seconds in terms of the anomalies. That's correct, isn't it?

Mr. GERMANY. Yes, sir, that is correct.

Mr. PACKARD. There were no monitoring systems that would have alerted them to the progress.

At what point in time would—well, apparently there was no point in time where they could have shut down the motors—

Mr. GERMANY. No, sir.

Mr. PACKARD [continuing]. And stopped the process of going, even had they known?

Mr. GERMANY. That's correct.

Mr. PACKARD. They would have either had to have aborted and cut the shuttle away from the rest of the hardware, had they known, but that would have been the only thing they could have done, no way to have salvaged the mission.

Mr. GERMANY. That's correct. We didn't have anything at all that would allow them to correct the situation or to leave the situation.

Mr. WALKER. Thank you.

Mr. ROE. Mr. Barton.

Mr. BARTON. Thank you. I just have two quick questions.

One, based on what you just said, how close, in spite of all the screw ups, did the mission come to not disintegrating? And two, if it wasn't—were there some unusual wind shears that caused exces-

sive—I think you call it maximum-Q—that if it had been a normal wind situation, that wouldn't have occurred? Does that make sense to you?

Mr. GERMANY. Well, I'm not sure I follow the questions directly, but the—

Mr. BARTON. I mean, it appears that there was a chance, in spite of the cold temperature—the ring did seal, and for a certain amount of time everything was working OK.

Mr. ROE. If the gentleman would yield, I think it would be more profitable—we've only seen the first blush; we're going to have an analysis presented by the accident analysis team, and it might be better if we listened to what their analysis is, because the questions that we're generating now relate to that issue, if that is satisfactory to the members. I think it would be more profitable, and we would at least have the full background before us. Is that all right?

So why doesn't the gentleman hold on his questions?

Mr. BARTON. I would like an answer to the first question.

Mr. ROE. All right.

Mr. BARTON. If they feel that the mission came close to being successful, in spite of all the problems.

Admiral TRULY. Let me try and—the answer is no. We don't know how the leak would have continued to grow had the vehicle not broken up where it did, but I know of no analysis that said that we could have sustained that unknown—that leak that was growing at an unknown rate until separation, and that the axial thrust caused by the exhaust at the time of separation would have also created an unknown separation condition at the time of solid rocket motor separation.

So the task force never was able to develop any conclusive data that would have shown that the mission could have been a success. You could postulate that, but we had no data.

Mr. ROE. All right.

Under those circumstances, I believe you will—is your next plan to have the accident analysis team's observations presented by Mr. Thompson?

Mr. THOMPSON. Yes, sir.

Mr. ROE. Suppose we proceed with that.

Mr. THOMPSON. OK, John.

At the time of the accident, Mr. Chairman, John Thomas was the manager of the Space Lab Program at Marshall, and he was instrumental in providing the leadership for this accident analysis team. And with the conclusion of our work, he is now leading the redesign activity on this joint on the solid rocket booster.

Mr. ROE. Mr. Thomas.

Mr. THOMAS. Thank you, Mr. Chairman.

Mr. ROE. We'll have to pull those microphones closer because we're having difficulty hearing. And it's not your fault; it's the microphones' fault. We're hoping NASA will design a new one for us in due course along the line.

Mr. THOMAS. OK.

Could I have the first chart, please?

Mr. Chairman and members of the committee, I'd like to discuss with you today our activities within the task force dealing with the topic of accident analysis.

Next chart, please.

And to set the stage for doing that, I would like to describe for you the approach utilized in the accident analysis process. It was structured from the very beginning, observing the incident, obtaining the flight data, the photovisual coverage and the observations from the flight. From that, we developed a fault tree, and that fault tree was constructed using the data from the incident, the anomalies we did observe early on, the observable vehicle failures—that is, the explosion—and all the failure sources that could produce such—

Mr. ROE. Will the gentleman please suspend? We have a call of the House. I don't want to lose the continuity, but your testimony is too important and I want to keep it in continuity. So we will have to recess for 10 minutes and vote. And if everybody would please come back right away, because in 10 minutes time we're going to proceed to go through this program in depth.

[Recess.]

Mr. ROE. Again, the committee will reconvene. We were just about to begin with the presentation by Mr. Thomas. If you'd be so kind as to begin again, sir.

Mr. LEWIS. Mr. Chairman. Mr. Chairman. Over here, Mr. Chairman.

Before we start, I think it should be noted that our senior astronaut lost his position to an electronic pointer. [Laughter.]

He was pointing out on the charts where the presenter—now he's lost out to an electronic pointer. That just goes to show you the advance of technology.

Mr. ROE. I missed that. OK. Are we ready?

Mr. THOMAS. Mr. Chairman, I was in the process of defining the analysis approach that we implemented in the accident analysis team, beginning with the incident. And from the incident, developing a fault tree that included the anomalies, the vehicle failures, and the source of those failures, and that was for each and every element that was aboard the 51-L flight.

Having defined the fault tree and the potential sources for cause of the failure, then we developed an incident data base, an accident data base, consisting of a large amount of design and qualification data, the assembly tests or assembly and build tests and checkout data, determined the flight environments, the data that was received from the flight on the downlink, and other data from the ground, the various tests and analyses that had been conducted and would be conducted in the future in a closed-loop fashion, as well as the recovered hardware and a detailed listing of anomalies that had been experienced in the past.

Having this data base, then, we reviewed the data base and developed from that a number of scenarios that would have led to a structural breakup of the vehicle. We postulated the sequence of these scenarios and then evaluated their credibility. And in evaluating that credibility, it required that we do additional testing and analysis, which is also shown in the process, where we had special tests set up, special analytical models developed, as well as those that were existing at the time. And then we took the results of those, fed those back into the data base, and then cycled back through the scenarios. Having then an iterative process of testing

credibility of each one of the scenarios, finally winding up with conclusions of what we suspected to be the causes and the findings of the accident analysis panel.

Next chart, please.

Then to carry out this process, we established an organization that is listed under J.R. and myself in the top block. We established a group for each of the major elements; that is, the shuttle main engine, the external tank, the solid rocket motor, one for the solid rocket booster, and for those things that transgressed across all of those systems, a systems working group. We also treated the payload, which was an inertial upper stage and the TDRS satellite. We then had recovery support involvement down at KSC, and we kept very close with that. The photo analysis support was very important in this process in determining events and the times of those events to supplement the downlink instrumentation.

In addition, the orbiter was thoroughly reviewed. The installation process, as well as the analytical process leading to payload installation into the orbiter, was reviewed and the Goddard Space Flight Center reviewed the TDRS and the other payload aboard 51-L, the Spartan. That is the major payloads that were in the bay.

This group met—could I have the next chart, please? This group met continuously, were in session continuously, from the time of the accident. There were preestablished contingency plans in place for each one of these groups; they were implemented, particularly for the major elements, within hours following the accident, and were in session up—even prior to the formation of the task force, and then we carried forth with those. The task force was established in early March, and from that point forward—you can tell in the middle of the chart there those areas where we met with the Commission and preceding each Commission meeting, we had a very regular session with our counterparts on the Commission, called the accident analysis panel.

Now, the other major milestone within this scenario of events is the 18th of April, and that's the time that the report was prepared and submitted.

Could I have the next chart, please?

Now, proceeding into the analysis itself and the findings, first I would like to give you some very summary level findings, and then from there I will progress to describe each one of the findings and later on determine—or show to you the determination of the various failure mechanisms that caused the seal to leak.

The first finding, of course, is that the right-hand aft field joint leaked hot combustion gas, and that was from the solid rocket motor, of course. And the second event, as Mr. Germany pointed out earlier, was that that leak contacted the external tank and weakened or penetrated the hydrogen tank. The hydrogen tank then was breached by this penetration or weakening, and it then initiated the process that led to the structural breakup of the total stack.

And also in these findings, we determined that there was no other element of the STS or its payload which contributed to the cause of the accident.

Now, if I could take those one at a time, and begin with the solid rocket motor description on the right-hand chart. You will see the

solid rocket motor up at the top. It is assembled at the factory in casting segments, of which there are four. You see the forward segment, and then aft, and those segments at the factory have what are called factory joints, and they are covered over with insulation and propellant, as delivered to the launch site. At the launch site, the solid rocket motor is assembled using these four segments. And as each segment is joined, there is a field joint; and the field joint, as shown by arrows emanating from each of the three, it shows a cross section of the field joint down below that.

Mr. ROE. May I interrupt you and ask you a question, there?

Mr. THOMAS. Yes, sir.

Mr. ROE. Is the configuration and the structure of the factory joint the same material makeup, other than the sealing insulation on the outside, as would be the field joint?

Mr. THOMAS. Yes, sir.

Mr. ROE. In other words, it's still an O-ring type of configuration, but it's sealed in the factory?

Mr. THOMAS. Yes, sir.

Mr. ROE. Thank you.

Mr. THOMAS. On the left screen I've shown a colored cutaway of the field joint, and if I could start on the right-hand side of that, is the propellant in the red; the insulation in blue; and there is a liner that is shown in gray, there. The brown between the insulation is vacuum putty, and the metal parts then, are shown—the clevis, which is in orange, and the case tang, which is in purple; and the O-rings that seal those two metal parts are in green. The joint is pinned together around a given joint by 177 pins that are shown in this schematic in yellow. Those pins are held in place by a metal band that goes around the circumference of the total vehicle, holding those pins in place, and that is covered over with cork, that is shown in green. You can see the leak check port also, in a lighter brown, that is utilized to leak-check the two O-rings.

This joint configuration is the one that failed, and the failure mode was that the gas came through—our analysis is that the gas came through the putty, between the insulation. The O-rings leaked; the gas then either went down around the tang in this direction, down here, and out, and as the metal heated, up—or the hot gas exited here—the hole then became larger. Or, as the gas came down and out this area right here, and the tang was overheated, and the emanation of the hole was at that point. At any event, the hole—which I will describe to you shortly—began at this joint.

May I have the next chart, please?

This is a photograph of the recovered hardware from this particular right-hand aft field joint, and the photograph is taken looking from this direction into the—from inside out. It is the top part, here, represented by this schematic. This is the hole here, and that is what one can view here. These are the pinholes, as you can see, those pins right there, on this side and along the bottom here. The white is the insulation; this black is the propellant as it has burned forward, and this is the actual melted metal.

This is at approximately the 300 degree position on the spacecraft.

Next, please.

This is the lower half of this joint, that is, this part, depicted schematically here. This is the hole that goes from this point to this point, and that's approximately 33 inches. Again, the propellant, the insulation, and the metal. There is a secondary hole in the metal at this point that we believe occurred or penetrated very late; in fact, after the 73-second time period, due predominantly to recirculation around the external tank attach ring on the outside. It was, we feel, an outside-to-inside burn through.

May I have the next charts, please?

On the left is a sketch of the vehicle looking forward, with the right-hand solid rocket motor here, and the leak that I was just talking about from a circumferential standpoint occurred at this point right here, then contacted the external tank in this radial location, and from then forward to the dome, then exited the external tank. And that, longitudinally, is slightly around on the other side of that solid rocket motor.

Next, please.

I mentioned that we had prepared a fault tree for you earlier, and I have shown that at a very summary level on these two charts that are on the screen now. If I could just briefly explain the two screens.

This one is the total summary fault tree, as you can see. It has the orbiter, the main engine, the payload, the external tank, and the solid rocket motor. This chart on the right screen takes these two elements of the fault tree and gives you an indication of the next tier or the next level of detail that was postulated that could have caused the failure.

The color code with respect to understanding the chart, the green represents an improbable cause; the red, a probable cause; and the yellow, a possible cause. And this fault tree, we started—in fact, you start and go backward in the development of a tree and test it, then in the opposite direction. We started with the total breakup. We observed the external tank breakup, and then we postulated those things that could have caused that, the orbiter, and so forth. Then the next level down would be to determine what within, for example, the external tank could have produced that observation there, and that was damage at liftoff, premature—that is the range safety system, called a linear shaped charge—destruction, a structural flaw, or an overload could have caused structural breakup of a tank. And, in fact, we cleared all those as not being the cause of this accident.

Then one would move down to the solid rocket booster and again consider loads; consider that the integrity of the pressure vessel was violated, and it also has a range safety system aboard. And we determined that it was not at fault.

The red, then, the way one would follow this logically, is from here to here to here, and then back down, and then you get finally down to the point that we have a joint seal anomaly.

The conclusion is, then, that there were no other contributors to the accident other than the solid rocket motor, and the solid rocket motor joint leakage.

Now, what would then cause the joint to leak? And these are the factors that we determined to contribute to that leak. That is, the gap opening due to joint dynamics, and I'm going to go into these a

little bit further; but this first one, the dynamics; the joint temperature at launch, affecting both resiliency of the O-ring and the potential for ice in the joint; the joint damage and/or contamination during the assembly process; O-ring squeeze after mating—that is, as has been referred to, it's also a static O-ring compression—putty performance, which is a pressure-holding capability, also referred to as pressure actuation time; assembly blow-holes, which can produce O-ring erosion. I'd like to take each one of those individually and describe it for you.

Next chart, please.

The gap that I have reference to when I say the gap opening is as shown right here, at the upper left-hand corner of this screen. This is a cutaway of the joint. In the static condition, the joint is in this configuration, relatively straight from tang to clevis, and the O-rings are located in here and the gap is the gap between the—this land between the O-rings, the O-rings and this tang. As the motor pressurizes, the ends of the clevis and the end of the tang tend to bow in this direction. And this is—the internal pressure, of course, is on the left side of the tang and clevis. This bows out, this bows out, and you put a bending moment in the clevis which causes the tang to move away from this inner clevis leg at this point, therefore, opening up the O-ring gap. That is what has been referred to as gap opening, and also rotation of the joint.

Depicted also on the curves is time in thousandths of a second, and this is the gap opening at these points right here for the primary O-ring, which is located in this slot, and the secondary O-ring, located in this slot. And as you can see, as the motor pressure builds up with time, these gaps begin to open and open at a fast rate, between 200 and 300 milliseconds after ignition, and finally wind up with the primary O-ring gap opening as much as 27 to 29 thousandths and the secondary opening on the order of 15 to 17 thousandths. And we believe that these, in fact, have a probable influence in the cause of the accident.

Mr. BARTON. Mr. Chairman, could I ask a question there?

Mr. ROE. The gentleman is recognized.

Mr. BARTON. Is that the normal performance of those O-rings, or was that the performance during the accident?

Mr. THOMAS. I'm particularly describing the metallic part of the joint at this time, and it is normal. The O-rings in this case, which I will talk about a little bit later, in theory and in design should track that opening.

Mr. BARTON. OK, but that is a normal occurrence in the flight, right there?

Mr. THOMAS. That is.

Mr. LUJAN. Mr. Chairman, I have a quick question.

Mr. ROE. The gentleman is recognized.

Mr. LUJAN. Is the maximum pressure time—pressure from inside the tank—is that concurrent with the maximum turbulence time?

Mr. THOMAS. No, sir. The maximum pressure is immediately—right after ignition, and it drops downward as you go toward the area—or the regime—of maximum dynamic pressure. Once through that, it builds back up slightly.

Mr. LUJAN. OK. Thank you.

Mr. ROE. The gentleman will proceed.

Mr. THOMAS. The—it should be noted also that this aft joint is the—the aft joint on both sides of the vehicle—is, in fact, open less than those that are forward, and that is normal, as well. But we do conclude that this is a potential cause, in combination with the other effects, for the accident.

If I could have the next, please.

Joint temperature is, of course, a factor that must be considered. Tests show that the O-ring resiliency significantly decreases at the temperatures experienced on STS 51-L. The cold O-ring would not track the gap opening rate without pressure assist, and what I mean by that is that the pressure assist is pressure from the motor getting in the O-ring groove and forcing it to a closed position. There must be room in that O-ring groove for the pressure to enter that groove and provide the pressure assist.

On the right-hand chart, I've shown the temperatures for the two lower joints, the aft field joints, for both vehicles, both SRB's, the right and the left. The little insert up at the top shows the radial clocking on the right-hand solid rocket booster; the left—and as you can see, the right-hand solid rocket booster temperature around the periphery varied in the way that is shown here from about 30 degrees at that position; it built up as we go around between 90 and 180 degrees, and drop back down. The reason for this is—this is at time of launch, but at the time of launch, the sun angle was about from this direction, which put the sun on this side of this solid rocket motor. On the other side, it was shielded, on the left-hand side, and as you can see that was a relatively steady temperature, on the order of 30 degrees plus or minus 2 or 3 degrees.

Analysis and tests indicated also that at these temperatures, that ice could be in the joint, and that would be formed from water that penetrated the joint during a rainstorm or inclement weather while the vehicle was on the pad. And we did show by analysis that ice could be at that location within the joint, and further tests showed that if ice was there, and should it freeze, it will unseat the secondary O-ring.

I think it is needed to be pointed out that most all of the 51-L joints up the vehicle tended to follow this same temperature distribution pattern around the vehicle, although they would be slightly warmer.

So we conclude from this that the joint temperature is a probable contributor to the cause, in conjunction with other factors.

Next, please.

During the assembly process, with the tight tolerances that we must maintain, there is the potential for some damage to the O-ring or the metal, or there is the potential to create contamination that could affect the sealing performance. With respect to tightness of the tolerances at the locations that would be experienced during the 51-L, I've shown each one of the joints as they appear on the stack. The top one is the right-hand motor; the lower is the left; again, with the clocking. This location here on the right hand—as I've shown with this arrow—is the location where one would expect—either at this location or the one 180 degrees opposite—are the locations that one would expect damage during the assembly process, if it occurred because this is the location of the maximum

ovality as measured during the mating process between the two segments.

You can see that this one is the worst; the others are less than that, as you look around the other five joints. Even with this process, we looked to see if there had been metal-to-metal interference, and analytically it would appear that there is no potential for overstressing the components, should that have existed.

We also showed that by some subsystem testing, subscale testing, that contamination could be produced at that joint, but we had to work at it a great deal in order to produce that contamination.

We have had some very, very limited experience of O-ring damage in ground tests; however, we believe that to be associated with the ground test assembly process and not necessarily directly applicable to the flight motor. But in any event, it was possible to have created the contamination or damage, but we believe that with the care that was taken and with the dimensions that we actually measured, that it was improbable that contamination contributed to the 51-L accident.

Next, please.

A very important factor to be considered, particularly in conjunction with cold O-rings and their resiliency, is the squeeze—that is, the degree of compression—of the O-ring around the joint. It should be noted also that, at this location where I pointed a minute ago that the maximum potential for damage could occur, this is also the maximum point of squeeze on the aft field joint for the right-hand motor, and that is also the point where we observed the leak, around the 300-degree position around the vehicle. So we find that these conditions, with this maximum dimensions, could produce max squeeze on the O-ring.

Now, if one puts max squeeze on the O-ring, this then reduces the pressurizing volume that it might have within its groove, and as we have shown by subsystem testing, an initial gap between the O-rings and the tang of 20 thousandths, which was considered to be the nominal prior to 51-L, it would seal down to 10 degrees. And I guess I should stop now and explain my color code.

The green is that the test that we performed would pass. The yellow as that we would have some leakage, but it would finally seal, and the red indicates that the joint would not seal at all. Down the left-hand side are the temperature ranges for which we tested; across the top are the pressures reaching the O-ring at the time of ignition, and the right-hand column is that the pressure is delayed some 200 to 500 milliseconds, which is associated with putty, that is the next topic.

This is the squeeze of 4 thousandths on the O-ring. This is a nominal squeeze of 20, and if we can direct our attention to these two columns right here, it would show that with a 20 thousandths initial gap, that the joint would seal down to 25 degrees and there would be, then, the potential for some leakage, but it sealed down into this area; but it would not pass when we tested lower than zero degrees.

With an initial gap of 4 thousandths—if I could skip one line for a second—4 thousandths, which is maximum squeeze, it showed that the joint—the confident sealing of the joint was only down to about a temperature of 55 degrees, and in this 40 to 50 degree

region, there was a question of whether it would finally seal. And then below 40 degrees, it was shown by these subscale tests that it would not.

Now, these subscale tests are not finite in their discrimination, but they do give one enough information to describe the relative thresholds at which passing or failing would take place.

In order to test the squeeze theory—that is, that the tighter the squeeze, the higher the operating temperature must be—we installed some tests which I do not have shown on the right-hand chart, but showing that with a 10 thousandths gap, that it would seal down to 25 degrees, which says that the threshold is somewhere—on the squeeze—from 4 to 10 thousandths of an inch.

There is one other—

Mr. LEWIS. Mr. Chairman.

Mr. ROE. The gentleman.

Mr. LEWIS. Might I ask when this squeeze test data was obtained?

Mr. ROE. The gentleman is asking when was the squeeze test data obtained.

Mr. THOMAS. This particular data was obtained post-51-L accident. It was during the investigation process.

Mr. LEWIS. So you have nothing to compare it to prior to the investigation?

Mr. THOMAS. No, sir, we do not.

Mr. LEWIS. OK.

Mrs. MEYERS. Mr. Chairman, could I ask a question?

Mr. ROE. The gentlelady from Kansas. He's almost finished, but the gentlelady from Kansas. Go ahead.

Mrs. MEYERS. Well, in previous damage to the O-ring, because it had shown up in previous flights, had you been able to identify what was causing the trouble? Was it a squeeze or a burn or—

Mr. THOMAS. Earlier in the—those that you have reference to, I think, is the erosions and blowby earlier in the program, before 51-L?

Mrs. MEYERS. Yes.

Mr. THOMAS. Those were attributed, in every case, to a blowhole where the O-ring was eroded, to a blowhole in the putty that allowed a hot gas jet impingement or hot gas jet to impinge upon the O-ring and erode it.

Mrs. MEYERS. So that—when you talk about the squeeze problem, that is a result of the cold temperatures?

Mr. THOMAS. The squeeze, per se, is a result of the dimensions of the two mating motor cases and the mating process, how they come together.

Mrs. MEYERS. I understand that, but you had said that the squeeze was not a factor previously, and so did that have something to do with the cold temperature?

Mr. THOMAS. When I answered the previous question I did not intend to mean that it was not a factor previously, that it was not known to be a factor previously, prior to 51-L.

Mr. ROE. Well, if the gentlelady will yield now, I want to finish this because we're losing continuity. I want to finish this continuity, and then we'll have ample time to get into depth because I know—I see here that there's a series of questions that should

emerge here, and the gentledady is right on target. But I'd rather wait and put them into context or we're going to lose—we're going to be all over the lot and we're going to lose the context that I'm trying to create for the record. So if you would please bear with me, the gentleman would conclude.

Mr. Thomas.

Mr. THOMAS. Thank you.

There is one other factor in this O-ring squeeze scenario that surfaced during the investigation, and that is that the cases, the case walls and diameters, appear to grow slightly—on the order of, say, 20 to 30 thousandths after four to five uses; this was determined during the investigation process, and that must be reckoned with for the future.

The maximum squeeze is considered a probable cause, in conjunction with other factors.

Next, please.

The last factor that is considered to be in the probable category is putty performance, and tests showed the potential for putty to delay O-ring pressurization during the ignition process; however, that performance is variable. Sometimes it would delay the pressurization and sometimes it would—a hole would become in the putty, and it would pressurize immediately. This was further substantiated by the presence of blowholes in the putty prior to 51-L, and in 16 of the 138 joints. We also determined, during the investigation and the destacking of STS 61-G—which was a vehicle that was stacked after 51-L—it was found that several of the joints in the 61-G contained blowholes, which would have occurred during the assembly process, of course. Tests confirmed that delayed pressure actuation could result in failure of the seal. If it holds the pressure off by 250 to 500 milliseconds, the joint would fail at the max squeeze conditions and at the low temperatures. And that's shown in the right-hand column of the chart on the right. Again, the green is pass. If we have maximum squeeze at 55 degrees, we delay the pressure 250 to 500 milliseconds; then it will—with 4,000 squeeze, it will pass down to 55 degrees and down to about 40 degrees with nominal initial gap opening. But lower than that, the seal would not pass.

So putty performance is a variable, and it is considered in the probable category.

The last slide, please.

We could not determine that any single causing mechanisms—that is, those that we just discussed—could be discerned. The damage and contamination at mating we believe to be improbable, but it takes a combination of others to form the most probable cause of the 51-L accident, and those are the gap opening, the O-ring squeeze, the low temperature—either involving O-ring resiliency, or ice in the joint—and the variability of putty. And the conclusion was that the joint must be redesigned to eliminate the effects of these conditions.

And that is all I have, Mr. Chairman.

Mr. ROE. I want to thank the gentleman for an excellent, in-depth presentation.

I think that we again have to vote, regrettably. Is the gentledady from Kansas still here, Mrs. Meyers?

What we'll do—because you were developing a good point—what we will do is to recess again so we can keep the continuity going, recess for 10 minutes. We'll vote and return immediately, and then the Chair will defer to Mrs. Meyers to continue that process she was on in reference to the pressurization. So you'll be up first when we return.

So we'll recess for 10 minutes.

[Recess.]

Mr. ROE. The committee will reconvene. Members, I'm sure, are delayed, unfortunately, on the floor, but we're going to go on.

What I would like to do at this point, in view of Mr. Thomas' presentation, I think that there has been considerable questioning that has emerged, as you know, over the last 3 or 4 days since we've begun the hearings in the specific area of this—in the specific area which we're discussing, and I think it would be profitable for us to review four or five of the elements that people have on their mind, and be done with this part of the issue as to really what happened in the accident per se, vis-a-vis the relationship of the O-ring plus temperatures and the other areas that we have been discussing. I know we have other representatives that have further testimony to give—Dr. Thompson—but we'll take that up as we go along today.

Now, having said that, for the record I would like this question just to get it into the record for anyone who chooses to answer it. Maybe, Dr. Fletcher, you might want to direct one of your folks.

During the course of the photography that we reviewed yesterday, at 0.678 seconds, the black smoke was observed and there were seven or so puffs that followed, caused by—and then the question is, the burning of material. And now, for the record, what material do you believe was burning at the time?

Mr. THOMAS. Mr. Chairman, we believe that material that was burning was the insulation that is shown as NBR on that joint photograph, and the grease, and possibly the O-ring to some extent.

Mr. ROE. The question that follows on that answer, and that's the answer that comes from the Commission's report—given that the insulation is designed to protect the casing, how could it burn?

Mr. THOMAS. The insulation was eroding; and by eroding, it burns down a little bit and flakes off, and burns down and flakes off. And in that process, it releases it and provides the insulation.

Mr. ROE. The final question to this, for the record. Given the small volumes of the O-rings and the grease per se, how could so much smoke be produced, quantitatively?

Mr. THOMAS. I speculate, Mr. Chairman, that that was the NBR, and there are ample amounts of NBR, the insulation.

Mr. ROE. The insulation. All right.

Now, in the course of the testimony that we've had, starting with Dr. Thompson and then yourself, Mr. Thomas, filling in, the areas that were covered fundamentally which I want to concentrate on are the joint situation, the weather situation, the putty situation, and in effect, I wrote down to myself, the torque situation, meaning the change of pressure because of the dynamics of the vehicle itself on the O-ring. OK? Those are the areas that people now are beginning to want to get into in more depth so that we can lay to rest once and for all any doubts and questions—and answer any ques-

tions, hopefully—that these folks may want to ask at this point, to get upon the record. Do you understand where I'm coming from?

Now, therefore, I will defer to the ranking minority member, Mr. Lujan from New Mexico.

Mr. LUJAN. Thank you very much. Thank you.

Mr. Thomas, there is one thing in all of the readings and studies that comes to mind as something that might have happened, and I haven't heard anyone talk about it yet. My understanding is that when you begin to stack everything together, you first stand the solid rocket boosters up—you know, pointing up—then you add to that the external tank, and then you add the shuttle onto that. Is that correct, the way that it's all put together?

Mr. THOMAS. Yes.

Mr. LUJAN. I further understand that after the external tank is put on, it is then filled with the fuel. Is that correct?

Mr. THOMAS. Yes, sir.

Mr. LUJAN. And that at the time that it is filled with the fuel, it is already attached to the solid rocket boosters. When it is filled, when the external tank is filled, the coldness of the fuel makes the external tank contract. My understanding is that it's 4 inches that it contracts.

When it does that, of course, it's got to pull away from the solid rocket boosters 2 inches on each side, assuming that it's all equal. Could that contribute—because the damage was near the struts that hold the external tank and the booster together—could that pulling away, those 4 inches by contracting the external tank, have contributed to the weakening in that general area? Was that studied in the entire process that you went through?

Mr. THOMAS. Yes, sir. We revisited all of the stacking loads as the vehicle was assembled to determine if there was anything in the process that caused us to exceed our design allowable limits, and that the stack configuration, as it sat on the pad with the propellants loaded, was analyzed. And it was determined that there were no unexpected or unusual loads produced prior to the 51-L liftoff.

Mr. LUJAN. Well, but we've had the damage at that joint all the way along. My question is, is there a spring or something—if you're going to move 4 inches, something's going to give somewhere, where that strut is attached on both sides, whether that could be a contributing factor to the other 13 times that there was damage inside the joint.

Mr. THOMAS. I don't recall specifically what the shrinkage radially of the tank is, nor what it is longitudinally, but in the longitudinal direction is where it shrinks the most; that is, it gets shorter. And that is taken—the deflection there is taken into account by having the struts slightly at an angle, such that when it does shrink, they are up at the proper horizontal angle. And the preloading in the struts is accounted for in this shrinkage calculation, both radially and longitudinally. I just don't happen to recall the numbers, sir.

Mr. LUJAN. The struts aren't rigid?

Mr. THOMAS. The struts are hinged at each end.

Mr. LUJAN. So that the up and down would be compensated for with those hinges—well, I'm not sure, now, whether it's 4 inches

that it shrinks in circumference or not. My understanding was 4 inches; now, it may be from top to bottom rather than---

Mr. THOMAS. I'd be happy to provide that for the record, sir.
[Material to be supplied follows:]

Material requested for the record on page 48, line 1162 by Mr. Lujan on June 12, 1986.

The external tank (ET) shrinks in both longitudinal and radial dimensions as it is loaded with cryogenics prior to launch. The shrinkage is accounted for in the external tank to the solid rocket booster (SRB) strut configuration and design loads. The forward struts are designed for longitudinal loads and remain stationary during loading. The AFT struts are for lateral (radial) loads. They are initially at a seven degree downward angle (SRB to ET) and move to a horizontal position as the ET is loaded. The seven degree angle change is equivalent to the longitudinal shrinkage of four inches. Unconstrained ET radial shrinkage is 3/4 inch. However, due to the strut configuration and loads, the physical radial shrinkage is 3/8 inch.

Mr. LUJAN. Thank you, Mr. Chairman.

Mr. ROE. I thank the gentleman from New Mexico.

May I ask for just a clarification, again for the record. As I understand it, when the O-ring—the joint and O-ring system was originally designed, that the understanding from an engineering point of view is that upon launching of the vehicle, that the torque or the pressures that were put up—I would say torque at that point—literally help to seal the O-rings. Wasn't that the original conception in the early, original design?

Mr. THOMAS. That is my understanding.

Mr. ROE. That is what I think we heard testimony to. And then it was determined, after a point in space—you'll pardon the euphemism; a point in time—it was then determined that instead of that occurring, that those pressures that evolved during the course of launching literally pulled away from the O-ring and worked the opposite. Do you recall that discussion?

Mr. THOMAS. Yes, sir.

Mr. ROE. When was that—when was that latter phenomenon discovered?

Mr. THOMAS. I don't remember the chronological time, but it was around the time that the structural test article was tested at Marshall. It's in the late 1970's, I believe.

Mr. ROE. That's what I'm trying to get at. So it was determined, from an engineering design point of view at a given time in space in 1977 or whatever, that instead of the pressure on those O-rings working "X" way, it was just the opposite during the launch because of countervailing pressures, and it worked the opposite way? Is that a factual statement?

Mr. THOMAS. That's my understanding.

Mr. ROE. OK. I think that's important to keep in mind.

The Chair recognizes the gentlelady from Kansas, Mrs. Meyers.

Mrs. MEYERS. Thank you, Mr. Chairman.

I—several of us up here, I think, were confused about the O-ring squeeze, and I thought that when the two parts were put together, that it was actually opened wider so that then the O-ring would not fill the gap and prevent the gases from going through, and that's why I was asking the question, and was wondering whether that equipment had ever been involved before, or shown that kind of damage before.

Mr. THOMAS. Regarding your first understanding there, as the two halves are mated, the squeeze on the O-ring around the circumference of the sealing surface will vary, but not to the point that it would create a gap between the O-ring and the sealing surface. It's just a differential amount of squeeze as you go around the vehicle on the O-ring. So from that standpoint, it's not a problem during the stacking process. What turns out to be a problem is that if you have maximum squeeze on the O-ring—that is, maximum compression—in conjunction with cold temperatures, that is when the O-ring performance or the joint performance to seal degrades, because the fundamental problem with that is that you cannot get pressure behind the O-ring to actuate it to seal and the cold weather has prevented it from being resilient enough within itself to follow the opening of the gap as it rotates or as it opens during motor ignition.

Mrs. MEYERS. OK.

Was the putty part of the original design, or was that something that was added later to protect the O-ring?

Mr. THOMAS. It was in the original design, for that purpose.

Mrs. MEYERS. As I understand it, Mr. Chairman, there was a briefing last August at NASA headquarters in Washington about the O-ring problem and Morton Thiokol briefed people in Washington about the O-ring problem. Who was at that briefing?

Dr. FLETCHER. You're asking people that weren't at headquarters at the time. We may have to supply that for the record, unless somebody in the back row—can you?

Mr. THOMPSON. I believe Mike Weeks was the senior man at that meeting, and Mike is here today.

Dr. FLETCHER. Mike Weeks is here, Mr. Chairman.

Mr. ROE. Well, that's a statement of fact. Would you provide for the record who was at that meeting? I think that would be adequate.

Dr. FLETCHER. Yes, sir.

[Material to be supplied follows:]

Material Requested for the Record on Page 52, Line 1247, By Mr. Roe on June 12, 1986.

Attendees at the August 19, 1985, O-ring Briefing at NASA Headquarters:

MORTON-THIOKOL

J. E. Mason
C. C. Wiggins
J. C. Kilminster
A. J. McDonald
C. A. Speak
F. J. Ross

MSFC

L. B. Mulloy
R. Schwinghamer

HEADQUARTERS

L. M. Weeks
D. L. Winterhalter
W. H. Hamby
R. Bardos
P. F. Wetzel
P. N. Herr
H. Quong

Mr. ROE. I'm trying to stick to the technical questions, now, so that we don't lose the continuity. OK?

Mr. BARTON. Mr. Chairman, I think that is a very important question, though, about who was at the meeting and what they were told.

Mr. ROE. If the gentleman would yield, there are a plethora of important questions just to be asked. What the Chair is attempting to do at this particular session, while we have the expertise here, is to take and establish a series of factual events as to the issues involved. We've got all afternoon and days and days to expand on that. While we've got these technicians that have been flown in from all over the country, I don't want to lose the value of those technicians' knowledge; while we're asking questions that are germane, I want to deal with this issue today so that members clearly understand the technical issues so we don't have to go back and revisit it 500 times, and then we're going to get more work done.

Mrs. MEYERS. Could I ask one more technical question?

Mr. ROE. Yes, of course you can.

Mrs. MEYERS. I think it was indicated in the report that the putty may have been dislodged or may not have stayed in place because of the testing once the rocket was put together. Is that accurate?

Mr. THOMAS. After the segments are mated and they have the putty in between the joint, there is a leak check of the O-rings that is performed using the leak check port between the O-rings, which is pressurized to two pressure levels. An initial pressure is induced into this small cavity between the O-rings, of approximately 200 pounds per square inch. That is to seat the O-ring. It is dropped back down to 50 PSI and locked up and monitored to see if there is a loss of that pressure, indicating an O-ring leakage. There was a postulation that this high pressure, the 200 PSI, may have blown by the O-ring before it seated, and then been trapped by the putty, and then continued to blow through the putty, creating a blowhole prior to ignition. And we have not been able to determine whether that is fact or not. That was only a postulation.

Mrs. MEYERS. Thank you.

Mr. HENRY. Would the gentlelady yield on that point?

Mrs. MEYERS. Yes.

Mr. HENRY. Thank you.

My understanding was that as the O-ring sealing problem became more and more increasingly apparent, that the pressurization levels were increased as kind of a fail-safe check on the seals. And as you increased up to 200 pounds per inch, as a preflight readiness and inspection you may have potentially negatively affected the putty variability. Am I correct?

Mr. THOMAS. That is what the statistics show.

Mr. HENRY. So you have a counterproductive safety program, as it were. The safer you tried to make it by that means, the more likely the accident, if we understand the problem correctly.

Mr. THOMAS. Well, I think it's important to note that the higher the pressure, the more the incidence of O-ring distress. But it did not appear to make that distress on an individual O-ring, to my recollection, worse.

Mr. ROE. The Chair recognizes the gentleman from New York, Mr. Scheuer.

Mr. SCHEUER. Thank you, Mr. Chairman.

Mr. Thomas, according to the Rogers report, "Prior to the accident, neither NASA nor Thiokol fully understood the mechanism by which the joint sealing action took place." We know there were a number of early warning signals from 1983, two different warnings in 1985 up to NASA headquarters, so they had an impressive body of evidence there that things had gone awry, that there was a very real problem that needed to be addressed.

Now, I'm impressed by the report that you have assembled in the short 6 weeks since the tragic *Challenger* accident. I'm very impressed by the enormous data base that we now have about the O-rings, the faulty O-rings and the field joint behavior. I'd like to know, how much did it cost to accrue this information since *Challenger*? How much personnel did NASA assign to that? And above all, for goodness' sake, why wasn't this work done after repeated early warning signals that emanated from Marshall but did go up to NASA central headquarters on at least three occasions, as outlined in the report, so that they were alerted, they should have known. My question is, Why wasn't the remarkably fine work that you and the others have done in the last 6 weeks done before the tragic accident so that, as Admiral Truly testified yesterday—if this knowledge that you've accrued after 6 weeks of brilliant and dedicated and highly professional effort had been available to Admiral Truly and other decisionmakers before the *Challenger* launch, that launch certainly would have never taken place.

So since they had the knowledge that things had gone awry, why didn't they do over a period of several years what they've done very professionally and very successfully over a period of only a couple of weeks?

Dr. FLETCHER. Mr. Scheuer, I'd like to start that question. As you know, once an accident has occurred you can put your best talents and your large amount of resources in investigating that particular accident. Before the accident occurred, perhaps we should have been alerted, as you suggest, and—

Mr. SCHEUER. Let me interrupt you, Dr. Fletcher. It's not a question of, you should have been alerted. You were alerted.

Dr. FLETCHER. I'm sorry, I—

Mr. SCHEUER. In 1983, information came up to NASA headquarters in Washington that things had gone awry. L. Michael Weeks signed a waiver of the fail-safe requirement for the joints, and headquarters was fully informed about the lack of redundancy in the joints. Then, in July 1985, in a memorandum from Irving David, it further shows that headquarters was again alerted to the seriousness of the joint problem, and in August 1985, Michael Weeks and others at headquarters were briefed again about the repeated failures of the O-rings. So you were alerted; so this isn't just a problem of communications.

There are plenty of fingers of blame, if we are in the business of fingerpointing. There are plenty of problems with decisionmaking at Marshall, and undoubtedly they should have taken corrective action based on the information they had. But it seems to me that we cannot exculpate NASA's central headquarters from a major

share of responsibility here by saying, if they were alerted. You were alerted. Why didn't this effort, this remarkably effective and professional effort that we've done in a matter of 6 weeks—why didn't this take place in 1985? After the third warning that something was very much awry with the O-rings and the seal?

Dr. FLETCHER. Excuse me, Mr. Scheuer. I didn't mean to say, if I did, that we were not alerted. I'm just saying that maybe we should have taken that sort of intensive action at the time. And by the way, I think that your earlier statement is quite right; headquarters was at least as much to blame as other parts of the organization. I don't think all of the responsibility should reside just at the Marshall Space Flight Center, and I have said that and I think everyone else that I know has said the same thing.

Mr. SCHEUER. I'd like either you or Mr. Thomas to tell us, how much did this effort cost that was made in the last 6 weeks to accrue this remarkably impressive data base? How many people were involved in the effort? How much did it cost?

Mr. THOMPSON. Here, let me try to answer that. We've discussed that within the task force, and there's a lot—well, there's not a lot of rigor in this number, so let me just try to give you a ballpark estimate. And if you're interested, I'll try to go back—or get NASA to go back—and try to—

Mr. SCHEUER. Well, you're using up valuable time, Mr. Thompson.

Mr. THOMPSON. It's about \$5 million. About \$5 million would be my estimate to run the tests that we conducted during this investigation.

Mr. SCHEUER. During this 6 weeks?

Mr. THOMPSON. During about the 6 weeks where we maximized the test activity.

Mr. SCHEUER. How many professional and scientific people were involved in that?

Mr. THOMPSON. In the conduct of the test, in the analysis of the test?

Mr. SCHEUER. Yes.

Mr. THOMPSON. I'd say in the range of 200 people.

Mr. ROE. Would the gentleman yield for a moment?

Mr. SCHEUER. Well, of course I'd yield, Mr. Chairman, but I can't help remarking—

Mr. ROE. I'm going to give you more time later.

Mr. SCHEUER. I yield, Mr. Chairman.

Mr. ROE. I'm only trying to do something here, and I'd ask you to suspend on that because otherwise I would be breaking the continuity of my own arrangements.

What I'd like to do is to ask Mr. Scheuer to suspend for a moment because, obviously, these questions are going to lead in this direction. What I want to get on the record at this point, so we can be done with it, is there any other member here now that wants to ask a technical question on the basis of the data that we have before us? We have information that's been presented; we're not through with this, but that's the prelaunch and the other safety areas that follow. This is the heart of the technical testimony. And we've talked about the field joint; we've talked about the weather issues, the relation thereto; we've talked about the putty—

there's other questions on the putty; we've talked about the high pressure. So what I'd like to do is use this time for any member, in that order, first to get that on the record so we are done with revisiting 50 times the same question over and over and over again, and then go from there and recognize Mr. Scheuer to begin, and then from Mr. Scheuer back to the gentleman from Texas, because we started in that direction.

Mr. NELSON. I have a technical question.

Mr. ROE. The gentleman from Florida is recognized.

Mr. NELSON. OK.

Mr. THOMAS, now, there seems to be an inconsistency, and I want you all, Mr. Thompson, to straighten this up for us. We had testimony—first of all, let me start with the Commission report.

The Commission report says that one of the contributing factors was the fact that the casing of the SRB was out of round, and you all have measured this. You have measured it on a number of flights; indeed, we find that there was an out of round on 61-C, as well. And in the way that you have presented the data to us here today, the way the Commission has structured their report, that is an implication of one of the factors that contributed to the failure of the joint.

Where the inconsistency comes in is that we have had testimony or information to our staff, specifically last Thursday at the Cape from a Mr. Carver Kennedy, who says that once you mate the clevis and the tang, insert the pin, and then insert around the circumference 177 of the clips in the pins, that that actually causes a circularizing in the joint so that the implication is that you would eliminate the out of roundness once the clips are inserted in the pins.

Now, the question is, Mr. Thompson, Mr. Thomas, what is correct?

Mr. THOMAS. Mr. Nelson, I believe that the process that you just described with the installation of the pins and the insertion of the shims—

Mr. NELSON. Shims?

Mr. THOMAS. Shims.

Mr. NELSON. Are you talking about the pin? Is that one and the same?

Mr. THOMAS. No.

Mr. NELSON. The clip?

Mr. THOMAS. The clip.

Mr. NELSON. The clip? OK. You call it shim? S-H-I-M?

Mr. THOMAS. Right.

Mr. NELSON. OK.

Mr. THOMAS. When you put those in, that tends to round it, but it cannot go all the way because those shims are of a constant thickness all the way around, and they are not sized to take up the total amount of gap around the periphery of the vehicle. So it tends to round it, but it can never go all the way toward the rounding process.

Mr. PACKARD. Would the gentleman yield on that specific point?

Mr. NELSON. Yes, I will. I want to—before I lose this, I want to make sure that the measurements that you gave us at the cape last Friday, as well as today that you've repeated, where you show the

differences in the roundness on the different segments, and you show that in the diagram of the circumference—you measured that out of roundness before you put the shims in, before you put the pins and the shims in. Is that correct?

Mr. THOMAS. Before we mated.

Mr. NELSON. OK. So conceivably the shims then, as you just stated, will cause more circularizing or rounding, once you put them in. Is that correct?

Mr. THOMAS. Yes, sir. To a degree, it is going in the right direction, toward rounding.

Mr. NELSON. OK. All right.

Are you saying that by the putting in of the shims in the pins, that it does not completely correct the out of round condition?

Mr. THOMAS. Yes, sir.

Mr. NELSON. How do you know that?

Mr. THOMAS. Because dimensionally, the width of the gap of the clevis plus the width of the tang in the clevis plus the dimensional tolerance variations around the gap, around the circumference, in addition to the thickness of the shim, do not present a total, even thickness of tang, O-ring, and shim equal to the width of the clevis. There is what I call a "rattle space" in there, a small space for the tang to move back and forth. And the thickness of the shim is thirty-two thousandths, plus or minus a couple of thousandths—

Mr. NELSON. I thought the shim was an eighth of an inch thick. It's not?

Mr. THOMAS. No, sir.

Mr. PACKARD. Would the gentleman yield?

Mr. NELSON. Thirty-two one-thousandths?

Mr. THOMAS. Thirty-two thousandths. That's this small clip I'm pointing to right here; it's thirty-two thousandths.

Mr. NELSON. That's thirty-two one-thousandths of an inch thick?

Mr. THOMAS. Yes, sir.

Mr. NELSON. So let me then summarize, and I'll yield to the gentleman.

What you're saying is that when you put 177 shims in 177 pins around the circumference of the SRB segment, that it helps solve the problem of out of roundness, but it does not completely solve it and it very well may be that you'll still have metal on metal—

Mr. THOMAS. Yes, sir.

Mr. NELSON [continued]. Caused by the out of roundness of the casing?

Mr. THOMAS. Yes, sir.

Mr. NELSON. Is that a fair summary?

Mr. THOMAS. Yes, sir.

Mr. NELSON. I yield.

Mr. ROE. The gentleman from California.

Mr. PACKARD. I thank the gentleman for yielding.

To followup, at the same time that the shims do correct as much of the out of roundness as it is capable of doing, it creates at the same time a strain on the joint, in the metal of the joint, does it not?

Mr. THOMAS. Not perceptively. It compresses where it—

Mr. PACKARD. Well, anytime that you correct an out of roundness you are creating some strain on the metal that is out of round, when you move it toward roundness.

Mr. THOMAS. Yes, sir. And that—it does produce that, but it's not of a great magnitude. That's the only point I was making.

Mr. PACKARD. And that pressure between the metals—and sometimes, where it even gets to metal-to-metal—is what we have been shown to be this squeeze problem, create the squeeze problem; and particularly, coupled with cold weather, that the O-rings have not the resiliency to return back to reseal when there is that squeeze as a result of the out of roundness or the stress of metal to metal.

Mr. THOMAS. It's the out of roundness.

Mr. PACKARD. Is the strain at the O-ring point, or is the strain at other points in that effort to correct the out of roundness?

Mr. THOMAS. The only strain that one might see—and I think, again, it's imperceptible—is the amount of strain that you might put into the motor case wall by having it flexed slightly to install the shim. The predominant squeeze that is put into place is squeezing of the O-ring, which does not induce any stress at all into the tang or clevis.

Mr. PACKARD. In the design of the O-ring under these very conditions, where we're trying to mate the two parts together, and if there is strain or if there is the creating of a roundness in the mating process with the shims, is there movement of the O-ring in there as that takes place, as the seating takes place, so that if there is strain, that the O-ring has the capacity to adapt itself to that strain?

Mr. THOMAS. The O-rings are, of course, elastomeric material themselves, and they have good strain capability. But more importantly is, they are completely covered with grease, and that grease will allow the O-rings to move as—

Mr. PACKARD. So in the groove that the O-ring is placed in, it can slide in that groove rather freely? It is not kind of pressed in there and locked in, into a single position, without the flexibility of movement?

Mr. THOMAS. Yes, sir.

Mr. PACKARD. I thank the gentleman for yielding.

Mr. ROE. All of that notwithstanding, the state of the art, as you expressed it so well, it still is moveable?

Mr. NELSON. Mr. Chairman, I'm not through yet.

Mr. ROE. Just a moment. The gentleman from Texas has a question, but I believe that—are you finished yet? The gentleman from Florida?

Mr. NELSON. No, sir; I had yielded.

Mr. ROE. Oh, OK. Well, the gentleman from Florida is recognized.

Mr. NELSON. I just want to get some additional clarification on this.

Since you have told us that the measurements that were reported in this handout—that's not the one. There's a chart like that someplace where you've got each of the segments, and you've got the gap. And if I recall, in some it was four one-thousandths of an inch; in others, it is twenty-one thousandths. Is that correct?

Mr. THOMAS. Yes, sir; I think.

Mr. NELSON. All right. But you said that is a measurement before you put the pins and the shims in?

Mr. THOMAS. Right.

Mr. NELSON. Since we're concerned with the gap at the time of ignition—which is, in fact, once the pins and the shims are in—where do you have that kind of calculation? What is the gap then, in inches?

Mr. THOMAS. We could not tell precisely what the gap was at the ignition point of 51-L. What we did during the investigation process was destack STS-61-G. And our intent there was, No. 1, we knew what the measurements were as we stacked the vehicle; and then, before we began the destacking process and during the destacking process, we made several hundred measurements of all of the joints on the vehicle. And what our intent was, was to determine, No. 1, were we inducing any strange or unusual stresses into the clevis legs or other parts of the joint? And more importantly, could we predict where this maximum squeeze might take place?

On the left hand, I believe, is the one we spent so much time on—on the left hand, we determined that there was, in fact, some maximum squeeze, almost metal-to-metal, on that joint as would have been predicted based on the pre-mated measurement. But what surprised us a little bit is that we could not precisely pinpoint its location circumferentially. It was dislocated 90 degrees from where we would have thought it would have been.

Mr. NELSON. And in measurement of inches, what was that gap where you called it the maximum squeeze?

Mr. THOMAS. About a thousandth of an inch.

Mr. NELSON. About one one-thousandth of an inch. And you interpolate from what you measured on 61-G, when you destacked—you interpolate that to 51-L?

Mr. THOMAS. We think there was the same type phenomena there.

Mr. NELSON. OK.

Thank you, Mr. Chairman.

Mr. ROE. The gentleman from Texas.

Mr. BARTON. Thank you, Mr. Chairman.

Mr. ROE. These are technical questions. This is the last technical question before the Chair recognizes the gentleman from New York.

Mr. BARTON. No, my question is not a technical question, Mr. Chairman.

Mr. ROE. No, no. This gentleman from Texas. Mr. Andrews. I beg your pardon.

Mr. ANDREWS. I accept. My question is technical.

On June 11, the committee submitted some written questions to NASA. One of those, I'd like to ask the group, if you would expand on it a little bit for us.

The question was, "Was there a qualification test call-out in the design specs for the solid rocket booster joints?" Your answer was, "There were no qualification test call-outs in the design specs for the joint per se. There are, however, design specs and verification requirements for the performance of pressure seals and the structural elements."

Now, I guess the question is, were there any qualification specifications for the joint seals? Yes or no?

Mr. THOMPSON. I did not pursue that particular question during the analysis process.

Mr. ANDREWS. Well, can you answer that question?

Mr. THOMPSON. We're going to cover that a little later in Jack Lee's discussion. But in the qualification tests of the assembled motor, obviously that thing—after the firing in the inspection, then you should pick up any anomalies in that area at those joints.

Mr. ANDREWS. All right.

Mr. THOMPSON. Now, specifically what was done in the joint area relative to the qualification, I believe that that's probably going to be covered in Jack's discussion in terms of what the specification calls for, what was done by test, and what was then augmented by additional analysis. So I believe if you can wait on that, we'll get to it.

Mr. ANDREWS. I'll be glad to wait to expand on it, but do you know the answer to the question? Is the answer yes, or is it no?

Mr. THOMPSON. Were there specific qual tests done on the joint? I'm not aware of them at a large scale—you know, at the full motor scale, no. To my knowledge there were not.

Mr. ANDREWS. So your answer is no.

Mr. THOMPSON. Well, let's just take a minute and let Jack come up and directly answer it.

Mr. ANDREWS. Thank you.

Mr. LEE. Would you repeat the question exactly?

Mr. ANDREWS. We submitted a written question on June 11. The question was, "Was there a qualification test call-out in the design specs for the solid rocket booster joint?"

Mr. LEE. OK. The answer to that question is, in the design spec there is not a specific qualification test requirement for the joint. However, there is a requirement for certifying that the joint meets certain specifications. You do this in a number of different ways—qualification tests; you may do it by similarity; you may do it by development tests, or analyses. So there is a requirement for certification of that joint, and this joint was in fact certified to those requirements, with some qualifications.

Mr. ANDREWS. Well, just to be sure I understand. If you had a motor here—you're suggesting that there was a test made of the entire motor; but that in terms of the joint itself, the critical joint, no tests?

Mr. LEE. There was no qualification test. There were a number of special tests and development tests associated with the joint, but not associated with the full qualification—the qualification to cover the full regime of all requirements. There were a number of tests performed, either in development, qualification, and special tests.

Mr. VOLKMER. Would the gentleman yield on that?

Mr. ANDREWS. I'd be happy to yield.

Mr. VOLKMER. Could you furnish the committee copies of all documentation of the qualifications for the joint?

Mr. LEE. Yes, sir.

Mr. VOLKMER. And the criteria and certification?

Mr. LEE. Yes, sir.

Mr. VOLKMER. We'd like to have those.

Mr. LEE. Yes, sir.

Mr. VOLKMER. Thank you.

[Material available from committee files.]

Mr. ANDREWS. Thank you, Mr. Chairman.

Mr. ROE. All right; we'll have that file for the record.

Now we have just one—

Mr. PACKARD. Mr. Chairman, are you still on technical questions?

Mr. ROE. If the members would give the Chair a chance, they have all been given ample opportunity to be heard, and I will get to the next witness. Yes, we're still on technical questions. What I'm trying to do now is seal off the technical questions so we can go on and start from there on the processes that were handled.

Now that the gentleman from Texas has concluded, the Chair will now recognize the gentleman from Utah, Mr. Monson, who has a technical question he'd like to ask.

Mr. MONSON. Thank you, Mr. Chairman.

With regard to the field joint temperature, do you have a specified limit as to what that can be before launch is allowed to go forward?

Mr. THOMAS. Yes, that's my understanding.

Mr. MONSON. It's a calculated temperature? It's not a temperature that is taken through some mechanical means?

Mr. THOMAS. For STS-51-L, those temperatures are calculated, placed on an ambient measured value.

Mr. MONSON. Obviously, those limits were not exceeded on that flight, then?

Mr. THOMAS. To my knowledge, the calculated limits—or the ambient conditions—were used for the launch process.

Mr. MONSON. Now, the chart indicates that, at the location of the leak, the temperature was somewhat less than 30 degrees; I don't know how to interpolate it exactly, but it's my understanding it was to be qualified to fly at 31 degrees. Is that correct?

Mr. THOMAS. Pardon me just a second.

Admiral TRULY. Mr. Chairman, while we are getting the answer to that question, I thought it might help to point out that the reason—the conversation between the two gentlemen who were head of the task teams was the way we organized the investigation. Mr. Thomas' team was to determine the cause of the accident, and Mr. Jack Lee's team was to get into the development and the production; in other words, the requirements and the certifications and so forth.

Mr. ROE. I understand that, but we're bound to have a little overlapping so that we can get on with it, to a point.

Now, are you finished, Mr. Monson?

Mr. MONSON. I need my answer.

Mr. THOMAS. It's 26 degrees.

Mr. MONSON. It's 26 degrees?

Mr. THOMAS. That's the specification value, and the—

Mr. MONSON. And the chart indicates it was somewhat very close to that.

Mr. THOMAS. The calculated values at the joints were approximately 28 degrees, thereabouts.

Mr. MONSON. Now, you also indicated earlier that you've discovered that the casings expand after flights, and I assume that they don't return to their original size; is that correct?

Mr. THOMAS. That is correct.

Mr. MONSON. Does that in any way indicate that you will not get as many flights out of these casings as you originally thought you might get?

Mr. THOMAS. We don't believe that to be the case right now. We think that this growth that I have described is a function of the proof pressure testing; that is, bringing the motor up to the maximum—in excess of the maximum—expected operating pressure right after the manufacturing process to screen out flaws. In doing that, we think that after approximately the first three to four proof cycles, that the growth will cease to exist, and then they can be used as usual throughout their normal life.

Mr. MONSON. You don't have any experience in that area, though, yet? Is that correct?

Mr. THOMAS. We have not completely resolved that issue.

Mr. MONSON. Thank you.

Thank you, Mr. Chairman.

Mr. ROE. The gentleman from—I'll give the gentleman from California an opportunity in a moment, but Mr. Lujan from New Mexico, please.

Mr. LUJAN. I am confused as to what Mr. Lee's answer was. My understanding—and part of your briefing will show qualifications not accomplished to the required spec limits—my understanding was that there was no analysis made on the effects of temperature on that joint, that Thiokol was supposed to do an analysis but that when you went back and checked all the data, you found that that analysis had not been made.

Now, did I understand your answer just a little bit ago to Mr. Andrews that that analysis had been made?

Mr. THOMAS. Sir, could I defer that until Mr. Lee comes up, immediately following me?

Mr. LUJAN. Well, he's answered the question, and apparently it is completely different than my understanding is.

Mr. ROE. The Chair would ask Mr. Lee to come up here now because if this is in limbo, let's get it squared away right now.

Mr. LEE. OK. Let me go through a little more explanation. I understand some of the confusion here.

There is a requirement on Thiokol in the contract, in the specification, to certify—design and certify—the joint to a number of requirements. Now, to certify, you can do that by qualification testing, development testing, special testing, or by analyses. In the case of the seal joint per se, the requirement to certify, if you will, the joint to the full range of specification requirements imposed on them—and this is by a Johnson Space Flight Center document which is imposed on all of our contractors—it's around a natural and induced environment. The natural environment requirement ranges from 31 degrees Fahrenheit to 99 degrees Fahrenheit. The induced environment, which means after you've got the external tank loaded and so forth—this can range, under those same environmental conditions, from 26 degrees Fahrenheit to 120 degrees Fahrenheit.

Now, in reviewing this process with Thiokol, they did not interpret these requirements, either the induced requirements or the environmental requirements, to mean for vertical flight. They interpreted these requirements to be in a storage configuration.

And then to take it one step further, in reviewing how they satisfied all of their requirements relative to performance, sealing capability, and so forth, we found that an overall performance of this joint was required to be demonstrated by qualification tests, by development tests, and by flight tests. That requirement was associated with a temperature of 40 degrees to 90 degrees mean bulk temperature of the propellant from sea level to 200,000 feet. That's an overall system requirement; we didn't take issue with that. There's a requirement for the sealing capability—and by the way, they did, in fact, qualify these; they did it with about six demonstration motors, full scale motors, and three or four qualification motors, and the lowest temperature of any of those was, I believe, 36 degrees.

Another requirement for verification of this seal was associated with the sealing capability of the O-rings themselves, and this requirement did not impose a temperature limitation, if you will, but was more to demonstrate that the O-rings did, in fact seal; they were redundant; and that they had a leak test port to be able to verify, from an acceptance standpoint, the integrity of these seals.

The third part of this systems specification, if you will, has to do with the imposition of the natural and induced environments, the 31 to 99 and the 26 to 120. This was specified to be accomplished by analyses. Now, the contractor proposed that, Thiokol, and the Marshall Space Flight Center accepted that. The issue comes in on the fact that they did not interpret that to be an in-flight requirement. They did not do a detailed analysis or test to verify that during the flight regime. There was, in fact, analysis done that turned out to be, in hindsight and in light of the issue of the lack of understanding of the joint and the temperature issue and so forth—the analysis that was performed was not adequate, and I think the Commission report points that out; not specifically about this issue, but the inadequacy of the overall certification and qualification program.

The analysis that was in fact performed was the review and insurance, by inspection, that the O-ring—the O-ring material itself—met a certain MILSPEC, and I have that number but a certain MILSPEC. The significant part of that MILSPEC is that it should meet—be able to be usable from a temperature range of minus 30 to 500. And on that basis, they considered that analysis to be—that is part of an analysis which should, in fact, qualify or certify that particular joint.

So the issue here—I mean, if you want to look at the uncertainty of why this issue was brought up relative to the qualification, is that in light of today's understanding, that was not adequate and the fact that the Thiokol Corporation misinterpreted or did not interpret that range as NASA did.

Mr. LUJAN. Mr. Chairman, you're pushing me—and that's fine—so we can move on ahead, but we'll pursue that this afternoon, I guess.

Mr. ROE. I would suggest the following. We're getting out of kilter here a little bit. We've had a good continuity and want to

keep continuity. I knew this was going to happen, and part of the question was, when? There are obviously other technical questions that other members wish to ask, and the Chair is going to recognize all of them in due course, and I want to assure each member that his interest or her interest is respected. It is almost 12:30 and, as I promised I'm going to do, I'm going to defer now to my good friend from New York, Mr. Scheuer. When Mr. Scheuer is concluded, we will break from our hearing, return at 1:30. If Mr. Scheuer needs additional time at 1:30, he will be up, No. 1. If he wants to suspend and wait for other members to bring more of the technical matters out, that's what we'll do.

And the second point, as far as our witnesses are concerned, we would then defer to Mr. Lee because I see it's now important to bring in your next phase because it's overlapping, and I think that's—in fact, I don't think—that is the direction that we will follow.

The Chair now recognizes the distinguished gentleman from New York who has been eminently patient, the distinguished Mr. Scheuer.

Mr. SCHEUER. Well, thank you, Mr. Chairman. I must confess that I have a sense of abiding inferiority in not being able to cope with all these technical and scientific questions.

Mr. ROE. But the redeeming factor is, you have the floor. [Laughter.]

Mr. SCHEUER. Well, I've never been very good at science or math; as a matter of fact, I have to take my shoes and socks off if I want to count to 20. But here we are, and let's get back to some of the policy questions we have been wrestling with.

I think we were discussing a few minutes ago that since the accident 18 weeks ago, and since the task force on the O-rings was set up, over a 6-week period we spent about \$5 million, and about 200 scientific and technical personnel produced this extremely impressive body of evidence that we now have that really answers an awful lot of questions about the O-rings and the failure to achieve adequate sealing. Is that more or less what we've decided?

Mr. THOMPSON. Yes. That was my estimate, in terms of the resources—

Mr. SCHEUER. Very good. And I think the record also was clear, and I think Admiral Truly testified to this yesterday, and without putting words in your mouth I would assume you all agree that if we knew before the launch what we know now, after this expenditure of \$5 million that was put together—this technical knowledge base by 200 scientific and technical people, that there never would have been that tragic launch, OK?

Now, what I'd like to ask is—the perfectly predictable follow-up to this, after the repeated warnings of maybe 14 or 15 failures of the O-ring on a number of flights, and after these three warnings in February or March of 1983 and in July of 1985 and in August of 1985, warnings that went right up to NASA's nerve center in Washington, how much in the way of resources, both funding and personnel, did you apply to solving the perfectly self-evident problems of the seal and the O-rings before launch?

Dr. FLETCHER. Mr. Scheuer, I'd like to start out again on that one, even though I wasn't here. I think we want to differentiate be-

tween dollars and numbers of people, and the quality of people. Yesterday we talked about the new giants in NASA; the folks that are here today are those new giants. Admiral Truly has picked people from all over NASA to do this investigation, and these are truly unusual people.

Mr. SCHEUER. With all respect, Doctor——

Dr. FLETCHER. Answering your questions, sir——

Mr. SCHEUER. Yes, let's get to the specific answers.

Dr. FLETCHER. I think we very likely should have, with all those alerting signals, put that kind of talent, because it was available——

Mr. SCHEUER. Well, I'm asking a simple question. I'm asking how much in the way of funding and how much in the way of personnel, scientific and technical personnel, was applied to develop specific answers to the problems of the failed O-ring that had appeared on a dozen or more launches, information about which was conveyed at least three times to NASA headquarters in Washington? What was the specific response to that in terms of funding to find the answers and application of scientific and technical personnel? How much? How many people? How many dollars?

Dr. FLETCHER. Well, if we don't have anybody here that can answer the question we can supply it for the record.

Mr. SCHEUER. Well, now, Dr. Fletcher, with respect, you weren't there and these people were there. Why don't we give them a chance to answer it?

Dr. FLETCHER. Right.

Mr. THOMPSON. Well, there was one of the four of us here.

Mr. ROE. Mr. Thomas, it looks like the bee is on you.

Mr. THOMAS. As I understand the question, sir, you are asking after the period in mid-1985 when the presentation was made to headquarters on the seriousness of the seal situation, how many resources were applied between then and January on trying to fix the seal?

Mr. SCHEUER. You had a big fat question mark that was articulated on three different occasions, warnings coming from Marshall to NASA Headquarters in Washington—in early 1983, in July 1985, and in August 1985—that described at least a dozen failures of the O-ring. Now, what did you apply in the way of resources, both in trained scientific and technical personnel and in dollars, to remediate that problem before the tragic launch 18 weeks ago?

Mr. THOMAS. I'm sorry, sir. I think we're going to have to present that for the record because the people who have to provide that are not in the room today.

Mr. SCHEUER. Well, Mr. Chairman, I would request that the people who have that information be requested to testify——

Mr. ROE. Well, in view—I think that the gentleman makes a very valid point. In view of the fact that we're going to break shortly, is there a possibility that you could contact some of your folks and maybe put something together for this afternoon?

Dr. FLETCHER. We'll do our best, Mr. Chairman, between the lunch hour.

Mr. SCHEUER. I would just like to make one more comment. Apparently there was a redesign task force on the O-rings at Morton Thiokol.

Admiral TRULY. Yes, sir; I understand there was.

Mr. SCHEUER. I want to know what they had in the way of funding and what they were able to put together in the way of trained manpower, scientific and technical manpower, to address this life-threatening problem of the O-rings and the joints between the three warnings culminating in July of 1985 and August of 1985, between that point in time and the time that this tragic launch took place. What kind of resources were made available to Morton Thiokol, either out of their own funding or out of separate—perhaps emergency—funding of some kind, discretionary funding of some kind, to remediate this problem? And I have to just pinpoint that, footnote that by saying that you really have achieved a notable knowledge base in the 6 weeks that you worked on the problem with insignificant resources. I don't know how you would quantify the cost to the American public of this tragic disaster. Leaving aside the acute pain that we've all suffered from the loss of those seven noble, great Americans, but just looking at it financially, as against the \$5 million cost of preventing it, the *Challenger*—the hardware itself cost \$3 billion or \$4 billion, and if you crank into the computer the additional cost to the public and to NASA, the delay in the program, the upset, the loss of morale, all of these intangibles, you would probably come out to \$5 billion or \$6 billion. So you're talking about what would have been a cost benefit calculus of 1 to 1,000. If you had spent that \$5 million before, you would have saved \$5 billion afterward and, of course, those seven great lives.

So you can see the point that I'm getting to. Why didn't we spend this \$5 million and why didn't we have these 200 scientific and technical people assigned to this problem after the ample and repeated warnings that NASA central headquarters had, up to and including July and August of 1985? What went wrong? What went wrong, and why didn't we make this remedial effort before the launch instead of having this excellent scientific attack on the problem that was perfectly self-evident before the launch after the tragic event, after the horse had fled the stable? And this is the information that I would like you to get us this afternoon.

Mr. ROE. All right. Well, we will defer that to this afternoon.

I'd like to put just one more technical question on the table before we break, again for continuity.

We mentioned, Mr. Thomas, relative to the burning of the NRB insulation from NASA's drawings, the insulation is in contact with the burning propellant. What evidence is there from previous flight exhaust gasses that the insulation burns? Is there any?

Mr. THOMAS. From the past static motor tests, I would presume there to be none. But from lab tests which we conducted during the investigation to determine the materials that were present in the joint, which one of those would burn and which one would produce black smoke, the NRB and the grease are the ones that produced black smoke.

Mr. ROE. So that's been ascertained since you've done your investigation?

Mr. THOMAS. Yes, sir.

Mr. ROE. OK.

The Chair now calls for a recess. We will return at 1:30, and may I suggest to members, please be here on time if you will, because we are going to begin immediately at 1:30, and we'll begin with Mr. Lee and your presentation at 1:30.

[Whereupon, at 12:20 p.m., the committee recessed, to reconvene at 1:30 p.m., the same day.]

AFTERNOON SESSION

Mr. ROE. The committee will reconvene, and as announced this morning by the Chair, our afternoon session will be devoted initially to a presentation by Mr. Jack Lee of NASA, followed up by Mr. Holloway of NASA and then Mr. Utsman from NASA, which brings then into clear focus the items and the areas of expertise and study that the different task forces have carried out in their review of the accident and other peripheral data.

Having said that, the Chair recognizes the distinguished gentleman, Mr. Jack Lee, from NASA.

Mr. LEE. Thank you, Mr. Chairman, and members of the committee.

Could I have the first Vu-Graph, please? The second?

With your permission, sir, I'd like to follow the agenda as displayed on the screen.

Mr. ROE. Well, wait until we get the lights out, somebody around here. And I think it would be helpful, Mr. Lee, if you would pull your microphone closer, please.

Mr. LEE. Yes, sir.

First, by introduction, I would like to give the organization which we used in accomplishing this effort, and the review schedule which we used during the process, then a little on the review approach for our team. And then I would like, by way of indicating the findings, I would like to present the significant findings of this team. We did not make recommendations; we came to the findings.

Next Vu-Graph, please.

The Commission members on our team were made up of Mr. Joe Sutter, who was the lead for the Commission; he is from the Boeing Aircraft Co.; Dr. Arthur Walker from Stanford University; Mr. Robert Rummel, who is now consulting and has been an executive with TWA; Dr. Gene Covert from MIT; and Mr. Al Wheelon from Hughes Aircraft.

Could I have the next Vu-Graph, please.

By the way, in way of support to me in supporting this team, I utilized primarily a small staff within the agency plus predominantly the project offices within the Marshall Center and the Johnson Space Center.

The contractor visits—by the way, the approach we took was to visit each of the contractors to accomplish our mission, plus a visit at the Marshall Space Flight Center and the Johnson Center. On the 5th of March we had an introductory session at Johnson, primarily to familiarize the Commission team with the overall requirements, the level 2 system requirements as imposed on the shuttle program, and how they are divided to be introduced into each of the elements of the shuttle, the elements being the orbiter,

the external tank, the shuttle main engine, and the solid rocket boosters.

We started our contractor visits first with Thiokol and we were there on March 17 and 18. We were at Rocketdyne, the developer of the shuttle main engine, on April 2 and 3. We were at Rockwell on the 3d and 4th of April, primarily to discuss the orbiter; then at Marshall Space Flight Center, where we reviewed a number of specific questions that had been posed to us in advance by the Commission team members, and to review the solid rocket booster portion of the—the solid rocket booster, if you will. To distinguish between the solid rocket motor and the solid rocket booster, the motor is, per se, the propulsion system; the solid rocket booster includes the recovery system, the avionics, the thrust vector control system, and that sort.

On April 8 and 9 we visited the Martin Marietta Corp. near New Orleans, and that was for the external tank.

The review approach we took since we were primarily interested in looking at the production and development aspects—next slide, please—we were specifically looking at the production and development aspects of the shuttle in its entirety, as that effort relates to—could have been related to the accident. You have to recognize that we were performing this somewhat in parallel with the analysis effort, and it was not—the conclusions that Mr. Thomas presented earlier were not available to us at that time. We did this in parallel, so what we were looking at is specifically the concept or the approach to establishing design requirements, how these requirements were controlled, the review process, the certification of those requirements, the development and qualification—the development meaning component and subsystem testing as opposed to—and verifying design parameters, if you will, as opposed to qualification of an entire system to meet specifications. This also included the transportation mode, since the solid rocket motor segments are produced in Utah and they have to be transported across the country by rail to the launch site at the cape. Not only the transportation mode, but how this transportation mode was verified.

We looked into the design and production controls, the manufacturing aspects of these elements. In addition, we looked at the launch services, how the development contractor becomes involved with the launch activities, if you will, in overseeing his hardware and introducing requirements and ensuring that the tests and acceptance and checkout requirements at the cape, in fact, are met.

One of the areas that we knew that we were concerned about at the time we started in March was the critical items list. We reviewed the—CIL, by the way, is critical items list; FMEA is failure modes and effects analysis, and hazard analysis is, in fact, hazard analysis.

Our intent here was to understand and to recognize and to comment on, if necessary, the process through which these failure modes and effects analyses were generated, how they related to the identification of a critical item, and what category of critical item it was; and then, how that dealt with the hazard analysis.

The last item was in response to a number of specific questions that were, in fact, submitted to us in advance of the start of this process.

Could I have the next Vu-Graph, please.

We knew—we'll start now with the significant findings, and with the solid rocket motor in particular. These were findings that resulted from our review at the Thiokol Chemical Corp.—Wasatch.

We know, of course, by March that the solid rocket motor was pretty well implicated in the accident, and we were in fact aware of a lot of things that had gone on by that time, recognizing that failure analysis had been proceeding for about 2 months before this. So we were aware of the fact that the solid rocket motor was very much involved, so we did in fact—and we knew, by the way, that it was pretty well isolated; it could be isolated to the joint area. We thought that that was the case.

So by having that fact and recognizing that our charter to look into the design and development or production and development aspects of the solid rocket motor—we were more thorough in reviewing not only their whole process from the development standpoint, but specifically, we focused on the solid rocket motor joint. So we took as examples, to verify or to prove the approach to the development process, we took as examples how they dealt with the joint from a qualification/certification/verification standpoint. So we were, in fact, more specific in that area, as you might expect.

The significant findings with the solid rocket motor at Thiokol—the first one has to do with the subject we discussed this morning, and it has to do with the qualification of the motor. The qualification testing was not accomplished to the required specifications. And I gave you—I attempted to give you—an explanation of the process, from the requirements introduction by specification, the method, the areas that require certification, and the method to be utilized for that certification this morning.

Maybe if I can give one more example it will help clarify this thing.

In the—classically, the best thing we could do to ensure that that entire motor was qualified, completely qualified to all environments, would have been to encase it with an environmental chamber, if you will, taken it to the lowest possible temperature that had been established, and introduce as we fire the actual loads, lift-off loads, if you will. And that would then—if we accomplished that full-scale testing, that would in fact have qualified-tested the entire motor, including the joint.

Now, the way we did this, because we didn't have an environmental chamber and we did not determine it to be necessary to have an environmental chamber, we qualified the motor to the environments that were available to us. And by the way, this did range from some 40 degrees to close to 90 degrees, so we were in the area of most concern; that is, the mean-bulk temperature requirements. We did—in that same logic, in order to be able to certify that the joints did meet the requirements, we chose to do that by analysis, and I explained that this morning. We chose to perform that analysis, and in that analysis we used the specification for the O-ring, which does specify it can be used from a range of minus 30 degrees Fahrenheit to 500 degrees.

Now, the reason that issue was brought up is that in today's environment, the thing was not qualified-tested to that full range, as I explained. And based on the interpretation of the specification by

Morton Thiokol, enough effort, I would say, did not go into completing this complete verification by analysis. And again, in hindsight, you would say that our selection process—and that would be NASA's involvement here, too—the selection process for that analysis was somewhat inadequate.

The next point is the adequacy of the O-ring process and quality control. Now, we did not find in our investigation, nor did Mr. Thomas find in his analysis investigation, that the O-rings used in this flight were in fact not acceptable or were not of good quality control, nor that they were not properly processed. But in our reviewing in detail this process, we found it had not been identified as a critical process, which we believed it should, and there were a number of things and areas that we believe could be changed to give a better assurance that in the future that O-ring did, in fact, get processed properly and that there was no way that you could have a quality escape, if you will. And again, I would like to remind you that we did not find anyplace where we had an improperly processed O-ring; but the process itself—and we felt we had that charter to look to that—and so we did, in fact, believe—or I'm not sure that's the particular recommendation that came out, but we did feel strongly that that process should be beefed up.

The next point, it is questionable whether the horizontal hot fire testing compromises flight simulation. Now, we knew of this possible concern on the part of Mr. Sutter's team, so we had started—a month or so ago—a pretty detailed evaluation of the merit or requirements, if you will, first of whether the solid rocket motors should be fired in the vertical or the horizontal; and in doing so, we are assessing facilities available around the country. We are looking at the requirements which we are trying to impose on ourselves to ensure that the motor is properly qualified, and we are weighting these to determine which we believe would be the proper route to go. Once we complete this, we will make this information available to Admiral Truly who, in turn, will make a decision on that part of the future testing of the solid rocket motor.

The next item is in somewhat the same category, but it's a little different. There's a difference—there was, in fact, a potential difference between the certification testing and the flight configuration. And specifically, what happened here is when the motor is installed in the vertical, there is some adjustments, or changes, if you will, in the famous putty configuration. It tends to not assume the same shape necessarily that it would when the vehicle is stacked in the vertical. And by this, we mean that when we're ready to static test the motor, it would not be in the same configuration we assumed it would be in the vertical. So there was some adjustments, if you will, some tamping of the putty, some fixing of the configuration which we believe could, in fact, make a difference in the results of the static test.

The fourth item is in case reuse. Now, we did not find this only with this production and development team; we had the benefit of some of Mr. Thomas' earlier analyses. And the situation which exists here is, by going back to remeasuring cases which had been reused—now, these are the solid rocket motor cases; you remember that once we fire these, we bring the solid rocket motor back in, and as part of the refurbishment we clean the motors out and we

recast, if you will, the propellant. We found, in measuring some of these reused cases, that the dimensions had changed. Now, this was somewhat of a surprise to us because it was not anticipated or understood that this should have happened during the reuse. Our understanding of the characteristics of the material, the way it was processed, should not have allowed this change in dimension.

Now, let me quickly say that in Mr. Thomas' analysis and our understanding of this dimensional change, there is no indication that the reuse of the—the possible growth of cases due to reuse had an effect on 51-L, but it was characteristic of the change in the cases and it's something that was of surprise to us or change to us, and we recognized that we had to make the determination.

We think we understand this and it is being properly analyzed now, and I have no doubt that we will solve that problem of the lack of understanding of case reuse.

The next point is inadequate understanding of the field joint operation as designed. We came to pretty much the same conclusion that Mr. Thomas' analysis team arrived at, and he did this through additional testing and analysis and development testing, if you will. We came to that conclusion by just assessing the design and the process and the understanding as the design was—as the joint was designed and tested.

The last item is the case configuration changes resulting from transportation in the horizontal. Because of the length of these cases where they are cast, we transport them across country in the horizontal position. As they are—they stay in the horizontal for long periods of time. The case tends to become oval. Now, we think that this is a potential contributor, this becoming oval, when it gets to the cape to the possible out of roundness. Now, we have seen in the Commission's report, this is addressed where there is some consideration for that—for either fixing the transportation mode or being able to properly assure that the roundness is in fact adequate or correct prior to stacking.

May I have the next one, please?

The next area is that for the shuttle main engine, and these are the significant findings we arrived at from our review at Rocketdyne. We found that the engine itself is a high-technology, high-power density state-of-the-art engine, a very, very precision instrument. We found that because of this, and because of the long relationship, I guess, in working with the liquid propulsion engines at the Marshall Space Flight Center, our people at NASA and those of the contractor had a very good understanding of not only the programmatic, but of the technical requirements.

The third item was a consideration for margins of critical components that were not demonstrated by test. Now, this does not have to do with the acceptability or the certification for flight. Our concern here is, over the long reuse of the engine, we believe that we are going to have to develop or introduce some test that will allow us, by actual test results, to recognize the margins that are in some of these components. The way we do it today is, we test around the nominal, and we analyze or compute what we think those margins are. We believe that we're going to have to extend our test program in the margin area to be able to recognize these margins; as such, we will understand the performance of the engine better as it

relates to performance over the long period of time, the possible reuse, the overhaul, the refurbishment of the engines themselves.

Could I have the next one, please?

At Rockwell, on the orbiter, we also found that there was a very good understanding of the programmatic and technical requirements between NASA and Rockwell. We also found that Rockwell had some concern relative to the level of involvement that they had with the orbiter as it is processed and turned around, if you will, at KSC. And the emphasis here was more of involvement in that process in a way that their technical knowledge, their background, their corporate memory from a technical standpoint of the orbiter could best be brought to bear on any potential problems or foreseeable problems on the orbiter itself.

The next item was the number of the critical components, and I've listed two because they've been used before, the 17-inch disconnect and the brakes, and there was a list of these—a number of components within the orbiter; and this, by the way, is not only in the orbiter. There are some others in the SSME; there are some in the external tank, and I'm sure there are some others in the SRB, which we will ferret out. But in particular, there are a number of critical components like these that require some reassessment. This activity has already started; in fact, it had started before the accident.

The last one has to do, again, with a concern on the part of Rockwell that the critical payloads like the Centaur, which are relative hazards because they are, in fact, cryogen propellants within the orbiter bay, possibly were not receiving as much of an overall safety system assessment as you look at the orbiter in totality with the payload attached, and in order to be able to assure that all safety aspects were covered. These, by the way—in fact, all of these findings are being—actions are being taken by the Orbiter Project Office at JSC to start effort on these.

Could I have the next one, please?

The last one is the external tank. We also found there is a very good understanding by both NASA and Martin on program and technical requirements. Martin had some concern, not quite to the degree of Rockwell, that they didn't have quite the direct involvement at KSC on their hardware, if you will—and “their hardware” meaning the development contractor's hardware—they did not have the same involvement or adequate involvement that made them feel comfortable that everything that happened to that hardware, in fact, was getting the proper assessment, again based on their knowledge through the years of development qualification. There was no problem, by the way, identified by the Martin people, though.

And then the last item has to do with the range safety destruct system. Today we have the range safety destruct system on both SRB's—or both SRM's—and the external tank. And it has been—this has been a question that has come up over the years, and we are in the process of working with those people who established that requirement. If we can safely—or within the bounds or within the requirements established—if we can eliminate a destruct system, if you will, from the external tank, we'd all feel more comfortable about that.

That concludes the significant findings. I would like to summarize one point. We did not find, in any of our reviews with these contractors, a real deficiency in the basic processing of establishing and identification of requirements, how those requirements are introduced by contract, how the specification identifies those, the requirements for certification and verification, configuration control, acceptance. We found that the procedures, if you will, the mechanism for being able to accomplish the production and development programs of all these vehicles were, in fact, sound and only in some areas where that has appeared to break down, particularly in the case of the qualification testing—and I won't say that exactly broke down; there was some misunderstanding, and possibly, in light of today's environment, we should have put more emphasis on the certification aspects of that seal—but the procedures and the implementation of these procedures seemed to be sound throughout all the contractors.

Mr. ROE. I thank the gentleman, and I would like to welcome Mr. Thomas Holloway of NASA's mission planning and operations team. We welcome you, Mr. Holloway; go ahead with your presentation, please.

Mr. HOLLOWAY. Mr. Chairman, thank you.

First chart, please; second chart, please.

I am reporting on the mission planning and operations team, and first I'll introduce the members of the Presidential panel of the same title. Dr. Ride was the leader of that group; Mr. Rummel participated; Mr. Hotz, and Mr. Acheson.

Next chart, please.

First, let me characterize what our group did, the Mission Planning and Operations Panel. There was not a focus for our group because there was not any obvious relationship to the accident itself, so we were in the process of looking at a large number of activities that go on in the process of preparing for and executing the flight operations during a shuttle mission. And as such, we established a fairly large group of individuals to go off and examine multiple areas in flight operations to see if, one, we could find anything that contributed to the accident; and second, if we saw any indicators in those functions and activities that needed attention to prevent future accidents.

First, I will say that I will not discuss each one of these things in detail today because I don't think they are important for your purpose here, but I would like to characterize generally what we did find.

First of all, we did not find any concerns that were a total surprise to the system and to the people involved. I would characterize what we did find in three ways. First, there were many of the areas that we examined that we found that all was proceeding very well for the medium-to high-fly rate that we were looking toward, and the procedures and processes were working very well.

Second, we found situations where the functions and activities may not have been what we would have liked for them to be for a medium- and high-fly rate, but the procedures and plans and budgets were in place that would allow that to evolve to more than a satisfactory situation.

And the third area were areas of concern that perhaps require some emphasis on the part of the program as we go forward to ensure that evolves properly, to ensure that we have everything in place that we'd like to have.

Next chart, please.

I might add that the dominant portion of the activities we looked into fell in the second category.

We met with the Presidential Commission 11 times, presented 22 formal briefings and numerous data packages and formal reports. That amount of time spent with that group was on the order of 65 to 70 hours in technical briefings, and some 320 to 350 people at one time or another participated in the generation and the presentation of that information.

Starting at the top, we discussed that group the 51-L mission preparation, including the crew training, the crew activity planning, the trajectory design, the ascent abort modes, and how that worked out on 51-L. We also talked about payload, our cargo manifesting, and providing opportunity for the SR&QA people to be interviewed on March 12.

March 20, we had our joint session to put together plans and schedules. On March 24, we discussed the range safety history that Mr. Lee has previously discussed briefly with you; the history of that program, how it evolved on the shuttle itself; what the current procedures are; what the flight rules are that control its utilization, and where we are today.

We discussed the milestone history; in other words, how well we had been doing with schedules in terms of mission preparation, and how we anticipated we would be able to perform in 1986, had that flight schedule been allowed to evolve.

We reviewed our weather flight rules; RTLS rain damage assessment; and again, on March 25, we provided information on shuttle main engine failure containment, and an opportunity for the Commission members to interview some safety, reliability, and quality assurance personnel.

On March 31 we reviewed orbiter testing, what we thought that the operating base was for the flight operations group; payload safety; crew training, and the state of our crew procedures program that maintains flight crew procedures.

On April 7 we participated in a meeting at Marshall, again to allow the Commission to interview some SR&QA personnel at that location.

On April 8, we reviewed workload assessment, how much overtime and how the annual leave was being used and so on and so forth, particularly for the Mission Control Center personnel in Houston. We reviewed the state of the orbiter software program and how we develop software and test it and prepare for each flight. We reviewed the cargo manifesting, the process and procedures associated with putting a cargo together, and the history of how well that's gone and how many times we have changed those cargoes and those payloads as a function of each flight.

On April 9, in a 9-hour meeting, we reviewed the landing considerations, KSC landing considerations relative to rain and brakes and nosewheel steering, and also transatlantic abort landing considerations of the same nature.

On April 14, we reviewed the ascent envelope expansion, or the state of the ascent envelope in terms of flight design and trajectory, and spent the afternoon reviewing the history of the first stage abort options from RFP days up through 1983.

On April 15, we provided an opportunity for the Commission to continue their review on safety, reliability, and quality assurance.

Next chart, please.

On April 18, we submitted to Admiral Truly our report; it was later submitted to the Commission by Admiral Truly's office. I won't review those in detail, but it included all those things I've previously discussed.

Now I'd like to review the major findings of the group. Before I do that, I need to tell you that they are not all related subjects, so they don't flow very well. They are all individual subjects, or most of them are individual subjects, and as such they don't have continuity, one from the other.

First, under mission planning and preparations, the 51-L mission manifesting, mission operations, flight crew preparations, pre-launch, and launch were typical and satisfactory and had no effect on the accident. Furthermore, the flight crew and the ground crew were well trained; they had fulfilled all of the training requirements and, more importantly, we all believe that the crew, both ground and flight crew, were indeed well trained and well qualified to fly the mission that would have occurred had the accident not happened.

Under 51-L mission preparation, first, there were no actions possible that could have resulted in the survival of the 51-L crew. As has been stated before, during first stage the SRB's simply must work. There's no possible procedure that can allow us to separate from a thrusting SRB with the current configuration that would allow survival of the orbiter.

Second, the range safety system that Mr. Lee previously discussed did not contribute to the accident, and the actions of the range safety officer were important. As you remember, the range safety officer destroyed the SRB's in flight, and he had the proper—he took the proper action based on the conditions of the day in the situation that he had on his hands at that particular time.

Also, we have initiated a joint NASA/DOD review of the range safety system, and we will be reviewing those issues, many issues, in that system, including the one that Mr. Lee discussed earlier today.

Under NSTS mission planning, we found that the operations maintenance inspection program—that's the program in which the requirements to inspect and maintain the orbiter from structural equipment to line-replaceable units, and the process of getting those requirements introduced into procedures at KSC that the technicians can execute, including a methodology that allows the feedback to the appropriate people in terms of accomplishment of those procedures—were immature and did not provide what we would like to have in the future to make sure that all the requirements are met and, in such cases when waivers are entertained, that they are identified very early in the process and can be dealt with at the technical level in time to make timely decisions. That

work has been in progress for a year or so at this time, and we expect that it will evolve satisfactorily in the future. So it's a matter of emphasis in completing the work that was in progress at the time of the accident.

Under NSTS mission operations, one of the major findings was that the current program commitments precluded devoting adequate resources to developing a capability to support the increasing flight rate. And what I mean by that is, that either because we were more interested in flying the flights or because the flight rate demanded all of our attention, we were spending all of our resources toward flying—a majority of our resources, at least—toward flying the flights rather than looking toward the future flight rate and the requirements that it would take to develop the flight products and the procedures and the details to fly at the higher flight rate.

Additionally, at the time of the 51-L launch, KSC landings—one of the favorite subjects that's been discussed by many people—did not constitute an unreasonable safety of flight risk based on known failures.

Next, statistical weather and forecasting uncertainties have resulted in several wave-offs from KSC and dictate a need for multiple landing sites for end-of-mission. We will always need multiple places to land the shuttle regardless of what the planned landing site is, and we ought to put those in place and have plans in place to utilize them and turn the vehicle around and prepare for the next flight.

The current—the next item speaks to the current landing and deceleration systems, which have not demonstrated an adequate margin for routine KSC and transatlantic abort landings. We believe that for a long-term program we need a better landing and deceleration system; and, in fact, the program has in place many of the elements of what we believe are required to cause that to happen.

Crew escape systems—we reviewed the history of the crew escape systems from the inception of the RFP back in the early 1970's through 1983, and there are very many varieties of crew escape, including augmenting the basic shuttle to allow it to perform a recovery-type operation and allow it to land on a runway, from ejection seats to escape pods, to situations where a group of crewmen might bail out of an opening in the cabin during glided flight before impact. During that review, we found that these systems were all reviewed numerous times throughout the history of the shuttle program; and because of what at that time was considered to be limited utility—and what I mean by that is that the systems that were envisioned to be put in place would not cover an adequate number of the envisioned scenarios that might happen, such as 51-L—it was not found to be a usable system; the technical complexity; the ability to build such a system and ability to monitor the impending failures and execute the escape system in time to make it useful; and cost and schedule and performance impacts, performance impacts being primarily payload-to-orbit—no system was implemented.

Last in this group, we reviewed the astronaut office involvement in the program and found that they play a significant role in all

activities associated with the development, flight preparation, and flight execution, and they and their management are members of all major decisionmaking boards and panels.

Under flight rate and scheduling, we found that the 1985 mission operations were successful in spite of significant remanifesting perturbations. We did take on a number of challenges in 1985 outside of the scheduled manifest; we had a number of upsets, one including an engine shut-down on the pad; we remanifested the cargo and flew a new mixed set in a matter of 6 or 8 weeks. We took on the challenge of flying the 51-L mission and rescuing the Navy Syncom satellite in about 4 months, and executed that and, in my opinion, did all of that quite well.

However, the trends indicated that the milestones required to support the preparation for the 1986 flight schedule would have been extremely difficult. We may have arrived at the point where our schedules did not meet our capabilities.

We had four major conclusions that coincided with those 11 major findings.

First, we believe the NSTS program should develop a bottoms-up strategy for expanding our flight rate. And as a start, rigid manifesting criteria need to be established and enforced.

Also, we believe that an inspection and maintenance program should be implemented that will ensure that we get the job done as long as the shuttle flies, and work is in progress to make that happen.

Third, the NSTS program should focus attention on defining and providing an adequate margin for end-of-mission and intact abort landings, and that work is in progress and it includes both ground facilities and flight hardware.

And last, the program should evaluate the options and utility of providing crew escape systems and augmenting orbiter abort modes using the technology of 1986 with the understanding of the program as we know it today.

Mr. ROE. I thank you, Mr. Holloway.

Now we'll hear from Mr. Utsman, who is the final witness on the Pre-Launch Activities Team. Mr. Utsman.

Mr. UTSMAN. Thank you, Mr. Chairman.

The first chart, please. Next chart, please.

This chart depicts the organization that we used in order to carry out the task of supporting the prelaunch team of the Commission.

The prelaunch team's job was essentially in three areas. One was to look at the NSTS processing that had been done for 51-L; the second part was to look at the flight readiness processes that led up to the launch decision, and the third area was to look at the security aspect and determine if there were any problems in that area.

In carrying out those three tasks, we organized into three teams, as shown on that chart.

I would like to say that the purpose was always to support the Commission's activities, looking for causes of 51-L problems since this activity was primarily started immediately after the accident, but we also realized that due to the comprehensiveness of the review that there would be many lessons learned and many things that we could find that may not be associated with the accident

and we wanted to capture those so that we could use those and make improvements on those. So that was always in our minds.

Next chart, please.

We felt the review was comprehensive. It involved about 900 of our people. It involved all levels of—

Mr. ROE. Is it 900 people just—I hate to interrupt you, but is it 900 people en toto or just for your area of review?

Mr. UTSMAN. It was in this area of review.

Mr. ROE. I thank the gentleman.

Mr. UTSMAN. It involved all levels. We had from engineering management all the way down through technicians; we wanted to have technicians involved for their viewpoints. We had all the disciplines involved. It did involve our NASA people and our contractor people, and the 900 did include both NASA, Civil Service, and the contractor. We had participation with some members of the Air Force, and we had an active participation by members of the flight crew, which was important to us.

In conclusion, we had several significant, relevant findings which we'll discuss in a few moments. We did find that our operating procedures do require correction in some areas in that there are some processing practices which can be improved. We document the results, and it was in a large amount of volumes due to the amount of work and review that went on. What we tried to do to simplify that was to summarize it into a single document that would capture the essence of those other documents, the 6,000 pages, and that was submitted to the Commission along with a copy of all the background material which was used.

Next chart, please.

I'm going to move into the first area, the NSTS processing review.

The job there, right after the accident, we impounded all the data, which included all the paper, any data that was associated with the 51-L processing. And what we did then was formulate into teams—which I'll show you in just a minute—and went into the process of reviewing every bit of that documentation in the records, as well as interviews, to ascertain whether we had had any problems associated with any of these activities. We looked at how the flight hardware met with our mobile launch platform; we looked at pad B, our launch complex pad B, since this was the first use of it, to look for—if there were latent defects that could have been in our processing or in bringing that activation on board; we looked at the GSE that interfaced with the vehicle and the facilities that interfaced with the vehicle, looking for anomalies.

We reviewed all our payload processing. We looked at the ICE team. We, along with DOD, did look at the range support that does support the activity, prelaunch, at KSC, and analyzed all our problems and documented these findings.

Next chart, please.

These are the teams that we did put together that did support this activity. As I mentioned, these started early on; and when the task force was formed, we went back and did a quick check to make sure that we did have a degree of independence. We didn't want to have people reviewing their own work, but we wanted

people who were familiar with the work to be able to review it, and we found that to be the case.

The outside members working with us, such as the flight crew members as well as the staff from the Commission, gave us the feeling that we had a degree of independence since we recognized that these were mainly KSC people looking at KSC work. And so we felt comfortable that that was the case; we did have an objective look.

Now I'll go into the major findings concerning the processing. Next chart, please.

Our first major finding was that, in conjunction with what had gone on on the accident analysis team, we in looking at our activities could find nothing that led up to or contributed to the 51-L accident.

Now, I'd like to hesitate and stop there. There is one, in the area of the SRB joint—the way the joint is put together, it is what we call a "blind mate;" that is, you can't see the internals once you're done with it. We do know that you can put the joint together correctly. We know this from tests, and that you can have some joint sealing degradation; and the type of things that you can have, even though you have tested it and put it together properly, is that you can find some minor, small contamination—for example, when a pin goes in, as you saw in the earlier joint, there may be a metal sliver in there in that, and there's no way to tell it. The O-ring could be damaged but yet still pass the seal test under some extreme conditions. And we know that we can have water in the joint, and we have no way to test for the water in the joint, as has been attested.

When it was looked, it weighed—even though the processing was done properly, as Mr. Thomas said earlier, it was felt that there was any low probability that there was any problem associated with the—contributed by the processing.

Next chart, please.

One of the problems that we did find was that our work control documentation system does require revision. This system has been in place and is a derivative of the system that was installed and instituted in early manned flight. What has happened to it is that, due to the activity, it has become cumbersome; and, to use a term, it's not very user-friendly. This led to two problems. One was that people became sloppy in their practices, and this is an area that you can often say is just a discipline problem among our people. When we looked at it we found that we had given them what we thought was a task and a system that was too cumbersome to really work with effectively, so what we're doing right now, we are in the process of looking at it. We have several teams bringing in all levels of the workforce, looking at how we can streamline it and make it what we would call more user-friendly. We are also going to be emphasizing on the importance of the system as well as how to use it, and we think that those will lead to an improved system with more rigor in it and more discipline.

We did not have a problem at the time with the paper system, assuring that there were no contributors to the accident, because with the effort we put into it we could find where the records were inadequate by talking with people and working in that manner;

with special analysis, we knew that we were all right. This is not what you want for a normal operation, and we intend to correct it.

Next chart.

Launch complex 39-B requires additional modification. This wasn't really a surprise to us; in fact, the complex turned out to be what we consider very good. However, we know we've got some hardening modifications to be made, and these are just where, in some cases, panels bulged due to negative pressure that we hadn't anticipated. We're going to have to put plugs and things like that; it's not a major item.

The major thing we did find was that this freeze plan that we had instituted this time, which was also the first time it had been used, was inadequate, and that led to the significant amounts of ice on the launch complex. This is going to be corrected, and it's underway right now, the definition of its correction.

Next chart, please.

One of the findings when you went through with the 900 people was that there were cases where we had had some inefficiencies in our processing due to high workload. The high workload contributed to a peaking of work that was somewhat more than we had anticipated. The four orbiters being processed was a new time for us, and when we got into it, it is not something—due to the short-term nature of what we saw of the problem—that you could add people. I might say that in most of our cases, to get people fully up to qualification requires some 18 to 24 months, so you can't just go out and hire people, bring them in, and then have them be able to get the job done.

So what we're looking at now is, very carefully, how we can approach our shifting and our manpower mix, along with our contractors, to assure that we have as much flexibility to unforeseen problems as we can in the future.

Mr. ROE. For clarity, will the gentleman hold at that point?

On the top of that chart, you're referring to manpower limitations due to high workload-created scheduling difficulties. You're speaking now to the launching process itself?

Mr. UTSMAN. That's correct, sir.

Mr. ROE. Thank you.

Mr. UTSMAN. Next chart, please.

We did find a few test team errors that were caused by not following established procedures. Most of them were related to work control documentation systems as we discussed earlier, the lack of being user-friendly; however, we did have a couple of very serious cases. The most serious one was that we had an undetected slamming of the 17-inch disconnect. We know it's a critical problem. The reason it occurred—well, there were many reasons, but the fellow who did the—who slammed it is an experienced person who took the judgment onto himself that this was not a problem since he had seen it before and understood the background. Our system is such that if you do something that is out of the ordinary, you should document it, and this was not documented so therefore it went undetected through the system. There was no indication of a problem. It was reported during the post-review of the data, but again, it was a very serious—in our view—situation of not following established procedures.

What we're doing is obviously—I think the seriousness of that is being stressed throughout the work force. We're also going in to look at situations where—have we been as rigorous in ferreting out places where human errors can occur on critical hardware, and see if there aren't ways that we can preclude those? We feel, with that, that we're going to reduce the propensity for this type of situation.

Next chart, please.

Mr. Holloway reported that the test requirements system required revision from their view of it. This is a similar type of finding that our team had, looking at it from a KSC processing standpoint. Between the people in the program, there is work underway right now to make the correction to both of these findings.

Next chart, please.

The orbiter logistics system supporting 51-L was found to be inadequate, causing significant LRU cannibalization. I think this has been well-reported. It was created by just a lack of parts and the level of degree of activity. And we ended up, out of some 300 parts required for the processing of 51-L, that 45 of them had to be removed from another vehicle and placed into *Challenger* for use in 51-L.

Besides the manpower implications of that, there is an implication that you just don't like to be working on vehicles because any time you get into a vehicle, it creates a potential safety hazard.

The program has been working—Admiral Truly has initiated action already to try to beef up the spares program.

Next chart.

Additional analysis will be required to assess environmental effects upon launch capability.

From the ground systems standpoint, we had not developed adequate modeling, in my view, to know comprehensively all the problems that we might have through the launch complex. We had one cylinder, for example, that reacted slower. We had qualified it to 32 degrees, but when we looked at it, even though the ambient temperature was above 32 degrees, we hadn't run the modeling to find out exactly the temperatures there, and it was below freezing and it reacted slower. It didn't create a problem, but it meant—it was an area where we need to improve our information.

Also, the instrumentation and analysis of the temperatures all over the launch complex, we feel, is going to have to be improved in that, as has been pointed out, you just can't take a temperature measurement at one spot and have that be representative of the total complex. So we're looking at modeling techniques so that we can have an improved assessment, really.

Ice debris was greater than predicted. There was much discussion on the prelaunch activity about the ice debris and where it would go. We did review that and we found that when you reviewed the films postlaunch, that the aspiration effects were greater than had been anticipated by the people who, prelaunch, had participated in that discussion.

There was—again, the ice did not create a problem, but it did show us that there is a need for improved modeling—if not for ice, to look at the aspiration effects as it may affect all debris. So this is an area of reassessment.

Next chart, please.

That was the final finding that we had that summarized all the 10 teams' activities as far as the STS processing. At this point I would move into the flight readiness review process as it led to the launch decision.

The way we handled that, due to the nature of it, it was one where I think, in all fairness, the Commission took the larger lead and we worked off of data, somewhat, that the Commission had provided us.

What we did, we analyzed the policies and procedures and found that essentially we were in compliance with them.

Next chart, please.

That was our first finding; and again, as has been stated several times, the process itself—the structure of the process—is a consistent, fair process.

Next chart, please.

However, in all honesty, the flight readiness process did not address the critical SRB flight safety issues. And part of the rationale that you get, I think, in our determination it was the lack of understanding of the full certification process. So therefore, when it came forward—even though the indications were coming forward—when it came down to the launch decision, there was not a clear understanding of the mechanism that was going on in operating at the low temperatures in the joint. And so consequently, we've got to review our whole system and how we lead up to that and decide what action should be taken.

Next chart, please.

This is another area that, I think, has been well documented. The communication during the launch decision process was inadequate, and that may be a poor choice of words on my part. What I was trying to portray is, it was obvious in the after-effect that there were people in Morton Thiokol at the engineering level whose concerns didn't reach those who said that if they had known of them, they might have taken other actions. I don't know, other than that says that there has to be something wrong in the communication there, for improvements.

Also, with regard to the ice debris and Rockwell, we had the senior officials of Rockwell believing they were talking on a flight safety issue, while the senior officials of NASA believed they were talking about an issue that was not safety of flight, but a refurbishment issue. And again, that type of communications indicates there was a problem with the communication.

Next chart, please.

That was all I had on launch decision, in that there is a lot of review in that whole activity. But that is all that we were asked to look at as the prelaunch team.

The final area we have is the prelaunch security. In that activity, the assessment, again, was initiated right after launch, and the review was done in conjunction not only with KSC, but aspects of local, State, and Federal agencies to assure that all aspects of the security problem were looked at. And the next chart documents our major finding, in that there were no factors contributing to the 51-L mishap that were found as part of the security assessment.

Next chart, please.

However, we did say that based upon our look-see, or looking at that whole activity, that we wanted to reassess our national resource protection to assure, in light of all that we looked at, that we were doing a proper job, and this type of review is ongoing.

And that's all I had, and that was the end of our findings, sir.

Mr. ROE. Thank you, Mr. Utsman, and your other colleagues for an excellent presentation and one of candor. And without objection, the Chair would move that testimony, the written testimony accompanying the charts and graphics, be incorporated as part of the committee's records at this point in the record. No objection; so ordered.

[Materials to be supplied.] [See Appendix 2 p. 662.]

Mr. ROE. In the preagreed discussion we had this morning as to our process this afternoon, Mr. Scheuer, the distinguished gentleman from New York, was proceeding upon a particular course of questioning, and we decided it would be apropos and workable to finish the testimony first of the distinguished representatives of NASA, which we have done at this point, and therefore the Chair now defers to the gentleman from New York, Mr. Scheuer.

Mr. SCHEUER. Thank you very much, Mr. Chairman.

Dr. Fletcher, we were discussing this morning the remarkable body of evidence, the remarkable data base that NASA achieved in a comparatively short period of about 6 weeks after the tragic accident by the application of approximately \$5 million and approximately 200 scientific and technical people.

And I asked you if you could get for us this afternoon the resources and the personnel that were applied to addressing the problems that were enumerated in the February 1983 warning, the July 1985 warning, the August 1985, warning, before launch.

Dr. FLETCHER. Mr. Scheuer, as you know, we did look at that very hard during the lunch period, and I think we have some answers for you.

Mr. SCHEUER. Good.

Dr. FLETCHER. There was a study started after a flight readiness review when the joint problems were discussed quite extensively. The study was started in early 1984, and it looked at things like margin assessments, new designs, and new materials to be used in the joint. Additionally to that, at the Marshall Space Flight Center, there was some internal Marshall effort that looked at modelling of the joint, things like putty layup, et cetera, that was ongoing. And also, after each mission, when an incident occurred with the joint, there was some manpower and some dollars associated with doing a postflight analysis.

The total of this, with the information that I could gather over the lunch hour, was approximately \$3.5 to \$3.8 million. I don't know exactly how many people were involved, but I can supply that for the record.

[Material to be supplied follows:]

Material Requested for the Record on Page 126, Line 2088, By Mr. Scheuer on June 12, 1986.

Approximately 40 MTI and MSFC engineers were involved in the early redesign assessment during the months preceding the accident. The initial studies, in early 1984, utilized approximately 17 engineers. Additional personnel were added as needed for putty lay-out, subscale testing and other structural and mechanical analyses.

Mr. SCHEUER. Over how long a period of time did this effort take place?

Dr. FLETCHER. This was over a period of about 2 years.

Mr. SCHEUER. Starting when?

Dr. FLETCHER. In early 1984.

One thing that I have not been able to quantify that I think is worth pointing out is that the—because the problem had been recognized earlier—but as the Commission's investigation quite clearly shows, we did not deal with it to the extent that we should—we did institute a design change into the joint, the metal for the joint itself, which has been referred to as a capture tang, that was designed to reduce the joint rotation that has been discussed here today. That capture tang, that metal in that captured tang was designed into the design for the filament-wound case; that's a new version of the solid rocket motor that is designed and is under development to be used out at Vandenberg Air Force Base for west coast launches. And in the summer of last year, the decision was made—

Mr. SCHEUER. The summer of 1985?

Dr. FLETCHER. The summer of 1985, yes, sir.

The decision was made, in the case billets, the raw billets that were being produced to later be machined, that enough metal would be—the design of those raw billets would have enough metal so that the steel cases could also have such a capture tang.

I don't have a dollar number to put on what went into that particular design change, so I guess I would, in summary to answer your question, it was less than \$5 million; \$3.5 to \$3.7 million over a period of the last 2 years, plus the cost of that capture tang, and I can get that. But I don't have it now.

Mr. SCHEUER. Well, now, as of August of last summer, in the third of these three early warning signals that all was not well, the recommendation was made in this final briefing to the NASA people, through Michael Weeks and others, the recommendation was made that efforts need to be continued at an accelerated pace to eliminate seal erosion, and that additional tests needed to be conducted for establishing margins of safety for eroded O-rings.

Now, this was 1½ years into that 2-year effort that you're talking about, so apparently it was quite clear as of 18 months into that period that there was vast additional data that had to be accrued before launch could be effective.

Let me ask you, do you agree with the statement made in this Presidential Commission report, on page 148, that—I refer to item 5 in the second column—"The O-ring erosion history presented to Level I at NASA Headquarters in August, 1985"—the briefing that I just referred to—"was sufficiently detailed to require corrective action prior to the next flight." Do you agree with that?

Dr. FLETCHER. I accept that. I'm sure that it is correct; it was a conclusion of the Commission. I think it is quite clear, in hindsight, that the O-ring problem should have been dealt properly with, and that's a point that you made earlier and I'm very glad that you did—is that the fact that this problem was missed was not only a problem at the Marshall Space Flight Center, but also at NASA Headquarters. The signs were there; the Commission—in retrospect, the Commission and our task force and this tremendous

amount of effort that we've put on it, which is the nature of accident investigations, has shown that improper attention to this crucial problem was given, and it was not limited to the people at the Marshall Space Flight Center.

Mr. SCHEUER. Mr. Chairman, we have in the audience, the Deputy Associate Administrator of Flight for NASA, Mr. Weeks, and I wonder if we could ask him to come to the witness table.

Mr. ROE. I believe Mr. Weeks is here. If we may, Dr. Fletcher, we'd like to have him come to the table for some questioning.

Dr. FLETCHER. Mr. Chairman, this is Mr. Michael Weeks. He was the Deputy Administrator at the time of the accident.

Mr. SCHEUER. Deputy Administrator for Flight?

Dr. FLETCHER. I'm sorry—Deputy Associate Administrator (Technical) for Office of Space Flight—or for the STS.

Mr. ROE. Mr. Weeks. Go ahead, Mr. Scheuer.

Mr. SCHEUER. Mr. Weeks, in February 1983 you signed a waiver of the fail-safe requirement for the joints, correct?

Mr. WEEKS. That's correct.

Mr. SCHEUER. Right. And then in July 1985, you were alerted to the problem of the joints when Irving Davids wrote a memo, which you were copied, right?

Mr. WEEKS. That's correct.

Mr. SCHEUER. OK. Then in August 1985, you were present at a briefing about the repeated failure of the O-rings in which you were urged—you, I mean the collective group—were urged to make efforts to continue at an accelerated pace, efforts to eliminate this seal erosion, and to conduct additional tests for establishing a margin of safety for O-rings, OK? Right?

Mr. WEEKS. Yes.

Mr. SCHEUER. Now, what I'd like to know, at that point in time in August 1985, with a launch date set for *Challenger* staring you in the face not many months hence but with these critical warnings in your possession, what kind of resources did you spend to address yourself to the problems that this memo urged you to address at an accelerated pace? How many people? How many dollars? What did you learn, and what did you do about it?

Mr. WEEKS. As Admiral Truly spoke to you, I think I should—

Mr. SCHEUER. Mr. Weeks, I'm asking you a couple of very simple questions—

Mr. WEEKS. I understand that.

Mr. SCHEUER [continuing]. Which demand a factual answer.

Mr. WEEKS. The effort after that August meeting that we had, which was quite an important one—

Mr. SCHEUER. What was important? The meeting or the effort?

Mr. WEEKS. No, the effort and the problem of the erosion of the secondary O-ring—

Mr. SCHEUER. Well, we know the problem was important. What we want to know is, what did you do about the problem when you were warned about it for the third successive time? What happened after that August meeting?

Mr. WEEKS. The key items that happened after that was the studies that Admiral Truly has already spoken to.

Mr. SCHEUER. What did you learn from those studies?

Mr. WEEKS. That there was, essentially, as we have found now—it's about a 2-year program—

Mr. SCHEUER. That essentially what?

Mr. WEEKS. That it's about a 2-year program to bring the capture tang and any changes into that joint, to eliminate all of those problems that Mr. John Thomas talked about.

Mr. SCHEUER. Now, I don't understand that. It was a 6-week program that just took place to put together the data base that tells you that under no circumstances should this launch take place. Now, what I want to know—

Mr. WEEKS. Now, wait a minute.

Mr. SCHEUER. What all of us want to know is—

Mr. WEEKS. Wait a minute. "Under no circumstances"—I believe really, Mr. Scheuer, you—

Mr. SCHEUER. Scheuer.

Mr. WEEKS. Scheuer, excuse me.

The conclusion of that briefing given to us on August 19 was, it is safe to continue flying the existing design as long as joints are leak-tested with 200 PSI stabilization pressure, and are free of contamination in the seal areas, and meet the O-ring squeeze requirements.

Now, Marshall did proceed with a number of hardware things that were put into the filament-wound case qual test motor. They were basically three; in addition to all this study effort, there were three changes made in the qual motor of the filament-wound case because that was coming along and was an opportunity to put them in. And so we inserted into the qual motor program the fixes that I will now relate. There were basically three of them.

As Admiral Truly said, in July 1985 we ordered those 72 forgings with the extra material so that we can now, for the fix that we're going to have to do, provide the captured tang to stop the rotation. And that decision—

Mr. SCHEUER. Let me cut you off there—

Mr. WEEKS. I really think that to get the three things that were quite fundamental as a result of that—

Mr. ROE. If the gentlemen will both suspend. There is a bit of excitement in the air because we are trying to get to certain facts.

I think Mr. Scheuer had asked you in the initial question, which you really didn't answer—but if I could impose on the distinguished gentleman from New York to allow the witness to make his observations, then let's go back then and restructure our questions. Is that satisfactory?

Mr. SCHEUER. Very good.

Mr. ROE. So we'll give you the courtesy of giving you the time to answer.

Mr. WEEKS. Very good. I appreciate that.

So these—in addition to those studies that Admiral Truly spoke to, there were these three things that we put into the hardware. The 72 forgings were ordered because we knew the rotation problem was serious, and we had changed the design in the filament-wound case so that it did have a captured tang. That decision of proceeding with those 72 forgings is now saving us 6 to 9 months in the implementation program that Mr. John Thomas is heading up

that would have delayed us more had we not made that decision. These forgings, in fact, are already at Rohr in San Diego—

Mr. ROE. Can the gentleman, just for clarity, explain to the committee what he means by forgings and where the forgings are located?

Mr. WEEKS. OK. The solid rocket motor is composed of a lot of spun forgings that are 146 inches in diameter and 12 feet long. I think Mr. Lee showed that. It takes two of those forgings, properly machined, to make up a single segment that can then be poured with propellant with, I think, as you, Mr. Roe, spoke to, of the joint that is covered over that is the same sort of joint. And so that's what those forgings are. They're spun; they're done by the Ladisch Corp. up in Milwaukee, and then they are shipped to Rohr in California for machining. And already, with that decision that we made to move out on those forgings, we've gained ourselves 6 to 9 months that we would otherwise have due to this terrible accident. And we changed two of the three case joints as a research project, changing the O-rings in two of the three in this qual motor, which was for the filament-wound case, and that was to improve the sealing.

And the last change of the hardware that was put into the qual motor, into the filament-wound case qual motor, and that stops the rotation, and that one is down in the throat area. The basic idea of the captured tang, which is a very likely candidate for the way we will fix the joint for the final—for when we get flying, is a captured tang that forbids the rotation to exceed more than about nineteen-thousandths of an inch. And that, in addition to the study effort, are very positive things that were done by Marshall and by Thiokol to move forward in this area of improving the O-ring erosion which occurred many times during the past 2 years.

Mr. ROE. All right. Now, if we can get back to our continuity, Mr. Weeks. We thank you for your explanation, but I believe what Mr. Scheuer is about to do is to evolve a set of questions that really are not looking for long, technical explanations, and I mean no efrontery to your expertise, but what actually happened? What did we do? And that's what—

Mr. SCHEUER. Can I rephrase my questions, Mr. Chairman?

Mr. ROE. Yes, sure.

Mr. SCHEUER. Let's rephrase the questions because maybe I wasn't sufficiently clear.

Following the meeting on August 19, where you were urged to make efforts to continue at an accelerated pace the elimination of the seal erosion, where you were urged to make additional tests for establishing margins of safety for O-rings, conditions which apparently impelled the Commission to write that: The O-ring history presented at level I at NASA headquarters in August 1985 was sufficiently detailed to require corrective action prior to the next flight."

Now, having been urged to make an accelerated research and development effort to eliminate seal erosion and to establish margins for safety for eroded C-rings—for eroded O-rings—what did you do?

Mr. WEEKS. The accelerated program was very clear in those three things I just told you that were put into the dual motor test

for the filament-wound case, which were genuine improvements to reduce the probability of erosion occurring in those joints.

Mr. ROE. Will the gentleman yield at that point for a point of clarity?

Mr. SCHEUER. Yes.

Mr. ROE. Did you not say two things, as I understand it, when the discussion took place that the results of the—the review of the discussion indicated that if you were to correct the system, that it would take 2 years?

Mr. WEEKS. At the time period that we were doing that, the best estimate that we had for capture tang design configuration was about 2 years.

Mr. ROE. All I'm simply trying to get at is just simply to elucidate your specific statements and facts you made; either they are correct or not. Therefore, do I assume from that—if the gentleman will indulge me further—do I assume from that that if I'm talking to you and we're deciding we have a problem, and you say, well, we do have a problem, we've discussed it—well, OK, now. I'm concerned about that; what I want to do is get that totally corrected so that we do not have any more problems. In order to pursue that course of action, how long approximately do you think it would take? And then you respond to me and you say, well, from my best judgment it would take approximately 2 years.

Is that an accurate observation of your point?

Mr. WEEKS. Yes, sir.

Mr. SCHEUER. Can I take it from there, Mr. Chairman?

Mr. ROE. Yes, you can, of course. I just wanted to clarify that.

Mr. SCHEUER. Now, there was a life-threatening condition there which the Commission said should have been corrected prior to the next flight, OK? Do you disagree with this conclusion? Do you feel that research should have gone on over the 2 years that you suggest it would take, while 25 or 30 additional space flights were being carried out? Should those two things have happened simultaneously or concurrently?

Mr. WEEKS. Well, Mr. Scheuer, it is much easier to look at this thing with 20/20 hindsight, but I still remind you of the following things that we knew at that time.

When the briefing was presented to us on August 19, 1985—as you will look in the briefing that was provided to the Commission on February 10—there was no temperature data presented that showed that the resiliency was such a critical factor. It wasn't until after the disaster of 51-L that I actually saw the resiliency data that showed that Viton, which is the O-ring material that we've been using, is so slow to recover at very low temperatures—

Mr. SCHEUER. Will the gentleman—

Mr. WEEKS [continuing]. That was not brought out—

Mr. SCHEUER. Mr. Weeks—Mr. Weeks, we are engaged here, and let us admit an effort at Monday morning quarterbacking. Should we be doing something else? Should we not all be trying to find out what the problems were and what should have happened that didn't happen that produced that awful accident?

Mr. WEEKS. I—

Mr. SCHEUER. Of course we should; there's no point in debating that.

Now, what I'm suggesting is that you had in your possession—I mean the decisionmakers, the corporate decisionmakers at NASA headquarters—three separate warnings that should have given you notice that this launch shouldn't take place until these problems that were identified were solved. That's what the Commission says.

Let me read it to you over again. I read it to you once before; I'll read it again.

"The O-ring erosion history presented to Level 1 at NASA Headquarters in August of 1985"—at the meeting at which you were present—"was sufficiently detailed to require corrective action prior to the next flight."

Now, do you disagree with that?

Mr. WEEKS. In 20/20 hindsight, I totally agree with you.

Mr. SCHEUER. OK. Now, we're looking at this from 20/20 hindsight. We're all trying to learn some lessons. We're all trying to learn some lessons, and frankly, there may be some lessons on this whole tragic series of events that Congress could learn from. Maybe we didn't do as much as we could have in funding, in encouragement, in oversight. There's probably enough blame to go around for everybody. There are no superpeople here, no supermen or women who are pointing the blame at anybody else. We are all in this together; we are all trying to learn how to avoid this awful catastrophe in the future and move forward successfully, to retake America's supreme place in space.

Mr. WEEKS. I cannot disagree with you, sir.

Mr. SCHEUER. Pardon?

Mr. WEEKS. I cannot disagree with you, that it would be extremely wise if we could have seen to do this \$5 million effort that took 6 weeks—

Mr. SCHEUER. Well, what I'm asking you—

Mr. WEEKS [continuing]. In September of 1985.

Mr. SCHEUER. Right. What efforts did take place?

Mr. WEEKS. I wish I could relive that history and do it.

Mr. SCHEUER. That may be enough for my purposes.

Mr. ROE. Will the gentleman yield? I want to get another point on the record.

Mr. SCHEUER. Let me ask one more question.

Mr. ROE. Well, it's a point of clarity that's not clear, Jim.

Mr. SCHEUER. I yield to my chairman.

Mr. ROE. The gentleman, in making his earlier testimony—we solidified the point of view of the 2 years, which we agreed on.

You made another statement, which I think is important. The second statement that you made, that it was determined in the course of that discussion—as I recall what you said—that even though the severity of the issue was understood, that it was decided that it wasn't that severe that you could not proceed with additional launchings, or whatever that meant, even though you would be doing some redesigning as you went along. Did I not understand you to make that comment?

Mr. WEEKS. That's correct, and I think that the statement at the conclusion of the briefing is quite significant in that it is safe to continue flying the existing design as long as we did those three things that are in that briefing.

Mr. ROE. Well, if the gentleman would expand on that further. Therefore, there are a group of people—whomever they were—that participated at this particular meeting, reviewed these facts that were available, and they determined two things, according to your testimony. One, they determined that if everything—if they had their “druthers,” or whatever the case may be, it would take 2 years in their judgment to be able to correct that; but in spite of that decision, they took and made the second judgment. And the second judgment, well, we can continue to fly. We’ll start the mechanisms going to get this corrected, but we can continue to fly until we get that done. Isn’t that the decision that was made, according to what you’re saying?

Mr. WEEKS. That is correct.

Mr. ROE. Therefore, some people who were at that specific meeting had to be the people who made that specific decision.

Mr. WEEKS. That’s correct.

Mr. ROE. Is that a fair commentary?

Mr. WEEKS. That’s correct.

Mr. ROE. Could we have a list of the people who participated?

Mr. WEEKS. I have it right here.

Mr. ROE. Would you submit the list for the record, please?

Mr. SCHEUER. Was Jesse Moore at that meeting?

Mr. WEEKS. No, sir. Mr. Moore was——

Mr. ROE. Well, let me finish the first parliamentary issue first, Mr. Scheuer, if I may.

Mr. SCHEUER. Right. Right.

Mr. ROE. Therefore the gentleman would submit for the record a list of the names of the people that participated in that meeting.

[Material referred to follows:]

August 19, 1985 - O-Ring Briefing at NASA HeadquartersMorton-Thiokol, Wasatch Division

J.E. Mason	Senior Vice President and General Manager
C.C. Wiggins	Space Division Vice President and General Manager
J.C. Kilminster	Space Booster Program Vice President
A.J. McDonald	Solid Rocket Motor Project Director
C.A. Speak	Filament Wound Case Program Manager
F.J. Ross	Washington D.C. Office - Marketing Manager

George C. Marshall Space Flight Center

L.B. Mulloy	Solid Rocket Booster Program Manager
R. Schwinghamer	Materials and Processes Laboratory Director

NASA Headquarters

L.M. Weeks	Office of Space Flight Deputy Associate Administrator (Technical)
D.L. Winterhalter	Shuttle Propulsion Division Acting Director
W.H. Hamby	STS Program Integration Deputy Director
P.F. Wetzel	Solid Rocket Booster Programs Chief
P.N. Herr	Solid Rocket Motor Program Manager
H. Quong	Reliability, Maintainability, and Quality Assurance Director (Chief Engineer's Office)

Mr. ROE. The Chair recognizes the gentleman from New York.

Mr. SENSENBRENNER. Mr. Chairman, I'd like a point of clarification. I thought we were operating under the 5-minute rule here, and it's been a half an hour and there have been a lot of other members that have been very patiently waiting.

Mr. ROE. Well, that's probably the Chair's fault because this afternoon the Chair had decided, because of specific questions where people had been waiting all day, that we'd give people a little more latitude. But it is not the intention of the chairman to turn anybody off, and we'll give the gentleman the same courtesies in return.

The gentleman from New York.

Mr. SCHEUER. Thank you.

Mr. Weeks, you were telling us about Jesse Moore's presence.

Mr. WEEKS. Yes, sir.

Mr. SCHEUER. Was he at the meeting?

Mr. WEEKS. No, sir. He had planned to go to the meeting, but he was—some other prior pressure caused him to go to another meeting. But I did brief Mr. Moore that evening, as we were wont to do in the early morning and evening. I briefed him on the results of that and told him about the briefing and showed him the briefing, and as we left that evening I said I was still not quite satisfied and I wanted to call someone that I had great trust in, and I so did do that, to Mr. George Hardy of the Marshall Space Flight Center who had headed up the SRB for many years and then had moved up to be deputy engineering. And I had great faith in his judgment, and I asked him, how bad is it? And he allayed my fears, and I think it came from the fact that we did do a test that showed that we had a factor of safety of four on the 0.032-inch erosion that occurred.

Mr. SCHEUER. Isn't it clear that we really didn't know enough at that time to really come to any conclusions about a factor of safety except to know that we had life-threatening conditions to which we ought to have achieved answers before we went ahead? Isn't this what the report is all about, that corrective action was required prior to the next flight? And the fact is that you have learned more in this 6 weeks of collective effort through the expenditure of \$5 million and the application of 200 trained scientific and technical minds, than you knew through that entire 2-year effort up to the date of launch? Isn't that true? You really didn't know what the problem was with the seal erosion and with the margins for safety for eroded O-rings as of the time that that launch took place? Isn't that true?

Mr. WEEKS. I essentially agree with you, sir. That joint, with the putty problem, with the rotation problem, with the—

Mr. SCHEUER. Let's not get into technicalities.

Mr. WEEKS [continuing]. Temperature problems, are all very complicated and I agree that the effort after was extremely effective and we learned immensely after the accident.

Mr. SCHEUER. You learned immensely. Wouldn't you say that, with the benefit of hindsight, that following the warnings of that August 19 meeting to accelerate the pace of research into seal erosion, and to accelerate the tests for establishing margins of safety for eroded O-rings, the simple, clear message of that briefing was,

do your homework before going ahead with another launch because you have life-threatening conditions that are there which must be faced and for which solutions must be found? Wasn't that the clear meaning of that briefing on August 19?

Mr. WEEKS. Yes, sir.

Mr. SCHEUER. Why wasn't that done? Your boss knew about it; you reported to him that evening.

Looking at it in hindsight, what have we got to learn? Why didn't you and Mr. Moore and the other decisionmakers follow up on those recommendations and either do the work in the next 6 weeks—which would have been a replica of what you did in the last 6 weeks or so—or why didn't you postpone the launch until you had done your homework?

Mr. WEEKS. If we had known that clearly how crisply to do this problem, we certainly should have done it.

Mr. PACKARD. Mr. Chairman, may I just—would the gentleman yield for just a moment?

Mr. SCHEUER. I'll be happy to yield.

Mr. ROE. He was just finishing.

Mr. PACKARD. So that we can conclude this matter and not hammer on something that's not redoable, I think that the Commission's report makes a rather cogent statement that reflects directly on what the gentleman from New York is pursuing.

It says, "If the decisionmakers had known all the facts, it is highly unlikely that they would have decided to launch 51-L on January 28, 1986." And I think that that's what we're hearing from the witnesses. And I think that's what we're trying to determine, is how to avoid repeating this problem again. And I'm not sure that it would be productive to pursue it further.

Mr. ROE. Well, the Chair has allowed this discussion to go this far simply because of the point of view that I believe that it's a subliminal issue—Mr. Weeks, you have become quite, what would you say, well known throughout the Nation—what Mr. Scheuer wants to do, and the gentleman from California understands, is just to get on the record the sequence of events that took place. And I think you've done a good job in making that presentation.

Mr. SCHEUER. Mr. Chairman, may I add one more sentence?

Mr. ROE. Yes.

Mr. SCHEUER. I think this has been very helpful, and I wish to express my feeling that Mr. Weeks has been forthcoming in his testimony. It took a little time, but he's given us what seems to be a NASA view. They should have known a lot more before they proceeded, in hindsight. Any other conclusion would be difficult to come to.

There's been a lot of fingerpointing here at Marshall, but I think it's fair to say that central headquarters, also, has played a major role in this, and I think that we shouldn't forget this as we proceed with these hearings, Mr. Chairman. I hope we'll have a chance to ask Mr. Weeks to come back. He's been very helpful today. I appreciate his forthcoming testimony, and I hope I will have the chance to ask him further questions.

Mr. ROE. I thank the gentleman from New York.

Mr. PACKARD. Would the gentleman yield?

Mr. SCHEUER. Can I yield to my colleague, Mr. Nelson?

Mr. ROE. If I could just chair the meeting, then I will let you yield.

Mr. SCHEUER. Very good.

Mr. ROE. I would like to make it clear to all of our Members that there's no one that's going to—we seem to have—I don't know; maybe it's the Ides of June. There seems to be a little testiness today, unnecessarily. I think the Chair has been overabundantly generous to every Member about any particular issue, any particular area that they chose to make their points, to be able to make them. And I intend to see that the hearing continues under that decorum and under that direction. And no one will be precluded from their point and their opportunity. I want to make that point abundantly clear.

I want to make another point clear. I think it ought to be said at this point, in this stage of the hearings, we have work yet to do and very important work to do. And I think we've successfully come to a point where, as far as the obligations and responsibilities of the Commission, they have made a report. We are now very, very carefully and very legitimately following up on it, point to point. Everybody, practically, at this table one time or another has said there's plenty of blame to go around. There is for everybody. That is not our mission. Our fundamental mission is to understand what happened, why it happened, and how we correct it and what policies we set for the Nation. That is the purpose of this hearing.

Now, there will be some blood and some scar tissue, I'm sure, when we're done. But it's going to be fair and it's going to be honest and it's going to be just, and I think that's the direction in which we have been continuing and that's the direction in which we will continue.

Now, having said that, I will yield to the distinguished gentleman from Florida, Mr. William Nelson, because he has a series of questions he would like to ask.

The Chair recognizes the distinguished gentleman from Florida.

Mr. NELSON. I appreciate it. The reason I had asked the gentleman from New York to yield was that I just wanted to follow up, just with a question or two, to Mr. Weeks.

After this famous meeting that occurred in August, did you or anyone else issue instructions to Marshall or to Kennedy to take care of those three problems that were noted in the Thiokol report?

Mr. WEEKS. Yes, Mr. Paul Herr sent a memo to Marshall following up on the August 19 meeting, and I can't remember the date of Mr. Herr's memo.

Mr. NELSON. All right. May we have a copy of that, please?

Mr. WEEKS. We will find it for you. Yes, it's available.

Mr. NELSON. Fine. Send that to me personally, please, and to Mr. Scheuer.

[The information follows:]

Material requested for the record on page 149, line 3651, by Mr. Nelson on June 12, 1986.

Memorandum dated August 23, 1985, signed by Paul Herr reference Headquarters, meeting on SRM "o" ring briefings is enclosed.

MPS

August 23, 1985

TO: Marshall Space Flight Center
SA41/Manager, Solid Rocket Booster Project

FROM: MPS/Manager, Solid Rocket Motor Program

SUBJECT: Headquarters SRM FWC-STA/"O" Ring Briefings

As a follow-up to the SRM briefings to Headquarters on August 19, 1985, please provide the following:

I. FWC-STA

- a. pre-launch loads at WTR and ETR with and without winds.
- b. inspection plans for VLS-1 pre and post FRF.
- c. rationale for new FWC segment - could DM-7 segment be used to avoid costs?
- d. results of forward segment inspection.
- e. pictures of failed aft segment.

II. "O" Rings

- a. provide a copy of "O" ring validated (TWR-14952)
- b. schedule and cost to incorporate the captive feature on future segment buys.
- c. data on pre launch loads causing joint rotation.
- d. results of post flight torque tests of nozzle and ingiter bolts.

Thanks again for two well done briefings on the SRM here at Headquarters.

Paul N. Herr

Mr. NELSON. All right. Now, Mr. Weeks, what specifically does it mean in the Thiokol report when it says, "meet O-ring squeeze requirements?"

Mr. WEEKS. The basic limit, Mr. Nelson, on the minimum squeeze is $7\frac{1}{2}$ percent of the diameter of the O-ring itself, so that means roughly that you shall not have a squeeze less than 20 thousandths, approximately, on the 280 thousandths O-ring.

Mr. NELSON. Were those requirements met on 51-L?

Mr. WEEKS. I believe so. In fact, I think that John Thomas could probably answer that, but I believe it was in the vicinity of .035.

Mr. THOMAS. Yes, sir, that is correct. They were met.

Mr. NELSON. OK. Now, was there a concern about excess squeeze or maximum squeeze?

Mr. WEEKS. Yes, I believe so. But as I understood the problem then—and I guess as I do now—the more serious one is when you get the rotation with the minimum squeeze, which then, if you don't have good resilience, doesn't fill up the gap and contain the gasses. But I believe there is a concern at the high one, but I don't believe it's the crucially serious one.

Mr. NELSON. All right. Were these squeeze requirements met on all of the flights after August 19, 1985?

Mr. WEEKS. I can't be totally authoritative, but I've never heard anyone say that they did not.

Mr. NELSON. OK.

Mr. Thomas, do you have any information with regard to that?

Mr. THOMAS. No, I don't.

Mr. NELSON. OK.

Supply that for us, Mr. Weeks, if you will.

[Material to be supplied follows:]

Material Requested for the Record on Page 151, Line 3684, By Mr. Nelson on June 12, 1986.

The calculated O-ring squeeze, using actual measured case tang and clevis dimensions for 51-I (flew on August 27, 1985) and subsequent missions are shown below:

		<u>FIELD JOINT</u>		
<u>STS</u>		<u>FWD</u>	<u>CTR</u>	<u>AFT</u>
51-I	LH	11.2%	11.5%	11.5%
	RH	12.8%	15.3%	14.6%
51-J	LH	9.8%	16.0%	16.6%
	RH	13.9%	16.1%	14.3%
61-A	LH	11.5%	12.5%	17.0%
	RH	16.0%	15.6%	15.6%
61-B	LH	13.9%	15.3%	13.2%
	RH	8.8%	16.5%	12.9%
61-L	LH	14.6%	10.5%	16.3%
	RH	13.9%	16.3%	14.2%
51-L	LH	10.2%	13.2%	13.4%
	RH	12.5%	13.1%	14.3%

Mr. NELSON. OK. Mr. Chairman, I want to now pick up the question that I asked in Dr. Fletcher's absence yesterday morning. I asked Admiral Truly, and he said that Mr. Lee would supply the answer today, so if Mr. Lee would come up.

Mr. ROE. Mr. Lee, please.

Mr. NELSON. I further privately discussed this with Dr. Fletcher, and it gets into the question of the testing and analysis requirements on the whole SRB—not just the joint, the whole SRB. Under the design specs it was to go down on natural environment down to 31 degrees, and under induced environment it was to go down to 21 degrees. And there were supposed to be testing and analysis on this, and the reason this was raised was when you briefed this committee down at the Kennedy Space Center on Friday, you told us that you had no evidence that such testing and analysis in fact was done.

Would you restate that for the record, as to what you told us Friday?

Mr. LEE. Yes, sir, Mr. Nelson.

With your permission, you stated that the lower limit on the induced temperature was 21—was 26, I believe, 26 degrees Fahrenheit?

Mr. NELSON. No, sir; not in these documents. It says 21 in there, but be that as it may, let's go on.

Mr. LEE. It is, in fact, 26 degrees.

The finding that the Commission's production and development—

Mr. NELSON. Well, let's just clarify that. I have a document here—as long as we're going to get specific—NASA Technical Memorandum. Is this the cover page for it?

Mr. LEE. I believe so.

Mr. NELSON. OK. Dated November 19, 1973, Marshall Space Flight Center. It gives temperature, degrees Fahrenheit; talks about the aft attachment; talks temperature in degrees Fahrenheit; hot, max of 96; cold, minimum of 21.

Mr. LEE. I'm not familiar with that particular document. I was referring to the overall systems specification that is from the shuttle—overall specification which is imposed on our element contractors, and that is in fact 26 to 120 degrees Fahrenheit, induced.

Mr. NELSON. All right. It's a minor point; we'll clarify it later on between the exchange of paper.

Dr. FLETCHER. Mr. Nelson, did you say 1973?

Mr. NELSON. That's correct. That's the date.

Dr. FLETCHER. I'm not sure, but that could have been before Morton Thiokol was selected. I think we ought to check the date, but I believe that was an early spec that may have been changed by the time we had the solid rocket contractor on board.

Mr. NELSON. All right, we'll check it.

Go ahead.

Mr. LEE. Mr. Sutter's commission team, which I supported, found that the requirements for that specification were satisfied by the Morton Thiokol Co. through either qualification testing, analysis, or inspection or acceptance testing. Now, in the case of the seal joint itself, for the certification—the acceptance of the certification of that joint—it was specified to be done by analysis. That was pro-

posed by the Morton Thiokol Co., and the Marshall Space Flight Center accepted that, by analysis.

As I stated this morning, the interpretation of that induced requirement by Morton Thiokol was not associated with vertical flight, but more as a storage temperature. So, given that situation, their limitation or band, range of temperatures for qualification, to them was that associated with the mean bulk temperature, which they believed encompassed all environmental requirements for the motor from a qualification standpoint—was 40 to 90 degrees. Now, that's what they did in fact state to our team when we reviewed this.

It is my interpretation and the writer of the specification, the keeper of that spec at JSC, and the project office—the solid rocket booster project office—at Marshall, that the intent was to be 26 to 120 through vertical flight. Now, that makes a difference in the way you go about satisfying or certifying them. In any event, the certification method was by analysis, and the data presented to certify that environment to the Government, if you will, was a MIL-SPEC on the O-ring which states clearly that the O-ring can be operated between the temperatures of minus 30 and 500. Now, the interpretation of the meaning of that certification on the part of the Government was that the O-ring was the critical part; it did, in fact—was usable through those ranges.

Now, in hindsight it is determined by Mr. Sutter's team that the proper imposition, if you will, for the method of certification probably should have been by test, which it wasn't, in light of the accident; and the stated satisfaction, if you will, by analysis of using only the O-ring spec was inadequate or improper.

So the issue is around the interpretation of the specification and, in light of the accident, we should have gone through a full-scale qualification through all those environments. So there was a misinterpretation and probably a lack of imposition, if you will, or inadequate imposition of the method of qualification. And that was, in fact, the issue that our team came out with, is that under items of this type of criticality, the method of certification and qualification should be further scrutinized and ensure that they do in fact go through the full qualification range. That was the intent of the whole thing. Not to imply that Morton Thiokol did not satisfy their contractual requirements.

Mr. NELSON. Friday, you showed us this same chart that you showed us today, which said "significant findings," and the first one is, "qualification not accomplished to required spec limits."

Mr. LEE. That's right.

Mr. NELSON. You explained that Friday at the Kennedy Space Center, and you said that the adequate testing and analysis had not been done. And when I asked why, you said nobody knows why.

Mr. LEE. I'm sorry, I don't remember giving exactly that answer. I believe, in answer to the question, I stated that the people who were there at the time in the development program, back in the late 1970's who were in fact required to interpret the adequacy of that certification, who actually signed off on the certification and qualification, are no longer with us. I believe that was the intent of my answer, as opposed to "no one knew."

Mr. NELSON. OK. So what you are saying today is that analysis was required, which in fact the documentation shows, for both the natural environment and the induced environment; and you're saying that the interpretation of what analysis should be was that it would go down to 26 degrees in a stored condition; is that correct?

Mr. LEE. Yes, sir.

Mr. NELSON. But that's not what the design specs call for, and I read from 3.2.2.1.17.2, which is on a document entitled, "Space Shuttle Flight and Ground System Specification," dated September 30, 1983, from the Johnson Space Center, and let me read for you: "Induced environment: Each element shall be capable of withstanding the induced environment imposed during transportation, ground operations, handling, and flight operations." Flight operations, OK? Now, how could they come to an interpretation that that meant only for storage?

Mr. LEE. I don't know that, Congressman. I only know that the people on my team who evaluated it interpret it the same way you do. The writer of the document interprets it the same way you do, and I think the project office does. I cannot answer for why Morton Thiokol did not interpret it that same way during the development program.

Mr. NELSON. Well, first of all, we have two verification completion notices that have been signed. This induced environment is in fact one of the verification requirements completed and signed off. One verification completion notice is done just before STS-1, and the second one is done just before STS-5. So the obvious question is, why were they signed?

Mr. LEE. Are they Government signatures?

Mr. NELSON. Yes. There's a whole raft of signatures here.

Mr. LEE. Well, again, the basis for that certification was, in fact, what was interpreted to be the completion of the analysis, and that was the O-ring itself was in fact a MILSPEC designed to go from minus 30 to 500 degrees Fahrenheit.

Mr. NELSON. Well, you're talking about the—that doesn't answer the question. The answer to the question—what you're saying is that you don't know why these were signed because the analysis was not done according to the design criteria.

Mr. LEE. No, sir. I'm saying that it was established that the certification would be completed by analysis. I'm also stating that the analysis in this case was the recognition that the O-ring itself was good to be used between the temperatures of minus 30 and 500 degrees; that's the documentation which I have seen that was used to say this is, in fact, certified for those temperatures.

Mr. NELSON. If the design specs say otherwise, then who made that determination that they were going to test—or analyze, in this case, analysis—to a different standard than in the specs?

Mr. LEE. Well, the determination to certify it by analysis was proposed by Thiokol and approved by NASA. The method for that analysis happened to be the MILSPEC, and the MILSPEC calls for a temperature range which encompasses the 26 degrees to 120 degrees.

Mr. ROE. Will the gentleman yield for a clarity, please?

Mr. NELSON. Certainly.

Mr. ROE. The question that's being asked, and the distinguished gentleman, Mr. Lee, comes back and says "they decided that we would do an analysis." Then we would have him carrying on about 20 minutes of dialog relating thereto. But the fundamental question is, Who decided we would use the analysis approach? Who made that decision?

Mr. LEE. That was approved at the project office level within Marshall and our project office level at Morton Thiokol.

Mr. ROE. Now, think what you said. It was approved by, and I asked you who made the decision.

Mr. LEE. Oh.

Mr. ROE. Did it come from Thiokol? Did it come from NASA? Was it from Thiokol-NASA corroborative?

Mr. LEE. I'm sorry. It was proposed by Thiokol, by the company.

Mr. ROE. So are we saying, for the record, that that initial decision to use the analysis approach was suggested or recommended by Thiokol; but however, after review, the NASA authorities—whoever had the jurisdiction—approved that approach. Is that correct, for the record?

Mr. LEE. Yes, sir.

Mr. ROE. The gentleman from Florida will proceed.

Mr. NELSON. All right. Thank you, Mr. Chairman.

I think another hindrance in our conversation here—and, you know, isn't that interesting? You know, it's just a human foible of communication; and that, in large part, Dr. Fletcher, is what the Rogers Commission has pointed out. It's a mistake in communication that occurred in so many areas.

So in trying to hone in the clarity of our communication, let's make sure. You're talking about—that an analysis was determined on the basis of the O-ring itself. But that's not what the design requirement was. The design requirement is for everything on the SRB, not just the O-ring. If in fact this document that I have is an accurate one, here, entitled—from Johnson Space Center—"Space Shuttle Flight and Ground Systems Specification, Level 2 Program, Definition and Requirements," September 30, 1983, and it clearly says what are the design environments, the natural environment as well as the induced environment. And it clearly includes flight operations, and it says each element. It doesn't say just the O-rings.

So when you get into your analysis and then you start signing off on these verification completions—Mr. Lee, I'm not picking on you. You all have done an excellent job. By the way, Dr. Fletcher, I wanted to compliment you; you know, what we learned on Friday and subsequent, my private conversations with Chairman Rogers, he thought that your NASA investigatory team did an excellent job, the ones that we've heard the reports from each of the people today, and basically, you know, what you all concluded and reported here today and reported to us last Friday is in fact the same facts that the Commission reported.

But now we find a specific question here. Why were these verifications signed off on for a requirement in the design specs? Does anybody have any clues? Anybody?

Dr. FLETCHER. Mr. Nelson, of course, this happened when I wasn't here, but I'm sure you are aware that there's a difference between a component requirement—which is the O-ring, which had

the MILSPEC on it and which was accepted as an analysis—and the system of which it is a part, which includes the O-ring and the groove into which it fits and the whole seal. And I think what we're seeing here is, we accepted the MILSPEC on the O-ring but we didn't have adequate verification that tests were made on the whole system, which is the seal.

Mr. NELSON. Including the putty.

Dr. FLETCHER. That just plain fell through the cracks.

Mr. NELSON. Including the putty.

Mr. LEE. Yes, sir.

Mr. NELSON. The putty wasn't tested down to 26 degrees, was it?

Mr. LEE. That's true.

Mr. NELSON. Well, I'll just yield to my friend from California.

Mr. ROE. The gentleman from California.

Mr. PACKARD. I appreciate that. My line of questioning doesn't necessarily follow on the gentleman's from Florida, although that—

Mr. NELSON. Well, you don't want to break my train of thought, do you?

Mr. PACKARD. I don't and so let me yield back. That was one of the questions I had, but he's pursuing it adequately.

May I ask the chairman to allow him to go ahead and complete?

Mr. ROE. Of course. You'll be next.

Go ahead, the gentleman from Florida.

Mr. NELSON. OK.

How—anyone; Admiral Truly, Dr. Fletcher—how do we go about determining whether or not such analysis was ever made? Do we know in fact today that the analysis was never made down to 26 degrees?

Mr. LEE. I think I can answer that. Because it was a concern to our group, when we found that particular situation around the joint, we did in fact review or attempt to find all documentation, all analyses, all tests to help support that, and we could not find any analyses other than that which has been stated relative to the MILSPEC for the O-ring. And that is, again, Mr. Nelson, one of the reasons that we, as our team, identified this as a finding, because we believed that it was in fact inadequate in the system.

Mr. NELSON. OK. Assuming that that is the case, that you all did not uncover this analysis—documentation of this analysis—assuming that it does not in fact exist, then what can we do to crawl inside the minds of these people, some—looks like about 24 signatures on this page before STS-1 in March 1981, and again in November 1982, before STS-5? What can we do to crawl inside their heads?

Dr. FLETCHER. I guess I'm the experienced manager in terms of team motivation, but basically it doesn't matter, Mr. Nelson, how many signatures are on the document as long as at least one of them has understood the problem, feels responsibility for pursuing the problem in the depth that is necessary, which I indicated was a systems problem, not just a component problem. We need to tighten up and make sure there are at least one—plus a checkup on that person—to make sure that it is done satisfactorily.

Mr. NELSON. OK. If you would do that, and if you would report back to us, I would appreciate it. And, while you're doing that, Dr.

Fletcher, there are some other people that you could perchance go to for additional information, and that is that we understand that a thorough review was made by a group of experts headed by Dr. Walt Williams, and that—so you had on these design specs, you had a lot of people overseeing it. You had Thiokol, you had Marshall, you had this outside group of experts, and the Aerospace Safety Advisory Panel. So let's see if we can crawl inside their heads, as well, and see if we can get any clarification on it.

OK. Mr. Chairman, if I may continue?

Mr. ROE. Yes. Are you on the same vein?

Let me give you a break and let's hear a little bit from—

Mr. NELSON. If you'd like to give me a break, Mr. Chairman, that's fine.

Mr. ROE. Well, you're going to be here for a while and so am I, so let's defer for a moment—

Mr. NELSON. I'd be happy to.

Mr. ROE [continuing]. For the distinguished gentleman from California.

Mr. Packard.

Mr. PACKARD. Thank you, Mr. Chairman.

I want to go back to the O-ring problem and ask some specific questions as to where we go from here, and I need a little background before we do.

In your judgment, as you've reviewed the Commission's report and as you've reviewed your own teams' research, do you feel that cold weather alone, devoid of water and ice in the joint, would have caused the accident? Without water and ice in the O-ring joint, but still having the cold weather, in your opinion would there have been an accident?

Mr. THOMPSON. I think the cold weather was probably the most significant influence in the four or five that John Thomas described today. It took us over the edge. That's my own judgment.

Mr. PACKARD. The cold weather, not the ice?

Mr. THOMPSON. That's correct.

Mr. PACKARD. Of course, the cold weather caused the ice, but that would be—

Mr. THOMPSON. The effect of the cold weather on the O-ring—

Mr. PACKARD. The temperature at 28 degrees or 29 degrees was more critical than the fact that it was ice?

Mr. THOMPSON. That would certainly be my judgment.

Mr. PACKARD. How many O-rings are there on the entire SRB—O-ring joints, excuse me?

Mr. THOMPSON. Two per joint, six field joints—

Mr. PACKARD. I don't mean O-rings, I mean joints. How many joints are there on one of the SRB's?

Mr. THOMPSON. There are six field joints.

Mr. PACKARD. Six? Total joints I'm asking, now, both factory and field.

Mr. THOMPSON. There are 14 total, I believe. Let me—

Mr. PACKARD. Well, all right. It's not critical, the number.

The factory joints—has there been any problem with the factory joints in the history of the equipment and our launch system? Have we had any history of problems as we've returned and recovered and refurbished? Have we looked at the factory joints?

Mr. THOMPSON. Yes, sir. They've been looked at and none have any—

Mr. PACKARD. And as we've looked at those factory joints, have any shown any deterioration of the O-rings?

Mr. THOMPSON. Let me check and make sure we've got no evidence of any erosion—I believe the answer is no, we have not. But in terms of being precise on that and making sure there's absolutely none on any factory joint, I'd like to be able to come back and confirm that there are none. I believe that to be the case.

Mr. PACKARD. So it's anticipated that if you find no history of deterioration of factory O-rings—

Mr. ROE. Would the gentleman yield for—

Mr. PACKARD [continuing]. Then you would not anticipate any redesign of those particular factory joints?

Mr. ROE. Let me add a point that I think is necessary for clarity right at this point.

The question, so that we all understand what we're talking about as I understand it, if the gentleman would yield, is that the configuration of the factory joints is identical with the O-ring configuration, as is the field joint. Is that a correct assumption?

Mr. THOMPSON. Yes, sir.

Mr. ROE. All right. So therefore—just for clarity—what we're saying is that, regardless of what the issues are involved, factory or field, it's identically the same mechanism, same structure?

Mr. PACKARD. Is that correct, Admiral Truly? Because I've gone on that assumption.

Admiral TRULY. The configuration of the O-rings, which was your question, is identical between factory and field joints. There is a design difference, however, because the factory joints are covered with insulation at the factory, with propellant poured over that insulation, and that is the single difference.

Mr. ROE. Well, if the gentleman from California would yield, one of the issues that emerged in the discussion today that related to where that extra smoke came from, came from the exchange of views that the interpretation—I believe Mr. Thomas—that in testing further—I believe it was Mr. Thomas; I don't remember—that it was the insulation that added to that issue. Is that a correct remembrance? The insulation is above and beyond the oil and the grease and whatever and the organic material, Viton rubber or whatever, in the O-ring was part of the smoke. But in addition, what created a more volumetric amount of smoke involved, as you indicated, was some of the burning of the insulation. Is that a correct point? That's what you said. And the question of the gentleman, if I may, is that this same type of insulation that's used in the field O-joint insulation is the same kind of insulation that's used in those joints that are factory sealed. Is that a fair commentary, the gentleman from California?

Mr. PACKARD. Yes.

Mr. ROE. That's what we're trying to find out.

Mr. THOMPSON. Would you give us a minute and let us get the vu-graph—

Mr. PACKARD. Please. Let me pursue with my questions and then come back, if I may.

The thrust of my question—or the end result—is to find out if we're having a different history with the factory joints than we are the field joints. I think we are; is that correct? Obviously, we're not showing a problem with the factory joints.

Two questions that I would like answered, one very simple. If we see no real problem and have no real history of problems with the factory joints, will they be included in any redesign? Will it be necessary to redesign those, along with the field joints?

Mr. THOMPSON. I know that's all being looked at, but let's get John Thomas to answer that. He's heading up the redesign team.

Mr. THOMAS. First, to clarify the configuration. The field joint from here outboard looks identical. From here inboard, the insulation comes right down this way—the edge of the insulation comes right down this way—and back against the case, and all this area here is then filled with propellant. So there is no gap in the insulation at this joint; it's a continuous path of insulation over the joint.

Mr. PACKARD. Let me pursue it a little bit, then.

The rotation has proven to be one of the problems under cold weather conditions relating to the accident. Do we find the same rotation problems at the factory joints as we do at the field joints?

Mr. THOMAS. Yes, sir, just to a little bit lesser degree because of the influence of the continuous insulation across the skin. But it is, for all intents and purposes, the same.

Mr. PACKARD. And do field joints have the same—are they subject to the same problems of the cold weather as the field joints?

Mr. THOMAS. Yes, sir, they are.

Mr. PACKARD. And so they could fail under a set of circumstances similar to what we found failure, here in this accident?

Mr. THOMAS. It is conceivable that they could fail under that set of circumstances. However, the joint is susceptible to the same degree of hazard as is the case, about 6 inches away from it. And that is that if the insulation burns through, or for some reason is fractured to the case, even at the point where there is not a joint, you would have erosion of the metal and weakening of the metal and a failure just as you would a joint. So in this case, where you have insulation over it, it is essentially a continuation of the membrane.

Mr. PACKARD. Well, certainly, we know that—we've seen no breakdown or evidence of failure of other joints other than the one that ultimately has been identified as the cause of this accident.

I'm intrigued by the fact that all of the problems in combination that caused this accident, or the accident-causing joint and those that contributed to the cause of the accident, all fell into one specific area. I'd like to know if that's by chance, by coincidence, or whether in fact that is predictable and was predictable.

We're looking now at about the 307-degree point on the field joint in the rear right booster. It was the coldest spot on that booster at that particular time of day when launch took place. It was the most—it had the most stress because it was next to the strut, and also because it happened to be the point of the maximum O-ring squeeze. All of that came at the same point, or essentially the same general area on that joint. Is that simply coincidental? Or in the shipping of it, where it goes out of round, do they ship that section, that particular section of the SRB, in the same configuration

so that every section for every flight would be out of round and put the same kind of squeeze pressure around that same strut, that 307-degree area?

Mr. THOMAS. The cases are shipped—all are shipped in the same orientation, that is, with the 90-degree or tunnel position up on the rail car. They're all shipped in that configuration.

Mr. PACKARD. So that every out of round correction would put the stress or the maximum O-ring squeeze at the same point, flight after flight?

Mr. THOMAS. I would say not precisely at the same point, but on that side of the vehicle.

Mr. PACKARD. So that it wasn't coincident that all things seemed to zero in to that one specific area?

Mr. THOMAS. I think there—excuse me, sir.

Mr. PACKARD. It certainly wasn't designed that way, but that's the way it happens to be. OK.

I'd like to pursue if I may, Mr. Chairman, just briefly, this whole question of cannibalism and the extra workload—and we can turn the lights on if we like.

It is alarming that 45 parts out of 300 had to be cannibalized from another shuttle or another piece of equipment. That has to mean that there was a significant amount of cannibalism from flight L-51 to the previous flight, which I think our gentleman from Florida was on. Is that true?

Mr. UTSMAN. Yes, sir.

Mr. PACKARD. I have to assume that the very process, the human process, of removing from one and putting it onto another simply geometrically increases the potential for error, for problems. Is that correct?

Mr. UTSMAN. That's correct, sir.

Mr. PACKARD. It not only increases the possibility of error, but it certainly contributes substantially in this case, where it became almost a graduating process of increasing the workload of the people. As we increased the amount of cannibalism, the amount of change from one flight to another to get the flight off on schedule, that became—and that was exacerbated by increasing the flight schedule from what was initially planned to be 16 and then up to 24, or over a process—that must have put incredible pressure on the crew—not the crew of the flight, but the personnel involved in making these changes. Is that correct?

Mr. UTSMAN. It was one of the frustrations that did get to our launch teams.

Mr. PACKARD. It came back to this committee long before the accident that this was becoming a problem, that we were overworking, possibly, the personnel. That, in addition, could create enough of a problem for where—well, when people are overworked, sometimes things can be overlooked.

Is that because we have not had adequate spare parts in inventory?

Mr. UTSMAN. Yes. The reason you cannibalize is because you don't have a spare part to draw from the shelf.

Mr. PACKARD. And not having adequate spare parts, did we find that in this particular case that we had to remove from other

pieces of equipment, parts that were—that are now in retrospect attributable to the accident, the O-ring joint and any of that area?

Mr. UTSMAN. No, sir. All those attributed to the joints are expendable parts.

Mr. PACKARD. I would have assumed that.

So what parts generally are cannibalized?

Mr. UTSMAN. It's normally parts that are high value, critical parts on the orbiter, and the common thread that normally runs is that there has been some problem where they are in a repair cycle, or the repair rate may have been slightly higher than anticipated.

Mr. PACKARD. What effect will that have, or would that have had, on the Galileo and Ulysses missions that were scheduled to fly in May, this past May? Would that have reached a point—it was a progressive point and getting worse and worse as far as the cannibalism and also the extra workload that that was creating? Would that have created a possible delay in those two flights, which had a very narrow window?

Mr. UTSMAN. Obviously, the answer to that is speculation. My own personal feeling is it would have created large frustrations with the work force. I think that it would have forced us to look at priorities and work arounds. My own personal belief, we would have found work arounds, but it certainly would have been a higher work factor and a frustration factor.

Mr. ROE. Would the gentleman yield on that point?

Mr. PACKARD. I'd be happy to yield.

Mr. ROE. For the record, why—just two points. Why don't we have enough spare parts? Is it inadequacy in funding by Congress? Or has there been some other decision process that gets in the way there? For the record.

Dr. FLETCHER. I'd like to start, Mr. Chairman, with that because I have had a chance to look into that, both in my former capacity and more recently.

We have to recall that this is really an R&D Program; sometimes we call it an operational system, but it's really an R&D system. And for R&D systems, you don't really have enough data to go on to get adequate spare parts. Also, you only have four orbiters and the spare parts problem in that kind of a system is a lot different, say, than for a 100-aircraft fleet, especially a mature fleet where you've had some experience on spare parts. I don't want to say we couldn't have done better, because I'm sure we could have; but spare parts is not a trivial issue on any kind of an R&D program of this sort.

Now, having said that, I'm sure there are experts that are closer to it than I am.

Mr. ROE. Well, I think what I'm really trying to get at—if the gentleman will yield further—just for the record purposes, has Congress not provided adequate funding to provide the resources for spare parts? Or has part of the decision been made—whatever the reason may be—on NASA's part?

Dr. FLETCHER. To the best of my recollection, since that has come up before, Congress has provided adequate funds for spare parts. Whatever actions were taken to reduce the number of spare parts, if it was done, was done within NASA.

Mr. NELSON. Mr. Chairman, may I elucidate you further on that subject?

Mr. ROE. If the gentleman from California will yield.

Mr. PACKARD. I'd be happy to yield to the gentleman from Florida.

Mr. NELSON. Indeed, what Dr. Fletcher says is accurate. A case in point is last year. There has been a diversion of some of the funds that were authorized for spare parts by this committee. The specifics of that we can provide through documentation. This committee has come forth, recognizing continually that spare parts is a problem and going to continue to be; and yet, there was an administrative decision within NASA last year, as a case in point, that diverted some of the funds.

Mr. PACKARD. Let me just—if I can reclaim my time——

Mr. ROE. The gentleman from California.

Mr. PACKARD [continuing]. Pursue that for just one further question.

If the policy decision is made, or if budget constraints force that decision, that we would live with three orbiters, and cannibalism continued at the levels that they've been in the past, what kind of problems would that create for us in keeping any kind of a schedule like what we're talking about now, 17 flights per year?

Mr. UTSMAN. It would have created a large problem. We did look at it. Some of our people feel that we would have not been able to meet the schedule.

The key to it would have been to be able to generate a rapid turnaround response on repairs with the various vendors in order to compensate for things not on the shelf. We were working to be able to do that, and that was our only hope of being able to meet the schedule. It would have been extraordinary efforts in the repair cycle.

Mr. PACKARD. Certainly that's going to be a decision that this committee is going to have to grapple with in the future, as to how we deal with the spare parts problem and the cannibalism problem and the additional work that puts onto the personnel that get these off of the ground.

Mr. ROE. Will the gentleman yield at that point?

Mr. PACKARD. I would be happy to.

Mr. ROE. I know that both the gentleman from California and the gentleman from Florida are going to generate another series of questions, but I just want to—if I can intrude on that dialog.

The one thing I'm thinking about is the relationship of reusable parts as it relates to spare parts, as it relates to testing, which they're going to get into next. I think that becomes very important because of metal fatigue and so forth and so on. I don't know whether you want to start that or whether——

Mr. PACKARD. Let me just ask two short questions before we get into that, Mr. Chairman.

I'm interested in the putty because it's a part of this failed joint, and I want to make sure there's not any portion of that joint that we leave unattended in this hearing.

The putty is placed in Utah, Brigham City, UT; it is much colder there. It is a much different climate, different atmosphere and altitude and so forth. Have you, in our review and any tests or re-

search, found that the putty acts differently at the factory there in Utah compared to there at the cape?

Mr. THOMAS. Yes, sir, the putty will react differently at different temperatures.

Mr. PACKARD. In what way?

Mr. THOMAS. It will become more dense at cooler temperatures and lower humidity than it does at warmer temperatures and higher humidity.

Mr. PACKARD. Now, is the testing generally done in Utah on that joint?

Mr. THOMAS. Yes, it is.

Mr. PACKARD. So the putty is tested in Utah?

Mr. THOMAS. Right.

Mr. PACKARD. Have there been any efforts to test the putty and its function, the way it functions, whether it meets the design specs at the cape?

Mr. THOMAS. Yes. We have taken, during the investigation—taken the putty and conditioned it to the conditions that one would expect at KSC, and the conditions that one expects at Brigham City, UT and tested those and compared the results. We were using 80 percent relative humidity at 75 degrees and 10 hours for the conditioning of KSC putty and slightly less than that for Utah putty. We have not been, however, able to create—or produce—enough tests to create a trend that one is significantly worse than the other.

Mr. PACKARD. Well, at the factory—in your factory joints, obviously, the putty has remained much more—the integrity of that joint and the putty has been much more successful than it has at the field joints, where they have to put the putty in there at the cape.

Mr. THOMAS. Mr. Packard, there is no—

Mr. PACKARD. But tests have not shown where there has been any—well, maybe I have misunderstood that process.

Mr. THOMAS. There is no putty in the factory joints.

Mr. PACKARD. There is not?

Mr. ROE. Will the gentleman yield for a minute?

I think it might be helpful to your question on the putty, and help the committee, in the following way if I may.

There is some dialog going around, as the gentleman from California is pointing out, in reference to the putty issue itself per se, that originally—purportedly—NASA used one particular manufacturer of a particular type of putty which uses asbestos as part of the base, as I understand it. That company purportedly went out of business or wasn't going to make the putty any more, and another company was selected to do that. And there was a question as to whether or not the same formula was identical in the same putty issue.

Could you give us—the gentleman from California is here, and we think it's important to get it on the record—could you give us just a little background and a rundown on the putty issue? Because I think that bears upon what the gentleman is speaking to from California.

Mr. THOMAS. Yes, sir.

Mr. ROE. What factually happened there?

Mr. THOMAS. Your scenario that you just stated is correct in that the original supplier of the putty, which was a—I'm trying to recall the trade name for it—anyway, it was an asbestos-field vacuum putty that was—Fuller-O'Brien, I believe, is the name of it. They went out of—or they stopped making putty, and the putty that the—the new vendor for the putty, although it is asbestos-field as was the other, it is made by Randolph. And it has essentially the same consistency. It reacts a little bit more to humidity; that is, it gets a little less dense or a little bit less viscous with higher humidities, but it essentially serves the same purpose.

Mr. ROE. Then to finalize this point—

Mr. VOLKMER. Will the gentleman yield? The gentleman from California?

Mr. PACKARD. Yes, I'd be happy to yield.

Mr. VOLKMER. I would like to know, were any viscosity tests ever run on the putty at higher temperatures, or temperatures at the interior of the SRB, during firing?

Mr. THOMAS. We have run viscosity of the putty at varying levels of temperatures, but I don't believe we ran it up that high.

Mr. VOLKMER. I mean, the putty is subject to those temperatures when the SRB is being fired, is it not?

Mr. THOMAS. Initially, at the very end of the putty path between the two motors, initially there is the high heat rate. It will erode back with the propellant as it comes back toward the joint, but at the time that the propellant stops burning and then progresses up the bore, it becomes relatively cool.

Mr. VOLKMER. Well, you still didn't answer my question. Does the putty—is the putty subject to that temperature of the inside while the SRB is being fired?

Mr. THOMAS. It is subjected to that temperature.

Mr. VOLKMER. I know for a relatively short period of time, but it is subject to that temperature?

Mr. THOMAS. Yes, sir.

Mr. VOLKMER. And we don't know what the viscosity of it is at those temperatures?

Mr. THOMAS. Well, I think at those elevated temperatures, the putty just chars along with the propellant as it goes back.

Mr. VOLKMER. It chars?

Mr. THOMAS. Yes, sir.

Mr. VOLKMER. Do you know if it gets real runny, almost like real soft butter, anything like that?

Mr. THOMAS. No, sir, we don't believe it does because it stays a relatively cool temperature a short distance from the burning surface because it dissipates its heat back into the insulation. I can provide that for the record.

Mr. PACKARD. Let me reclaim my time and just ask a question and conclude this item on the putty.

Were any tests run on the putty before the accident?

Mr. THOMAS. Yes, sir, there were a series of tests run at the time that this transition took place from the Fuller-O'Brien to the Randolph putty.

Mr. PACKARD. And does—do we know the difference between the reaction of the putty when its being tested in the horizontal in Utah versus how it reacts at the launch pad?

Mr. THOMAS. I think it—I can't say that we've tested that specifically in the large motor. We have tested it in the small motor during the investigation, although we have—in the static motor tests at Utah, the putty has been examined from the inside to determine its characteristics. It has been repaired a number of times prior to test, and from that standpoint we understand its characteristics.

Mr. PACKARD. My perception is that perhaps NASA would do well to be more familiar with the actual formula for putty and how it operates. We may be leaving that to the manufacturers and to the contractors without us being fully familiar, and I can understand that, because we're certainly not.

One last question, Mr. Chairman. It's bothered me for the last 2 days; in fact, since we were down there and I saw the pictures of the launch pad, for the first time today I came to realize that pad B was used for the first time with 51-L, and I wasn't aware of that. And that means, then, that the failure of the freeze plan happened on the very first usage of the pad, and the water system.

Would you have launched—the decisionmakers for go or no go—would you have launched had the rains fallen and created the amount of ice, both in the joint and on the pad, to the same extent that the failure of the sprinkling system created? Would you have had a decision to launch had you had rain that would have caused those same kind of icicles and the same kind of water problems and ice problems in the joint as the sprinkling system did? That's a hypothetical question, but I think it's interesting.

Mr. UTSMAN. Well, I guess from the viewpoint—the analysis—let's take the ice on the fixed service structure and that. I think the analysis would have indicated, because the source of the icicles would have been the same, and so from that basis the decision would have been the same from that aspect.

As far as water in the joint, we did not know of the phenomena of water in the joint until after, as part of the investigation. And so I'm not sure I know what we would have done in that case. There may have been many other factors, though, on a cold night, raining like that, that would have much precluded that.

Mr. PACKARD. Well, I think you have seen the picture, of course, that we've seen in the report. And as you look at it, it becomes incredible that we would feel inclined to launch with that kind of environment.

In our briefing on Friday at the cape, one obvious way to prevent water—and thus ice—into the joint, which I think the Commission's report certainly indicates had a profound effect upon the resiliency of those O-rings—in fact, the report says that, perhaps not contrary to Admiral Truly's comment that the cold weather had more adverse effects than the ice and the water did, but at any rate, this report says that the ice did displace the O-rings, that it actually displaced them, which had an effect upon the ultimate seal.

Simply turning that seal over, reversing it so that it does not point upward—thus water and ice flowing down into that joint—would appear to be a simple way, although probably a costly way now to redesign. But certainly, it is an open trough; that clevis points upward; that allows the water to flow right down around the

tang fitting into the clevis. But we're not in the redesign business, but certainly that ice and water can easily be prevented from entering into that.

Admiral TRULY. Mr. Packard, you are exactly right. I think that probably, at this stage, would be a very costly fix, but I can assure you that the redesign fix will not allow water into that joint.

Mr. PACKARD. Mr. Chairman, I will yield back my time.

Mr. ROE. One of our colleagues suggested to the distinguished gentleman from California, praise be to the Lord to see a spaceship designed by the Congress. [Laughter.]

The Chair recognizes the distinguished lady from Tennessee.

Mrs. LLOYD. I thank the Chairman.

Mr. Chairman, we've been talking about safety throughout our hearings. I really think another thing we might revisit is how well we do manage risks, because certainly this determination has to be made on every flight.

The Washington Post had a very descriptive diagram, if you didn't see it, an article on May 25 that really gives us a very succinct description of the steps that are used to determine your risk management program. I'd like for Dr. Fletcher if you would, or someone else if you might like to just defer to someone else, to describe the elements of NASA's risk management activities, what really supports your risk management decisions.

Dr. FLETCHER. Well, I will start, Mrs. Lloyd, but risk management is a pretty generic term. Risk management is decided in headquarters in terms of what are the chances of an overall failure of the system under a given set of circumstances. When you get down to the flight team, the launch crew in those last several hours or couple of days, risk management is an entirely different thing. They have to look at the factors that have come up just before launch and assess whether this is a risk we want to take. This is a judgment question; you can't make calculations at this point.

Mrs. LLOYD. Well, I realize that on the day of the launch that might be the case, but Dr. Fletcher, I do think there are procedures and methods that are used to assess risk. I think Dr. Silveira testified before my subcommittee as well as Mr. Nelson's at a joint hearing last March on this subject, and if you would like me to speak to Dr. Silveira to address this question, it would be fine with me.

Dr. FLETCHER. Yes, I guess so.

Dr. SILVEIRA. As we had mentioned in the testimony that we had given previously to yourself and Mr. Nelson, the only time that we had gone into trying to assess a probability, if you will, or a risk, was as a result of a request that was made by DOE for their analysis that they were performing at that time, to assess the probability of failure of the vehicle, to assess the danger when we are flying the RTG's, the radioactive material.

As far as in our program and any major decisions that we would make, we have a number of reasons why our past history had indicated that that was not a good way of doing it. As a result, we don't use it generally in our risk management. We prefer using things like the failure effects and analysis that we do; the technical

engineering judgment, using things to control our failures rather than depending on a probability analysis to assess it.

Mrs. LLOYD. But basically, what do you do beyond the failure modes and effects analysis, Dr. Silveira?

Dr. SILVEIRA. Yes, ma'am. Any time, of course, that we do have a failure component, and we track these very carefully from our ground test program as well as our flight test program, we go back and make sure we thoroughly understand that failure and, of course, effect a redesign to ensure that that failure will not repeat itself.

Mrs. LLOYD. And you test the components at that time?

Dr. SILVEIRA. Yes, ma'am.

Mrs. LLOYD. Dr. Silveira, what was the basis for NASA's assigning a probability of 1 in 100,000 to a catastrophic SRB failure?

Dr. SILVEIRA. Well, as I say, as a result of a request from DOE to assess a number, we went back and attempted to look at various parts of the vehicle, various systems to establish a probability of failure of those particular components. When that was added to a statistical analysis—and indeed, a lot of these things don't lend themselves to statistical analysis; for instance, as I say, every time you have a failure you repair it, so you destroy your data base and you really don't have a good data base to go against. So as a result of trying to come up with these numbers for use in the safety analysis, our people developed numbers, went back and combined them, and then came out with a number that said it would be more like 10 to the minus 5 in our analysis, 1 in 100,000 cases.

Now, there are verbs that were in the shuttle data book that was the official transmission of that data, which I think that we had provided the staff earlier to look at, which said that indeed that was a case where a failure would be highly unlikely, that it was remote to happen.

Mrs. LLOYD. Well, yesterday, if you remember, reference was made to the report by Teledyne and Sandia and the Wiggins Co.—

Dr. SILVEIRA. Yes, ma'am.

Mrs. LLOYD [continuing]. And this claimed that the probability number would be somewhere between 1 in 34 to 1 in 10,000. So I just wanted you to explain this discrepancy for the record, Dr. Silveira.

Dr. SILVEIRA. Yes, ma'am. As you recall, back in about the 1977 time period NASA had commissioned the Wiggins Group to go and conduct a study for range safety purposes. Now, at that time we weren't looking at the vehicle with a Centaur vehicle on board and the like. And their analysis went back and looked at all the statistical data of all vehicles at that time and said that the probability of failure was like 1 in 57, in that order. Of course, we said that's like comparing apples, oranges, and things like that; there are a lot of vehicles in that family that don't relate to our vehicle. We think we're somewhat unique, both in the way that we operate and in some of the redundancy that we've provided and increased safety factors that we've provided in our design. And as a result, we felt that that study was not proper. Since that time, the Air Force has conducted additional studies with the Wiggins Group, that is now another group, plus Sandia and other people to try to assess what

they would figure—using, again, the statistical data base from previous experience with solid motors—and come up with a number that they had.

Where we left the study, their statistical numbers would come out like about 1 in 100. They said, we think it's really better for the reasons of more conservatism in the design and the like; they said it would be about 1 in 1,000. We said we still adhere to our number because we think a failure is highly improbable in the shuttle. We agreed that we would plug in the range of numbers, their 1 in 1,000 and our 1 in 100,000, and see how that would affect the end numbers as far as the safety as far as flying the radioactive material. And that was about the place we were headed at that time.

Mrs. LLOYD. Well, do you intend to revisit this decision? I certainly think we should make the very best risk management analysis that we could.

Dr. SILVEIRA. Yes, ma'am. Of course, we're going back and looking particularly at the "Challenger" tragedy to look at yields, how the vehicle failed; as you recall, another big discussion that we were having with the people that were reviewing us was the matter of how the vehicle broke up and the forward bulkhead analysis and—

Mrs. LLOYD. Well, are you looking at a statistical data base? It might really help you in your analysis.

Dr. SILVEIRA. Well, of course we will go back and look at whether there is anything else we can pull out there. But of course, we will still have a hard time in changing our statistical data base from anything we know as far as the *Challenger* is concerned right now.

Mrs. LLOYD. Well, could you establish a data base?

Dr. SILVEIRA. As far as probability of occurrence?

Mrs. LLOYD. That's right.

Dr. SILVEIRA. I think we would still have a hard time doing that and saying that we were going to use it for any management decision.

Mrs. LLOYD. Well, it would be an expensive project.

Dr. SILVEIRA. Well, if you mean go back and do testing on the thing—

Mrs. LLOYD. That's what I mean.

Dr. SILVEIRA. As we had in the shuttle data handbook, if we performed a certain function a thousand times, the only thing that we would—and did it successfully, tested a thousand times successfully—that would only give us a confidence factor that we would possibly have three failures in the next thousand events, with a 95-percent confidence factor. So we don't think that we could do that much testing. Of course, as soon as we saw any anomaly in that testing, we would go back, redesign, try to fix it, and then you'd have to reestablish your data base and start testing again.

Mrs. LLOYD. Well, it didn't work for the *Challenger*, and I feel that this is an area where we need to really revisit and look at it again.

Dr. SILVEIRA. Yes; ma'am.

Mrs. LLOYD. Thank you very much.

Thank you, Mr. Chairman.

Mr. ROE. I thank the gentlelady from Tennessee.

The gentleman from Pennsylvania, Mr. Walker.

Mr. WALKER. Let me say first of all, I admire the stamina of all of you, sitting there and so on for all this time and so on. You've done a remarkable job of testifying and so on, but you've also shown great stamina.

Let me ask just a couple of questions about whether or not you now see, as a result of the investigations done by your technical people, and also as a result of the Commission report, whether you now see changes in what you are going to do in flight rules. That may not be the best term, and that may not be a precise term, but I'm thinking about—you obviously are not going to fly in low temperatures now. You now know that very low temperatures are probably a reason not to fly on a particular day. There were other things that caused you not to fly in the past; if you had wet weather, for instance, you didn't fly because of the possible problem with the tiles.

Have you now developed another set of things growing out of the *Challenger* incident that will give you new points of departure each time that you fly, things that you will decide not to fly?

Admiral TRULY. As a result of the accident—and one of the things that I directed be done—was a complete reassessment of mission rules in the launch and abort mission phases, and the Mission Operations Directorate at Houston has taken that chore. Frankly, in the things that we're doing—No. 1, they're not through; they've not finished that, and if any specific mission rule changes have made to this point, I'm not aware of them. But I intend to review their work.

On your point about cold weather, I think there's certainly going to be an emotional reason not to launch in cold weather. I would put it a different way. We're going to make sure that whatever weather we launch in, be it temperature or environment—or clouds is one that we're totally confident that we have certified and tested to, and there is no doubt in anybody's mind, whether it be level 4, 3, 2, or 1, that we're ready to launch, no matter what the temperature is.

Mr. WALKER. Would it be helpful if this committee were to help you get a doppler radar at the Cape for better local forecasting?

Mr. ROE. Don't kick the gift horse in the face.

Dr. FLETCHER. I wish I was the one that is doing the weather analysis. Could I get Mr. Aldrich to come to the microphone if he's here, and answer that question and tell you where we are on our attempt to upgrade weather forecasting capability?

Mr. WALKER. Sure.

Mr. ALDRICH. Mr. Walker, we've been discussing doppler radar systems for better real-time understanding of the upper level winds for some time. And as I answered Mr. Nelson's question yesterday, we intend to pursue those systems for direct application for that use. My understanding so far is that it will be even more useful for the kind of upper level winds that we regularly see at Vandenberg than for Florida, and we have approved recently, with the Air Force, a test program of a doppler radar there. We are very encouraged that these will add to our capability, and certainly, we would be appreciative of support in providing these systems, as we can understand what they will contribute to our overall system.

Mr. WALKER. As I understand it, they would at least provide us with a better handle on wind shear; is that correct?

Mr. ALDRICH. We need to test to be sure we understand what they will tell us, and it's very promising and hopeful that they will, yes, sir.

Mr. WALKER. And when I talk about flight rules, the one thing that concerns me, having viewed your time line, and I raised a question briefly this morning on it, is that it appears as though the launch of 51-L—that at the time the maximum dynamics were on the craft, it was also a period of time when it was experiencing a wind shear problem, a fairly strong wind shear problem.

Will we be reviewing a pattern of not launching if we have reason to believe that we have significant wind shear at altitudes where the ship would be undergoing its most massive loads?

Dr. FLETCHER. Mr. Walker, as you know, we've always had launch rules which depend on wind shear at altitudes. What we're talking about with a doppler radar is having a better fix on that wind shear. We mostly have estimated wind shear from the magnitude of the winds and so forth, and estimated the wind shear. Measurement precisely will, of course, be improved somewhat by doppler radar, and I imagine that's what we're talking about. We have to really test and see how much better that is before we implement a doppler radar system.

Mr. WALKER. Well, I really do think that the wind shear question becomes an important one, at least in my mind. For example, have you correlated the winds aloft on 51-C with the winds aloft on 51-L, since 51-C is where I understand we also had fairly significant O-ring problem? Has that, as a contributory problem, been correlated at this point?

Mr. THOMAS. Yes; sir, we have correlated the—not specifically; I don't recall whether we did 51-C or not, but we looked backward to see if we could see any correlation that would show that this one was worse than any of the previous flights, and we selected the worst previous flight to compare. And unfortunately, I don't remember which one that was, whether it was 51-C or not.

Mr. WALKER. OK. When you went back and looked, did you find that on the two flights you had a fairly similar wind shear problem at the time that the load design on the ship was the greatest?

Mr. THOMAS. I don't recall that, Mr. Walker, I'm sorry, whether we did that or not. I would have to review the data. I just don't recall.

Mr. WALKER. I would appreciate if you would, letting us know on that, and getting back to us, because it seems to me that the fact that you had the initial failure that you see in the black puff of smoke, then the resealing, and then the understanding, now, that at the point that the ship was under the greatest dynamic stress loads, that it then failed a second time, or the failure became catastrophic, that it may well be that the winds also contributed to that particular problem and it would be, I think, very advantageous to know whether or not there is a correlation to past failures because it would certainly play a role, it seems to me, in some design conditions if we're finding that the buffeting of that ship by winds has a role to play. And it certainly would seem to me that

that then becomes a question on launch rules. Does that all seem logical?

Admiral TRULY. Mr. Aldrich would like to add a comment to that. He is very familiar with what happened on 51-L with the wind shears, and I think it would help you resolve this issue.

Mr. ALDRICH. All of these conditions we've discussed with 51-L were the result of a major cold front that came down from the central part of the country across Florida, and the conditions on launch day were the temperatures and the final winds at the back of that front.

The system we use currently involves balloon launches and some very elaborate calculations to try to predict the winds based on the conditions we know and see, and I think your point is well made, that there were some unique weather-related shear conditions here, potentially, that could not be predicted through those approaches. And we are certainly reviewing that, both in terms of other indicators that we might have had that would be in addition to the doppler weather, and in terms of changes and more conservatism in the rules for those kinds of weather patterns. And I think yes, all of those points are well made, and we are and will be looking at those.

Mr. WALKER. So that what you'll end up doing is establishing some different weather parameters for the launch director to use in making his decision, and they'll be more conservative than those you have used in the past; is that what you're saying?

Mr. ALDRICH. We will be looking at doing that, yes. I understand the weather community now assesses the general conditions to indicate a higher potential for shear, and we were in fact dealing with what our balloons and our calculations on that day—and you can't prove what was there at the exact time of the launch, but you can postulate that shears could have been more prevalent or more significant than what was expected.

Mr. WALKER. I thank the chairman.

Mr. ROE. I thank the gentleman from Pennsylvania.

The gentleman from Missouri, Mr. Volkmer.

Mr. VOLKMER. Thank you very much, Mr. Chairman.

I have several areas. First is a technical one. Can you tell me how it's possible to maintain a tolerance of plus five thousandths and minus three thousandths on a piece of rubber roughly one-fourth inch in diameter and 37 feet long?

Mr. THOMAS. The process is that the O-ring is formed, and then it is ground with precision instruments to that diameter. It is actually ground that way.

Mr. VOLKMER. All right. Now, at what temperature is it ground?

Mr. THOMAS. Ambient temperature.

Mr. VOLKMER. In the plant or factory, wherever it's done?

Mr. THOMAS. Yes, sir.

Mr. VOLKMER. And that could be 75 degrees or 80 degrees or 60 degrees? Somewhere in that area; I'm sure that they don't work when it's too cold. And we do know, as I asked down at Kennedy, we do have some loss in coldness, do we not?

Mr. THOMAS. Yes, sir; we do.

Mr. VOLKMER. And doesn't that then affect the amount of tolerance?

Mr. THOMAS. When we compute the squeeze—computed the squeeze numbers on 51-L, we took into account the differential coefficient of expansion of the rubber down to the lower temperature. And as I recall, that amounted to approximately three thousandths of an inch on the diameter.

Mr. VOLKMER. Now, is that three thousandths of an inch additional smaller in diameter? That's three thousandths smaller than it was in the factory?

Mr. THOMAS. Yes, sir.

Mr. VOLKMER. Now, if it was already down three thousandths because of the tolerances permitted, then you're three thousandths under, are you not?

Mr. THOMAS. When we compute squeeze on the O-ring, we use the minimum specification diameter, which is three thousandths less, or 0.277 O-ring, so it would be three thousandths below the 0.277.

Mr. VOLKMER. But if it came out of the factory with three thousandths less—

Mr. THOMAS. We assume that it does that in any case. We assume, in computing squeeze, that it is of a minimum diameter.

Mr. VOLKMER. All right. But what I'm trying to get out, the cold also reduces it three thousandths in addition?

Mr. THOMAS. Yes, sir.

Mr. VOLKMER. So now you're actually under the specifications, the tolerance level?

Mr. THOMAS. Maybe I should explain that the minimum O-ring squeeze is 7.5 percent of the diameter. And in order to assure that we have that, we take all of the worst case dimensions for the as-machined configuration of the metal and the minimum specification number for the O-ring, and then be sure that the shim that is installed into the clevis produces more squeeze on the O-ring than the minimum. And on 51-L, we still met the minimum squeeze condition with the 0.277 presumed O-ring and the three thousandths shrinkage due to temperature.

Mr. VOLKMER. All right.

To continue on with the O-ring, on page 158 of the Presidential Commission report, there is a document known as the SRB Critical Items List. On this it says, "A more detailed description of SRM joint testing history is contained in TWR-13520, Revision A." Have you all reviewed that, that testing history?

Mr. THOMAS. I'm sorry, sir. I don't recall which one that is. That, I believe, is attached to the Critical Item List revision of about a year ago. I don't recall—

Mr. VOLKMER. More than a year ago, because this document is dated December 17, 1982, so it has to be prior to 1982.

I'd like you to furnish us a copy of that document.

Mr. THOMAS. Yes, sir.

Dr. FLETCHER. We will do so, Mr. Volkmer.

[Material to be supplied follows:]

Material requested for the record on page 201, line 4926, by Mr. Volkmer during the June 12, 1986, hearing.

A copy of the requested document TWR-13520, REV. A is attached.

311

DOC NO. TWR-13520
TITLE

VOL REV A

RETENTION RATIONALE, SRM SIMPLEX SEAL

Howard H. McIntosh
Prepared by
Howard McIntosh

Rel - J. Jillette

1 December 1982

Thiokol / WASATCH DIVISION
A DIVISION OF THIOKOL CORPORATION
P.O. Box 524, Brigham City, Utah 84302 801/863-3511

①

RETENTION RATIONALE, SRM SIMPLEX SEAL

The SRM steel case joint design is common to the regular weight case and the light-weight case. All dimensions are the same and the assemblies are identical, including the shimming after assembly. The joint is basically a modification of the single O-ring Titan tang and clevis joint with the same tolerances, but allowing more clevis gap for horizontal assembly. A second O-ring provides a leak check test to be made, between O-rings, to verify the O-ring seal after assembly. Shims are used between the clevis outer leg and the tang to obtain the maximum amount of O-ring squeeze for sealing.

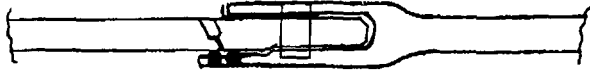

This report contains a summary of numerous tests and uses of the SRM joint to provide the rationale for the retention of the simplex seal. Total experience to date includes:

- a. Similar joints
- b. Leak checks at joint assembly
- c. Hydrotests
- d. Hydrobursts
- e. Static motor firings
- f. Motor flights
- g. Laboratory bench tests

Experience has shown positive functioning of the primary O-ring in all instances of use in the SRM tang and clevis joint. Testing has indicated positive sealing under adverse conditions beyond the required single pressurization for motor operation. It is concluded that considering the SRM joint as a single O-ring seal, sufficient rationale exists to retain this design with assurance of performance. A data base is also being established in support of the secondary O-ring positive sealing.

A. Similar Joint Use

1. The Titan case joint contains a single O-ring bore seal. The tang-clevis-pin joint design of the SRM uses the same design

REVISION A

FORM TC NO. 1899

PAGE 08

DOC NO. TWR 13520	VOL
SEC	PAGE 1

FEB 14 08 14:24 NASH MIT 82

tolerances as this well proven joint. Titan joints have a record of over 1100 joint use data points during the testing and throughout its flights with no loss of pressure. The SRM joint differences include: Increased clevis gap for horizontal assembly, second O-ring added to verify single O-ring presence and uniform shimming to center tang and close the clevis gap.

2. Initial assemblies of SRM joints contained no shims and all routine hydrotests are conducted without shims.

B. Leak Checks (Over-all total of 930)

1. All new segments have leak checks before hydrotest on all tangs and clevises. No leaks experienced.

a. Increment I 28 domes + 2x122 segments = 272 tests

b. Increment II 12 domes + 2x73 segments = 158 tests

Total 430 tests

Note: Vertical assembly
no leaks experienced

2. All plant joints have leak checks on case fabrication assembly and refurbishment proof test (in casting segment configuration).
Vertical.

a. Fabrication of 8 static tests - 56

14 flight cases - 98

4 GTM + STA-1 - 31

TOTAL 185

Two leakers experienced and debris found as cause

b. Refurbishment hydroproof of

7 static tests - 49

26 GTMs - 14

6 Flight Cases - 42

TOTAL 103 plant joint

No leakers experienced. (One stiffener to stiffener joint leak upon depressurization).

3. Field joints are tested horizontally at Thiokol for static firings only. All other leak checks are conducted with vertical assembly.

a. Static tests 8 x 3 = 24 checks

Repeats = 8 minimum

32

REVISION A

DOC NO.	TWR 13520	VOL
SEC		PAGE 2

FORM TC NO. 1808
PAGE 08

NASA MTI R2 FEB 14 1986 14:24

(3)

Four leakers experienced with 2 on DM-1 and one each on DM-3 and DM-5. No leaks after reassembly.

- b. CTMs were assembled at MSFC and KSC
 $4 \times 2 \times 3 = 24$ checks
- c. Flight checks at KSC $5 \times 3 \times 2 = 30$ checks
- | | | | |
|-------|----------|---|----------|
| extra | <u>1</u> | = | <u>1</u> |
| Total | | | 31 |

One leakler experienced and debris identified.

- d. Refurbishment hydrotest $17 \times 6 = 102$ checks
4. Extra checks on hydroburst, joint verification and STA-1 efforts produced approximately 20 checks with no leakers on first cycle joints.
- C. Hydrotests at Rohr, Thiokol and MSFC have been conducted at pressures above 1037 psig with no leakers.
1. At Rohr $150 + 85 = 235$ tests on segments
 2. At Thiokol $17 \times 4 = 68$ tests

Extra	=	<u>3</u>
		71 Tests

No leakers experienced upon or at pressure. (One stiffener to stiffener joint leaked upon depressurization).

3. MSFC tests on STA-1 pressurization with new O-rings produced no leaks even after 4 pressure cycles (experienced O-ring "pinching" during depressurization and nibbling after cycling).
- D. Hydrobursts -
1. Regular weight case joints were cycled with proof pressurizations and experienced leakage past the "nibbled" primary O-ring after eight cycles. After twenty cycles, the O-rings were replaced and maximum design pressurization was achieved (1.4 safety factor) however leakage past the rotated joint O-rings occurred at high pressures (1,480 psig or 1.58 x MEOP).
 2. Lightweight case joints passed all tests which included four cycles to MEOP (one with a planned defective primary O-ring) and an 1.4 MEOP pressurization. The joints were then sealed on the inside with vulcanized rubber to enable the burst to take place at 1550 psig.
- E. Static Motor Firings

No joint leaks have been experienced during eight horizontal static motor firings. Adverse conditions of joint movement from a "sagged"

REVISION A

	DOC NO. TWR 13520	VOL
	SEC	PAGE 3

FORM TC NO. 1209
PAGE 10

FEB 14 14:25 88 NASA WTI 02

position to flight position upon pressurization were experienced without joint leakage. A pressure reading, taken on each test, between the O-rings of the center field joint, showed variations in pressure traceable to joint movement (from vacuum to pressure above ambient).

- F. Five Shuttle flights have flown involving ten SRM cases with no evidence of a pressure leak past the primary O-ring of the joints.
- G. Laboratory Bench Tests.
 1. High pressure extrusion tests have shown pressure retention of a standard .280 in. dia. O-ring in a gap of 0.125 in. at 1600 psi.
 2. Low pressure check with the sealing surface defects testing device show remarkable sealing power of the single O-ring with large, deep and rough surface defects using minimum squeeze.

REDUNDANT SEAL DATA BASE - In order to establish a redundant seal data base, additional data are being obtained on all refurbishment hydrotests by checking the actual joint movement due to pressurization with a direct reading dial indicator through the pressure port. Initial information generated in a lightweight cylinder to cylinder proof test shows a total movement of only .030 in. at 1004 psig in the centerjoint (dial indicator in tang against land between O-ring grooves on the clevis inner leg). This test conducted in the normal vertical mode, indicates that the tang to clevis movement will not unseat the secondary O-ring at operating pressures. This one point data base will be up to ten points after DM-5 and STS-5 cases have been refurbished.

REVISION A

5

DOC NO.	TWR 13520	VOL
SEC		PAGE 4

FORM TC NO. 1809
PAGE 11

NASA MTI R2 FEB 14 08 14:25

Distribution

- E. Dorsey
- J. Kilminster
- C. Speak
- R. Boisjolly
- J. Leavitt
- R. Berte
- B. Brinton
- H. McIntosh (5)
- R. Laney

REVISION _____

FORM TC NO. 1808

PAGE 12

6

DOC NO.	_____		VOL
SEC	PAGE	_____	

FEB 14 1988 14:27 NASH INTL HZ

Mr. VOLKMER. Specifically, I'd like to have a copy of it.

I know we have a vote going on. I have several more questions.

To get into the question of temperature, what is more important, ambient or air temperature, or the temperature at the joint?

Mr. THOMAS. The temperature at the joint.

Mr. VOLKMER. Then why don't we, when we make a determination of whether we meet criteria in order to launch, require certain temperatures to joint?

Mr. THOMAS. That should have been a mission rule.

Mr. VOLKMER. It should be in the future?

Mr. THOMAS. Yes, sir.

Mr. VOLKMER. Now, does the—earlier we had testimony, yesterday, about the 31 °F temperature for the SRB itself. That only related to, as I understand it, to the total SRB or the ambient temperature at the time of the launch. Is that correct?

Mr. THOMAS. Let me ask Mr. Lee to respond to that. I'm not aware of it.

Mr. LEE. That is the natural environment, outside temperature, if you will, the 31 to 99 degrees. That's right.

Mr. VOLKMER. Right. That's the—so yesterday, when I asked a question on what the temperature was at time of launch, that was 36 degrees, that's the outside temperature also?

Mr. LEE. Yes, sir.

Mr. VOLKMER. That does not relate necessarily to the temperature of any part of the SRB, including the joints?

Mr. LEE. That's true.

Mr. VOLKMER. And as I guess we found out, it's more important to worry about the temperature of the SRB and joint temperature and other things, is that not correct?

Mr. LEE. Absolutely.

Mr. VOLKMER. Now, I'd like to ask anyone who wants to answer this question, if you want to do so—

Mr. ROE. Would the gentleman yield?

Is anyone planning on voting?

Mr. VOLKMER. Well, I'd like to.

Mr. ROE. Well, we're on the second call. Why don't you and I vote and come back again?

Mr. VOLKMER. OK, fine.

Mr. ROE. Why don't we suspend for about 10 minutes? We'll be right back. We should finish up in about 20 minutes.

[Recess.]

Mr. ROE. We will reopen this hearing for only a short period. We've just learned that there will be at least two to three more votes, and they're imminent. I've talked to Mr. Nelson and Mr. Volkmer, and we've agreed that we do have some additional questions but we will put those in writing and forward them to you. And should there be an occasion that we think we need additional personal testimony, then we'll be back in touch with you to see what we can work out.

Mr. ROE. Meantime, on behalf of the committee, I want to—and I know you have an observation you'd like to make, Dr. Fletcher, so if you would proceed.

Dr. FLETCHER. Mr. Chairman, I'd like for the record to personally express our sincere thanks from all of NASA to Princeton Univer-

sity for making J.R. Thompson available to the task force for these past months. I recognize the importance of his position at Princeton, and I'm sure his availability to us was not without significant impact to his work at Princeton. As you know, he's deputy director of the Tokamak Program down there. NASA and the Nation should be grateful; and I might add, I appreciate your forbearance, Mr. Chairman, for all of us in answering your questions.

Mr. ROE. Well, I appreciate that. And on behalf of myself and the committee, I want to thank you, Dr. Fletcher and Admiral Truly and Dr. Thompson and all of the other distinguished representatives of NASA that have testified over the last 2 days. I think your contribution to the record and your contribution to educating members of the committee and providing the substantive information in candor and right up front was what was necessary at this point of our proceedings. So we want to thank you for your patience, your forbearance, and your indulgence. It's been very productive.

Now, for the benefit of the other members that are here and the staff people, we will now, in effect, adjourn today, but we will reconvene on Tuesday at 9:30, and our first witnesses up will be Thio-kol. And then we're going to have in the afternoon the representatives from your Marshall Space Center. So that is what our schedule is.

Again, many thanks. We appreciate it. The hearing stands adjourned.

[Whereupon, at 5:02 p.m., the committee recessed, to reconvene at 9:30 a.m. Tuesday, June 17, 1986.]

INVESTIGATION OF THE CHALLENGER ACCIDENT

(Volume 1)

TUESDAY, JUNE 17, 1986

HOUSE OF REPRESENTATIVES,
COMMITTEE ON SCIENCE AND TECHNOLOGY,
Washington, DC.

The committee met, pursuant to call, at 9:30 a.m., in room 2318 Rayburn House Office Building, Hon. Robert A. Roe (acting chairman of the committee) presiding.

Mr. ROE. The committee will come to order.

We begin our second week of hearings in the Science Committee's investigation of the shuttle *Challenger* accident.

In following our schedule, this morning we will hear from witnesses from Morton Thiokol, the designer/manufacturer of the solid rocket booster's motor joint.

The design and functioning of this joint has been identified by the Rogers Commission as the prime cause for the shuttle's failure on January 28.

Charles Locke, chairman of the board and chief executive officer of Morton Thiokol will be accompanied by Edwin Garrison, president of the Aerospace Group; Joseph Kilminster, vice president; Carver Kennedy, vice president of the Space Booster Programs; Allan McDonald, director of the SRM Verification Task Force; Roger Boisjoly, staff engineer; and Arnold R. Thompson, supervisor of structures design.

This afternoon we will hear from Marshall Space Flight Center personnel. The committee considered it extremely important that we juxtapose the appearance of the Morton Thiokol witnesses with those from Marshall because it is this center that has the safety oversight responsibility for NASA's SRB Program.

The aerospace contractors have a major role and responsibility in the development of our Nation's space programs. The relationship between NASA and these contractors is a critical element in how these responsibilities are fulfilled.

We are anxious to hear from and to question this morning's witnesses. There is much ground to cover in a limited amount of time, so gentlemen, welcome.

I have a few other comments I want to make for the benefit of the members, but I will defer to our distinguished ranking member, Mr. Lujan from New Mexico.

Mr. LUJAN. Thank you very much, Mr. Chairman.

I, too, want to take this opportunity to welcome today's witnesses to our committee's investigation of the *Challenger* accident and to thank them for their appearance before us.

I believe that what we hear from them will be of critical importance in our search for the chain of events which led to the *Challenger* accident.

I encourage our witnesses to lend us a willing hand in determining the precise history of the field joint, the reaction of corporate management to design and operating problems as they became apparent, and the responses of the Marshall Space Flight Center to those problems.

It is important for us to determine to what extent NASA, including its field centers and its contractors, understood the problems of the solid rocket booster joint.

Both the Marshall Space Flight Center and personnel at Morton Thiokol will be afforded the opportunity to participate in a fair and open review of the facts today.

As this committee conducts its investigation, it is imperative that we determine who said what to whom, when, and where, and what was then done about specific problems relating to the joint. And we must understand exactly what went wrong in the chain of communications between the contractor for the solid rocket booster and NASA.

For my part, I want to understand how key personnel executed their responsibilities. All of us need to understand whether we are dealing with a compound failure in implementing a highly complex management system or whether the system itself is, in the words of the Rogers Commission, flawed.

Further, I am deeply concerned by an apparent failure in the certification process. NASA believed that the SRB was certified for flight temperatures of 21 degrees Fahrenheit, and apparently it was not. During the course of our hearings we will find out how much of this was due to contractual ambiguities, misinterpretation, a failure of the contractor and/or a failure of NASA to monitor the contractor properly. Our investigation will not be complete until we have the answers to these questions.

Thank you very much, Mr. Chairman.

Mr. ROE. I thank the distinguished gentleman from New Mexico.
[The prepared opening statement of Mrs. Lloyd follows:]

STATEMENT

HON. MARILYN LLOYD

JUNE 19, 1986

WITNESSES

MORTON THIOKOL

MARSHALL SPACE FLIGHT CENTER

MR. CHAIRMAN. LAST WEEK THE COMMITTEE HEARD FROM THE ROGERS' COMMISSION AND NASA OFFICIALS ON THE SHUTTLE CHALLENGER ACCIDENT. IT WAS CLEAR TO ME THAT THE MAJOR GOAL FOR THE COMMITTEE WHICH CAME OUT OF THOSE HEARINGS IS THAT WE MUST INSURE THAT NASA CAN FLY SAFELY IN THE FUTURE. IT IS CLEAR TO ME THAT FOR THIS GOAL TO BE ACHIEVED THERE ARE TWO MAJOR REQUIREMENTS: 1) THE SOLID ROCKET BOOSTER (SRB) DESIGN MUST BE FIXED, AND 2) INSTITUTIONAL FIXES MUST BE MADE IN NASA IN TERMS OF RISK MANAGEMENT COMMUNICATIONS AND RELATED DECISIONMAKING. PURSUING THE QUESTION OF INDIVIDUAL CRIMINAL NEGLIGENCE AND RELATED LIABILITY SEEMS TO ME TO SERVE NO USEFUL PURPOSE. IN FACT, SUCH AN APPROACH CAN ONLY SERVE TO DISCOURAGE PROGRAM MANAGERS IN NASA AND AMONG HER CONTRACTORS FROM MAKING HARD DECISIONS IN THE FUTURE. THIS COUNTRY IS ALREADY IN THE THROES OF A LIABILITY CRISIS. I HOPE THAT

NO ONE ON THIS COMMITTEE WILL POISON THE ATMOSPHERE THROUGH PLAYING "WHO SHOT JOHN" IN TERMS OF THE CHALLENGER ACCIDENT AS NASA ATTEMPTS TO TURN THINGS AROUND.

I AM OF THE OPINION THAT SIGNIFICANT CHANGES IN THE MANAGEMENT STYLE THAT HAS CHARACTERIZED NASA'S APPROACH TO DIRECTING THE SHUTTLE PROGRAM ARE REQUIRED IN AT LEAST THREE AREAS.

FIRST, IT SEEMS TO ME THAT SENIOR MANAGEMENT MUST HAVE A BETTER MEANS FOR AUDITING NASA'S OVERALL CONFIGURATION MANAGEMENT SYSTEM AS IT APPLIES TO THE SHUTTLE ACTIVITY. THERE IS A HIGH DEGREE OF TRUST IMPLICIT IN THE MANAGEMENT STYLE AND THAT IS GOOD. HOWEVER, IT SEEMS TO ME THAT LEVEL 1 MANAGERS HAVE VERY LITTLE UNDERSTANDING OF THE DECISIONMAKING PROCESSES THAT GO ON AT THE LEVEL 3 FLIGHT READINESS REVIEWS, FOR EXAMPLE. THEY DEPEND UPON THE FLOW OF INFORMATION BEING ACCURATE AND CONCISE; HOWEVER, IT IS CLEAR THAT EACH CENTER HAS ITS OWN MANAGEMENT STYLE. THUS, IN CERTAIN CASES, COMMUNICATIONS FLOW UPWARDS CAN GET DISTORTED OR MISINTERPRETED VERY EASILY. HEADQUARTERS MUST HAVE A MEANS FOR ASSURING ITSELF THAT THE DECISIONMAKING PROCESS AS IT PROMULGATES THROUGH THE WHOLE CHAIN OF COMMAND FROM THE CONTRACTORS THROUGH THE FIELD CENTERS, PROGRAM MANAGEMENT, AND FINALLY

TO HEADQUARTERS, IS ACCOMPLISHED IN A CLEAR AND CONCISE MANNER. IN THIS WAY, THE CONTROL PROCEDURES, CRITICALITY ISSUES AND ENGINEERING CHANGES SHOULD BE FULLY UNDERSTOOD AT ALL LEVELS AND ANY PROBLEMS THAT ARISE ARE CLEARLY COMMUNICATED TO AND AT ALL LEVELS.

SECONDLY, THE AUTONOMOUS OPERATING STYLE THAT HAS CHARACTERIZED CERTAIN OF THE NASA FIELD CENTERS INVOLVED IN THE SHUTTLE PROGRAM HAS SIGNIFICANTLY REDUCED THE OVERSIGHT CAPABILITIES THAT MUST RESIDE AT THE HIGHEST LEVELS OF NASA MANAGEMENT. THUS, I BELIEVE THAT THE TIME FOR FIELD CENTER DIRECTORS DOMINATING THE DECISIONMAKING PROCESS WITHIN THE AGENCY HAS PASSED, AND IT IS NECESSARY TO STRENGTHEN THE PROGRAM MANAGEMENT CAPABILITIES AT HEADQUARTERS.

I HAVE LEARNED, FOR EXAMPLE, THAT A FIELD CENTER SENIOR MANAGER WITH EXTRAORDINARY RESPONSIBILITIES IN THE SHUTTLE PROGRAM RECENTLY VISITED HEADQUARTERS FOR THE FIRST TIME IN NEARLY FIVE YEARS IN ORDER TO PARTICIPATE IN A BRIEFING TO COMMITTEE TASK FORCE STAFF. I AM NOT QUESTIONING THE COMPETENCE OF THIS MANAGER, BUT CLEARLY HIS VISION AS IT RELATES TO THE OVERALL DECISIONMAKING REQUIREMENTS OF THE SHUTTLE PROGRAM MUST BE SIGNIFICANTLY LIMITED. THE FACT THAT SUCH AUTONOMY RESIDES AT ANY ONE LOCATION OUTSIDE OF WASHINGTON DOES NOT DO THE

OVERALL NASA PROGRAM MANAGEMENT STRUCTURE JUSTICE.

THIRDLY, I BELIEVE IT IS ESSENTIAL THAT NASA, ALONG WITH THE CONGRESS, REVIEW AN EARLY SHUTTLE PROGRAM OBJECTIVE TO ENHANCE THE COMMERCIALIZATION POTENTIAL OF THE SHUTTLE BY PERFORMING NEARLY ALL MAJOR SHUTTLE ACTIVITIES THROUGH THE USE OF CONTRACTORS. TODAY I THINK THAT NASA MUST MODIFY THIS APPROACH IN ORDER TO STRENGTHEN ITS IN-HOUSE CAPABILITIES, ESPECIALLY IN THE AREAS OF SAFETY, RELIABILITY AND QUALITY ASSURANCE IN ORDER TO MAKE THE PROCESS WORK.

MR. CHAIRMAN. TODAY WE SHOULD LEARN MORE DETAILS ABOUT THE DEGREE TO WHICH NASA REQUIRES INSTITUTIONAL FIXES IN MANAGING SHUTTLE RISKS. LET US TAKE THESE "LESSONS LEARNED" AS A BASIS FOR OUR FUTURE OVERSIGHT OF NASA'S SPACE TRANSPORTATION SYSTEM. THE WAY IN WHICH THEY IMPLEMENT THESE FIXES WILL DETERMINE WHEN THEY CAN SAFELY FLY AGAIN. IN THAT LIGHT, THIS CAN BE A CONSTRUCTIVE HEARING.

Mr. ROE. Now for the benefit of both our witnesses and our members, let me make the following comments: We will operate today because of the complexities and the in-depth relationship of both groups of witnesses under the 5-minute rule. We will follow that procedure at least until we unfold the basic questions that people want to ask.

I think the second thing I should mention this morning is that in reviewing your testimony, Mr. Locke and your associates and the order of magnitude of the questions that are emerging that I am not sure we can finish everything by noon today, which was our original plan. We are going to try.

The same thing goes with the people from Marshall this afternoon, to try to bring it together.

Why did we select your company and Marshall at this juncture of the hearings? We want to nail down the facts involved in the relationship of what happened in the decision to fly or not to fly. That is what we are trying to ascertain.

The Chair is not interested in the points of view of placing blame at this point. That is not our purpose. Our purpose is to determine exactly what happened, why it happened with the background information to get it on deck so everybody understands that we are not dealing in what may have been. What happened is what we want to know.

The reason for that and why your testimony and the testimony of the representatives from Marshall become important is because we are looking to the second step of our investigation which has to do with management failure or a review that management didn't work in the company or in combination together to help forestall some of the decisions that were made.

That is a key issue that the Commission brought up in their findings and we want to find out what happened and what do we do to not let that happen again.

Mr. SENSENBRENNER. Mr. Chairman, I think that we are getting down to the nubbin of what happened on January 28 and I would request that for this morning's witnesses and this afternoon's witnesses that the Chair place them under oath.

Mr. ROE. Let's take a 5-second break here.

What is the general opinion of the members? I think the gentleman makes a very, very valid point. We could do that for all witnesses. We expect everybody to tell the truth in the first place.

Without objection, I ask unanimous consent that television broadcast, radio broadcast, still photography, and other means of coverage shall be permitted during the full committee hearings on the Rogers Commission report and the investigation of the Science and Technology Committee.

So ordered.

Why don't we have all of the witnesses that are here—we have Mr. McDonald, Mr. Locke, Mr. Garrison, and Mr. Kilminster, and you have who else? Mr. Boisjoly and Mr. Thompson and Mr. Kennedy—all stand, please.

[Witnesses sworn.]

Mr. ROE. I thank the gentleman from Wisconsin for his suggestion.

Now, the first witness the Chair recognizes this morning is Mr. Charles S. Locke, chairman and chief executive officer of the Morton Thiokol, Inc.

We have your statement, but I want you to go through it in full, if you will.

Mr. Locke.

STATEMENTS OF CHARLES S. LOCKE, CHAIRMAN OF THE BOARD AND CHIEF EXECUTIVE OFFICER, MORTON THIOKOL, INC.; U. EDWIN GARRISON, PRESIDENT, AEROSPACE GROUP, MORTON THIOKOL, INC.; JOSEPH C. KILMINSTER, VICE PRESIDENT, MORTON THIOKOL, INC.; CARVER G. KENNEDY, VICE PRESIDENT, SPACE BOOSTER PROGRAMS, MORTON THIOKOL, INC.; ALLAN J. McDONALD, DIRECTOR, SRM VERIFICATION TASK FORCE; ROGER M. BOISJOLY, STAFF ENGINEER; AND ARNOLD R. THOMPSON, SUPERVISOR, STRUCTURES DESIGN, MORTON THIOKOL, INC.

Mr. LOCKE. Thank you, Mr. Chairman and good morning.

I am Charles S. Locke, chairman of the board and chief executive officer of Morton Thiokol, Inc., and seated with me at the table here are Ed Garrison, president of our aerospace group; Joe Kilminster, division vice president; and Al McDonald, director of our solid rocket motor verification task force.

Also with us, and seated here in the front row, are Carver Kennedy, division vice president, space booster programs; Roger Boisjoly, staff engineer; and Arnie Thompson, supervisor of structures design.

We have two prepared statements to make and then would be happy to answer your questions and those of the other committee members.

We at Morton Thiokol share the anguish this country feels as a result of the *Challenger* tragedy. Indeed, the accident and loss of the crew have been particularly painful for each of us since, in the final analysis, it was our solid rocket motor that failed. Nothing we can say or do will bring back those extraordinary people whose lives were lost, but I pledge that Morton Thiokol will do everything in its power to be sure that such a tragedy does not happen again.

We congratulate the Presidential Commission on an excellent job in reviewing the shuttle accident and establishing the framework for a safer space program in the future. We are in full agreement with the Commission's recommendations.

Throughout the investigation by the Commission, our company cooperated fully and responded candidly. Our employees were advised to speak the truth, and I am confident that they did so.

Early on, Mr. Garrison and I met with Dr. Keel, Executive Director of the Commission, and pledged Morton Thiokol's total support. Thus, we were gratified to note Chairman Rogers' acknowledgement of our cooperation when he testified before you last week.

I should also say that we take pride in the contributions of our employees who testified—Joe Kilminster, Al McDonald, Roger Boisjoly, Arnie Thompson—as well as many others. The Commission's report is evidence that the candor of these men and their engineer-

ing knowledge were of great value. This policy of openness will not change as the space program regroups and moves forward.

We want to openly address the criticisms and questions surrounding the *Challenger* accident. We recognize that the decision to launch any shuttle flight is an awesome one. In today's light, there can be no doubt that the whole process must be reviewed carefully.

We must ensure that our procedures give full consideration to all factors, with safety the overriding one. Therefore, we welcome the opportunity to appear before this committee, to comment on the Commission's report, to discuss events prior to the launch, and to explain what we have done since January 28 to move toward redesign of the solid rocket motor joint and seal.

With the benefit of hindsight, it is clear that some decisions made the evening of January 27 were wrong—that mistakes were made. Our space program experts, confronted with reports that the weather would be substantially colder than for any previous launch, reviewed the available data and initially concluded that a launch should not occur at an O-ring temperature lower than 53 degrees Fahrenheit, the lowest previous launch temperature.

But we all know that NASA questioned Morton Thiokol's decision. Our engineers could not prove that it was unsafe to fly at less than 53 Fahrenheit. Thus, after reviewing the data further and evaluating the concerns of a number of engineers, our managers, each of whom has a technical background, came to the judgment that it was safe for our booster motors to fly.

I might add that, had we known how very cold the right aft joint of the motor really was—it may have been, in our opinion, as low as 16 degrees Fahrenheit—we believe our judgment surely would have been different.

Others here with me this morning represent the various views expressed that evening, and they can speak more fully on this topic.

Our focus since January 28 has been first, to assist the accident investigation, including conducting analyses and tests in support of that effort; and second, to develop solutions for the future. We reorganized to accomplish these objectives, and quickly shifted our efforts away from a production mode.

One key move we made was to obtain the valuable assistance of Mr. Dorsey, who came back from his recent retirement to become vice president and general manager of our space division. Mr. Dorsey, before his retirement, had had many years of experience in the development of our solid rocket motors.

We also knew he could restore the confidence of our employees at a time when we were both supporting the investigation and moving into redesign. All together the duties of several hundred people have been changed to recognize the nature of the work ahead. I believe that we are now well positioned organizationally to face the tasks of the future.

Before I leave this subject, I do want to comment specifically on some of the personnel changes that followed the accident. Besides bringing in new management, we did substantially reorganize the responsibilities and jobs of many others in the division.

In the course of these changes, we came to believe that Al McDonald, who had spoken candidly, but harshly, about NASA in

the investigation, should operate in an environment where he could continue to do important work, but in which he would be less likely to interact directly with the agency.

We could not afford the possibility of friction, which would be counterproductive to the important work ahead.

Similar concerns existed concerning Roger Boisjoly, one of our seal experts. In retrospect, we must criticize ourselves for not being sufficiently sensitive to how these actions would be perceived.

I should also say that I am sorry about some remarks I made, which were reported in the press. Those remarks grew out of my frustration over the misperception of the actions we took with respect to these two gentlemen.

I hope subsequent events have demonstrated that we had no intention of punishing anyone. Such action would be totally contradictory to what our company has ever done or stood for.

The task force which Al McDonald heads will lead the redesign effort. It has already begun to coordinate with NASA and the National Research Council oversight committee. Solving the problems in design will be a complicated process.

Our management is charged with coming up with the best possible recommendation on how to proceed with the design. But we want each of our people to know that, if anyone has an idea on how to make a better joint, or a better seal, we will listen carefully. And if the company's final recommendation in any way differs from a particular individual's viewpoint, we will provide a mechanism for such individual viewpoints to be made known directly to NASA and the oversight committee.

Mr. Chairman, the Presidential Commission concluded its report by observing that its findings and recommendations are intended to contribute to the future NASA successes that the nation both expects and requires as the 21st century approaches. We embrace the report with that goal in mind and pledge that we will do our part to support NASA's efforts.

Thank you very much.

With your permission, Mr. Chairman, I now would like to ask Joe Kilminster to present some details of the joint design and the prelaunch situation as we experienced it.

[The prepared statement of Mr. Locke follows:]

STATEMENT OF CHARLES S. LOCKE,
CHAIRMAN AND CHIEF EXECUTIVE
OFFICER, MORTON THIOKOL, INC.,
BEFORE THE SCIENCE AND TECHNOLOGY COMMITTEE,
UNITED STATES HOUSE OF REPRESENTATIVES
JUNE 17, 1986

Good morning, Mr. Chairman, and members of the Committee. I am Charles S. Locke, and I am Chairman and Chief Executive Officer of Morton Thiokol, Inc. Seated with me at the witness table are Ed Garrison, President of our Aerospace Group; Joe Kilminster, Division Vice President; and Al McDonald, Director of our Solid Rocket Motor Verification Task Force. Also with us, and seated here in the front row, are Carver Kennedy, Division Vice President, Space Booster Programs; Roger Boisjoly, Staff Engineer; and Arnie Thompson, Supervisor of Structure Design.

We have two prepared statements to make and then would be happy to answer your questions and those of the other Committee members.

We at Morton Thiokol share the anguish this country feels as a result of the Challenger tragedy. Indeed, the accident and loss of the crew have been particularly painful for each of us since, in the final analysis, it was our solid rocket motor that failed. Nothing we can say or do will bring back those extraordinary people whose lives were lost, but I pledge that

- 2 -

Morton Thiokol will do everything in its power to be sure that such a tragedy does not happen again.

We congratulate the Presidential Commission on an excellent job in reviewing the shuttle accident and establishing the framework for a safer space program in the future. We are in full agreement with the Commission's recommendations.

Throughout the investigation by the Commission our company cooperated fully and responded candidly. Our employees were advised to speak the truth, and I am confident that they did so. Early on, Mr. Garrison and I met with Dr. Keel, Executive Director of the Commission, and pledged Morton Thiokol's total support. Thus, we were gratified to note Chairman Rogers' acknowledgment of our cooperation when he testified before you last week.

I should also say that we take pride in the contributions of our employees who testified -- Joe Kilminster, Al McDonald, Roger Boisjoly, Arnie Thompson -- as well as many others. The Commission's report is evidence that the candor of these men and their engineering knowledge were of great value. This policy of openness will not change as the space program regroups and moves forward.

We want to openly address the criticisms and questions surrounding the Challenger accident. We recognize that the decision to launch any shuttle flight is an awesome one. In today's light there can be no doubt

that the whole process must be reviewed carefully. We must ensure that our procedures give full consideration to all factors, with safety the overriding one. Therefore, we welcome the opportunity to appear before this Committee, -- to comment on the Commission's report, to discuss events prior to the launch, and to explain what we have done since January 28 to move toward redesign of the solid rocket motor joint and seal.

With the benefit of hindsight it is clear that some decisions made the evening of January 27 were wrong -- that mistakes were made. Our space program experts, confronted with reports that the weather would be substantially colder than for any previous launch, reviewed the available data and initially concluded that a launch should not occur at an O-ring temperature lower than 53°F, the lowest previous launch temperature.

But we all know that NASA questioned Morton Thiokol's decision. Our engineers could not prove that it was unsafe to fly at less than 53°F. Thus, after reviewing the data further and evaluating the concerns of a number of engineers, our managers, each of whom has a technical background, came to the judgment that it was safe for our booster motors to fly. I might add that, had we known how very cold the right aft joint of the motor really was -- it may have been, in our opinion, as low as 16°F -- we believe our judgment surely would have been different.

Others here with me this morning represent the various views expressed that evening, and they can speak more fully on this topic.

Our focus since the 28th of January has been first, to assist the accident investigation, including conducting analyses and tests in support of that effort; and second, to develop solutions for the future. We reorganized to accomplish these objectives, and quickly shifted our efforts away from a production mode.

One key move we made was to obtain the valuable assistance of Mr. Dorsey, who came back from his recent retirement to become Vice President and General Manager of our Space Division. Mr. Dorsey, before his retirement, had had many years of experience in the development of our solid rocket motors. We also knew he could restore the confidence of our employees at a time when we were both supporting the investigation and moving into redesign. All together the duties of several hundred people have been changed to recognize the nature of the work ahead. I believe that we are now well-positioned organizationally to face the tasks of the future.

Before I leave this subject, I do want to comment specifically on some of the personnel changes that followed the accident. Besides bringing in new management, we did substantially reorganize the responsibilities and jobs of many others in the Division. In the course of these changes, we came to believe that Al McDonald, who

had spoken candidly, but harshly, about NASA in the investigation, should operate in an environment where he could continue to do important work, but in which he would be less likely to interact directly with the agency. We could not afford the possibility of friction, which would be counterproductive to the important work ahead. Similar concerns existed concerning Roger Boisjoly, one of our seal experts. In retrospect, we must criticize ourselves for not being sufficiently sensitive to how these actions would be perceived.

I should also say that I am sorry about some remarks I made, which were reported in the press. Those remarks grew out of my frustration over the misperception of the actions we took with respect to these two gentlemen. I hope subsequent events have demonstrated that we had no intention of punishing anyone. Such action would be totally contradictory to what our company has ever done or stood for.

The task force which Al McDonald heads will lead the redesign effort. It has already begun to coordinate with NASA and the National Research Council oversight committee. Solving the problems in design will be a complicated process. Our management is charged with coming up with the best possible recommendation on how to proceed with the design. But we want each of our people to know that, if anyone has an idea on how to make a better joint, or a better seal, we will listen carefully. And if the

company's final recommendation in any way differs from a particular individual's viewpoint, we will provide a mechanism for such individual viewpoints to be made known directly to NASA and the oversight committee.

Mr. Chairman, the Presidential Commission concluded its Report by observing that its findings and recommendations are intended to contribute to the future NASA successes that the nation both expects and requires as the 21st century approaches. We embrace the Report with that goal in mind and pledge that we will do our part to support NASA's efforts.

Thank you very much.

With your permission, Mr. Chairman, I now would like to ask Joe Kilminster to present some details of the joint design and the pre-launch situation as we experienced it.

Mr. ROE. I thank the gentleman.

The chair recognizes Mr. Kilminster for his further testimony.

Mr. KILMINSTER. Good morning, Mr. Chairman, and members of the committee. I am Joe Kilminster, vice president of Morton Thiokol. As Mr. Locke has already mentioned, all of us at the company share in the Nation's grief over the loss of *Challenger*. At the same time, this tragedy has intensified our resolve to go forward in making the space program as safe and successful as it can be.

Until recently, my specific area of responsibility was the space booster programs for our company; and over the past 12 years I have been directly involved in the development and production of our solid rocket motors. Prior to that, I held engineering positions in structures, preliminary design, and ordnance project engineering.

I would like to describe briefly Morton Thiokol's testing and development programs and to share with you the events and thought processes that affected the decisions of January 27. Before I discuss these two topics, let me take a few moments to review with you the operation of the solid rocket motor field joint and its components.

Mr. Kennedy will assist me on the diagrams that you see on the left. As you can see from the motor drawing, the solid rocket motor is made up of four segments. Each segment is connected to the next segment by a field joint. There are three field joints for each solid rocket motor. Shown on the left is a cross section of the field joint, and shown at the bottom left is a cross section of the nozzle joint.

Additional detail of the field joint is shown on the next figure. The segment tang—the yellow section—and segment clevis—the blue section—connect the segments, which are held together by 177 clevis pins. The joint is sealed by two rubber O-rings—the black circles. The top one is identified as the primary O-ring, and the bottom one is the secondary O-ring. The purpose of the O-rings is to prevent the combustion gases from escaping from inside of the motor to the outside.

The gap between the tang and clevis—the white space in between the two—determines the O-ring compression, or squeeze. Shims are used to minimize the gap and increase O-ring squeeze. A shim is a piece of metal that fits between the tang and the outside leg of the clevis to adjust the spacing between the tang and the clevis where the O-ring is.

The size of the gap is determined by a number of factors, including the dimensions of the metal parts themselves, the O-ring diameter, and the loads on the segment. A design feature unique to our solid rocket motor is the leak test between the two O-rings. The leak test determines whether the O-rings will properly respond after assembly to pressure or whether there is some assembly damage or contamination.

The putty—which is identified by the diagonal lines—is intended to act as a thermal barrier to prevent hot gases from coming into contact with the O-rings. At the same time, during pressurization, the putty is displaced—moved—by gas pressure compressing the air between the putty and primary O-ring. Air pressure forces the O-ring into the gap between the tang and clevis. This process occurs early in the ignition stage stage. Also, during ignition, pres-

sure loads are applied to the joint, causing the tang-clevis gap to open.

With that introduction, let me turn to the history of the solid rocket motor field joint design.

In 1974, NASA selected us to design and manufacture the solid rocket motors for the space shuttle. The basic joint/seal design of the solid rocket motor is similar to the Titan solid rocket motor, which has a single bore seal O-ring, and which has had a successful history. In 1976, NASA completed its critical design review and accepted the design.

Since its acceptance, we have learned even more about the complexities of this design and have responded whenever our experiences indicated a need for improvement or change.

As part of our testing program, we discovered in June 1977 that the gap between the tang and clevis opened under pressurization loads, sometimes referred to as joint rotation. Immediately, we discussed the problem with NASA and commenced analyses and testing to determine how to increase the squeeze on the O-ring and thereby reduce the effect of gap opening. We eventually incorporated three design changes to accomplish this. First, we reduced the joint metal tolerances. Second, we increased the diameter and tightened the tolerances of the O-ring. Third, we incorporated the use of shims.

These changes resulted in increased O-ring squeeze, which both we and NASA believed was necessary to counteract the gap opening we had observed. Later on we increased the shim thickness to improve O-ring squeeze even more, based on analysis work that was done.

Testing of these modifications reduced concerns about the gap opening. A number of successful tests and qualification procedures established that the seals would function safely as expected.

Another area to which Morton Thiokol devoted significant attention was evaluation of the performance of the secondary O-ring. In 1980, a number of tests were conducted which established that the secondary O-ring would seal if it were required to do so.

Even though actual tests demonstrated the integrity of the second seal, analytic calculations suggested that if the hardware tolerances were all in the wrong direction—in other words, narrow tang, wide clevis, and small-diameter O-ring—the secondary seal would not have what is called positive squeeze. This means that it would not be squeezed, or compressed, at all.

Therefore, at that time we instituted procedures to select actual hardware to avoid these worst-on-worst conditions. Because the solid rocket motor was assembled based on hardware measurements, we believed the secondary seal would in fact be redundant to the primary seal.

O-ring erosion, which occurs when a hot gas jet strikes the O-ring, is another area that received significant attention. Morton Thiokol began addressing this issue in November 1981. It was at that time that erosion was first detected in the postflight seal inspection of the shuttle flight, STS-2, which flew on November 12.

I should point out that sealing of the joint does occur, even with erosion. Testing was conducted that showed significant amounts of O-ring material could be removed, and the O-ring would still seal.

On those flights that experienced varying amounts of erosion, the primary O-ring sealed. Nevertheless, erosion is clearly undesirable, and we devoted resources to minimizing this problem.

Our efforts regarding erosion cannot be described without discussing putty. Putty is intended to keep heat and gas jets, which cause erosion, away from the O-rings. Most of our early efforts to eliminate erosion, therefore, revolved around studying how the putty is applied to the joint areas, and various putty characteristics.

We intensified our joint analysis efforts early last year because of the erosion and blowby experienced on the January 24, 1985 flight, STS 51-C. Blowby is when gases pass by the O-ring as the O-ring seals. Numerous activities were undertaken in the first part of the year, including analytical and test efforts. In August, at the urging of some of our seal experts, a joint/seal task force was formed to investigate and solve the O-ring erosion and blowby problem. Approximately 40 people devoted substantial time and energy to this effort.

I should emphasize that at no time after the second flight in 1981 did we experience field joint erosion that was outside our experience base or that might jeopardize safety of flight. They were less than we had observed on STS-2. All of our testing and other efforts to deal with the erosion issue were communicated to Marshall Space Flight Center in a timely fashion.

While we had previously considered the role of temperature on overall flight performance, blowby observed on the January 1985 launch prompted us to consider the effect of temperature on O-ring resiliency. We conducted laboratory O-ring compression and resiliency tests between 50 to 100 degrees Fahrenheit and evaluated environmental exposure of putty and subsequent O-ring erosion. Again, all of our findings were reported to Marshall Space Flight Center.

In July 1985, we ordered long lead steel billets to accommodate a redesigned case joint. A detailed presentation on all of our experiences with solid rocket motor seals was made to NASA headquarters in August of last year.

I hope this brief summary of some of our efforts helps to demonstrate two important points.

First, we evaluated and reevaluated every component and process of this design. We responded in a timely fashion when we became aware of an anomaly. And, most importantly, we always sought to satisfy ourselves that safety-of-flight risks were evaluated and minimized. This was a continuing process.

Second, the events help to explain that frame of reference within which both Morton Thiokol and NASA were working on January 27, 1986.

As one of the participants in the events of January 27, 1986, let me review briefly with you my thoughts. On that day, we were informed that launch time temperatures were expected to be substantially lower than any previous launch. As launch was scheduled for early the next day, our engineers immediately commenced evaluating the available data, focusing particularly on past flight experiences and recent test data. All of the information was discussed among the staff engineers, their supervisors, and the vice

president of engineering. Because our engineers did not favor launch outside our experience base, we communicated our reservations to NASA officials and recommended against launch.

Two NASA officials—Mr. Mulloy and Mr. Hardy—questioned our conclusions from the data that was presented. Mr. Mulloy pointed out that he could see no correlation of blowby and temperature. A comment was also made that the secondary O-ring is located in the desirable sealing position because of the leak check. Because of the observations and analysis made by Mr. Mulloy and others, we felt it necessary to reassess the data.

To do so effectively, I asked for an offline caucus so we at Morton Thiokol could review our initial no-launch recommendation in the light of some perceptive questions raised by NASA. During the caucus, at which all of the knowledgeable employees were present, we reevaluated the data. We also considered facts that were not taken into account before making our initial recommendation; for example, Mr. Mulloy's comments about the conclusiveness of our data, the position of the secondary O-ring, and the fact that we could fly safely even if the O-rings had three times as much erosion as that experienced on the previous coldest launch.

Based on all the data we had considered, including the subscale tests at 30 degrees Fahrenheit, which showed no O-ring blowby, the managers—each of whom is technically experienced—concluded that a launch recommendation would be made. As the telefax I signed shows, we considered all of the available data. We concluded that O-ring erosion would not compromise the primary O-ring. If the primary O-ring were slow in seating and blowby occurred, the secondary O-ring was in position to seal.

Obviously, we were wrong. We did not have the safety margin necessary to cover some things we were not aware of—temperature of the point lower than 29 degrees Fahrenheit, perhaps as low as 16 degrees Fahrenheit, potential for ice in the joint, putty behavior at cold temperature, and the effects of violent wind-shear conditions.

In hindsight, we all wish we could reverse the judgment we made. The decision we made that night has been constantly on my mind since the morning of January 28. I know it has also been on the minds of everyone who participated in the discussion and decision of the evening of January 27.

Thank you very much, Mr. Chairman. Mr. Chairman, I do have a model of the joint here. If you would like to pass that around to committee members, you are free to do that.

[The prepared statement of Mr. Kilminster follows:]

STATEMENT OF JOSEPH C. KILMINSTER

Good morning, Mr. Chairman. I am Joe Kilminster, Vice President of Morton Thiokol. As Mr. Locke has already said, all of us at the company share in the nation's grief over the loss of the *Challenger*. At the same time, this tragedy has intensified our resolve to go forward in making the space program as safe and successful as it can be.

Until recently, my specific area of responsibility was the Space Booster Programs for our company; and over the past 12 years I have been directly involved in the development and production of our solid rocket motors. Prior to that I held engineering positions in Structures, Preliminary Design, and Ordnance Project Engineering.

I would like to describe briefly Morton Thiokol's testing and development programs and to share with you the events and thought processes that affected the decisions of January 27. Before I discuss these two topics, let me take a few moments to review with you the operation of the solid rocket motor field joint and its components.

As you can see from the motor drawing, the solid rocket motor is made up of four segments. Each segment is connected to the next segment by a field joint. Shown on the left is a cross-section of the field joint, and shown on the bottom left is a cross-section of the nozzle joint.

Additional detail of the field joint is shown on the next figure. The segment tang—the yellow section—and segment clevis—the blue section—connect the segments, which are held together by 177 clevis pins. The joint is sealed by two rubber O-rings—the black circles. The top one is identified as the primary O-ring, and the bottom one is the secondary O-ring. The purpose of the O-rings is to prevent the combustion gases from escaping from the inside of the motor to the outside.

The gap between the tang and clevis—the white space in between the two—determines the O-ring compression, or "squeeze". Shims are used to minimize the gap and increase O-ring squeeze. A shim is a piece of metal that fits between the tang and the outside leg of the clevis to adjust the spacing between the tang and the clevis where the O-ring is.

The size of the gap is determined by a number of factors, including the dimensions of the metal parts themselves, the O-ring diameter, and the loads on the segment. A design feature unique to our solid rocket motor is the leak test between the two O-rings. The leak test determines whether the O-rings will properly respond after assembly to pressure or whether there is some damage or contamination.

The putty—which is identified by the diagonal lines—is intended to act as a barrier to prevent hot gases from coming into contact with the O-rings. At the same time, during pressurization the putty is displaced—moved—by gas pressure compressing the air between the putty and primary O-ring. Air pressure forces the O-ring into the gap between the tang and clevis. This process occurs early in the ignition stage. Also, during ignition, pressure loads are applied to the joint, causing the tang-clevis gap to open.

With that introduction, let me turn to the history of the solid rocket motor field joint design.

In 1974, NASA selected us to design and manufacture the solid rocket motors for the Space Shuttle. The basic joint/seal design of the solid rocket motor is similar to the Titan solid rocket motor, which has a single bore seal O-ring, and which has a successful history. In 1976, NASA completed its Critical Design Review and accepted the design.

Since its acceptance, we have learned even more about the complexities of this design and have responded whenever our experiences indicated a need for improvement or change.

As part of our testing program, we discovered in June, 1977 that the gap between the tang and clevis opened under pressurization loads, sometimes referred to as joint rotation. Immediately, we discussed the problem with NASA and commenced analyses and testing to determine how to increase the squeeze on the O-ring and thereby reduce the effect of gap opening. We eventually incorporated three design changes to accomplish this. First, we reduced the joint metal tolerances. Second, we increased the diameter and tightened the tolerances of the O-ring. Third, we incorporated the use of shims.

These changes resulted in increased O-ring squeeze, which both we and NASA believed was necessary to counteract the gap opening we had observed. Later on we increased the shim thickness to improve O-ring squeeze even more based on analysis work that was done.

Testing of these modifications reduced concerns about the gap opening. A number of successful tests and qualification procedures established that the seals would function safely as expected.

Another area to which Morton Thiokol devoted significant attention was evaluation of the performance of the secondary O-ring. In 1980, a number of tests were conducted which established that the secondary O-ring would seal if it were required to do so.

Even though actual tests demonstrated the integrity of the second seal, analytic calculations suggested that if the hardware tolerances were all in the wrong direction—in other words, narrow tang, wide clevis, and small-diameter O-ring—the secondary seal would not have what is called "positive squeeze." This means that it would not be squeezed, or compressed, at all.

Therefore, at that time, we instituted procedures to select actual hardware to avoid these worst-on-worst conditions. Because the solid rocket motor was assembled based on hardware measurements, we believed the secondary seal would in fact be redundant to the primary seal.

O-ring erosion, which occurs when a hot gas jet strikes the O-ring, is another area that received significant attention. Morton Thiokol began addressing this issue in November, 1981. It was at that time that erosion was first detected in the post-flight seal inspection of the shuttle flight, STS-2, which flew on November 12th.

I should point out that sealing of the joint does occur, even with erosion. Testing was conducted that showed significant amounts of O-ring material could be removed, and the O-ring would still seal. On those flights that experienced varying amounts of erosion, the primary O-ring sealed. Nevertheless, erosion is clearly undesirable, and we devoted resources to minimizing this problem.

Our efforts regarding erosion cannot be described without discussing putty. Putty is intended to keep heat and gas jets, which cause erosion, away from the O-rings. Most of our early efforts to eliminate erosion, therefore, revolved around studying how the putty is applied to the joint areas, and various putty characteristics.

We intensified our joint analysis efforts early last year because of the erosion and blow-by experienced on the January 24, 1985 flight, STS 51-C. Blow-by is when gases pass by the O-ring as the O-ring seals. Numerous activities were undertaken in the first part of the year, including analytical and test efforts. In August, at the urging of some of our seal experts, a Joint/Seal Task Force was formed to investigate and solve the O-ring erosion and blow-by problem. Approximately 40 people devoted substantial time and energy to this effort.

I should emphasize that at no time after the second flight in 1981 did we experience field joint erosion that was outside our experience base or that might jeopardize safety of flight. All of our testing and other efforts to deal with the erosion issue were communicated to Marshall Space Flight Center in a timely fashion.

While we had previously considered the role of temperature on overall flight performance, blow-by observed on the January, 1985 launch prompted us to consider the effect of temperature on O-ring resiliency. We conducted laboratory O-ring compression and resiliency tests between 50°-100°F and evaluated environmental exposure of putty and subsequent O-ring erosion. Again, all of our findings were reported to Marshall Space Flight Center. In July 1985, we ordered long lead steel billets to accommodate a redesigned case joint. A detailed presentation on all of our experiences with solid rocket motor seals was made to NASA headquarters in August of last year.

I hope this brief summary of some of our efforts helps to demonstrate two important points.

First, we evaluated and re-evaluated every component and process of this design. We responded in a timely fashion when we became aware of an anomaly. And—most importantly—we always sought to satisfy ourselves that safety-of-flight risks were evaluated and minimized. This was a continuing process.

Second, the events help to explain the frame of reference within which both Morton Thiokol and NASA were working on January 27, 1986.

As one of the participants in the events of January 27, 1986, let me review briefly with you my thoughts. On that day, we were informed that launch time temperatures were expected to be substantially lower than any previous launch. As launch was scheduled for early the next day, our engineers immediately commenced evaluating the available data, focusing particularly on past flight experiences and recent test data. All of the information was discussed among the staff engineers, their supervisors, and the Vice President of Engineering. Because our engineers did not launch outside our experience base, we communicated our reservations to NASA officials and recommended against launch.

Two NASA officials—Mr. Mulloy and Mr. Hardy—questioned our conclusions from the data that was presented. Mr. Mulloy pointed out that he could see no correlation of blow-by and temperature. A comment was also made that the secondary O-ring is located in the desirable sealing position because of the leak check. Because of the observations and analysis made by Mr. Mulloy and others, we felt it necessary to reassess the data.

To do so effectively, I asked for an off-line caucus so we at Morton Thiokol could review our initial "no-launch" recommendation in the light of some perceptive questions raised by NASA. During the caucus—at which all of the knowledgeable employees were present—we reevaluated the data. We also considered facts that were not taken into account before making our initial recommendation; for example, Mr. Mulloy's comments about the conclusiveness of our data, the position of the second-

ary O-ring, and the fact that we could fly safely even if the O-rings had three times as much erosion as that experienced on the previous coldest launch.

Based on all the data we had considered, including the subscale tests at 30°F which showed no O-ring blow-by, the managers—each of whom is technically experienced—concluded that a launch recommendation would be made. As the telefax I signed shows, we considered all of the available data. We concluded that O-ring erosion would not compromise the primary O-ring. If the primary O-ring were slow in seating and blow-by occurred, the secondary O-ring was in position to seal.

Obviously, we were wrong. We did not have the safety margin necessary to cover some things we were not aware of—temperature of the joint lower than 29°F (perhaps as low as 16°F), potential for ice in the joint, putty behavior at cold temperature, and the effects of violent wind shear conditions.

In hindsight, we all wish we could reverse the judgment we made. The decision we made that night has been constantly on my mind since the morning of January 28th. I know it has also been on the minds of everyone who participated in the discussion and decision of the evening of January 27.

Thank you very much.

SPACE SHUTTLE SRM JOINTS

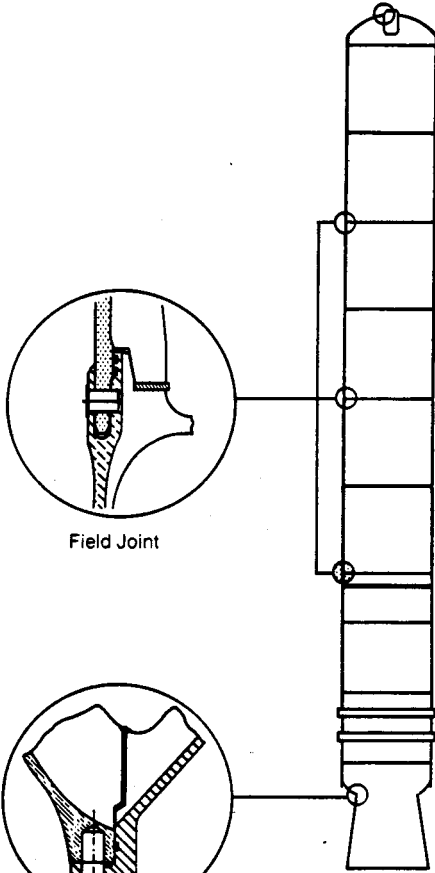

Field Joint

Nozzle-to-Case Joint

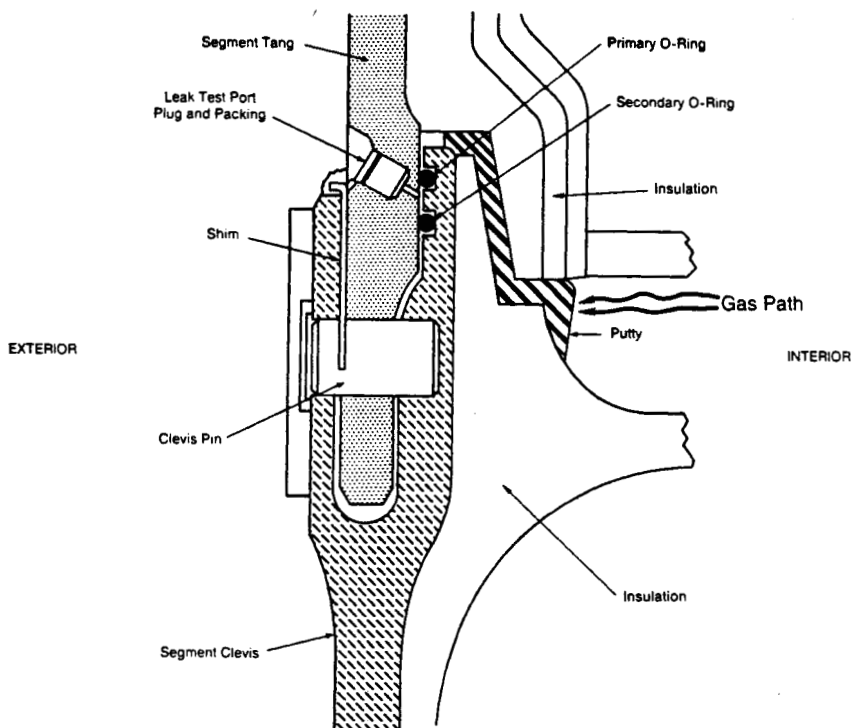
**DETAIL OF SPACE SHUTTLE
SRM FIELD JOINT**

OPERATION OF SRM FIELD JOINT

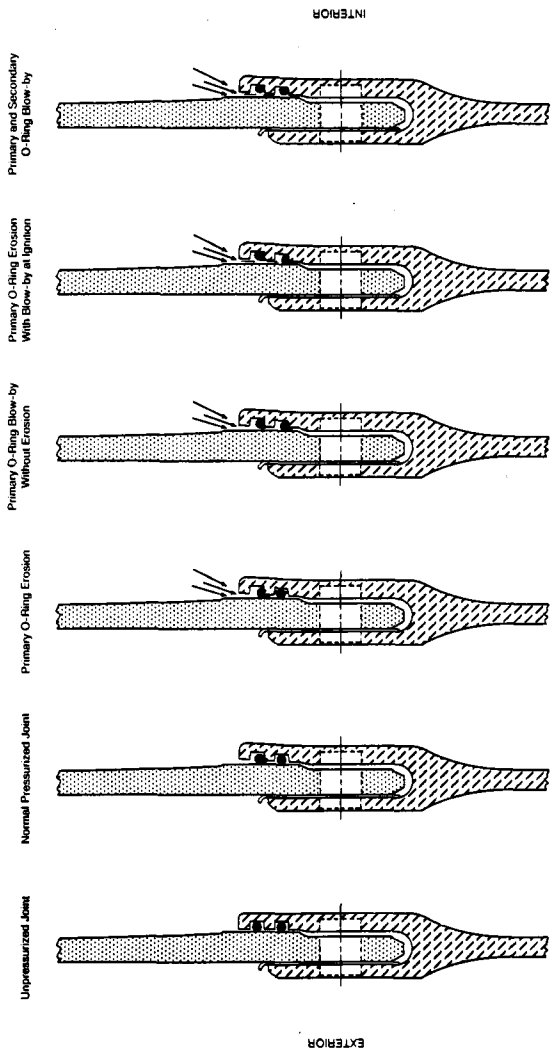

Mr. ROE. I want to thank you, Mr. Kilminster, for your testimony, and I think it would be profitable to clarify a little bit further, if I may, before we go into our interrogatories, what really happened during that discussion. There has been all kinds of conjecture in the media and so forth, and I think it is important, and how it is interpreted in the Commission's report.

So I think it is very important while we have the key people here that participated in the decisionmaking process that we ask those questions, but I would like to hear the reflections first from Mr. McDonald. You have been vocal and candid in your observations, and hindsight is 20/20 vision and all that, but that notwithstanding it is important to the committee to understand what your motivating factors were in this decisionmaking process and see if you can portray to the committee what really made you change your mind if you did change your mind as to whether the launch should take place or not.

If you could give us reflections, as I understand from Mr. Kilminster's testimony, the Thiokol leadership went on its own and called its caucus together and said "We have a different position coming through from NASA and Marshall saying we don't think you are interpreting this correctly, have we done the proper tests?"

On the basis of that kind of dialog, as I understand Mr. Kilminster's testimony, that is where the decision was made by Thiokol to reverse the position on the flight, particularly as far as the cold weather was involved.

Mr. McDONALD. First I would like to clarify that I was at the Kennedy Space Center that evening. I was not in the caucus at Utah where the final decision was made.

Mr. ROE. Did you communicate with any of these folks?

Mr. McDONALD. Only the telephone conference that occurred before the caucus. I did not communicate with them during the caucus, no. Prior to the end of the telephone conference, in fact I was the one responsible for setting that up, I had requested that Thiokol assess the situation, their engineering people assess that situation, and come back with a recommendation as to what temperature, not just whether we launch or not, but at what temperature we would be willing to launch, and that decision should be made by the vice president of Thiokol Engineering.

That telephone conference was conducted over about a 2-hour time period, the charts relative to the assessment of what temperature we would launch at were made by the individual engineers preparing the charts, Mr. Bob Lund, the vice president of engineering, went through the conclusions and the recommendations made, which were not to launch below 53 degrees Fahrenheit. When that rationale for launching, notably 53 degrees, was challenged by the NASA people, we had agreed to hold a caucus to reassess that data.

I had made a comment at that time, said if we are going to reassess the data, then we must re-assess the effect of the temperature on both the primary and secondary O-ring. Mr. Hardy had commented earlier we had not addressed that, and I reiterated that is an important consideration because, in my mind, it was very clear that we made the 53-degree recommendation based on our experience.

The year earlier, we had experienced the worst condition we had seen in a field joint, a condition where we eroded two of the O-rings in field joints, and we saw heavy black soot behind the primary O-ring and some sheen taken off the secondary O-ring, even though there was no major erosion from it. It was clear that even though we presented 13 charts on our concerns of going at lower temperatures, it was the basis of that previous flight which we didn't expect to experience again, because at that time those were reported as the 3 coldest days in Florida history prior to that launch. So we didn't expect to see that condition again.

Mr. ROE. But you recognized that the cold weather created the condition?

Mr. McDONALD. We concluded that was the reason we saw the blowby. We didn't attribute that to anything else. We concluded that it was the cold temperature.

Mr. ROE. But you were aware at that point it was the temperature issue and that was on January 27, so there was some recognition by our folks and yourself that there was a temperature problem that apparently had caused a problem before as far as the two O-rings are concerned, and on January 27, you did recognize that temperature may play some role.

Is that a fair comment to make?

Mr. McDONALD. That is correct. That is a fair assessment and that is why we really held the conference. I felt that if we were going to recommend anything other than 53 degrees, we were going to have to assess it analytically to say what temperature can we launch at and how does temperature affect that O-ring seal.

I felt that if we went off line to take a caucus if we wanted to calculate a new temperature based on how we knew that O-Ring would respond, and we knew that the O-ring in the primary seal, which was hit by the gas first, it had to travel across the O-ring groove.

It so happened that the squeeze in that O-ring was such it didn't have to do much of that, but in theory it has to move from one side to the other because the leak check on primary O-ring does check it on the wrong side of the O-ring groove. We knew that and it was in that kind of position at the time.

So I knew that it took some time for that to happen and some time for the O-ring to be extruded into the gap and the issue that we had discussed that night was that the concern by the engineers was the timing function.

We could not allow the time for that O-ring seal, the primary O-ring seal to seal past about 170 milliseconds because that was the time when the metal parts really started to rotate and once rotation occurs, which it separates the sealing area, the O-ring from the metal parts, that the resiliency of the O-ring comes into play.

That is the ability of the O-ring to recover from the temperature. If we didn't get a good seal on the primary at that time, we could not depend on the secondary O-ring because it had the same resiliency problem, but if the primary O-ring did not seal in the first milliseconds before that metal part separated, there was a good chance the secondary seal would seal, because it was at least in the proper position and did not have to travel.

My comment that was finally used as one of the pieces of rationale, is somebody needs to assess that if we are going to use any temperature other than 53 degrees and it was at that point in time when the caucus was held at Utah and they said they would go off for 5 minutes and it ended up for about half an hour and as a result I didn't participate in the caucus because I felt the right people were there to discuss that information, all the engineering people were there and I was not aware of what happened in that caucus at the time.

Mr. ROE. I want to call on Mr. Boisjoly in a minute, but let me ask you one question. When the decision came back to you from the caucus that lasted approximately half an hour, were you satisfied with that decision or did you still doubt in your mind whether that was the wise thing to do?

Mr. McDONALD. I was not satisfied with that decision. I was a bit taken back and surprised because the rationale that was presented did not indicate to me that we had run the calculations to convince me that we had a good number again and we didn't come back with a number, which kind of bothered me a little bit. It just said that we would recommend to proceed on with the launch.

In reviewing the chart that Mr. Kilminster eventually had to sign, there are about nine items on that chart and I believe five of the nine were reasons not to launch. They were the concerns raised earlier in the telecon and only four of those were items that you could say may say it is all right. There were still more unknowns than knowns. That is when I raised the issue with both Mr. Mulloy and Mr. Reinartz, my concern that I don't think that they can accept that recommendation.

Mr. ROE. I have a couple of other questions I would ask when the question period starts.

Mr. Boisjoly, would you give us your observations, and then we will have closed the circle here, and all the people who were part of the process from the Thiokol group will have spoken, and then we will go to questions.

What is your observation, sir?

Mr. BOISJOLY. Our primary concerns that evening were for the cold temperatures, and those primary concerns were rooted in the launch the year before in 1985.

Mr. ROE. Run that by me once more.

Mr. BOISJOLY. Our primary concerns were rooted in the launch 1 year before in 1985, as Al had mentioned. That was the most severe blowby that we had ever witnessed on a joint, and the main emphasis of the discussion from an engineering standpoint that evening was the resiliency of the seals and the witness of that blowby from the year before, that temperature was indeed telling us something.

I had prepared a chart that broke the ignition transient during the pressurization cycle into three distinct zones, the zero and 170 milliseconds. I had stated that we had a high probability of a reliable secondary seal. And the basis for that statement was that we had a bench test that showed that at 50 degrees, we could maintain O-ring contact when we separated the surfaces in that regime; in other words, just a little bit of separation, the O-ring still had the capability of following the metal surfaces and had the ability to be

sealed. That was the only—the lowest temperature data that we had at that point in time.

Mr. ROE. No other tests had been made at that point below 50 degrees?

Mr. BOISJOLY. That is correct. I had another zone defined between 170 and 330 milliseconds, and I said we had a reduced probability of having a secondary seal. We weren't sure whether it would or would not seal because it would be beyond our experience base at that point.

Then I had a third zone which took us from 330 to the end of the ignition transient cycle of 600 milliseconds, and I said we had a high probability that we would not have any secondary seal. That was based on the fact of the same type of testing, which showed at 50 degrees, if we open the gap to the full amount, the seal not only lifted off but stayed lifted off for 10 minutes, and we had terminated the test after 10 minutes, so we had a pretty fair assessment that temperature did have an effect on resiliency of the seal at that point.

I also went through a series of qualitative assessments based on observations. I was the one that was at the Cape and appeared in the disassembly of 51-C which occurred in 1985. I was the one that tracked the soot, defined it, took the samples, had them brought back to the plant for analysis and so forth, and had that soot analyzed, and there was no doubt that they were the products of combustion, products of O-ring, products of putty between the two O-ring seals. We had a case where, on that particular flight, we had on the 15-A vehicle, we had an 80-degree arc of black grease between the O-rings and the grease was homogenous color and it was black, jet black. We had never seen anything like that before.

On the other joint on that same vehicle, we had 110 degrees of black grease between the O-rings. I also pointed out that we would have lower O-ring squeeze due to the lower temperature. I had run a calculation during the day to ensure that we would still have squeeze as a result of the lower temperature.

Earlier in the day, I didn't know what the temperature exactly would be so I ran a calculation on the basis of temperature drop from ambient of 50 degrees which would have put us in the 25-degree region from ambient of 75. I ran the calculation and it worked out to be a relatively benign difference of three-one thousandths of an inch, which is not a major change in squeeze.

However, a major factor was that as temperature goes down an elastometric material, the material becomes harder, so we pointed out that the shore hardness, which is the measure of the hardness of the O-ring, would be harder, and I used a brick and sponge analogy to explain that.

It would be more difficult for the seal to attempt to seal in the gap as it was being pressure-energized. We would also affect the grease, causing the grease to become thicker. I mentioned that higher O-ring pressure actuation time may occur as a result of all of those that I mentioned before.

Now, here is the two bottom lines that we were trying to drive home that night from an engineering standpoint.

Mr. ROE. Before you do that, let me ask a question for clarity. Did you advise your superiors of these tests and your observations on January 27?

Mr. BOISJOLY. Yes; I am reading from the actual charts that we used.

Mr. ROE. The gentleman will proceed.

Mr. BOISJOLY. The bottom two statements basically summed up in effect what I have just stated. The results of what I just stated could result in the following action.

If action time increased, and that action time being the time it would take an O-ring to seal, the threshold of the secondary seal pressurization capability approach—to amplify on that and explain it to you, the longer it takes the primary seal to go into position and affect a seal, rotation effects occur in the metal parts such that the longer that time, the more the probability the secondary seal would not be capable of being pressure actuated, because it would unseat. If the threshold is reached, then the secondary seal might not be capable of that pressurization, and that was the sum and substance of the discussion that night.

We had charts in there that showed that we had a static test fixture that showed that at 30 degrees, we experienced no blowby but that was a static test fixture that had no gap opening; its purpose was just to evaluate the blowby phenomena in the seal, to evaluate it in the regime of 5 to 50 pounds per square inch, and that was a direct outcropping of the flight readiness review from the year before in which I made the statement that all seals have a certain amount, maybe a teaspoon of gas that goes through, and it is a question of when that gas goes through whether it is hot or ambient gas compressed prior to the hot gas coming through, and that mechanism has in an O-ring attempting to go across the groove and seal. That test was run for that purpose and that chart was used to demonstrate that the seal would seal at 30 degrees. However, that was a static condition. The joint was not moving at that time.

The major point is we used pictures to show that the SRM-15, which had the major soot between the seals, as I described, versus an SRM-22, which had soot blowby at a higher temperature and much less arc degree and much less blackness, it boiled down to that major issue, that temperature on one side of the argument was not a discriminator, and on the engineering side of the argument, it was a discriminator, and physical evidence was indeed telling us that temperature was a major effect.

Mr. ROE. I thank the gentleman.

I thought it was important to have the input of two of the gentlemen who worked very diligently on this issue.

Now we will go to questioning. I am going to have three questions, but I want to make a summary first and then I will defer to my minority leader from New Mexico.

I would like to make the following observation at this time, and place in space, if you like, in our investigation. We have heard very candid testimony from Mr. Locke, who is chairman of the board of the company. We have heard an extensive technical—and very well-done, by the way—presentation by Mr. Kilminster giving the

members a better understanding of precisely how the technology works. We feel that was very successful.

We have talked to Mr. McDonald about his observations, being the representative at the Cape and making some of these decisions, or translating these decisions into action. And, Mr. Boisjoly, on your engineering points, we have determined two things, as I see it, in the testimony so far, and the facts before us. No. 1, that NASA knew over a long period of time, as did Thiokol, that there was a problem with this particular seal and the O-ring situation. We knew that. It wasn't something new that came to us.

The second point that I think we have established in fact is that in the course of the shuttle launches that took place, the subsequent review of those launches and the situation, the impact upon the O-rings and the seal and the putty were known, and were very much concerning many of the key engineering personnel, as you have testified to.

The third thing that we have learned today is that from Mr. McDonald and Mr. Boisjoly's point of view, that you were knowledgeable, therefore, the company was knowledgeable on the evening of January 27 before the launch that there was serious concern with the situation, particularly relating to the low temperatures and what effect, if any, it would have upon the O-rings, the pliability of the material and so forth, so there were legitimate problems, and you have continued to maintain that position.

Now I will go to my questions. We have not determined what happened in that discussion. We know what the result of the discussion was in the caucus discussion.

There has been an allegation made, and I think it is tough to bring it up, but it has to be laid on the table, I think. One of the allegations that has been presented and conjectured on is that during that half hour of the discussions in caucus by Thiokol, et al, that Thiokol or NASA in effect—let me get that correct now—that in effect, when Thiokol had taken its original position of no go because of the temperature and the concerns of your field engineers, and that was reviewed, that part of the discussion process was based upon the point of view that NASA was a great customer for Thiokol, so the allegation goes, and that factored in as one of the major parts of the decision above and beyond the safety and engineering facts that were available at that point, that Thiokol was bending to NASA's position based upon the fact NASA was a good customer of the Thiokol Co. Tough question; has to be asked.

So I would like to hear from Mr. Locke on that if you would like to respond.

Did you participate in the caucus, Mr. Locke?

Mr. LOCKE. No, I did not, Mr. Chairman.

Mr. ROE. Is there someone here who did participate in the caucus?

Mr. KILMINSTER. Yes, Mr. Chairman, I did.

Mr. LOCKE. Neither Mr. Garrison nor I participated in that conference that night and really had no knowledge of this decision—the decisions being made.

Mr. ROE. Would you pull the mike closer, it is very important.

Mr. LOCKE. Neither one of us had knowledge.

Mr. ROE. Neither you or yourself.

Mr. LOCKE. Mr. Garrison.

Mr. ROE. You were not there.

Mr. LOCKE. No. But I think Mr. Garrison might make some interesting comments on that point and we will hear from Mr. Kilminster.

Mr. ROE. Mr. Garrison, you understand where I am coming from. I want to know precisely what the feeling of the company is on that issue.

Mr. GARRISON. Yes, sir. I interviewed of course all of the people involved.

Mr. ROE. Were you there?

Mr. GARRISON. I was not there. But afterward I did talk to all the people. It's my belief in talking to those people that they made a decision that they thought was a reasonable technical decision and each one of them told me personally that they did not feel pressure from NASA. I don't think that is true of the engineering people that were in the caucus. I believe most of those people have testified that they did feel pressure.

But from the—my perception at this point in talking to my people, the people that actually made the decision is that they did not feel the pressure. They felt they were making a logical engineering decision.

Mr. ROE. Could you do something for the committee, could you give us a list if we don't already have it—I am not sure we do or not—of precisely the people that participated in that caucus, their names and what their official positions were.

Mr. GARRISON. Yes, sir, I believe that information is listed in the Shuttle Commission report.

Mr. ROE. OK, fine, I don't recall that.

Mr. GARRISON. Yes.

Mr. ROE. The second question I want to ask, I think it is a very important point to develop at this point; the engineers to me are the people who are the knowledgeable ones in the sense of the technology involved and the issues. If the engineers felt that there was some legitimate technical problems they were concerned with, what motivated other than the engineering staff, namely administrative people or managers in that caucus, how was the decision of the engineers' overridden? There has always got to be some leader.

Was there someone in charge of the caucus? Was there someone who, as I am chairman of this particular venture and all our people are capable of course, was there somebody who tilted that decision? That decision had to be made from a basic point of view of technology available versus the point of view of a business discussion or something, something had to happen there. Because the engineers have testified that they were not satisfied with the decision even after it was made.

Mr. GARRISON. I don't want to pretend to put myself—

Mr. ROE. I understand you were not there.

Mr. GARRISON. In the minds of the people who were there, because I could not feel the emotions and did not know what was transpiring, but I would like to make a couple of comments and clarify the fact that these were not administrative people. They were all engineering people.

They were all from engineering background, although they were management people they had worked up through the ranks. So they do have enough technical background, I think, to follow logically some engineering analysis.

Second, there was really no incentive for the company to be anything other than conservative. I have read some articles in the press that seem to insinuate that we had some incentive that caused us to make that decision and that is not true. As a matter of fact, our incentives are in the opposite direction. We have tremendous losses, financial losses if we have a problem with the shuttle flight.

So I wanted to make those two comments and other than that, Mr. Chairman, I am not able to put myself in those people's shoes but I have talked to all of them and Mr. Kilminster, of course, was a member of the four people that we considered the management group that made the decision.

Mr. ROE. Could we hear from Mr. Kilminster? What was your observations at the time?

Mr. KILMINSTER. Yes, sir, I think that the data was not conclusive relative to blowby. For instance, the data that was presented indicated that a flight at 75 degrees had also experienced some blowby although it was not as extensive as it was in the previous cold launch. In addition we had conducted some static test motors that as we knew at that night had been fired with O-ring temperatures in the range of 48 to 47 degrees, and there was no O-ring blowby observed on those.

As Mr. Boisjoly had mentioned, they had conducted subscale tests with the right seal gaps, full diameter O-rings and as a matter of fact, at lower squeeze condition than what we had in the 51 LSRM's and observed no blowby. The other two aspects that were looked at and were discussed in that caucus were the fact that the secondary O-ring by nature of the leak test was in the downstream desired position so that even if there was some blowby to occur of the primary O-ring that seal would be in position and would be capable of sealing.

The other aspect that was discussed was on that previous coldest launch where we did observe erosion blowby, there was thirty-eight one-thousandths depth of erosion on that primary O-ring. So whatever caused it, whether it was jet impingement or blowby, thirty-eight one-thousandths was there. We had previously run tests that demonstrated that he could have one hundred and twenty-five one-thousandths at least erosion on the O-rings and have them successfully function. So it was based on those technical judgments and that technical background that the decision was made as far as I am concerned.

Mr. ROE. Let me ask you one followup and conclude before I call on the gentleman from New Mexico, for the benefit of the committee did everybody jump up and say how many people participated, I don't remember the number, 12, 14, in the caucus?

Mr. KILMINSTER. I think there was 12 or 13.

Mr. ROE. Twelve or thirteen, yes, the Apostles. The point in question, did everybody then say now that we have reviewed all the technical data available and we feel pretty much this is the right

thing to do, let's go ahead with it. Or were there still people that documented whether that direction should be taken?

Mr. KILMINSTER. As far as I was concerned, I felt there was four people in the room that still felt that from a conservative basis that it was not a rational thing to do to describe that.

Mr. ROE. Was a decision made then at that point and your people, whoever was the head of that caucus, had the right to make that decision and telegraph that to Mr. McDonald and go with it, or did it have to go higher leadership, did it go to Mr. Locke, did it go to Mr. Garrison. Who made that decision to go. What was the chain?

You had your caucus, everybody wasn't all together on this thing, they were concerned. There was legitimate misunderstandings or lack of engineering data and so forth, what happened then specifically.

Did you call up Mr. McDonald or someone call Mr. McDonald and say, we analyzed it and we are going to go with it. What happened?

Mr. KILMINSTER. At that point in time a management poll was conducted.

Mr. ROE. What does that mean, a management poll?

Mr. KILMINSTER. Mr. Mason, who is the senior vice president, asked for an assessment by the managers. The managers included Mr. Lund who was vice president of engineering, Mr. Wiggins who was the space division general manager and vice president, myself, and Mr. Mason.

Mr. ROE. OK. That management group made the decision?

Mr. KILMINSTER. That is correct.

Mr. ROE. So it didn't get to Mr. Locke or higher people. That was the management group that was responsible to make that decision, is that correct, yes or no.

Mr. KILMINSTER. That was the decision that was made at that level, yes, sir.

Mr. ROE. And how did you, just for clarity, did you telephone Mr. McDonald or what?

Mr. KILMINSTER. We reopened up the net of the telecon.

Mr. ROE. OK.

Mr. KILMINSTER. We had been on caucus where everybody was on hold. And we reopened the net and at that point in time, I summarized the basis for our decision to proceed with the launch and then during that portion of the telecon we were requested by NASA to put that in writing and sign it and send it down.

Mr. ROE. And you did.

Mr. KILMINSTER. And we did.

Mr. ROE. And the decision was made.

Mr. KILMINSTER. Yes, Mr. Chairman.

Mr. ROE. The Chair recognizes the distinguished gentleman from New Mexico.

Mr. BOEHLERT. In one point you make, would you yield just a moment?

Mr. LUJAN. I would yield.

Mr. BOEHLERT. During that off-line caucus, Mr. Lund apparently was one of those rather persistent in recommending against proceeding.

Could you tell me and the committee if Mr. Mason, as has been reported, said to Mr. Lund, take off your engineering hat and put on your management hat.

And if he did say it, could you interpret for us what he meant by that?

Mr. KILMINSTER. I can confirm that he did say that. I cannot interpret what Mr. Mason meant by it but I can tell you what my interpretation was.

Mr. BOEHLERT. That would be helpful.

Mr. KILMINSTER. My interpretation was that there was perceived to be differences of opinion amongst the engineering people and that as is common when you have a number of different viewpoints, someone has to collect that and make an engineering decision and that would be in Mr. Lund's role to do that.

Mr. BOEHLERT. He was the key man in terms of the engineering decision, is that right?

Mr. KILMINSTER. That is correct.

Mr. BOEHLERT. And he was recommending against proceeding.

Mr. KILMINSTER. No, sir. He initially he covered prior to the caucus he did cover charts that recommended against the launch. And then subsequent after the caucus then he was one of the four managers that was polled and agreed to launch.

Mr. BOEHLERT. After it was suggested that he talk—

Mr. LUJAN. I have only 3½ minutes left.

Mr. BOEHLERT. All right.

Mr. LUJAN. I did want to pursue something with Mr. McDonald.

You said you were taken back, surprised with that decision. You were down at the Cape. Is it considered not proper—first of all let me ask you, do you know Mr. Aldrich and Mr. Moore?

Mr. McDONALD. Yes, I do.

Mr. LUJAN. Is it considered not proper for you to go to them. They are the ones that have to make the final decisions. Once they had said that you should go ahead with the launch, you felt very strongly I gather that you should not.

Is there something in the protocol that says you shouldn't go to Moore and Aldrich and tell them, hey, there is a real big problem here?

Mr. McDONALD. Yes, I think it is unwritten in the protocol but I didn't really think there was any need to do that because I knew that Mr. Reinartz was a member of the Mission Control Team with Mr. Aldrich and Mr. Moore, and in fact until the testimony I was under the impression that Dr. Lucas was also a member of that team.

I found out later he was not. I knew that was Mr. Reinartz' boss and he was going to talk to him about it. Of course Mr. Mulloy was there who I communicate with and who Mr. Reinartz takes his recommendations on any problems associated with the solid rocket boosters, and I felt I was talking to exactly the right two people about voicing my concerns even after the decision was made as to why I didn't feel good about this launch and I was surprised that they would accept that recommendation because—

Mr. LUJAN. Do they have a meeting every—in the morning to my understanding right before the launch to go over last minute

things and decide whether you are going to launch at that point or not?

Mr. McDONALD. Well, I was unaware that they did. I guess maybe they do, but I was—

Mr. LUJAN. So you were not there.

Mr. McDONALD. I was not there. I was sure that they would pass that on.

Mr. LUJAN. By that time they could see the ice on the pad and everything and it might have been a good time to raise the question, but if you were not there, no way.

Mr. KILMINSTER. You say they had you put it in writing that you had made a decision to launch. Was that normal? Did you have to—every time you had a disagreement did they have you send a telegram or wire or put it in writing or sign off that we ought to do this or was this unusual because there was so much dissention?

Mr. KILMINSTER. Well, in this case the whole operation was unusual in that we had not previously had an issue come up so late in the launch process. However, it is normal during the flight readiness review process for me to sign off at various stages that the solid rocket motors are acceptable for flight, and I normally do that.

Mr. LUJAN. How soon before the day of the flight? This is the only—this is the first time you had to do it just the day before, is that correct?

Mr. KILMINSTER. That is correct.

Mr. LUJAN. Before that if you can remember, how far away from the day of flight did you have to sign something?

Mr. KILMINSTER. I think it was approximately 3 weeks.

Mr. LUJAN. Three weeks, and this was the first time otherwise. So there was a realization that it was a very serious matter and to put it very bluntly, probably put the monkey on your shoulders rather than accept that responsibility if anybody questioned why did we launch, they could say well, Kilminster told us it was all right and here's the proof.

Did you feel that way?

Mr. KILMINSTER. No, I was not really surprised when I was asked to send down a piece of paper with my signature on it. However, I have to say that it was unusual because the whole operation was unusual.

Mr. LUJAN. One final—

Mr. ROE. Go ahead.

Mr. LUJAN. One final question, Mr. Locke, and one of the things that we look for in the committee is what changes need to be made in policy. In your testimony you say:

Our space experts reviewed the available data initially and concluded launch should not occur at O-ring temperatures lower than 53 but we all know NASA questioned Morton Thiokol's decision and our engineers could not prove that it was unsafe to fly at less than 53 degrees Fahrenheit.

That seems to be a reversal of past NASA criteria where in the past you had to prove that it was safe, not that it was unsafe. Is that just an unfortunate use of words or did you feel that this was a different circumstance?

Mr. LOCKE. Well, remember that we are making these judgments now after the fact.

Mr. LUJAN. Yes.

Mr. LOCKE. And that selection of words was deliberate.

Mr. LUJAN. That was basically what NASA asked you to do, to prove that it was unsafe rather than that it is safe to fly?

Mr. LOCKE. It seemed that way, yes, sir.

Mr. LUJAN. Thank you very much.

Mr. ROE. I thank the gentleman.

The Chair recognizes the distinguished gentleman from New York, Mr. Scheuer.

Mr. SCHEUER. Thank you, Mr. Chairman.

Mr. Locke, you are quoted as saying to a newspaper man recently—as a matter of fact on your first page of your statement you talk about the pain and anguish of this tragic accident. Is this what you were referring to when you mentioned to a newspaper correspondent recently and I quote, “This shuttle thing will cost us 10 cents a share this year.”

Mr. LOCKE. Yes, sir, it was. And I would like to clarify the circumstances under which those remarks were made.

This was—

Mr. SCHEUER. Make it very brief because we only have 5 minutes and I have some other questions to get on with.

Mr. LOCKE. This was an article by the Wall Street Journal who asked me to give them a financial analysis of where the company stood as a result of the shuttle incident, as well as all other factors of the company.

Mr. SCHEUER. All right.

Mr. LOCKE. So I was simply responding directly to his questions.

Mr. SCHEUER. From the national point of view, would you agree that it cost every shareholder in the American company, every man, woman and child in the United States, not 10 cents a share but perhaps \$20 or \$25 a share? And that is not counting—

Mr. LOCKE. Well, sir—

Mr. SCHEUER [continuing]. Not counting the incalculable loss of time that we cannot put a monetary value, the trauma to the American people, the incalculable loss in lives, the seven lives that were lost? Would you say that is a true financial loss of the accident, \$25 per shareholder in the American enterprise?

Mr. LOCKE [continuing]. Sir, I don't believe you can put a financial value on this tragedy at all.

Mr. SCHEUER. You certainly can't. And I would say that your statement that this shuttle thing cost us 10 cents a share, has to go down in the annals of history. In 1882 William Vanderbilt, in answer to another newspaper reporter's comment, said “The public be damned.” Now, for over a century that remark has stood unchallenged and unparalleled for its gross insensitivity, for its banality and tastelessness, but I believe you have finally done it. You have finally moved Mr. Vanderbilt over in that corporate dealership hall. You have done it.

Let me ask you another question, on the first page of your statement you said it was our solid rocket motor that failed. Flat statement.

In your contract with NASA, the Morton Thiokol contract with NASA, it provides that in the event of a failure of the solid rocket motors to perform in compliance with the specification require-

ments of the contract, there will be a fee reduction of \$10 million and the loss of the flight success incentive fee.

Would you say that your failure as you described it, the solid rocket motor that failed, would trigger that \$10 million fee and the loss of your flight success incentive fee?

Mr. LOCKE. Sir, that is a contractual matter that I will just have to defer to other people to conclude.

Mr. SCHEUER. Well, what is the clear meaning of those words and the clear meaning of your words this morning? This morning you said it was your rocket motor that failed. Now let's leave all the Philadelphia lawyers out of this. You said our solid rocket motor failed. OK?

In this contract it is perfectly clearly stated that in the event of a failure of the solid rocket that \$10 million penalty would be triggered and the loss of your success incentive fee, flight success incentive fee would be triggered.

Is that a fair reading of the contract and a fair reading of your words this morning?

Mr. LOCKE. The contract is a very complex document.

Mr. SCHEUER. It is not complex. It is very straightforward, Mr. Locke.

Mr. LOCKE. I don't have any other comments.

Mr. SCHEUER. Mr. Locke, you have said on page 2 of your testimony that this policy of openness in which you respect the candor of these men and their engineering knowledge will not change as the space program regroups and moves forward. Yet you told this same reporter that once—I quote, "Once this Commission issues its report and this thing is closed, it is going to be a different situation because people are paid to do productive work for our company and not to wander around the country gossiping with people.

You were also critical of engineers "who travel all over the country at our expense to appear before commissions or just take idle trips to talk to somebody in Washington."

Now, here you have taken a trip. I hope you don't think it is an idle trip to come to Washington to talk to someone and a number of your staff have come, too. Your words are open but I detect from these comments to the Wall Street Journal that you don't consider commission hearings and you don't consider congressional hearings to be a very constructive part of the legislative process, you don't look on them favorably.

Now, which is it?

Mr. LOCKE. Well, sir, as I said before the interview with that particular reporter was a very long interview and they selected certain parts of the comments to report. They did not report the entire—

Mr. SCHEUER. They never do, but we don't write the stories, do we? We found that out up here. Apparently you were not misquoted and you said that travel all over the country at our expense to appear before commissions or just to take idle trips to talk to somebody in Washington is not what you consider a legitimate corporate activity.

Do you really believe that? Are you here today just to talk to somebody? Is this an idle trip just to talk to somebody in Washington?

Mr. LOCKE. Those remarks were made in connection with the conclusion of the Presidential Commission's report and the conclusions of all of the investigations. All I was simply trying to say was that after all of the investigations are over, we have a very big and very complex job to do and we have got to get on with it.

Mr. SCHEUER. Does this mean that you will cooperate with whatever continuing ongoing oversight there will be and that you won't cast a damper or cloud or bring any pressure on outstandingly fine Americans buying Mr. Boisjoly and Mr. McDonald in their efforts to help us understand what happened and to prevent coming like this from happening again?

Mr. LOCKE. Sir, I think our record is very exemplary. In fact, Mr. Rogers himself said before this committee that he had gotten complete cooperation from this corporation during his investigation. He was very, very complimentary of us and I am very glad that he did say that to this commission. We have—we will continue to be.

Mr. ROE. I think we have pursued that line far enough. I think that we are at a point where we have sown in our witnesses, we expect the facts to be on the table, plenty of room to look in hindsight but I think your testimony is clear, and we expect that kind of cooperation.

The Chair recognizes the gentleman, distinguished gentleman from Missouri, Mr. Volkmer.

Mr. VOLKMER. Thank you, Mr. Chairman.

I would like to ask Mr. Kilminster, in your statement you state that approximately—page 6—approximately 40 people devoted substantial time and energy to this effort, and that was on the joint/seal task force. Can you give me in writing the names of the persons who were on that task force, the job performance they were performing, and the amount of time that they individually spent on that task force from August 1 through January 1 last year?

Mr. KILMINSTER. The task was initiated in August 1985 and continued on through January of 1986. I do not have those detailed information here.

Mr. VOLKMER. I don't ask for it now. I want you to submit it to me in writing.

[Material available from committee files.]

Mr. VOLKMER. To be honest with you, Mr. Kilminster, after reviewing the Commission's report—and I am sure you did, did you not?

Mr. KILMINSTER. Yes, sir.

Mr. VOLKMER. Did you see the statement in there, the activity report for Mr. Boisjoly dated October 4, 1985. He asked, "I should add that several of the team members requested that we be given a specific manufacturing engineer, quality engineer, safety engineer and forward this to six technicians to allow us to do our test on a noninterference basis with the rest of the system."

"This request was deemed not necessary when Joe"—I believe you are Joe—

Mr. KILMINSTER. Yes, sir.

Mr. VOLKMER [continuing]. "Joe decided that the nursing of the task approach was directed."

Mr. KILMINSTER. We will supply you with a summary of the activity that was conducted over that time period.

Mr. VOLKMER. I don't want a summary, I want it detailed.

Mr. KILMINSTER. We will provide it.

Mr. VOLKMER. I just don't believe you. I don't believe that you devoted substantial time and energy to that effort.

Mr. KILMINSTER. I would like to refer to Al. Would you comment on that?

Mr. McDONALD. Well, I don't know the—I can't give you the names of those 40 people. There were some conflicts in getting some things done in the plant and I shared Mr. Boisjoly's frustrations, I think we all did. I think what one has to remember in this particular instance in the shuttle, because the hardware is so large, when you have problems you normally can solve an engineering type problem and go in the laboratory and solve that problem because the hardware is small, you can go test.

Here we have to use very large pieces of equipment. We have to use flight hardware to run some of these tests and we have to be very careful that we don't do anything to that hardware that makes it unusable for the flight.

Mr. Boisjoly was getting very frustrated that we were handling the engineering assessment effort just as if we were getting ready for a flight. In many cases we have no option but to do that because the hardware may go back into flight.

Mr. VOLKMER. I would like to ask Mr. Boisjoly to take the witness table and ask him if he ever received those personnel that he asked for in that activity report of October 4, 1985?

Mr. BOISJOLY. No, we did not. We were told that if the problem required nursing it all the way through to completion, then that was our task, to nurse it. I believe I made a statement that there just wasn't enough time or personnel available to nurse those types of problems, and I was referring to laboratory tests as well as full-scale tests at the time, and I just felt as Mr. McDonald said, very, very frustrated that we were not proceeding ahead in a timely fashion.

Mr. VOLKMER. Isn't that because of the administrative paperwork, et cetera, it takes to get things done within Morton Thiokol?

Mr. BOISJOLY. Yes, yes, not just Morton Thiokol but let me explain something. For instance, I was frustrated in procurement. We had a piece of equipment that we needed that was on the shelf at a company in San Diego that we could have simply gone down and picked it up and brought it back and used it and we had arranged to do something similar to that, while the procurement process and the rules that govern Government contracts are such that it is just not as straightforward as that, and I was frustrated that we couldn't go down and just pick it up and use it because we had arranged the use of that equipment in our laboratory and by the time we got the piece of equipment through the procurement process and the paperwork process, we had lost our window in the lab.

That was just one of many instances where I worked out procedures with the vendors to give us equipment, O-rings, materials, et cetera, and we just couldn't get the purchase orders written and go down and get them. Part of that was due to the rules and regulations of going out and getting single sources so we were operating in a mode that we couldn't operate like a development program.

That was the basis and source of those memos.

Mr. VOLKMER. Now, you have earlier in your testimony—let me ask you this. Did you have any assistance from management in cutting this redtape, getting through it so you could get these things?

Mr. BOISJOLY. Some, but I still felt as a result of our trying to get this work done that it was not sufficient. I didn't think there was any reason why we couldn't get the technicians asked for, and we couldn't go outside the regular production program and do this on the side and let the regular system work in and of itself.

Mr. ROE. If the gentleman from Missouri will hold. There is a point we have to check on. I will give you extra time.

You used the word single sources. Could you explain what you mean? Was it a decision of single sources from the Thiokol or single sources through the NASA process or what?

Mr. BOISJOLY. No, and I am not familiar with the purchasing regulations that the Government imposes but apparently we are not at liberty as a vendor—

Mr. ROE. "We," Morton Thiokol?

Mr. BOISJOLY. We, Morton Thiokol, are not at liberty to go out to single companies and purchase an item without going through a bid process. When you are trying to get a development program and test program going, they—

Mr. ROE. "They" being NASA?

Mr. BOISJOLY. The purchasing people in Morton Thiokol, go out and get bids. We have to get bids to get these materials from this particular company in a timely manner to run these tests. That all took time.

Mr. ROE. What I am trying to get in the record—you are confusing us here. At least this member. What I am trying to get into the record is that this is not a Thiokol process per se as a company, it is a governmental process, is that what you are saying?

Mr. BOISJOLY. That is correct.

Mr. ROE. All right, so the agency you deal with is NASA, so it is a governmental process that was creating this frustration, not that you couldn't get the material through the Thiokol leadership, is that correct?

Mr. BOISJOLY. That is correct.

Mr. ROE. If they had authority to do it?

Mr. BOISJOLY. That is right.

Mr. ROE. The gentleman from Missouri.

Mr. VOLKMER. Thank you, Mr. Chairman.

I would like to ask you, Mr. Boisjoly, because you have in earlier testimony referred to data from it on the August 9, 1985 memorandum to James Thomas from Bryan G. Russell in regard to the secondary seals. Did that raise a red flag to you for any further flights?

Mr. BOISJOLY. Are you talking about where he explained the time periods of—

Mr. VOLKMER. Yes, at 100 degrees Fahrenheit the O-ring maintained contact, at 75 degrees the O-ring lost contact for 2.4 seconds, at 50 degrees Fahrenheit the O-ring did not establish contact.

Mr. BOISJOLY. That is essentially the same data we presented on the 27th, the evening before the launch, yes, sir.

Mr. VOLKMER. That is the basis now. That was sent to Garrison, Kilminster, Evans, Brittan, McBeth, Boisjoly, Thomas, and Stein, they all had it.

Mr. BOISJOLY. Yes.

Mr. VOLKMER. Well, the other question I have is because it seemed to be confusion between Morton Thiokol and NASA, at least individuals that I talked to about the purpose of the putty; is or is not the putty intended as an insulation to the O-rings from the hot gases from the motor?

Mr. BOISJOLY. Yes, it was intended as a thermal barrier.

Mr. VOLKMER. Thomas, when we were at Kennedy a week ago Friday at a briefing, and I specifically asked him he said no. So I am just curious, it was intended as that.

Now, it is known that—a memorandum from John Q. Miller dated February 20, 1984 states that the putty served as a thermal barrier. A memo from George Beer, dated March 9, 1984 is no one really claims putting to be part of the insulation or sealing system and advised Marshall and Mulloy to consider removing it. Has that confusion existed throughout the development of the solid rocket motor?

Mr. BOISJOLY. I wasn't at the beginning, but we did have almost a year of discussions, I believe it was, in the 1984 timeframe about removing the putty from the joints. We had discovered that the blow hole, especially a single blow hole in the putty was providing the source of jet impingement on the O-ring seals and eroding them. If we could remove that source of jet impingement by either substituting another material or putting many interruptions in the putty purposefully we could take the sting of the jet away and the erosion would be minimized.

There was approximately a year's worth of discussions on that particular issue and we had proposed at one time to put putty in the joint of one of our tests and that was disallowed by Marshall.

Mr. VOLKMER. In your opinion should the sealing pressures have continued when it is known that after those started at 200 pounds per square inch that the erosion problems even became more greater?

Mr. BOISJOLY. I guess I don't understand your question.

Mr. VOLKMER. Well, you have a pressurized sealing, the jet, the test—

Mr. BOISJOLY. The leak check.

Mr. VOLKMER. Yes; for the leak check.

Mr. BOISJOLY. How that came about was that we were leak checking originally at 50 lb/in². We discovered just through many conversations and telecons, that we have got to check the putty because the most important thing to determine in a leak check is whether or not the seal is in fact in position to seal and doesn't have any contamination underneath it.

So we did a series of laboratory tests, I believe it was in 1983 which demonstrated that 50 lb/in² could indeed be masked by the putty. In other words, you might not even need a seal in the joint and you could pass the 50 lb/in² leak check. So we determined at what temperature—excuse me, at what pressure we would blow through the putty and we determined that 200 lb/in² under all circumstances of minimum tolerances would blow through the putty.

So we instigated a double leak check, namely 200 lb/in² to check and make sure the putty did not mask a leaking seal and then 50 lb/in² subsequent to that test to actually test the seal. Fifty lb/in² is a very difficult test on an O-ring seal. So that you have the best of both worlds, first of all the 200 lb/in² ensures that the putty is not masking a leak, secondly that the 50 lb/in² proves the seal is indeed going to seal.

Mr. ROE. The time of the gentleman has expired.

The distinguished gentleman from Michigan, Mr. Henry, please.

Mr. HENRY. Thank you, Mr. Chairman.

I would like to try to approach some of the contractual questions which were raised, I hope, in a little more objective and fair basis and change the climate.

It seems to me that what we have here is a supplier, the contractor of a Government agency, and there are contractual obligations on both sides, the supplier provides a service, produces a product, the Government reviews it, finds it acceptable or it doesn't, and has contractual obligations to pay—to put it in elementary terms. There are obligations on both sides.

The supplier has obligations, legal obligations not to deliberately misrepresent the certification of the product that is supplied to the Government, likewise the Government agency—in this case NASA—has obligations that are equally important under the law not to deliberately circumvent either in collusion or not in collusion with its suppliers the specifications of its own contracts.

I think the emphasis has to be on the second side of this equation every bit as much as on the first side of the equation. Pursuing the question, I think that has to be said given some of the other questioning earlier this morning. I guess one of the questions that would lead me to then is first of all, to Mr. Kilminster, my understanding is that the contract certifications require as a general standard that the solid rocket motors and the systems for which you contract be operational, safe, reliable, down to a standard of 31 degrees, is that not correct?

Mr. KILMINSTER. The original requirements were established during our proposal submittal and a model specification was provided to us by NASA. We interpreted that model specification and submitted back to NASA after we were on contract a development and verification plan which identified what we proposed to do or planned to do through the development program to meet all of the requirements.

Mr. HENRY. You are not answering my question. Doesn't the contract or the specification require a 31 degree performance standard on the bottom end?

Mr. KILMINSTER. As far as the motor performance is concerned, we do not believe it does. We believe that the motor performance specification is identified at 40 to 90 degrees and that is what the calculations and analytical work was based on for motor performance.

Mr. HENRY. We were told 31 degrees by Mr. Tully, so I would certainly appreciate if staff or someone would come to some determinative issue. Obviously we have, given the resiliency of the O-rings at lower temperatures, we have a tremendous gap in understanding.

I mean, on the record before this committee last week, we were told that it is a 31-degree standard that was an inadequate testing for subsystems for the system standard on the rocket motor. You are telling us your understanding was 40 degrees.

Even if your understanding was 40 degrees average, that would mean that when you personally signed the certification of flight readiness, your understanding of specification requirements was a 40-degree specification. Yet your concern was that we not launch at anything under basically the 50-degree threshold because of the experience on two other lower temperature flights down in the 50 degrees area, not wanting to get below that 50-degree threshold. Is that not correct?

Mr. KILMINSTER. Fifty-three degrees was the previous coldest launch.

Mr. HENRY. How could you sign a flight readiness certification and then come back and say we don't want to fly it below 53 degrees when you signed a specification, in NASA's interpretation, that certifies it as flight ready at 31 degrees, and your interpretation is at 40 or 41?

Mr. KILMINSTER. What we were doing is attacking on a real-time basis the information that was made available to us from the flight program and we were alerting the system that based on what we had observed on the previous coldest flight, and if we were to stay within our experience base, we had to stay within that 53 degrees.

Mr. ROE. Will the gentleman hold a moment for clarification?

I believe what we are trying to develop here in part, which I think is important to this part of the record, in Thiokol's opinion and their best judgment of the contractual agreements they have with NASA for the particular—you will have more time—what is the temperature range which you would consider to be your responsibility in your existing contractual agreements with NASA? What degrees? From what degree to what degree?

Mr. KILMINSTER. We have a number of components that are qualified over the range of 20 degrees to, I believe, 110 or 120 degrees. We have flight and insulation structural matters that are qualified for storage down to 32 degrees and we have operation, motor operation 40 to 90 degrees.

So there are multiple temperature ranges there.

Mr. ROE. If the gentleman will yield further, we will protect your time.

If you have a variable group of temperature gradients to deal with, there has got to be one—you got a motor, you have got to have one particular thing, something has to govern that. You can't have this little piece here and this little piece there.

What do you consider to be your range of temperatures you were responsible for to be able to say, go with that particular engine?

Mr. KILMINSTER. For motor operation?

Mr. ROE. Yes, sir.

Mr. KILMINSTER. That was 40 to 90 degrees.

Mr. ROE. Yes, 40 to 90 degrees. That is the point I wanted to make.

The gentleman from Michigan.

Mr. HENRY. Thank you, Mr. Chairman.

What I am trying to indicate is clearly we have discrepancy in terms of at least the way the presentation was made to us last week by NASA, which argued that every major subsystem, in this case, the solid rocket motors, was to be certified down to a 31-degree standard.

Even if it was, they still launched this then below their own specifications. That has to be said, too. I just don't want to dump on one side here.

I think it looks to me like there was a lot of waffling on the standards almost in a collusive environment where basically it is as if I were buying shoes for a major retailer and going to a manufacturer and I knew they came back and it didn't quite meet the specifications but I needed them for my sales and the manufacturer basically said, we will make it up to you later, and this kept going on and on and I had a sole-source vendor and spring sales were coming up with new shoe styles. These things happen. But in this case, you had contractual obligations that, because they are public force of law.

One question to Mr. Boisjoly following up on Mr. Volkmer's question, because I am not sure you got quite to what he was asking. I think the nature of my colleague's question to you was, were you aware of the fact that when you were increasing the pressurized testing on the O-rings, that you were inadvertently blowing out the putty or pushing back the putty in such a way that you were inadvertently increasing the likelihood that there would be gas bypassing the putty?

Mr. BOISJOLY. Yes, we discovered that on the testing of the filament wound cases in 1985. We actually walked down the bore of the motor in a horizontal position. We had looked at blowholes that were formed by assembly and we also found some blowholes that had been formed by leak checks.

So at that point, we knew that there were two mechanisms that could form blowholes in the joint in the putty, assembly and the leak check itself.

Mr. HENRY. Did you ever do any testing to see whether or not the leak testing with increased pressurization was perhaps a greater risk than just keeping the leak testing at the lower pressure?

Mr. BOISJOLY. No, because we all felt from a technical standpoint that it was more important to make sure that the seal had the major integrity and the putty above that was secondary to that, even though it was not an erosion problem; it was limited at that time in our thought process to an impingement of erosion, which was not a resiliency problem in the O-ring itself.

Mr. HENRY. Thank you, Mr. Chairman.

Mr. ROE. The Chair recognizes the distinguished gentleman from Florida, Mr. Nelson.

The gentleman from Florida.

Mr. NELSON. Thank you, Mr. Chairman.

That is where I want to pick up, Mr. Walker, what NASA told us Friday a week ago at the Kennedy Space Center, and what NASA again told us last week. That was my line of questioning I wanted to follow up specifically with you all as to what was your contractual obligation in certifying that in fact the motors would operate under what is called the natural temperature which was specified

in the contract down to 31 degrees, and then what was called the induced temperature which is defined in the contractual documents for the skin of the booster down to 25 degrees, and for the attachment joint down to 21 degrees.

Now, the question is, since NASA said that analysis on those contractual specifications was never done as it was required in the contract, the question is, Why? Anyone?

Mr. GARRISON. I would like to make a few summary comments on this issue. I think what we have to realize that about 12 years ago, we got a stack of documents and specifications and which our review lately of those determines that there was some room for interpretation. There were many levels of specifications.

We read those specifications and constructed a development, verification, and qualification program which we felt met the intent. Those plans were approved by NASA, and we proceeded and successfully completed those programs, and our article was bought off as being completed and having met all the requirements.

One of the problems I think we have, Congressman Nelson, is the interpretation of the people in the early part of the program. Now, we have gone back and read some of those documents now naturally, and we still have some confusion in interpreting the intent.

Now, if you would like, I would like Mr. McDonald to address some of the specific documents and what we think they mean, and some of the problems we have with them.

Mr. NELSON. Before he does that, let me try to understand how you could have confusion, because the document that you supplied, Morton Thiokol, dated February 17, 1984, to the Marshall Space Flight Center entitled "Performance Design and Verification Requirements" specifically makes reference to the natural environment and the induced environment, and makes reference to the appendix 10.10, and for the induced environment makes reference to the interface temperatures, so how could there be any confusion on that? Anybody want to respond to that?

Mr. McDONALD. Let me—I wasn't there in February 1984, but I went back to look at this subject because I came on the program about 2 years ago. I have been involved in the past year of certifying the filament wound case rocket motor for a flight out at Vandenberg, so I went back to see what the steel case motor was certified to.

It was my distinct impression from what went on and what was signed off by both the people at Thiokol and NASA that the motor was never intended to operate outside the 40- to 90-degree range. In fact, I wrote a paper on that subject, delivered it to the AIAA last July and it was approved by NASA that that is what it said.

Mr. NELSON. Let me interrupt you right there. You are talking about the requirements for the propellant of 40 to 90 degrees. But that is not what we are talking about. We are talking about the overall design environment requirements for the operation of the SRB's. We are not talking about the propellant requirement.

Mr. McDONALD. Let me address that one.

First of all, you must understand there is a difference between the SRB and the SRM. Our contract is the solid rocket motor. There is another contractor that Marshall monitors, USBI, that has a contract for the solid rocket booster.

Mr. NELSON. That is correct, but I am talking about what was in your response to Marshall entitled "Performance Design and Verification Requirements," prepared for Marshall by Morton Thiokol, dated February 17, 1984.

Mr. McDONALD. Right. I think the confusion there is if you go and look at those documents, and I went and looked at them, it never says anything about operating the motor; it is exposed to those kinds of environments just like we have in storage and in handling.

If you look at the JCS-07700, there is a table in there called ground thermal environment, and it says it must withstand that and that is the one that has the 31 to 99 degrees. In that table, it has two columns, one column says ferry sites; clearly nobody is going to launch anything in a ferry site. The other column says vertical flight.

Now, the interpretation, in my opinion, because below that is all the solar radiation factors, is that means the vehicle is sitting in a position ready for vertical flight. The right booster facing the ocean where the sun comes up, the left booster facing inland, the time for the exposure from solar radiation is a function of course, whether it is morning or evening, and the tail facing south.

There is no time duration on those exposure temperatures, which tells me that if, since there is no time on any of those, it can sit there indefinitely in that attitude and nothing bad can happen, but it doesn't say it is necessary to launch it, because clearly if you had that sitting there for a long time at 31 degrees, the propellant would start being 31 degrees, also.

Mr. ROE. Will the gentleman yield for clarity? I will give him more time.

Mr. NELSON. I will yield in just one second.

I can understand your response to that, Mr. McDonald, save for the definition from which you derive that 31 degrees. And the definition is this: Induced environment, "each element of the shuttle flight vehicle shall be capable of withstanding the induced environments imposed during transportation, ground operations," which you are describing, "handling, and flight operations."

Now, flight operations indicates one thing to me. So I can understand where you are coming from with respect to your answer, but that is not what the definition is.

Mr. McDONALD. Well, clearly in vertical flight, if you are flying the flight, you are flying to 40,000 feet and you are down to minus 50 or minus 60, that is a lot less than 31.

Why isn't that in there? It is totally unclear that is the worst temperature one will experience in flight, because it is not. So the interpretation that I made from that, and that is after the fact, by the way, because I wasn't here, as I said, in February 1984, because I can't conclude that that is what the vehicle is to be exposed to during operation.

Mr. ROE. The time of the gentleman has expired.

The Chair would like to get a clarification for the record, Mr. McDonald. There seems to be a, obviously, a lack of understanding, and it is not coming through clear to the committee as to what role the temperature plays.

You testified earlier when we asked you to respond in your observations that both yourself and Mr. Boisjoly had a concern and a continuing, nagging concern even though decisions were made that those extremely low temperatures that existed at that point gave you reason for concern based upon other data, technical data that was available to us and so forth and so on.

Forgive me, I did not put my own question in the order I wanted to.

But you are making a very telling point. You are coming back and saying there is no such thing as a static temperature per se, because it is continually variable—the sun, the clouds, the temperature itself, so there is no such thing as a continuing environment of a continuing temperature.

What you are saying is, as I understand it, depending on how that temperature fluctuates, if the vehicle remains standing, the whole vehicle will rise or fall to that temperature.

Is that a fair engineering comment to make?

Mr. McDONALD. That is right, depending on how long you are sitting there.

Mr. ROE. It could be a variable depending on if you got bad weather coming in on this side and the sun shining on that site.

So, in effect, you make another point. You say once the craft is launched, you have variable temperatures that take place because of the level that the flight is at; is that correct?

Mr. McDONALD. That is correct.

Mr. ROE. So we have a whole set of variable temperatures, is the point I think that is being developed here. Is that a correct statement to make?

Mr. McDONALD. Yes, it is. I think the specifications, for the motor is a lousy one.

Mr. ROE. OK. Let me finish the point. I don't want to break you off on that point.

Where I am coming from is this fundamental question, and I think everybody has been skirting around it, but haven't nailed it down yet. All we are trying to do is to determine the facts.

You recognize, in spite of the decisionmaking process, you expressed your concern as an engineer vis-a-vis the low temperatures that morning. The question really that should be asked in my opinion is, Is there a launch temperature at a given time that something that we are striking for? In other words, is there a decision that could be made as a launch temperature?

I think it is a cockamamie point of view, from my point of view, to have this part at this temperature, this part at that temperature, this part at that temperature. How the heck can you run anything that way?

It would seem to me you have to get to a point and say, at 42 degrees, hey, baby, whether that likes it or not, that is the way it will fly or it is not. That is the question we are trying to nail down.

Is there some magic on the temperature issue, on launching a vehicle? That is the question.

Mr. NELSON. May I support the Chairman on that point.

Mr. ROE. Let me get the answer.

Go ahead.

Mr. McDONALD. I agree with you 100 percent. That is exactly—

Mr. ROE. Thank God we are making progress.

Now, what is the answer?

Mr. McDONALD. That is exactly the argument that I had that night after the recommendation came back in not to fly at 53, to go launch with Mr. Mulloy and Mr. Reinartz, because Mr. Reinartz had made the comment in the caucus when we made a 53-degree recommendation that that didn't seem to be consistent with what he understood the motor was qualified for, which he understood was qualified from 40 to 90. I did, too.

So I argued with them afterwards as, how in the hell can you accept a recommendation to go fly this thing outside of what you think it is qualified for and what I think it is qualified for.

Mr. ROE. What was the response?

Mr. McDONALD. I didn't get one. I told them I wouldn't want to be the person to stand up in front of a board of inquiry if anything happened to this vehicle, and explain why I did that. I didn't get a response.

Mr. ROE. There was no response.

Mr. McDONALD. There was no response.

Mr. ROE. The Chair recognizes the gentleman from North Carolina, Mr. Cobey.

Mr. NELSON. May I follow your particular point just for a second?

Mr. ROE. If you get time from Mr. Cobey, I will be delighted.

Mr. NELSON. May I talk 10 seconds, Mr. Cobey?

Mr. COBEY. I yield.

Mr. ROE. The gentleman from Florida.

Mr. NELSON. The Chairman's point is well taken, Mr. McDonald, of saying there is a range of temperatures and you say, well, what happens high in the atmosphere where it is a lot colder—that is not the question.

The question is, What is the temperature and the distinctions made at the time of launch, because that is when that critical seating of the O-ring is supposed to take place.

Mr. McDONALD. Oh, I agree with that. But what I think the question was before us was, what did we qualify all of the elements of the solid rocket motor for to behave properly, at what temperatures?

As far as I was concerned—that was part of my discussion with the Marshall people that night—as far as I was concerned, we didn't qualify all those elements even at 40 degrees, which I thought was the operating temperature ranges for every single element; that we had qualified some by analysis, some by test and some by neither, including the O-ring seals.

Mr. NELSON. Is that an abrogation of the contract?

Mr. McDONALD. No, I think it was a matter of what people interpreted what that contract meant. It referred to those other documents and as I said it is a bad specification because it doesn't distinguish between operating environments and exposed environments the vehicle has to tolerate, but not do anything bad and that was the breakdown I think in those specifications. It is hard to interpret that.

Mr. NELSON. I thank Mr. Cobey for yielding.

Mr. HENRY. Would the gentleman yield?

I would like for the record a copy of the speech you gave in July 1985, apparently to a professional engineering society which is a matter of public record, that your interpretation and understanding is that is a 40-to-90 degree launch system and also presumably that speech you said was checked clear through NASA.

Mr. McDONALD. It was and was approved and with a couple of minor changes they wanted made for it.

Mr. HENRY. Thank you.

Mr. COBEY. Mr. Kilminster, in your testimony, you indicate that after the July 1985 launch, that you conducted O-ring compression and resiliency tests between 50 and 100 degrees to evaluate the—and evaluated the environmental exposure of the putty and subsequent O-ring erosion.

Why did you pick 50 to 100 degrees and why didn't you test it below 50 degrees, the resiliency, any reason?

Mr. KILMINSTER. I would like to refer that question to Mr. Boisjoly.

Mr. BOISJOLY. That testing was a direct outcropping of the SRM 15 or 51-C flight in January 1985. When we were going through the flight readiness reviews, we were addressing that temperature could have been a factor in that large amount of soot that we had seen.

So subsequent to that, like in the February to March timeframe, the testing proceeded on a very limited basis and we established three levels to get some very preliminary data and the three levels were 50 because it was around 53 degrees, 75 because that was pretty much normal and 100 to get a high bound on the testing.

Mr. COBEY. You didn't have the resources or the time—

Mr. BOISJOLY. No, we were trying to specifically get data on a flight that had just occurred to try and tie in the statements we had made on the flight readiness review for the next vehicle on the basis of our judgment and we were trying to get laboratory data to back up that judgment which we did.

Mr. COBEY. Then you were in no position to make any statement on resiliency and the compressing of the O-ring below 50 degrees?

Mr. BOISJOLY. Other than the fact that the trend was obvious. At 100 degrees, it never unseated. At 75 degrees, it unseated for 2.54 seconds and at 50 degrees, it never attached. So the conclusion was it was getting progressively worse and we did develop a matrix for testing later in the year.

Mr. ROE. What is puzzling me if we established a task force that was to review this issue of the O-ring, going back to earlier flights and we knew this so far in advance, why didn't we pay attention to it, because—I am getting myself involved, that is obvious. I am sorry.

The gentleman from—

Mr. COBEY. My next question would follow up on what you have just said. I am a little bit troubled by what I call committee decisions. I know, Mr. Kilminster, you signed the document that went to NASA to launch, but in a sense, there were four people that signed off and it was almost like a committee decision, there was no one person responsible.

In these unusual circumstances, why didn't your group contact Mr. Garrison, Mr. Locke? It seems like it was an awfully important

time in the history of your company, not just from 20/20 hindsight, but this last-minute, critical decision had never occurred before as to whether to launch or not launch.

I think there ought to be someone who ultimately—one person needs to sign off on something that critical.

Mr. GARRISON. It is troubling to me that I was not advised or brought into the decisionmaking process. I think I should have been and I think the people thought it was a real time technical issue, something that could be resolved. It was a decision that was compatible with the NASA position and they proceeded with it.

I am disturbed about that. We are looking at procedures in the past that will eliminate this problem in the future. It is a gap in our management system, I believe.

Mr. COBEY. Do you think that then you should have presented with their feelings at that time what this group, after they caucused and that you as a person should have made a decision yes or no, and then you would as a person be responsible rather than this responsibility being spread? How would you have handled it?

Mr. GARRISON. I am not sure at that level—I believe that this had such potential impact that it should have been brought to a higher management position. I don't want to put myself in a position that says I have to make and sign off on every decision because I have very competent management people who do that.

Mr. COBEY. But this was such a critical and unusual situation that it seems to me that it would have been proper for even Mr. Locke to have had to take a look at it.

Mr. GARRISON. I agree with that.

Mr. COBEY. And sign off.

Mr. GARRISON. Secondguessing or make a—

Mr. COBEY. Or make a decision, go or no-go.

Mr. GARRISON. I am sure if the people who made the decision and were involved could have anticipated the results of that decision, it would have come to us.

Mr. ROE. The time of the gentleman has expired.

The Chair recognizes the distinguished gentleman from Wisconsin, Mr. Sensenbrenner.

Mr. SENSENBRENNER. I have some questions of Mr. Kilminster.

Were there any minutes taken at the caucus where the decision to launch was made on the night of January 27?

Mr. KILMINSTER. No, no minutes taken as such. Notes were made as we developed the rationale and those notes were used then to transcribe into the telefax that I signed and subsequently sent.

Mr. SENSENBRENNER. Were the notes turned over to the Rogers Commission?

Mr. KILMINSTER. I don't believe I retained those notes after we typed them on to the—they were essentially the same. I was reading from notes—

Mr. SENSENBRENNER. Were the notes destroyed after you signed the telefax?

Mr. KILMINSTER. After we had it typed.

Mr. SENSENBRENNER. Were those typewritten notes essentially verbatim of what was taken down in longhand at this caucus?

Mr. KILMINSTER. Essentially, yes.

Mr. SENSENBRENNER. Were there any exceptions?

Mr. KILMINSTER. Not that I can recall.

Mr. BOISJOLY. If I may, I believe I was the only one that took some notes in real time after the meeting and I did hand those into the Commission and to my knowledge everything that was taken was handed into the Commission that reflected something different than presented on the telephone conversation that evening.

Mr. SENSENBRENNER. I am trying to understand how the decision to launch was made that night after Mr. McDonald phoned in from the Cape that it was too cold and we should not have a launch then and all of a sudden after this mysterious caucus Morton Thiokol overrode their professionals on the scene and decided that the launch was OK and the launch would take place with great tragedy.

So that I know what was done and what was not done, listening to some of the answers to the testimony, was there any testing done on the joints with that cold ambient temperature?

Mr. KILMINSTER. Mr. McDonald did not call in.

Mr. SENSENBRENNER. He was a participant in the conference and recommended that there should not be a launch. Didn't you get the impression that Mr. McDonald was recommending against a launch?

Mr. McDONALD. At the teleconference, I recommended that our vice president for engineering and engineering people assess that and make a recommendation at what we would launch at. They said we shouldn't launch below 53 degrees and I agreed with that. I didn't recommend it.

Mr. SENSENBRENNER. How did that get changed? The recommendation against launching suddenly became a recommendation to launch.

Mr. KILMINSTER. When we went on to caucus, we evaluated additional data. Specifically we took into account the testing that had been done.

Mr. SENSENBRENNER. What testing was that? Because we have had testimony here that there was no testing that was ever done with the ambient temperature that cold and Mr. McDonald in his speech and testimony has said that the testing was sufficient to operate the solid rocket motor between 40 and 90 degrees Fahrenheit and here the ambient temperature was 38 and the temperature in the joints was much colder than that.

What testing are you referring to?

Mr. KILMINSTER. To the testing done to identify that with erosion, you could lose 125 thousandths of material and still seal. That testing had been done some time earlier.

We compared that with how much erosion had been lost from the previous coldest launch, which was 38 thousandths.

Mr. SENSENBRENNER. Mr. Locke says on page 3 that Thiokol's engineers could not prove it was unsafe to fly at less than 53 degrees Fahrenheit. Saying that you couldn't prove that it was unsafe to fly at less than 53 degrees Fahrenheit is not the same as saying that it was safe to fly at less than 53 degrees Fahrenheit.

We then get testimony that there has never been any testing that was done at temperatures as cold as what were existent at the Cape at the time of the launch, that there wasn't an engineering

computation, and it seems to me that you opened a heck of a big crack for the *Challenger* to fall through, and it did.

Now how did that happen?

Mr. KILMINSTER. There was testing conducted at 30 degrees in a subscale vessel which Mr. Boisjoly talked about. That subscale vessel is 6 inches in diameter, but it has the full O-ring diameter and the O-ring gap or groove. That was done at 30 degrees and those tests indicated that there was no blowby in that test rig.

Mr. SENSENBRENNER. You said it never seated at 50 just a minute ago. We are getting all this conflicting evidence. Wasn't that enough for Thiokol to say, "Hey, something is wrong here," and you didn't say it?

Mr. KILMINSTER. I believe that we did point out all of the data that was available to us. We had shown that we had blowby at 75 degrees on one launch and we had blowby at 53 degrees. We had subsequently or prior to that conducted static tests down to 47 and 48 degrees with no blowby.

Mr. SENSENBRENNER. My time is up and I observe that after listening to your testimony, Mr. Kilminster, with 20/20 hindsight, you would do it all over again the same way.

Mr. ROE. The Chair recognizes the distinguished gentlelady from Kansas, Mrs. Meyers.

Mrs. MEYERS. Mr. Chairman, I am trying to get a clear idea of exactly the procedure that night.

Mr. McDonald, you were at Cape Kennedy?

Mr. McDONALD. That is correct.

Mrs. MEYERS. And you recommended, you said, to whom that the launch not be undertaken if it was under 53 degrees?

Mr. McDONALD. Well, I had recommended to Mr. Mulloy and Mr. Reinartz that I didn't understand how they could accept a recommend below 40. I did not know what happened back at Thiokol that changed the original recommendation which I agreed with at 53 to one of launch the next morning with no specific other temperature on there. I did not know what transpired.

As far as I knew, they had run new calculations or found new data or something that would support a lower temperature, but when I saw the statement with the information on it that he read from, I couldn't find anything really substantial there that would support a launch at those colder temperatures and I was frankly surprised that NASA would accept it because of what I thought was my interpretation and theirs is also of what the motor was qualified to.

Mrs. MEYERS. And so it seems to me, Mr. Chairman, that we have a lack of clear, unambiguous language. You recommended in, I assume, terms such as you just used to Mr. Mulloy and Mr. Reinartz, who are at Marshall?

Mr. McDONALD. They were from Marshall. They were at the Kennedy Space Center in the same room I was.

Mrs. MEYERS. They were at Kennedy, all right, and they in turn took your language and made the recommendation to Mr. Kilminster and the group, who were where?

Mr. McDONALD. No, they didn't recommend to Mr. Kilminster. They had questioned the earlier information which had come to the conclusion that we shouldn't launch below 53 degrees Fahren-

heit. They had raised questions about that, and it was then that the Thiokol people headed by Mr. Kilminster had a caucus to reassess that data.

Mrs. MEYERS. Where was Mr. Kilminster?

Mr. McDONALD. He was in Utah.

Mrs. MEYERS. So it went from you to Mr. Mulloy to Mr. Kilminster and his group in Utah?

Mr. McDONALD. I transmitted the temperature data to the people in Utah, but the conversations I had with Mr. Mulloy and Mr. Reinartz about the lower temperature recommendation was after Mr. Kilminster had made the recommendation to proceed on with the launch, after Thiokol had changed their mind from the original 53-degree recommendation.

Mrs. MEYERS. Mr. Kilminster just said in response to Mr. Sensenbrenner that he did not get the word from you that you had recommended not to launch, and you replied then that that was because you had not talked directly to them, you had talked to Mr. Mulloy.

Am I confused?

Mr. McDONALD. No, not totally confused. That is correct. I talked to Mr. Mulloy. I did not talk to Mr. Kilminster.

Mrs. MEYERS. All right.

You said, Mr. Kilminster, I think it was, that you requested an off-line caucus. Can you tell us exactly what that means?

Mr. KILMINSTER. I requested to go off the telecon net by putting the telecons on mute on our end of the telecon so that we could more effectively discuss the items that had been brought up during the earlier discussion and see if there was any additional information we wanted to take into account in formulating a decision.

Mrs. MEYERS. Had you ever gone off line before during a launch?

Mr. KILMINSTER. Well, this was not during the launch. This was a separate telecon set up and we typically can go off line, go on mute when we are having a teleconference on technical matters or whatever.

Mrs. MEYERS. But had you ever requested such a caucus in prior launches?

Mr. KILMINSTER. No. This was unique in that regard.

Mrs. MEYERS. Mr. McDonald, you recommended against the launch.

Mr. McDONALD. That is correct.

Mrs. MEYERS. Had you ever done that before?

Mr. McDONALD. No, I had not.

Mrs. MEYERS. Prior to January 27, was it ever stated to NASA in clear, unambiguous language that the shuttle should not fly until that solid rocket motor joint had been redesigned?

Mr. McDONALD. It had not been stated by me to that effect. I believe someone, Mr. Thompson may be able to answer. He wrote a memo or something, but his recommendation never went to NASA. I don't know of anybody that made that statement to NASA.

Mrs. MEYERS. In the testimony of Mr. Kilminster, it says in July 1985, we ordered—a detailed presentation on all our experience with solid rocket motor seals was made to NASA headquarters in August last year; that is, August 1985, by Al McDonald.

If you conveyed all of your experiences with solid rocket motor seals, was there a recommendation made at that time?

Mr. McDONALD. I would like to address that since I am the one that made that presentation.

Yes, there was a recommendation at that time, and I think you need to understand how that meeting came about. We had flown at the end of April—I think it was STS-51 Baker, a flight where we received the aft segment back at our plant in Utah and removed the nozzle from that aft segment in the latter part of June.

On that nozzle, we found the primary O-ring seal on the nozzle had eroded completely through and eroded approximately thirty-two one-thousandths of the secondary O-ring.

As a result of that problem, we were asked to come down to the Marshall Space Flight Center to address what we observed and understood about it and why it had happened and in July we did that in great detail.

As a result of that meeting with the people at Marshall Space Flight Center, the people at NASA headquarters had asked us to come to Washington to review that situation with them and to combine it with a couple of other already scheduled meetings with the people at NASA headquarters.

When I sat down with the engineering people to put together the presentation as to what happened on that flight and why we thought it happened, the engineering people and myself decided that even though that was a very bad thing to happen on the nozzle that the secondary seal on the nozzle is much better than the one we have in the field joint and it clearly worked.

It is a face seal around a corner rather than a bore seal that we have one in line after each other in the field joint. We concluded that had we have had an incident like that occur in the field joint we may have lost the vehicle.

So we decided that I would make the presentation on the whole SRM pressure seal issue, what have we seen on every seal and every joint and to identify very clearly that even though this happened on the nozzle our greatest concern was on the field joint, which we did and we went through that presentation with all the detailed history of every anomaly that we had observed, what we understood about it and the conclusion was that on the nozzle seal that that was a quality problem—not a design problem, but a quality problem.

We had concluded that we had missed the leak check on that nozzle, and that by the way goes back to why we went up to the 200 lb/in² for the leak check, even though we knew that in some cases a leak check can blow holes in the putty.

We also knew you didn't need a leak check to blow holes in the putty. The assembly itself would cause that.

When you put the assemblies together as soon as the O-ring hits the metal parts, the air trapped in the pressure blows up through the putty. We know if we get blowby during the leak check, it can blow holes in the putty.

We had found that the putty indeed can hold 100 lb/in² sometimes and were worried it may be masking the leak check of whether the O-ring was good or not. It so happened the flight set that we had a problem with was the last nozzle flown that had a leak check at a 100 lb/in².

We found out later that putty could hold pressure as high as 100 lb/in² so we went to 200 lb/in². We concluded the reason that

primary O-ring had burned through is it never sealed in the first place and the O-ring had to erode enough material to the jet impingement and blowby to end up in the condition it was and we had just missed that leak check and therefore we needed to retain the 200 lb/in² and all flights afterward had the 200 lb/in² leak check.

Mr. VOLKMER. Would the gentlelady yield?

Did Mr. Mulloy tell you that after 51-B there would be a launch constraint?

Mr. McDONALD. No, he did not.

Mr. VOLKMER. After 51-B?

Mr. McDONALD. No. We addressed each launch any time we had an anomaly on every launch, we had to get up and explain what that anomaly was, what we knew about it and why we felt that that anomaly was acceptable to fly with if it should occur again and what have we done to fix it and that is the way every launch was conducted.

I did not know that there was a launch constraint that was imposed subsequent to that problem.

Mr. VOLKMER. You were never informed of it?

Mr. McDONALD. I was not.

Mr. VOLKMER. Thank you.

Mrs. MEYERS. To get back to the meeting in August again, Mr. McDonald, did you make a specific recommendation that the shuttle should not fly until that joint was redesigned at that time?

Mr. McDONALD. I did not. The recommendation we made was to accelerate our efforts to try to solve the problem.

Mr. ROE. The time of the gentlelady has expired. The chair recognizes Mr. Andrews.

Mr. ANDREWS. Mr. Kilminster, Mr. Locke in his opening statement says that our engineers could not prove that it was unsafe to fly at less than 53 degrees Fahrenheit. Is that a correct statement?

Mr. KILMINSTER. Yes, I believe it is.

Mr. ANDREWS. Was that the standard that was imposed upon you by NASA?

Mr. KILMINSTER. No; I don't believe so.

Mr. ANDREWS. Who imposed that kind of burden on Thiokol?

Mr. KILMINSTER. Well, as a member of the team, our job is to recommend to NASA based on the data base that we have our recommendations relative to the acceptability of those motors for flying. And the data that we had that evening was inconclusive. In fact, that is what it said on some of our earlier charts that we used in the earlier part of the telephone conversation.

Mr. ANDREWS. Previous launches—was it not the case that the burden of Thiokol was to prove that it was safe?

Mr. KILMINSTER. Yes; that is correct.

Mr. ANDREWS. And Mr. Locke seems to imply that on this launch NASA suddenly flipped that burden, that you suddenly found yourselves having to show that it was not unsafe to launch; is that correct?

Mr. KILMINSTER. I believe Mr. Lund has testified that he felt that way.

Mr. ANDREWS. What did you think?

Mr. KILMINSTER. I felt that this was not uncommon to the way that we normally made our recommendations to NASA. When we got on the loop and discussed the technical data that was there to be discussed, we were asked in my opinion to take a good look at that data and rationalize from that data what we were recommending. And the point was that there was data that was not absolutely conclusive that O-ring blowby was a function of temperature.

Mr. ANDREWS. I would like to ask Mr. Locke—Mr. Locke, please tell us what you mean by this burden of proof. In your opinion, was there a change imposed on you by NASA for this launch that you did not have on other missions?

Mr. LOCKE. Your honor, as I have said to you before, I was not there. That is an interpretation of mine after having learned what I have learned up to this point, that there seems to have been a change in order. But that is a judgment.

Mr. ANDREWS. Well, that is what your written testimony is. Why is that? How could that have happened?

Mr. LOCKE. I don't understand what you mean how could that happen.

Mr. ANDREWS. What kind of contractual relationship did you have or do you have with NASA that imposes a burden to show that it would be unsafe to fly? For you as opposed to on NASA?

Mr. LOCKE. I don't think there is such a contractual requirement.

Mr. ANDREWS. Mr. Kilminster, is that your understanding too, there is no written policy that exists?

Mr. KILMINSTER. I don't believe there is a written policy that exists, no, sir.

Mr. ANDREWS. But it is your testimony this morning that the impositions placed on you by NASA on the fatal launch were no different than previous launches; your obligation was to show that it wasn't unsafe to fly?

Mr. KILMINSTER. That is what I believe.

Mr. ANDREWS. Mr. McDonald, my understanding was exactly I think what Bob Crippen stated, that you always had to prove that it was safe to fly, and I had to argue why I felt our rocket motor was safe to fly and all of a sudden we reversed roles. I couldn't understand that. It was a total role reversal and all I had ever seen in the 2 years I had been in this program.

Mr. ROE. Will the gentleman yield? Is there anybody that we know of with your group or NASA's group that made that decision? In other words, our thesis and understanding is that everything we are doing is safety first based upon qualification tests of tests and parts and pieces to meet certain temperatures, and therefore the assumption would be if we meet the tests it is OK to fly. That is the positive approach.

What the gentleman from Texas is developing now, we have a negative approach and we are coming back and saying we don't know whether it is going to fail or not but we have no evidence to show that it will or will not fail at a lesser temperature or whatever the variance may be. Therefore it has never been tested for that, so somebody made an arbitrary decision someplace. Did NASA do that, did Thiokol? Where did it come from?

Mr. ANDREWS. Even worse, we have the man on the ground at Kennedy saying that it was his understanding on all previous mis-

sions up to this one that the burden was to show that it was safe, and that was your understanding, Mr. McDonald, and that is why you were so shocked during those conversations.

Mr. McDONALD. That is correct.

Mr. ANDREWS. We have the man who was in the room at Thiokol that was in charge of that meeting, saying the burden of proof is on Thiokol to show that it is not unsafe to fly, and that your understanding is on every previous mission that has been the burden. Is that what you are saying?

Mr. KILMINSTER. No, sir; I am saying I didn't detect any difference in the assessment that we had to make of the data that was available in order to make a recommendation to NASA.

Mr. ANDREWS. Which is it? Does Thiokol have the burden to show that it is not unsafe to fly or is it the burden to show it is safe to fly? Is it the positive or the negative?

Mr. KILMINSTER. I believe it is the latter.

Mr. ANDREWS. The negative?

Mr. KILMINSTER. It is our job to show that it is safe to fly.

Mr. ANDREWS. It is the positive, then.

Mr. KILMINSTER. Yes.

Mr. ANDREWS. You are saying now that you agree with Mr. McDonald.

Mr. KILMINSTER. That it is our job to show that it is safe to fly; yes, sir.

Mr. ROE. But who shifted the burden?

Mr. KILMINSTER. I think that is a matter of definition.

Mr. ANDREWS. Mr. Locke stated in his statement and reaffirmed that your engineers could not prove that it was unsafe to fly at less than 53 degrees Fahrenheit. So, now, that burden, according to you, as I understand your statement, Mr. Locke, changed on your company on this mission. Mr. McDonald is basically saying that is exactly what did happen.

Mr. ROE. If the gentleman will suspend for a moment, I am going to protect your time. We have this following information. Mr. Boisjoly testified to the commission, the Rogers report, page 93, that the offnet caucus was a meeting where the determination was to launch and it was up to us to prove beyond a shadow of a doubt that it was not safe to do so. This is the total reverse to what the position usually is in a preflight conversation or a flight readiness review.

Do you agree with Mr. Boisjoly's characterization of this meeting? If so, what caused this change in attitude by Thiokol and NASA? In other words, Mr. Boisjoly, would you elucidate here? You testified to that degree to the commission and that the offnet caucus was a meeting where the determination was to launch and it was up to us to prove beyond a shadow of a doubt that it was not safe to do so. Immediately there was a change, we had to prove that it wasn't safe to do so.

This is in total reverse to what the situation usually is in a preflight conversation or a flight readiness review.

Do you agree with Mr. Boisjoly's characterization of this meeting and, if so, what caused the change? Does anybody here have the answer?

Mr. ANDREWS. Mr. Boisjoly has been nodding his head. Would you confirm that the statement just read by Chairman Roe—

Mr. BOISJOLY. Yes; that is true, and the reason I made that statement is because I have been in flight readiness reviews at Marshall, specifically the one after the flight in January 1985, and I took a lot of flak, a major amount of flak, in trying to prove that the next flight was safe to fly. And so here we were presenting some information from an engineering standpoint that said one thing, and it was being interpreted as inconclusive, and yet we were never allowed to make judgments like that before.

Mr. ROE. Where did the flak come from? You said you took enormous flak.

Mr. BOISJOLY. From the flight readiness reviews, from the individual levels at the Marshall Space Flight Center.

Mr. ROE. From NASA?

Mr. BOISJOLY. Yes. That is where flight readiness reviews are held. We are not allowed to use things like "we feel that" or "we think that." We are always challenged and asked to present the data base, present the proof, present the information that supports the statement that you are making at the time.

Mr. ROE. The gentleman from Texas.

Mr. ANDREWS. I am still confused by Mr. Kilminster. I want to respect your comments but I read the statement by Mr. Locke and I hear the testimony of these two gentlemen, and yet you in the room—you don't seem to sense that there was a difference in the decisionmaking process on this mission and any other mission. We are trying as a committee to determine, as Mr. Rogers said, where do we go from here in terms of having the proper criteria so there is not a confusion.

I think we need a better understanding from you as to what the burden was on that group that made that decision in that room. You seem to imply that, frankly, there was just not any difference in this mission and any other mission.

When these other gentlemen, including the CEO in his written statement, says that suddenly the burden changed, that you were under the impression you had to show it was unsafe to fly—which is it; do you appreciate what these gentlemen are trying to say this morning?

Mr. KILMINSTER. I hear what they are saying and I think it is a matter of perception. My perception was with the data we had to show what our rationale was that it was safe to fly.

Mr. ROE. Therefore, that goes 360 degrees back to the first question asked, how do we deal with the issue that NASA is a good customer for Thiokol, and what forced that change of decision? The question to force the change of decision or to put in more information to the caucus came from NASA. That is the only place it could have come from, is that correct? Therefore, all the information that you had to consider—if the gentleman would yield further—in the caucus was a combination of the information that you had generated partly in response from the people in the field at Kennedy because of the temperatures and based upon the point of view that you were questioned on that data by NASA and then you had to reconsider at that point, which you did reconsider obviously.

Isn't that what you testified to? So someplace in that mix the decision changed from we are not going to fly, we don't think it is safe, the testing hasn't been proper, and now the reverse decision is made, we have no way to prove that we shouldn't fly.

That is the question. How did that creep into the decisionmaking process?

Mr. ANDREWS. I am not convinced Mr. Kilminster believes that that did change.

Mr. ROE. Mr. Garrison.

Mr. GARRISON. As I mentioned before, I was not involved that night, but I would like to give you my feelings based on having lived with this thing since the failure. I think the problem may lie in the fact that the Marshall engineering and the Marshall program management people had made their analysis and they felt that it was safe to fly and they were surprised when we came back with the recommendation not to fly.

I think that puts different kinds of pressures on different people who are exposed to that. I think the engineering people were shocked because they have always been on the other side, so to speak, to prove that we have enough data that says this is OK. I think Mr. Kilminster interpreted it as just another instance where we have to prove in great depth to NASA why we have established a position.

Mr. ROE. The gentleman's time has expired.

Mr. VOLKMER. I think this is very important.

Mr. ROE. The chairman agrees. Before this hearing is over, I hope you understand where this questioning is leading to. The commission said that we don't want to pin blame on an individual, that is what the commission said, and the Secretary has time and time again, on different news broadcast, reiterated that point and so have other people. Let me make one more point. Should this committee be holding oversight?

If the commission has done its work, what are we doing this for? For a specific reason. First, to totally acquaint the American people with what has happened here so we can put it behind us once and for all. And not necessarily to pinpoint blame but what happened in the management process between the companies involved and NASA. Macy doesn't tell Gimble, nobody knows. Who was in charge? Who did make the decision?

The question remains either Thiokol protects its own by the facts involved in the decisionmaking process and the facts involved. Marshall will testify this afternoon as to specifically what happened, because we could be having another launch someplace along the line and Macy doesn't tell Gimble. That is not going to happen as far as this committee is concerned. We are trying to get to the point of view that somebody made some decision someplace. Either it is all Thiokol's fault because you didn't follow the directions, or all NASA's, or a joint problem because we didn't communicate.

That is why we are trying to get these facts on the table as best you know them. I am trying to say that is the only way we can deal with the issue.

The gentleman from Missouri.

Mr. VOLKMER. Thank you, Mr. Chairman. I am a little concerned as the gentleman from Texas is and the gentleman from New

Jersey. What is becoming apparent to me, Mr. Kilminster, is that your group believed that you came to the conclusion that it was safe to fly that flight before the next morning; is that what you are telling me?

Mr. KILMINSTER. Yes, sir.

Mr. VOLKMER. How did you come to that after the previous discussion had been to the opposite effect? What I am concerned about—my question in my mind now is whether you first arrived at the fact that Marshall wanted you to say it was safe so you put that conclusion up here, and then you went through the process of finding the hypothesis to come to that conclusion and after reviewing your charts that you used and the two charts that were used in the first conference and the second one, I find an absence of those things that were in the first one in the second one. I am greatly concerned whether that is the way that you arrived at your conclusion. Could it have been that way?

Mr. KILMINSTER. No; not as far as I am personally concerned. What I thought we were asked to do by NASA was to look at that technical data that we had presented earlier because they did not arrive at the same conclusion that we did looking at the same data. I think that they were asking us is there's something else that is involved that maybe you didn't present to us. We don't arrive at that same conclusion.

Mr. VOLKMER. How come in the second chart you do not include the information that you had in the first charts?

Mr. KILMINSTER. If you are talking about the first charts being in the first telephone conversation, they already had that information.

Mr. VOLKMER. Did you include that information in your thought processes and discussions when you came to the conclusion finally that it was safe to fly?

Mr. KILMINSTER. Yes, sir. One of those charts, for instance, described this 30-degree test that I had mentioned. That was on the earlier chart.

Mr. ROE. We will continue that further. I would like to hear from Mr. Boisjoly. What is your observation—obviously there is a different relationship between the two observations. Give us your observation. What caused the change in the attitude?

Mr. BOISJOLY. My observation is that when we as engineers presented our data and were unable to quantify it, it left it somewhat open from the standpoint of we only had data down to 50 degrees. I had thought we made it quite clear that the 30-degree test was a static test and did not simulate the gap opening. I also thought we made it clear that the problem was one of resiliency and that was a function of temperature.

When the Marshall folks on the other end of the line challenged a lot of things that were said specifically by me, asked me to quantify it and I told them I couldn't quantify it but I had enough data to show that we were going away from the direction of goodness, and that is the terms I used, and they challenged that at some length and wanted quantification over and over again of the terms I was using. I just couldn't. We didn't have the data necessary to do that other than the data that had already been presented.

Mr. ROE. Isn't it true that you didn't have the data because the tests were never made below those temperatures?

Mr. KILMINSTER. Yes.

Mr. ROE. Is it true on the record from a technical point of view you could give them no other answer, there wasn't any other answer because the question should have been we have never tested the equipment as a unit, as a vehicle below those temperatures?

Mr. KILMINSTER. That is correct.

Mr. ROE. Was that said, by the way, was that specifically said?

Mr. KILMINSTER. We specifically talked to the 50-degree data, the 75-degree data, and the 100-degree data in the resiliency tests.

Mr. ROE. Because under the plans and specifications there never was a test made below that.

Mr. KILMINSTER. The plans and the specifications and the temperatures relative to the specifications were not discussed that night. We were discussing subscale test data.

Mr. ROE. But you couldn't respond any other way because tests were not made?

Mr. KILMINSTER. That is correct.

Mr. ROE. Mr. Boehlert.

Mr. BOEHLERT. I have difficulty in fully understanding all the aspects of this matter and even greater difficulty understanding the decisions of the technocrats, given all the information discussed in the prelaunch conference. The commission says on page 104 of the report:

The commission concluded that the Thiokol management reversed its position and recommended the launch of 51-L at the urging of Marshall and contrary to the view of its engineers in order to accommodate a major customer.

Mr. McDonald, you were at the Cape and I get the impression that you felt the pressure building up down there. Would you expand upon that a little bit?

Mr. McDONALD. Yes; I definitely felt the pressure and it was because this role had been reversed. I had stood up probably in front of more readiness reviews in the past 2 years than anyone, and always had to justify why my hardware was ready to fly. I personally sign all the defects in the hardware, criticality defects outside of our experience; I have to explain why it is OK to fly with those, what data and tests do I have.

My feeling was these were more minor than what we were facing that night. So when I heard comments like they are appalled at the recommendation, and comments that when are we going to fly this thing—in April?

Mr. BOEHLERT. Who made those comments?

Mr. McDONALD. Mr. Hardy from Marshall made the comment he was appalled at the recommendation, and Mr. Mulloy about not being able to fly until April.

Mr. BOEHLERT. So you had the distinct impression that pressure was being applied from NASA to Thiokol?

Mr. McDONALD. Yes; I did.

Mr. BOEHLERT. Mr. Kilminster, you must have felt that same pressure because you requested to go off line in the teleconference. What prompted that request?

Mr. KILMINSTER. The thing that prompted my request is that any pressure that I felt was one of going back and reassessing the technical data.

Mr. BOEHLERT. You asked for a 5-minute break. Was that "May we have 5 minutes" casually or did you think it could be quickly wrapped up?

Mr. KILMINSTER. That was my assessment of what it would take to review the data.

Mr. BOEHLERT. It took 30 minutes, is that correct? Who was the senior engineer in that conference that you had at Thiokol?

Mr. KILMINSTER. The vice president of engineering, Mr. Lund.

Mr. BOEHLERT. Did Mr. Lund have serious reservations and recommend against launch?

Mr. KILMINSTER. Not during the caucus.

Mr. BOEHLERT. What prompted Mr. Mason—I am asking you to give us your best guesstimate. Mr. Mason allegedly said to Mr. Lund, "Take off your engineering hat and put on your management hat." My interpretation of that is that Mr. Lund was arguing based upon facts, engineering data that you should not proceed. What do you think motivated Mr. Mason's comment to Mr. Lund?

Mr. KILMINSTER. I think that as the discussion ensued during that caucus that there were different aspects reviewed relative to the data that we had presented earlier and the new data that we had considered during the caucus. And there was a perception that there was not unanimity of opinion amongst the engineering people.

Mr. BOEHLERT. Did you feel any pressure as that caucus was underway from NASA, your internally talking to the boys trying to make a prudent decision, did you feel under great pressure; did you feel in your mind that NASA wanted you to proceed with launch come hell or high water?

Mr. KILMINSTER. No. My perception was that they wanted us to look at the technical data and come to a technical recommendation.

Mr. BOEHLERT. Then you had a different perception from that of Mr. McDonald because I think he had the distinct impression from his vantage point that NASA wanted to go, no questions asked.

Mr. McDONALD. Yes.

Mr. KILMINSTER. Yes, my opinion is different from Mr. McDonald in that regard.

Mr. BOEHLERT. You said there were 12 people in the caucus?

Mr. KILMINSTER. Twelve or thirteen, yes.

Mr. BOEHLERT. Did you go around and count heads or hands, have vote, go or no go?

Mr. KILMINSTER. No. We had an open discussion and during the course of that discussion Mr. Boisjoly and Mr. Thompson again reiterated their concerns. We talked about the second seal or the secondary O-ring being in the proper position to seal even if the primary O-ring was slow in getting across and sealing. We did the calculation based on the previous coldest launch.

Mr. BOEHLERT. I know all that because you have testified to that before. But before you went back on line, what did you do as a practical matter? You have got 12 people sitting around, all technical people, knowledgeable. Did you take a head count? Did you vote

or did you just draw a conclusion yourself and then go back on line?

Mr. KILMINSTER. No. Mr. Mason requested that we have a decision made, and he polled Mr. Wiggins, Mr. Lund and myself based on the information we had discussed during the caucus and asked if we would recommend a launch. And we all recommended that we would launch.

Mr. BOEHLERT. And then you went back on line?

Mr. KILMINSTER. Then I made notes in order to cover the points that we had discussed and then we went back on line.

Mr. BOEHLERT. So Mr. Lund then was on two sides of the issue during that conversation; initially he was no, finally he was yes?

Mr. KILMINSTER. Initially being before the caucus, yes.

Mr. BOEHLERT. Well, during the caucus.

Mr. KILMINSTER. No, I think that during the caucus he was listening to——

Mr. BOEHLERT. Just prior to Mr. Mason saying to him, "Take off your engineering hat and put on your management hat," what would you say Mr. Lund's frame of mind was then, go or no go?

Mr. KILMINSTER. I don't know.

Mr. BOEHLERT. Why do you think Mr. Mason said that?

Mr. KILMINSTER. Because there was a perceived difference of opinion among the engineering people in the room, and when you have differences of opinion and you are asking for a single engineering opinion, then someone has to collect that information from both sides and make a judgment.

Mr. BOEHLERT. If there was a perceived difference of opinion among the engineers in the room, some said yes, some said no, I assume Mr. Lund was among people in the room—there was a perceived difference of opinion among people in the room. So there was obviously a change of heart there. Who had the change of heart within the conversation?

Mr. KILMINSTER. I guess all of us, based on the additional information we looked at.

Mr. BOEHLERT. All of you were against and eventually said yes?

Mr. KILMINSTER. I stated prior to the caucus that based on the engineering information, that I could not recommend a launch decision.

Mr. BOEHLERT. Did anyone within the caucus argue for initially the launch?

Mr. KILMINSTER. Excuse me?

Mr. BOEHLERT. Was there anyone in the caucus arguing initially for the launch as soon as you went off line? In any group dynamic situation like that, there are opposing forces and someone takes the lead.

Mr. KILMINSTER. I don't know that anyone was pushing the launch. We were relooking at the data.

Mr. BOEHLERT. So you are telling me after a thorough, objective, very technical analysis, you all came to the same conclusion?

Mr. KILMINSTER. The managers came to that conclusion.

Mr. BOEHLERT. All 12 of the people there?

Mr. KILMINSTER. No, the managers.

Mr. BOEHLERT. The four, and did you disagree with what the Rogers Commission report says on page 104, and let me repeat that.

This is an exact quote: "The Commission concluded that the Thiokol management reversed its position and recommended a launch of 51-L at the urging of Marshall and contrary to the views of its engineers in order to accommodate a major customer."

Mr. KILMINSTER. I don't agree with that finding.

Mr. WALKER. Will the gentleman yield?

I want to go back to Mr. McDonald for a minute, because I think it ties in.

Mr. McDonald, you were feeling pressure at the Cape. You have testified that a statement of Mr. Mulloy and a Mr. Hardy—both of them made statements to that. Were they making statements based upon orders that they got from above?

Mr. McDONALD. I don't know what they made their statements on.

Mr. WALKER. Who was responsible for the change of attitude you were feeling at the Cape?

Mr. McDONALD. Well, I don't know who was responsible for the change of attitude. It came from two different sources. Hardy was at Marshall and Mr. Mulloy was at the Cape, and they both made statements that surprised me about their reluctance to accept our recommendation.

Mr. WALKER. So the pressure was from those two people?

Mr. McDONALD. That is right.

Mr. WALKER. Was there anybody else you felt pressure about the change?

Mr. McDONALD. Mr. Reinartz made a comment that our 53-degree recommendation wasn't consistent with what he thought the motors were qualified to, 40 to 90, which was a third person, and he was from Marshall and the Cape also.

Mr. WALKER. Those three people were applying pressure to you?

Mr. McDONALD. As far as I was concerned, yes.

Mr. WALKER. Were any of them involved in applying pressure on the people in Utah?

Mr. McDONALD. They heard the same comments because we were on a network where the comments came over the network.

Mr. WALKER. So those are the three people that you would identify that have changed the evidentiary proof from positive to negative?

Mr. McDONALD. Yes. In my opinion, yes.

Mr. BOEHLERT. One last question to follow up.

Mr. McDonald, you were there and you can tell us—a lot is lost when a transcript is printed in black and white, but allegedly Mr. Mulloy said, and I will read the words exactly without any particular inflection: "My God, Thiokol, when do you want me to launch—next April?"

Would you estimate that was said in heat—my God, Thiokol, when do you want me to launch—next April? Or was it, Come on, guys, when do you want me to launch—next April?

Mr. McDONALD. It was the louder of those two.

Mr. ROE. The time of the gentleman has expired.

We are going to call on Mr. Lewis from Florida, and then we are going to quit for lunch after Mr. Lewis finishes his interrogatories.

It is apparent, and many members have mentioned this to me today, that there is a great deal of additional questioning that they want to propound to the distinguished group of witnesses we have, so we would request that you would return tomorrow morning at 9:30 to conclude your testimony tomorrow, because there is just no way we can get it all done today, and we are going to talk to the Marshall Space Flight Center people this afternoon.

The Chair recognizes the distinguished gentleman from Florida, Mr. Lewis, who will be our concluding member at the moment.

We will reconvene at 1:30 with the Marshall Space people witnesses.

The gentleman from Florida.

Mr. LEWIS. Thank you, Mr. Chairman.

I think, gentlemen, that we have heard a lot of discussion this morning and I believe we all recognize we have had a problem since 1977 with the seals in the joints. We had a design review apparently in August 1985 to redesign the joint and nothing was really done. People were looking at it.

I guess, Mr. McDonald, I would like to ask you, who in NASA did you basically feel that you reported to, if anybody?

Mr. McDONALD. Well, I felt that my normal contact was Mr. Larry Wear, and he is the manager of the solid rocket motor project at the Marshall Space Flight Center. He works for Mr. Mulloy.

Mr. LEWIS. What are your responsibility and purpose at the Cape? What were they?

Mr. McDONALD. My responsibilities at the Cape is that all of the contractors, including ourselves, have a representative from senior management; I was the director of the solid rocket motor project, to be at the Cape to give approval for the launch in case something came up that needed resolution, either that individual could get the resolution or have it done some way, and that is why I was there.

Mr. LEWIS. Did you personally feel that the problem that had been observed with the field joints was a possible detriment and would have the possibility of losing a vehicle?

Mr. McDONALD. Well, I felt that if we continued to try to expand the boundaries on where we had been flying, that we were running risks in that direction that we didn't have to take.

Mr. LEWIS. And the boundaries were expanded that morning apparently when we had the temperature problem, is that correct?

Mr. McDONALD. That was my concern and those of the engineers, yes.

Mr. LEWIS. And you told Mr. Mulloy, I understand, that—did you tell Mr. Mulloy after the caucus conversation with Mr. Kilminster that you did not want to fly?

Mr. McDONALD. Yes; I told Mr. Mulloy, you know, that I not only was surprised he accepted the recommendation because of this O-ring problem and that if I were the launch director, I would cancel the launch for three reasons, not just this one, and they wouldn't accept the one, which was bad enough.

Mr. LEWIS. What were the three reasons?

Mr. McDONALD. The first was the O-ring problem.

The second reason being that I had just returned from Mr. Kennedy's house, and he had been in contact with the ships at sea, and they reported that they were in an absolute survival mode out there; they were steering in shore at about 3 knots in about 30-foot waves, and that they wouldn't be in a position to support an early-morning launch, and as a result, we were putting, in my opinion, the boosters at risk and it was rather important on this launch because this was the first time I told them that we are going to separate the nozzle at the apogee, which we had not done before, and it was the first time we were going to separate the parachutes on impact of the frustums. In my opinion, you could kiss those good-bye, the parachutes, and I thought we were putting the boosters at some risk.

The third reason was I told them that I am concerned about ice all over that launch pad in the morning, which I suspect there will be because I knew we used a water system for sound suppression and I was afraid it would change the acoustics and debris and all other kinds of problems, that it didn't seem prudent that we would want to launch in that condition.

It was at that time that they told me these problems weren't mine. I shouldn't worry about those, but that they would pass those on, my concerns, not as recommendations but as concerns, and I was under the impression that they passed all three of them on because I think it was Congressman Lujan who asked why didn't I talk to Jesse Moore or Arnie Aldrich or something. They called Arnie Aldrich, and we were waiting for this dispatch from Mr. Kilminster after they said they wanted that signed and faxed in with the rationale when I was talking about the subject waiting for the fax.

Mr. Mulloy asked me where it was, nearly a half hour had passed, and the fax machine was at the other end of the building. So, I went to get the fax and it wasn't there and I wasn't sure it was working. In 10 to 15 minutes, it came through.

I came back and they were on a telephone call with Mr. Aldrich. I caught the end of that because I had come back with the fax and made copies for everyone and went in and they were talking about the problem at sea and the risks associated with not recovering some of the hardware. And I was under the impression they had already discussed the first issue, which was the O-ring seal issue, and were discussing the second.

They also discussed a bit of the third about my concern on the ice, and the conclusion was, they had gone over that earlier in the day and they had concluded that even though there was a high probability of losing the parachutes and the frustums on the flight, they would have to accept that as a good possibility. They didn't feel they were putting recovery of the boosters at much risk because they would have aircraft in the area and could get them later, and they would certainly float.

I remember Mr. Aldrich asking Mr. Mulloy if he could afford from inventory to lose that kind of hardware and still support the flight schedule, and he said that he could, and so they accepted that risk of losing that hardware, and they briefly discussed the issues.

I didn't hear them talk specifically about the O-ring seal issue we discussed for 2 hours, and I presumed they had done that already.

Mr. LEWIS. Let me go a little further. How many launches were you at the Cape for, how many shuttle launches?

Mr. McDONALD. Well, I have been alternating with Mr. Kilminster in the past couple of years since I have been on the program. He goes to one and I follow to the next one.

Mr. LEWIS. Did you have a real gut feeling that this flight should not launch?

Mr. McDONALD. Well, I was more concerned of what we didn't know than what we knew.

Mr. LEWIS. You didn't answer my question. Did you have a gut feeling that this flight shouldn't go off with all the data available to you?

Mr. McDONALD. Well, I had a gut feeling that it wasn't prudent to launch this and we could wait a day or two and get rid of any concerns.

Mr. LEWIS. You stated to the Rogers Commission, "I am the one that has to answer, yes, Thiokol is ready to fly. I am the guy who is going to have to get up and say, yes, we are ready to fly."

If you felt strongly that you shouldn't have launched and you had this responsibility, why didn't you go to make a statement that if you launch, I cannot accept responsibility, or make statements like this? If you knew Mulloy wasn't going to do anything about it essentially, why didn't you go to Moore?

Mr. McDONALD. I thought they had addressed that with Arnie Aldrich on the teleconference. I was sure they had. I was amazed that that never went further, because I knew that if I was going to have influence on whether to launch or not after management had come back and recommended to proceed on that, I was talking to the right gentleman to influence that. One was a member of the Mission Control team, Mr. Reinartz, so I had no reason to believe they hadn't discussed that thoroughly with Mr. Aldrich and Mr. Moore, and was shocked to find they hadn't.

Mr. ROE. Will the gentleman yield?

I think the gentleman is developing a very important, I think, final point of view, which is, at what level was the decision made, and it appears from our earlier testimony from the chairman of the board, Mr. Locke, that it never reached—that decision never reached that top level of determination, and nor, from what Mr. McDonald and Boisjoly are saying, nor did that decision reach the top level of NASA's leadership. So, the decision was made some place in between.

I thank the gentleman for yielding.

Mr. LEWIS. Thank you, Mr. Chairman.

Mr. Chairman, we are going to have a constraint on time, but I would like to go further with Mr. McDonald.

Was Thiokol polled by the launch director at the T-minus-1 mark in preparation for turning the control over for the ground launch sequence?

Mr. McDONALD. I was not aware that they were.

Mr. LEWIS. Were you at that time? Still in the control room?

Mr. McDONALD. Yes; I was in the firing room No. 2.

Mr. LEWIS. Was Mulloy there with you at that time?

Mr. McDONALD. No; I don't believe he was. I didn't see him.

Mr. LEWIS. Mr. Chairman, I would like to resume my questioning tomorrow morning.

Mr. ROE. Before we break up, I want to get one point clear for the record from Mr. Kilminster or Mr. Garrison. Has there ever been an occasion in your association with the NASA agency where you have been required to provide a certified statement in defense of a launch such as this particular experience you have had in the accident?

Mr. KILMINSTER. No, sir; not other than the normal flight readiness review sequence.

Mr. ROE. Did you feel that might be suspect? Why would somebody say we have had all these launches, but when this decision is being made, somebody says, go offline and do your thing, but when you go back, let us know and we want that in writing from you, which you said that was very unique; is that correct?

Mr. KILMINSTER. The whole sequence was unique.

Mr. ROE. Didn't you feel that that was a little surprising? Didn't you feel a little bit funny—why did NASA do that? What is your conjecture?

Mr. KILMINSTER. I wasn't overly surprised when they requested that in writing.

Mr. ROE. Why weren't you surprised? It had never happened.

If somebody said to me, hey, you know we have been working this way for the last 10 years, but this one we want in writing, I would question that. That would have a different connotation to me, but it didn't to you?

Mr. KILMINSTER. It did not.

Mr. ROE. You expected them to ask in writing.

Mr. KILMINSTER. I was not surprised, and again, because of the flight readiness review process, we do have a piece of paper there that is signed that says it is OK to fly, and if some new issue came up, it didn't surprise me.

Mr. ROE. Thank you for your testimony this morning.

The committee will stand in recess until 1:30, when we will reconvene and take testimony from the Marshall Space people and NASA.

[Whereupon, at 12:40 p.m., the committee recessed, to reconvene at 1:30 p.m., this same day.]

AFTERNOON SESSION

Mr. ROE. The committee will come to order.

I want to apologize to our distinguished witnesses today. We had four votes in a row. We resume our deliberations from this morning when we heard from Morton Thiokol.

This afternoon's witnesses are from the Marshall Space Flight Center. Dr. William Lucas, Director of the Center, is accompanied by Dr. Wayne Littles, Deputy Director of Science and Engineering; Lawrence Mulloy, Assistant to the Director for Science and Engineering; they are all accompanied by Stan Reinartz and Mr. Gerald W. Smith.

The NASA centers and the aerospace contractors must operate in continuous coordination and communication in order for each to

perform its assigned responsibilities. Today we are exploring how this occurs, or fails to occur.

We also have with us Dr. William Graham, NASA Deputy Administrator; and Thomas Moser, Deputy Administrator of NASA's Office of Space Flight.

Welcome back to our hearing this afternoon. Before we continue to proceed, I would like to hear from our distinguished minority leader, Mr. Lujan.

Mr. LUJAN. Thank you very much, Mr. Chairman.

I too am pleased to welcome our witnesses from the Marshall Space Flight Center. I welcome this opportunity to hear from them to better understand the nature of their attitudes and actions on a wide range of issues we have been investigating the past week.

I am particularly concerned by what appears to be a complete reversal of NASA's attitude toward launch safety. In testimony from Morton Thiokol this morning, we heard that during the debate on whether the launch should proceed, the burden of proof to launch shifted dramatically from NASA to the contractor. Furthermore, where it had been standard operating procedure to prove that it was safe to launch, for 51-L this apparently was not the case.

Our witnesses this morning testified that officials from the Marshall Space Flight Center told Thiokol to prove that it was not safe to launch. Clearly, this is an issue we must resolve today. I want to know if and why NASA told Thiokol that if they wanted to stop a launch, they would have to prove that it was unsafe to launch. I also want to know how this shift in attitude came about.

I am also deeply concerned by the obvious confusion with regard to the design specifications, the effects of temperature on the solid rocket motors, and how the motors were qualified. We also need to know precisely how the lines of communications between the Marshall Space Flight Center, the Johnson Space Flight Center, and NASA headquarters operated with regard to the joint in general and the launch of 51-L specifically.

I hope that by the close of business today, we will know exactly how serious Marshall officials thought the joint problem was, what they did about it, and with whom they discussed these problems outside of Marshall. We will be making real progress when we get the answers to these questions.

Mr. ROE. I thank the distinguished gentleman from New Mexico.

Before we proceed, we are going to swear in all the witnesses. If all the people who are testifying today would stand and raise their right hand.

[Witnesses sworn.]

Mr. ROE. This morning's hearing was very intensive. We are trying to bring together that decisionmaking process that took place on the go or no-go on January 27. We are trying to draw that together and get a response hopefully this afternoon from the representatives of the NASA organization from the Marshall Space Center. First I want to call on Dr. William R. Graham, our Deputy Administrator for his opening remarks.

STATEMENTS OF DR. WILLIAM R. GRAHAM, DEPUTY ADMINISTRATOR, NASA, ACCOMPANIED BY THOMAS MOSER, DEPUTY ADMINISTRATOR, OFFICE OF SPACE FLIGHT AND ADM. RICHARD TRULY, ASSOCIATE ADMINISTRATOR FOR SPACE FLIGHT

Dr. GRAHAM. Thank you, Mr. Chairman.

Mr. Chairman and distinguished members of the committee, Dr. Fletcher, the NASA Administrator, had hoped to be here, but after we had testified here last week, he had committed to appear at this time before the Senate Subcommittee on Science, Technology and Space. Therefore, I am here today as Deputy Administrator of NASA to address your questions.

As Dr. Fletcher, Admiral Truly, and I explained to this committee last week, NASA is moving forward to implement the recommendations of the Rogers Commission. Since then the President has told us that "the procedural and organizational changes suggested * * * will be essential to resuming effective and efficient Space Transportation System operations, and will be crucial in restoring U.S. space launch activities to full operational status." Of course, NASA fully supports that direction.

Admiral Truly, in assuring you that the Commission recommendations would be his road map, gave you an interim report of progress last week. This morning in the session that Dr. Fletcher attended NASA responded to the recommendation of the Commission to establish an Associate Administrator for Safety, Reliability and Quality Assurance, reporting directly to the Administrator and independent of other NASA functional and program responsibilities by committing to establish this position and office, which will be established with direct authority over safety, reliability, and quality assurance, agencywide.

We have learned that the NASA management organization, in this regard, was flawed. I believe that this was an outgrowth of attitudes and procedures that had formed over many years. We are changing that system in order to do what the President has said must be done: "* * * make our space program safe, reliable, and a source of pride to our Nation and of benefit to all mankind," and to "retain our leadership in the pursuit of technological and scientific progress."

We are changing that system because, while great accomplishments have been made in our space efforts, serious mistakes have also been made.

In all programs involving people, errors will be made, errors in fact, errors in judgment, and errors in approach. One of the great contributions that NASA has made in the past is to blaze the trail in establishing how to manage large, complex programs in such a way that errors do not persist and grow into disasters, but rather are controlled and removed before they can cause serious harm.

Often we have heard people say "If we can put men on the Moon, surely we can do that." almost whatever "that" was. And the statement is true. But putting men on the Moon, or putting the space shuttle into orbit—or moving a 100-ton vehicle at 10 times the speed of a rifle bullet—is an extremely unforgiving business, and demands the most rigorous and constant observation of engi-

neering and management discipline to agree substantially beyond every day experience and practice in most other fields of endeavor.

NASA must learn again things that it learned before, and it must learn new things as well—in management communications, organization, and engineering.

Mr. Chairman, with your committee's help and oversight, and the dedicated effort that NASA and the U.S. scientific and aerospace community are making, NASA in the future will be a strong and capable national enterprise.

At my left today is Mr. Moser, NASA's Deputy Associate Administrator for Space Flight and to my right is Dr. William Lucas, the Director of the Marshall Space Flight Center.

Dr. Lucas will give a short statement and then we would be pleased and prepared to answer your questions.

Mr. ROE. The Chair recognizes Dr. Lucas.

STATEMENTS OF DR. WILLIAM LUCAS, DIRECTOR, MARSHALL SPACE FLIGHT CENTER, ACCOMPANIED BY J. WAYNE LITTLES, DEPUTY DIRECTOR OF SCIENCE AND ENGINEERING; LAWRENCE MULLOY, ASSISTANT TO THE DIRECTOR FOR SCIENCE AND ENGINEERING; GERALD W. SMITH, MANAGER, SOLID ROCKET BOOSTER PROJECT; STAN REINARTZ, MANAGER, SPECIAL PROJECTS OFFICE, AND BILL SNEED, ASSISTANT DIRECTOR, POLICY AND REVIEW

Dr. LUCAS. Thank you, Mr. Chairman.

Mr. Chairman and distinguished members of the committee, I am pleased to represent the dedicated men and women of the Marshall Space Flight Center in responding to the report of the Rogers Commission.

The distinguished chairman and the dedicated members of the Commission were diligent and painstaking in their execution of a very difficult assignment. We agree with the findings as to the cause of the accident. We have cooperated with the Commission from the outset and, so far as I know, have responded to its every request as rapidly as possible. Our people have worked very hard to devise tests and supply data to substantiate conclusions being reached on the basis of analysis and deduction.

From the moment of the accident, we have been deeply engaged not only in finding the cause of the failure, but also in preparing to fix the causes of the failure. With the appointment of the Commission, we directed all of our factfinding to the support of the Commission through the NASA 51-L Data and Design Analysis Task Force. Our people, living with shock and grief, have been able to apply themselves diligently to the identification and correction of the problems.

As soon as the solid rocket motor joint became the most likely suspect as to the cause of failure, we organized a team of design and analysis experts from the Marshall Space Flight Center, from other NASA centers, and from several industrial contractors, including Morton Thiokol Inc. to redesign the joint. In addition, we engaged a panel of senior independent experts from industry and Government to overview the design team activity.

That panel has already held one 2-day meeting, has supplied recommendations in writing subsequent to the meeting, and individual members of that panel have made important suggestions that are being considered. It has been encouraging to have received unsolicited offers of assistance from several industrial organizations, many of them nonaerospace, and from private individuals. We are giving careful consideration to each suggestion.

In addition to this activity, we welcome the fact that the National Research Council has identified a panel of distinguished individuals to overview the entire effort and report to the Administrator. I'm confident that all of this activity will result in a safe solid rocket motor joint design that can be verified by test.

The Marshall Space Flight Center has undertaken a reevaluation of the design requirements, failure modes and effects analyses [FMEA], critical items lists [CIL], and the launch operations requirements for each of its space transportation system elements—solid rocket booster, space shuttle main engine, and external tank.

The review of the design requirements includes participation with the Johnson Space Center to verify the level 2 system requirements which are the basis of the requirements for the level 3 transportation system elements. Each of the subsystems and components within the level 3 elements will be reviewed again to determine that they are designed to the requirements and have been verified functionally.

The Government and prime contractors will accomplish this review and present the results to a Design Certification Review Board for final approval. The element operational requirements for each of the Marshall systems are being reviewed to assure that required verification during the launch preparation is included in the appropriate document.

A reevaluation of the failure modes and effect analyses and critical items lists has been initiated for each subsystem of each shuttle element assigned to the Marshall Space Flight Center. The evaluation approach requires each prime contractor—Rocketdyne, Martin Marietta, Michoud Aerospace, USBI, and Thiokol—to accomplish an evaluation of its element and publish an updated FMEA/CIL document.

Additionally, independent contractors have been employed to conduct a separate and independent review. The independent reviews and the prime contractor results will be assessed by a Government team and the findings and recommendations will be presented to a senior board. All criticality items will be reviewed by the Board and its recommendations will be forwarded through level 2 for review and approval by level 1.

We are reviewing our management delegations and systems to assure that they are totally commensurate with the spirit and practice of open communication throughout NASA. Where changes are indicated, they will be made without hesitation.

Mr. Chairman, this has been the most painful experience in the history of the Marshall Space Flight Center. We will not forget the dreadful 51-L disaster, and I'm confident that the men and women of the Marshall Space Flight Center, along with their associated contractors, will apply to the resolution of the current problems, all

the vigor and ingenuity that have resulted in the great number of successes in the last 26 years.

We are prepared to exert any effort and make any sacrifice necessary to restore our country's space program to a position that our citizens expect.

Thank you, Mr. Chairman.

Mr. ROE. Thank you, doctor, for your testimony.

I want to first of all compliment NASA for having taken an important step in already establishing an Associate Administrator for Safety. I think that is one of the strong recommendations that we felt and I think you are to be complimented for moving so fast and starting the implementation of the recommendations of the committee and the Commission.

We want to bring together the thought process that was utilized and once and for all, set that to rest because it bears upon many, many other areas of concern in the committee, the decisionmaking process that took place on January 27. This morning we had the Thiokol people in as you know and we spent about 4 hours going through their observations, exactly what happened. We mentioned the point of view that it is not our concern to nail somebody, that is not our goal. Our goal is to do a number of things, first to ascertain what the actual facts were at that point, that is essential to put that to rest, what happened in the decisionmaking process and just about where we are going to go from here.

Those are all the directions we are talking about. Now having said that in the course of events that took place on the 27th, we now would like to hear from Mr. Lawrence Mulloy. Is he here? If you would come forward, I think you were sworn in. We would like to hear from you as we asked two witnesses this morning what your recollections and what your intent was and we have a copy of the film that was made at the time that the decisionmaking was going on, which will show—would you like to see that first? It might help you.

Let's show that film for the members of the——

Dr. GRAHAM. Mr. Chairman, may I introduce Admiral Richard Truly, the Associate Administrator for Space Flight who has just come from another hearing.

Mr. ROE. Welcome.

I believe this is a video conference, an earlier flight readiness review, is that correct?

Mr. MULLOY. That is correct. This is an excerpt from the 51-L flight readiness review, I think.

[Film shown.]

Mr. ROE. Now what we would like—the debate which has arisen which we are attempting to put to rest, during this morning's testimony Mr. Allan McDonald and Mr. Boisjoly both had expressed their point of view that they were deeply concerned about going ahead with the launch simply because of a number of reasons, but particularly because of the temperature, testing hadn't been done at those lower temperatures and so forth, and so had projected their concern to Thiokol.

I am sure—if I get this out of step somebody correct me.

The second point was that the Thiokol people then had a caucus telephonic meeting and discussed the matters of issue involved, and

had expressed the point of view that they were concerned about launching at a lower temperature and other factors that were involved.

Now purportedly the Marshall Space people came back and challenged that issue and in effect, reversed the point of view from a positive to a negative point of view and in effect tell us why we can't fly. We don't think your interpretation of the engineering technical facts that are before us are correct and therefore you members from the Marshall Space Center, including yourself et al purportedly came back and said here is another set of circumstances. We want you to rereview this and then the caucus was held and the decision was made after a half-hour review by the Thiokol people that were at that conference, 11 or 12 people.

There are two points, an observation that was in the Commission report that we are concerned with the point of view that the decision that Thiokol made was based upon the point of view that NASA was one of their best customers. That is one of the observations and it is on page 104, I am sure you have heard it.

The Commission concluded that the Thiokol management reversed its position and recommended the launch of 51-L at the urging of Marshall and contrary to the views of its engineers in order to accommodate a major customer. That is an issue that has to be dealt with and we dealt with that this morning.

What we would like to hear from you at the moment, Mr. Mulloy, is what your observations are on that issue. That is the two areas that we asked Mr. McDonald and Mr. Boisjoly and you are credited with certain decisions. What is your remembrance of that? In other words, was Thiokol under pressure by you representing NASA to make a decision that it shouldn't have been making?

Mr. MULLOY. I would like to relate the tape that you saw to the timeframe and to January 27. I think it is best to look at the chronology of the history of this problem which is well documented in the Commission report but, I think it focuses where I was coming from on January 27.

As stated there had been O-ring erosion on the second flight of the shuttle system, STS-2 were some fifty-two one-thousandths of erosion was seen. I took over the SRB program at STS-5. At the time we flew from STS-5 to STS-10 with no observation of erosion. We first saw erosion in a case joint when I was manager of the SRB program at STS-10 and that was covered in some detail in the STS-11 FRR. It was explained to me, since that was my first experience with that erosion that that was somewhat less than what we had seen on STS-2.

The contractor developed the technical data where the first tests were run to determine what was the mechanism for the erosion and how bad could it be. That was presented to me as a rationale to continue flying, once we had seen it on STS-2, what we saw on the last flight wasn't as bad, therefore it was an acceptable risk.

As the project manager, I am in the position of getting data from Morton Thiokol and having the data assessed and they present the data to me along with a recommendation. I test the data and make my own judgment whether or not the data supports the recommendation being made, and that was done on the flight review.

Subsequent to that, we continued to see this primary O-ring erosion in the field joints, in the case, and in the case to nozzle joint. Each time we saw that observation after a flight, the contractor, Morton Thiokol, looked at the extent of that erosion, did additional testing as deemed appropriate to further understand the mechanism for that erosion, and came to me with a recommendation to continue flying.

My engineering people supported that recommendation and in each case, that that new observation was made in nine instances that was reviewed by levels of management above me, starting with the basis for that judgment. Both the data and the base for that judgment was reviewed by the shuttle project office at the Marshall Space Flight Center and by a center board convened at the center with senior members of management, engineers at the center, and is chaired by Dr. Lucas and then we take that information to level 2 and into level 1.

That was done on STS-11, 41-C, 41-G, 51, 51-F, 51-I, 51-J, 61-A, and 61 Bravo, where an incidence of erosion was seen, and in each case the contractor judged that that erosion was acceptable. They thought the tests and analysis that they were doing showed that it was an acceptable risk. They so recommended to me. I made my own judgment on that, and agreed with that recommendation that it did indeed represent an acceptable risk, and presented that to my management for judgment.

Mr. ROE. Will you hold a minute? I don't want to break your train of thought, but it seems to us that that goes a little afield of what was testified to this morning. I just want to ask you this one question: Did they certify to you—in other words, this was the responsibility of Thiokol to come to you and say we have reviewed everything, we have reviewed this situation in the O-rings, we have reviewed this deterioration or whatever you want to call it, and we recommend it is OK and still continue to fly.

Mr. MULLOY. Yes; sir, and in every flight readiness review you will find a presentation from Morton Thiokol where this suggestion is made.

Mr. ROE. Did you question that?

Mr. MULLOY. Yes, sir, in several specific instances. Now, on the first instance that I saw the erosion, that is where we first went, or a Thiokol person went, and did some limited testing to determine how bad it can be. My question was we had 53 thousandths of STS-2 and I forget exactly what the magnitude was on STS-10 but it was somewhat less than the 53 thousandths. This is where this mechanism was first identified and that was done by Morton Thiokol engineers, Mr. Thompson, Mr. Boisjoly, Mr. Russell, and the people who were in the program at that time. And yes, I did question it.

Mr. ROE. It was questioned but then your technical review didn't indicate that NASA should take any different view than what they took at that point.

Mr. MULLOY. That is correct, and that was based on the assessment that I had done as the project manager by the engineering people at the Marshall Space Flight Center.

Mr. ROE. Did you advise your level 2 and level 1 people?

Mr. MULLOY. Yes, sir; all of those instances I mentioned, were discussed at the level 2 and the level 1 flight readiness reviews, yes, sir. Now I am trying to relate this to get up to January 27. There were a couple of things then that began to happen that were different than what we had been seeing on STS-11. What we were dealing with first was hot gas impingement on the primary O-ring that was causing it to erode, but it never had any indication it did not seal.

Then, on a nozzle joint, we saw evidence that we had had a soot behind the primary O-ring, which was an evidence of blow-by. That was something that was different, so that was treated in quite a bit more detail on the flight readiness review, and back in April of last year, about April 1985, we had something that was of deeper concern to me, and that was on the nozzle joint, where we found that we had completely violated a primary O-ring and had indeed eroded a secondary O-ring, and Mr. McDonald discussed that in some detail this morning, and the history of that, and the rationale as to why Morton Thiokol then came and recommended continued flying even in light of that, and that was in Mr. McDonald's testimony this morning.

I tested that rationale and concluded that was a sound recommendation, and carried that forward that my recommendation was that that was an acceptable risk. And then we came, the tape that we were seeing here, on 51-E was the one, the flight readiness review that occurred right after the next coldest or the coldest launch at that time, which was in January 1985.

In that instance, if you look at the record, you will find that Morton Thiokol's recommendation, after having seen that and the recommendation, was based on the following or the same type of logic that was eventually developed for the 51-L launch, that we can expect to see blow-by, we can expect to see, we have to live with blow-by, and we can expect to see some erosion. As a matter of fact, the statement in that flight readiness review is that this condition may repeat on the next flight, but that condition is not outside of our experience base and represents an acceptable risk.

Now we judged that, I judged it. I assigned in that case I think six or seven action items to go back and look more specifically and provide more data that supported that position. One of those actions was related to the statement that said cold appears to enhance blow-by, and the analysis that was provided back at that time said that the squeeze on the O-ring was reduced 1 percent, I believe, and that the O-ring got somewhat harder. However, you still had positive squeeze and the hardness of the O-ring was not of concern, so now I am going to get to the night of January 27. That is kind of the history of everything that we had been dealing with.

Mr. ROE. If the gentleman would yield at that point.

Mr. MULLOY. Yes, sir.

Mr. ROE. Before we take the 27th, the record is replete, however, for over a period of years—years, not just months—years on the continuing recurring problem on the O-rings, continuing, so we go back 6 or 7 years on that. I mean Mr.—1977—Mr. Locke had testified to the point of view this morning that they as a result of the January situation in 1985 ultimately they set up an in-house task force, I think it was 40 engineers and people on it going back to the

middle of 1985, intensively to review this. So people were aware, including the agency, of the severity of this problem. Is that a correct commentary?

Mr. MULLOY. That is a correct commentary.

Mr. ROE. Will the gentleman proceed?

Mr. WALKER. Just one point of information. All this information that you had in front of you now getting into January 27, did that include the tests run by Morton Thiokol 100 degrees, 75 degrees, and 50 degrees, where at 50 degrees they literally had shown 100 percent chance of failure?

Mr. MULLOY. Yes, sir; that data was in the 11 or 12 charts that Thiokol had submitted for review.

Mr. WALKER. It was available?

Mr. MULLOY. Yes, sir.

Mr. WALKER. You did know that tests had been run and showed 100 percent chances of failure at anything below 50 degrees?

Mr. MULLOY. The data shows the O-rings will not track the sealing surface at 75 degrees.

Mr. WALKER. I understand. But at 50 degrees, there was no seal whatsoever and it didn't take place for 10 minutes and you only used the engine for 2 minutes?

Mr. MULLOY. That is correct, and at 75 degrees there was a 2.4 second delay, as was testified by Thiokol this morning.

Mr. WALKER. What I am trying to say as we get to the 27th, you did have data before you that showed that at 50 degrees or below there was a 100-percent chance of failure of the O-ring?

Mr. MULLOY. I had data, sir, that indicated that the O-ring would not track the metal surface at 75 degrees for 2.4 seconds, and in 10 minutes it would never recur to track the metal surface. That was the total extent of that test. It was two steel plates with an O-ring between it and then lifting the steel plate at the rate of expansion or gap opening that actually occurs in the gap and looking at the first light between those and measuring the time. That was the test data.

Mr. WALKER. If it doesn't track, it doesn't seal, so therefore it fails?

Mr. MULLOY. That is correct, sir, and those data would indicate it would fail at 75 degrees.

Mr. ROE. The gentleman will proceed.

Mr. NELSON. Mr. Chairman, what is the validity of that data, then, because obviously the O-rings are sealing at 75 degrees on the SRB's. May I interject that question?

Mr. ROE. The gentleman from Florida.

Mr. MULLOY. You are asking that of me, sir?

Mr. NELSON. Yes, sir, that data taken by itself cannot be interpolated or extrapolated to determine whether or not an O-ring will or will not seal in a dynamic situation, as was subsequently shown by additional tests.

Mr. ROE. All right, the gentleman will proceed.

Mr. MULLOY. OK. January——

Mr. ROE. January 27, now you are going to say, you are going to start to unfold what happened.

Mr. MULLOY. Yes, sir.

Mr. ROE. OK.

Mr. MULLOY. Now, there was some confusion. I watched the testimony this morning on CNN, and there still seemed to be some confusion about who started things and asked for and who recommended what, so I would like to go into that and I will get to my thought process, if I may, sir. When we stood down from the launch on the 27th, a request went out knowing that we were going to have cold that night, for all the elements to look at any concern for the cold temperature for the night of the 27th. That went to the items that I was responsible for, which is the SRB, which is the SRM Morton Thiokol and USBI.

Mr. ROE. Was it in writing?

Mr. MULLOY. No, sir, that was an oral request over the communication net. The concerns that came back before we went into the initial mission management team that afternoon came back to me. The only two concerns that came back, there was some concern that we would break a launch commit criteria on the temperature of the recovery battery, which is up in the forward skirt of the solid rocket booster, and possibly the temperature, low temperature limit on the fuel service module in the aft end of the solid rocket booster which contains the hydrazine fuel that powers the auxiliary power unit that provides the power steering for the swivel nozzle for the booster. No mention was made at that time of any concern for the effect of cold on the O-rings.

Mr. Wear, who is my Solid Rocket Motor Element Manager, passed that request in the case of the solid rocket motor to Mr. Boyd Brenton, who is the chief engineer for Thiokol on the solid rocket motor, who was at the Huntsville Operations Support Center, at the Marshall Space Flight Center, supporting the launch, and said, "Do you have any concern for the cold temperature on the SRM's at the temperatures predicted for tonight? It is supposed to go below freezing."

Mr. Boyd Brenton, who is in Huntsville, and this is all in the Presidential Commission record by the way, called a Mr. Robert Ebeling at Thiokol and asked him was there any concern for the cold temperature. Mr. Ebeling contacted Roger Boisjoly and some other people, Mr. Brenton called Mr. Thompson, who contacted Mr. Ebeling, and Mr. Ebeling then I believe the Presidential Commission reports got Mr. Boisjoly and some other engineers together to look at the effect or any concerns that the solid rocket motor might have for the cold temperatures projected that night.

The record shows that Mr. Ebeling then contacted Mr. McDonald at KSC, who I believe stated that he was at Carver Kennedy's house at that time and told Mr. McDonald that they were working the request to look at concerns for the cold temperatures on the SRM, and one thing they had concern about was the effect that it would have on the sealing of the O-rings.

Mr. Ebeling requested Mr. McDonald to provide him with the latest projection on what temperature was going to be that night. I believe the testimony shows that actually Carver Kennedy called KSC and got that information from KSC. Mr. McDonald then relayed that back to Mr. Ebeling.

Then Mr. McDonald called Cecil Houston, who is the Marshall resident manager at KSC, and told him that Thiokol had some concerns relative to the effect of the cold temperature on the O-rings,

that the engineering people wanted to discuss those concerns and asked Mr. Houston to set up a teleconference. That is the early teleconference referred to in the record where the communications were very bad, and the result of that teleconference was to set up a later telecon at 8 o'clock, KSC time, whereby the participants, all of the principals, could get on a four-wire network where the communications would be better.

Thiokol, meanwhile, would prepare some charts that better summarized the concerns that the engineers had, and they would transmit those from Utah to Huntsville, and from Utah to the Kennedy Space Center.

Mr. Reinartz was involved in that early telecon, Mr. Houston called Mr. Reinartz. I was not contacted on that in the first telecon. Inadequate communication, so not much information could be transmitted. Mr. Reinartz then contacted me, and informed me we were going to have a telecon at 8 o'clock. We were going out to the Cape, to our resident manager's office out there where we had a four-wire network, and Mr. McDonald was to join us at that location.

Mr. Reinartz and I went, we were staying at the Merit Island Holiday Inn, over to Dr. Lucas' room, where Mr. Kingsbury, the Director of Science and Engineering, also was. We just told them that Thiokol had some concern relative to the temperature, and the effect of that on the O-rings on the sealing of the joint, and that we were going out to a teleconference to discuss and to better understand that. That was the extent of that communication.

We then went out to the Kennedy Space Center, the charts were a little late coming in. Stan and I arrived there, Cecil Houston was there. Some time after that Mr. McDonald arrived, and somewhere I think the record shows around 8:45 we finally got the charts that had the data on them, not conclusions, no conclusions, but data, and we began a teleconference.

The Commission report shows all the participants in that teleconference. There were a number of them at Marshall. The people that had been assembled at Marshall were under the leadership of Mr. Hardy, who is the Deputy Director of Science and Engineering, and my chief engineer for the Solid Rocket Booster Project was there, and all other personnel who were available that could be rounded up that evening who had knowledge of the history of the O-ring erosion.

Thiokol, meantime, had assembled 11 or 12 people there, which I did not know at the time of the teleconference, but subsequent to that I had found out that included the senior management at Morton Thiokol, and as I say, at KSC there was me and Al McDonald, Stanley Reinartz, and Jack Buchanan, who heads up the Thiokol launch support service organization down there, so the teleconference began, and the 11 or 12 charts that were used are in the record, and the Thiokol engineers presented those charts.

Mr. Boisjoly, I think, presented some of them. I think Mr. Brian Russell actually discussed some of them, and Mr. Thompson actually discussed some of them, and the upshot of that data, the data that were in there, were the one that the gentleman had asked about earlier, was the three specific temperatures in there, and then the total record of O-ring erosion that I mentioned going back

to the STS-10 was also in that briefing, and what the discussion really centered around was what was the meaning of those three tests, points at 100 and at 75 and at 50 degrees, and a lot of the discussion centered around if one expects that the cold temperature per se will cause the joint—will cause blowby, why did we have evidence in the rest of the record where we had blowby at 75 degrees.

As a matter of fact, the two worst instances that we had, the two things that were the most concern to me occurred at warmer temperatures, the first one being the erosion and STS-10 and going back to STS-2 where it was much worse and then the one where we completely eroded a primary O-ring and eroded a secondary O-ring was not related to that temperature.

So we assessed those data, and—in real time. There was an engineering discussion. It went on for about 2 hours, and it is a very typical kind of discussion that occurs between our contractors and Government engineers.

Mr. ROE. This was going on with the company in Utah.

Mr. MULLOY. Yes, and the people in Huntsville.

Mr. ROE. And that is before they went off the record for the half hour.

Mr. MULLOY. Yes, sir, yes, sir, and rationale developed during the course of that conference, and the rationale generally that was developed stated that we had to be tolerant of blowby on the primary O-ring at any temperature, and the test data that showed that at 75 degrees it is 2.4 seconds before the O-ring recovers is, could be an explanation of why we were having blow-by at 75 degrees, but if the concern was as soon as pressure got to the primary O-ring, and the joint began to rotate you had blow-by the primary O-ring, that jet, that pressure, would immediately get to the secondary O-ring, and that pressure on the secondary O-ring test data had shown would seal at 30 to 50 pounds per square inch which is down inside that 170 millisecond timeframe that Mr. Boisjoly testified to this morning, and the conclusion was that, one, the data did not show that the primary O-ring would fail due to low temperature, and the—but that if you got blowby at the moment of ignition the secondary O-ring was in a position to seal, and that was the logic that was discussed that was a prolaunch type of logic.

Then Thiokol went on, having had that discussion, Mr. Kilminster asked for a caucus, and after he had been off the loop for some 30 minutes, he came back with the rationale that was later put in writing and sent down with the signature on it that was a rationale to fly.

Now if I may address your concern, sir, was there a reversal in my mind to say, "prove to me that you cannot fly," I certainly was not conscious of any such reversal. I had no motivation, no driving motivation at all, to launch that vehicle on January 28 versus January 29 or February 5. What the people who were on that teleconference were dealing with is what were the data telling us, and I do believe, because we had had this history of problems, and because we were familiar with all the data that was presented there, our conclusion was that the data was saying, or were saying, that it is an acceptable risk to fly.

Mr. ROE. How do we—in the testimony this morning, when we heard from Mr. Kilminster and certainly Mr. McDonald and Mr. Boisjoly they both, particularly Mr. McDonald and Mr. Boisjoly said they were terribly concerned about the whole idea of flying at all because of those low temperatures and made quite a point of that.

I am sure you looked at that on testimony this morning and then when we talked and the questions were asked to Mr. Kilminster at the time as to what was the general feeling of the engineering group that were involved in that caucus, that in going into that caucus, the general feeling was that the information they had was such that they would recommend not flying.

Do you recall that part of the testimony?

Mr. MULLOY. Yes, sir.

Mr. ROE. But then apparently from the discussions that they had with your folks, yourself and others, they took that back under advisement in that 30-minute caucus, and then came back and in effect made a different decision. Even after the decision was made, Mr. McDonald particularly and I believe Mr. Boisjoly said they were still not satisfied, very much distressed with that, couldn't possibly understand how that decision could have been made under the circumstances.

The next question was asked to Mr. Boisjoly at the tail end of this morning, had to do with the point did we have any substantive information recognizing the history of the operation, and that whole situation over a period of 7 years, there are all kinds of groups being assigned to relook at it and testing every time we are flying and so forth, having a series of events take place, where even NASA itself came back and was concerned about the extra residue and so forth in that joint, and then the question was asked at lower temperatures was there any test actually made at lower temperatures, and Mr. Boisjoly responded and said beyond the temperatures involved, I believe it was 50 degrees, the answer was "No." And then our concern immediately of the committee arose on the point of view that here a decision was made by whomever or with a combination, that was lesser than the degrees that had been tested and therefore we were in an area that we just did not have a substantive fact, is that a fair representation of what was said this morning?

Mr. MULLOY. Yes, sir; I believe it is a fair representation.

Mr. ROE. What would be your response?

Mr. MULLOY. Of what was said this morning.

I would say that Mr. Boisjoly was the leader in expressing the concerns. He was the man who had the engineering data, and during the course of the 2-hour discussion, Mr. McDonald did not enter into that at all.

Mr. ROE. He was not there?

Mr. MULLOY. Yes, sir; he was there, he was at KSC but he was listening as we were—

Mr. ROE. I am sorry, he didn't enter into the—

Mr. MULLOY. Into the discussion during the first part of the telecon. That was all being led from Utah, and the engineers were talking, and Mr. McDonald did as his testimony shows, and testimony in the Commission record shows, toward the end of that tele-

conference he did interject that, oh Mr. Kilminster, that before they went into the caucus that they should consider something Mr. Hardy had said earlier, and that he thought that was very important, and that was the fact that the secondary O-ring was in a position to seal, should you have blow-by the primary O-ring, and he testified, paraphrasing somewhat around that this morning, I believe, so Mr. Boisjoly did have those concerns.

Now, when we came, when they came out of the caucus Mr. Kilminster was reading from notes which as near as I can recall were very close to what was subsequently documented and sent down there, and when he expressed his rationale, Mr. Reinartz asked does anybody have any comments or any other comments to make to this recommendation, and there were none. Nobody at KSC made any comment at that point.

There were no other comments made from Marshall, where there were a large group of engineers assembled, and there were no further comments made from Utah, so my assumption was from that location that there was no dissent to that decision, because Mr. McDonald was there and did not take any issue at that point with the decision, and there was no decision, or there was no dissent conveyed from Marshall or from Utah.

Now after the telecon was terminated, Mr. McDonald did state to my recollection something to the effect that while he would agree there was some doubt, reasonable doubt, as to whether there was a problem with the O-rings or not, there were two other reasons why if he was the launch director he would not fly this vehicle, and one of them was because of the ice that was on the pad that he knew about from having conversations with Carver Kennedy, and the other was that he had understood that the retrieval ships for the solid rocket boosters were in an absolute survival mode and steaming back toward Florida, and that they were just making about three knots and just trying to hold their own, and that he thought under those circumstances if he was the launch director that he certainly would not launch this vehicle.

He did make another comment relative to temperature, that says, as he testified this morning, again related to, "I can understand why you have problems with the recommendation of 53 degrees, but I don't understand how you fly this vehicle outside of its specific limits, which is 40 to 90 degrees;" and I pointed out to him that was not the total specifications on the motor, that that was the temperature specifications for the propellant mean bulk temperature which Mr. McDonald described in testimony as being an asinine comment.

Mr. ROE. We are going to give you more time. I wanted to set out for the committee your observations. I think they are very important here, but I want to ask you just one question and then the whole group another question, and then I will yield to the distinguished gentleman from New Mexico.

It is either true or it is untrue factually. Were any tests of substance conducted at lower temperatures on the parts, the motor and so forth and so on? Mr. Boisjoly said on those lower temperatures they were not. That is extremely important for the committee to know.

Mr. MULLOY. Yes, sir, I have some data here on both the temperature specification as well as what was actually done. I would point out that on DM-4, that is a development motor which is a full-scale motor that is static fired in the horizontal position out in Utah, the O-ring temperature on that motor was 40 degrees, by calculation. On QM-3, the O-ring temperature was 45 degrees.

There was an ambient temperature, let's see, I have some more here, the DM-4 where the O-ring temperature was 40 degrees, the ambient temperature was 36 degrees. For the QM-3 where the O-ring temperature was 45 degrees, the ambient temperature was 40 degrees.

Now on the total specifications, as you gentlemen pointed out I think this morning, the propellant mean temperature specifications on the motor is 40 to 90 degrees. The ground firings of the actual experience on that propellant mean bulk temperature was from 56 to 80 degrees and the flights on propellant mean temperature went from 52 degrees to 80.5 degrees.

On ambient temperature the specifications are 31 to 99 degrees for vertical flight. Ground firings were conducted from 36 to 97 degrees, and flight had been conducted from 55 to 86 degrees up to 51-L.

Mr. ROE. Would you say that Mr. Boisjoly was wrong in his statement to the committee this morning that tests have been made below the temperatures involved?

Mr. MULLOY. The data I have here, sir, says DM-4 was tested at 36 degrees with an O-ring temperature of 40 degrees.

Mrs. MEYERS. Mr. Chairman, did he not specify, somebody had said this morning that they had made it very clear that the testing that had been done around 30 or 35 degrees had been only static tests, and that that really made a significant difference?

Mr. ROE. What we are going to do, I realize, because we have got a vote in a minute but there are other people who are going to have questions, you are coming back and you are leaving the impression with the Chair and with the members of the committee that perhaps Mr. Boisjoly's testimony this morning was not accurate. Now either we did test or we did not. Somebody hasn't got the facts. I may be making that too simplistic, but apparently from their point of view representing that company, they came back and nobody objected to that, of the Thiokol people, that when the decision was made, they had no substantive data available to them because they had never flown at those lower temperatures.

Mr. MULLOY. Mr. Chairman, I cannot remember the total context that that was made in, but I do recall some discussion. I think the question was asked related to the resiliency test at 50 and 75 and 100. I recall a question being asked was there any testing below 50 degrees?

Mr. ROE. We were trying to get across the point of view what the temperature was and what was an acceptable temperature and launch of a system.

Mr. MULLOY. Yes, sir.

Mr. ROE. That is what we are trying to get across. And then the question was asked specifically, had there ever been a launch at those low temperatures or had there been any testing at those low

temperatures as far as a shuttle launch is concerned? That is where we are coming from.

Mr. MULLOY. Yes, sir. There had been no launch at a temperature, let me give you the lowest—

Mr. ROE. What was the lowest temperature. It either was or it wasn't. Was it not the lowest temperature, you never had experience at a lower temperature because you didn't have any lower temperature; is that correct?

Mr. MULLOY. The lowest temperature for a launch prior to 51-L is 53 degrees.

Mr. ROE. What was 51-L?

Mr. MULLOY. 51-L is 29 degrees.

Mr. ROE. Therefore for the record and factually before us none of us, including you, the committee or Thiokol had ever had any experience on launching anything at that low temperature, is that a fair statement?

Mr. ROE. Sir, then the question is do you feel that our testing between the 21 degrees and the 52 degrees of the launching of the 51 launch and the one that was launched the temperature before, did we have enough test data, physical test data, not interpretations of engineering, not what may have happened or we think so far, one-eighth of an inch or two-tenths of a milligram, did we have enough test data to make the magnitude of a decision that was made?

Mr. MULLOY. In my judgment in hindsight, no, sir.

Mr. ROE. That is the point. Now nobody is trying to nail anybody down here. We understand where this is all coming from. What we are trying to do, and some people say, what is this committee pursuing, are we on a witch hunt? We are not. We are going to try and come back and make two ultimate decisions. One is the recommendations to NASA in its overall management program, its communications.

It has obviously got to improve.

The second point we are going to make is that this committee as a Member of the Congress of the United States are going to decide what the policies are going to be, and we want to make, what would you say, educated recommendations to our fellow colleagues as to what happened on the way to the forum, so to speak, and what we are going to do.

Now, we will recess at this point because we have to vote. We will start right away with Mr. Lujan as soon as we return.

[Recess.]

Mr. ROE. The committee will reconvene.

We were going to start the questioning of this afternoon with Manny Lujan from New Mexico. He is not here, so I will defer to the distinguished gentleman from California, Mr. Packard.

Mr. PACKARD. Thank you, Mr. Chairman.

Mr. Mulloy, this morning Mr. McDonald testified that on the evening before launch, that he had conveyed the three major concerns to you.

Could you recount those for the record, what those three major concerns were?

Mr. MULLOY. Well, sir, the three major concerns that were communicated to me on January 27, was, first, the concerns that engi-

neers at Thiokol had expressed about the ability of the O-ring to seal at the predicted launch temperatures.

As I said, Mr. McDonald didn't enter into that discussion during the 2-hour teleconference, and I think I stated that subsequent to that, he said while he would agree that there was some question about the validity of the recommendation of 50 degrees, he didn't understand how we could operate out of what he thought the motor specification was. It was 40 to 90 degrees.

The second concern expressed was for the ice that was on the pad. He understood about those conditions out there.

And the third was the fact that retrieval ships for the solid rocket booster were in an absolute survival mode, and coming back toward the shore at a very low speed and that they would not be in a position to recover the solid rocket boosters.

Mr. PACKARD. And which of those three concerns did you convey to those above you?

Mr. MULLOY. Well, Mr. Roinertz, who is my superior, was in the meeting and he also heard those, so he knew about it, and we placed a telephone call to Mr. Aldridge that night, because there was in the launch criteria—there is a statement relative to recovery area, and that if there is a possibility that the boosters cannot be recovered, that that is an advisory call.

It does not say you cannot launch under those circumstances. I took that to be my responsibility to advise Mr. Aldridge that we would not be in a position possibly, to recover the solid rocket boosters, because they would be some 40 miles from the impact area.

Mr. PACKARD. Was the concern for the O-rings discussed?

Mr. MULLOY. No, sir; it was not.

Mr. PACKARD. Why not?

Mr. MULLOY. Well, sir, I testified to this in the Commission. It is in the record. I will repeat it here.

The O-ring and other special elements of a level 3 system were considered in the management system to be a delegation to the level 3 project manager to make dispositions on those, any problems that arose on those.

Our judgment was that there wasn't any data that was presented that would change the rationale that had been previously established for flying with the evidence of blow-by, and that data would indicate that since that was inconclusive, and the fact we had redundancy at a time when blow-by would occur which is less than 170 milliseconds, that there was no change in that rationale and, therefore, there would not be any requirement to have that rationale approved by level two or level one.

That was the judgment.

Mr. PACKARD. Did you share any of this information with Mr. Moore at any time?

Mr. MULLOY. No, I did not.

Mr. PACKARD. Previous to launch?

Mr. MULLOY. No.

Mr. PACKARD. And why did you require of Mr. Kilminster his written approval?

Mr. MULLOY. Well, sir, we had just had a long 2-hour discussion where the data were discussed from a number of sides.

He had read a rationale as to why he was making a recommendation to launch, and I wanted that rationale in writing to be sure that it was concise and that I could accept that rationale, other than just in an oral transmission.

Mr. PACKARD. And that rationale was different than what he had expressed just the night before.

Mr. MULLOY. No, sir.

This whole telecon took place from 8:45 to 11 o'clock on the same night, the 27th. There had been—we had cold temperatures on the 27th, as a matter of fact, well below the, you know—well, 50 degrees. I don't recall exactly what the temperature was, and there wasn't any concerns expressed at that time.

Mr. PACKARD. In your judgment, why did Morton Thiokol change their position on launch?

Mr. MULLOY. Well, sir, this is speculation on my part, since I was not involved in the caucus, but I have to speculate that upon having all of the information discussed in that 2-hour telecon, and what the meaning of those data were, and what conclusions you could and could not draw from those, that during that 30-minute caucus, that they concluded they were in a go-for launch position.

Mr. PACKARD. When they conveyed the decision or the recommendation not to launch, you were involved in the receiving of that information?

Mr. MULLOY. Yes, sir.

Mr. PACKARD. What was your reaction?

Mr. MULLOY. My reaction to that was that the recommendation not to launch below 53 degrees had not been—the basis for that had not been established, and during the course of the discussion, several flaws in an argument that would say that you conclude from these data that you cannot launch below 53 degrees, that that would be a valid argument.

Mr. PACKARD. My time is up?

Mr. ROE. If you have one more question.

Mr. PACKARD. Mr. Mulloy, you testified to the Commission that the context of the Thiokol presentation the night before the launch was that primary O-ring with the reduced temperatures and reduced resiliencies may not function as a primary seal, and would be relying on the secondary seal, the redundancy.

Yet, the primary O-ring was changed from a critical 1-R, which incorporated the redundancy to a critical 1, long before this, the launch time.

How could you accept the rationale of the redundancy and authorize this launch when, in fact, it was not a critical 1-R?

Mr. MULLOY. Yes, sir. The category of the joint—of the case joint was changed from criticality 1-R to criticality 1 back in late 1982, and approved in level one in March 1983, I believe.

As Mr. Boisjoly has testified and he said this again this morning, at the moment of pressurization, from zero to 170 milliseconds, redundancy does exist.

From zero to 170 milliseconds, redundancy does exist. From 170 to 330 milliseconds, whether or not you have redundancy, is an iffy proposition.

Above 330 milliseconds, I believe he said, under a worse case stack-up of tolerances—either he or Mr. McDonald mentioned this this morning—you may not ever have a secondary O-ring.

The rationale that was developed by—this wasn't developed by me. This was developed by the engineers during the course of this discussion, or at least the point was made during the course of this discussion—that should you have blowby, the primary O-ring which was the concern that was being expressed, that the O-ring would be sluggish, because it is cold, that the grease would be viscous, that the timing functions in getting that O-ring across its gap and in there might be somewhat longer than what it had been at warmer temperature.

The conclusion was that should you have blow-by, during that period, that blowby would seat the secondary O-ring and cause the seal. The rationale that was presented in written form was that the data did not indicate that the primary O-ring would not function.

However, should blowby occur at pressurization, the secondary would, because you have redundancy from zero to 170 milliseconds.

Mr. ROE. If the gentleman would yield, that is assuming, however, you were testing within a certain temperature range, because you didn't know it was going to happen in a lower range, you stated that yourself.

Mr. MULLOY. I am sorry—

Mr. ROE. You are talking about redundancy, and you are saying that at different levels and temperatures and so forth, the redundancy may exist in certain milliseconds.

Mr. MULLOY. Yes, sir.

Mr. ROE. The issue that we discussed earlier is we never had an experience at those lower temperatures because we never did it before.

Mr. MULLOY. I would like to clarify what I said before the recess.

Mr. ROE. If you would like to clarify that you meant that is OK, but I heard what you said.

Mr. MULLOY. I wanted to make certain the record was clear.

Mr. ROE. I want to be clear that the point of view from NASA's point of view, that we are concerned—we are concerned with 14 launches that have some problems to them. We are concerned with that.

We don't buy the point of view, do we measure other criticality points in degrees? My father taught me something about something in my life. It is or it isn't, we can't take an issue in our lexicon, you took it from a 1-R position and made it a No. 1 position.

You didn't qualify that, there is nothing in the record that qualifies it as half an 1-R or three-quarters of an 1-R in terms of temperature. It seems when we are concerned about 700 audit items being criticality one category, you say any one of those could be disastrous, and therefore, we put them in criticality number one.

We didn't say we put them there in number of degrees. We either did or we didn't.

Mr. PACKARD. Mr. Chairman, before we leave this, one of my primary concerns is that with all the signs and with all the indicators from launches that the O-rings deteriorated with the lowering of temperatures. There should have been tests run, but from all the

indications that I have received, the only data that was accumulated was from previous launches.

If we took the attitude that we would use launches to determine the data base, then we had a built-in accident at some point or another. That process builds in an accident that we will only use—we have not done any testing, field testing or otherwise, but we simply use the data from the previous launches when it comes to cold weather.

Then it simply is saying we are going to continue to launch until we have an accident, because we used previous launch data as far as the effect of cold weather on the O-rings.

The tables clearly show that at 65 degrees and above, there were 17 launches without any deterioration of the O-rings, and there was not a single launch below 65 that didn't have O-ring problems, not a single one, and that is the only data base we have.

We have no research data that was done without it being associated with a launch, and that means that we would continue to launch and flirt with cold weather problems until we had an accident and to me that is just terribly alarming, that we had a built accident somewhere along the line, it could have been before had we had cold weather, but certainly we were going to continue to launch using the last data of the cold weather launches to determine whether we had problems or not, especially when we had signs as long as 9 years before that we had problems with that joint.

Mr. ROE. I appreciate the gentleman's comment. Do you want to respond?

Mr. MULLOY. I think the first paragraph in chapter 6 of the Presidential Commission report sums up what the distinguished gentleman has said succinctly, and I take no issue with that.

I do have, I guess, some different data relative to the temperatures at which O-ring erosion has occurred. STS-2 was 70 degrees, and it was the worst erosion that we had on a primary O-ring.

Mr. PACKARD. Let me refer you to page 146, and look at the charts, because you have made some references to the first chart, that you were confused and could draw no conclusions from the upper chart, figure number 6, because it showed a variety of erosions anywhere from 53 degrees up to 75 degrees.

But the chart below clearly shows that there was no deterioration of 17 flights above 65 degrees, and all flights below 65 degrees had deterioration, not one single flight that showed no deterioration below 65.

To me, that would be the safety officer's job to monitor this kind of data that would obviously show that below 65, there very well may be problems. In every case, there was.

Now, above 65, the data may be inconsistent, but far more on the consistency side that above 65 is safer than below 65, and it would be the safety officers determination and monitoring of these that would help give some direction to whether it is a go or no-go, certainly below 53 degrees.

Mr. MULLOY. I think some of our confusion and possibly something that led to the decision that we made on the 27th was clouded by the fact that we had in the data shown, that we had had a full-scale flight motor fired with an O-ring temperature of 40

degrees, and the further thing that clouded the issue was that the worst erosion that we saw on the nozzle, the case joint and on the case joint occurred at temperatures above 70, so it kind of confused us as to what the real effects of temperature were.

Mr. PACKARD. But your tests at 40 degrees did not parallel the conditions that these monitorings were done by actual flights. This was a static test that may not have the same application as one that would be in flight.

Mr. RITTER. Would the gentleman yield on that point?

Mr. PACKARD. I would be happy to yield.

Mr. ROE. The gentleman from Pennsylvania.

Mr. RITTER. Thank you.

In talking about temperature effects, you have been focusing on the erosion, but as you say, you have a lot of erosion at 72 degrees—maybe erosion was only part of the problem, and maybe not the main problem, because the key to an O-ring seal is compressibility, the fact that it seals and sits and you can lose material and still have seal.

But if you look at the data on O-ring recovery versus time on page 65 of the Presidential Commission's report, you will see that there is just no doubt that at low temperatures, these O-rings are pretty solid.

I mean, they are losing their compressibility, and that to me is even more than the O-ring erosion data. I wish you could comment on that. There seems to be no doubt about that at all.

Mr. MULLOY. Yes, sir, there is no question that January 27, we were familiar with both erosion and blow-by, and there was I believe more in judging the acceptability of the risk and in the impressions that I took from Morton Thiokol, that stated that it was an acceptable risk, there was more emphasis on the margin, if you will, between the maximum erosion that could occur during the course of blow-by, and that there was such a margin against what could theoretically occur versus what could be sustained, that they still felt it was a safe situation.

Mr. RITTER. In Mr. Kilminster's testimony, he doesn't even mention O-ring recovery, the solidification of the O-ring at falling temperatures, he just talks about the erosion, and yet, the data is there to show that the compressibility or the flexibility of the O-ring is lost, essentially lost at, it looks like about 30 degrees Fahrenheit.

It becomes less than compressible, or it doesn't recover.

Mr. MULLOY. That is correct, sir, in a static situation.

Mr. RITTER. And it would probably be worse—it would probably be far more dangerous in a dynamic situation where other things can happen and usually do.

Mr. MULLOY. Yes, sir. Of course, in fact, in testing that was done at low temperatures subsequent to the accident, it was shown that an O-ring will seal far below 50 degrees in a dynamic situation, depending on the initial gap the O-ring is compressed to.

Mr. RITTER. It depends on the design at that point, and you were working with not necessarily the greatest of designs.

Mr. MULLOY. Yes, sir.

Mr. ROE. The Chair recognizes the distinguished gentleman from New Mexico, Mr. Lujan.

Mr. LUJAN. Thank you, Mr. Chairman. I have looked forward to the hearings today, because I am particularly interested in the whole management review thing rather than the engineering, all of the changes that can be made to the seals and the O-rings and all of that.

It seems like every time something comes up, we run into Marshall, the way of doing business at Marshall. On the decision to launch and the discussions about whether you should, because of the temperature, and all of those things, there was a decision made and then we hear testimony that it was never passed on higher.

Aldrich and Moore both said they didn't know anything about it. We then learn that the erosion had happened, was noticed first on STS-2, which Admiral Truly was on, and he was very surprised during the Commission report to know that there was a problem because he hadn't known until the economic meeting or didn't know at the time.

The end of last week, there was some kind of a flap about turning tapes over to the Commission that hadn't been turned over, headquarters had to be contacted, and headquarters turned over those tapes.

We then find out in checking why had they not been turned over? We were told even the participants didn't know that they had been taped. And it just seems like nobody passes information on to anybody else, and that there is a big bottleneck there, and that has caused a lot of problems, and one of the things that NASA needs to address in order to make it a workable system—I don't want to be casting any aspersions at Marshall, but it seems to me like every time something comes up, it is because it was something that either Marshall knew and didn't pass on or didn't know and should have been known—does Marshall operate different than other centers in that headquarters doesn't seem to know what happens over there, it just dies there?

Dr. GRAHAM. Mr. Lujan, if I may start the answer—to that and then I will ask Admiral Truly to address the issue of the videotape and Dr. Lucas to address the partial communications issue.

As was testified, communications and management in NASA is a NASA-wide issue, and not limited to the Marshall Space Flight Center. The discipline for communication, and to make sure that information is moving in the appropriate channels and getting to the appropriate people is an agencywide concern, and has to be addressed from the highest levels of the agency.

A more subtle part of that is recognition of important information whether it is passed through the system. Part of that is the responsibility of the person originating the information to make sure it is tagged appropriately. But a major part of that lies in the most senior management at NASA to make sure that the significance of information is recognized when it is received, and all of those issues are key matters that we must address in our return to successful space operations. It is a matter of greatest concern to the headquarters as to, first, why information wasn't better recognized, and secondly, how to make sure that in the future, it is better recognized for its significance.

With that, I would like to ask Admiral Truly to address the issue of the videotape, and then Dr. Lucas.

Admiral TRULY. I am delighted you brought up the issue of the videotape, Mr. Lujan, that got some play on the media Friday evening. I was very frustrated by that, and personally involved, and would like to share what I know about that. I believe an incorrect perception was given in some of that, and I think I can set a little bit of that straight. As I understand the situation with those tapes some years ago, when General Abrahamson was Associate Administrator, there were teleconferences held throughout the system including Marshall and other places that combined video and audio to improve the teleconferencing of meetings.

When your staff a couple of weeks ago was over at NASA and we were providing them with some prebriefing, someone, and I am not sure who, mentioned that they had heard that such a videotape was possibly available of some of the flight readiness reviews. Somebody from the Marshall Space Flight Center was at the meeting, I was not there, but Jack Lee related this to me this morning.

And he immediately called back and began asking questions, and it turned out that the communications laboratory or the technicians at the Marshall Space Flight Center had recorded four flight readiness reviews, in an effort to improve the audio and video quality because it was a sync problem, and also an audio quality problem in these video conferences.

It was not a part of the procedure prior to the accident directed by level 1, level 2, or level 3. It is true that during the investigation that neither the task force nor the Commission knew of the existence of these videotapes, and I might add that I am very sorry that we didn't, because earlier on in the investigation, it would have been very helpful. Because as the one you saw earlier, whether you put a face and a voice to a viewgraph, it makes a big difference as to the effect, and I think it would have been helpful to the Marshall Space Flight Center in that perception.

Mr. LUJAN. You should not have been frustrated in listening to that, because my understanding was that it took going to you in order to get them, and the minute you asked for them, you got them.

But the appearance seemed to be apparently at Marshall, there was some confusion that we didn't know that the tapes existed or for whatever reason, they weren't turned over to the Commission.

Admiral TRULY. That is what frustrated me, because I took the trouble that afternoon to write a press announcement that went out with the videotapes. Apparently, it was not adequate to explain all the detail.

At any rate, they were discovered. There was about 2½ minutes on one of them, which you saw, where Mr. Mulloy talked about the O-rings, which as I say, I wish we had known earlier.

I called the Commission within 10 minutes or so of when I heard about it. The Marshall Space Flight Center, in coordination with us, called a satellite link and transmitted the tape to Washington; we made a copy of it and it was over to the Commission the next morning.

So my frustration is in perception, and I can only say in my personal experience in the course of the investigation when I tasked Marshall, generally through Mr. Jack Lee, who was on the task force, and who is a Deputy Center Director. I never once had a

single delay beyond the mechanical delays of finding information to get to me so that I could send it directly to the Commission.

Thank you, sir.

Mr. LUJAN. Thank you.

Dr. Lucas.

Dr. LUCAS. I am sorry if Marshall is perceived as not being communicative. This is not our intention or desire, and I don't think it has been our effort. With regard to the tape just described, within minutes of its discovery, that was communicated to Admiral Truly's office, and was made available because it was recognized how it would be perceived coming up late as it did.

There would be no motivation for us to not release those tapes, because it did make the point that we had communicated our concerns about the O-rings throughout the system, and throughout the flight readiness reviews.

I think Marshall is the center of attention because we are responsible for the main propulsion system of the shuttle, and the solid rocket motor is our responsibility. It is true that we have had concerns about the O-rings for a long time, but those concerns have not been retained, they have been disseminated in various ways, in our problem assessment system, they have been disseminated in our flight readiness reviews, as was testified. At least some of them have been recorded in our flight evaluation reports that are released in a few days following every flight.

So, that has been pretty well disseminated, in my opinion. I think it is true that we at Marshall and we throughout the system did not fully comprehend the significance of what was being seen at that time. It seemed to us that a good rationale existed for continuing to fly.

Never had anyone suggested to me, nor had I deduced based upon my own information that we had a situation that was unsafe. I am confident that had any of us concluded that we would have been screaming very loudly on that.

Mr. LUJAN. I know that these time constraints are awful, because you don't get to pursue a subject very much, but what you are telling me, I guess is, you didn't think that the situation was that serious when Thiokol told you that you shouldn't launch and then went back and had them reevaluate it, and then Marshall decided that—Thiokol decided to change their mind, and Mr. Kilminster sent you a wire.

If that is the case, if you did not perceive it as a serious situation, then that explains why you didn't tell Mr. Aldrich or Mr. Moore about it. They testified that they had absolutely no idea that that process had gone through, and that the final decision had been made to do it; is that correct, because you didn't perceive it as a serious matter?

Dr. LUCAS. I wasn't in any of the discussions on that previous night. I was informed about the discussions, and I was informed that Thiokol had suggested or some members of Thiokol had expressed a concern about the effect of the cold temperature on the O-rings.

But then, on the following morning, about 5 a.m. on the morning of the 28th, I was told that Thiokol had proposed to launch and was shown the flight readiness or flight commitment statement of

Mr. Kilminster, and was also informed that our own engineers, very competent people in whom I have great confidence, agreed with that assessment. Therefore, there was not an issue as far as I was concerned, and for that reason, I didn't pursue the matter beyond that.

Mr. ROE. Will the gentleman yield? You are saying to the committee what seems to be that Thiokol made the recommendation, but Thiokol testified this morning, and their first approach was from their engineering stand point of view was a no-go, and that was when we went off the record and took the half-hour for Thiokol to review additional information that was given to them or propounded to them from Mr. Mulloy and his associates, and they took that matter under judgment, and then they came back and they responded.

So, are we saying that Thiokol made the recommendation and then NASA agreed, or did Thiokol say no-go until NASA said, why not, here is where our rationale comes in, and then they were responding to NASA's concern.

The reason I am thrusting this, we have to dispel the point of view, was the decision made because of intimidation? Was the decision made on the part of Thiokol because NASA was their biggest customer? That is out there.

When we are done with this one thing, people are going to know, every rumor, we are going to get done with it. But the question is not clear. That is still not clear to us.

And then we go to the point, if the gentleman would yield further just to get it into the record, at the beginning of Mr. Mulloy's statement, you said that there were nine cases of O-ring erosion and blowby reviewed by levels above me, and you listed the nine cases.

We would like to ask you to list the nine cases again, and then tell the committee at what level the O-ring problem was discussed and who was at that level. Do you see where I am coming from, Dr. Lucas?

Dr. LUCAS. I do. May I respond by saying that what happened in the course of that 2-hour discussion is hearsay information as far as I was concerned? What I saw was the next morning after it was over, and was presented with the readiness statement.

Now, when I saw the signature of Mr. Kilminster, who is a respected engineer and vice president of Thiokol, with whom we have been associated for a long time, and whom I have a lot of confidence in, when he says he is ready to fly and he bases that on technical, not management considerations, I am inclined to accept that.

That is further amplified by the fact that to preclude Thiokol from doing what some may be accusing them of doing now, we placed an incentive on them to avoid this very thing. Thiokol has a substantial penalty riding upon any flight failure.

Thiokol has a positive incentive to deliver their hardware to the launch site on time, which they had done. To assure we have quality of hardware we placed a \$10 million penalty for any flight failure plus the loss of any positive incentive they had already gained. So it is inconceivable that a company would take that kind of risk and recommend a launch with which they didn't agree.

Mr. LEWIS. Would the gentleman yield?

Mr. Kilminster this morning stated this is the first time that he had to provide this in writing prior to a launch. Doesn't it seem unusual on this particular launch this particular problem had to be approved by Thiokol in writing and wouldn't that cause your hackles to come up a bit?

Dr. LUCAS. No, sir, because that is standard practice.

Mr. LEWIS. He said this morning it was the first time he had to do this.

Dr. LUCAS. No, sir, I think he said it a little differently. He said at this juncture. Thiokol always presents a readiness statement for launch. When we have our flight readiness reviews, then when we have our L minus 1 day review, Thiokol always presents a statement signed off with Mr. Mulloy in writing that it is ready to launch.

This is the first time that a concern like this had arisen in this timeframe, and I believe that is what he referred to as being unusual. It is the first time they had ever done it, because as far as I know, this is the first time this ever happened. But it is not unusual. Mr. Kilminster usually signs a flight readiness statement.

Mr. LEWIS. When does he usually do this?

Dr. LUCAS. At the flight readiness review and then I believe that is repeated at the L minus 1-day review, which is 1 day before launch.

Mr. LEWIS. And this one was done when?

Dr. LUCAS. There had been an L minus 1-day launch, I believe, 3 days before that which he had submitted his last statement and then we had oral checkups when the launch was stood down day by day. This one was done sometime in the evening before the launch the following day, some 12 or so hours before the launch, I presume.

Mr. LEWIS. He had previously signed off a flight readiness report 3 days earlier?

Dr. LUCAS. Yes, sir.

Mr. LUJAN. I think he said 2 or 3 weeks ahead of launch date was the normal time that he did it, and this was the first time he had to do it on that date.

Dr. LUCAS. Two or three weeks is the flight readiness review. L minus one is the launch minus 1 day.

Mr. LUJAN. That should have raised something in hindsight—my God, we could all live a much better life than we do if we had hindsight. The other thing that has to do with this to raise the point that it was serious was that Mr. Locke, the chairman and chief executive of Morton Thiokol this morning said that they had concluded that they shouldn't launch and then he said, our engineers could not prove that it was unsafe to fly at less than 53 degrees Fahrenheit—a change in the way that we have done business before.

In the past, you had to prove that it is safe first, and now for this particular one, it was reversed, the attitude was reversed, prove to us that it was not safe.

Dr. LUCAS. There certainly has been no change in policy to that effect. I would never condone such a policy as that. Since Mr. Locke said so, it must appear that way to him. That is not our

policy to prove it is not safe to launch. We prove we are safe to launch.

Mr. LUJAN. Well, I hate to be taking up so much time, but did you give Mr. Mulloy any instructions—you say you didn't know before that next—let me let that question go by and give others a chance.

Mr. ROE. I would like to get Mr. Mulloy to answer the question, would you repeat the nine flights and tell the committee at what level the O-ring problem was discussed and who was at that level? What I am trying to get at is I read the New York Times article about your concern on—they reviewed some of the decision processes and so forth.

You made that statement in part today, I am in part of the system, up in the chain, but I don't make all the decisions basically is what you said. There were other levels involved.

You mentioned again, you listed the whole nine, and tell the committee at what level the O-ring problem was discussed. We have been going on this for 7 years and then who was at that meeting?

Mr. MULLOY. Yes, sir. I can answer part of your question.

Let me say I cannot answer everyone who was in the flight readiness review. I believe there is an action underway to try to ascertain that in headquarters, but I cannot testify as to who was at each one. I did not bring my record of this with me. I called back, and had a man call back, and asked which ones were discussed at levels 1 and 2.

I am reading from what was provided to me. It looks like it fits within the erosion. STS-11, 41-C, 41-G, 51-E, Echo, 51-F, Foxtrot, 51-I, 51-J, 61-A or Alpha, and 61 Bravo.

Mr. ROE. These were a problem with the O-rings and they were discussed at level 1?

Mr. MULLOY. Level 1 and level 2.

Mr. ROE. Therefore, it is inconceivable that level 1 which is top management would not have understood the issue?

Mr. MULLOY. That is right, and I believe that has been acknowledged.

Mr. ROE. The distinguished gentleman from Florida, we took away 1½ minutes this morning as we concluded and I would give that 1½ minutes back.

Dr. GRAHAM. May I add a comment to that made by Mr. Mulloy?

Mr. ROE. Yes, sir.

Dr. GRAHAM. We are, in fact, reviewing the records to see who was at the various flight readiness reviews that occurred when the O-ring data was mentioned, and we have not yet been able to pull that together. However, we will take that for a record and provide you with what information we have on that.

[The information follows:]

Material requested for the record on page 204, line 4764 by Chairman Roe during the June 17, 1986, hearing.

There is no requirement to keep attendance at the Flight Readiness Reviews (FRR's); consequently, no official record of attendee's has been maintained. In some few instances, lists of potential attendees are available and are attached. These should be considered as "typical" of attendance at the more recent FRR's. However, it must be noted that just because an individual's name is on the list does not assure that that individual was in the room at any specific point in time.

Typical JSC participation at an FRR would include the Center Directors, the NSTS Program Manager, the major organizational element directors, the lead flight director, the presenters of FRR material and other individuals deemed necessary to support the presentations.

STS 61-B FRR
ATTENDEES

Washington:

- o Head Table: Beggs, W. Williams, Moore, RCA/John Christopher, Weeks, Lee
T/Bastedo, E/Benson, Winterhalter, Silveira,
Harrington, Miller, Harkleroad
- o Others: Hamby, Ryan, Dr. Nicogossian

CUSTOMERS

AUSSAT/Max Crisp	at KSC
MORELOS/Bob Sava (NASA LSSM)	at KSC
SATCOM/John Christopher	here at HQ
MDAC/Irv Webster	Huntington Beach, CA
Hughes/Charlie Carroll	at KSC

JSC: Griffin, Goetz, Aldrich, Kohrs

MSFC: Lucas, Lindstrom, Taylor, Dr. Lovingood, Marmann, Mobley, Bridwell
Bunn, Hardy, Dr. Littles, Kingsbury, Henritz, Thomas, Lester
Malloy, Zoller, Nichols, Horton, Thompson

KSC: D. Smith, T. Utsman, B. Sieck
J. Talone, S. Beddingfield, J. Conway

RIC-DOWNEY

Dr. Petrone, Peller, Glazer, Bejmuk

MMC-MICHOUD

Mr. Davis/Robert Smith, J. Dutton

ROCKETDYNE:

Gerry Johnson, Paul Dennies, Dick Schwartz, Al Hallden

THIOKOL: Kilminster

PATRICK AFB: Col. Smith, J. Nordbush, Col. Shults

GSFC: T. Janoski, R. Barning

SPACE DIVISION

Lt. Col Larry Combes, Lt. Shipman

SPACE COMMAND

General Sawyer, Col Anzalone

STS 61-C FRR
ATTENDEESWashington:

- o Head Table: Graham, Moore, Weeks, Lee
T/Wood, E/Sade, D/Cohen, Harrington,
Gunn, Winterhalter, Miller, Harkleroad
- o Others: Hamby, Dr. Nicogossian

CUSTOMERS

MDAC/Irv Webster at Huntington Beach, CA
RCA American/Bill Palme/Joe Schwartz at JSC

JSC: Griffin, Goetz, Aldrich, Kohrs

MSFC: Lucas, Lindstrom, Taylor, Dr. Lovingood, Marmann, Mobley, Bridwell
Bum, Hardy, Dr. Littles, Kingsbury, Henritz, Thomas, Lester
Malloy, Zoller, Nichols, Horton, Thompson

KSC: D. Smith, T. Utsman, B. Sieck
J. Talone, S. Beddingfield, J. Conway

RIC-DOWNEY

Dr. Petrone, Peller, Glazer, Bejmuk

MMC-MICHOUD

Mr. Davis/Robert Smith, J. Dutton

ROCKETDYNE:

Walt Williams, Gerry Johnson, Paul Dennies, Dick Schwartz, Al Hallden

THIOKOL: Kilminster

PAIRICK AFB: Col. Smith, J. Nordbush, Col. Shults

GSFC: T. Janoski, R. Barning

SPACE DIVISION

Lt. Col Larry Combes, Lt. Shipman

SPACE COMMAND

General Sawyer, Col Anzalone

41-B (STS-11) FRR TELECON PARTICIPATION

JANUARY 25, 1984

LOCATION	NO	PRINCIPAL PARTICIPANTS
Headquarters	211	Beggs, Mark, Culbertson, Abrahamson, Moore, Weeks, Gunn, Baynes, Dankhoff, Hamby, Land, Fitts, Harrington, Wild, Lee Silveira, Cohen, Davis, Edelson, Aller, ASAP members
	209	Griffin, Goetz, Lunney, Aldrich, Kohrs, Charlesworth, Kranz, Draughon, Bostick, Honeycutt, McCarty, Jackson, Jones, Moorehead, Colonna, Cohen, Nicholson, Williams, Bobola, Germany
	210	Smith, Page, Utsman, Rock, O'Hara, Seick, Lamberth,
KSC	296	Hollinshead, Long, Sasseca, Parker, Minderman, Walton,
	265	Jones, Hannemann, O'Connor, Gustafson, Green, Lee, Mills Neilon, Williams Grenville, Morgan
	240	(USBI) Donnelly, Catalano; (MMC) Wirth, Favata;
MSFC		Lucas, Lee, Kingsbury, Lindstrom, Lovingood, Hardy, Mulloy, Taylor, Horton, Adams, Jackson, Henritize, Brooks, Zoller, Thompson, Nichols, Bridwell, Thomason, Downey
		(USBI) Murphy, Lavacog
		Minor, Boykin, Smith, Benner, Gerstner, Petrone, Rubenstein
		Foll, Davis, Smith
		Johnson, Dennies, Fuller, Sanchini (Walt Williams-NASA)
		Kilwan
		Kutyna, Lindsay, Owens
		Henderson, Lawter, Yager, Bolen, Gooch
		825-7310 Sniegowski, Anzalone
		-KSC Jones, Hannemann, O'Connor, Gustafson, Green, Lee, Mills
GSFC	572	McCeney, Lynn, LaFluer
MDAC		Webster, Daros

41-B FRR Telecon Participation (Cont'd)

NASA Advisors/Location

Headquarters

W. Hawkins
S. Himmel
C. Donlan

Payload Reps/Location

Headquarters

WESTAR
H. Leavitt-WU
A. Cammarato-WU
M. Callahan-WU

Rockwell

H. Grier

KSC

PALAPA
S. Gunawan-Indonesia
H. Asturi-Indonesia
Solich-Indonesia
Silalahi-Indonesia
Akbar-Indonesia

WESTAR

Van Cleve
Hilburn
Judson
Hepsen

SPAS

Moritz
Klaber

HAC

Carroll
Albinger

MDAC

Payne
McLean
Holloway

Rocketdyne

W. Williams

Huntington Beach

JSC

MDAC
J. Webster
C. Daros

WESTAR

M. Ziegler-WU
F. Cleary-WU

Hughes AC

W. Grayer

FRR
 ^
 LEVEL I ATTENDEES (MSFC)

MISSION 41-C	MISSION 41-G	MISSION 51-E	MISSION 51-F
DR. LUCAS	MR. LEE	DR. LUCAS	DR. LUCAS
MR. KINGSBURY	MR. KINGSBURY	MR. LEE	MR. KINGSBURY
MR. LINDSTROM	MR. THOMAS	MR. KINGSBURY	MR. BUNN
MR. TAYLOR	MR. HENRITZE	MR. TAYLOR	MR. TAYLOR
MR. BRIDWELL	MR. BRIDWELL	MR. BRIDWELL	MR. THOMAS
MR. MULLOY	MR. MULLOY	MR. MULLOY	MR. MULLOY
MR. HARDY	DR. LITTLES	DR. LITTLES	MR. LESTER
MR. HORTON	MR. HARDY	MR. HENRITZE	MR. BRIDWELL
MR. LEE	DR. LOVINGOOD	MR. HARDY	MR. NICHOLS
DR. LOVINGOOD	MR. THOMSON	MR. BUNN	DR. LOVINGOOD
MR. THOMSON	MR. NICHOLS	DR. LOVINGOOD	MR. HARDY
MR. NICHOLS	MR. LINDSTROM	MR. THOMSON	MR. HENRITZE
MR. HENRITZE	MR. HORTON	MR. LINDSTROM	MR. LINDSTROM
MR. BUTLER	MR. BUTLER	MR. NICHOLS	MR. THOMSON
MR. ZOLLER	MR. ZOLLER	MR. ZOLLER	MR. HORTON
MR. YORK			DR. LITTLES

MISSION 51-I	MISSION 51-J	MISSION 61-A
DR. LUCAS	DR. LUCAS	DR. LUCAS
MR. LEE	MR. RICHARDSON	MR. RICHARDSON
MR. KINGSBURY	MR. KINGSBURY	MR. KINGSBURY
MR. TAYLOR	MR. HARDY	MR. TAYLOR
MR. REINARTZ	MR. BUNN	MR. THOMAS
MR. MULLOY	DR. LITTLES	MR. MULLOY
MR. BUNN	MR. HENRITZE	MR. BUNN
MR. BRIDWELL	MR. BRIDWELL	MR. BRIDWELL
MR. NICHOLS	MR. NICHOLS	MR. CHASSAY
DR. LOVINGOOD	DR. LOVINGOOD	DR. LOVINGOOD
MR. HARDY	MR. REINARTZ	MR. HARDY
MR. HENRITZE	MR. TAYLOR	DR. LITTLES
MR. LINDSTROM	MR. C. SMITH	MR. REINARTZ
MR. C. SMITH	MR. ADAMS	MR. J. SMITH
MR. ZOLLER	MR. J. SMITH	MR. NICHOLS
DR. LITTLES	MR. CAMPBELL	MR. HENRITZE
		MR. C. SMITH

2201 HEADQUARTERS BUILDING

SEATING CAPACITY: 68

51-F DELTA LRR/FRR SEATING

- (ADDITIONAL SE SEATING)
- 1 (SO)
- 2 (SO)
- 3 (SO)
- 4 (JSC R/O)
- 5 (JSC R/O)
- 6 (JSC R/O)

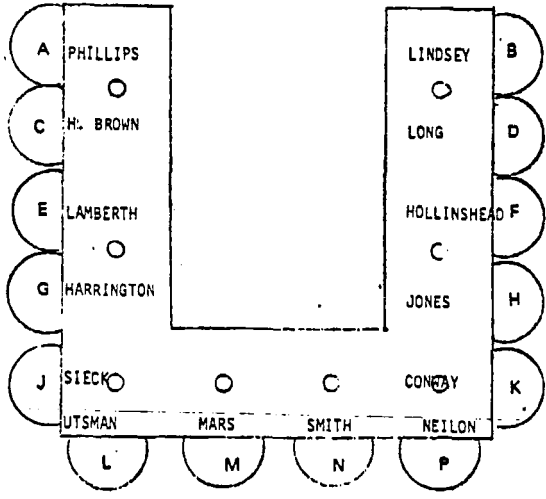

- 7 AF
- 8 AF
- 9 AF
- 10 AF
- 11 CARG
- 12 CARG
- 13 CARG
- 14 CARG
- 15 CARG
- 16 CARG
- 17 CARG
- 18 CARG

19	20	21	22	23	24	25	26	27
*****L SOC SEATING*****								

28	29	30	31	32	33	34	35	36
*****S PC SEATING*****								

37	38	39	40	41	42	43	44	45
*****NASA SEATING*****								

46	47	48	49	50	51	52	53	54
*****ADDITIONAL S PC SEATING*****								

2201 HEADQUARTERS BUILDING

SEATING CAPACITY: 68

51-F DELTA LRR/FRR SEATING

ADDITIONAL SE SEATING

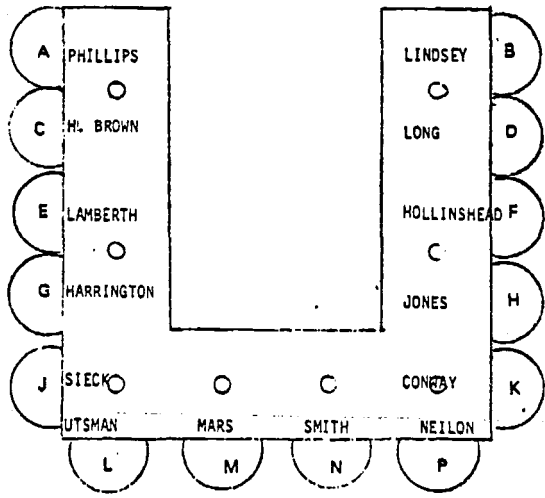

- 1 (SO)
- 2 (SO)
- 3 (SO)
- 4 (JSC R/O)
- 5 (JSC R/O)
- 6 (JSC R/O)

19	20	21	22	23	24	25	26	27
*****LBOC SEATING*****								

28	29	30	31	32	33	34	35	36
*****SPC SEATING*****								

37	38	39	40	41	42	43	44	45
*****NASA SEATING*****								

46	47	48	49	50	51	52	53	54
*****ADDITIONAL SPC SEATING*****								

- 7 AF
- AFB
- 9 AF
- 10 AF
- 11 CARC
- 12 CARC
- 13 CARC
- 14 CARC
- 15 CARC
- 16 CARC
- 17 CARC
- 18 CARC

I would also like to mention that there is another system within NASA to provide information on flight anomaly which parallels that which was transmitted in the flight readiness review and I would like to ask either Dr. Lucas or Mr. Mulloy to just mention that.

Mr. MULLOY. The problem assessment system is in place at the Marshall Space Flight Center as a tool to assure, it is a tool used by our quality and reliability assurance organization, that problems that occur in flights and in ground test, in development, or qualification motor tests that would have a bearing on the flight or the upcoming flights, that that is documented and tracked. That problem assessment system shows in the case of the O-ring erosion, it shows essentially the same information, in many cases identical information to what is in the flight readiness reviews. It is the basis for continuing to fly given the observations that we're seeing.

That information is provided here to NASA headquarters to the Chief Engineer's Office. So that is another route by which the information on the O-ring erosion is known to level one.

Mr. ROE. So what you are basically saying is that Washington level knew of part of the problems; is that a fair comment?

Dr. GRAHAM. There are two pieces to this, one, what was transmitted and what was understood. I believe what Mr. Mulloy and Dr. Lucas are addressing is what was transmitted. I don't know that they are the most appropriate people to express what was understood.

That was a headquarters issue and in some cases a Johnson Space Center issue. It is clear the issue was not perceived at the seriousness with which it actually affected the system. However, the information was transmitted to these agencies.

Mr. ROE. Where I am coming from—in 1985, the question is asked by Chairman Rogers to Mr. Mulloy and he says, and they all knew about it at the time of 51-L. Mr. Mulloy responds, yes, sir, you will find on the flight readiness review record that—you will find in the flight readiness review record that it went all the way to the L-1 review. That is on page 85.

Now, one of the findings or the observations, however, of the Commission was, it is disturbing to the Commission that contrary to the testimony of the solid rocket booster project manager, the seriousness of concern was not conveyed in flight readiness review to 51-L and the 51-L flight readiness review was silent.

Dr. GRAHAM. My point on that was that the seriousness of the issue has two aspects. It is the concern of it in the person who transmits it and the perception of it in the person receiving it. It has to be done in both domains and I think it is in fact unfair to focus all the criticism on the Marshall Space Flight Center, in this issue.

They could have transmitted the information in a higher profile way, but also as engineers, as managers at headquarters, there was certainly a responsibility to perceive the significance of this. So, as I said at the outset, I think the problem lies in more than one location.

Mr. ROE. Look. My job is not to nail down all the problems on Marshall Space Flight Center. That would be a fallacy on my part and the same way with whether it is the Kennedy Space Center.

You make an extremely important point, it is people's perceptions. If only I had known—that is what we are going through and we have to do it for a few days to get it on the deck.

The fact remains that we can deal with 7 years of knowledge that people in NASA knew of the problem. Even Thiokol this morning testified that since January they had put 40 engineers and people together on a team in January 1985. You now, it is still spunky.

We have to try to get rid of that perception and it seems to me that—I guess it was President Truman, God rest his soul, came back and said "the buck stops here." I have to give an account to 565,000 people in my district, to people who elected me, as does every other member here.

If we misread a public issue, then we are misreading it and that doesn't make it a crime, but the fact remains do we do something in this instance to improve our management? That is where we are coming from.

Dr. GRAHAM. I couldn't agree more and the buck does not stop at Marshall, but goes to headquarters as well in this situation.

Mr. ROE. The gentleman from Florida.

Mr. LEWIS. Thank you, Mr. Chairman.

Dr. Graham, you have pointed out the system is a good system, it is just that people didn't communicate what they were told.

Dr. Lucas, when Mr. Mulloy came to you at your hotel room on the night of the—when Mr. Mulloy came to you at the hotel and to your room and said that there were some engineering concerns, what was your response and what was generally your discussion with him at that time?

Dr. LUCAS. When that information was conveyed to me, it was that some people from Thiokol had expressed a concern about the potential effect of the weather on the O-ring, and that they were going out to the Kennedy Space Center to engage in a telephone conversation, between a few people at Kennedy and a larger number of our engineering people at Huntsville and at Wasatch.

I inquired as to who in Huntsville would be involved in the telephone conversation and was given the names and I concluded on that basis that the appropriate people were involved in discussing the question. Therefore, I said, fine, proceed with it and keep me informed as to how the matter is resolved.

Mr. LEWIS. To your recollection, on any previous launches did you have any similar concerns like this with the solid rocket boosters?

Dr. LUCAS. I don't recall an instance with the solid rocket booster, but it isn't unusual to discuss concerns about the flight hardware up until an hour or two before launch. That goes on over the loop and in engineering discussions off line in many launches, and I doubt if there have been very many where that didn't occur. I don't recall this having occurred on the solid rocket booster, however.

Mr. LEWIS. But you were aware that for 9 years, since 1977, there was a concern about the possibility of a seal failure or a probability of a seal failure and that there was a concern expressed by Thiokol this evening.

I guess what I am concerned about, the comment was made earlier today that we have what I would consider some of the best technical minds in the business that are concerned about something like this, and then they are overridden by managers rather than by engineers.

Dr. LUCAS. If you are referring to the night before the launch—

Mr. LEWIS. Yes, January 27.

Dr. LUCAS. Let me go back to the 7 years or whatever the time has been.

Mr. LEWIS. You were supposed to have a referee testify, that never came off on this particular field joint.

Dr. LUCAS. It is true that there have been concerns expressed over the years about this joint and there have been modifications and improvements made in the joint over the years. I suspect if you would tabulate, you would find that the concerns expressed by the Marshall Space Flight Center are equal to or greater than the concerns expressed by anyone else.

The engineers who have expressed the concerns have also diligently tried and thought they had in fact improved the situation to the point of making it much better and I am sure they did make it much better.

It turns out that under these circumstances it wasn't made good enough. I wasn't aware of the overriding, if that is, in fact, the case of Thiokol people, by the managers.

Mr. LEWIS. I think the record will reflect that from this morning's testimony.

Dr. LUCAS. I have heard that testimony, and the testimony of the engineers since that time, and seen correspondence copied in the Roger's report that concerns me greatly, correspondence that I never knew existed, correspondence marked "company confidential," or "private," or something like that. That never came to my attention. Had it done so, I am sure the reaction would have been different.

Mr. LEWIS. Thank you.

Mr. ROE. The Chair recognizes the distinguished gentleman from New Hampshire, Mr. Smith.

Mr. SMITH. Thank you, Mr. Chairman.

In listening to the testimony this morning from Morton Thiokol and then listening to you gentlemen, it seems to me that in our oversight responsibility as a committee of Congress what we should be looking at is the term "acceptable risks."

We all realize, including the seven people who died realized, that there is a great deal of risk involved with flying in space and certainly with the rocket, but it seems to me what is unacceptable to this member is safety by consensus of the majority and I think essentially that is what we have here. We had a statement from the Thiokol people this morning that their engineers had if not a formal poll, at least there was some opposition in the number of people who were there, 12 or so in the room.

First it was indicated that they were opposed to this flight because they didn't feel it was an acceptable risk based upon the information about the O-rings, the temperatures, et cetera. It seems to me Mr. Mulloy that when you questioned, their first response to

the recommendation, which was not to fly, you essentially, at least—I am not trying to put words in your mouth—you got the answer you were looking for, which was it is an acceptable risk in your mind that the information based on the data that we had concerning the O-rings and concerning the temperatures, it was your opinion that that is all the information we had. We had not really done anything differently, we hadn't tested and, therefore, what you were looking for was specifically that, that this is an acceptable risk, that I don't see anything else other than that and I don't really understand why Thiokol would say otherwise, so in a sense—I don't mean to imply that you did it deliberately but I think in a sense you did exert pressure on Thiokol on that particular point.

Would you respond to me on that, please?

Mr. MULLOY. Yes, sir. I think I would characterize what I was doing as what I do when a large group of engineers who analyzed some data come to me with those data, with a recommendation. I look at the data and test the validity of that recommendation. I tend to challenge the conclusions that are being drawn from a little bit of data. I tend to challenge what conclusion can one draw from three data points on resiliency of O-ring when one of those data points say the O-ring won't seal at 75 degrees and we had tremendous experience that it did seal at 75 degrees.

That was the nature of the discussion. I think the testimony of the Thiokol people who made the decision was that they did not feel any pressure as a result of that, and I heard that in the Presidential Commission hearings and I heard it again this morning from the Thiokol people, that they do not acknowledge that they felt pressured.

Mr. ROE. If the gentleman would yield, I believe they did comment just the opposite this morning, when Mr. Kilminster was talking and Mr. Boisjoly, they did feel, they just had a feeling there was pressure on them from NASA.

Mr. SMITH. If you look in the testimony, your testimony, I am referring now to the Rogers Commission, pages 95 and 96, it just seems to me the bottom of page 95 under Mr. Mulloy, "It has been suggested, implied or stated that we directed Thiokol to reconsider these data." Now referring to the information that they provided you. "That is not true," you say. "Thiokol asked for a caucus so they could consider the discussions."

Then you go over to page 96, bottom of page 96, excuse me, the top of page 96, on the right-hand column, when you say:

At approximately 11 p.m., Eastern Standard Time, Thiokol and NASA teleconference resumed, the Thiokol management stating that they had reassessed the problem, that the temperature effects were a concern but the data were admittedly inconclusive.

I think what you mean there about what is inconclusive is basically what had been going on for, now we find out, a number of years, in terms of comments about the temperature and the O-rings and this data. The data was out there, we understand that, but what I am trying to home in on is: Isn't it reasonable to assume that if you have a bunch of very technical people, a group of very technical people, like the engineers at Thiokol, who are basically at odds with each other, they are not unanimous, they have some strong feelings about this thing, yet nothing new safetywise

has come up, to my—is that an acceptable risk in your mind when that kind of testimony is out there?

Is that an acceptable risk? Why wasn't something done over the past 6 years, or was anything done, perhaps, is a better question, between you at NASA and Thiokol to correct it? What specifically was done? Were there meetings? There was, certainly, and I haven't been here for 6 years. I will defer to my colleagues. I know of no testimony that has come before this committee regarding the safety or lack thereof of the O-rings, or temperature or any other testimony to that effect, and I have sat through a lot of hearings in 2 years but I don't know of any.

Mr. MULLOY. Yes, sir, I will refer again to the first paragraph of chapter 6 of the Commission report. I do believe that we, NASA, got into a group think situation relative to the seriousness of this problem. We saw it and assessed it as an acceptable risk. We saw it again. We looked back at how we accepted it before. When we saw something different we ran additional testing and analysis, and we convinced ourselves that it was an acceptable risk, and on January 27 that same thought process was in place, and we looked at the data and concluded that it was an acceptable risk.

You asked why wasn't more done. You know, in the 6 years previous. I have had that question posed to me many times in the last 4 months, and I have asked it of myself many times since the tragic accident. My answer has been, in hindsight, obviously more should have been done.

The turning, I think we started down a road as well summarized in that first paragraph, chapter 6, where we had a design that had a design deficiency. When we recognized that it had a design deficiency, we did not fix it. Then we continued to fly with it, and rationalized why it was safe, and eventually concluded and convinced ourselves that it was an acceptable risk. That was—when we started down that road, we started down the road to eventually having the inevitable accident. I believe that.

Mr. SMITH. My line of questioning is not to put you on the spot. My line of questioning is to try to determine for this committee what acceptable risk is, how we as a committee can get information that would help us to evaluate that, and I think had you felt as some of the Thiokol engineers—I think we are dealing with a philosophical difference rather than a technical difference. Philosophically, there has been a lot of information, technical information, provided about the O-rings and everybody was aware of it.

But I think had you had the same feeling, technically, that some of the Thiokol people had—not all but some—perhaps you would have accepted their first recommendation and not gone the other way. So I am not trying to pin blame here. That is not my job. What I am trying to do here, essentially, is to—for you to give some information to us as to how we might oversee what is acceptable risk, and how we might correct some of the, you know, management communication mistakes, if you will, that have taken place over the past, apparently now, 6 years on this particular issue.

Mr. MULLOY. Yes, sir. Well, perhaps I am not sure that I can give you the help that you are asking for. I will try and then perhaps some of my colleagues can give a better answer than I can in that

regard. But in the specific case of the O-ring, the rationale for acceptable risk was based on the analysis and test data that showed the tolerance to blow-by and erosion, and we convinced ourselves, based on that analysis and test data, that we could sustain the maximum theoretical erosion and still be in a safe situation.

That was—now, obviously since the accident we have found out a lot more about that joint, things that we did not know before that, and you are asking how can we get enough foresight in dealing with these type things. It is very unlikely that all 800 Criticality 1 items will be eliminated on the shuttle system. How can we get where we can forecast better, and judge better, what that acceptable risk is. I don't know that that helps, but that is the best I can give you.

Mr. SMITH. Just one quick comment, Mr. Chairman, for a final comment. If I could give a perception on this thing it would be that if I were a Thiokol executive in that particular situation, what has happened when the recommendation came forth, at least in their minds, was it is nothing new, in the sense that we have said before we have got problems with the O-rings. We have had, what was it, 24 successful launches—correct me if I am wrong; I think it was 24.

Therefore, what is the cause for alarm? It is easy to look back and say, yeah, there is a great cause for alarm now, but I guess what I am saying is apparently this was—this had become an acceptable risk, in our mind, and apparently you convinced Thiokol of the fact that there wasn't anything new regarding these O-rings or the temperature or any of this other information that would cause you to cancel the flight.

Is that a fair statement of what went on in the decisionmaking process?

Mr. MULLOY. Yes, sir, that is a fair statement, and I would only add that I reached that judgment not just on the 27th but in all those years before then, based on the input from these same individuals, both at Thiokol and at the Marshall Space Flight Center and in review above that.

Mr. SMITH. Thank you. Thank you, Mr. Chairman.

Dr. GRAHAM. Mr. Chairman, may I add one more comment either now or after you return?

Mr. ROE. Do it now.

Dr. GRAHAM. Fine.

When you ask a very deep question involving any high-technology complex program, which is what is acceptable risk, and how do you define it, I don't believe it has a very short answer. But let me give you at least a substantial part of that in short form.

For something like the shuttle, a purely statistical test, that is sample a component, test it, sample it, test it, can never, within reason of time and cost, be done to the degree of reliability that you need for operating a system like the shuttle, which is one in which you want a very, very small probability of failure, driven as close to zero as possible. In fact, what has to be done instead is that components have to be designed so that they perform in very predictable ways. They then have to be tested under a range of environments, and it has to be established that those components perform in the manner appropriate to the design and in the manner predicted.

Finally, you have to look at the failure modes of the system, and see what the liabilities, consequences are, if the component doesn't perform in the manner that has been designed and predicted for it, and take that into account in assessing the overall margin and reliability you have to put into that component. That is in fact the approach that is used on space transportation system, and that clearly broke down at least in the case of the field joints on the solid rocket boosters.

Mr. ROE. The committee will stand recessed while we vote. We will return and start again with Mr. Monson from Utah.

[Recess.]

Mr. ROE. The committee will reconvene.

When we recessed to vote, our next colleague to be recognized is the distinguished gentleman from Utah, Mr. Monson.

Mr. MONSON. Thank you, Mr. Chairman.

With regard to the acceptable risk factor that we were discussing before we broke, did temperature elements come into play on that, or was it strictly based on erosion and temperature and resiliency I guess, or was it strictly based on erosion?

Dr. GRAHAM. Let me start with that one if I may, and then I will pass it to Dr. Lucas and Mr. Mulloy. There was a concern over the erosion which had been carried for several years in the observation of the flight hardware data, and we have discussed that at some length.

It was known that there was an erosion and blowby on the joints. The potential influence of temperature on that I believe was less well understood, and was in fact part of the engineering discussion that took place on the evening before the launch.

While the issue of the original view of the Thiokol engineers, namely that it was in fact not safe to launch, was questioned, let me state that as an engineering discipline issue, I think it was appropriate that the NASA personnel, Mr. Mulloy involved in this case, did ask for the justification of that view, to understand why that was being made, to review the data, and to establish what the basis in previous experience, analysis, in fact was, that caused that.

Now there is no question that through this process errors in judgment and errors in evaluation of data were made. I am certainly not trying to say anything different than that, but raising the question why the recommendation was made in the first instance seems to me as an engineering manager an appropriate question to ask at that time. So that in fact not only Thiokol but NASA did understand the reason for the recommendation.

With that, let me ask Dr. Lucas and Mr. Mulloy to respond more specifically.

Dr. LUCAS. I think Mr. Mulloy should respond to the matter of the temperature being a consideration.

Mr. MULLOY. Yes, sir. The temperature data that was presented that night was the same data that existed back in July, and was discussed as I say on August 19, three test data points, one at 100 degrees, one at 75 degrees, and one at 50 degrees, and what the discussion centered around was what does that mean in terms of the capability to make a seal in that joint.

Mr. MONSON. My question really was in two parts, though. You said that you had derived some acceptable risk standards and tem-

perature entered into those decisions up to that point, forgetting everything on the night of January 27, prior to that, that temperature and resiliency of the O-ring entered into it?

Mr. MULLOY. No, sir, it had not, as an overwhelming concern. If you look at the total context around August 19, 1985, the total context of that briefing that was given here at NASA headquarters, you will see that all of the issues and the concerns that were being discussed about the ability of a joint seal were concentrated on the erosion, the margin that one had against erosion, and the conclusion being drawn that that was an acceptable situation.

There is no data in that presentation which was a comprehensive presentation. Now that lack of any concern being expressed for temperature continued right up to the night of January 27. There were two seal task force meetings which included the Marshall Space Flight Center engineers, where the whole interchange occurred of what are we going to do about working this problem, and temperature was not an overwhelming or was not a concern that was discussed there at all.

It was again toward primarily bending the putty, finding an alternate to putty, perhaps going to a larger O-ring and that type thing.

Mr. MONSON. Was erosion anticipated in the design process of this joint?

Mr. MULLOY. I am certain it was not. That predates me from when I came onto the SRB Program, but I am certain that a certain amount of erosion was not considered in the design process to be an acceptable—

Mr. MONSON. But once it was discovered that erosion occurred, then a decision was made that you could tolerate a certain amount of erosion?

Mr. MULLOY. Yes, sir, and that was based on analysis and tests that was done by Morton Thiokol.

Mr. MONSON. Now on the night of January 27, a recommendation was made not to launch based on some unknown factors, what the effects of temperature were primarily as I understand it. Had a recommendation against a launch by Morton Thiokol ever been made prior to this?

Mr. MULLOY. No, sir.

Mr. MONSON. And so without accurate data on what their concerns were at this time, why was it considered necessary to ask them for data that you probably knew they didn't have because it really hadn't entered into the fact, into the decisionmaking process up to that point?

Mr. MULLOY. Well, sir, I don't believe that anyone that I heard ask for data that we knew that they didn't have. What was said was that the data that we do have certainly do not give you a correlation between temperature and the fact that the joint will or will not seal. We were all concerned with the risk that we were taking in continuing to fly at any temperature, and what the data said was that there is a risk at any temperature.

As I stated, the worst, the nearest thing to a catastrophe we had before 51-L was 51-Bravo, where we completely eroded away a primary O-ring and eroded the secondary O-ring, and that was at

above 70 degrees, 75 degrees I believe, and that is the kind of discussion that occurred.

How can we reach a correlation. We know we have a risk in this joint. We are all concerned about the risk in this joint, but how can we correlate the probability of failure of the joint to temperature, and that was the whole gist of that 2-hour conversation.

Mr. MONSON. I don't like to Monday morning quarterback and I apologize for doing it, but it is hard to understand the process that occurred that night, when it was a concern over a lack of data, and then knowing that that data didn't exist because the tests had really only gone down to about 50 degrees as I understand it from the testimony that I am hearing, and yet it was understood from those tests that the lower the temperature got, the more the problem developed, despite the fact that you had had problems at higher temperatures on other flights as well.

It just seems that the evidence was leading that way, and I just would hope that we will remember this and make sure that if there is any doubt, we don't try to base things on whether or not we can prove that it is unsafe but whether or not there is data to support the fact that it is safe, in the future.

Mr. MULLOY. I certainly agree with that, sir, and that is what I thought we were doing on the night of the 27th.

Mr. MONSON. Thank you, Mr. Chairman.

Mr. ROE. The Chair recognizes the distinguished gentleman from Pennsylvania, Mr. Ritter.

Mr. RITTER. Thank you, Mr. Chairman.

I think most of what I wanted to ask has already been asked, but I would like to add this comment, and then some questions.

Neil Armstrong, when he was here kicking off these meetings, mentioned how in the early days they figured everything would go wrong that could go wrong, and they were very surprised when it didn't, and these days the attitude was everything is supposed to go right, and everything should go right, and they are surprised when it doesn't.

And I think for me that sums up what happened to the whole system.

I think the system was really a victim of its own success. Probably the greatest single enemy of the success of 51-L, of this shuttle *Challenger* mission, was the success of 24 previous flights. That the people in the system got in the mode of thinking that they could do no wrong, or that the systems were so good in their integrated combined state that little things like joints and O-rings and things like that simply weren't that important, and the test, the report, the Rogers Commission report, is so loaded with the idea that you almost had to prove, and I go to Mr. Lund's remarks to Chairman Rogers, he said "we couldn't prove absolutely that the motor wouldn't work" and Chairman Rogers said "In other words, you honestly believed that you had a duty to prove that it would not work" and Mr. Lund said, this is the vice president for engineering at Morton Thiokol, he said "Well, that is the kind of mode we got ourselves into that evening. It seems like we have always been in the opposite mode. I should have detected that, but I didn't. But the roles kind of switched."

I think that is a very, very telling comment. Now on a more specific note, I would like to call attention to the Thiokol "Letters and Memoranda Written After the O-Ring Concern Escalates." That is the title. I would like to know on page 249, whether anyone at NASA, Marshall or elsewhere, had any idea of this kind of memo which was circulating at Morton Thiokol. I just read from one paragraph.

It is from Mr. Boisjoly to R.K. Lund, vice president for engineering. He says, "If the same scenario should occur in a field joint, and it could, then it is a jump ball as to the success or failure of the joint because the secondary O-ring cannot respond to the clevis opening rate and may not be capable of pressurization."

By the way, the secondary O-ring cannot correspond to the previous, may not be capable of pressurization, I am not sure that is an erosion problem at all. We are really spending a lot of time on erosion when flexibility and compressibility is maybe the real factor. Anyway, "the result" he states, "would be a catastrophe of the highest order, loss of human life."

Had anyone any wind at all that this was the kind of concern that was in and about Morton Thiokol, and obviously this kind of concern is what underlies Morton Thiokol's reticence the night before the launch to go ahead. Was anyone aware of this?

Dr. GRAHAM. Mr. Ritter, I think I will ask the gentleman from Marshall to see if they had any specific knowledge of this. At headquarters I certainly did not, and I notice that the letter has company private, written on both the heading and the end of the letter. That type of communication is not normally circulated outside the company, although it is not impossible that it might be.

Dr. Lucas.

Mr. RITTER. I mean there are such things as leaks, which we are kind of familiar with around here. You know, this is the kind of thing that is leakable, because it is kind of a life and death matter.

Dr. GRAHAM. Let me ask the representatives from Marshall if they were aware of this letter.

Dr. LUCAS. I can say unequivocally that I was not aware of such a document as this, nor the information contained in it, and I would like to ask my other colleagues from Marshall if any of them were aware of it.

Mr. MULLOY. Sir, I was not aware of that information that is in this memorandum, and certainly not aware of the specific memorandum itself. There were monthly meetings face to face, and there were week to week telecons that occurred between the people who worked this problem or the solid rocket motor program for me, and none of those concerns that are in this memo were conveyed to me in any manner.

Dr. GRAHAM. I think another issue that might be raised here is why this was in fact a company private as opposed to a piece of information that would be transmitted, and I don't know the answer to that.

Mr. RITTER. Yes, I am a little bit concerned about that, too, in that there are certain things that are proprietary, there are certain things that you hold close to the vest, but when you deal with life and death issues, and you are dealing with a customer who is prob-

ably your biggest customer, you would think that this kind of, the strength of this argument, would be transferred.

I am just disturbed that it isn't.

Mr. Chairman, I would like to proceed if I may.

Mr. WALGREN. Would the gentleman yield for one follow-on thought.

Mr. RITTER. Yes, I will.

Mr. WALGREN. That is as I understand it after the memo that the gentleman from Pennsylvania just read, there was a presentation made to level 1 of NASA about the O-ring problem, and obviously they communicated substantially their reservations in that presentation, and the question I would have is not so much what happened in the launch of this *Challenger*, but as I understand it, after Morton Thiokol made that original presentation to level 1 NASA, the Commission found that, and I quote from page 148, "The O-ring erosion history presented to level 1 at NASA Headquarters in August 1985 was sufficiently detailed to require corrective action by or to the next flight."

And so the question is not so much why this flight was launched, but why did not NASA at the highest of levels, and this is beyond Marshall and beyond anybody knowing one thing and not knowing another thing, the information was adequate at the highest levels of NASA to suspend the flight in August and September 1985, and it wasn't done, and what is NASA's response to that?

Dr. GRAHAM. I will ask Dr. Lucas to address one specific on that, but I think the more general answer to the question goes back to Mr. Ritter's observation at the start of his questioning, and that is that in fact there appeared to be what I will call a culture change in NASA over a period of several years. During which the successes of the program led to an environment where the determined challenge of each issue was somewhat lessened. While I was not there at the time, I can certainly tell you from experience in other areas that as an activity becomes more successful from an engineering and a management point of view, it certainly becomes more difficult to challenge it, and to raise questions.

I think this has a great implication for the future of NASA, because NASA looks forward to many successes in the future. At the same time it must be able to operate in a very intensely concerned and intensely skeptical mode while it is going through those successes.

Mr. RITTER. Right. If the gentleman would yield back, I would appreciate the quality of the gentleman's line of questioning, but I have been waiting here all day long and we are going to be going to vote. I have another part of my question that I would like to complete. There is another memo here titled "Activity Report," and that is all, and it is again by Mr. Boisjoly and it doesn't say just company, private, but let me quote.

It says, I might add, that even NASA perceives that the team is being blocked in its engineering efforts to accomplish its tasks. NASA is sending an engineering representative to stay with us starting October 14. So it is right in that period of time that my colleague from Pennsylvania talked about. We feel that this is the direct result of their feeling that we, MTI—I am not sure what

that means—are not responding quickly enough on the seal problem.

And so there seems to be some fairly extensive—I don't know how extensive, but there seems to be some conflict between the progress of the Morton Thiokol team and NASA's expectations, at least according to Mr. Boisjoly, and yet when Morton Thiokol comes back and says we are not ready, from our perspective we prefer not to launch, it is NASA which overrides or to some extent calls the shots on Morton Thiokol.

Dr. GRAHAM. That was obviously a long and hard engineering discussion. I believe NASA stated during that in fact NASA would not proceed with the launch or at least the Marshall Space Flight Center personnel would not recommend proceeding with the launch if in fact Morton Thiokol recommended against it. That is not intended to excuse NASA for any responsibility in the situation. NASA clearly bears a major responsibility, but nevertheless it was not NASA's intention nor did NASA override Thiokol. They may have inadvertently biased the Thiokol answer.

Mr. RITTER. Mr. Hardy's comment that he was appalled by Thiokol's original recommendation, and Mr. Reinartz' comment we won't be able to launch until April—were you present when Mr. Hardy mentioned that he was appalled at the initial recommendation of Thiokol?

Mr. MULLOY. Yes, sir.

Mr. RITTER. Were you appalled?

Mr. MULLOY. No, sir, I was surprised at the conclusion drawn from the data, and a 2-hour discussion prior to that I think tended to establish that that conclusion could not be drawn from the data presented.

Mr. RITTER. What is the meaning of the word "appalled" in this case? Does it mean that he doesn't agree with it or he doesn't like it?

Mr. MULLOY. No, sir, I can't speak for what was in Mr. Hardy's mind when he used that term.

Mr. RITTER. Mr. Hardy is not here today?

Mr. MULLOY. He is not here today, but I believe that he had the same feeling that I did, that you just can't reach that conclusion from these data.

Mr. RITTER. The interesting thing was the four people, the four management people who eventually made the decision out of the group of 12 which was in the caucus—and I don't have the list of their names with me at the moment; it is in this pile here. But as I understand it, not one of them was intimately related to the work on the seals.

In other words, the vice president for engineering was not—I guess he was the one who had reservations and the other three were not related to the seal problem. Were you aware that that is how that decision was made, or did you have any idea of the decision process that Thiokol went through to change their mind?

Mr. MULLOY. No, sir, I was not aware at all of that process. As has been testified, we were on mute and it was some 30 minutes and they came back with a rationale for a recommendation for launch. However, after becoming aware through testimony as to who was involved with that, Mr. Kilminster is intimately familiar

with the problems on the seal, he dealt with that in our flight readiness reviews on a number of occasions.

Mr. RITTER. But it has been pointed out by people at Thiokol that the people wanting to develop the solution to the seal were simply not getting cooperation. That kind of bothers me too. Was it Morton Thiokol that was not cooperating to put together the kind of team solution approach? Was NASA involved in that? We had some pretty frustrated engineers testifying this morning that they were trying to push this. Here is a memo saying that NASA is aware of this and NASA knows that the team is being blocked in its engineering efforts to accomplish its task and yet—and yet—

Mr. MULLOY. Let me explain. As I have said, I was not aware of any of those memos or those weekly activity reports or the fact that the reason the work wasn't getting done was because these engineers were frustrated by their own management policies. I was not aware of that. However, we were trying to get an alternate configuration that would improve the margin that we could test on our qualification motor No. 5 originally scheduled to be fired in November. It is a qualification motor for the first Vandenberg launch, a filament-wound case motor, but it has the same joint configuration, the nozzle to case and in the field joints. So around October, I got concerned that the results weren't coming in to allow us to reach a conclusion as to what the configuration that we could put on that QM-5—

Mr. RITTER. Were you expecting those results?

Mr. MULLOY. Yes, sir, we were.

Mr. RITTER. And yet those results were not forthcoming?

Mr. MULLOY. They were not forthcoming. As a result of that, I scheduled a meeting—I can't recall the exact date—in the October-November timeframe and told Thiokol I wanted them to come into Marshall and tell us how they were coming on arriving at a recommended configuration for the equipment for the QM-5 firing.

That meeting did occur, and it became evident that there had not been a whole lot of work done, and again in that meeting the frustrations of the engineers were not being conveyed. It was just simply that the work wasn't getting done. That briefing was given to Mr. Kingsbury and myself and we then provided some emphasis to Thiokol that it was very important that that work get done so we could select a configuration for QM-5.

Mr. RITTER. One last point.

Mr. ROE. The committee will reconvene. The chair recognizes the distinguished gentleman from Pennsylvania, Mr. Walker.

Mr. WALKER. Thank you, Mr. Chairman.

One of the conclusions of the Rogers Commission reads: "The Commission concluded that the Thiokol management reversed its position and recommended the launch of 51-L at the urging of Marshall."

Dr. Graham, do you agree with that Rogers Commission contention?

Dr. GRAHAM. Mr. Walker, my information on that is derivative, basically information I have been told by others who were participating in that, so I am going to ask—

Mr. WALKER. I want an answer from each of the people at the table as to whether or not they agree with that finding of the Rogers Commission.

Dr. GRAHAM. I have no independent information to either confirm or deny that particular statement, so I would only be giving information based on secondary sources that I have. I have not yet found those to be of sufficient specificity that I can give a completely conclusive answer. There was certainly a very active discussion. Much of it, in my view, during the telecon the evening before, was proper engineering and technical probing of the reason the recommendation was put forward.

However, it is possible that that went beyond probing and into a situation that Thiokol interpreted as being an attempt to encourage or otherwise steer them to a specific conclusion. I believe that is the view Thiokol stated, and I understand that is their view of the situation.

Mr. WALKER. I am not worried about what Thiokol is stating. The Rogers Commission conclusions, in all the various phases, is going to be the guidance of where we go from here, and I think that this is a fairly important conclusion given where we are after testimony today, and I am trying to find out whether NASA management, to begin with, agrees with that conclusion of the Rogers Commission, and that is that the position was reversed at the urging of Marshall.

Dr. GRAHAM. Once again, I certainly accept the conclusions and the recommendations of the Rogers Commission.

Mr. WALKER. So you do agree with that?

Dr. GRAHAM. I understand that is their conclusion and accept that as their view of the situation.

Mr. WALKER. What is NASA's view of the situation?

Dr. GRAHAM. NASA certainly—

Mr. WALKER. What is NASA's view of the situation?

Dr. GRAHAM. I am not adding information to the process because I don't have independent information. I am accepting what is being told to NASA by the Rogers Commission.

Mr. WALKER. So you accept the Rogers Commission conclusion that the Thiokol management reversed its position at the urging of Marshall?

Dr. GRAHAM. I accept the conclusion that Thiokol reversed their position, particularly as they determined it to be, at the urging of NASA. I believe that is what was stated there.

Mr. WALKER. It is the conclusion of the Rogers Commission that it took place that way. I am asking whether or not, based upon everything you know, whether NASA has also arrived at that conclusion.

Dr. GRAHAM. I have not independently arrived at that conclusion, but I accept that conclusion of the Rogers Commission.

Mr. WALKER. Admiral Truly?

Admiral TRULY. That is the way I was going to answer it. I accept the conclusion of the Rogers Commission. The commission took all the testimony in closed and open public testimony, came to that conclusion and I accept it. And since it resulted in the most important part of the Rogers Commission report, which was the findings and recommendations, which is what we are using, to

move out on to correct the problems, I see no reason for myself to go further into it than to accept their findings.

Mr. WALKER. Dr. Lucas.

Dr. LUCAS. Based upon my own knowledge, I have no knowledge that NASA did influence Thiokol. I was not in the meeting. I have talked to all of my people who were, and they do not believe that they influenced Thiokol or insisted that Thiokol change their position on the matter.

Mr. WALKER. So you disagree with the Rogers Commission?

Dr. LUCAS. No, sir. I don't have all the information from the Rogers Commission and would not be in a position to disagree with them.

Mr. WALKER. If you don't have it, who does? This is directed at Marshall.

Dr. LUCAS. I believe there are still a few volumes that have not yet been released.

Mr. WALKER. So you are saying that you do accept that conclusion by the Rogers—

Dr. LUCAS. I accept the conclusion.

Mr. WALKER. Mr. Mulloy.

Mr. MULLOY. Yes, sir, I think that is a conclusion that the Rogers Commission drew from all of the testimony. I have not seen all of the testimony. As Dr. Lucas said, there are four volumes yet to be released and I don't know the total basis by which they reached their judgment. I was not aware that I was trying on the night of the 27th to influence Thiokol to reverse their position. However, Thiokol has testified in testimony, that I have seen some individuals felt, that is what they perceived, and I think that is the basis of the Commission's judgment and I have no argument with the Commission's judgment.

Mr. WALKER. So we agree across the table that the commission is right, that Thiokol management reversed its position and recommended the launch of 51-L at the urging of Marshall? We are agreed now across the table that that is in fact what took place?

Dr. GRAHAM. I believe our statement, Mr. Walker, was that we accept that and accept the results derived from that to move forward.

Mr. WALKER. If we are accepting that, if we are accepting that statement, then I want to know how it is that it happens, who at Marshall did that urging?

Dr. GRAHAM. Well, in the first instance, that was a report, as I understand it, by the commission and of a response of the Thiokol Corp. We can certainly describe who was involved in it.

Mr. WALKER. Excuse me, but the Thiokol Co. is out of this at this point. We are dealing with a recommendation and a finding of the Rogers Commission. We have taken testimony from you and Thiokol. They have arrived at a conclusion, and we have a conclusion in place that that happened. Now we want to find out why it happened, how it happened, who did it, is where I am now going. That is my next question.

If we are agreed that that took place, then the real question on my mind is who made the decision that allowed—for example, we had Mr. McDonald before us today who said that at least three different people, employees of Marshall he felt put pressure on him.

Why was that? Who made the decision that those employees should put that kind of pressure on Mr. McDonald?

Dr. GRAHAM. Mr. Walker, we are certainly not disputing either the findings or the recommendations that come from that. However, as has been stated, there are more volumes that we haven't seen, and in addition, this is a perception of the people at Thiokol as then determined by the Rogers Commission. I anticipate that Thiokol and the Rogers Commission would be better prepared to address the specifics of that issue than we would.

Mr. WALKER. Mr. McDonald said something today, earlier, in which he said that he told someone at NASA that if you go ahead with this decision, he wouldn't want to face a board of inquiry about it if something had happened to the shuttle.

Who did he say that to?

Mr. MULLOY. Sir, he said that to Mr. Reinartz and myself after the decision was passed down from Thiokol. He made it in the context that if he was the launch director, because of the situation with the retrieval ships, that he would not launch this vehicle. Although he agreed that there was some question about the recommendations for it not to fly below 53 degrees, and then he went on to say, "If I was the launch director in making this decision," I don't believe that is what he said.

Let me restate. He said, "I would not want to appear before a board of inquiry," and he explained why, that "I had flown this vehicle outside of the propellant mean bulk temperature specification limits."

Mr. WALKER. Now, he said that to people whom he also testified were making statements to him indicating that they wanted this vehicle to fly. For example, at least somebody said to him, "My God, do you want me to wait until April?"

Mr. MULLOY. Yes, sir.

Mr. WALKER. What does that mean?

Mr. MULLOY. I think I said that, and what it meant was that we had flown vehicles successfully and that blow-by was independent of temperature, as indicated by the data, and that there was no correlation with cold temperature.

Mr. WALKER. But the point is that there is a pattern here. Were you feeling pressure from anyone to get that launch underway?

Mr. MULLOY. No, sir, and I do not—again, I did not know that I was applying pressure to anyone else. Mr. McDonald has testified that he felt pressured.

Mr. WALKER. He felt pressure not only from you, but Mr. Reinartz and Mr. Hardy, he said. In other words, everyone that was there from Marshall was evidently putting pressure on him toward a particular decision, and that was to launch.

Now, doesn't that strike you as odd? That he wasn't feeling pressure from one person? He was feeling pressure from all three people. Now, can you understand that maybe he thought a decision had been made even higher up than each of you?

This wasn't isolated according to his testimony earlier today. Now, why was that? What was it that was driving each of the three of you from Marshall to say to Mr. McDonald that you felt that we had to get on and begin flying.

What was driving you?

Mr. MULLOY. Well, sir, I was not aware that I was driven. What I was doing as I have testified before was looking at the data that was being presented. What Mr. Hardy was doing was looking at the data that was being presented. What Mr. Reinartz was doing was looking at the data that was being presented. What Morton Thiokol engineering management was doing was looking at those data. What the engineers at Marshall, if I may finish, sir, what the engineers at Marshall were doing was looking at those data and trying to correlate the data with the recommendations that was being made.

I don't think anyone at the Marshall Space Flight Center was determined to launch that vehicle in an unsafe condition.

Mr. WALKER. But, you see, sure it is hindsight on our part, but when we go back and look at data that you were looking at, it raises questions. Every flight that had been flows below 65 degrees had had erosion. We had the test, and you say that you discounted it because at 75 degrees, you had flown and you had not had a problem, but the fact is that at 75 degrees, it ultimately did seal, but you had 100 percent assurance that at 50 degrees, it didn't seal at all, so that at least that part of the test was valid.

You had a group of conclusions, all of which led to a question of temperature sensitivity, all of which were ignored, in other words, to go ahead and fly, and yet you had testimony earlier today from Morton Thiokol that when they went into that meeting, the engineering meeting, the offline meeting, that no one at that meeting started with the premise that you ought to fly, that they ultimately went back and got convinced that they ought to fly, but there were at least four people even at the end that didn't think they should go, and nobody began the meeting arguing that they should fly.

Now, somewhere along the line, there was a building pressure to do something here that no one was enthusiastic about, at least in the initial instance, and I am trying to determine how that took place.

Mr. MULLOY. Sir, I can give you my perception of that. I don't agree that it was a building pressure. I think that there were insights gained during the course of that 2-hour discussion about the data between the engineers at the Marshall Space Flight Center and the engineers at Thiokol, and the engineering managers who were listening to that discussion.

I believe there was additional insight gained relative to conclusions that one could draw from those data. That is my perception of what happened.

Mr. WALKER. Mr. Chairman, the second bells have rung, thank you.

Mr. ROE. Are you finished?

Mr. WALKER. Yes.

Mr. ROE. We will again, I regret, have to go back and vote. We will recess for 10 minutes. Mr. Walgren, you are up next.

[Recess.]

Mr. ROE. The committee will reconvene.

When we recessed to vote, we were about to call upon our colleague, Mr. Walgren from Pennsylvania.

Mr. WALGREN. Thank you, Mr. Chairman. This whole process of trying to sense responsibility is pretty difficult, and we on the one

hand don't want to be blaming somebody unfairly. On the other hand, it is very important that NASA as an organization change whatever it was that caused this, and I was glad to hear Dr. Graham emphasize the point of skepticism and building in somehow a much different mindset than might be there.

On the other hand, it sure is difficult to sense the real pressure of responsibility. Perhaps it is there, but it is hard for me to sense it, listening to the testimony at these several hearings.

Culture is in a sense something that can't be penetrated. If you can blame something on a culture, there is really no way to go behind that, and I would urge you as NASA representatives not to stop at that point.

We had a world war that somebody blamed on culture, and there was no responsibility. I think somehow that you have to go deeper than that. I wish I could encourage you to do it.

I wanted to ask two avenues that to me seemed to sort of stop in the record. One is Thiokol came to NASA and made a complete presentation, as I understand it, of their apprehension that the O-rings were going to fail, in late August 1985, and the only pickup on that in the report that I see is one memorandum from Mr. Kingsbury saying that he is most anxious to be briefed on the O-ring problem, because it does not seem to appear to carry the priority which I attach to this situation.

And then, that is the end of the formal record that I know of. The truth of it is that the Commission found that just on that presentation to NASA at the highest levels in August 1985, that was enough to stop all flights.

Now, is there some reason other than culture that that didn't stop the flights, and if not, can I urge NASA to pursue whatever the followup on that O-ring presentation of Thiokol's was, because in the lack of stopping the flights, that is what caused the accident, not the temperature on January 27, not the private memo from Thiokol, but the lack of NASA's responsibility, according to the Commission, that on that information alone, no further flights should have occurred.

Is there a quick answer to why the Commission's finding that the flight should have stopped in August 1985, and that everyone had enough information to stop it, why did not that happen?

Dr. GRAHAM. Mr. Walgren, let me ask Dr. Lucas to address that, but before he does, let me just say one quick thing on the culture issue. I come from the private sector. I have been at NASA now about a half a year. I think culture in a corporate sense and in an agency sense is a very specific quantity which permeates the organization, deals with the approach to subjects, deals with whether probing questions are asked, whether issues are challenged, whether people from the top to bottom are put face to face in dealing with issues in the organization.

I think that is something that is under management control from the top of the agency down, and something that is not an ephemeral quantity but something that has to be addressed and controlled, and directed by the top management of the organization.

To me it is a very real quantity.

Mr. WALGREN. And I would like to ask if Dr. Lucas could give that submission to the record because I don't have enough time and I tend to preface things too much.

[The information follows:]

Material requested for the record on pages 230, line 5403 and 250, line 5862, by Mr. Walgren during the June 17, 1986, hearing.

NASA agreed with the conclusion of the Morton Thiokol briefing of August 19, 1985, which concluded that "Analysis of existing data indicates it is safe to continue flying the existing design as long as all joints are leak checked with a 200 psig stabilization pressure, are free of contamination in the seal areas and meet o-ring squeeze requirements."

Mr. WALGREN. The second avenue that I wanted to direct your attention to, and in this I am trying to be constructive in thinking myself about what would I think about if I were in those circumstances, there were recommendations that there be a near-term fix, as I understand it, made by Thiokol, that shims be placed on every flight since August, on the flight after the one that was scheduled to go August 22, 1985, the Thiokol people recommend shimming in every flight thereafter.

In the NASA memos it is picked up. I cannot bring it right back, but there was a recognition that that would be a good thing to do, a near-term fix.

As I understand it, this rocket was not stacked until November 1985. I don't understand why a recommendation for a fix as simple as my own understanding of shimming would be, would not be incorporated in a flight where the rocket is not put together until November 1985, when near-term fixes to a critical problem had been recommended with the intensity that recommendations were made in this O-ring situation.

Is there an answer to why this rocket was not subject to that near-term fix?

Mr. MULLOY. Sir, was that recommendation made in the August 19 briefing? I am not familiar with the recommendation in that timeframe to do additional shimming on the joints.

Mr. WALGREN. Well, what I am basing this on is there was an internal Thiokol memorandum which recommended a near-term fix involving the shims, and then I thought I remembered that being picked up in some of the discussions of NASA people, and I gather that would have been before November 1985, when I understand this rocket was put together.

Mr. MULLOY. Yes, sir. Of course the joints are shimmed now. That was a recommendation that goes back in the pre-1980 timeframe for shims and some of the documentation that was provided the Commission.

Mr. WALGREN. I am looking at the August 22 Thiokol memorandum.

Mr. MULLOY. Yes, sir.

Mr. WALGREN. Where they recommend a maximum shim for a near-term solution be incorporated for flights following STS-27, which is currently at that point scheduled for August 24, and then

I am convinced that somebody in NASA at least was very aware of the ability to do an improvement by increasing the shipping because of the effect that has apparently of increasing the pressure and helping you with the erosion problem.

Mr. MULLOY. Yes, sir. That was discussed in terms of custom shimming, but this recommendation that you refer to here did not come to NASA. I did not receive any recommendation during that timeframe to do custom shimming, and I don't recall that from the August 19 briefing at NASA Headquarters as being one of the near-term recommended fixes. That was a memo from Arnie Thompson to—

Mr. WALGREN. I would hope just in conclusion, Mr. Chairman, that those in charge of this review within NASA be really looking at why there was not better pickup on the August Thiokol report on O-ring seals that would—goes right by any of the questions of who knew what when. Apparently everything necessary was known. There was no pickup. And second, why there was not pickup on this recommendation of the near-term fix, which would also if acted on reasonably promptly change the circumstances of the flight in January, and it would seem from a management standpoint you would be able to see how your organization was operating, and what improvements might be made.

Thank you, Mr. Chairman.

Dr. GRAHAM. We will take that for the record, Mr. Walgren, with your permission.

[The information follows:]

Material requested for the record on page 253, line 5934, by Mr. Walgren during the June 17, 1986, hearing.

Changes to flight hardware designs are not made on the basis of recommendations contained in internal company memos, even where NASA might have a copy of such a memo. Changes require a formal proposal by the contractor and a comprehensive evaluation of the proposed change by NASA.

In our knowledge, no one at MSFC was aware of the Thompson memo. However, ideas contained in that memo were considered for incorporation on a qualification motor (QM-5) which is part of the Filament Wound Case (FWC) program. The larger o-ring was incorporated, the additional shims were not. In hindsight, it is fortunate that additional shims were not incorporated since testing after the accident has shown that the conclusions stated in Mr. Thompson's memo that increasing squeeze is good have been proven to be just the opposite, i.e., too much squeeze is bad.

Mr. ROE. The Chair recognizes the gentleman from Missouri, Mr. Volkmer.

Mr. VOLKMER. Mr. Mulloy, in your early testimony you reviewed going over the level 1 flight readiness reviews that preceded flight 51-L. I don't have the copies of all those, the appendix hasn't been printed yet.

I look forward to it because what I do find within the Commission report is, however, that words like "the condition is acceptable", that this is acceptable. Those were the words used in almost all of those flight readiness reviews?

Mr. MULLOY. Yes, sir; risk acceptable or condition is acceptable.

Mr. VOLKMER. Right.

Mr. MULLOY. Based on our previous experience.

Mr. VOLKMER. And if that is presented to me if I am in higher headquarters, somebody presents that to me, again we are looking at what you are saying and what I am hearing, and what I hear is, well, it is something that you just don't worry about, it is acceptable, and that concerns me, because it also concerns me, Mr. Mulloy—and Mr. Heard is not here—but if at the time on the teleconference when Thiokol made their first presentation with their criteria for not going ahead with the launch, and you and your staff and your people there had said OK, we are going to scrub it, we will go and look at it tomorrow, do you think Thiokol would have turned around and said "No, we are going to go ahead and go and have a little conference of our own, a caucus of our own, to change their mind."

Mr. MULLOY. No, sir; I do not believe they would have done that.

Mr. VOLKMER. I don't either, and that is what disturbs me, because, gentlemen, in answer to your questions by the gentleman from Pennsylvania, you all said that you really didn't know yourself, know whether Marshall turned Thiokol around. It is obvious to me that the attitude and what proceeded with Thiokol, and what occurred during that teleconference, maybe it wasn't said directly but there is no question in my mind that it is there.

I think that Marshall has to accept that responsibility. If you gentlemen aren't going to accept that responsibility, that gives me great concern, great concern for the future for what is going to occur.

Dr. GRAHAM. In fact NASA does accept the responsibility, and accepts the Commission recommendations in that regard. I believe the distinction that was being made was that, as was testified here this morning, or this afternoon rather. As I understand the statement of the NASA engineers involved in that, it was not their intention to transmit the signal to Thiokol that they were being intimidated or otherwise asked to make a decision that was contrary to their engineering judgment. Rather they were being asked to explain the basis for the judgment.

Nevertheless, it is clear the signal was received the other way. That is a very serious problem, and something we have to take every effort to guard against occurring in the future, while at the same time still being able to understand why recommendations are made.

Mr. VOLKMER. And to be honest with you, Mr. Mulloy, do you now feel that temperature has an impact on the operation and the sealing effect of O-rings, lower temperature?

Mr. MULLOY. Yes, sir; I agree with the Commission's conclusions in that regard relative to the failure investigation. They list a number of causes for the failure of that joint, and temperature is listed as a contributing factor and I believe that is correct.

Mr. VOLKMER. What brought you to that conclusion?

Mr. MULLOY. I think the failure analysis done that showed there was a lot about that joint that we didn't understand going into 51-L. We didn't understand the effect of overcompression on O-rings.

What we worried about prior to 51-L was being assured that we did have compression on O-rings. What we found as a result of the failure investigation, that overcompression was also a contributing cause to the accident, in combination with temperature and other factors.

So, I think we know a lot more about that joint today than we did before 51-L.

Mr. VOLKMER. Why didn't we know it beforehand?

Mr. MULLOY. I guess it is difficult for me to answer this way, but I was not smart enough to know it beforehand. The people, Morton Thiokol and the engineers that we have, had been looking at this problem over the last 7 to 8 years. They were looking at the observations and making judgments and making recommendations to continue flying, based on those data, were not smart enough to recommend the additional testing, and the people who reviewed that at levels above me were not smart enough to say that we need to do more than what we are doing.

It is tough for me to say that, but I don't know any other way in hindsight.

Mr. VOLKMER. And the fact that you accepted the data for low temperatures for the DM-4 O-ring at 40 degrees, and the QM-3 at 45 degrees as a model for an SRB for launch purposes—does that today give you any qualm?

Mr. MULLOY. No, sir; it does not. I think that these are flight motors that are in a horizontal position. When the motor is put in the horizontal position it sags about 8 inches, which puts some varying gaps, and so forth, in those joints. When you pressurize the motor for the actual firing, you get the real simulation of the dynamics of what is actually happening in the joint versus a test where you just have two steel platens and you are measuring the resiliency of an O-ring.

I think a full-scale flight motor test at 40 degrees is a more significant data point than a scale test of resiliency of an O-ring.

Mr. VOLKMER. But there had been no leak check on those?

Mr. MULLOY. Yes, sir; they were leak-checked. All static firing motors were checked, and that DM-4 is a flight motor fired with an ambient temperature of 36 degrees, and an O-ring temperature of 40 degrees.

QM-3 was at an ambient temperature of 40 degrees with an O-ring temperature of 45 degrees. There was another set of data that correlated to low temperature that was presented by Thiokol that night. That was the full-scale testing on joint segment field joints that were done with an O-ring that was 5 mills undersized, and a

durometer of 90, the hardness was 90 as opposed to 75, which correlates to the flight O-ring, which has a room temperature durometer of 75. But, that correlates to a 30-degree condition on the motor, so there was significant test data that would indicate that at 30 and 40 degrees, the motor would function.

Mr. VOLKMER. Why would the Commission—maybe we will have to find out something from them. On page 129 of the report, it shows in relation to the demonstration motors and the qualification motors, that pressure and nozzle, it is not applicable.

Mr. MULLOY. STS-4 was lost at sea, sir.

Mr. VOLKMER. I am not saying STS-4, I am saying all the DM's and all the QM's. My copy shows that pressure is not applicable, nozzle not applicable—

Mr. MULLOY. I suspect that that judgment was reached because the practice at Morton Thiokol during that time when the joints were assembled. They went in and looked at the configuration of putty, and tamped more putty into the joint at that time, and I think their judgment was that that invalidated any significance of those test data.

Mr. VOLKMER. In other words, if there is a leak check made then they went in and filled the putty holes?

Mr. MULLOY. That is correct, sir.

Mr. VOLKMER. You don't do that on a flight motor?

Mr. MULLOY. No, sir, we do not.

Mr. VOLKMER. That is what I am—you know, if I could have a little bit, I am very concerned about the, I would say attitude towards this because as one who has tried to be objective in it all the way, I find it—and maybe it is hindsight and not foresight again, but the engineers for Thiokol, not management, but the engineers that raised the question to begin with, I don't believe ever changed their mind about what happened or what was going to happen or the possibility of that happening, and I just think that they raised some very valid points that evening that should have been followed.

Thank you, Mr. Chairman.

Mr. ROE. I thank the gentleman.

The Chair recognizes the distinguished gentleman from Florida, Mr. Nelson.

Mr. NELSON. Thank you, Mr. Chairman.

Dr. Lucas, you have had a long and distinguished career and you have thousands of people that have been working for you and your predecessors who have rendered invaluable service and will continue to render invaluable service, and despite the circumstances, the tragic circumstances that bring us together here over the very serious mistakes that have been made, I do not want to lose sight of the fact of the commendable service that has been rendered from the Marshall Space Flight Center over the years, including the Apollo and the Shuttle Program.

Now, what I would like to talk to you about is, particularly Jack Lee of the Marshall Space Flight Center, was tasked to do the investigation on what went wrong and he told us about a week-and-a-half ago down at the Kennedy Space Center, and it was repeated last week in hearings, that indeed analysis was to have been done down to 31 degrees, that that was a part of the design spec, and we

have—we have checked the documents, we have them here, you have copies, you know what it is, and as far as I can read English, indeed that is what the design specs were. Natural environment down to 31 degrees, and for induced environment down to on the strut 21 degrees, and on the skin at the joint 25 or 26 degrees.

Now, when Jack talked to us at the Kennedy Space Center and then again here last week, he said that they had no evidence that the analysis had in fact been done despite the fact that the certifications or the verification completion notice had been signed before STS-1 and also again before STS-5. This morning when representatives of Morton Thiokol were here, I questioned them as to this, and they stated that they don't read this being a contractual requirement or in case that word would imply something else, that they don't feel that the design specifications required that kind of analysis.

What I would like to glean from you and/or any of your representatives, including Mr. Lee, Mr. Mulloy, anyone, at your pleasure, is if you could share for us what your interpretation of the design specs were.

Dr. LUCAS. Mr. Nelson, I certainly will and then I will ask Mr. Mulloy to amplify that somewhat. My understanding of the specification requirements are exactly as you have presented them and we interpreted when they were certified as having been met by Thiokol, that there was no ambiguity there, that it was 31 degrees, 21 degrees and 25 or 26 degrees respectively. That is a program document. It is imposed upon the contractor for the delivery of that element and it was so certified as having met that.

Mr. Mulloy, you want to talk about the details?

Mr. MULLOY. Yes. I agree with you, sir, in reading that. It is incredible, I think, that there could be any misinterpretation of it. The shuttle program level specification JSC-07700, volume 10, appendix 1010 does contain the natural environment requirements. It shows that requirement clearly for vertical flight for a temperature range of 31 degrees Fahrenheit to 99 degrees Fahrenheit. It also shows the induced environment that says each element of the shuttle vehicle shall be capable of withstanding induced environments imposed during transportation, ground operations, handling and flight operations as specified in appendix 1011.

Then we have taken that and interpreted that into the end item specification to which the solid rocket motor is procured. That specification is CPW1-33, and that interpretation says under natural environment in that specification, that SRM shall withstand the natural environment defined in JSC-07700, volume 10, appendix 1010, which is the 31 degrees for vertical flight.

The induced environment, it says the SRM shall withstand the induced environment thermal or environmental conditions defined in the following document: SD-784-SH-0144. This is the thermal interfaces design data book. This document is required by appendix 1011 of JSC-07700, volume 10.

If one looks at the specification in SD-74-SH-0144, it shows a temperature range for the skin of the SRB for prelaunch condition of 25 degrees to 120 degrees. It further defines what it means by prelaunch condition. It states that the prelaunch—let me read it from the document, if I have it.

Prelaunch, it states:

The prelaunch post-fill surface temperature histories are presented herein for the hot and cold day environment specified in the space shuttle flight and ground system specification JSC-0700 volume 10, appendix 1010.

The key words there are "post fill." That means that the external tank has been fueled. That is not a storage condition, that is clearly a prelaunch condition, and this environment alludes to that prelaunch condition.

It, further, has data included in that document which is the diurnal cycle or the day-to-day temperature swing that goes with the coldest day, so one can then do the analysis that arrives at that temperature. You are correct also in stating that Thiokol certified that the motor was qualified to that document which requires that, and you are also correct in saying that the Government, NASA, and all the reviews that were done by NASA, accepted that certification. There were independent reviews done also of that wherein that certification was also accepted when in fact there is no basis for that certification.

Mr. NELSON. Is the certification to which you refer the verification completion notice?

Mr. MULLOY. That is one, sir. It is also the certificate of qualification where both Thiokol asserts that the qualification requirements have been met and the Government, NASA in this case, also attests that the qualification requirements have been met. So there is a verification completion notice and then there is a certificate of qualification.

Mr. ROE. Would the gentleman yield?

Mr. NELSON. I have a key question.

Mr. ROE. You always have a key question, but he is saying there is no basis for certification. Is that what you said?

Mr. MULLOY. I believe I did say that, and that is in error, sir, because the basis for certification is the military specification for the O-ring which says that the O-ring is capable of operating from minus 30 to 500 degrees. That same military specification goes on to say, however, you must do a specific analysis of the particular application of that O-ring in the environment that it is to be used in for certification.

Mr. ROE. The gentleman from Florida.

Mr. NELSON. Mr. Chairman, what do you want to do? We have a vote.

Mr. ROE. Why don't we vote and return. We have to finish this line of questioning and so we will return in 10 minutes, if they ever decide to finish it.

[Recess.]

Mr. ROE. The committee will reconvene. The distinguished gentleman from Florida will please proceed.

Mr. NELSON. Thank you, Mr. Chairman.

Where we were was we were talking about the question of what was the design specification, and the witnesses had just testified that they thought that the design specification indeed called for the design specification to work for the entire SRM down to 31 degrees and induced temperature in the range of 21 for the strut and about 25 or 26 for the skin near the joint.

Now, the next question is, since you spoke, Mr. Mulloy, about the verification completion and the other documentation that you talked about, qualification, do you have any evidence that indeed the analysis that you make reference to was required by this design specification? Do you have any evidence that in fact that analysis was in fact completed by the contractor?

Mr. MULLOY. No, sir, I do not. Where it showed that the analysis is required, was entered, is that the basis for certification in the military specification for the O-ring from minus 30 to 500 degrees.

Mr. NELSON. Now what you are telling me is that the basis that the Government signs off on this verification completion is solely on the basis of a military specification for the O-ring?

Mr. MULLOY. Yes, sir, because that is the basis that was presented by Morton Thiokol as the basis for certification of that requirement.

Mr. NELSON. But that in reality doesn't have anything to do with the design specification.

Mr. MULLOY. I agree, sir.

Mr. NELSON. So in essence, in the case of STS-1 and STS-5, where the signoff by the Government occurred, that the—that things were verified—we were verifying—we the Government, NASA was verifying on the basis of an incorrect piece of information as to compliance with the design specification. Do you read it that way?

Mr. MULLOY. Yes, sir, I do. I believe that is not a valid basis for certification of that requirement, and I believe the Government review of that failed to recognize that.

Mr. NELSON. On December 8, 1982, when you had signed off the one before STS-5, do you have any recollection as to what was the information upon which you gave that approval?

Mr. MULLOY. Yes, I do. I believe that was the certification review to look at the difference in the lightweight case. That was a lightweight certification to update that, and everything other than the changes in the factor of safety due to the lightweight case and some other things, which I cannot recall, with similarity to the steel case. So my presumption at that time was that the steel case had been certified for that environment prior to STS-1, and there was nothing that caused me to question that when we did the recertification for the lightweight case.

Mr. NELSON. But specifically it had a volume 10 verification requirement, completed one of those, was with regard to the induced temperature?

Mr. MULLOY. Yes, sir, that is correct, and my basis for that was by similarity to the steel case and as it turns out, I was referencing a nonexistent data base.

Mr. NELSON. Well, who in the Government would have considered the design specification to have been certified by considering what you said was the evidence supplied by the contractor, which was the military specification on the O-ring? Who would have considered that?

Mr. MULLOY. Sir, that would have been done through the critical design, first the preliminary design review process, then the critical design review process. What typically is done there is there is a traceability back to the level 2 requirements, and you will find in

that review where this requirement is specifically—there is a big matrix that says requirement certification method, and basis of certification.

You will find that we assemble teams of engineers who look at a particular area. One of them would be thermal, one of them would be structures, one of them would be propellant liners, insulation, et cetera. That team would have looked at this particular requirement, and made a certification that they were complete, based on the certification of the contractor, and then there is a critical design review board that is typically chaired by the project manager, with other senior members, who take a review of what we call RID's, which is review item discrepancies.

If the teams have identified areas where the testing and analysis does not meet the requirements, or where there are design deficiencies in those. So it is a large number of people, and it is a large process that culminates in the critical design review.

Now, in the case of the SRB, I am aware that prior to my time, there was then an independent group that was brought in to look at all the verifications of the solid rocket booster, who relooked at that total thing. So there is a very large number of people who have looked at that and accepted that certification, undoubtedly without penetrating it pretty thoroughly.

Mr. NELSON. Dr. Lucas, let me see if I can summarize this, and you tell me if this is an accurate summary. That now, as you understand the situation, design vehicle on the SRB's, with regard to this temperature requirement, the lower temperature, be it the environment or the induced environment, was not met, and that part of the Government's approval of the specification in the verification completion procedure, of which I have copies of two, STS-1 and STS-5, was an oversight on the part of the Government that in fact the requirement had been met by virtue of being supplied with information that the military specifications of the O-ring were sufficient to meet that requirement.

Dr. LUCAS. Yes, sir, Mr. Nelson; I believe that is essentially correct. I think it should be said that it had not been demonstrated that the specifications had been met, and the Government missed that, and I don't know why other than we didn't penetrate enough.

Mr. NELSON. OK, so we have tragically in hindsight, as we explore this, mistakes by the contractor, of which of course the contractor still, according to their testimony this morning does not, they still don't acknowledge that this is what the contract said or what the design specifications said.

I will take that up, Mr. Chairman, with them directly, again, and I intend that to be my line of questioning in the morning, so if Morton would be prepared for that.

And then second, the mistake in the review process by the Government as to what in fact was required. Now, we know that is what has happened in the past. Now tell us, Dr. Lucas, what is happening in the future?

What are you doing at Marshall to make sure that mistakes like this never happen again, and how is your redesign process proceeding?

Dr. LUCAS. Well, clearly, this is a lesson learned, that we must not allow to happen again, and I cannot understand how it hap-

pened. It is not characteristic of what we have done in the past, and we can't allow it to happen again in the future.

Sometimes I fear that maybe design engineers become too familiar with the hardware, and they make assumptions that probably shouldn't be made. We have discussed at Marshall, on occasion, the possibility of doing our reviews not with engineers but maybe with accountants or auditors, people that are not in a position to make any judgment whatever, but simply read down and say yes, you know, this is what it calls for, and this is what we have got and how do you know that that is what you have got?

I don't know whether that is a practical thing or not. We haven't pursued that far enough, but that is the kind of discussions that are going on presently at the Marshall Space Flight Center, and I am confident in the team at NASA, to make doubly sure that this never happens again.

Dr. GRAHAM. Mr. Nelson, if I could add just a word on that. We are conducting the design review for the solid rocket booster, and in fact, the redesign effort there, with the Marshall team. But in addition to that, augmented by a group of people from both inside and primarily outside Marshall working directly with the Marshall team. In addition, we have a distinguished group of engineers and scientists that have been provided to NASA, reporting to the Administrator, from the National Research Council and the National Academy of Engineering, and I believe the National Academy of Sciences as well. So we have put in a larger hierarchical structure to oversee this particular redesign issue.

But I think your question is a deeper one, and has to do with how we conduct activities on such an unforgiving system as a space transportation system necessarily is. That is a problem that we are going to give a great deal of attention over the next year to make sure that this type of a problem has no more chance of creeping into the system anywhere else than we can humanly prevent.

And Admiral Truly is working on that now in a very determined way. Dr. Fletcher and I are working on that. We recognize that as one of our highest priority issues.

Mr. ROE. The Chair recognizes the gentleman from Pennsylvania, Mr. Walker.

Mr. WALKER. Thank you, Mr. Chairman, and I will be brief.

I just want to tie up one loose end from some previous questioning that I did.

Dr. Lucas, there has been reference before to a meeting that was held in our hotel room at the Holiday Inn about an hour and a half before the crucial teleconference that we have all been talking about took place.

When Mr. Mulloy and Mr. Reinartz consulted with you at that point, did they tell you about Thiokol's concerns, and did they in particular mention that Thiokol's engineers were recommending against launch?

Dr. LUCAS. No, sir. They did express concern. They came to my room and told me that some Thiokol engineers had expressed a concern about the effect of weather on the O-rings, and that they were proceeding to the Kennedy Space Center to conduct a teleconference with Thiokol, and with our people back at Marshall.

I don't believe, and, of course, Mr. Mulloy can testify to this himself, I believe Mr. Mulloy had not been in the earlier conversation with Thiokol, although Mr. Reinartz was there. I think he was learning, along with me, that there was a concern, and I think that is the answer to your question.

Mr. WALKER. OK. Now was there any discussion at all that took place in your room about getting Thiokol to change their mind about recommending a launch the next morning?

Dr. LUCAS. No, sir, not at all. As a matter of fact, I didn't know that Thiokol had a position at that time. The proposition was placed to me that some Thiokol engineers had expressed a concern. They had tried to get information on a teleconference that was a very poor connection. Many people were at their homes, didn't have a good connection.

I did not know at that time that Thiokol had a position, if they in fact did.

Mr. WALKER. There is nothing out of that conversation that Mr. Mulloy and Mr. Reinartz have interpreted as being an instruction to try to get Thiokol to change their minds about this concern they had about launch?

Dr. LUCAS. Not at all. We have never, I have never, and I am not aware of any other official in Government having attempted to override a contractor's objection to a launch.

Mr. WALKER. Thank you, Mr. Chairman.

Mr. ROE. I thank the gentleman from Pennsylvania.

For the record, in the discussion that Mr. Mulloy was giving before, in the answer to Mr. Nelson from Florida, speaking of that certification process, and you, Dr. Lucas, had expressed your concern with that, the question that comes to my mind, as I understand it, there is somewhere between 780 to 800 items in the criticality list, No. 1. Is there any observation from NASA at this point of any of those items having fallen into the same time of ersatz certification, as was referred to before, that we are aware of at this point?

Dr. GRAHAM. Mr. Chairman, as you know, shortly after the *Challenger* accident, we initiated a program which has since been specifically recommended by the Presidential Commission, to go back and look at all of the criticality 1 and 1-R items. I would like to ask Dr. Lucas to address those from the area that Marshall is involved in, but then ask Admiral Truly to address it on a larger scale, since he has the direct line management oversight of all of the space transportation system.

Dr. LUCAS. Yes, Mr. Chairman. The Marshall Space Flight Center has already begun working with our contractors to completely exhaustively review all of our failure modes and effects analysis, our critical items list analysis. This review will be completed with the contractors, will be submitted to a senior board at Marshall for review, and then, in turn, submitted to a senior, more senior program review, so we are going from scratch, as if it had not been done before, redoing it, and any criticality items will have to be verified, any criticality 1 or 1-R, or whatever, has to be verified as if it hadn't been done before.

We haven't found any problems yet. It hasn't gotten too far, but I am not aware of any problems found to date.

Admiral TRULY. I would only make two comments, Mr. Chairman. One is this total program review will take probably through the rest of this year. We do have almost a 3-month head start in it. We have been going about that long.

The other comment that I would specifically make is that this review includes not only the design of critical parts or sections, but the specific question of certification. We are going back to ground zero on each item, and reassessing the logic behind the basis for the certification of the entire list, not only for the solid rocket motor but throughout the system.

Mr. ROE. The Chair recognizes the distinguished gentleman from Missouri, Mr. Volkmer.

Mr. VOLKMER. Mr. Mulloy, as I understand it, back in July of 1985, and perhaps prior to that time, in one instance, launch constraint was imposed because of the O-ring, is that correct?

Mr. MULLOY. Yes, sir, that was after 51 Bravo, when we had extensive damage on the primary seal and some erosion on the secondary seal on the nozzle to case joints.

Mr. VOLKMER. And on what authority or basis did you impose that launch constraint?

Mr. MULLOY. OK, sir. That is part of our problem assessment system that I had described earlier. That system and how it operates, the operating plan for that, is a Marshall document, SE-012082TH, dated March 1981. In that procedure, it tells how the problem assessment system is to operate, and it assigns specific responsibilities to the various elements that operate within that.

The contractor is obligated to report all problems into that problem assessment system, so the contractor made this report on the 51 Bravo nozzle inspection.

At the time the contractor makes that input for the procedure, he enters in the computer form whether or not that is considered to be a launch constraint. When Thiokol submitted this, they submitted it as a "none", under launch constraint it was "none".

Given the seriousness of that problem then, the next step of the procedure that is specified in that document is followed in describing what the responsibilities of the element project manager is. In my case I have two subelement project managers, one for the SRM and one for the rest of the solid rocket booster to whom I have delegated this responsibility. But it specifically states that the level 3 project manager makes the final determination of whether or not a problem is launch constraint, and he makes a determination of changes thereto.

So when we saw that, we considered that that was something that we weren't going to fly again until we understood it. When it went through the review there at the Marshall system, a launch constraint for the next flight was assigned.

After then Thiokol prepared—they did some additional testing to expand the rationale and the basis for why they felt we could continue to fly. Given that observation, and the previous analysis and test had been based on just hot gas impingement to the primary O-ring, and how bad that could be theoretically. Because the limiting time that that flow can continue in the time it takes for the pressure to fill the volume between the putty and the primary O-ring, they expanded that analysis, assuming that the primary O-ring

wasn't there, and included the volume between the primary and the secondary O-ring. That analysis and then some additional testing correlated very well with what they had seen on 51 Bravo, so they came in with a recommendation that it was OK to continue to fly, based on this analysis, and this testing, and the rationale was followed, and Mr. McDonald, I think, spoke to this this morning.

One was that they felt the reason that the primary O-ring had never sealed was that the leak check pressure on that particular nozzle was inadequate to assure a leak check of the primary O-ring, because it was only at 100 lb/in². Tests had determined that it takes at least 150 lb/in² if you have a bad primary O-ring, to be sure that the putty isn't masking that primary O-ring leak. So they had essentially two pieces of that rationale.

One was the next vehicle to fly had been leak checked at 200 pounds per square inch. It had passed that leak check. There was no danger of the putty having masked a bad O-ring. Therefore, the primary O-ring would seal.

However, they further stated then if we are wrong, this analysis and test shows that the maximum erosion that will occur on the secondary O-ring is acceptable, because it is far below the maximum erosion that could be tolerated on that O-ring.

On the basis of that recommendation then, from Morton Thiokol, I then judged that that was a reasonable analysis. I accepted their recommendation. I then reviewed that in the flight readiness review with my boss, the shuttle project office manager at Marshall, at that time was Mr. Lindstrom, subsequently Mr. Reinartz. That was again written in, reviewed at the center board, and that is one of the ones that went all the way up to level 1, because it was a new incident, and on the basis of the acceptance of that I lifted the launch constraint, and then I lifted it for that flight.

We wanted to continue to observe it, so we didn't close it. Because it was an unexplained problem, there was no corrective action taken. The only thing was that we had a 200 lb/in² leak check instead of 100, and the procedure allows you to close those problems and lift launch constraints on the basis of either corrective action such as a design change or an explanation, as was done in this case, that is not expected to occur on the next flight, and that was done for every flight including up to 51-L.

We kept that problem open, because the concern was that the original problem was not solved. We were still seeing O-ring erosion, so I had no intention of closing that problem.

By the way, this is not at all unusual. During that period, you know, that launch constraint was being lifted under this same procedure, launch constraints were being lifted on other elements of the shuttle system.

Mr. VOLKMER. Could you give me a list of those other elements of the shuttle system, not now but in writing?

Mr. MULLOY. For the record, yes, sir.

[The information follows:]

SSME CONSTRAINING PROBLEMS

<u>PAS NO.</u>	<u>CRIT</u>	<u>OCCURRED ON</u>	<u>LIFTED ON</u>	<u>CLOSED ON</u>	<u>PROBLEM DESCRIPTION/CLOSURE DOCUMENT</u>
A02481	1	SSFL	STS-1 STS-2	STS-2	HEAT EXCHANGER LEAK/FAR A018579
A02586	2R	STS-1	STS-1 STS-2	STS-2	CONTROLLER VOLTAGE LOW/FAR A012716
A03777	1	NSTL	STS-2 STS-3	STS-3	HPFTP BLADE FAILURE/FAR A018288
A04621	1	HSL	STS-4	STS-4	SOFTWARE BYPASSES SHUTDOWN STEPS/FAR A005946
A04945	2R	NSTL	STS-4	STS-4	HP0TP TEMPERATURE FID/FAR A006908
A05674	2	HSL	STS-6	STS-6	SOFTWARE OVERWRITE ANOMALY/FAR A004557
A06060	1	KSC FRF	STS-6	STS-6	MCC MANIFOLD CRACK/FAR A011709
A06142	1	KSC FRF	STS-6 STS-7 STS-8	STS-8	HEAT EXCHANGER LEAK/FAR A011736
A06201	3	KSC FRF	STS-6	STS-6	ASI LINE CRACK/FAR A011741
A06206	1	NSTL	STS-6	STS-6	ASI LINE CRACK/FAR A016680
A06220	1	NSTL	STS-6	STS-6	ASI LINE CRACK/FAR A016681
A06225	1	KSC FRF	STS-6	STS-6	ASI LINE CRACK/FAR A011740
A06612	1	CANUGA	STS-7 STS-8 41A 41B 41C	41C	AFV POPPET CRACK/A018503

SSME CONSTRAINING PROBLEMS (CONT'D)

<u>PAS NO.</u>	<u>CRIT</u>	<u>OCCURRED ON</u>	<u>LIFTED ON</u>	<u>CLOSED ON</u>	<u>PROBLEM DESCRIPTION/CLOSURE DOCUMENT</u>
A06512	3	NSTL	STS-8 41A	41A	HPFTP LINER BROKEN/FAR A006677
A07144	1	STS-8	41A	41A	ASI LINE RUPTURE/FAR A014689
A07586	1	NSTL	41C 41D 41G 51A 51C 51D	51D	HPOTP SUB SYNC/FAR A010038
A07835	1	NSTL	41C 41D 41G 51A 51C 51D	51D	HPOTP SUB SYNC/FAR A014818
A07935	2R	41D	41C	41C	CONTROLLER POWER SUPPLY SHORT/FAR A004955
A07936	1	41B	41C 41D	41D	OPB ASI LINE CONTAMINATION/FAR A004957
A07951	1	NSTL	41C	41C	HPFTP DISCHARGE TEMP/FAR A013332
A08018	1	NSTL	41C 41D 41G	41G	HPFTP LINER COLLAPSE/FAR A013338
A08145	2	41A	41D	41D	HPFTP IMPELLER CRACK/FAR A012842
A08186	2	CAI05A	41D	41D	HPFTP IMPELLER CRACK/FAR A015859

SSME CONSTRAINING PROBLEMS (CONT'D)

<u>PAS NO.</u>	<u>CRIT</u>	<u>OCCURRED ON</u>	<u>LIFTED ON</u>	<u>CLOSED ON</u>	<u>PROBLEM DESCRIPTION/CLOSURE DOCUMENT</u>
A0837Q	2	41D	41D 41G 51A 51C	51C	MEVA ABORT/FAR A004987
A08565	1	NS1L	41D 41G 51A 51C 51D 51B	51B	HPFTP IMPELLER CRACK/FAR A013000
A08781	2	NS1L	51A 51C	51C	MANIFOLD/NOZZLE TUBES SEPARATED/FAR A009908
A08994	1	NS1L	51D 51B 51G	51G	HPOTP SUB SYNC/FAR A006798
A09015	3 (MAS 1)	51D	51D 51B 51G 51F 51I	OPEN (NONCONSTRAINT)	GOX CV LEAK/FAR A017445
A09016	3 (MAS 1)	51D	51D 51B 51G 51F	OPEN (NONCONSTRAINT)	GOX CV LEAK/FAR A017446
A09078	1	SSFL	51D 51B 51G	51G	MCC OUTLET ELBOW FAILURE/FAR A015713
A09136	1	SSFL	51G 51F 51I	51I	MCC OUTLET RUPTURE/FAR A006786
A09196	1	51B	51G 51F 51I	51I	HPOTP CHIPPED BLADES/FAR A008530

SSME CONSTRAINING PROBLEMS (CONT'D)

<u>PAS NO.</u>	<u>CRIT</u>	<u>OCCURRED ON</u>	<u>LIFTED ON</u>	<u>CLOSED ON</u>	<u>PROBLEM DESCRIPTION/CLOSURE DOCUMENT</u>
A09302	2R	5JF	5JF 5IJ 6IA 6IB 6IC 5IL	OPEN (6IE)	CCVA SLOW/FAR A010404
A09343	1R	5JF	5IJ 5IJ	5IG	IGNITER FID/FAR A010449
A09354	2R	5IF	5IJ	5II	HPFTP TEMPERATURE SENSOR/FAR A006762
A09365	2R	5IF	5IJ	5II	HPFTP TEMPERATURE SENSOR/FAR A006764
A09366	2R	5IF	5IJ	5II	HPFTP TEMPERATURE SENSOR/FAR A008282
A09385	1R	5JF	5IJ 5IJ	5IJ	IGNITER FID/FAR A010445
A09442	1	5II	5IJ 5IJ	5IJ	IGNITER FID/FAR A008289
A09482	1	CANOGA	5IJ 6IA 6IB 6IC 5IL	5IL	IGNITER INTERMITTENT/FAR A013045
A09530	1	5II	5IJ 6IA 6IB 6IC 5IL	5IL	HPFTP 1ST STAGE NOZZLE CONTAMINATION/FAR A010427

Page 07

B.D. 4200 9155

JUN 26 '88 9:35

SSME CONSTRAINING PROBLEMS (CONT'D)

<u>PALS NO.</u>	<u>CRIT</u>	<u>OCCURRED ON</u>	<u>LIFTED ON</u>	<u>CLOSED ON</u>	<u>PROBLEM DESCRIPTION/CLOSURE DOCUMENT</u>
A09623	1	SSFL	61C 51L	OPEN (61E)	4000 HZ VIBRATION/FAR A010113
A09719	1	CANOGA	61C 51L	OPEN (61E)	HPOTP NO. 4 BEARING SPALLED/FAR A013872
A09720	2R	6JB	61C 51L	51L	HPFTP TEMPERATURE SENSOR/FAR A013550
A09724	1	NSTL	61C 51L	OPEN (61E)	4000 HZ VIBRATION/FAR A009860
A09759	1	NSTL	51L	OPEN (61E)	4000 HZ VIBRATION/FAR A008921
A09876	2R	51L	51L	51L	CCVA FAILED SWITCHOVER/FAR A016629

SRM CONSTRAINING PROBLEMS

<u>PAS NO.</u>	<u>CRIT</u>	<u>OCCURRED ON</u>	<u>LIFTED ON</u>	<u>CLOSED ON</u>	<u>PROBLEM DESCRIPTION/CLOSURE DOCUMENT</u>
A01640	1	STS-2	STS-1	STS-2	PROPELLANT CRACK/MTI REPORTS TMR 12879 AND TMR 13040
A07293	1	STS-8	41A 41B 41C 41D 41G 51A 51C	*51E 51D	NOZZLE EROSION/PROBLEM SUMMARY REPORT FOR DR4-5/23 - TMR 11187-101
A07879	1	REFURBISHED HARDWARE	41C 41D	41G	S&A BB SWITCH CLOSURE TIME/MTI TMR 14217-2
A09150	1R	DN-6	51G 51F 51I 51J 61A 61B 61C	51L	IGNITER GASKET/MTI REPORT TMR 15351
A08698	1	41G	51A 51C 51D 51B 51G 51F 51I 51J 61A 61B 61C 51L	OPEN	OPT TORQUE/OPEN

*CANCELLED

JUN 25 '86 9:56

BLD. 4202 9:58

SRM CONSTRAINING PROBLEMS (CONT'D)

<u>PAS NO.</u>	<u>CRIT</u>	<u>OCCURRED ON</u>	<u>LIFTED ON</u>	<u>CLOSED ON</u>	<u>PROBLEM DESCRIPTION/CLOSURE DOCUMENT</u>
A09288	1R	51B	51G 51F 51I 51J 61A 61B 61C	OPEN	O-RING EROSION/OPEN
*NOT LIFTED FOR 51L					
A09452	1	62A	NONE	OPEN	FWC TEST ARTICLE STA-2/OPEN
A09602	1	51J	61A 61B 61C 51L	OPEN	OUTER BOOT RING/OPEN

*MTI RECOMMENDED CLOSURE - MTI LETTER E100-86-26.

SRB CONSTRAINING PROBLEMS

<u>PAS NO.</u>	<u>GRIT</u>	<u>OCCURRED ON</u>	<u>LIFTED ON</u>	<u>CLOSED ON</u>	<u>PROBLEM DESCRIPTION/CLOSURE DOCUMENT</u>
A00584	1R	VENDOR	---	STS-1	MMM FAILED TO COMMUNICATE DURING IEA TESTING/ BENDIX DR 78410
A01158	1R	VENDOR	---	STS-1	RSS COMMAND DECODER HAD INTERMITTENT FAILURE/ AVCO PROBLEM REPORT AND NSFC FA EC33-80-001
A01209	1R	KSC BENCH TEST	STS-1	STS-1	FAILED IMAGE REJECTION/KSC PR P1400-5683
A01210	3	VENDOR	STS-1	STS-1	D15 MODULE OF MMM DID NOT RESPOND/BENDIX DR 79111
A01211	1R	VENDOR	---	STS-1	PIC HAD SRM IGNITION LOAD TEST FAILURE/ BENDIX DR 79123
A01315	1	NSFC TEST	---	STS-1	HEAT SHIELD - FIBERGLASS CLOTH 1582 HAD STRUC- TURAL FAILURE/SPEC CHANGE - CCBID 583-00-5106
A01410	3	STS-1	---	STS-1	HIGH RESISTANCE ON GROUND STRAP/P1400-5068, CCBD SB 3-00-4812A
A01833	3	VENDOR	STS-1	STS-1	MMM INTERNAL ERROR DETECTED/BENDIX DR 79347
A01853	1	NSFC TEST	---	STS-1	AFT HEAT SEAL CORK DEBOND/NSFC DR 3108
A01854	1	NSFC TEST	---	STS-1	AFT HEAT SEAL CORK DEBOND/NSFC DR 3107
A01902	1R	VENDOR	---	STS-1	APU CONTROLLER VOLTAGE OUT-OF-TOLERANCE/BENDIX DR 79362 WITH FA REPORT EC 430-80-21
A02409	1R	STS-1	STS-1	STS-1	APU SPEED CONTROL VALVE FAILURE/KSC PR P1400-8243
A02410	1R	STS-1	STS-1	STS-1	APU SPEED CONTROL VALVE FAILURE/KSC PR P1400-8244

PAGE 11

BLD. 4200 915B

JUN 28 '86 9:57

SRB CONSTRAINING PROBLEMS (CONT'D)

<u>PAS NO.</u>	<u>CRIT</u>	<u>OCCURRED ON</u>	<u>LIFTED ON</u>	<u>CLOSED ON</u>	<u>PROBLEM DESCRIPTION/CLOSURE DOCUMENT</u>
A02472	3	STS-1	STS-1	STS-1	IEA FAILED CURRENT LEAKAGE/KSC PR PV400-8502
A02858	1	STS-1	---	STS-2	APU GEAR BOX LUBE HAD JELLED/MSFC DR 3473 AND ECM EP33-0440
A04337	1	STS-3	STS-3,-4	STS-5,-6	ACTUATOR ALIGNMENT FAILURE/KSC PR PV401-1401
A04404	1R	STS-3	STS-3,-4	STS-4	RGA C YAW SHRD DID NOT COME ON/KSC PR PV401-1524
A04708	1	STS-4	STS-4	STS-4	ROCK ACTUATOR EMITTING LOUD NOISE/PV401-2110. NOTE: PROBLEM ISOLATED TO GSE.
A04739	1	STS-4	STS-4	STS-4	ACTUATOR EMITTING LOUD NOISE/PV401-2153 NOTE: PROBLEM ISOLATED TO GSE.
A05086	1R	VENDOR	---	STS-6	APU HAD UNDERSPEED SHUTDOWN/USBI-HSV PR SS-0094
A05088	3	STS-4	STS-5,-6	STS-5	SRB SANK AFTER WATER IMPACT (STS-4)/PV100-1248 AND ED 326/12A00011-1/CCRD SB3-00-7650A
A05089	3	STS-4	STS-5,-6	STS-5	SRB SANK AFTER WATER IMPACT (STS-4)/PV100-1249 AND ED 292/12A00012/CCRD SB3-00-7650A
A05276	1	STS-5	STS-5	STS-6	DEFECTIVE HYDRAULIC PUMP/KSC PR PV401-3190
A05433	1	STS-5	STS-5	STS-6	SAFE AND ARM DEVICE SLOW TO ROTATE/KSC PR PV401-3571
A05549	1R	STS-6	---	STS-6	CABLE FAILED MEGGER TEST/KSC PR PV401-3892
A05720	1R	STS-5	STS-5	STS-6	RS RECEIVER HAD INTERMITTENT READINGS/KSC PR PV401-4398

PAGE 2

9188

4200

9157

9157

9157

9157

SRB CONSTRAINING PROBLEMS (CONT'D)

<u>PAS NO.</u>	<u>CRIT</u>	<u>OCCURRED ON</u>	<u>LIFTED ON</u>	<u>CLOSED ON</u>	<u>PROBLEM DESCRIPTION/CLOSURE DOCUMENT</u>
A06518	1R	STS-7	STS-7	STS-7	CABLE CONNECTOR HAD ROUGH EDGES AND BURRS/ KSC PR PY401-6134
A07052	1R	STS-8	STS-8	41A	CABLE FAILED NO-60 PIC RESISTANCE TEST/KSC PR PY401-7178
A07713	1R	VENDOR	---	41B	INTEGRATED RECEIVER DECODER-STAKING COMPOUND OMITTED AROUND TRANSFORMER/CINCHATTI ELEC. PR 4144-61
A09119	1	51B	51B	51B	APU SCRAP HARDWARE INSTALLED/KSC PR PY402-0503
A09809	1R	61C	61C 51L	OPEN	APU - ABORT CAUSED BY RH TILT APU OVERSPEED/ OPEN

ET CONSTRAINING PROBLEMS

PAS NO.	CRIT	OCCURRED ON	LIFTED ON	CLOSED ON	PROBLEM DESCRIPTION/CLOSURE DOCUMENT
A01683	1	STS-1	STS-1	STS-2	BARRY MOUNT HAD EPOXY PRIMER LIFTOFF/MWC CAPS T-009
A02074	1	STS-3	STS-1	STS-2	INSTRUMENT ISLAND GAPS/MWC CAPS T-010
A01667	1	MMF	STS-1	STS-2	LEAKAGE AT LH2 MANHOLE COVER/MWC CAPS S-043
A02228	1	STS-1	STS-1	STS-2	PHENOLIC BLOCK ON CABLE TRAY DEBONDED FROM SUBSTRATE/ MWC CAPS T-017
A02312	1R	VENDOR	STS-1	STS-2	L02 ULLAGE TRANSDUCER HAD CRACKED GLASS INSULATOR/ MWC CAPS E-045
A02506	1	VENDOR	STS-1	STS-2	G02 MIDLINE ASSEMBLY LEAK/MWC CAPS P-038
A02556	1	STS-1	STS-1	STS-2	LH2 TANK ABLATOR PANELS DEBONDED/MWC CAPS T-019
A02535	1R	STS-1	STS-1	STS-2	L02 ULLAGE TRANSDUCER HAD INTERMITTENT SIGNAL/ MWC CAPS E-048
A02667	3	STS-1	STS-1	STS-2	ECCO BOND CRACKS/MWC CAPS T-020
A02948	1	STS-1	-	STS-2	ET-1 TUMBLE SLOW OR NONEXISTENT (REENTRY PHASE)/ MWC CAPS P-039
A03581	1	STS-2	STS-2 -3	STS-5	CRYOGENIC CONNECTOR FAILED TO REMAIN CONNECTED/ MWC CAPS E-051
A03580	1R	MMF	-	STS-2	HOSE CONE FLEX HOSE LEAKAGE/MWC CAPS E-054
A03607	1	STS-2	STS-2	STS-3	CONNECTOR SHIELD-TO-GROUND FAILED RESISTANCE TEST/ MWC CAPS E-057
A03970	1	STS-3	-	STS-3	LH2 VENT/RELIEF VALVE LEAKAGE/MWC CAPS P-041

ET CONSTRAINING PROBLEMS (CONT'D)

<u>PAS NO.</u>	<u>CRIT</u>	<u>OCCURRED ON</u>	<u>LIFTED ON</u>	<u>CLOSED ON</u>	<u>PROBLEM DESCRIPTION/CLOSURE DOCUMENT</u>
A04617	1	MMF	STS-4 -5	STS-6	CONNECTOR NB6GE22-41SXT FAILED TORQUE REQUIREMENTS WHEN MATED WITH BACKSHELL NB-RFT-22/MMC CAPS E-068
A04468	3	STS-3	-	STS-3	TUMBLE VALVE RAIN SHIELD COVER WAS DETACHED/MMC CAPS P-042
A04769	1	STS-4	-	STS-4	L02 FEEDLINE LEAKAGE/MMC CAPS P-043
A04857	IR	MMF	-	STS-4	SHORTED ECO SENSOR/MMC CAPS E-060
A05364	1	MMF	-	STS-6	LOX TANK PRIMER LIFTOFF/MMC CAPS T-030
A05365	1	MMF	STS-5	STS-6	DEFECTIVE SAFETY WIRE - RSS COAX CABLES/MMC CAPS E-061
A05275	IR	MMF	STS-5 -6	STS-7	DEFECTIVE CONNECTOR PIN SOCKET/MMC CAPS E-063
A05941	IR	MMF	-	STS-8	L02 LEVEL SENSOR FAILED RESISTANCE TEST/MMC CAPS E-066
A05942	1	MMF	-	STS-6	CONNECTOR PINS PULLED OUT/MMC CAPS E-067
A05946	IR	STS-6	-	STS-6	WIRE SHORT TO SHIELD HARNESS/MMC CAPS E-068
A06077	IR	VENDOR	-	STS-6	L02 LEVEL SENSOR HAD CRACKED TERMINAL/MMC CAPS E-071
A06195	IR	STS-6	STS-6	STS-7	L02 ECO SENSOR HAD LOW RESISTANCE SHORT/MMC CAPS E-072
A06335	IR	STS-6	STS-7 -8 41A 41B	41C	LH2 100% LOAD LEVEL SENSOR FAILED/MMC CAPS E-073

Page 15

JUN 28 1986 BLD. 4209 9103

ET CONSTRAINING PROBLEMS (CONT'D)

<u>PAS NO.</u>	<u>CRIT</u>	<u>OCCURRED ON</u>	<u>LIFTED ON</u>	<u>CLOSED ON</u>	<u>PROBLEM DESCRIPTION/CLOSURE DOCUMENT</u>
A06655	1R	MMF	STS-7 -8 41A STS-8 41A	41B	RSS CONNECTOR INTERNAL SLEEVE SEPARATED/MMC CAPS E-074
A06816	1R	STS-7	41A STS-8 41A	41B	LH2 ILLAGE PRESSURE TRANSDUCER STUCK/MMC CAPS E-077
A06743	2	MMF	41A 41B 41C 41D	41G	VOIDS IN FOAM/MMC CAPS T-034
A06905	1	MMF	STS-8 41A 41B 41C	41D	STATINS ON LH2 BARREL/MMC CAPS T-035
A06929	1R	MMF	STS-8 41A	41B	ACOUSTICAL FILTER NOT STAKED/MMC CAPS E-076
A07484	1	MMF	41A	41B	IMPROPER THREADS ON CRYOGENIC FEEDTHRU CONNECTOR/MMC CAPS E-079
A07563	1	41A	41B 41C 41D 41G	51A	RSS BATTERY VOLTAGE SENSOR SHORTED TO GROUND/MMC CAPS E-080
A07802	1	41B	41B 41C 41D 41G	51A	DELAMINATION ON CABLE TRAY COVER/MMC CAPS T-040
A07997	1	VENDOR	41C 41D	41G	LO2 LEVEL SENSOR FAILED RESISTANCE TEST/MMC CAPS E-081-2

ET CONSTRAINING PROBLEMS (CONT'D)

<u>PAS NO.</u>	<u>CRIT</u>	<u>OCCURRED ON</u>	<u>LIFTED ON</u>	<u>CLOSED ON</u>	<u>PROBLEM DESCRIPTION/CLOSURE DOCUMENT</u>
A08475	IR	41D	51A 51C 51D 51B 51G 51J 61A 61B 61C 51L	OPEN (61E)	LH2 ULLAGE PRESSURE TRANSDUCER MEASUREMENT ERRATIC/ MHC CAPS E-082 IS STILL OPEN
A08717	1	MAF	51A	51C	WIRE GAUGE MISIDENTIFIED/MHC CAPS E-084
A10051	1	MAF	-	OPEN (61E)	CLIP PARTIALLY SEPARATED FROM AFT DOME/MHC CAPS S-069 IS STILL OPEN
A10060	1	MAF	-	OPEN (61E)	NICKEL PALTING PEELING OFF GH2 GROUND STRAP/MHC CAPS P-054 IS STILL OPEN
A09937	IR	MAF	-	OPEN (61E)	ORIFICE FITTING MISIDENTIFIED/MHC CAPS E-097 IS STILL OPEN
A10000	1	MAF	-	OPEN (61E)	ELECTRICAL TEST EQUIPMENT FAILURE/MHC CAPS E-088 IS STILL OPEN
A10077	1	MAF	-	OPEN (61E)	MOISTURE SEEPING FROM GO2 PRESSURE LINE BELLONIS/ MHC CAPS P-053-1 IS STILL OPEN
A10079	1	MAF	-	OPEN (61E)	DEFECTIVE WELD ON LO2 FEEDLINE/MHC CAPS P-053-3 IS STILL OPEN
A10080	1	MAF	-	OPEN (61E)	LO2 FEEDLINE WAS UNDERCUT AND HAD DEFECTIVE WELD/ MHC CAPS P-053-4 IS STILL OPEN

PAGE 17

JUN 28 '86 9:59 BLD. 4220 9185

Mr. VOLKMER. For the record, I would like to have those. May I continue, Mr. Chairman, just for a few minutes?

Mr. ROE. Yes.

Mr. VOLKMER. Even though then you continued to see erosion of the O-ring, you continued to waive the launch constraint?

Mr. MULLOY. That is correct, sir, on the basis of the rationale or the explanation as to why that was an acceptable risk that was presented to me by Morton Thiokol, reviewed and approved by my management.

Mr. VOLKMER. Is there any reason when this first came up that you put it in the problem assessment system rather than the problem reporting and corrective action system?

Mr. MULLOY. Actually, sir, it is the same thing. I think the problem reporting and corrective action system is the level 2 system that is required by JSC volume 5 in the 07700 series, and as a matter of fact this problem report also went to JSC, into the PRACA system.

Mr. VOLKMER. Was JSC informed of the problem?

Mr. MULLOY. Through the flight readiness review, and through the submission of this problem to the problem tracking system at JSC. I do not know what distribution was made at JSC when it goes down there. The report also goes to the chief engineer's office at headquarters.

Mr. VOLKMER. It is my understanding that we had some testimony earlier from Mr. Aldrich that he wasn't knowledgeable that there was a launch constraint.

Mr. MULLOY. That is entirely possible, sir. I don't know what distribution was made, and I have testified, that it wasn't briefed in the level 2 and the level 1. When I went—

Mr. VOLKMER. That is right.

Mr. MULLOY [continuing]. That we have a problem, the concern is flight safety, the rationale for continuing to fly is this. That was not briefed in the context of this is a launch constraint in the problem assessment system, and it is entirely possible that if that report, whatever distribution is made of that report at Houston, that he might not have seen that.

Mr. VOLKMER. Mr. Graham, do you recognized this as part of the problems of communication that needs to be corrected?

Dr. GRAHAM. Absolutely, Mr. Volkmer. This is a very serious problem in communication. On the one hand the system is in place which is quite extensive, and based on a great deal of history on the subject, and on the other hand we now have a very strong indication. I believe without talking to the recipients, nevertheless a clear instance of the information not showing up in the right form or the right person at the right time, and we have to make sure that does not happen again.

Given the fact that things can go wrong, we have to make sure that there is enough backup in the system, enough capacity, to keep this type of problem from growing to a disruptive dimension.

I believe Admiral Truly has a comment he wanted to make as well.

Admiral TRULY. Yes, I did. I wanted to specifically say that this specific point of the system at the Marshall Space Flight Center, the computer system at the Marshall Space Flight Center, into

which problems are entered and dispositioned and the system at the Johnson Space Center, where the same sort of actions are taken, it is not at all clear to me that the two systems are compatible, and I talked to Mr. Aldrich about that this morning, and assured myself that this, this specific point of the way, not through people but through a system that is required to track all the actions that go into it and out of it, is addressed in our program management review, before we get back to flight.

Mr. VOLKMER. It is possible, as I understand the whole system then, that the launch director would not even know, necessarily, of these launch constraints; is that correct?

Admiral TRULY. As I understand it, and again for the future, I don't see a problem, because we are going to go back to square zero and look at both systems. But as I understand it, at the time of 51-L, if the so-called launch constraint was dispositioned as Mr. Mulloy mentioned, unless someone read the paper that was distributed to level 2 in Houston, or to the chief engineer's office in Houston, it would not have shown up automatically in a single tracking system. We are going to assure in the future that it does. Is that a fair assessment?

Mr. MULLOY. Yes, sir, the report also goes to KSC also. Again, I don't know what distribution is made at KSC of the report.

Mr. VOLKMER. At the time of the flight on January 28, the O-ring problem was categorized at a criticality 1; is that correct?

Mr. MULLOY. That is correct. It was categorized as criticality 1 by the waiver processed in late 1982 and approved here in March 1983.

Mr. VOLKMER. Then I have documents before me that have been issued since then, that shows it as criticality 1R, one dated March 7, 1986, and one February 26, 1986.

Mr. MULLOY. What is the document, sir?

Mr. VOLKMER. Problem assessment system reports, Marshall Space Flight Center.

Mr. MULLOY. Yes, sir, that is an error in the system. It gets into a deeper thing. I don't know whether we have time to go into it here, but let me go back and say that the contractor fills out the data that you see on that problem assessment. He makes the initial recommendation whether it is or is not a launch constraint. He enters the criticality.

As a matter of fact, in the critical items list that Morton Thiokol maintains themselves internally. They are still carrying the joint as criticality 1R, even though there was a change made back in 1982 that changed it to a criticality 1. So what you see on that report—and anybody reading that report, if they looked at all the data and they looked at criticality, they would think that the criticality of that joint is officially 1R.

Mr. ROE. Will the gentleman yield?

Mr. MULLOY. That has been corrected and it now shows it is criticality I.

Mr. ROE. Are you saying that Thiokol's records have now been corrected?

Mr. MULLOY. No, sir, the past report has been corrected. We are in process of going back through a complete review of the criticality items list.

Mr. ROE. I know, but you know what is exasperating after setting here for 14 hours today, and I have been in the executive branch, if I were in charge of this thing and I knew that there is 800 items on a criticality list, any one of which could sink the shuttle, and I knew that, I would tell them flat out that you have got a mistake, get it off there. Do you understand where I am trying to come from. How long does it take for NASA to react? Is that Thiokol's problem, or responsibility, or is it NASA's problem, that one issue alone.

We have already gone through in the last 10 minutes well, that was a mistake and we are not going to let that happen again, and the certification we certified to and here we sit, and I don't mean to be, I really don't mean to be crass or unkind or unfair, but it sure as hell is exasperating, when we have a whole agency with 27,000 people, and doesn't somebody come back and say this is criticality I? How can you carry the one record and they carry it on something else? Is that a stupid question?

Mr. MULLOY. No, sir, that is a valid observation and it pains me very much to tell you what I am telling you, but I am telling it like it is.

Mr. ROE. I appreciate that, and your candor. I have a lot of respect for you but here we are saying—we came back and in summation we said who was responsible, did we test, did we test and know the temperature was going to create a problem. In fact you said that and so did Mr. Boisjoly, no we did not. We are coming back now and saying of the criticality list where the O-rings were involved, they were on your list as criticality No. 1 but Thiokol, who is redesigning them as a team together has 41 people reviewing the issue, are still carrying it on their list as criticality 1R.

How could that happen? The gentleman from Missouri.

Mr. VOLKMER. One question is that it appears to me that as you progressed through the various shuttle flights and as 51-L came up for review and reviewing the approval by Thiokol, it appears to me that you were acquiescing and they were acquiescing that there was almost 100 percent chance that the primary O-ring was going to fail but that the secondary ring would not fail.

Is that a correct assessment?

Mr. MULLOY. No, sir, I don't think I or Thiokol ever considered that there was 100 percent chance that the primary O-ring would fail. We were showing a large substantial margin against what would cause the primary to fail versus what we were observing.

Mr. VOLKMER. You are asserting that there was very little chance then for that primary to fail?

Mr. MULLOY. Our assessment every time was we did not expect the primary O-ring to completely fail, that was even after 51-Bravo where we did observe a primary O-ring had completely failed.

The primary basis for Thiokol's recommendation and my acceptance of that as an acceptable risk was that there was a low probability of the primary ring failing but the tests indicated that if we were wrong, we expected the secondary ring to hold. In retrospect I believe that was a step too far.

Mr. VOLKMER. The findings of the Commission also, you have been asked several of these, Mr. Mulloy, it says on page 148 that prior to the accident neither NASA nor Thiokol fully understood

the mechanism by which the joint sealing action took place. Do you agree or disagree with that?

Mr. MULLOY. I totally agree, sir.

Mr. ROE. The Chair is going to advise the gentleman from Missouri he has 1 more minute.

Mr. VOLKMER. I am just looking for—Admiral Truly, I would appreciate it if you would furnish me a copy of the list of persons and their affiliation that are presently working on the redesign of the joint for the SRB.

Admiral TRULY. Yes, sir, I would be pleased to do that.

[The information follows:]

Material requested for the record on page 292, line 6789, by Mr. Volkmer during the June 17, 1986, hearing at which Dr. Lucas testified.

The enclosed represents the full-time employees for the Design Team as of June 20, 1986. There are others that are devoting partial time to the redesign effort.

Marshall Space Flight Center

J. Thomas	R. Clinton	G. Ross
J. Blair	R. Higgins	J. Aberg
R. Jackson	J. Patterson	J. Phillips
J. Welzyn	J. Turner	R. Tepool
D. Brown	B. Goldberg	C. Vibbart
K. Coates	L. Hediger	C. Davis
R. McIntosh	S. Caruso	J. Ehl
J. Peoples	M. Semmel	J. Ransburg, Jr.
J. Thomas, Jr.	R. Nichols	R. Williams
K. Henson	W. Riehl	B. Tidmore
C. Nevins	W. Goldberg	J. Williams
W. Cobb	F. Ledbetter	B. Henson
P. Munafo	D. Hill	N. Fama
F. Jankowski	L. Jeter	J. Oakley
R. Bell	C. Bianca	A. Adams
F. Douglas, III	V. Richard, Jr.	P. Black
M. Gerry	R. Fisher	W. Simmons
B. Elkins	D. Bacchus	D. McCluney
J. Johnson	F. Bugg	S. Kirkindall
R. Rodriguez	O. Moon	J. Burton
J. Maldonado	A. Kirkendall	E. Donald, III
J. Funkhouser	S. Cash	C. Robinson
W. Ray	T. Kelley	V. Blankenship
L. Powers	S. Lowery	D. Hall
R. Cloyd	G. Lyles	J. Hamilton
D. Cummings	J. Moore	E. Howard
C. Reid	J. Moss	K. Knowles
W. White	R. Porter	K. Luna
T. Bechtel	T. Stinson	T. Smith
D. Davis	G. Swanson	C. Thompson
E. Cross	C. Martin	J. Tunstill
F. Cunningham	L. Craig	E. Wells
F. Dolan	F. Bachtel	M. Wales
D. Moore	D. Davis	D. Hipp
D. Drinan	R. McKemie	K. Carmack
L. Thompson	W. Trewitt	V. Hughey

B. Lang Kennedy Space Center

Johnson Space Center

H. Gibson
M. Brown
E. Schneider
A. Balusek

Langley Research Center

M. Card	W. Elber
R. Wingate	W. Elber
N. Knight	C. Poe
W. Green	N. Gardner
D. Smith	S. Yound
C. Lach	J. Woolsey

PRG Kentron

C. Lock

MICOM, U.S. Army

J. Wright
K. Mitchell

Jet Propulsion Laboratory

N. Kimmel
R. Landel

Air Force Rocket Propulsion Laboratory

L. Tepe

United Space Booster, Inc. - Booster Production Company

J. Greene	H. Dedman	P. Welch
L. Davies	J. Scarpa	R. Barnes
K. Seiler	C. Zyla	M. Adams
M. Mason	C. Reynolds	B. Howard
L. Zook	R. Collie	K. Cosby
R. Britton	L. Clark	S. Breeding
D. Justice	N. Murphy	D. Brown
H. Reed	T. Lin	G. Larsen
R. Rice	P. Potter	E. Ricks
D. Fetters	D. Mayfield	B. Lewedag
J. Franks	P. Clem	W. Martin
J. Brooks	S. Fischer	J. Smith
G. Brooks	R. Baldwin	C. LeMonde
B. Findsen	J. Atkison	H. Garber

McDonnell Douglas Aeronautics Company

T. Whelchel	K. McCarley
S. Walker	T. Menke
M. Hill	A. French
H. Wesch	J. Jimmerson
S. Matharu	M. Huddleston
B. Beck	J. Laux
J. Miele	J. Greenwell
R. Mohler	W. Warren
S. Sherrick	B. Willis
	J. Fowler

Teledyne Brown Engineering

B. Simmons	R. Curtis
F. Laney	J. Daniels
H. Busbin	J. Miller
C. Crossfield	B. Ralph
H. Eddleman	C. Wallace
K. Kittredge	D. Grider
C. Conwill	C. Swanson
M. Henderson	R. Browne
C. Johnson	

CHAM of North America, Inc.

L. Keeton
W. Mahaffey
P. Daley
A. Singhal
F. Owens

SRS Technologies

H. Whitesides

REMTECH, Inc.

R. Bender
W. Crain

Microcraft

D. Castleman
M. Long
J. Verbal
J. Rinehart
S. Harris

PDA

T. Mack
G. Crose
B. Holman

American Automated Engineering

M. Gough
L. Harrigan
C. Hopkins
K. McCafferty

Rockwell, Inc.

L. Sisson
 R. Warren
 R. Lighfoot
 N. Maurer, Jr.
 B. Kilgore
 F. Swisher
 W. Stewart
 G. Riser, Jr.

Lockheed Corporation

A. Johnson
 P. Pinoli
 J. Jentes

Martin Marietta Corp.

R. Lufriu
 W. Cliffong, Jr.
 D. Davis
 C. Kirch
 E. Williams
 J. Stephenson
 J. Geiger

Wyle Laboratories

R. Shavers	A. Peevy
T. Bogart	R. Scates
R. Avery	B. Cannon
R. Abrams	B. Bolton
B. Atkinson	J. Morgan
J. Perdue	M. Kennamer
W. Ben-Sayad	J. Cockburn
M. Sajjadi	J. Foreman
L. Frazier	D. Spires
A. Treece	M. Crosby
M. Tucker	

Morton Thickol/Wasatch Division

E. Dorsey	C. Kennedy	A. McDonald
B. Kuchek	G. Dixon	K. Wilks
L. Bailey	C. Bacon	C. Speak
J. Sucher	F. Brasfield	C. Olsen
H. Money	H. McIntosh	D. Call
W. McCreary	D. Larsen	R. McQuain
L. Bilbao	F. Call	L. Slater
R. Rasmussen	B. Tydeck	G. Caporale
N. Rosseau	S. Marsh	J. Elwell
I. Adams	W. McCreary	D. Harper
K. Crosson	H. Hazelton	B. Russell
B. McDougal	J. McCluskey	G. Stephens
J. Austin	D. Cooper	R. Ebeling
B. Brinton	B. Thompson	A. Macbeth
R. Hyer	M. McIntosh	S. Goleniewski
J. DeCarlo	P. Petty	J. Stoker
T. Gregory	G. Lamere	R. Roth
T. Crockford	C. Oylar	J. Sutton
D. Smith	J. Neale	J. Kapp
D. Ketner	A. Neilson	R. Burrows
M. Richards	K. Speas	J. Henderson
N. Eddy	K. Wollenhaupt	F. Daugh
G. Gorman	S. Hicken	P. Nguyen
R. Perry	L. Green	R. Morstadt
D. Dommasch, Jr.	R. Buttars	L. Gruet
M. Malone	K. Bailey	J. Miller
L. Lyon	M. Salita	M. McFarlance
R. McKinstry	G. Anderson	R. Boisjoly
R. Rose	L. Ting	R. Webster
S. May	A. Thompson	B. Lowe
D. Ferney	S. Stein	F. Couper
K. Sperry	G. Hawklins	C. Johnson
T. Swauger	J. Furgeson	C. Ferrari
G. Hurst	A. Freed	J. Burn
G. Brinkerhoff	G. Throckmorton	N. Longhurst
D. Pulley	R. Mackley	B. Morgan
J. Durtschi	D. Wagner	J. Jampton
B. Aubin	J. Curry	R. Paxton
T. Huffman	D. Brinton	T. Nhan
L. Mcrittrick	R. Wynn	R. Kochel
C. Putnam	J. Brown	C. Johnson
S. Graves	B. Phipps	D. Bright
B. Thompson	D. Compton	M. Ward
M. Sandor	L. Adams	R. Didericksen
S. Kocksiem	D. Crocket	B. Hansen
M. Islovec	D. Buhisv	R. Wilks
V. James	J. Fannesbeck	R. Lange
J. Detrid	J. Oostyen	R. Kirby

H. Conwell	W. Gerhart	P. McCluskey
T. Barfus	L. Wylie	G. Polidori
M. Cox	M. Evans	T. Johnson
M. Behring	J. Hagen	L. Carter
S. Olson	M. Bradford	T. Townsend
D. Thompson	K. Dixon	H. Gittins
P. Kelley	I. Nieto	D. McKinnon
H. Backman	P. Greenhalgh	W. Barlow
J. Lavery	D. Williams	G. Paul
M. Riderhoff	C. Martinez	F. Adams
M. Raule	T. Lindsay	J. Welker
D. Sauvageau	R. Jensen	D. Joos
R. Bell	B. Baugh	I. Black
S. Newlin	J. Jensen	B. Betenson
R. Hancey	S. Moake	R. Manning
K. Larsen	B. Ream	B. Loveland
N. Allen	B. Rose	D. Earl
D. Sebahar	R. Fitz	J. Faust
K. Campion	F. Nielsen	D. Munns
D. Kimmerling	R. Smith	D. Haughley
J. Stotts	B. Ballard	A. Williams
N. Johnson	E. Kopowski	E. Bailey
I. Woodruff	B. Firth	S. Leishman
S. Larsen	C. Olsen	S. Seger
R. Rushton	R. Singleton	C. Jonas
J. Downs	J. Daniels	N. Nelson
R. Anderson	J. Jepsen	J. Christiansen
B. Madsen	B. Deakin	J. Hawkes
K. Leishman	W. Wilson	D. Dowd
J. Garr	G. Naef	T. Nixon
E. Rose	M. Andreasen	E. Nilson
D. Taylor	K. Davis	M. Crittenton
F. Beach	C. Knowles	D. Hazelton
S. Gardner	D. Payne	R. Marble
A. Olsen	C. Johnson	S. Douglas
K. Wakley	R. Purser	L. Wright
C. Hansen	D. Anderson	J. Walker
D. Alger	S. McMurtry	C. Wren
T. Daniels	R. Reeder	F. Ward
D. Nelson	G. Larsen	D. Fisher
J. Shinkle	M. Richards	P. Udy
M. Bennett	B. Lones	S. Antonio
J. Beazer	G. Lasley	R. Garn
T. Baddley	B. Hardman	R. Ash
R. Rhodes	L. McMullins	R. Peterson
K. Phippen	H. Ward	R. Fullmer
J. Hurd	M. Miller	H. Smith
L. Lloyd	D. Davis	R. Oakesen
J. Pettingill	V. Rose	B. Southwick
K. Fowkes	S. Woolf	D. Stander
S. Nielson	J. Fisher	J. Maughan
R. Profaizer	D. Archibald	K. Nebeker

R. Fowkes
 R. Hansen
 K. Rose
 D. Holt
 C. Kawaguchi
 J. Moreno
 T. Davis
 E. Perard
 C. Larsen
 T. Evans
 Q. Eskelsen
 S. Snitker
 T. Mott
 C. Ridenour
 L. Jeppesen
 E. Robinson
 G. Ulloa
 G. Roberts
 V. Nielsen
 J. Peterson
 R. Randall
 M. Nelson
 R. Eggli
 R. Jones
 L. Goodsell
 D. Bell
 D. Francis
 A. Skujins
 R. Anderson
 T. Ambry
 C. Barley

T. Heyder
 J. Warner
 W. Nelson
 R. Grobe
 J. Read
 D. Godfrey
 E. Bilbao
 F. Wilson
 A. Brady
 J. Huffaker
 A. DeHerrera
 B. Okada
 B. Christensen
 L. Scott
 R. Baird
 R. Norman
 R. Borgstrom
 G. Nowak
 L. Westley
 K. Peterson
 A. Sorenson
 A. Bennett
 B. Meyers
 R. Hanson
 R. Whiting
 B. Butler
 G. Hale
 D. Wagner
 K. Barroclaugh
 C. Biere
 D. DeVowe

B. White
 T. Hamilton
 H. Udy
 R. Eames
 G. Harris
 C. Leavitt
 C. Olson
 A. Butler
 R. Lapine
 G. Yates
 A. Stucki
 K. McGill
 A. Garner
 M. Turnbull
 T. Lewis
 B. Tams
 J. Christensen
 J. Fredrickson
 R. Bowman
 G. Pett
 J. Newmyer
 M. Bell
 V. Gibbs
 K. Dye
 C. Jones
 G. Kimber
 M. Jeppson
 D. Weese
 B. Dawes
 E. Batt

Morton Thickel/Huntsville Division

B. Cooley
 B. Stokes
 R. Glick
 T. Bolner
 J. Collingwood
 H. Yell
 D. Woody

Mr. VOLKMER. I did find it—if I could have that 1 minute now.

Mr. ROE. You are as good as I am at stretching out that 1 minute, but go ahead.

Mr. VOLKMER. That is all right.

Mr. ROE. Are you sure?

Mr. VOLKMER. Yes; in the approval from Mr. Joe Kilminster, Mr. Mulloy, it says if the primary does not seat the secondary seal will seat and the provisions above that as I read it, give me the probability that the primary ring is not going to seat. That is on page 97 of the report.

Mr. MULLOY. Yes, sir.

The engineering assessment is that cold O-rings will have increased effective durometer, they will be harder to seat, et cetera. Demonstrated seals threshold three times greater. Those are assertions that the primary O-ring is expected to seat is the way I read that.

Mr. VOLKMER. You read it a little different than I do.

Thank you very much.

Mr. ROE. I want to thank you, Dr. Graham, Admiral Truly, Dr. Lucas and Mr. Mulloy for your candor and patience, and I think you have added a great deal to our deliberations today.

Thank you for being with us. We don't see you being called back tomorrow. We will call you if necessary.

Tomorrow at 9:30 we will call back the witnesses from the Thiokol Corp. to conclude their testimony at 9:30 tomorrow morning. Therefore, the committee stands adjourned and we will meet at 9:30 tomorrow morning.

[Whereupon, at 7:05 p.m., the committee was adjourned, to reconvene at 9:30 a.m. on Wednesday, June 18, 1986.]

INVESTIGATION OF THE CHALLENGER ACCIDENT

(Volume 1)

WEDNESDAY, JUNE 18, 1986

HOUSE OF REPRESENTATIVES,
COMMITTEE ON SCIENCE AND TECHNOLOGY,
Washington, DC.

The committee met, pursuant to adjournment, at 9:30 a.m., in room 2318, Rayburn House Office Building, Hon. Robert A. Roe (acting chairman of the committee) presiding.

Mr. ROE. The committee will come to order.

We want to welcome everyone this morning.

Today we resume the Science Committee's hearings investigating the shuttle *Challenger* accident.

Yesterday we heard from Morton Thiokol and Space Flight Center personnel. These two units are key to the O-ring problem pointed out by the Rogers Commission Report.

But this morning's session we have called back for further questioning and review several of the Morton Thiokol witnesses that appeared yesterday morning. They include Mr. Edwin Garrison, president of the Aerospace Group; Joseph Kilminster; Carver Kennedy; Allan McDonald; Roger Boisjoly; and Arnold Thompson. I think I covered everybody.

Our purpose in further interrogating more carefully each group of witnesses is not only to understand the detailed scenario that led up to the moment when the *Challenger* accident occurred, but more importantly, to see these details comprehensively as they formed a pattern that led up to the judgment to launch.

It will be from this larger perspective we as a committee will need to make its recommendations for changes in NASA's functions and operation that will ensure our space program and our Nation against any future accidents or failure.

We certainly want to thank all of our witnesses for staying over and returning this morning.

Does the distinguished ranking member have any statement to make before we—

Mr. LUJAN. I do not.

Mr. ROE. Mr. Lujan from New Mexico.

Let me for the benefit of the members who are here and others who may be interested, if any member has any statement they want to submit for the record, without objection, I would ask unanimous consent for that approval. And then the third thing is that we plan on concluding hopefully by noontime as far as our wit-

nesses are concerned, which is our goal, and then the committee will stand adjourned at that point.

We plan on reconvening a week from Wednesday, and in reconvening a week from Wednesday, our witnesses that day at 9:30 on Wednesday next morning will be a broad cross section of the astronaut corps going back to the beginning of the program so that we can have a substantive sampling and take advantage of their thoughts and ideas, and get advantage of their input and any recommendations they may choose to make to the committee at that point, plus other questions members will have to ask. That is what our plan is.

And then there is a whole series of additional hearings that will be held in more detail, particularly as we get into the issues of management, which the members are all concerned about, and improvements in the management program, and then, most importantly, from there we will go to the both short- and long-range policy recommendations the committee will be making through the legislative process. And that is where we are coming from.

Now, the chairman has two really short questions to ask before—oh, I beg your pardon. We asked all of the witnesses if you would please rise to be sworn and raise your right hand, all those who will be participating today, and then repeat after me, I, giving your name, do solemnly swear to tell the truth—

[Witnesses sworn.]

Mr. ROE. We thank you, gentlemen.

STATEMENTS OF U. EDWIN GARRISON, PRESIDENT, AEROSPACE GROUP, MORTON THIOKOL CO.; JOSEPH C. KILMINSTER, VICE PRESIDENT; CARVER G. KENNEDY, VICE PRESIDENT, SPACE BOOSTER PROGRAM; ALLAN J. McDONALD, DIRECTOR, SRM VERIFICATION TASK FORCE; ROGER M. BOISJOLY, STAFF ENGINEER; AND ARNOLD R. THOMPSON, SUPERVISOR, STRUCTURES DESIGN

Mr. ROE. The first question that I would like to ask, and I am going to be brief, mercifully brief this morning, was the—in our interrogation yesterday afternoon, in reviewing a number of the items that we were focusing on in the criticality list, Mr. Mulloy made the observation: As far as the O-ring situation was concerned, we were under the impression it had been put back as criticality No. 1. He made the observation, as I recall it, that NASA has listed it as criticality 1 item, but Thiokol is still carrying it as a 1-R item.

Is that correct or incorrect? In other words, we said to them at the time we couldn't possibly understand, with all of the dialog and all of the Commission hearings and this committee's hearings and the Senate hearings, that it is such an obvious point to view that, why wouldn't NASA be telling Thiokol, we don't know why you could be carrying it 1-R when we declared it to be. That is an important point.

Could someone elucidate?

Mr. McDONALD. Yes; at the time of the launch, we were still carrying it as a 1-R—

Mr. ROE. At the time of the launch. He made the point, you are carrying it that way now, is that correct?

Mr. McDONALD. I don't believe we are. The paperwork may not have changed, but we definitely considered it a 1 right now because we are going to fix it anyway. I think it is somewhat academic.

Mr. ROE. I am trying to get someone to say we are either 1-R or we are not. Is it the policy position now, as of this moment, for Thiokol to carry the whole O-ring situation as a critical item 1?

Mr. McDONALD. Since we are in the redesign effort, the criteria for that is it must be a 1-R. We will not accept a design that won't have a 1-R.

Mr. ROE. You are still missing my point. That is, your ultimate goal is a 1-R. Unless I am not asking the question properly—

Mr. McDONALD. If we were to fly the vehicle we have right now, it would be a 1.

Mr. ROE. That is the point I am making. So you consider the vehicle as it is now a criticality item 1, is that correct?

Mr. McDONALD. Yes, I do.

Mr. ROE. That is the way Thiokol is listing it?

Mr. McDONALD. I don't know if we are listing it that way.

Mr. ROE. Mr. Garrison, you are president of that company. Would you please list it that way this afternoon, right now?

Mr. GARRISON. Yes.

Mr. ROE. We are getting into minutia points we shouldn't be getting into, but that is the way it ought to be listed, and your goal is to go to the criticality 1-R when you are prepared with the new design, is that not correct?

Mr. GARRISON. That is correct.

Mr. ROE. Let me ask a second question and then I will defer to the distinguished gentleman from New Mexico.

Mr. Kilminster, in the communication you signed after the caucus meeting and the determination was made to go and to—actually go and fly, is really what it amounted to, there seems to be a little bit of a debate and I just haven't had time this morning to look that up in the Presidential documents that were submitted and whether it is concluded on that document. There seems to be some debate that there was in the orange copy submitted of that memoranda you signed, that was submitted to the Commission, but purportedly on the bottom there is another warning, which the warning reads, and I quote: "Information on this page was prepared to support an oral presentation and cannot be considered complete without the oral discussion."

Do you recall that?

Mr. KILMINSTER. Specifically, I don't recall that, Mr. Chairman. However, I think that was used on a piece of standard form paper and that very likely may have been there.

Mr. ROE. Well, it is there. I am going to develop this further.

What I am trying to get at, while other members are testifying, I am going to look this up as far as the copies of our official documents are concerned from the Commission as to whether or not that warning was there. Because it would appear to me that when you submitted this data or signed this data for NASA, that it wasn't just what was written here, that it warns that the information on this page was prepared, and I am quoting, "to support an

oral presentation and cannot be considered complete without the oral discussion."

Do you follow me?

Mr. KILMINSTER. Yes, sir.

Mr. ROE. That leads to the point of view, who in NASA was privy to the oral part of the discussion?

Mr. KILMINSTER. Those people at NASA that were involved in the oral discussion were those that were on the telephone conference that evening, which included Mr. Mulloy, Mr. Reinartz, at KSC, and a large contingent at Marshall Space Flight Center which included Mr. Hardy and others.

Mr. ROE. What I want to ultimately develop is this document which you signed which everybody agreed was somewhat out-of-the-ordinary situation, was not only the writings alone that were involved but also the oral discussions that took place with members of NASA who knew of the issue involved or the issues involved.

Is that a fair commentary?

Mr. KILMINSTER. That is the intent.

Mr. ROE. We will develop that further.

The Chair recognizes the distinguished chairman from New Mexico, Mr. Lujan.

Mr. LUJAN. Thank you, Mr. Chairman.

I have two questions but I want to move on quickly so everybody has an opportunity to answer the question.

When I asked staff—and probably, Mr. Kilminster, this could be directed to you—when I asked staff about the whole issue of criticality 1 and criticality 1-R and all those things originally I said, let me take a look at a list of what is there. I was really surprised, there was 748 criticality 1 items, 1,600 criticality 1-R items, and they are all kind of treated equally.

Just for the SRB alone, this book, that looks like a ream and a half of paper to me, so it must be maybe 750 pieces of paper there, in addition to the main engine 1 and external tank 1, so let me just refer to this one because this is what Morton Thiokol is concerned with.

Is there some way—it seems to me like if you throw 748 items at me that are really critical, then I am just going to really kind of ignore them because there is so much information there. Either that, or I would start with the first page and look at that and maybe that is not a very important item.

In looking over them, for example, I saw where one of the criticality 1 items, and I marked it over here, is if the external tank, it says, erroneous external tank ring safety system and armed device 1 and 2 caused by electronic circuit failures in the left SRB—what I thought that meant, if they failed to separate, then the external tank could fall and hit somebody on the head on Earth. That is not nearly as important, it would seem to me, as something that would make the shuttle blow up.

Is there some way that an assessment could be made of the possibilities of an accident, first of all, of an accident happening, and secondly, the severity of that happening?

One of the items that I do a lot of work with in the Congress is in the nuclear industry, and they have those scales of probability,

the rasmussen, and probabilities and all that sort of thing, but that doesn't seem to exist in the criticality 1 and 1-R items.

As one of the improvements that we are looking for, is that possible in this program, in this area?

Mr. KILMINSTER. I believe that the criticality assessment program that NASA has is very thorough. The criticality 1 versus 1-R, for instance, means that in our case, in the solid rocket motor, the basic structure, the steel case itself, is criticality 1. That means that if something were to happen to that unit, there is no backup.

Mr. LUJAN. No; I understand that, and because of limitation of time, they'll ring the bell on me. What I am getting at is couldn't we take those 748 items of criticality 1 and say this one is more important and so, therefore, we ought to pay more attention to this one? This is the second most important or dangerous one, rather than saying, all criticality items are not equal is what, I assume that is what—

Mr. KILMINSTER. There is another system called the failure mode and effects analysis system that identifies for each element what the criticality is and what could be expected if that element were to fail. And some of those 700 that you are talking about, for instance, could mean if one failed in the failure mode and effects analysis, then there is no backup. However, the extent that that might affect the vehicle is different, as you suggest.

Mr. LUJAN. Yes; because in that example of the external tank falling and hitting somebody on the head, that is a very remote possibility, and if it did happen, you would kill one person instead of a whole crew.

Mr. McDONALD. I would like to make a comment on that. I haven't read that one, but I don't think that is what they meant by that. Criticality 1 is potentially catastrophic for the shuttle and crew, and what can happen, if you don't separate one of those SRBs when it is supposed to separate, you can lose control of the vehicle, you sure can't make orbit. Too, you are losing the potential of losing the whole works.

Mr. LUJAN. It seems to me like all items are looked at evenly, and somehow we may be able to devise a system where some are more important than others, and those could be identified as this is the first one you look at, and all the way down the line. Anyway, we'll look further into that.

Mr. ROE. Right on target. I thank the distinguished gentleman.

I now recognize the gentleman from New York, Mr. Scheuer.

Mr. SCHEUER. Thank you very much, Mr. Chairman.

Mr. Garrison, yesterday both Mr. Locke and Dr. Lucas stated that because of the \$10 million reduction fee in the Thiokol contract for loss of emission due to failure of the solid rocket motor, there was a strong incentive on the part of Thiokol to fix problems like the O-ring. What would the financial impact to Thiokol be of stopping the shuttle program, let's say, for a year to reengineer some of the systems, to conduct further testing and development?

Mr. GARRISON. Well, we would have an impact. I don't think it would be catastrophic to the company, sir. I would have to go back and get some data and make some estimates of what the production cost versus the research, added research and development cost would be. It would be an impact if that is your question.

Mr. SCHEUER. Yes; I would appreciate if you would do that, and I would ask unanimous consent the record be held open for 1 week or 10 days, or whatever it will take you to get that.

[The information follows:]

Hearing on Investigation of the Challenger Accident
June 18, 1986
House of Representatives
Committee on Science and Technology
Washington, D.C.

Pages 13 and 14:

MR. SCHEUER

"Mr. Garrison, yesterday both Mr. Locke and Dr. Lucas stated that because of the \$10 million reduction fee in the Thiokol contract for loss of emission due to failure of the solid rocket motor, there was a strong incentive on the part of Thiokol to fix problems like the O-ring. What would the financial impact to Thiokol be of stopping the shuttle program, let's say, for a year to re-engineer some of the systems, to conduct further testing and development?"

MR. GARRISON

Well, we would have an impact, I don't think it would be catastrophic to the company, sir. I would have to go back and get some data and make some estimates of what the production cost versus the research, added research and development cost would be. It would be an impact if that is your question.

MR. SCHEUER

Yes, I would appreciate if you would do that, and I would ask unanimous consent the record be held open for a week or ten days, or whatever it will take you to get that."

INSERT

Mr. Garrison. Any response I could give to this question would be speculative. Short of actually stopping the program it is impossible to take into consideration all the unknown factors, things such as length of stoppage, engineering manhours required, technical problems encountered, etc... Without access to this data base we would be unable to provide an accurate response.

Mr. SCHEUER. On August 22, 1985, A.R. Thompson, one of your Thiokol engineers, wrote a memo indicating immediate short-term changes should be made in the joint design to reduce flight risk. This memo was ignored. How much money and how much time and how much in the way of the flight delay penalties would have been involved had you taken the time to do the research and testing that Thompson recommended at that time?

Mr. GARRISON. I am sorry, I really don't understand your question, Congressman.

Mr. SCHEUER. A.R. Thompson recommended in August, right after that August 19 briefing, you remember that August 19 briefing we heard so much about a couple days ago?

Mr. GARRISON. Yes, sir.

Mr. SCHEUER. Immediately after that briefing, when it was recommended that systematic new efforts be undertaken, your A.R. Thompson recommended that changes should be made in the joint design to reduce the risk. As a result of that, that immediate short-term efforts should be made to make changes in that design. It was as a result of the briefing just a couple of days before. OK?

What I am asking you is, in your calculus that led to ignoring, brushing aside his recommendations, what did you compute mentally, what did you crank into the computer as the cost of doing that, both in the out-of-pocket costs of the research, the cost in terms of penalty delays, and the general cost of time lost? How did they size all of those costs, direct and indirect costs, of delay penalties, research, how did you add all of them up, and how did you do your calculus that led you to reject, in effect, the August 19 briefing, the results of that briefing from your own Thiokol engineers and the recommendations a couple of days later, the specific recommendations of A.R. Thompson recommending immediate short-term changes in joint design?

Mr. GARRISON. If I remember, first off, I would like to say that the knowledge of Mr. Thompson's concern didn't get up to the kind of people who make a decision of that type, and I don't think we can do that. I really don't know how to make an estimate, sir—

Mr. McDONALD. I would like to make a comment on that, if I could.

Mr. SCHEUER. You must have made an estimate. If you could have had additional research without cost, without delay, by the snap of the fingers, you would have said, "Sure, let's have this research," it would have been there, but it wasn't without loss of time, it wasn't without investment of money, it wasn't without paying a time penalty.

So all of those things must have gone into your calculus of saying, "No, we are not going to do the research, in effect, we are going to ignore the briefing of August 19." I want to know the thought processes by which you came to the decision not to do the research.

Mr. Chairman, Mr. A.R. Thompson is in the room. I wonder if we could ask him to come to the table.

Mr. ROE. Why don't you join us up here, Mr. Thompson. Were you sworn in, Mr. Thompson?

Mr. THOMPSON. Yes.

Mr. SCHEUER. Maybe I will ask Mr. Thompson. Mr. Thompson, who did you make your recommendation to? Who in the chain of command at Thiokol, perhaps at Marshall, perhaps at NASA-Washington, knew of your concerns, knew of your recommendations, and what to your knowledge was done about them, and what decisionmaking process took place by which your recommendations were turned down?

Mr. THOMPSON. I wrote the memo to a Mr. Scott Stein that was involved in the O-ring team, and several copies of it to several people in the organization. Mr. Stein was involved in project engineering, as well as a member of the O-ring team.

The purpose of the memo is that I was not content with the procedure and how things were going, of course, so I thought we needed to do something more. I became less and less comfortable with flying due to the SRM-22, where we had the 53-degree motor. So I felt we needed to do something to help the resiliency and help reduce some of the blow-by.

Mr. SCHEUER. Who did your memo go to, who in the chain of command going up to you were aware of your memo?

Mr. THOMPSON. Let's see, I believe the head of the O-ring team was Mr. Ketner, and Mr. Boisjoly, and those are some of the ones I remember. Mr. Russell (my supervisor), Mr. Jack Kapp, Mr. Ebling, Mr. McIntosh, Dr. Salita, and Mr. Ketner.

Mr. SCHEUER. Do you have any reason to understand why your recommendation was turned down, not acted upon?

Mr. THOMPSON. No, sir, I don't. But as had been indicated, it did need some research to show that those were the correct things to do, and the two things, of course, were to increase the shim thickness to take some of the rattle out of the joint, and to increase the O-ring diameter.

Mr. SCHEUER. Would the research and development of your fixes have delayed the delivery of the SRM's to NASA?

Mr. THOMPSON. It would have required time to make new shims. It probably would have delayed it 1 month or 2, at least for the hardware and some of the research work would have been necessary to document it, which would have taken additional time.

Mr. SCHEUER. How much of those delays of 1 month or 2 have penalized Thiokol?

Mr. THOMPSON. I am not sure how to answer that, sir.

Mr. ROE. One more answer from Mr. McDonald and the gentleman's time has expired.

Mr. McDONALD. There were things done. In fact, the recommendation Mr. Thompson made was implemented as soon as we could implement it. The larger O-rings were put into the QM-5 test, which was the test we had going into the test bay that very time to find out if those were going to work and improve the situation that Mr. Thompson thought they would.

We acted on that immediately. And since the accident, we are going back and revisiting that, because—and this is a good example of sometimes a short-term solution becomes a long-term problem, is that we found that the increased O-ring squeeze that we got by putting that larger O-ring may not be the direction we want to go. Some of our tests said that is part of the problem.

Mr. SCHEUER. I thank the chairman.

Mr. ROE. The chair recognizes the distinguished gentleman from Wisconsin, Mr. Sensenbrenner.

Mr. SENSENBRENNER. Thank you. I would like to follow up on the line of questioning I tried to develop yesterday before my time expired on what the decisionmaking process was within Thiokol. I think one of the things we are concerned about as a committee is to make sure that the management processes are such that something like this never falls through the cracks again.

Now, as I understand it, based upon yesterday's testimony and the Rogers Commission report is that Mr. McDonald was at the Cape recommending against a launch, Mr. Boisjoly was in Utah recommending against a launch. There was a teleconference on whether to launch between the NASA officials at the Cape and the Morton Thiokol officials in Utah, and then there was a caucus of the Morton Thiokol officials, and a recommendation to launch was made.

Who made that recommendation to launch with the caucus? Did you, Mr. Kilminster?

Mr. KILMINSTER. Yes, sir. I was one of four that made that recommendation.

Mr. SENSENBRENNER. Who are the other three?

Mr. KILMINSTER. The vice president of engineering, Mr. Bob Lund; my immediate supervisor, Mr. Cal Wiggins; vice president and general manager of the Space Division, and his supervisor, senior vice president, Mr. Jerry Mason.

Mr. SENSENBRENNER. Did all of you agree on that recommendation to launch?

Mr. KILMINSTER. Yes, sir.

Mr. SENSENBRENNER. You agreed on that recommendation to launch contrary to the recommendation of your engineers, Mr. McDonald, who was at the Cape, and Mr. Boisjoly, who was at Wasatch—

Mr. KILMINSTER. It was not known to us at that point Mr. McDonald was opposed to the launch.

Mr. SENSENBRENNER. The NASA officials did not communicate Mr. McDonald's opposition to launch to you?

Mr. KILMINSTER. I think that they mentioned that that was discussed after the telecon.

Mr. SENSENBRENNER. Did you ask the NASA officials at the Cape if they had talked to Mr. McDonald, and if so, what Mr. McDonald's opinions were?

Mr. KILMINSTER. No, I did not ask that.

Mr. SENSENBRENNER. Why not?

Mr. KILMINSTER. I believe that at the end of the summary that we gave, after we came out of the caucus, Mr. Stan Reinartz, who was at KSC, along with Mr. Mulloy and Mr. McDonald, asked if anyone had any further comments or considerations to make relative to that recommendation, and none were forthcoming.

Mr. SENSENBRENNER. Yesterday Mr. Mulloy testified that Mr. McDonald did not argue against launch during the telecon and that he sat and listened to the Thiokol people and Wasatch present its arguments. Mr. Kilminster, you had no conversations with Mr. McDonald, who was your representative at the Cape, during the telecon?

Mr. KILMINSTER. No, sir, not specifically, just on the telecon as he was one of the people listening to what was being presented.

Mr. SENSENBRENNER. Mr. McDonald, was your role in the telecon to be seen and not heard or something else?

Mr. McDONALD. No; as I had indicated, I had requested the telecon because I felt it was an engineering decision that had to be made—I requested engineering—analyzed the situation, came back and recommended a temperature we were comfortable to launch with. That was done by the engineers.

The recommendation was done by the vice president of engineering. I had no reason to enter that telecon because I agreed with everything that was said.

Mr. SENSENBRENNER. Mr. McDonald, did you have an opportunity to support Mr. Boisjoly during the telecon?

Mr. McDONALD. Yes, I did.

Mr. SENSENBRENNER. Did you?

Mr. McDONALD. Yes, I did. I made one comment on the telecon relative to the interpretation of the static test data as to whether it showed that the O-rings would operate properly at colder temperatures since the static tests were at cooler temperatures than what we had flown at. The comment I made was I don't feel we can use that data because in those tests we recognized that we were putting blow holes through the putty during assembly and leak check operation, as such—it is much more difficult to assemble in a horizontal position than it is in a vertical. It is harder to keep the putty in the right place. We knew that.

We went in and filled all those holes of putty before we static tested. We didn't do that with the flight motors at the Cape. So I made a comment, "I don't think it is appropriate to use that data."

Mr. SENSENBRENNER. Well, now that we have all of this testimony on the table, I am trying to find out how all of a sudden, the four of you, Mr. Kilminster pulled the rabbit out of the hat and recommended the launch, when the evidence pointed in exactly the opposite direction.

Mr. KILMINSTER. I don't believe all the evidence pointed in exactly the opposite direction. I believe there was inconclusiveness with some of the evidence, and we pointed out that in our rationale, that the—some of the launches that have occurred, lower than 75 degrees, had not exhibited blow-by, whereas we had two, one at 75 degrees, one at 53 degrees that had exhibited blow-by. So there was no correlation there.

In addition, as I mentioned yesterday, we looked at the margin of safety that we had relative to O-ring erosion.

Mr. SENSENBRENNER. One final question. Once a decision like this was made by what I will refer to as the gang of four in Watsch, was that decision reviewed by anybody further up in the Morton Thiokol chain of command, either Mr. Garrison or someone else?

Mr. KILMINSTER. Not to my knowledge. That would have been left up to my superiors to carry that forward.

Mr. SENSENBRENNER. Well, Mr. Chairman, I would just like to make the observation, Harry Truman had a sign on his desk saying "The buck stops here" in the Oval Office in the White House. Obviously, no one at Morton Thiokol had a sign that said "The buck

stops here," and it seems to me that when we are dealing with legislation to try to prevent this tragedy from happening again, we are going to have to be insistent that there be a well-defined chain of command, and I think that the testimony that has come from Morton Thiokol, as well as from NASA, is that there was no well-defined chain of command where the buck stopped, either at Morton Thiokol or within NASA. And I think that an accumulation of those factors resulted in the tragedy.

Thank you, Mr. Chairman.

Mr. ROE. I thank the gentleman from Wisconsin.

The Chair recognizes the gentleman from Florida, Mr. Nelson.

Mr. NELSON. Thank you, Mr. Chairman.

What we are trying to do is establish what in fact happened, what is the truth. A dispute has arisen between you all, Morton Thiokol, and the test of the NASA witnesses from the Marshall Space Flight Center as to their statement to us that analysis was required under the contract. Under the design specifications for the solid rocket motor, analysis, in fact, was required of what the motor would operate like in conditions in an environment down to 31 degrees, and an induced environment on the skin at the joint down to 25 degrees and on the strut down to 21 degrees.

I have reviewed all of these documents, they are clear to me that, in fact, that is what it says, and in your testimony yesterday you disputed that in fact you had such an understanding from the documents. So I questioned at length the people from Marshall yesterday afternoon.

Now, obviously the report of the Presidential Commission points up that all of this tragic mistake in large part has been a communication problem, and human beings make mistakes, and there are communications problems every day. But the fact is our concern is that there still is a communication problem about what the design specifications, in fact, require.

I want to continue now trying to understand what your understanding of these design specs are. Because this item, 31 degrees in a flight condition, as stated in here, and down to 21 degrees, which is a design spec for the strut, is the very linchpin. Had that testing and analysis been done, according to the design specs, it is very likely that everyone would have been alerted in the system with the red flags waving and the launch never would have occurred.

So as the senior officer here, Mr. Garrison, let me go back to the question. What is your interpretation of these design spec requirements?

Mr. GARRISON. Congressman Nelson, as I testified yesterday on your questions, I went back and reviewed the fact that we had taken the specifications and other contractual documentations that we had received after award of the contract, we interpreted those and put them in a plan for a development verification and qualification program, and that plan was approved by NASA, and we proceeded with that, successfully conducted the program. Prior to the first launch, there was a very detailed review of the motor design and if we had met the specifications requirements. I think that there is documentation through the system that says that NASA had the same interpretation as we do—did on this item, that we

were to operate between 40 and 90 degrees and storage temperature was 32 to 100.

Mr. NELSON. All right. I beg to differ with you, not by my conclusions, but by the testimony that has been here——

Mr. GARRISON. Could we refer to a document I think that indicates that NASA did have an interpretation similar to ours?

Mr. NELSON. Please. And, Mr. Chairman, would you enter it into the record as a part of the hearing?

Mr. ROE. Without objection, so ordered.

[The information follows:]

Design Evolution of the Space Shuttle Solid Rocket Motors

Al McDonald

**21st AIAA/SAE/ASME/ASEE Joint
Propulsion Conference**

8-11 July 1985

MORTON THIOKOL, INC.

Wasatch Division

P.O. Box 524, Brigham City, Utah 84302 (801) 863-3511

AIAA-85-1265

DESIGN EVOLUTION OF THE SPACE SHUTTLE
SOLID ROCKET MOTORS

Allan J. McDonald
Director, Space Shuttle SRM Project

Morton Thiokol, Inc.
Wasatch Division
Brigham City, Utah

ABSTRACT

The design requirements established for the development of the Space Shuttle solid rocket motors (SRMs) were very demanding and included three very new and unique features:

- First solid propulsion system to be used for manned space flight.
- Largest solid rocket motor to be flown.
- First solid propulsion system designed to be recovered and reused.

It was these "new" features that dictated that "old" established technology and manufacturing approaches be used in the development of this unique solid rocket motor. High reliability was paramount. This paper discusses the evolution of the Space Shuttle SRMs from the original design flown on STS-1 to the new generation SRM currently under development. This new generation SRM incorporates a graphite epoxy filament wound case (FWC).

INTRODUCTION

Technology selected for the initial design of the Space Shuttle SRM evolved from the successful Minuteman and Poseidon C-3 booster programs. The Stage I Minuteman booster had been operational for eleven years, and the Poseidon C-3 for five years at the time the new SRM development program started in June 1974. The original development program included seven static tests: four development motors and three qualification motors.

This first generation solid rocket motor known as the "Standard SRM" boosted the Columbia into orbit on STS-1 on 12 April 1981 (Fig. 1) and flew on the first five Shuttle flights. The need for more payload resulted in reducing the steel case weight by 4,000 lbm which increased payload capability by 700 lbm for STS-6 and STS-7.

Further improvement in performance was obtained in the flight of STS-8 on 30 August 1983; this flight included the new high performance motor (HPM). The HPM provided 3,000 lbm more payload; performance was increased with a change in the nozzle and inhibitor pattern on the propellant grain. This improvement in the basic SRM was qualified with two static tests of the HPM prior to the first flight. A new generation SRM is currently under development to provide an additional 4,600 lbm payload to polar orbit from the new Air Force Space



Figure 1. First Launch of the Space Shuttle Columbia on STS-1 (12 April 1981)

Shuttle launch complex at Vandenberg Air Force Base (VAFB) in California. This new SRM incorporates filament wound case (FWC) segments made from a graphite epoxy composite. This new generation FWC-SRM is indeed a pioneering effort. The 146 in. diameter by 26 ft long graphite cylinders are the largest graphite structures ever fabricated and will be the first graphite rocket motor cases to be flown by the USA on any solid rocket propulsion system. The development of the FWC-SRM includes three static tests (two development and one qualification motor). The first FWC-SRM static test (DM-6) was successfully conducted at the Wasatch Division of Morton Thiokol at Brigham City, Utah on 25 October 1984 (Fig. 2). The second development motor test (DM-7) was successfully conducted on 9 May 1985 with a final qualification test (QM-5) scheduled for September 1985. First flight is scheduled from VAFB in early 1986.

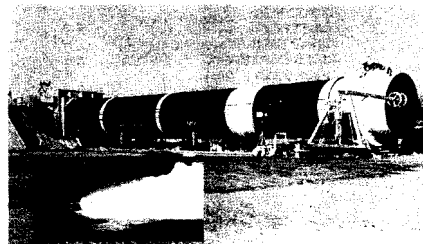

Figure 2. First FWC-SRM Static Test at Morton Thiokol/Wasatch Division

DESIGN EVOLUTION

Conservative structural and thermal design factors of safety were initially imposed on the SRM to withstand the transportation, flight, water impact and recovery environments (Table I). These high safety factors are consistent with manned flight operations. Recovery, refurbishment, and reuse of many SRM components resulted in unique design requirements to withstand water impact, salt water corrosion, numerous refurbishment cycles, and multiple operational uses. The use of established materials and proven design concepts and manufacturing approaches minimized technical risk while providing schedule assurance at minimum cost (Ref. 1). The analytical design ablation factor of 2.0 was later reduced to 1.5 based upon a data base established from full-scale SRM test firings.

TABLE I
SRM SAFETY FACTORS AND
ENVIRONMENTAL REQUIREMENTS

STRUCTURAL SAFETY FACTORS	
• PRIOR TO SEPARATION	1.4
• AFTER SEPARATION	1.25
THERMAL SAFETY FACTORS	
• ABLATION	2.0
• CHAR	1.25
ENVIRONMENTAL REQUIREMENTS	
• STORAGE TEMPERATURE	32° TO 95°F
• OPERATING TEMPERATURE	40° TO 90°F
• MAX CASE TEMPERATURE (REENTRY)	500°F
• MAX ACCELERATION LOADING	
• TRANSPORTATION	± 2.6g
• FLIGHT	3g
• WATER IMPACT	~20gs

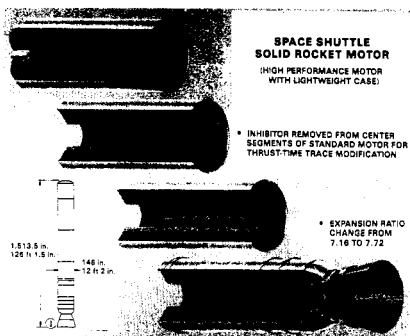

Figure 3. SRM Casting Segments

Propellant/Liner/Insulation

Eighty-six percent solids polybutadiene acrylic acid acrylonitrile terpolymer (PBAN) propellant was selected for the SRM based upon extensive experience with this same basic propellant in the Minuteman and Poseidon C-3 booster programs which produced over 200 million pounds of this propellant. The Shuttle SRM formulation (TP-H1148) is nearly identical to the propellant used in the Poseidon C-3 first stage motor; propellant formulation and properties are shown in Table II. Over 70 million pounds of the Shuttle SRM propellant (TP-H1148) have been processed to date.

Each SRM consists of four casting segments (Ref. 2), i.e., a forward segment, two center segments and an aft segment (Fig. 3). The forward segment contains an 11-point star grain configuration in the headend which transitions into a tapered cylindrical perforate (CP) grain design (Fig. 4). The remaining three segments contain simple tapered CP grain designs; the two center segments are

TABLE II

TP-H1148 PROPELLANT FORMULATION		PROPELLANT MECHANICAL PROPERTIES	
MATERIAL	WEIGHT (%)	UNIAXIAL PROPERTIES	74°F
HB POLYMER	14.0	MAXIMUM STRESS (PSI)	113.0
ECA TYPE II		STRAIN AT MAXIMUM STRESS (%)	36.9
ALUMINUM (NONSPHERICAL) (25 μ)	18.0	STRAIN AT CRACKING (%)	48.4
IRON OXIDE TYPE II	0.3	MODULUS OF ELASTICITY (PSI)	518
AP (GROUND ~ 20 μ)	69.7		
AP (UNGROUND)			

PROPELLANT CHARACTERISTICS

BURN RATE AT 1,000 psia (r_b)(in./sec)	0.435
BURN RATE EXPONENT (n)	0.35
DENSITY (LBM.IN. ³)	0.064
TEMPERATURE COEFFICIENT OF PRESSURE (Π_p)(%/°F)	0.11
CHARACTERISTIC EXHAUST VELOCITY (C*)(FT/SEC)	5,062
ADIABATIC FLAME TEMPERATURE (°F)	6,092

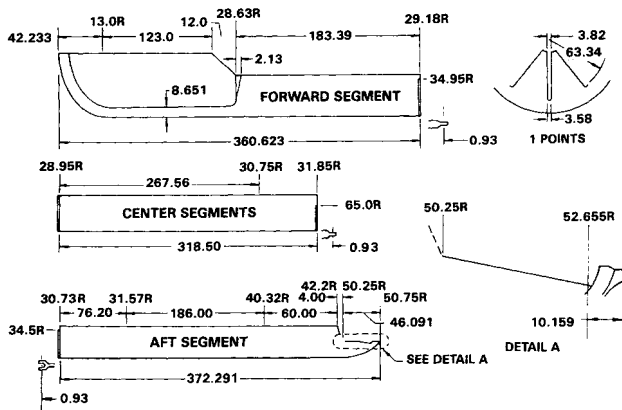

Figure 4. HPM Grain Configuration

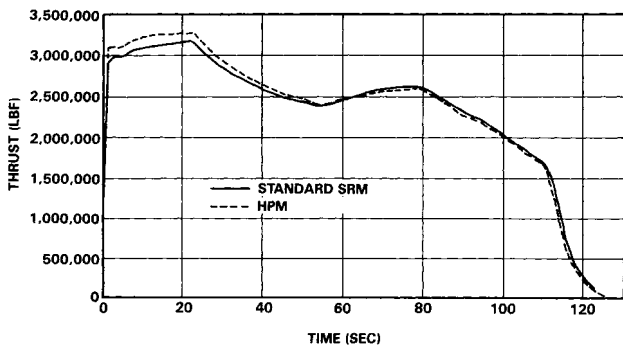

Figure 5. Thrust-Time Comparison, Standard SRM vs HPM

identical and interchangeable. This grain design results in a volumetric loading density of 80.5% with a propellant web fraction of 57.6%. Maximum induced grain strain is 21.9% at the fin to CP transition in the bore. Inhibiting is used on both exposed propellant surfaces at each segment joint to achieve the desired thrust profile shown in Fig. 5.

An asbestos/silica filled nitrile butadiene rubber (NBR) insulation was selected for the primary case insulation, stress relief flaps on the end of each segment, and full web propellant inhibitors on the forward faces of the propellant grains. This same insulation was used in the Minuteman and Poseidon C-3 boosters. A layer of carbon fiber filled ethylene propylene diamene monomer rubber

(EPDM) is used for added erosion resistance in the aft dome and under stress relief flaps of the aft segment and both center segments. Carbon fiber filled EPDM was developed under the Trident I C-4 program. The insulation design for the HPM is shown in Fig. 6. The Shuttle SRM also uses the Poseidon C-3 asbestos-filled carboxyl terminated polybutadiene (CTPB) liner; a modification of this liner is used as an inhibitor on all aft propellant faces. The high performance motor (HPM) removed most of the castable CTPB inhibitor on the aft propellant face of both center segments as shown in Fig. 7 to provide an increase in the initial burning surface to provide higher thrust during the initial portion of the burn (Ref. 3).

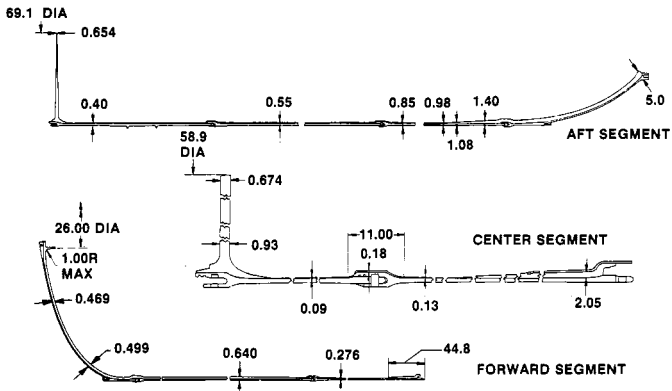

Figure 6. HPM Insulation Design

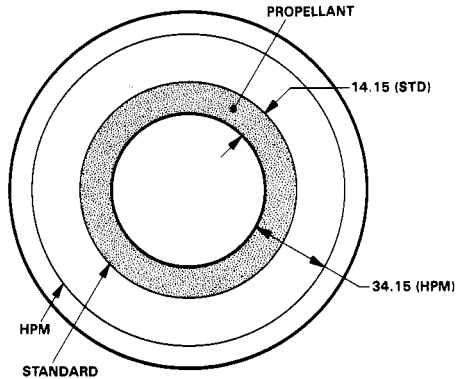

Figure 7. Center Segment Propellant Inhibitor Patterns

Ignition System

The SRM ignition system is mounted internally in the forward casting segment. The ignition system shown in Fig. 8 consists of the following elements:

Safety and Arming (S&A) Device - A reusable actuating and monitoring (A&M) assembly and an expendable booster-barrier assembly containing a mixture of boron potassium nitrate pellets and granules. The S&A device is an electro-mechanical system designed to preclude inadvertent ignition and insure positive ignition when required through the use of redundant NASA standard initiators (NSIs).

Ignition Initiator - A small, multinozzled steel cased rocket motor containing 1.4 lb of fast burning propellant in a 30-point star configuration. The

igniter initiator is ignited by a pyrotechnic charge in the booster-barrier assembly.

Igniter - An insulated reusable D6AC steel case containing 137 lbm of fast burning PBAN propellant in a 40-point star grain configuration. A molded silica phenolic throat insert controls the pressure in the igniter and directs the igniter plume to the main SRM propellant grain. The pyrogen ignition system used in the SRM is a scaled version of the Minuteman ignition system. The ignition system has not changed since its original development.

Nozzle

The SRM nozzle shown in Fig. 9 is an omniscient movable nozzle. The nozzle consists of aluminum and steel components insulated with carbon cloth

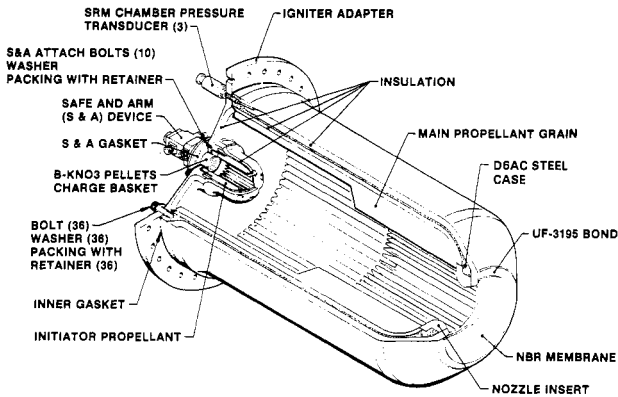

Figure 8. SRM Igniter

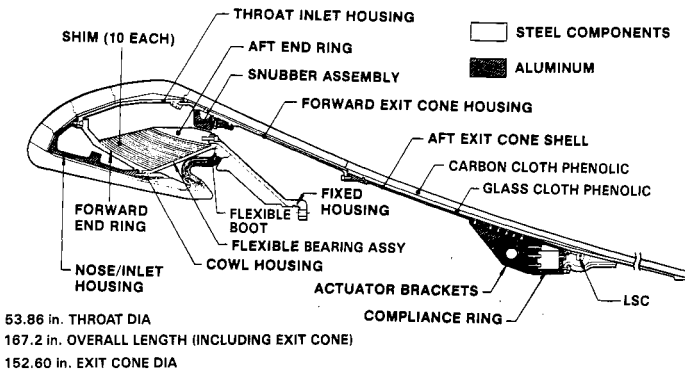

Figure 9. SRM Bolt-On Nozzle

phenolic ablation material supported on glass cloth phenolic throughout the nozzle. Approximately 20 percent of the nozzle is submerged inside the aft motor case. The exit cone contains two sections to facilitate shipping and handling. The exit cone extension is assembled to the nozzle after assembly of the aft skirt to the solid rocket booster (SRB). The exit cone extension contains a linear shaped charge (LSC) which severs the exit cone after SRB separation to minimize structural loads on the SRB during water impact. The nozzle contains a flexible bearing capable of 8 deg deflection for thrust vector control (TVC). The flexible bearing consists of ten layers of D6AC steel shims sandwiched between eleven natural rubber pads. The SRM nozzle with the flexible bearing is a scaled version of the Poseidon C-3 booster nozzle. The SRM nozzle contains a unique snubber device to reduce nozzle damage during water impact. The snubber device, positioned on the exit cone steel structure, permits vectoring but bottoms out on the bearing aft end ring at water impact to prevent forward motion of the nozzle. The

high performance motor (HPM) uses the same basic nozzle but reduced the throat diameter by 0.57 in. and extended the length of the nozzle by 10.46 in. to increase the initial expansion ratio from 7.16 to 7.72.

Case

Case sections are roll formed from D6AC steel forgings, the same material that was used in Stage I Minuteman motors. The 146 in. diameter motor case consists of eleven weld-free sections; the ends of each segment are machined to form tang and clevis joints as shown in Fig. 10. Each joint is fastened with 177 steel pins. The pins are held in place with spring clips and a steel retention band around the joint circumference. Each insulation joint ahead of the O-ring seals is filled with an asbestos filled zinc chromate putty during assembly for thermal protection of the O-ring seals. Each joint is sealed against pressure leaks with two fluorocarbon elastomer O-rings installed in machined

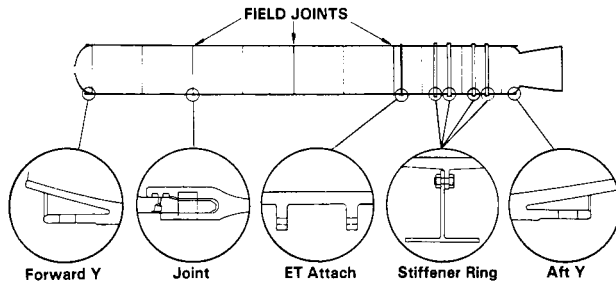

Figure 10. SRM Case

grooves in the clevis. A leak check port is located between the O-rings to check the redundant seals during assembly operations. Each case is designed for 20 uses; therefore, in addition to normal strength criteria, fracture mechanics and environmental effects were carefully considered in the design along with nondestructive testing. Case acceptance criteria include minimum fracture toughness as well as normal tensile properties (Table III).

TABLE III
D6AC PROPERTIES

ULTIMATE STRENGTH	195,000 psi
YIELD STRENGTH	180,000 psi
FRACTURE TOUGHNESS	90,000 psi $\sqrt{\text{in.}}$

The six cylindrical segments, attach segment, and two stiffener segments are roll formed from ring rolled forgings. The ribs on the attach segment for attachment of the SRB to the external tank (ET) attach ring and on the stiffener segments for attaching stiffener rings required to resist water impact loads are integrally formed during case roll forming and machining operations. Nominal case wall thickness is approximately 0.5 inch. The forward case segments have remained unchanged but the center and aft segment sections were reduced in thickness and weight for the HPM.

The new filament wound case (FWC) contains graphite epoxy cylindrical sections with D6AC steel end rings on each composite cylinder. The FWC uses the HPM D6AC steel end domes and ET attach section. The resulting case weight is reduced by approximately 28,000 lbm. The steel attach rings are attached to the graphite epoxy with a double staggered row of steel pins (132 pins per row) held in place with Kevlar retention bands. The metal to composite joint contains redundant and verifiable O-ring seals. The field joint between each casting segment is similar to the HPM as shown in Fig. 11. Stiffness of the graphite case was of primary concern. Results from the first two static tests indicate the case behaved as expected; average case sag for the horizontal static test was 6.12 in. compared to 3.37 in. for the HPM. As noted in Table IV, the DM-6 and DM-7 case growth data was well below the design requirements. Overall bending stiffness (E_t) of 10.4×10^6 lb/in. was about 20% less than predicted and lower than the nominal

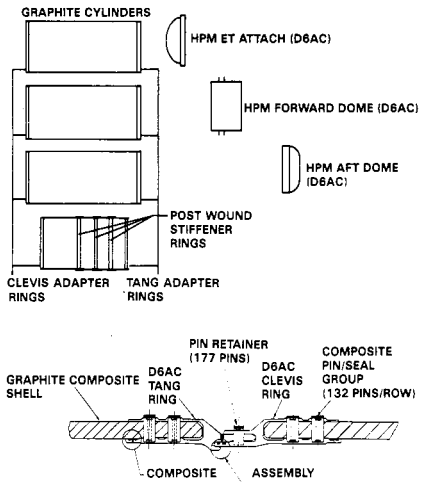

Figure 11. FWC-SRM Case Segments

TABLE IV
SRM STIFFNESS CHARACTERISTIC

	REQUIREMENT	FWC (DM-6/DM-7)
OVERALL AXIAL GROWTH AT MEOP (in.)	0.60	0.37/0.46*
RADIAL GROWTH AT FORWARD SEGMENT AT MEOP (in.)	0.66	0.60/0.58*
BENDING STIFFNESS (E_t , lb/in.)	10.6×10^6	10.4×10^6

*SCALED TO MEOP FROM MEASURED DATA AT 935 psi

requirement of 10.6×10^6 lb/in. (66% of steel case) due to joint bearing compliance. The FWC contains 22 helical layers of graphite filament for stiffness and 19 to 22 alternating hoop plies (depending on segment location due to pressure drop down the grain) for pressure vessel performance (Fig. 12). Nonstructural graphite cloth broadgoods are used on the internal surface for mandrel removal and for abrading prior to insulating. Additional layers of graphite broadgoods are used in the joint ends to increase joint strength and improve joint shear capability. A hoop wound glass overwrap is used on the joint ends to provide a machining surface for end ring attachment. The aft segment contains three postcure wound graphite composite stiffener rings to prevent collapse of the aft segment during water impact.

The FWC-SRM also uses a new systems tunnel fabricated from a molded polyurethane foam core with an aluminum cover. The systems tunnel or raceway is bonded to the FWC and contains all electrical cables and a linear shape charge (LSC) for motor destruct. The new foam core systems tunnel is 200 lb lighter

than the current all aluminum systems tunnel and has a much lower aerodynamic profile than the current design as shown in Fig. 13. The new systems tunnel requires less closeout of external insulation after cable installation and will be used on future HPM's as well as FWC-SRMs.

MOTOR PERFORMANCE

The HPM configuration is shown in Fig. 3. The HPM is 146 in. in diameter, 126 ft long, contains 1,110,136 lbm of solid propellant and weighs a total of 1,255,750 lbm. Mass properties of the HPM are presented in Table V. The nominal action time is 123 sec, and the HPM delivers an average thrust of 2.59×10^6 lbf, maximum vacuum thrust is approximately 3.31×10^6 lbf. The motor delivers a vacuum specific impulse of 267.3 sec with an initial nozzle expansion ratio of 7.72. Nominal burn rate is 0.368 in./sec at 60°F at a motor operating pressure of 625 psia. Maximum expected operating pressure (MEDP) is 1,016 psia. The ballistic performance of the HPM and FWC-SRM are basically the same; the

**TABLE V
HPM MASS PROPERTIES**

ITEM	FORWARD SEGMENT	CENTER SEGMENT(2)	AFT SEGMENT	TOTAL SRM
CASE	26,226	21,387	28,576	97,538
INSULATION	3,907	2,400	9,963	18,870
LINER	345	321	361	1,346
INHIBITOR	284	560	521	1,865
IGNITER INERTS	463	--	--	463
NOZ. FWD SECT.	--	--	17,160	17,160
NOZ. PLUG	--	--	80	80
SYSTEMS TUNNEL	131	129	144	533
INSTRUMENTATION	5	5	4	9
EXTERNAL INSUL	61	44	107	258
PROPELLANT - Mtr	301,639	272,754	262,989	1,110,136
PROPELLANT - Ign	137	--	--	137
SUBTOTAL (lbm)	333,166	297,575	319,875	1,248,191
			TOTAL SRM	
ITEMS SHIPPED SEPARATELY				
AFT EXIT CONE				5,883
EXIT CONE SEPARATION SYSTEM				250
STIFFENER RINGS				843
ATTACH PROVISIONS (TOTAL)				537
MISCELLANEOUS				36
SUBTOTAL (lbm)				7,569
TOTAL SRM (lbm)				1,255,750
MASS FRACTION				0.984
BURNOUT WEIGHT (lbm)				136,235
PREFIRE CENTER OF GRAVITY (IN. FROM IGNITER BOSS)				684.3
BURNOUT CENTER OF GRAVITY (IN. FROM IGNITER BOSS)				823.6

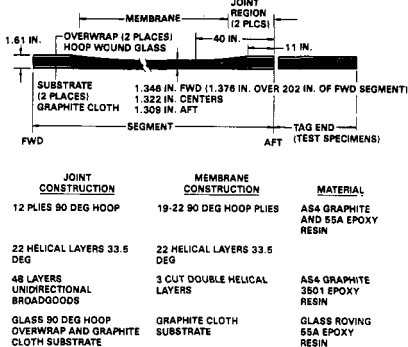
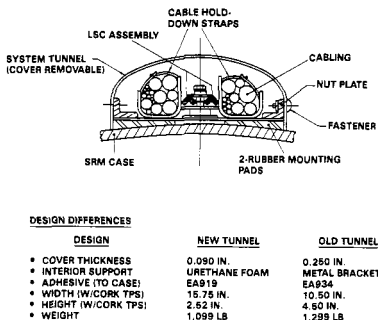

Figure 12. Typical Composite Segment Construction

OLD TUNNEL



DESIGN DIFFERENCES

DESIGN	NEW TUNNEL	OLD TUNNEL
COVER THICKNESS	0.090 IN.	0.260 IN.
INTERIOR SUPPORT	URETHANE FOAM EA919	METAL BRACKETS EA834
ADHESIVE (TO CASE)	15.75 IN.	10.50 IN.
WIDTH (W/CORK TPS)	2.62 IN.	4.50 IN.
HEIGHT (W/CORK TPS)	1.099 LB	1,299 LB

NEW TUNNEL

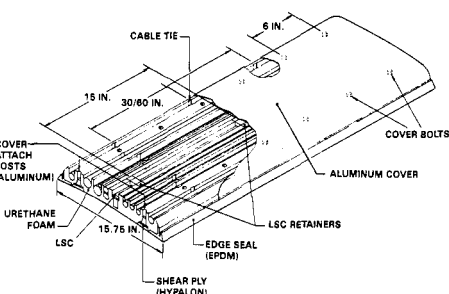

Figure 13. Systems Tunnels

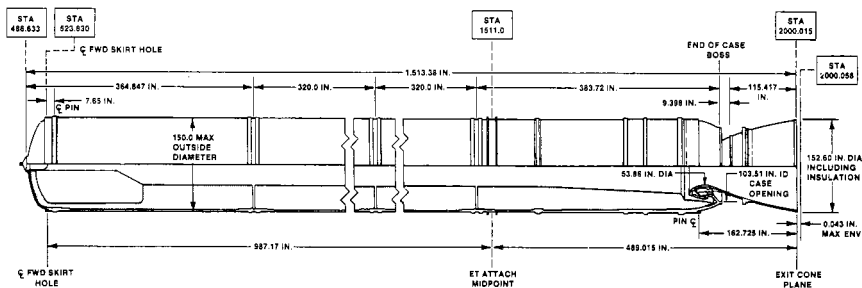

Figure 14. FWC-SRM Design Configuration

FWC-SRM has approximately 3,000 lbm less propellant (0.27 percent) resulting from a slightly smaller inside diameter and an increase in insulation in the area of the metal adapter to composite joint. The baseline FWC-SRM design configuration is shown in Fig. 14. A comparison of the pressure-time traces of the DM-6 and DM-7 FWC-SRMs with the HPM is shown in Fig. 15.

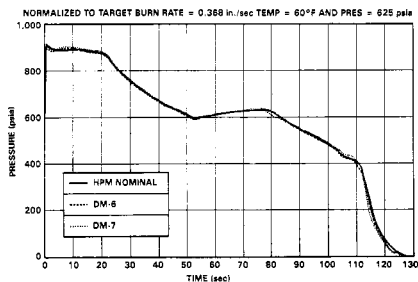

Figure 15. Pressure vs Time

Thrust differential between the two SRMs during operation must be minimized to reduce vehicle control requirements. The thrust differential between the two motors is primarily due to variations in propellant burning rate. The reproducibility of the thrust-time trace and the predictability of the propellant burn rate have combined to provide considerably lower thrust imbalance levels than required by the specification. Differences between target and actual burn rates have been less than 2 percent compared to a specification requirement of 3 percent.

Thrust traces during ignition for 26 static and flight tests (both standard and HPM) are shown in Fig. 16. The range in ignition interval times (from ignition command to 1,640,000 lbf sea level thrust) is less than 0.05 sec compared to the requirement of 0.170 sec (from 0.170 to 0.340 sec). The reproducibility of the thrust-time trace during steady state and tailoff is shown in Fig. 17. The envelope of thrust imbalance levels from 11 matched pairs of SRMs flown on the Shuttle is well below the specification limits as shown in Fig. 18; the SRMs are cast in matched pairs to minimize thrust differential.

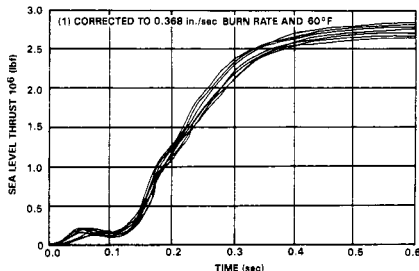

Figure 16. Composite of 26 SRM Thrust-Time Traces During Ignition

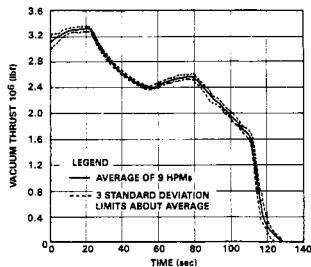

Figure 17. Thrust-Time Trace Reproducibility Experience

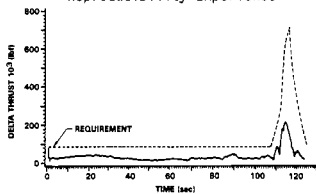

Figure 18. Maximum Thrust Imbalance Envelope for First 11 STS Flights

All SRMs have operated within specifications and all Shuttle flights have been successful to date. All SRM hardware has performed as expected with the exception of one of the nozzles on the flight of STS-8. This nozzle exhibited severe erosion in the nose inlet section of the nozzle that substantially reduced the safety factor of the nozzle in this area. The anomaly observed on STS-8 was traced to a need for tighter quality requirements on the carbon cloth phenolic material used in this section of the nozzle. This problem was corrected by restricting the material used in this portion of the nozzle and tightening the process controls for manufacturing these parts.

RECOVERY, REFURBISHMENT, AND REUSE

The solid rocket motors (SRMs) are the first and only reusable solid rocket motors ever flown. The expended motors are parachuted back to earth (Fig. 19), retrieved in the Atlantic Ocean approximately 130 miles from the launch site, towed back to Port Canaveral, returned to the Wasatch Division of Morton Thiokol in Utah on railcars, refurbished, reloaded, and returned to the Kennedy Space Center (KSC) for another launch. The steel case components of the SRMs will be used 20 times. The rubber/steel shim flexible bearing in the nozzle, which provides steering capability for the vehicle, will be used for 10 flights before the rubber is removed; new rubber will then be vulcanized to the refurbished metal to form a new "recycled" flexible bearing which will be good for another 10 flights. The steel and aluminum structures in the nozzle will be used for 20 flights. The safe and arm (S&A) device and the igniter are also refurbished and recycled for a total of 20 flights. Altogether, there are 84 metal parts, two S&As, six operational pressure transducers (OPTs), and over 5,000 pins and bolts that are recovered and reused on every SRM flight set (Ref. 4).

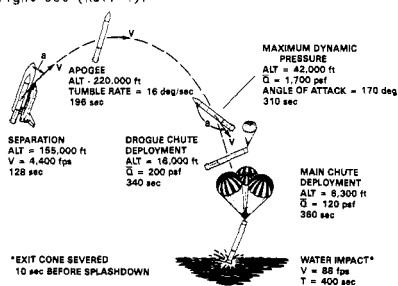

Figure 19. Typical SRB Reentry Profile

Some attrition of hardware has occurred when water impact loads have been more severe than expected. However, 95 percent of the hardware that has been recovered has been acceptable for reuse. Some SRM hardware has already flown five times and nearly all of the hardware from the development and qualification program has also been used in flight motors.

Eighteen Space Shuttles have been boosted into space from Kennedy Space Center using 36 solid propellant rocket motors. The two SRM boosters, which supply about 84 percent of the launch thrust,



Figure 20. SRB Separation



Figure 21. SRB with Three Main Parachutes

are separated (Fig. 20) from the Space Shuttle Orbiter approximately 2 min after launch at an altitude of 30 miles. The motors are parachuted to the sea (Fig. 21), retrieved and towed 130 miles back to Port Canaveral (Fig. 22). After partial disassembly, the motors are returned to Morton Thiokol in Utah on railcars (Fig. 23) where refurbishment and reloading takes place. Being the only reusable solid rocket motors ever flown, their

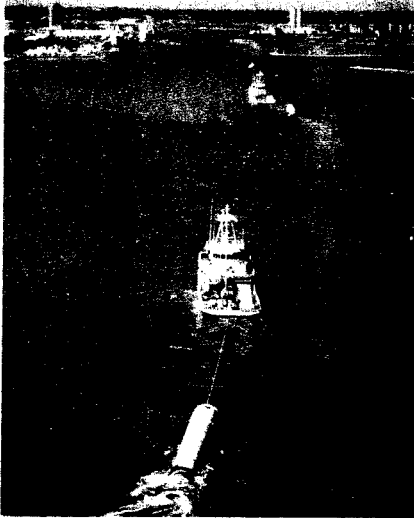

Figure 22. SRBs Being Towed Back to Port



Figure 23. SRM Segment on Rail Car

recovery provides the opportunity to evaluate the design performance and safety factors built into each motor, through insulation and hardware inspection during refurbishment.

Impact velocity of the SRM booster is around 55 miles per hour even with the three large parachutes attached. Initial forces are exerted on the remaining nozzle exit cone and transmitted into the aft case dome. Booster aft skirts which house nozzle actuators also receive high impact loads. The most damaging loading on the case wall comes from the water forced radially inward as the impact cavity collapses on the partially submerged case as shown in Fig. 24; nearly 3/4 of the motor is submerged below the water.

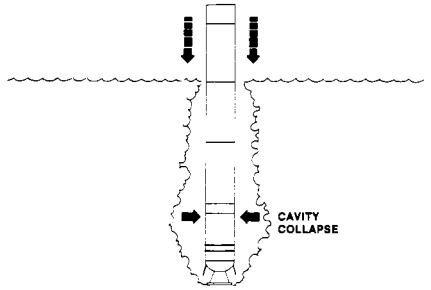

Figure 24. Water Impact

The floating motor is tipped from a spar mode (Fig. 25) to the towing log mode by displacing internal water with compressed air introduced through the nozzle opening. Hookup and towing (Fig. 26) times are a function of the sea state and have varied from 1 to 4 days. Hardware damage appears to be inversely proportional to the sea state to some extent.

The total SRM hardware mission cycle (Fig. 27) has two basic loops which include refurbishment. Case and igniter hardware start with new and used storage and proceed through proof testing, assembly, insulation, propellant cast and cure, inspection and final assembly finishing. Motor delivery to KSC, stacking, launch and recovery is followed by evaluation, refurbishment, inspection and preservation. Nozzle hardware flow is similar with flexible bearing fabrication and proof testing, nozzle structure proof testing, nozzle assembly, inspection and final motor assembly. Following the recovery, nozzle components undergo a performance evaluation, disassembly, refurbishment, inspection and preservation.

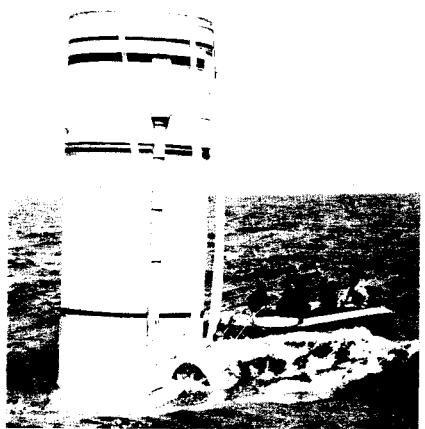

Figure 25. SRB in Spar Mode



Figure 26. SRB in Log Mode for Towing

CONCLUSIONS

As a result of successful SRM refurbishment, the goal of low cost Space Shuttle missions is enhanced. Hardware reuse goals of at least 19 can be confidently projected due to the building base of available data. SRM hardware continues to build up mileage by continued travel on water, rail, road and through space.

The new generation FWC-SRM has a requirement for recovery and reuse of all metal parts. The current FWC-SRM development program will also evaluate the potential reuse of the graphite composite cylinder sections. Graphite cylinders from the first two static tests (DM-6 and DM-7) and a short length structural test article (STA-2) are currently being evaluated to establish potential reuse capability. Data obtained to date indicate that the graphite cylinders may be reusable. Recovery of the first flight set of FWC hardware to be flown from VAFB early next year will be used to establish reflight capability of the graphite cylinders.

The Space Shuttle SRMs evolved from the most mature solid rocket technology in the industry to the latest advancement in the state-of-the-art for solid rocket motor cases. The SRMs have maintained a record of 100 percent reliability in all SRM static tests and flights of the Space Shuttle to date. Future flights will continue to use the HPM for most launches with the FWC-SRM to provide additional payload capability where needed. It is expected that the SRMs will continue their flawless performance in both HPM and FWC-SRM configurations in the future (Ref. 5).

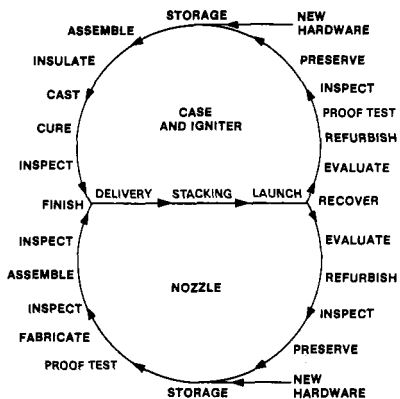

Figure 27. SRM Hardware Mission Cycle

References

1. John Thirkill, "Solid Rocket Motor for the Space Shuttle Booster," presented at the 1975 AIAA Propulsion Conference, 29 Sep - 1 Oct 1975.
2. E. G. Dorsey, Jr., "The Space Shuttle Solid Rocket Motor," presented at the the 33rd Congress of the International Astronautical Federation, 27 Sep - 20 Oct 1982, Paris, France.
3. L. G. Bailey, G. E. Nichols, and C. A. Saderholm, "Space Shuttle Rocket Motor Performance Improvement," presented at the 1983 JANNAF Propulsion Meeting, February 1983.
4. Howard H. McIntosh, Paul A. Ross, Allan J. McDonald, "Refurbishment of the Space Shuttle SRMs - the First Reusable Solid Rocket Motors," presented at the 1984 SAE Aerospace Congress and Exposition, 15-18 Oct 1984.
5. Allan J. McDonald, "Evolution of the Space Shuttle Solid Rocket Motors - Something Old and Something New," presented at the Twenty-Seventh Israel Annual Conference on Aviation and Astronautics, 27-28 Feb 1985, Tel Aviv, Israel.

Mr. McDONALD. I would like to review the documentation, any element of the shuttle goes through a preliminary design review, it goes through a critical design review, it goes through a design certification review which NASA is the principal participator, as well as the element subcontractor, and they also bring in outside people to make sure that that element is qualified to the specifications it is supposed to be.

One of those final ones, prior to the first launch, occurred in April 1980, is this document called "Space Shuttle Verification Certification Propulsion Committee." It was headed up by General Morgan and also the chief engineer at NASA headquarters at that time, Walt Williams, and their findings, their findings were, as in comparing everything that was done, ready for qualification. And the things they had concern was—one of their concerns was that we had no test at the temperature extremes of 40 to 90 degrees Fahrenheit.

Mr. NELSON. May I have a copy of that document right now?

Mr. McDONALD. You certainly can.

Mr. GARRISON. Read the other part.

Mr. McDONALD. Let me read to you first, and I will give this to you, and this was their findings. It says, "The SRM verification program does not include any full-scale firings nor any instrumented storage tests at environmental extremes. Extremes include short-term horizontal storage conditions at Utah or in shipment, long-term storage at 32 degrees Fahrenheit to 100 degrees Fahrenheit or firing at 40 degrees Fahrenheit and 90 degrees Fahrenheit."

Mr. NELSON. Was that specifically a document that modified the design requirements, as stated in the initial space shuttle flight and ground systems specification?

Mr. McDONALD. No, it was a document that was written based on the data that was available to determine whether we met the specifications as they interpreted them also.

Mr. NELSON. It was written by whom?

Mr. McDONALD. It was written by General Morgan and by Mr. Walt Williams, the chief engineer at NASA headquarters.

Mr. ROE. The document will become part of the record.

Let me clarify a point for the record at this point before I call on the distinguished gentleman from California, to get this into the record at this point.

In the observations of the Thiokol leadership and in view of that document that you have just read, is it perceived at all you would just go ahead blindly? Everything you did in the design approach had to be approved by NASA, is that correct or not correct?

Mr. GARRISON. Well, everything certainly had to be approved, yes, sir.

Mr. ROE. The question has arisen on the design specification requirements, and, in effect, what is being said, did Thiokol or did Thiokol not meet its design specifications?

Mr. GARRISON. In our opinion, and with our interpretations, we met the requirements.

Mr. ROE. All right. I am simply saying for the record, it would seem to me, you are not just picking up a bowl of soup and presenting it—there are thousands of parts and thousands of engineering decisions to be made. And I assume there was some process that

was followed with NASA as you progressed along, because NASA was the ultimate one to determine whether you were meeting your contract requirements or not. And if you weren't, they should have stopped you. Is that the proper understanding?

Mr. GARRISON. Yes, sir, that is correct.

Mr. ROE. That is all I want to say.

The gentleman from California.

Mr. PACKARD. Thank you, Mr. Chairman.

In your telecon, was temperature that night ever discussed?

Mr. KILMINSTER. You are talking of the telecon of January 27?

Mr. PACKARD. January 27.

Mr. KILMINSTER. Yes, it was.

Mr. PACKARD. What was the nature of that discussion?

Mr. KILMINSTER. Earlier in the day, when we were told the overnight temperatures could be low, we were told initially they could be as low as 18 degrees overnight temperatures. Later on, that was modified, and I believe the last calculation we made, even while the telecon was initially going on, was based on 23 degrees overnight low temperatures. We took those low temperature conditions as a function of time as when they would occur or when they were predicted to occur over that nighttime period, and then we predicted from that what the temperatures of the O-rings could get down to. It was on that basis we predicted that the temperatures of the O-rings would be around 29 degrees, and that was discussed during the course of the telephone conversation.

Also discussed, and I believe it is included in the charts that were used for that discussion, were temperatures of other motors that had been tested at various temperatures.

Mr. PACKARD. That was considered to be the ambient air temperature?

Mr. KILMINSTER. No, sir, that was the calculated temperature of the O-ring given some ambient temperature condition, and that ambient temperature condition over time.

Mr. PACKARD. And it was at that time your engineers, with that information, felt that it was inadvisable to fly?

Mr. KILMINSTER. Yes, sir.

Mr. PACKARD. And what circumstances and what data changed that decision?

Mr. KILMINSTER. We also had some information, as I had mentioned yesterday, where some resiliency tests were done, and those resiliency tests were laboratory tests that were conducted at 50 degrees, 75 degrees, and 100 degrees.

In addition, we had sub-scale tests that were conducted using the same pressurize rate that we would predict for the motor on these sub-scale vessels with full-scale full diameter O-rings, but at a smaller diameter, circumference diameter, and in the same gap or groove geometry that we would use in the full scale.

Those tests were conducted, 2 at 75 degrees and 2 at 30 degrees. This was done with an argon gas so we could sniff with a very sensitive instrument to see if there was any blow-by past the O-ring when we conducted that pressurization test. Those indicated that there was not any blowby.

Mr. PACKARD. And that was the extent of any tests that were below 40 degrees or even 53 degrees, is that correct?

Mr. KILMINSTER. No, sir. There was also some static tests temperatures, and I believe that night our calculation showed they were, one of them was at 47 degrees, again calculated O-ring temperatures, and another one at 48 degrees calculated O-ring temperatures.

Mr. PACKARD. Of course, there is a lot of difference between 47 degrees and 29 degrees.

Mr. KILMINSTER. Yes.

Mr. PACKARD. Were there ever any—or did you use previous flight experience as it relates to temperature to determine the effectiveness of the O-ring joint? Were those figures calculated and tabulated on an ongoing basis, previous flights?

Mr. KILMINSTER. I believe we understood that night, and I can't remember if they were shown on the charts or not, that there were a number of flights between 75 degrees and 53 degrees, which exhibited no blowby.

Mr. PACKARD. But nothing below 53?

Mr. KILMINSTER. Nothing below 53 for flight motors.

Mr. PACKARD. You have some of your new design people or the redesign people here today, is that correct?

Mr. KILMINSTER. Yes, sir.

Mr. PACKARD. I would be interested in knowing what kind of progress and what direction the redesign is going at the present time.

Mr. KILMINSTER. I defer that question to Mr. McDonald.

Mr. McDONALD. I am head of the redesign task force, and we are in the process of looking at various concepts. We have been establishing criteria for those concepts, and those concepts are to make sure that we have full redundancy in any sealing concept for the full duration of the flight. We are going to eliminate, as best we can, any kind of rotation one could ever get out of a joint like that, and we are looking at different seal concepts, as well as different types of devices to protect those seals, and it is not because we don't have a lot of concepts, we have more than we can deal with right now. We have got to narrow those down, but we are doing that very carefully.

Mr. PACKARD. We are looking primarily again at the existing O-ring type of redesign?

Mr. McDONALD. We are looking at some O-ring design and some that do not have any O-rings. We are looking at different types of sealing concepts, as well as O-ring concepts.

Mr. PACKARD. Thank you, Mr. Chairman.

Mr. ROE. For clarification of the record, Mr. Garrison, would you advise the committee, we are speaking of the redesign team—is that the word we are using? What do you call it, your redesign team?

Mr. McDONALD. Yes.

Mr. ROE. Is that a Thiokol redesign team?

Mr. GARRISON. Yes, sir. That is an organizational element title and the program management organization of our Space Division.

Mr. ROE. When did the team begin, for the record?

Mr. GARRISON. The team—

Mr. ROE. August?

Mr. GARRISON. At the time Mr. Dorsey came on board and reorganized the division.

Mr. ROE. When, August? Just recently?

Mr. GARRISON. March.

Mr. ROE. In March of this year?

Mr. GARRISON. Yes.

Mr. ROE. Has this all been discussed, NASA knows what you are doing?

Mr. GARRISON. Absolutely.

Mr. ROE. Are there NASA people on the team?

Mr. GARRISON. This is an internal organization, sir. It has been coordinated with NASA, they are fully aware of what we are doing. They are fully aware of the people we have assigned. We are not trying to say that this is the total design task force for the system. This is Thiokol's organization that is spending full time in supporting this activity.

Mr. ROE. Where did the idea of a team come from, from Thiokol or from NASA or a joint meeting between Thiokol, NASA, or what?

Mr. GARRISON. This is an internal Thiokol organizational title, sir. And it was to give our program management people, specifically Mr. McDonald, the assets to manage that program.

Mr. ROE. I understand the technical difference, I understand what you are talking about. What I am trying to get is where is the origin from? Is it sanctioned by NASA, is it now an accepted fact that there is a Thiokol redesign team that is approved by NASA?

Mr. GARRISON. Yes; I believe so.

Mr. ROE. Have you got a contractual agreement to that effect——

Mr. GARRISON. Well, we have——

Mr. ROE [continuing]. In your ongoing contract for redesign?

Mr. GARRISON. We have technical direction from NASA, yes, sir.

Mr. ROE. So it is a sanctioned operation by NASA who is agreeing Thiokol is doing the study into redesign?

Mr. GARRISON. Absolutely. Completely covered by our contract.

Mr. ROE. The gentleman from Texas, Mr. Andrews.

Mr. ANDREWS. I would like to go back to my line of questioning yesterday. Mr. Roe asked you yesterday morning who was in charge of that critical meeting in which the fretful decision to launch was made. I didn't appreciate your answer. I didn't know, I understood your answer. You were in charge of that meeting, were you not, sir?

Mr. KILMINSTER. The senior man that was at that meeting was Mr. Mason, the senior vice president of Wasatch operations.

Mr. ANDREWS. He was the person who oversaw the discussion in the meeting and drew the conclusions together, and not yourself?

Mr. KILMINSTER. That is correct.

Mr. ANDREWS. Yesterday I read to you a statement that was made by Mr. Locke, his written statement, in which he said: "NASA questioned Morton Thiokol's decision. Our engineers could not prove that it was unsafe to fly at less than 53 degrees Fahrenheit."

Mr. McDonald has testified, and this statement testifies, that what had happened was that NASA changed the burden of proof

on Thiokol and suddenly rather than trying to prove it was safe to launch, you were put under the burden of showing that it was unsafe to launch.

You disagreed with that statement yesterday. Is that correct, sir?

Mr. KILMINSTER. Yes; basically, I did not see any significant difference in the way that we were asked to review the technical data and draw conclusions from technical data that we are asked almost on a weekly basis when we have other technical discussions with Marshall Space Flight Center. When we present data one way or the other, they, rightfully so, scrutinize that data, penetrate that data and ask us on what basis we are making our judgments. And I saw that operation as being a typical type thing that we had done in the past.

Mr. ANDREWS. And that troubles me greatly. Because that leads me to think that this kind of decisionmaking may happen again in the future. I assume that we don't want to write such strict contracts between NASA and their contractors that would restrict common sense and inhibit judgment. But what do we do when the judgment is flawed and the common sense is put aside, as happened in the case of that meeting?

And my question to Thiokol and to you is: Do we need, as a matter of policy, to have tighter burdens of proof written into the contracts with the contractors, where you know full well what your responsibilities are when you make that decision to recommend a launch or not to launch?

Mr. KILMINSTER. I would believe that type of thing would be relatively difficult to write in as a matter of mechanics type operation. I have no further comment, I guess.

Mr. ANDREWS. How do we avoid the failure of common sense and good judgment that occurred in your instance?

Mr. KILMINSTER. I don't believe there was a failure of common sense in this instance. I believe that we had different people looking at the same data and drawing somewhat different conclusions.

Mr. ANDREWS. Let's go into that in a little more detail. I would like, if we could, there is a critical memo that was the final decision to launch that was sent to NASA, and if we could project that on the wall for a second, it might be a little bit easier to talk about. And I would like to ask Mr. McDonald if he would, if we can see this, to go down this memo and first, Mr. McDonald, tell us what is critical about this memo, what is this memo?

Mr. McDONALD. That was the final memo that came of the fax as a result of the caucus at Wasatch, and it basically delineates the points that were made when Mr. Kilminster came back on the line recommending to proceed on with the launch, even though we had some concerns.

Mr. ANDREWS. So when Mr. Kilminster tells this committee that his common sense was sound that day and his judgment was appropriate, this memo reflects that common sense and judgment. This is the basis for Thiokol's decision that is reflected in this written document.

Mr. McDONALD. That is the way I understand it, yes.

Mr. ANDREWS. Would you please go down the memo, and let's talk about the specifics of this extremely important document for

this committee, and give us your thoughts first why each of these is significant, what they mean to us.

Mr. McDONALD. Well, the first bullet says "Calculation shows SRM 25 O-rings will be 20 degrees colder than SRM 15 O-rings." Now the SRM 15 was from the previous flight 1 year before that on STS-51C. And that is bad, because they are recognized to be much colder, which everyone recognized was going in the wrong direction.

Mr. ANDREWS. If this is one of the things, when you saw this memo you were shocked, were you not, to see this in writing?

Mr. McDONALD. Yes; I was. I was a bit surprised because there were so many things on here. In fact, more things that were bad than there were good.

Mr. ANDREWS. Mr. Chairman, my time is up. I have heard the bell.

Mr. ROE. That is all right. I think it is a critical issue, and the members will indulge us, in addition to that, the point I raised this morning, if the gentleman from Texas will yield, I will give additional time, that is a duplication of the memorandums that appeared in the Commission report on page 97. That is how it is printed in the report.

However, in the original document, there is a section on the bottom that I mentioned this morning, as I understand it from information we received, that has a codicil under where it says; "Morton Thiokol, Inc., Wasatch Division," there is another part of the writing that has a warning, and it reads as follows, and I quote, warning reads: "Information on this page was prepared to support an oral presentation and cannot be considered complete without the oral discussion".

One more time, for the record, information on this page was prepared to support an oral presentation and cannot be considered without the oral discussion, and that is what I was attempting to develop early this morning, and relate that to this memorandum. There is an oral discussion related here. That is what the warning of the codicil says according to the official record.

Mr. McDONALD. Let me explain why that is there. This is a form. The form is a piece of paper that we use to put oral presentations together for the customer.

Mr. ROE. I understand.

Mr. McDONALD. We make bullets on there and when we give an oral presentation, there is obviously a lot more said than what is exactly on that piece of paper. It was just typed on that piece of paper. It has no more significance than that.

Mr. ROE. If the gentleman would yield, it may be typed on there. I am beginning to wonder why anything is typed. It seems to me—weren't there oral discussions that related to the issue?

We just got done saying you spent a half hour caucusing or an hour caucusing. What I am trying to get at, and I think the key to this issue, is whether or not Thiokol unilaterally made this decision, or was it made in concert and discussion with NASA officials. That is No. 1.

The second point of the question is, if that is so, at what level was that decision made, or those series of decisions made, and quote, one, did, No. 1, people in NASA top management know of

the decision. And equally as important, did No. 1 people in Thiokol know of the decision. Do you see where I am coming from?

Mr. McDONALD. I will defer the latter part of that question to Mr. Garrison, but this piece of paper is like a logo; it's a letterhead piece of paper where that information relative to the oral presentation is part of the paper. It was not typed on there after the information was. It was already on the piece of paper.

Mr. ROE. But the gentleman seems to be thinking I am having difficulty in understanding that. I am not. I understand exactly. What I am trying to develop all through the testimony we had people say: "Oh, we left that out," or "That didn't matter," or "This was a mistake." We have heard that for days now. You know someplace along the line you signed a document, Mr. Kilminster signed a document. Does the oral relationship and discussion have anything to do with it? That is the question he is asking. How did you arrive at the decision?

Mr. GARRISON. I don't believe that that statement on the bottom of the paper insinuates in any way that the document doesn't mean what it says. That was a decision that our management people made and transmitted to NASA as a result of the lengthy telephone conversations they had all afternoon.

Mr. ROE. There is a difference of interpretation, and I think you or Mr. Kilminster have said it. It depends upon, you know, the eyes—truth is in the eye of the beholder. I think I thought I heard what you said. The biggest mistake we can make in life in the art of communications is if the other person understood what we said. In your own group of people here, Mr. Kilminster said that he did not feel that was a change of policy, I did not feel that was pressure, and so forth.

But Mr. McDonald and Mr. Boisjoly testified to the point of view they do feel it was pressure. They didn't agree with Mr. Kilminster. It is either correct or is not correct; isn't that what you testified to? So therefore we have a difference of opinion in the Thiokol chain of command, if I may make that point. Is that reasonable?

Mr. GARRISON. Yes, sir.

Mr. ROE. Now, NASA comes back, and says: Look, we didn't think we were pressuring at all. We just were following the process. This is what we always do.

Now, there is something not coming together there. Do you understand where we are trying to come from?

Mr. GARRISON. I think that what you stated is true, that some people—

Mr. ROE. Was Thiokol under pressure by NASA to make a decision regardless of the problems involved to launch? Or did Thiokol unilaterally make that decision? That is what is before us on this memorandum right now.

Mr. GARRISON. Mr. Chairman, I would like to summarize what I think the position is, and when I saw what I think it is, because we do have a difference of opinion between our people on how they felt during that telephone conversation on pressure. We also have obviously a difference of opinion between two groups on technical judgment, and that is a fact.

I don't know how to get around that. The four people that made the decision felt that they had adequate, adequate technical justifi-

cation to make the decision. We had other people that felt just as strongly that they did not. Those are the facts.

Mr. ROE. I thank the gentleman. We will now recess for 10 minutes to go and vote and return, and we will take up with Mr. Andrews when we return.

[Recess.]

Mr. ROE. The committee will reconvene.

When we recessed to go and vote, we were having some questions being asked by the gentleman from Texas, Mr. Andrews. The chair recognizes the gentleman from Texas, Mr. Andrews.

Mr. ANDREWS. Thank you, Mr. Chairman.

Mr. McDONALD, tell us, if you would, please, the significance in your mind of this memo that is reflected on the wall that is found on page 97 of the Presidential commission report.

Mr. McDONALD. Well, I guess the significance in my mind was that Mr. Kilminster tried to incorporate all of the information that he knew, that he was aware of at that time, relative to the issue of cold temperatures on the capability of the O-ring seals, both positive and negative, and he summarized all that there.

Mr. ANDREWS. All right. When Mr. Kilminster stated earlier that he used good common sense and good judgment, that is what is reflected in this memo, is it not?

Mr. McDONALD. Well, you will have to ask Mr. Kilminster that.

Mr. ANDREWS. I believe he stated that that is his judgment. Now, if you would, please go down these very, very important conclusions that Thiokol drew, and tell the committee what is significant about each one.

Mr. McDONALD. Well, as I had indicated, the first one shows it is much colder, which is a bad thing. Everybody knew that that was our concern. Everybody was concerned about what effect that might have, because it was going to be colder, outside of our experience base.

Mr. ANDREWS. Were you surprised to see that in this memo?

Mr. McDONALD. Oh, absolutely not. That was a known factor for everybody. That was the reason we had the whole meeting in the first place, because it was outside of our experience base; our lowest experience base prior to this was on STS-51C, which was our set of SRM-15 motors that is referenced here, and this is a much colder condition. That was what drove the whole meeting.

Mr. ANDREWS. And weren't you surprised to see that the conclusion to launch was made in spite of this notation?

Mr. McDONALD. Well, I was surprised to see the conclusion the launch was made in that. I wasn't surprised to see it on this particular piece of paper, because Mr. Kilminster was trying to put down all the information that they knew, both good and bad.

Mr. ANDREWS. The second one is the temperature data section. Tell us what is significant about that.

Mr. McDONALD. Well, the temperature data is not conclusive on predicting primary O-ring blowby. Now, generally when we have information that is not conclusive, it has to be interpreted as negative; if you don't understand it or it can't support a position, then that is bad.

Mr. ANDREWS. And so good common sense or good judgment would be to recommend not to launch, when you have inconclusive information on something as critical as this temperature measure?

Mr. McDONALD. Well, that is right. It is a negative thing, and then we go to the engineering assessment, and recognizing that by getting colder those O-rings are going to be harder, there durometer increases, which is not good. We mention that those harder O-rings are going to take longer to seat, and that was kind of the issue that Roger Boisjoly had made earlier with the concern with the timing function, the time it takes for this whole sealing operation to occur while you may be getting some erosion on the O-ring.

And the sub to that is that more gas may pass primary O-ring before the primary seal seats, relative to the worse condition we had seen a year earlier, and that is a very negative statement that says that it is liable to be worse than what we had seen, even though a year earlier it certainly didn't fail.

Mr. ANDREWS. And in spite of that information that is reflected in the memo, Mr. Kilminster's common sense told him that it was OK to launch that morning?

Mr. McDONALD. Well, he was weighing this information relative to the rest of the information on this chart also to make that decision. In all fairness, you must go through the whole thing. At that point you will notice there are some comments that are made on the positive side of why they feel it will still work. The one about demonstrated seating threshold is three times greater than the thirty-eight one-thousandths erosion that was experienced on that previous coldest launch 1 year earlier is a positive statement that we can obviously tolerate much more erosion without losing the seal than we had seen prior to that.

The next statement says that the primary seal does not seat. The secondary seal will seat.

Now, that is a matter of judgment in my opinion, because the point that Mr. Boisjoly was making is that, yes, if you conclude that all of this whole phenomena occurs in the first 170 milliseconds before the metal parts have a chance to deflect and rotate, that is a fairly good chance that indeed will happen.

But if the cold temperature affects the O-rings themselves, and the grease and the capability extruded in the gap that Mr. Boisjoly, the point he made, and he made beyond that time regime, and then because the resiliency of the secondary O-ring is the same as the primary, they both have the same problem, it may not come out fast enough to catch up with the metal parts and it won't seal.

Mr. RITTER. Will the gentleman from Texas yield on that?

Mr. ANDREWS. I will be glad to yield.

Mr. RITTER. It states here if the primary seal does not seat, the secondary seal will seat, and you say that is certainly a matter of judgment and I would agree. Now, the primary O-ring seal has a critical 1 rating. That means it does not have a redundancy built into it, which means that in fact you should seriously doubt, given the criticality 1-R rating, you would seriously doubt, from the rating system, that the backup seal would work, wouldn't you?

Mr. McDONALD. Well, let me comment on that. I think—and I heard most of Mr. Boisjoly's testimony yesterday, and I think he

did an excellent job in explaining how we looked at that situation. The criticality 1-R was changed to a 1 when people recognized that if we took some of the hardware that our engineering drawings allowed us to build, and took the worst tolerances with the clevis opened as much as it possibly could, and the tang being as thin as it possibly could, and the O-ring being as thin as it possibly could be, that we were in a condition where if you believed the information that Marshall had obtained off of a structural test article on how much that opening between the tang and the clevis sealing surface happened during pressurization, you could end up with a condition where you had no squeeze on that secondary O-ring.

Now, when that was recognized, there were two things that were brought to bear at Thiokol. One was that we decided that we are not going to allow any hardware to ever go in the field that had all of those worse tolerances stack up. We were going to measure each of them individually and only mate hardware that was not in that kind of a condition, and we had to present at every flight readiness review what those measurements are and what O-ring squeeze that we had maintained, so there was none of it in the field.

Mr. RITTER. If you will yield back to me for a moment, doesn't the criticality of 1 characterization imply a single point failure, and that is it, and that is the nature of criticality 1, and that you are trying to justify why you guys went ahead and did this, but you violated in a sense your own performance rating system?

Mr. McDONALD. Well, it does imply that is what a critical 1 is, if the hardware is in that kind of a condition, and the reason it was changed is because the engineering paper allowed you to have hardware in that condition, and in order to make sure that it never happens, you have to treat it as a criticality 1. Now, in this particular instance, and subsequent to that change in criticality 1-R to 1, we watched all that hardware.

The second thing was the reason Thiokol never changed their paperwork from a 1-R to a 1—and we did not—was that, one, we didn't agree with the conclusion that the clevis opened that much in the first place. We ran our own tests, and said that it didn't open near as much as what the Marshall data indicated, and we ran ours in a vertical condition rather than a horizontal that they ran theirs in. The horizontal was the worst condition but the motor doesn't fly that way.

More recently, as a result of the referee tests, they were started because of this disagreement between ourselves and Marshall confirmed that we were right, that it didn't open that much, and as a result if you forgot about resiliency in the cold temperature, which up until recently we weren't aware of that problem, but when the criticality 1R was changed to one or temperature wasn't an issue, our hardware and our analysis and the data that we received recently said it was indeed redundant, and it stayed that way.

Now it is just because of this temperature problem and the resiliency of the O-ring that we found out in this past year has now made it so it is only a criticality 1.

Mr. ANDREWS. But the point is—if I could regain my time for one more question—the truth is, Mr. McDonald, you and Mr. Boisjoly, in looking at this memo that reflected that discussion, know full well that the things are listed on here, any one of those could be

ample reason to decide not to launch, as an abundance of precaution. That is correct, Mr. Boisjoly, isn't that right?

Mr. BOISJOLY. Yes, I agree to that.

Mr. ANDREWS. And in spite of that, we have Mr. Kilminster sitting there today testifying before this committee that he used good common sense, good judgment, and in spite of this memo and the stark conclusions that were drawn from the memo, and the facts that we know happened, he still says that Thiokol at that meeting, those engineers and the management people, used good common sense, and I am frankly just appalled by that, and as we as a committee try to go about designing better public policy, we need some harder answers than that, Mr. Kilminster. We have got to avoid the kind of bad discretion and the bad judgment that Thiokol used in that very, very critical meeting.

Mr. KILMINSTER. Based on today's state of knowledge, that certainly is the case. What I was trying to relate to you was the state of knowledge that we had that evening, and this information was reviewed with the vice president of engineering as well as the other two managers there, and that was our consensus, not just mine alone.

Mr. ANDREWS. Thank you, Mr. Chairman.

Mr. ROE. The time of the gentleman has expired. Put the lights on, please.

I think for an even balance of the issue, in view of the fact that we have been going round and round and round and round, and properly so, to get to the bottom of the issue, we can't lose sight of a very important fundamental fact. Even if what was said today is correct—and I have no reason to doubt it—there is a difference of opinion between Mr. McDonald, Mr. Boisjoly and Mr. Kilminster, there is no problem with that. But the final buck stopped at NASA, either that or Thiokol was running the system. That is something that we can't lose sight of in our evenhanded deliberations.

The gentleman from New Jersey, Mr. Torricelli, is recognized.

Mr. TORRICELLI. Thank you, Mr. Chairman.

Mr. Ritter, as a man of science, addressed this question from his own background. Let me briefly, Mr. Kilminster, do it, address this question from my own background as a lawyer. You find yourself in an interesting position, as one who invariably in the future could be involved in a civil litigation or worse.

As I understand your testimony this morning, before this committee, and I assume in the legal process that may follow, you are going to suggest to a court, as you suggest to this committee, that you were engaged in a conversation and a decision to launch a \$4 billion vehicle with seven lives aboard, and although one of your engineers was on the site and on the phone, never really questioned his contrary judgment. You did so without real working knowledge of the conditions at the site, and having never tested adequately the equipment that you had sold to NASA, as I understand the circumstances that were then prevalent at the site.

I am not so much, Mr. Kilminster, asking you for a response as I am that I have seen the makings of negligence cases before, but rarely one that was so strong. You are going to find yourself in a unique position, if you and your corporation are going to claim that negligence has not been committed in this case.

I invite your response, though it is certainly not required.

Mr. GARRISON, is the policy of your company to sell equipment to the U.S. Government, certify it having met standards that have been set forth in the bidding process, having never adequately tested them to the limits of those specifications? And could that not be said to be the case with any other equipment that you have sold the U.S. Government, or shall we assume that this is a unique exception, and that everything else that you have sold to the government has in fact been tested to the limits of its specifications?

Mr. GARRISON. I believe, Mr. Congressman, that I explained earlier that I do not believe we did that. I think that—I will repeat again, we interpreted the specifications. We submitted our plans, which were agreed to, and approved, and I feel that we complied with the contract.

I think you have to understand—and there may be some misconception in this room—that we take a contract and go away and do our thing and deliver a product, and that is not true, because everything we do is under scrutiny and approval of NASA.

Mr. TORRICELLI. I think Mr Roe has made that point, and I think it was a contribution to our discussions today, because for whatever failures took place in the corporation, the fact is that they were done under the nose of NASA and in fact with their approval. It is, however, difficult for a lay person listening to this discussion today to come to the same conclusion—having now read the specifications, and heard of your testing process—come to the conclusion that in fact the item was tested to the limits of its specifications—difficult to accept.

Mr. GARRISON. We believe we did that.

Mr. TORRICELLI. Let me suggest to you then, you today, sitting there, would suggest that NASA flew these motors at 31 degrees?

Mr. GARRISON. Absolutely not.

Mr. TORRICELLI. But you tested them to 31 degrees?

Mr. GARRISON. I think the record shows what the qualification program was.

Mr. TORRICELLI. Again, I don't come to this as a scientist. I come to this as a layman.

Mr. GARRISON. Our specification says the operating limit of the rocket motor is 40 degrees to 90 degrees, sir.

Mr. TORRICELLI. And that is, you felt, the limit of your obligations to NASA, that it be operational at 40 degrees?

Mr. GARRISON. No, I was just commenting on what specification requirements are. I thought you were referring to that.

Mr. TORRICELLI. I see; but your view is that the limits of your responsibility to NASA, that it be operational at 40 degrees?

Mr. GARRISON. I believe that was the requirement of our contract.

Mr. TORRICELLI. Yes, would you fly this shuttle today at 40 degrees?

Mr. GARRISON. I would not fly at all until we have gone through a redesign of the joint.

Mr. TORRICELLI. But yet you are telling me that you adequately, as required under the contract, tested at 40 degrees. You have done no tests since. You had those tests, but you now conclude that that was not the proper conclusion?

Mr. GARRISON. My statement was that I feel very strongly that we met all the contractual requirements.

Mr. TORRICELLI. I think the point is sufficiently made.

Mr. Chairman, may I have a moment—

Mr. ROE. Proceed.

Mr. TORRICELLI. Immediately after the accident, there was an opportunity to speak with Secretary Weinberger, and there was a natural concern if this was a problem of the solid rocket motors on the boosters, there being some similarity to the technology with military rockets, was the United States unprepared to defend itself in freezing temperatures.

He assured me of the fact that they had tested their equipment to minus 60 below. They had no problems with the joints, no problems with their solid rocket motors. I didn't find any of your reactions to that, how it is that other manufacturers with similar technology seem to have encountered none of these difficulties, and are operating with complete assurance of their technology. What are the profound differences that that same technology was not able to be incorporated in the shuttle from the outset?

Mr. GARRISON. I believe, basically, we all use the same technology. I can't address your question, because I am not familiar with all the requirements in the performance.

Mr. McDONALD. I think I can address that, since I was the chairman of the solid rocket technical committee for the American Institute of Aeronautics and Astronautics. First of all, Mr. Weinberger doesn't have anything in his arsenal that he launches that has joints in it. The only other system there is the Titan, and it is a space launch system. It is not a tactical weapon, so it is very unique.

Mr. TORRICELLI. So in military systems there are no joints?

Mr. McDONALD. There is no field joint in any military system. There are joints, but not field joints.

Mr. TORRICELLI. Because they separate at the joint?

Mr. McDONALD. No, no. We have joints in every rocket motor we build. We have to attach things like igniters and nozzles. There are different types of joints and they do not deflect like this one because they are not as big and they are not as long. This was unique to this type of an application, because you have a tremendous structure here.

Mr. TORRICELLI. Thank you, Mr. McDonald. That is helpful.

Mr. Garrison, finally, in the redesign team, at the moment that is looking at the joints and solid rocket motors, are there representatives of other companies? In other words, is the best and the brightest of America being involved in this redesign process, or have you returned this challenge to the same team that brought us the original designs?

Mr. GARRISON. It is my understanding that NASA is incorporating the inputs of everyone that they feel qualified to do so, and so are we. We have gone out and we do have a number of consultants assisting us in the various areas.

Mr. TORRICELLI. So we can be assured that everyone who has ever been involved in this technology in America, no matter who they work for or who they represent, the best of their knowledge will be made available for a quick and adequate solution?

Mr. GARRISON. I can't guarantee you that everyone will be. We are going to the experts that we feel familiar and comfortable with in all areas and getting other opinions, and I believe that NASA is also doing the same thing.

Mr. TORRICELLI. Thank you Thank you, Mr. Chairman.

Mr. ROE. The chair recognizes the gentleman from Pennsylvania, Mr. Ritter.

Mr. RITTER. Thank you, Mr. Chairman.

I can't help but agree with my colleague from Texas, Mr. Andrews. When I look at the chart from the memo, the followup to the telephone conference on page 97, I can't help but think that most of the very hard and fast comments that are made there actually opt against launch. I mean, if you add them up, they opt, you know, the bad versus the good, the bad are much more predominant. They weigh heavier individually than the good.

I mean, if you just look at that, it is hard to hit that bottom line, which says, "MTI recommends launch." Does anybody want to comment on that?

Mr. McDONALD. I think Mr. Kilminster has to comment on that, but I think in all fairness to him, one has to look at all of the factors on there, that he obviously thought the ones on the bottom, which in numbers weren't the most, were more important than the ones on top, and that happens many times. You go down and buy a suit—

Mr. RITTER. If you will yield back for a second, the ones on top are much harder and firmer. The ones on the bottom are like wishful thinking, almost. They are at best conjecture. They are at best seeking to push the issue of what—

They are trying to prove something. The ones on top, it is cold, there is no doubt about it. There is no doubt about what happens to the O-rings under those conditions.

You know there is no doubt about the more gas may pass the O-ring, but the other ones, the bottom ones, we already discussed a little bit about Criticality 1 and the fact that that characterization implies no redundancy. I mean the other ones are reaching, and I guess I have trouble, I just have trouble assuming that up to a launch decision.

Mr. GARRISON. Let me comment. Mr. Ritter, I don't think there is any doubt that our top technical people, our top management/technical people, because they are technical people also, made an error in judgment. That error was also, or the technical position that they had was agreed to by our customer, and that is not an excuse. That is a statement which I am really trying to portray that they weren't the only ones that misinterpreted the data and drew wrong conclusions.

We have other people, both here and maybe at NASA, that did not agree with those decisions, so I don't think we are trying to defend, I don't think Mr. Kilminster is trying to defend the position today that the decision was a correct one.

Mr. RITTER. Obviously the position was not a correct one. The world knows that all too well. But I mean, from the teleconference, from the written summary of the teleconference, you almost have to conclude not to launch. Anyway, I would like to get on to another perhaps more fruitful line of questioning.

Mr. McDonald, we have heard a great deal about your opposition to the launch. Did you actively argue against the launch during the time of the telephone conference?

Mr. McDONALD. No, I didn't. That two-hour telephone conference, as I mentioned, was a conference that was being conducted by our engineering people on the teleconference, which made the ultimate recommendation not to launch below 53 degrees Fahrenheit. I totally agreed with that. I had no reason to enter that conversation.

Mr. RITTER. But then the off-line telephone conference, did you actively campaign against a launch at that time?

Mr. McDONALD. Yes, I did. I had a long conversation during that off-line, with Mr. Mulloy and Mr. Reinartz, concerning a couple factors. One was I told them I don't know why we just don't delay this thing until tomorrow afternoon, because based on what I had heard from the weather report, that they were projecting temperatures something like 48 to 50 degrees in the afternoon. I knew when I came down to the Cape for that launch that the initial launch time was in the late afternoon, it was like 3:45 in the afternoon, and they told me that they had looked at that, but there was some problem with one of the abort landing sites. I believe it was Dakar. It was either weather or visibility in the late afternoon, and so they couldn't do that.

I also had a long conversation with them about the interpretation of the qualification of the motor between 40 to 90 degrees, which they, Mr. Reinartz had raised earlier that our 53-degree recommendation didn't seem to be compatible with that, and I told him he is right, it isn't.

I wasn't in the original development qualification program. I had been involved, however, in the design certification review as the chairman of our team for the filament wound case solid rocket motor that we were getting prepared to certify for flight out of Vandenberg Air Force Base, and in that process I went back and looked at some of the documentation that was prepared for certifying for the first flight of the steel case, and even though it was my impression that it was to be qualified from 40 to 90, I don't recall seeing anything that we had done, where we had static tested O-ring seals in the condition they should be at those temperatures. Therefore, you know, I would even be concerned with that, and that was the kind of conversation I was having with them at the time.

Mr. RITTER. But didn't you during the course of this caucus mention to Mr. Kilminster that he consider a point that the secondary O-ring is in the proper position to seal, if blow by of the primary O-ring occurred, and doesn't that act in support of what they were saying? Were you wearing two hats at that time?

Mr. McDONALD. No. They interpreted it that way and it was a point that I had made at the end of the teleconference when the decision was made to caucus to reconsider, and at that point I mentioned—in fact, Mr. Hardy had made the comment earlier—that if we are going to make a recommendation that is anything other than 53 degrees, I think an important consideration is to look at the secondary seal as well, because the cold temperature is bad for both seals.

Mr. RITTER. You are essentially saying, according to Mr. Hardy's testimony on page 99 during the Presidential Commission, that there was pretty good redundancy, that in a sense you supported the idea that the secondary O-ring would seal; is that correct?

Mr. McDONALD. No, I didn't support the idea. I supported the comment that I made that is an important consideration that we look at. If we are going to recommend some other temperature other than 53 degrees, I said that at the time, I still feel that is true, because it was very clear that the recommendation that we had made of 53 degrees was totally on our experience base from flights, and if we are going to go outside that experience base, we need to understand, to run some calculations as to how the seating is going to be affected at lower temperatures.

We must consider both seals, because if we conclude that the cold temperatures are not going to affect anything in the first 170 milliseconds, so that we don't get out of that regime that Mr. Boisjoly was talking about, it is probably all right to go colder. But if it does affect that timing and that first 170 milliseconds and goes beyond that, that is when the secondary seal, we can't count on it. We can count on the first 170 milliseconds.

Mr. RITTER. When Mr. Kilminster announced the decision to launch, I guess Mr. Reinartz asked, "Are there any further comments? Did you have any further comments, Mr. Boisjoly? Did you have any further comments, I mean, did anyone at that point seek to turn the situation around.

Mr. BOISJOLY. Both Arnie Thompson and I might add that we were the only ones in the room that continued to vigorously oppose the launch during the caucus. We reiterated and reviewed all the data that we had presented, and continued to try to convince the four management people not to change the decision. Once that decision had been made by them on the basis of our input, I would say it was over, so people keep alluding to the fact that, you know, why didn't we say something after the managers had come on the loop and made that decision on that launch.

I firmly believe, as I so stated in testimony previously, that once we as engineers fight our hearts out to present the information that we believe supports a particular position is given, then we are out of it. We cannot then act as management in the company to get in—

Mr. RITTER. I accept that.

Mr. BOISJOLY. With management. So that is why the comments were made.

Mr. ROE. The gentleman's time—

Mr. RITTER. If the gentleman would allow me just an additional 2 minutes.

Mr. McDonald, with your high-level position, though, you are in the management loop, and not just in a technical sense. When Mr. Reinartz said, "Are there any further comments?" how come you didn't jump up and down and say no?

Mr. McDONALD. Well, I had made some notes of what Joe had explained over the network as to what our rationale was to launch, and had jotted those down because this 5-minute caucus that was going to be a 5-minute caucus turned into a half hour. I had no reason to believe that that half-hour wasn't done in running some

calculations to determine whether we could indeed launch at a colder temperature outside our experience, and it wasn't until it got to the bottom line where there wasn't a particular temperature recommended, you just had to proceed to launch, it kind of took me by surprise.

I also, as I had testified, I was convinced that it was the pressure from NASA that caused the whole caucus in the first place. I knew that, and I knew that Mr. Mulloy had challenged our recommendations, and indeed, he challenges everything but it has always been on the other side when we try to say it is OK to do something he says, "I don't think you can convince me."

Now all of a sudden we had this list of three reasons why we said it ought to go ahead and launch, with a lot of things on there that were reasons not to. He didn't challenge those like he should have, I thought, so I knew at that point in time that if I was going to have any impact on this thing, I was going to have to deal with Mr. Mulloy and Mr. Reinartz, because I felt that my management, if I talked to them, would say, Well, have you talked to Mr. Mulloy and Mr. Reinartz about that?

And that telephone conversation, at the end it was very short. Joe went through, read those. He was told to put that in writing and sign it, and I had commented to Mr. Mulloy at that time, because I thought I would have to sign it, as I was the man at the Cape, that I wouldn't sign it, it would have to come from the plant. That was done. Mr. Reinartz says, "Any more comments?" And they accepted it all, and that was the end of that conversation.

It was after that that I, you know, I just couldn't live with that and told him I didn't see the rationale that was presented that convinced me that it was all right to proceed, and I don't understand how NASA can accept that recommendation.

Mr. RITTER. So you did protest to Reinartz?

Mr. McDONALD. Oh, I did, very, very vigorously, but they were not on the network. That was after everybody went off of the network. I protested for some time to both Mr. Reinartz and Mr. Mulloy.

Mr. RITTER. One last question for Mr. Boisjoly. Your memo of July 31, where you talk about inattention to the subject at hand, you say in this company private memo, "The result would be a catastrophe of the highest order, loss of human life." You close the memo—this is to V.P. Engineering, Mr. Lund. You then say, "It is my honest and very real fear that if we do not take immediate action to dedicate a team to solve the problem with the field joint having the No. 1 priority, that we stand in jeopardy of losing a flight along with all the launch-pad facilities."

What kind of response did you get? That is a pretty hairy document. It is a pretty emotional document. What kind of response did you get? You would think that it would elicit quite a substantial response, because of its strength of message.

Mr. BOISJOLY. I didn't get any personal response, but there was a memo written by Mr. Lund to Mr. Larry Sayer, director of engineering at that time, engineering design, on August 20, and basically it was an answer to that memo that set up a test team to go forward and solve this problem. But as far as any immediate interplay or verbal interplay, there was none with me.

Mr. ROE. The time of the gentleman from Pennsylvania has expired. The chair recognizes the distinguished gentleman from California, Mr. Mineta.

Mr. MINETA. Thank you very much, Mr. Chairman.

First, I would like to ask about this document that was cast on the screen. Is that essentially what was on—that is the telegram of January 27?

Mr. KILMINSTER. No, sir. Previously we had discussed I think something on the order of 11 or 12 pages of data, and then after we went off line on the caucus, then this, the one that was on the screen, is what was transmitted.

Mr. MINETA. And that was requested of you by NASA to affirm concurrence with going ahead with the launch on January 28?

Mr. KILMINSTER. That is correct.

Mr. MINETA. Had you ever been requested by NASA to submit in writing any kind of a document like that in the past?

Mr. KILMINSTER. As a matter of the normal flight readiness review process, we typically do sign a document that says that the unit, those units are ready to be used on the subsequent flight. That is typically done in the readiness review process approximately 2 to 3 weeks before a launch, and was done in this case, and then that same document is used up through L minus 1, launch day minus one review, and if anything comes up in that interim time, then that has to be worked in real time to resolve any issues.

Mr. MINETA. And if there are any issues that come up after this L minus 1, is there anything again to reconfirm what you had previously sent in the form of message or a telegram?

Mr. KILMINSTER. This was a unique situation relative to something coming up after the L minus 1, and we had no previous experience in that regard.

Mr. MINETA. And the fact that they had requested that of you, did you consider that to be atypical?

Mr. KILMINSTER. Well, the whole routine of having a discussion this late before launch was unusual. However, I was not greatly surprised when I was asked to submit a signature on this page.

Mr. MINETA. Let me ask about how long do you think it will take to redesign and get ready for tests and to qualify that joint in the O-ring area?

Mr. GARRISON. At the present time we are conducting a series of analysis studies and tests to identify a joint that we feel will be safe and serve the purpose and go forward with. Until we have an opportunity to select those specific design parameters, and until we have an opportunity to understand fully the Presidential Commission's recommendations in this area, I don't believe that we can make an accurate projection of that at this time.

Mr. MINETA. And you feel you have the inhouse expertise and the capabilities to go ahead and redesign that area?

Mr. GARRISON. Yes, sir.

Mr. MINETA. If you feel you are prepared and qualified now, then why could you not have completed this redesign over the past years, since this isn't something that just cropped up; this is something that was, I guess I might say, so obvious that the O-rings were faulty and that erosion was occurring persistently, why do

you feel you are able to do it now, and couldn't do it before the accident?

Mr. GARRISON. I believe that at this point in time we have some more data than we had prior to the accident.

In our failure analysis, as an example, we have done a great amount of testing to understand the joint. That data is available.

I think, initially, all of the technical experts that were involved in the design of the case and the motor felt that the joint was adequate.

Mr. MINETA. You have—you had noticed everybody has been on notice on this thing for quite a while, and I am not—what is it about the current data that you have now that gives you the assurances that you can go ahead and redesign or that you are even more aware or that you are aware of the problems as compared to, let's say, 1984, just using that as a figure?

Mr. GARRISON. I would like to have Mr. McDonald answer that, who has that support for us.

Mr. McDONALD. Mr. Garrison is right, we not only have much more data, but I listened to discussion yesterday from people from Marshall Space Flight Center, and Mr. Mulloy explaining why we felt that it was safe to fly prior to 51-L, and I have to agree with his assessments.

Prior to that time we had seen this erosion on the O-rings. That was evident. And when I came on the program in March of 1984, one of the things I initiated and was done by Thiokol was to get a better understanding of how this happens and to model that mathematically.

Dr. Mark Salita did an excellent job in modeling the erosion, and he developed that model based on a series of subscale tests that he conducted and then analyzed all the data from the flight motors and was able to predict the kind of erosion we were observing within plus or minus 12 percent.

We then took an O-ring and shaved it and kept shaving it and removing material until it would fail at three times the pressure we would ever operate at for a margin, and we found that we could shave up to about 155/1000 out of the 280/1000 O-ring before it would fail.

Mr. MINETA. That was roughly when you did that?

Mr. McDONALD. We did that in about mid-1984.

And then, subsequent to that, we took some hot firing tests where we focused a jet of gas on it to eat up the O-ring while the motor is igniting, much more like we see in the full-scale shuttle motor, except it was smaller scale.

The O-ring size is exactly the same. And we found out that we could erode the 125/1000 of that O-ring and we also maintain a good adequate seal.

In fact, we sealed it up to 150/1000 of it removed in one case, but between 145/1000 and 160/1000 sometimes it didn't.

So, it was in that same range that it would not seal that we found in our cold test at three times the pressure. So, on that data we had calculated, it was much like the insulation we have in the rocket motor.

It is a criticality one. The insulation of the whole rocket motor is exposed to the fire inside the motor for the full 120 seconds. And if

we are wrong in how that material behaves, it will burn through the case and it causes a catastrophic failure.

We calculate how much margin of safety or what the safety factor is on that insulator and that insulator in most cases has a factor of safety of two.

We calculated how much safety factor we had on the O-ring, and it was over two, because the duration at which the O-ring gets this erosion is during the first 600 milliseconds when the motor is pressurizing.

So, we felt that we had as good margin on erosion of the O-ring as we had on the insulator at that time.

Now, some people say, yes, but look, you are talking about milliseconds here, and if you are off, it is a big deal, and it is.

But you must consider the complexity of the shuttle system. When we ignite the two solid rocket boosters, if one of those boosters doesn't thoroughly ignite exactly the way the other one does within a couple hundred milliseconds, it will turn the whole vehicle over. You have a catastrophic event.

So, you are dealing with those kinds of engineering judgments and analyses. And it was our conclusion that it was safe to fly, even though we had that kind of erosion, as long as we kept it within what we had been able to predict, what we had shown took to fail it, that we had a good margin and we understood it.

That was our experience base.

Mr. MINETA. We had a blowby on STC, was it 51-C?

Mr. McDONALD. That is correct. And I would like it addressed.

Mr. MINETA. That was when?

Mr. McDONALD. That was in January of 1985. So, up until that time we had never seen this phenomena of blowby.

Mr. MINETA. What did you do then?

Mr. McDONALD. What we did at that time was to try to analyze that situation to understand why we saw that, what was different about 51-C over the previous flights before that when we didn't see it.

And we went to the flight readiness review for the next flight, which we were required to every time explain any anomaly, what we understood about it, and why it is safe to fly the next flight.

The conclusion we drew at that time is the only thing that we could conclude caused that blowby, was that that particular flight was preceded by the three coldest days in Florida history, and it was cold.

Now, we didn't expect to see the three coldest days in Florida history every time we went and flew, so the conclusion was on the very next flight it certainly won't be the coldest 3 days in Florida history again, and therefore, the next flight should be acceptable because it shouldn't see this type of behavior.

Mr. MINETA. So, that was when you first, then, became aware that the temperature played a role in erosion?

Mr. McDONALD. That is correct. That is the first time and that is when Mr. Boisjoly and Mr. Thompson and people started running some tests to confirm whether our suspicions was that the cold temperature may have affected that sealing capability in the O-ring.

Mr. MINETA. Had you gone back to any flight readiness review prior to the one just immediate to the one that was being launched in taking a look at those anomalies?

Mr. McDONALD. Oh, yes; we continuously did that.

Mr. MINETA. As I understand it, the procedure was to just look at the immediate preceding one and not look at a series of flight readiness reviews in order to see, what I would call, a trend line?

Mr. McDONALD. No; we continuously kept track of all of those, but our immediate concern was, are we seeing things that we have never seen before, and are they outside of what we have seen before, because if they are, they are clearly different and we must explain why they are different.

Mr. MINETA. Finally, then, did you ever get to the point of saying, yes, we have to change it, in terms of that 53-degree criteria?

Mr. McDONALD. Well, yes, we got to the point in July, as a result of the problem we had with the nozzle seal, the conclusion we need to make some changes in those joints.

Mr. MINETA. And that was when—

Mr. McDONALD. That was in July 1985.

Mr. MINETA. Thank you very much.

Mr. ROE. The time of the gentleman has expired.

The Chair recognizes the distinguished gentleman from Pennsylvania, Mr. Walgren.

Mr. WALGREN. Thank you, Mr. Chairman.

Going back to the questions about design specifications and how the system was asked for at 31 degrees and then accepted at 40 degrees, my impression of the document that you gentlemen prepared, asserting the acceptability of 40 degrees, that document was written as you presented the motor, as I understand it. Is that right?

You were substantially through the process of designing the motor and this was the acceptance at that point. Is that correct?

Mr. McDONALD. Correct.

Mr. WALGREN. My question, then, is where did that 40 degree number come from? It appears that NASA agreed to the 40 degree number or a group of people agreed to the 40 degree number, but it is, at that point, coming out of thin air.

Is there any tracking of that number? Where did it originate?

Mr. McDONALD. The 40 degree number?

Mr. WALGREN. Yes.

Mr. McDONALD. The number came from the specifications that we were supplied for the solid rocket motor to operate over a propellant mean bulk temperature of 40 to 90 degrees Fahrenheit.

It was in our specifications.

Mr. WALGREN. That was the original specification, is that correct?

Mr. McDONALD. It is the same one we have now.

Mr. WALGREN. Is that the same specification as the 31 degrees?

Mr. McDONALD. No; the specification as to 31 is a JSC, Johnson Space Center specification, that is referenced in our specification, I think volume 07700, referenced some vehicle specifications that are part of ours.

And you go to that document and it comes up with a 31 to 99. It says that the elements of the shuttle must withstand 31 to 99 degrees.

It doesn't say they have to operate under those temperatures; it has to withstand it.

And we have a lot of environments that we have to withstand, and we have certain environments we have to operate under.

We have to withstand coming across a blizzard in Wyoming, also, where it is even colder, but we don't operate under those conditions.

We have to withstand storage over a wider temperature range we operate over. We have to withstand sitting on the launch pad for some undetermined period of time under some environments, and we have to withstand any influence from other parts of the system and that is where I think the confusion came in, probably, earlier on how people interpreted that on what the motor actually operated under and what it had to withstand.

And those documents, in my opinion, make it very clear. It says "withstand," and that was probably where the misinterpretation came from.

Mr. WALGREN. And there is no design specification saying it shall operate at 31 degrees?

Mr. McDONALD. I couldn't find one.

Mr. WALGREN. And the temperature at launch was what, again, was—

Mr. McDONALD. Well, I believe the ambient temperature was 36 or something at the time 51-L was launched.

Mr. WALGREN. So, we were launching below the design specification at that point.

Mr. McDONALD. Well, in my opinion, from what we had qualified, or everybody thought we had qualified, the motor for, we were.

That was my argument with Mr. Mulloy and Mr. Reinartz after the teleconferences, why I didn't understand why they could accept the recommendation, because it was my interpretation that the recommendation was outside of what everybody thought the motor was qualified to.

Mr. WALGREN. And they did not assert that it was qualified to operate at that range. They simply fell back on arguments that, look, the seal didn't seal at 75 degrees or there are circumstances, doesn't seal at 75 degrees, so why should we worry about it.

Is that essentially it?

Mr. McDONALD. Mr. Mulloy showed how essentially ambiguous that specification was, because yes, he understands there is 40 to 90 degrees, but that the propellant mean bulk temperature—and that is what it refers to, which, in his mind, says it can be exposed to much colder temperature than that—as long as the propellant mean bulk temperature is within those limits.

And I told him at the time I thought that was asinine, because the propellant in that motor is so large and such a massive insulator that I could expose it to 100 degrees below zero for several hours and only change the propellant mean bulk temperature by a few degrees, and I know the spec didn't really mean us to do that.

That was a comment I made to him that night.

Mr. WALGREN. So, there never was a specific operating temperature that you received.

You received a withstanding temperature of 31 degrees and you received a propellant mean bulk temperature of 40 degrees.

Mr. McDONALD. That is correct, and that is why I said yesterday it is a lousy spec. It didn't get any better overnight. It is still a lousy spec, because it doesn't specifically say that.

Mr. WALGREN. Thank you, Mr. Chairman.

Mr. ROE. The Chair recognizes the gentleman from Missouri, Mr. Volkmer.

Mr. VOLKMER. Thank you.

Mr. Boisjoly, what happened between the flight readiness review on the 51-I and the January 27 telecon before, in other words, the first one, that persuaded you that the Launch Commit Criteria should be changed to 53 degrees, in the past it had been 31 degrees?

Mr. BOISJOLY. The teleconference of the 27th, is that what you are referring to?

Mr. VOLKMER. Yes; what persuaded you at that time to say you shouldn't launch between 53 degrees temperature?

Mr. BOISJOLY. Because the previous year 1985 January, that was the predicted O-ring temperature in that environment. We had blowby but we had characterized that the erosion part of that blowby was less than we had experienced before, and we would have been operating within our experience base.

Mr. VOLKMER. It was based on that and all the flights inbetween had been above 53 degrees?

Mr. BOISJOLY. That is correct, yes. It was not uncharacteristic at all to operate within one's experience base.

Mr. VOLKMER. But in all of the memorandums, et cetera, that had occurred before—inbetween the time, January 1985 and January 1986, you don't specifically say that, you basically say low temperatures—we need to look at this joint problem and do something about it.

Mr. BOISJOLY. That is right, and I so testified or submitted written testimony to the Commission to the effect that we had just experienced the three coldest days in Florida history the year before. And that would be analogous to a 100-year storm from a rainstorm or something like that. It was nobody's expectation we would ever experience any cold weather to that degree before we had a chance to fix it again, so that basically is why it wasn't pursued any further than that from my personal standpoint.

Mr. VOLKMER. In other words, you saw no need at that time then to try to change the criteria in March, April, May, June on through?

Mr. BOISJOLY. That is correct.

Mr. VOLKMER. Because of that, you didn't expect to experience it again anyway?

Mr. BOISJOLY. That is correct.

Mr. VOLKMER. OK.

Now, yesterday we had the testimony, and the Commission report bears reference to it too, that the Reinartz, when you finished up the second telecon, the one that Morton Thiokol had given approval and you were back in Utah, did you hear Reinartz say or

anyone else have any further comments or anybody disagree with the recommendation?

Mr. BOISJOLY. Yes.

Mr. VOLKMER. And you said nothing.

Mr. BOISJOLY. That is correct.

Mr. VOLKMER. Can you tell me why?

Mr. BOISJOLY. Yes; we had—Arnie and I, Arnie Thompson and I had fought vigorously against the launch and were two of the prime movers in preparing the charts that gave the information, technical information against launch. The first decision was made not to launch below our experience base and we were quite pleased with that. When we went off the line and caucused—one of the first statements that was made is that we have to make a management decision by management people. And we continued very strongly to oppose that. And we argued as vigorously as we could argue, and when you look up into people's eyes you know you have gone about as far as you can go.

And so both Mr. Thompson and I just plain frankly backed off. You had to be there and you had to see the looks and feel the experience that it didn't really make any difference what further you were going to say, you were just not going to be heard.

Mr. VOLKMER. Did you get that same impression from the Marshall people that were in the telecon, Mulloy and Reinartz and them?

Mr. BOISJOLY. I was unable to look into their eyes—

Mr. VOLKMER. For the tone of their voice.

Mr. BOISJOLY. The tone of their voice as I so stated, I felt that there was pressure, and I felt that the tone of the meeting had changed. And I think I stated that before; that we were always put in a position and quite frankly in many respects nitpicked to prove that every little thing that we had was in proper order and had the proper engineering rationale and data to back it up in order to fly.

And in this instance we were being challenged in the opposite direction. So that is why I didn't speak up, it was a management decision at that point in time, and I had nothing more to say.

Mr. VOLKMER. Thank you very much.

And as far as you know, Mr. Kilminster, did anyone at Wasatch inform anyone other than the Marshall people in the telecon, either level I or II, of any of these concerns?

Mr. KILMINSTER. No, sir, I had no advisability of that from Wasatch.

Mr. VOLKMER. Did you at any time have any contact with either Houston or headquarters?

Mr. KILMINSTER. As far as this night was concerned?

Mr. VOLKMER. Yes.

Mr. KILMINSTER. No, sir.

Mr. VOLKMER. All right. The last question I would like to ask you is, well maybe it won't be the last one if I have time, but it is very important to me. We have seen a considerable number of tests since the accident on the 28th, and these tests have brought about some eye opening to some people. We heard testimony of that yesterday. My question to the people at Marshall was, and the same question I think applies to you, since you developed this motor, is

why weren't those tests done before the accident rather than only afterwards?

Mr. KILMINSTER. I think as we have discussed we had an ongoing activity, a fairly concerted activity starting with August 1985 to address these matters. However, as we conducted the program and as these anomalies would become known to us, specific analytical techniques and specific tests were conducted in order to insure that we would have a safe flight condition.

And that started relatively early in the program where we tightened up tolerances on the nozzle, excuse me, on the field joint. We increased O-ring sizes, we initiated the use of shims in order to compensate for the rotation that was going on there.

Later on, when we did detect the erosion condition, we conducted analytical calculations to identify what limiting parameters there were there and what is the maximum extent of erosion we would expect to see, and found that it was well within the data that we had generated by tests that the O-ring could withstand and still seal.

As we were marching along, we were meeting these things head on on an individual basis in order to insure ourselves that it was safe to proceed. At the same time, having O-ring erosion was not a desirable circumstance, and we had activity going on in order to pursue that and try to eliminate it altogether.

And as we discussed yesterday, the putty is the prime actor there of keeping the hot gases away from the O-rings, so much of our initial work had to do with lay up, cleaning of the joint in order to insure that we had the proper putty configuration in there.

Mr. VOLKMER. I don't believe you answered my question; were you going to conduct the tests if we hadn't had the experience with 51-L and we have had a fight with the—would you have done the same tests we had done since the flight? Let me put it that way.

Mr. KILMINSTER. I guess I can't answer that specifically. We had identified a long lead procurement of steel bullets in order to accommodate a joint redesign. We had identified some tests that would be conducted to further evaluate the blowby. But as far as some of the dynamic testing that was conducted subsequent to the accident, I don't know if that would have been done or not.

Mr. ROE. The time of the gentleman has expired.

The Chair recognizes the distinguished gentleman from Idaho, Mr. Stallings.

Mr. STALLINGS. Thank you, Mr. Chairman.

Before I raise several questions this morning, I would like to express my appreciation to Morton Thiokol officials for their cooperation during the Presidential Commission investigation. Morton Thiokol as well as the other witnesses who have appeared before this committee I believe deserve acknowledgment for their efforts.

The Rogers Report was critical of the decisionmaking process and the lack of safety concern. While I recognize many serious mistakes have been made, I think it is important the record show what the history has been of Thiokol's past performance.

Mr. Garrison, your company has been the sole source of the solid rocket booster for the space shuttle for some time. How long have you been working on that contract?

Mr. GARRISON. I believe we received that contract in 1974.

Mr. STALLINGS. How would you characterize your performance on that contract?

Mr. GARRISON. I think the methods that we measure by has been very good. We have been in an underrun position from a cost standpoint, including the development contract and production; since we have been in production, we reduced the price of our delivered units by a significant amount, as much as 20 percent, I believe, based on the first unit and the last one delivered.

And of course we had planned to make some additional capital investments that would drive that cost down even more. I believe we met all of our schedule requirements, and in our opinion we have met all of the specification requirements, so we are proud of our performance on this contract up until that time.

Mr. STALLINGS. Have there been any incentive awards on the contract?

Mr. GARRISON. Yes; we have done very well on the incentive awards. We have gotten very high ratings in the award system, yes.

Mr. STALLINGS. Do you feel that your company will make some modifications, will change some policy as a result of this incident and these events?

Mr. GARRISON. Well, we are in the process of completely looking at our systems, our people, our organization from top to bottom, and this has called for a complete reassessment. We are in the process of doing that and we will do it. It is my intent that this—an event like this with the confusion, confusion may be a bad word, I would say the judgment of various people will be criticized at a higher management level and dealt with there.

Mr. STALLINGS. Thank you very much, Mr. Chairman.

Mr. ROE. I thank the gentleman.

The Chairman recognizes the distinguished gentleman from Florida, Mr. Nelson.

Mr. NELSON. Thank you, Mr. Chairman.

Mr. Chairman, I think it is important here to again underscore—Mr. Chairman, I think it is important to underscore the point that you brought out earlier, which is that there has been a communication problem. That the communication problem has been on both ends of the line of the communication; that it includes NASA as well as we look back into the flight—look back into the facts, as well as the contractor.

And so I want to explore again in—to the degree of misunderstanding that occurred to find out how this decisionmaking process was flawed such that the motor had never been tested to the extremes of temperature that it should have been.

Now, earlier in the testimony, I notice NASA testified to this yesterday, it was stated, and I would like your response to it Mr. Garrison, it was stated that they signed off on the verification certification before STS-1 and STS-5. Because they had been told by Thiokol that sure, the ambient temperature and the induced temperature on the solid rocket motor had been met because the military specification of the O-ring was that it would go down to minus 30 degrees and up to plus 500 degrees Fahrenheit.

Did in fact that communication go from Thiokol to NASA? Mr. Garrison.

Mr. GARRISON. I am not familiar, obviously. I was not in the details. I will ask Mr. McDonald or Mr. Kilminster, whoever may have that knowledge.

Mr. NELSON. Mr. Kilminster.

Mr. KILMINSTER. My understanding of the analytical work that was done, and, by the way, I think we need to be sure to clarify that that qualification can be accomplished not only by testing but also by analysis, also by similarity, that type of thing.

Mr. NELSON. That is correct, the design spec, by the way, required both for ambient temperature and for induced temperature to be by analysis. That is what is contained within these documents.

All right. Go ahead, please.

Mr. KILMINSTER. As I mentioned yesterday, in researching this, I think you will find that the fracture critical items, which includes the steel in the case, the steel parts of the ignition system and some of the steel parts of the nozzle, were qualified by analysis on a fracture mechanics basis at 20 degrees.

Mr. NELSON. All right. That is prefatory. Now let's get to my question.

Do you want me to repeat the question?

Mr. KILMINSTER. Please.

Mr. NELSON. Did Thiokol relay to NASA that these temperature analyses had in fact been met because you were using an O-ring which had already been certified to the military specifications which was down to minus 30, and up to plus 500 degrees Fahrenheit.

Mr. KILMINSTER. I can't comment specifically that there is a piece of paper in the system that says that.

Mr. NELSON. Well, that is what NASA said yesterday. Is there anybody in your organization that can answer that question?

Mr. GARRISON. Not here.

Mr. NELSON. Well, let me ask you this: Is, in fact, that O-ring—does it have a military spec from minus 30 to minus 500.

Mr. KILMINSTER. Yes, it does. It is a procurement spec.

Mr. NELSON. So it is conceivable that what NASA said yesterday is accurate, that someone said, well, we have completed the certification because that is what the military spec says.

Mr. KILMINSTER. That is conceivable.

Mr. NELSON. Okay.

Well, now, as we examine this, we realize that that wasn't correct, because this contract required more. Now let me get to that, because you all dispute the reading of this design specification.

This morning you gave this document dated April 1960, and of which you are citing, as, Mr. McDonald, you apparently all along have thought, that the temperature specs were 40 to 90. It is fairly clear to me from reading these documents that we are talking about two different things. We are talking about 40 to 90 degrees is the propellant bulk mean temperature, which is the temperature of that solid rocket propellant, which changes very slowly over the course of time.

As a matter of fact, some of your testimony to the Commission said you could have minus 100 degrees outside, and the propellant

temperature is only going to change a few degrees over a long period of time. That is one indication. That is one criteria.

It seems to me that these design specs also clearly state that there is another requirement regarding temperature, and that is from the ambient air temperature otherwise defined as natural environment under this document volume 10, and also another definition of induced environment, and they go on through the various appendices to determine and to define what each of those are in terms of degrees.

You still maintain that that is a part of the design specs that you all did not understand?

Mr. Garrison.

Mr. GARRISON. First off I would like to say that we didn't dispute your reading of the document.

Mr. NELSON. No, I understand. I am trying to get inside your head.

Mr. GARRISON. We have an interpretation problem, and I would like to reiterate again that this interpretation was basically made 12 years ago.

It has followed, and I believe everyone has been in agreement with our interpretation that has been involved in the program, so there was no reason for us to think until this time that it was incorrect, so I believe that we are talking about an interpretation, and I frankly don't know how we resolve that at this point.

Our interpretation, as I stated to you, based on the people that I talked to and our people were involved, as we stated, and I can't change that. It might be wrong. It was made 12 years ago, and I said we have been operating and everyone has been concurring that that was the correct interpretation.

Mr. NELSON. You know what we are trying to do here, as the modus operandi as set by the Chairman is trying to get the truth, and I understand you are trying to give the truth, and that is what we are trying to find out.

The fact is NASA came up and said they messed up, and you are saying you didn't mess up. You are saying you might have messed up, and we are just trying to find out what was the degree of your thinking.

I have already said prefatory to my comments, you know, you are not entirely at fault. I mean, there is a lot of blame to go around here.

Mr. GARRISON. Congressman Nelson, I think you will have to admit that it would be unusual for us to go say sometime after we had made our interpretation that we believe you are wrong in your interpretation. They wrote the spec.

I think Mr. McDonald has expressed his opinion that he thinks the spec is confusing, and open to misinterpretation, and that may be our problem, but we honestly thought we were meeting the intent of the specs, and we thought that for 12 years.

Mr. NELSON. Mr. Chairman, I have one more question.

I could not help but reminisce, as we have heard this whole conversation, and we have heard these temperatures, 40 to 90, and we have heard many times the reference to 53 degrees, and Mr. McDonald's concern about not launching below 53 degrees, because in fact that was the coldest temperature of any previous launch,

and he knew that there had been severe O-ring degradation on that launch, so my question is, which I couldn't help but reminisce, STS-61C, that finally launched on January the 12th, we were scrubbed four times, and during several of those scrubs, the temperatures were less than 53 degrees, and so my question is, did any of these same concerns with the temperature come up in discussions during the final checks before those attempted launches?

Mr. McDONALD. I am not aware that they had, Congressman. I don't know. I wasn't at that launch, but I don't recall that that came up.

Someone would have to relay what the temperatures were expected during the time period before and after, because if you will recall, the 53 degrees on the previous coldest one, when it actually launched it was actually 60 some degrees, I believe, the ambient temperature, and that 53 degrees is an O-ring temperature that is calculated from that, and you have to know what the temperature history is to arrive at what the O-ring is.

Mr. NELSON. Mr. Chairman, I will just conclude with that. I thank you.

The temperature was on or about in the low 40 degrees on December the 19th, during the first scrub of STS-81C, in the low 40's, the ambient air temperature.

Thank you, Mr. Chairman.

Mr. ROE. The Chair recognizes the gentleman from California, Mr. Packard.

Mr. PACKARD. Thank you.

Mr. Chairman, I would like to pursue that a little bit further. I think, Mr. McDonald, you expressed that for this launch we experienced the 3 coldest days in, what, the history of Florida, at that time?

Mr. McDONALD. That was what was reported to us on the January 1985 launch, that is correct.

Mr. PACKARD. What was the temperature on this flight 51-L that was scrubbed three times—

Mr. McDONALD. That is correct.

Mr. PACKARD. What was the temperature on the 22d when it was first scrubbed?

Mr. McDONALD. The 22d? I don't know what it was then. I was down at the scrub the day before.

Mr. PACKARD. What was it the day before on the 27?

Mr. McDONALD. During the launch window from 0938 to 1238 it ranged between 48 and 57 degrees.

Mr. PACKARD. So, it was below the 53 at least part of that launch window.

Mr. McDONALD. That is correct.

Mr. PACKARD. Was temperature discussed then?

Mr. McDONALD. No, it was not.

Mr. PACKARD. On any of the 3 scrubbed days?

Mr. McDONALD. Nowhere was it, no.

Mr. PACKARD. And the temperature dropped in one 24-hour period from 48 as a low down to below 29, possibly even down to 16.

Mr. McDONALD. Down to 22. They were predicting 18, and that was what caused the great alarm. You know, that doesn't happen very often in Florida.

Mr. PACKARD. Why, in your judgment, wasn't weather—when it had gone down on the windows before or on the scrub days before on 61-C, was it, and also in the previous scrubbed days of this launch where it was below the 53 level, where there was not data to justify flying, and where there was a policy that we wouldn't fly below those certain thresholds—why wasn't the weather discussed on those scrub days?

Mr. McDONALD. I don't—I can't answer that. I think that is an excellent point, and again, it is part of that communication problem.

I think that is an excellent point. I don't recall that anyone brought up the weather, what predicted temperatures were, because it was too much like we normally fly with, and I think that is an excellent point.

Mr. PACKARD. The erosion problems of the O-ring was known for several years before, and there was some data on that, and you were monitoring that.

The O-ring resiliency was not—there was no data or research done on that until June 1985, is that correct?

Mr. McDONALD. I believe that was the time period, wasn't it, Roger?

About February or March, he said, we started that.

Mr. PACKARD. You started. June 3d is referred to in the President's Commission as having some results from your research as far as the resiliency under cold weather of the O-rings.

In your testimony, Mr. Kilminster, I believe you said that, "As launch was scheduled,"—this is the night before, on the night of the 27—"As launch was scheduled for early the next day, our engineers immediately commenced evaluating the available data."

This is in reference to the cold weather and how it would affect the O-rings. You had had some data before. Why did you wait until the night before you began to even consider the whole question of O-ring resiliency and O-ring problem under cold weather conditions?

Mr. KILMINSTER. This was in response to a specific request that came from NASA earlier in the day, after they scrubbed on the 27th, around noon eastern time, I believe, and the prediction that they had at that time that there was going to be a significant drop in overnight temperatures.

Mr. PACKARD. And what did your review—immediate evaluation of the data—what did it show?

Mr. KILMINSTER. Well, there was a couple of areas of concern.

No. 1 was, would we be concerned about this propellant mean bulk temperature condition? So, analysis and quick evaluation was done there and said, no, that under the circumstances that we would not have any problem with propellant mean bulk temperature.

There was some assessment made of if it gets that low, if there is some gradient, some temperature gradient going from the case wall into the insulation and propellant, would that be a concern.

That was looked at and judged by engineering not to be a concern, and so the only one that was identified as being of concern was the joint issue.

Mr. PACKARD. Were you relying wholly on NASA's evaluation and judgment as to whether to overlook the cold weather and the O-ring?

Mr. KILMINSTER. No, sir. That was our engineering people who were conducting that assessment on all three of those items.

Mr. PACKARD. One last question, one that I dealt with with the people yesterday afternoon.

On page 146 of the Commission's report, it shows where there was, or that you were monitoring, the flights that—well, all flights were monitored in terms of O-ring degradation, and it showed no successful flights below 65-degree weather, no successful flights that had no O-ring damage done, 17 flights above the 65-degree level with no O-ring damage, but all flights had damage that was below that level.

Were you using this information on an ongoing basis to evaluate the effects of O-ring and cold weather?

Mr. KILMINSTER. I believe the task force, in conducting their activities, were looking for any correlation, correlations having to do with the shape of the segments as they were put together.

And I can't say specifically, but I think they were looking at temperature based on what we had learned on the earlier January issue.

But perhaps Mr. Boisjoly could answer that in more detail.

Mr. BOISJOLY. We had asked for that data as part of the team members and were in the process of gathering that data, and we had not yet received it.

Mr. PACKARD. So, Thiokol did not have access or did not use at least the information from previous flights in respect to the joint.

Mr. BOISJOLY. We did with respect to the joint on erosion, but with respect to specific launch temperatures on specific vehicles, we didn't have that specific data at that time.

Mr. PACKARD. It is easy, perhaps, after the fact, but do you believe that there was a general malaise on the question of temperature and its effect upon the O-ring joint up until the accident?

Do you think that this was a general disregard or a feeling that it was not as critical of an area, the temperature effect on the O-rings?

Mr. BOISJOLY. No.

Mr. PACKARD. Not as critical.

Mr. BOISJOLY. No, not at all, because I think my memos indicate just the opposite to that. I was extremely concerned about that.

Mr. McDONALD. I would like to comment on that information, because one of the gauges that we had used from the start—I think Mr. Mulloy testified to that yesterday, and he also challenged us to why we could continue flying—was the first time we ever observed erosion on a field joint O-ring was in the second flight STS-2, at 70 degrees Fahrenheit, and it was the worst and still was the worst erosion we had ever seen on launch.

So, you have got to take that data in some context.

Mr. PACKARD. I understand that.

However, erosion, I think, is not necessarily resiliency. I am not persuaded that it was the erosion problem that created the leak here as much as it was failure of the O-ring to seal, which could

have been erosion, but was probably more likely a lack of resiliency to seal off the gap.

Mr. McDONALD. I don't disagree with that. I am just saying they thought thermal stress, as observations on O-rings, as a function of temperature. You have to put that in perspective.

Mr. PACKARD. Thank you.

Mr. ROE. I thank the gentleman from California.

We are just about at a conclusion here this morning. There are a series of questions that the committee has prepared that we will be submitting to you in writing that we would like you to respond to, and some of them have really to do with—they are specific.

Some are technical in nature. I am thinking about the joint rotation aggravated by switching to lightweight steel.

I know that is something that is being worked on, the cases, and those sorts of things, but I think it would be invaluable to get that on the record in writing, and if you would be kind enough to respond to that we would appreciate it, to round out the record.

The gentleman from Florida.

Mr. NELSON. Thank you, Mr. Chairman.

Just one clarification, if you could help us here, Mr. McDonald.

On page 142 of the report, discussing the closure issue, it states: "On December 6, 1985, Thiokol's Brian Russell wrote Al McDonald requesting closure of the solid rocket motor O-ring erosion critical problems. He gave 17 reasons for the closure, including test results, future test plans, and the work to date of Thiokol's task force. Four days later, December 10, 1985, McDonald wrote a memo to NASA's Mr. Ware, asking for closure of the O-ring problem."

Can you share with us why you did that?

Mr. McDONALD. I would be glad to do that, sir.

The reason that Mr. Russell had originally addressed the memo to me on that subject was that he had received a telephone call from his counterpart at the Marshall Space Flight Center, Mr. Jim Thomas, who had apparently come out of a meeting or been given some direction by the director of science and engineering at the Marshall Space Flight Center, Mr. Jim Kingsbury, that he was very upset in the problem assessment system and this problem review board of this continuing long list of anomalies that were reported, and the list keeps getting longer and things weren't taken off, and some of them were getting relatively old, some of them back literally, years, and that list certainly had far too many problems that were over 6 months old, and we need to get that list down, and we must close some of those actions out.

In fact, he informed me that Mr. Wear, who is the one I usually communicated with, the manager of the solid rocket motor project, would probably be sending me a memo to that effect here shortly, which it did come, and that we need to get those off of those lists, and he put together a memo on what his position was as to why we ought to be able to remove the O-ring problems from that list, because we were tracking them on another system, in fact, weekly, not monthly anymore.

We had a task force that had a meeting, a teleconference, every week with the people at Marshall discussing what we were doing, trying to solve the issues.

And if you read the memo that I wrote, it says that we are going to continue that, and it is not an indication we solve the problem.

In fact, just the opposite. It is going to be some time before we can solve that problem, so if somebody wants to get this list down, they might as well take them off, because we are doing it in, I think, a more productive manner that is more visible, and therefore, let's take them off, and that is what I did it for.

Mr. NELSON. Did you raise the issue of the temperature questions at that point in your memo?

Mr. McDONALD. No, I did not, sir.

Mr. NELSON. This was just your memo in response to their 17 reasons stating that they wanted to close out any further discussion of the O-ring problem.

Mr. McDONALD. Right. There wasn't anything, I don't believe, on temperature there, no.

Mr. ROE. The time of the gentleman has expired.

The committee will stand adjourned. We are going to reconvene in 1 week Wednesday.

I want to thank the representatives from Thiokol for their up front, straightforward answers in response to the committee's questions.

As I mentioned, we will have some in depth other technical questions which we think will be helpful to the committee and we will submit those to you in writing.

We want to thank you very much.

The committee stands adjourned.

[Whereupon, at 12:25 p.m., the subcommittee adjourned subject to the call of the Chair.]

INVESTIGATION OF THE CHALLENGER ACCIDENT

(Volume 1)

WEDNESDAY, JUNE 25, 1986

HOUSE OF REPRESENTATIVES,
COMMITTEE ON SCIENCE AND TECHNOLOGY,
Washington, DC.

The committee met, pursuant to call, at 9:30 a.m., in room 2318, Rayburn House Office Building, Hon. Robert A. Roe (acting chairman of the committee) presiding.

Mr. ROE. The committee will come to order.

This morning we commence our third week in the series of hearings that the Science and Technology Committee is holding to investigate the space shuttle *Challenger* accident. Equally as important to where we will go from here in the overall national space program.

In following the overall plan for our inquiry, we heard first from Chairman Rogers of the Presidential Commission on the Space Shuttle Accident. The Commission, under the guidance of its distinguished Chairman, had conducted a detailed investigation of the shuttle's hardware and technology failures, and also a thorough analysis of the management decisions associated with the launch. Chairman Rogers presented the excellent report that grew out of the Commission's work.

Our second group of witnesses was headed by Dr. James Fletcher and was comprised of various other NASA officials involved in the general governance of the agency, as well as those specifically in charge of the Space Transportation System.

Third, we heard personnel from Morton Thiokol Co., the designer/manufacturer of the solid rocket booster's motor joint. The Rogers' Commission identified the faulty operation of this joint as the prime cause for the shuttle's failure on January 28.

On the same day, we heard from personnel at NASA's Marshall Space Flight Center. Since the Marshall Center has safety oversight responsibility for the SRB program, the committee considered it important to juxtapose the appearance of the Morton Thiokol and the Marshall Center witnesses.

Today we will be hearing from NASA's astronauts. These are individuals who are, or have been, the most direct participants in America's manned space flight programs. Their intense training encompasses knowledge of a vehicle's hardware and its specific function, knowledge of and experience with the special characteris-

tics of the space environment through simulation, and most importantly, inflight intimacy with space travel.

They are an extremely unique group of individuals who have been selected for excellence in judgment and expertise. We call on them today to provide us not only with their perspective of a mission's planning and execution, but also with their view of both the weaknesses and strengths in NASA's current program and operation.

This morning we will hear from Maj. Donald Slayton, Gen. James McDivitt, Capt. John Young, Col. Henry Hartsfield, and Comdr. Robert Gibson.

In this afternoon's session, Gen. Thomas Stafford will join us in a continuation of the proceedings.

Our ultimate goal in examining the causes of the shuttle accident is to strengthen the Nation's space program so that we can safely and steadfastly continue our pursuit of the dual objectives of space exploration and space development.

Gentlemen, I welcome you. I know that you can help us in our task.

We will begin after the remarks of Mr. Lujan, the distinguished Representative from New Mexico, and the Science Committee's ranking Republican member.

Mr. LUJAN. Thank you very much, Mr. Chairman.

I, too, would like to extend a warm welcome to today's panel of witnesses. There are few people in the world better qualified to talk about space flight than the astronauts who appear before us today for this hearing.

Mr. Chairman, it has been almost 6 months since the tragic *Challenger* accident. During that time in attempting to find the causes and the cures we have had a lot of criticism. So much so we tend to forget we have a great space program.

I happen to believe it is the best in the world. To illustrate my point, I might bore the committee with a little story that evolved sometime ago.

My granddaughter was talking about flying saucers. I told her that in southern New Mexico there had been sightings of space ships. We read about those all the time. I had been told they were expecting another sighting on a particular day. So I went down into the area hoping that I could see one.

It didn't come, so I stayed another day hoping to catch sight of one. One did finally come and I saw it. I saw it land. I might tell you, Mr. Chairman, this is a true story.

She asked me if I saw any creatures, and I said yes. She asked me if they were little green men, and I said no.

I then explained to her that the creatures were just like her and me. Their names were Jack Lousma and Gordon Fullerton, as a matter of fact.

The point of the story is I did see a spaceship land and it came from the United States, the only nation in the world to possess a machine that will carry us into space and return just like a regular airplane does.

Mr. Chairman, it is a dangerous operation. I have been told 2,700 things, criticality 1, and 1R can go wrong. I marvel every time I see

a shuttle land, usually within feet and within seconds of NASA's predictions when it left Kennedy several days before.

Our job is not to find fault for fault's sake only, but to learn from this experience, this *Challenger* experience so we can take corrective action. I am particularly grateful that members of the astronaut corps have agreed to share their wisdom of the years in the space program with us.

There are few whose knowledge of the program is deeper and command of issues broader than members of this astronaut corps. I look forward to hearing a frank assessment of the strengths and weaknesses of our space program today and when we are through here, I hope we can get on with the business of rebuilding our space program.

We really can't afford to wait much longer for major policy decisions to be made. The longer we wait, the harder and surely the more expensive it gets.

Thank you very much, Mr. Chairman.

Mr. ROE. I thank the distinguished gentleman.

We have two housekeeping matters to take up first.

Without objection, television broadcast, radio broadcast, still photography of the coverage will be permitted this week on the hearings held on the Roger's report, and there is no objection, and so forth.

The second matter is I move the proposed membership of the Science Policy Task Force that has been placed before the members be approved for 6 months commencing July 1, 1986.

Someone second that motion?

The gentleman from Pennsylvania second that motion.

All in favor, signify by saying aye.

Contrary?

So carried.

I want to thank you for taking your time to be with us as a distinguished panel and just for the members, just to reiterate, and for yourselves, we are on a tripart program here really. Some people had said and recently there were some news reports that were issued, an editorial or two, if the Rogers Commission did their work as they did, and did a good job, why should it be necessary that the Congress, namely the Science and Technology Committee of the House and our counterpart in the Senate, why should we be in effect holding additional hearings?

I kind of was surprised at that in a way because I didn't consider the issue to be concluded on the basis of the Rogers Commission report, nor has this committee, by the way, or the Congress. I think that is No. 1.

No. 2, the Rogers Commission made it very clear that the initial responsibility as given to them by the President in his directive was based upon the point of view of what happened technologically in effect, why was there an accident, what happened. Of course, we have been pursuing that and I am sure there will be questions and dialog relating to that tragic issue today from your point of view.

But second, in that tripart program, we want to look into the management structure as to really what has happened to NASA and not NASA bashing. That is not our purpose here at all.

We want to be able to take quantum steps forward to improve the situation so we can go back into space as quickly as possible, but safety is, of course, you know, No. 1.

So the second issue that we are devoting our issue to which you begin to bridge that gap now, as I see it—Manny and I talked about that earlier—is to start to look to what you see the role that the astronaut corps should play in the overall program.

There are some vast differences in those who participated in earlier manned flights as to what we see the institution beginning to develop into.

Then, of course, our third function, when we finish these phases of our hearings, will be to get into the long and short range policy issues, what does America and what does the Congress do and what do the people do, what do you do as far as the short range space program is concerned, getting back out there and what our goals will be in a major point of view for the long range issues. So that is where we are coming from. That is what these issues are about.

Now, having said that, I want to formally welcome you to our committee, and I guess Maj. Deke Slayton has been designated for us to call upon to make the first initial observations.

Does anyone have a formal statement? That is where I am coming from. Suppose we recognize now Major Slayton.

STATEMENTS OF MAJ. DONALD "DEKE" K. SLAYTON, USAF (RET.); BRIG. GEN. JAMES A. McDIVITT, USAF (RET.); CAPT. JOHN W. YOUNG, USN (RET.); COL. HENRY W. HARTSFIELD, JR., USAF (RET.); AND COMDR. ROBERT L. GIBSON, USN; LT. GEN. THOMAS STAFFORD

Major SLAYTON. Thank you for the opportunity to visit with you. I do not have a prepared statement. I didn't get notification in time to do that. I gathered from your letter, however, that one of your primary interests was in how the astronaut corps interfaces with the rest of the management team.

I guess being one of the more mature guys here at the table, I can probably relate back to how we started and where we ended up in the shuttle program initially.

I can't speak to what has happened since then. You have people here who are more talented than me that can speak to that. But at the time we came into the Mercury Program, there were seven of us flight crew, and one of the first things we did was to break up into technical areas of expertise. Each guy took a major technical area of the program to follow and to make technical inputs into. We all reported directly at that time to the Center Director, Bob Gilruth, and of course, we were a very small, tight organization at that time.

The precedence for that had been set by guys like Scotty Crossfield in the back of the room, who worked on the X-15, and probably put in at least 10,000 hours of engineering design for every hour he flew.

That is typical in this business, and we probably did about the same thing in the Mercury Program. We had a very strong voice directly into the engineering system. There were some things we didn't like when we came onboard.

The design was fairly well set, and we were able to influence the change in those and make them happen. Management listened to us. We had a lot of changes we proposed that were not adopted because somebody in the management chain has to make a management judgment in many cases.

Seven guys propose a problem to them, and they get seven different answers, and somebody has to decide which one we are going to implement. At the time the Mercury Program was about over, we had already committed to a lunar landing, and it became obvious we were going to have to get organized and expand the astronaut corps, and I had the misfortune at that time of having been grounded due to a medical problem, so I was elected to take over the management of the astronaut corps, a job I didn't particularly care about, but it was the next best thing. So, then, we had submerged the rest of the corps down one level below the Director, because they now reported through me to the Center Director.

A few months later than that we brought another group of astronauts onboard, including John Young and Jim McDivitt to my right, and then at the same time, it became obvious that the organization was going to have to expand very, very rapidly and get much bigger, and we reorganized into a flight crew operations directorate.

So, my function was then elevated to not only encompass the astronaut corps, but the aircraft operations and everything related to flightcrew training, the simulators, procedures and crew equipment.

I ran two jobs at that time. I was Chief of the Astronauts, and also the Director of Flight Crews, but I was still reporting to the Center Director. Shortly after that, Al Shepard had the misfortune of getting grounded, which was good fortune for me, because I put him in charge of the Astronaut Office at that time. From then on through the early part of the Apollo Program, that is the way we operated. So, inputs from the flight crews generally went to Alan; from him, they came to me, and then they went on in to the system.

We had a system in those days which still exists, I believe, where the program managers ran a configuration control system. Originally they were design reviews. Flightcrews participated intimately in all those. Once the design was fixed, then you had the configuration control system. I always represented the crews on that particular system. Any inputs coming in came up through channels, and I am sure there are some changes that people recommend on occasion that didn't get in that they thought should have, but, as usual, when you get 50 smart guys, they have got a lot of different ways of doing things, and you have to nail down one, and say this is the way we are going to go.

There is another factor at work, and that is that there are a lot of people in the engineering elements, the subsystems, who would have a pet idea they weren't able to float up through their element of the organization, and it was always nice to be able to go and tag an astronaut somewhere and get him to agree with them, and then they could come in and say, hey, this is what the astronaut corps wants to do, which would give them some extra leverage. We had to be very careful of that. We could only have one astronaut posi-

tion come in relative to a particular change. But this was a continuing dialog and an ongoing thing, and I think it worked very well, and these guys can tell you whether it worked as well as I thought it did. They may not agree with me. But I think certainly the astronaut corps in general, and in total, had a voice in all elements of the design, the development and the operation.

When we got down to the flight readiness review aspects, again, I was a member of that board. I had the option at any point of saying hey, I don't think, this flight is ready to go, and we don't want to go. It was my job to deliver the crew to the pad for the flight, and I surely would never have taken one down there if I thought it was unreasonably safe, recognizing that none of them are ever safe. That cannot be guaranteed, but it is a qualitative thing. If I might dwell on that for one second, back in the Mercury program, when we flew Atlas we had an 80-percent probability of success, and that was considered acceptable because it was the best we knew how to do.

You wouldn't send a shuttle crew down with an 80-percent probability of succeeding. So that kind of summarizes it. I think I can take one more step while I have the floor, and that is when I got a chance to fly in the Apollo-Soyuz I did, and came back into a different management role, and that was program management, and I no longer had direct responsibilities for the flightcrews.

I had responsibility for the program. But again, the crew always had a direct input to whatever we did, and under no conditions would I have ever committed a flight either to approach a landing test or the orbital flight I was responsible for, without having the crew's concurrence in it. The crew commanders always had a strong voice in whatever we did, and I don't think again, they can speak for themselves. But when a guy was assigned to a flight he essentially became commander of his own ship, and he was responsible for keeping that crew tied together and doing the things necessary, and we were all there to help him do that job. What has changed since 1982 I can't speak to. I will stop here. Thank you.

Mr. ROE. I thank you, Major.

How about General McDivitt? Your observations, please.

General McDivitt. I am glad I have an opportunity to follow Deke, because I sort of would like to continue on with the same train of thought that he had. During the time that I was an astronaut, I participated in the program as described by him.

I always felt that I had a route to the top, a very direct route, didn't have anybody that would stop it as long as I had a decent idea. The point that Deke makes about trying to pull together the ideas of 7, 16, 20, 30, 50, or 100 astronauts, it is a difficult thing to do. When you have a generic issue that deals with the entire program, to be able to speak with force and have respect for the position that you take, you have to speak with a single voice.

We always did that, at least I thought we did. As Deke mentioned, some of our ideas didn't get through the filters and sometimes they did, but at least we stood together and we had a unified astronaut position that went forward.

When I got to be a crew commander, those things which were flight-specific for that flight, I felt were my responsibility. We talked them over if they were generic, but if they were flight-spe-

cific, I could deal with the program manager or through Deke, and I had a way to the program.

Later on, after I stopped flying as an astronaut, I became the program manager for the Apollo Spacecraft Program. Looking at it from the other side, I felt that if I needed a position from the crew for a specific flight, I could always go to the crew commander and we could discuss that issue.

If I needed a generic program-related issue, I could go to Deke, and we could work out what the astronauts' position was as a whole, and it swung a lot more weight than 50 different voices coming to me.

I chaired that Configuration Control Board that Deke talked about for 3 years, and on it I had representatives of the Flight Operations Directorate, the ground crew; I had the flightcrew; had the program managers that reported to me for the command and service module, for the lunar module; I had an associate program manager for safety; I had my systems division chief; and I had a secretary that looked after it; and we had the contractors represented on the Board, too, one for the command and service module, one for the lunar module.

At those meetings, we had the official astronaut input. Sometimes I would agree with it, and sometimes I wouldn't, depending on how it affected the programmatic issues which I had to deal with. As Deke said, he was forced into pulling together the various viewpoints of the astronauts and coming up with a single position for the Astronaut Office. I was forced into pulling together a single position for the program considering what was said by the astronauts, what was said by Flight Operations Directors and other people, and in pulling together that Flight Program position.

I must say, though, while I found in favor of the astronauts sometimes and against them other times, we never had an issue with respect to anything that dealt with safety of flight.

Deke knew that—I am sure he knew—that if we had a safety of flight issue, we would get it resolved very quickly. We never flew with open issues on the spacecraft, and we had a method through that Configuration Control Board of dealing with all the issues that came up in the program.

So, I found there was a role for the astronauts in the Astronaut Office in bringing their ideas up, into, and through a formal management structure to the program manager. I found that being on the program side of it, I had to have that single point of contact where I knew what the astronaut position, was.

As Deke mentioned, there were a lot of guys who had pet ideas that tried to get the endorsement of an astronaut, so it could be the astronaut position. But unless it came out of the Astronaut Office and through Deke, it wasn't the astronaut position.

So we had a very rigid, formal process that we went through, and there weren't any loose ends about who was really representing this position. I knew who it was.

Thank you.

Mr. ROE. Thank you, General.

How about Captain Young?

Captain YOUNG. It is a great honor for us to be here today to talk about this. We have a little different situation now. We have

about 88 active astronauts, and they are scattered throughout the agency right now across all lines.

In management, there is Dick Truly, up here in Washington in the Office of Space Flight. Serving with him right now is Captain Crippen, trying to decide how to organize the management structure of the Space Shuttle Program.

We have in Houston, Charlie Boland who is the Deputy Technical Assistant to the Director of the Johnson Space Center. In the program office working for Arnie Aldrich's level 2 board, we have Brian O'Connor, Technical Assistant for Operations, and we have about seven or eight others directly involved in the management scheme.

But we do get together just the same as everybody did in the old days and discuss things over Monday morning meetings, and decide what our positions are going to be with respect to various projects and then we go through our chain of command, through the Director of Flight Operations, through the Director of the Space Operations Directorate, to the Director of the Johnson Space Center, and come up with issues.

I think there is probably one difference of what we used to do in the old days and what we did prior to the 51-L accident. That is because people started, I believe, and some of the agency believe the space shuttle was operational in the sense that you really didn't have to think as much about issues involving safety as we really should have thought about it.

Some of this was self-generated on our part. We are taking steps to correct that right now. We have crews participating at the Kennedy Space Center and our technical panels reviewing paperwork and preparedness. We have crews participating in the design of the solid rocket booster redesign at the Marshall Space Flight Center. Commander Gibson is leading that group and he has Mark Brown working for him, Mr. Mark Brown, and also Dave Leestma working with the main engine people over at Marshall.

So we have people all over the agency that are working now helping us to correct the 51-L accident. We agree with the conclusions of the Commission in their entirety because, as you know, and the recommendations, all data that analysis was made from was provided for by the National Aeronautics and Space Administration, so it is kind of easy for us to agree with those recommendations.

And we support them wholeheartedly. The Astronaut Office right now is participating in the best way that we can to return this agency and the space shuttle to safe operating conditions. We think that what we are doing is the best that we can do in every way for this country to make the shuttle get back to safe operating status as soon as possible.

Thank you.

Mr. ROE. Thank you, Captain.

How about Colonel Hartsfield?

Colonel HARTSFIELD. Mr. Chairman, I can only echo what John has said. In respect to how we handle issues in the office, I have always said if you ask 12 astronauts, you will get 13 opinions on a subject.

But we do raise a lot of issues that we certainly don't agree on. But we have after our Monday morning taking up—and we do taking up every Monday morning, which was the custom when I arrived at the office, and the way Mr. Slayton ran the office when I came there. We discuss the problems that have arisen over the last week and everything that is going on, so we all have a common starting ground at least from that week, but from time to time we raise issues that are not agreed upon.

So we have little specialties we call issue meetings and we get everybody together and discuss the issues and hear all sides of it and come out of there with a consensus opinion that becomes the position for the astronaut office. We have done that as long as I have been there and that is the position that we try to take forward then to the control boards and the other elements of the organization that handle these issues.

Now, again, I would agree with John, I fully support the Commission's report. I think what they have recommended is the right thing to do. We have people spread out, as John said, working on different aspects of this retrospection period we are going through, looking at all facets of the program, the maintenance, the critical items list, and our flight rules and one message that I think we are trying to carry to all these people is the idea of safety. Safety has to be the key and what we are trying to do is build an attitude. Safety is an attitude and it is an attitude that we are trying to engender throughout the Agency.

I am reminded of a story that Ken Mattingly used to tell when he was getting ready to fly on Apollo 16. He went out to the pad and was climbing around the Saturn 5 out there and went into an inner area and there was a workman back there with a wrench, and Ken spoke to him and asked him how he was doing. He said, doing fine. And he told Ken, "I don't know how this complex machine works and I don't know too much about your job, except I admire you, but I will tell you one thing, it is not going to fail because of me." Now, that is the attitude I think that we have to get through this Agency.

Mr. ROE. Commander Gibson.

Commander GIBSON. Thank you, Mr. Chairman.

Let me add my sentiments to Captain Young's. We certainly do concur with the Commission findings and we support the recommendations and we are going to do everything that we can to implement all of those and come back from that accident.

I can probably speak about the working relationship within NASA from the new guy's standpoint perhaps, being from one of the later astronaut groups in 1978. We found during all of the testing and the support that we did leading up to the first flights of the shuttle, that the working troops within NASA, the working level people, were very ready and willing to take our recommendations to improve the testing and to facilitate getting the thing in the air.

As General McDivitt said, later on as a crew commander I was able to find that the system was very responsive to any inputs that came from the crew commander as such and I guess maybe in the past we have had—perhaps our problems have come from where

we didn't have total agreement, maybe, between the crew viewpoint and some of the viewpoints within NASA.

The tires and brakes are probably a good example and my fellow crewmember, Congressman Nelson, I am sure, will remember us discussing the brakes at great length. I think that the primary disagreement there came from, in our area, where we felt the brakes were a safety item and that other people thought that the brakes were more of a reuseability issue. So we didn't always have total agreement on where our safety problems were, where our reuseability problems were, but for the most part, I think we are working within the NASA organization and we are well received and, as I say, we are working to come back.

[The prepared statement of Commander Gibson follows:]

Statement of

Robert L. Gibson
Henry W. Hartsfield, Jr.
John W. Young

National Aeronautics and Space Administration

before the
Committee on Science and Technology
United States House of Representatives

Mr. Chairman and Distinguished Members of the Committee:

It is an honor to be here to tell you how the Astronaut Office is responding to the Presidential Commission on the Space Shuttle Challenger Accident with respect to those recommendations which directly concern astronauts. First, we believe the Commission did an outstanding job with a technically complex subject. We support all the Commission recommendations without reservation and intend to do our best to insure that these recommendations get implemented. As you know, the data on which the Commission reached its conclusions was provided by NASA; therefore, it is easy to agree with the recommendations. All these recommendations, we sincerely believe, are aimed at helping NASA do a better and safer job in the future.

With respect to the use of astronauts in management, we have astronauts working across the Agency. As you know, Captain Robert Crippen is now in Washington assisting Admiral Truly. In Houston, we have Charlie Bolden as Special Assistant to the Director of the Johnson Space Center, and Bryan O'Connor is Assistant Manager for Operations in Arnie Aldrich's Level II Program Office. Astronauts Dan Brandenstein and Jim Wetherbee are the Deputy and Technical Assistant for the Flight Crew Operations Directorate at the Johnson Space Center. We have three astronauts working with the Marshall Space Flight Center folks on the solid rocket booster redesign and the other vital performance systems - the Space Shuttle main engines. Hoot Gibson here leads our team, and he has Mark Brown working with him; Dave Leestma is working with the Marshall Space Flight Center main engine people. Hoot can tell you about solid rocket booster redesign progress.

At the Kennedy Space Center, the Cape Crusader astronauts, led by astronaut Bo Bobko, are participating on the eight technical teams which are reviewing paperwork and preparedness.

With respect to other Commission recommendations, Henry Hartsfield is the Astronaut Office Space Shuttle Safety Officer. He has several other astronauts working for him on the Orbiter and its payloads. He is participating in Space Shuttle safety reviews on a near daily basis and can tell you what is happening in the world of Space Shuttle safety.

We concur with the Commission recommendations on landing safety, launch abort and crew escape, flight rate and maintenance safeguards, because NASA's success will be judged by our success in those arenas.

With respect to safety and improved communications, we fully support the Commission's recommendations. It is essential for NASA to have a management system that consciously eliminates the avoidable risks. As we have seen, some risks are self-induced when we try to attain very high flight rates, simultaneously reduce operating costs, and try to fly unsafe payloads. As 51-L showed us, after 24 flights, the Space Shuttle, as wonderful as it is, is still an inherently hazardous research and developmental vehicle. Since we now have three Orbiters, it is logical for all of us to be realistic about what we can do safely and operate these national resource vehicles conservatively.

As the Commission recommends, therefore, we think a safety agency, independent of the sometimes safety opposing other NASA functional and Program responsibilities, will be essential. This safety organization will help us find safety problems and correct them early to prevent another Space Shuttle accident. In the nuts and bolts of this matter, because of the type of work that we do every day, every branch, every division and every directorate throughout the Agency should have safety educated and oriented individuals with the ability to report directly through safety people to the Administrator of NASA. It is also clear from what we have seen recently that safety people have the need to be able to talk directly to each other because many safety problems are common. It is clear that open communications will be very helpful in preventing another Space Shuttle accident.

In summary, the Astronaut Office is very supportive of the recommendations of the Presidential Commission on the Space Shuttle Challenger Accident. Everything and anything that we can do to carry out the recommendations, we are doing. We believe when the Presidential Commission's recommendations are implemented, that we will be doing the very best that we can for the country to return the Space Shuttle to safe operating status.

Mr. ROE. Fine. We thank you for your initial presentation.

What we are going to do, as part of our job now, we will have to recess for 10 minutes while we go and vote and then we will continue from there.

[Recess.]

Mr. ROE. The committee will reconvene.

Before the recess, we had the opportunity to have an overview from our distinguished witnesses of their observations of the space program in part, and also their basic feelings and some of the ideas they expressed as far as the overall relationship between the astronaut corps and into the Agency.

There are a couple of questions I would like to ask at this point, and perhaps make an observation. We have deliberately—I want to thank you, by the way, for joining with us—we deliberately selected particular people to participate in these hearings, because what we are trying to, amongst other things, what we are trying to achieve is what role does the corps literally play, and what your own perception is of that role as far as the decisionmaking process is concerned within the whole space program?

I have observed the program when Major Slayton testified, as a pioneer in the field, and getting to Commander Gibson and Commander Young, who are currently active, there seems to be a feeling you portrayed to me—maybe it is only dialog—I don't think so—that you felt there was a relationship, an immediate relationship so that if something concerns you, you could express that right to the leadership immediately, and it was translated immediately.

Then the question we have to ask when we get to Commander Gibson and Captain Young particularly at that point, is do you feel that dynamic exists? Somebody made the point of view that safety was really a state of mind. I think you made that point, General.

So, I think that is important. Let's ask the first question of your observations. Do you feel the same dynamics between the corps, who are literally the commanders, and people who fly and are responsible—and I think you made that point, Major, if you didn't think you should fly, you didn't fly, and that decision was made by the commanders of the flight, not by somebody else in the NASA system or industry or whatever.

That is the issue we would like to kind of mature a little bit. Do you feel, first of all, Major Slayton, your observations, do you feel from what you see that that prevails, and then let's switch over to Commander Gibson or Captain Young.

Major SLAYTON. Well, I think John and Hoot can probably address that a little better than I can. The only observation I would make, not being in the system anymore and trying to determine what is changed originally, is I think maybe the corps has submerged another level or two down in the hierarchy from what it used to be.

My observation is any time you start putting layering between groups, you start building new problems, you build communications problems, and you just don't have the direct access.

So where we used to be able to talk directly to the Center Director about things and even to the NASA Administrator, if they are going to stay within channels—and being good, disciplined Government guys, I am sure they most of the time do—they have to go

through about three or four different people to get to that same level.

And that would be my opinion of what may be different. I think anything you can do to clear out the channels and get direct communication running not only between the astronaut corps but every place else in the system, because I observed from this report that that is not a problem unique to the astronaut corps. That was another problem in some of the other centers, and to me that is one that has got to get fixed throughout the agency.

Mr. ROE. Commander Gibson.

Commander GIBSON. I would amplify what Mr. Slayton said. We are definitely moved down to a level a bit below where we used to be. Our comments and concerns can still, of course, be made known to Captain Young, and he carries them forward, but again, he is reporting through another chain that we weren't reporting through before, and it seems like each time perhaps that we report through a different level, it gets filtered just a little bit. So, I would agree with what Mr. Slayton said.

Mr. ROE. Let me hear from Captain Young.

Captain YOUNG. There was talk prior to the 51-L accident, since the space shuttle has become operational, that everybody was talking about that we were going to do away with things like flight readiness reviews, we were going to do away with the crew reporting of their mission.

In fact, we had done away with it, several crews did not report up the chain of command, to report what they did on their missions.

Mr. ROE. Two things, Captain. Pull that microphone closer, and when you say they did not report, who told them? How did that happen? Was it just a change of direction? That is important.

Captain YOUNG. Everyone at NASA, and it was across, nationwide, started the business, operational much like an airliner, which it certainly is not, which we certainly have always held the opinion that it is not an airliner, and can never be an airliner, an agency which had people started thinking of it as an airliner, which, as the 51-L accident points out, and some of the things in the Commission report, it is not an airliner. You start treating it like an airliner and start treating your astronauts like airline pilots down in the airline system, that is how we did things before the accident, in quite a few areas, and therefore, operational or safety issues from the crews were not a matter of concern to management, and I can certainly understand that, except that the 51-L accident points out that was probably not the way we ought to do, and we are going to take steps, and we are taking steps to ensure that that attitude gets corrected agencywide.

We do have to worry more about the safety of the machinery, and the safety of operational decisionmaking. There is a place in the structure that people speak of these days called risk management.

I think our position, since we have three orbiters left, we need to take the position throughout the Agency that we are going to operate in a safe and conservative manner every time we fly the space shuttle. In other words, we won't take chances similar to some that we took in 1985 with the weather, for example, or we won't take

chances with the lighting situations, and we won't overstress our ability to do things with our machine that has placards on it, for example, a crosswinds placard. We wouldn't want to exceed any of those because simulations show us that that wouldn't be a very good idea. We are going to change the direction of the Agency, and we are going to have to do the right thing.

Mr. ROE. General.

General McDIVITT. Let me put on my program manager's hat, and take off my astronaut hat. I would feel uneasy as a program manager if I didn't have direct access to the views of the astronauts. I feel from an organizational, functional standpoint, that there is a requirement to know and have ready for flight, the crew, the ground system, and the launch equipment, the equipment that flies, both the launcher and the spacecraft.

I noticed recently when I was reading parts of the Commission's report, that the Astronaut Office now reports into something called Operations, or something like that, it does indeed remove it from the position that it had been before.

If I were the program manager, I would look at that function as two different functions, the ground system where the flight controllers are, and the flying system where the astronauts are. It would be getting filtered before it got to me as a program manager, and I wouldn't like that, not from an astronaut standpoint, but from a program management standpoint. You don't have access to the data in a timely fashion, and get the relatively unfiltered perception of how these problems are seen by those two distinctly different organizations, and I would rather have that come to me and let me make the decision on it, instead of having somebody in front of me, filtering and then bringing to me the filtered version of it. So as a program manager, I wouldn't like to see the organization the way it is structured today.

I also note that in looking at the Johnson Space Center organization, that from an organizational standpoint, a block diagram standpoint, the engineering development directorate is at the same level as this Operations Director, whatever it is called, and down below that are these other two things. I don't see it that way. I see engineering, ground control and flight operations up in space, all at the same level, and they are not like that. So just from an organizational chart, it doesn't look very well and won't do a good job, and from a program management standpoint, I would feel I wasn't getting all the information I needed.

Mr. ROE. Colonel Hartsfield.

Colonel HARTSFIELD. Since I have been at Johnson Space Center, we have had two major reorganizations, and in each of those, the astronaut office was pushed to a deeper level. We still manage to get our inputs in, but as Mr. Gibson said, it was filtered. We were not speaking organizationally, with the same voice that we had had in the early seventies. As far as how the commander got treated in this thing, I would like to give my viewpoint on that.

I have flown three times, the last two times as a commander, and I will have to say, leading up to the flight, the responsibility to pull that flight together, and work a lot of the problems did belong to me as the commander, and my viewpoints, I think, were listened to, and the preparations of the flight.

In fact, I remember an incident before the launch of 41-D, that we had a problem with the spacecraft that was brought to me the night before we were supposed to launch, and I was told that there was, they discovered just that day or very recently a possible single failure point that could cause some problems with separation of the SRB, and it would require software patch to get around it, and I was asked, you know, low probability, we had flown 11 previous flights that way, but how did I feel about it?

Did we want to launch with that problem or not, and after discussing it a little bit, I said, I think we ought to fix it, it is a one-day slip, we ought not to take the chance. We delayed a day and fixed the software up then.

In my mind, that is the way the system should work. There were other inputs to that decision, and upper management had to make that decision, so I am not sure we could put it in the vein that the crew said, don't go and we didn't. In this particular case, it seemed like the crew opinion of this problem was honored, and that is, I think, that I would like to see that in these types of situations that the viewpoint of the crew certainly carry a lot of weight with the management.

Mr. ROE. Well, I think we have come 360 degrees on that area, and that leads to the question: Here we have Major Slayton making the point of view in his earlier experience as a pioneer in this field, that his concern as a crew commander, as a member of the crew was listened to, and I believe, and I don't want to misrepresent, I think I heard you say that if you decided as the commander that they would not fly, they would not fly.

Is that a correct interpretation of what you said? I think so. Here we have a scenario where we have been flying, somebody else made the point that the rationale has to be portrayed that astronauts and commanders of shuttle flights are not operating as airline pilots by any stretch of the imagination. OK.

And I think you made that point very eloquently. Now, we come back with this scenario where we have a number of flights flying, and we have a situation that arises and I am not going into depth as to technology, where a decision has to be made, and there is a meeting that is held, and, supposed to be for a half-hour, lasted for an hour, where a decision was made to fly or not to fly, and I don't recall in any part of that testimony, maybe my colleagues would know one way or the other, I don't recall, in the testimony that you were consulted, where the corps was involved, now, Major Slayton says he had at his level at that point in the evolution of the programming, he had the right to say yay or nay, and here we have a group of people, fire corps people, the people from Marshall got together and they made the decision to fly or not to fly.

Was the astronaut office, was the astronaut corps consulted on that decision? Or has the management program become so institutionalized that we were considered to be airline pilots and therefore, we would be involved and have the right to make the decision yay or nay, we shall or shall not fly.

That is a legitimate question, we ought to try to answer.

Captain YOUNG. I don't want to take away from airline pilots, because they have a hard job as it is.

Mr. ROE. Nor do I, because I use them all the time.

Captain YOUNG. But in this particular instance, with respect to the cold temperatures on the solid rocket motor seals, there were no astronauts involved in that conversation, nor any people from mission operations or the astronaut office, to my knowledge, involved in that conversation.

There are times when you get in close to launch, that the system that says whether you are going to fly or not to fly, can be represented by astronauts. We don't have it done that way right now. There could be astronauts going to every meeting involved in those kinds of decisions.

Mr. ROE. And why not?

Captain YOUNG. If you are operational, getting down close to launch, the things that the astronaut should be worried about are those things that he or she can do something about, for example, it was done on 51-L.

Dick Scobey had a problem knowing that the hatch was closed on 51-L and stopped the launch to fix the hatch on one of the scrubs before the 51-L flight launched, and so he was directly involved in that, and that is the kind of operational thing that the crew commander has to be worried about when you get ready to fly.

There were no astronauts represented on the solid rocket motor seal problem, and in fact, I am not sure of the way that the system got that kind of information, that if they had been represented in that manner, that it would have made any difference to the program.

We have heard in flight reviews, and I have sat in there myself, serious concerns which we didn't know were serious concerns, that people talk about, things like the solid rocket motor nozzle, which also has seal problems. The consequences of those seal problems not working would be just as serious as the 51-L accident, and when people present these things in a manner that they don't appear serious to you, everybody in the room says, let's go fly.

Mr. ROE. What I want to develop for the record, and not to lead your answer, the question is, here is a situation, you all spoke of safety in your initial presentations, which is the premier issue we are concerned about.

You brought up factors, 80 percent safe, and we talk about 800 criticality items involved, any one of which could create a catastrophe.

It seems to me to be a little extraordinary, and maybe I am wrong, because here it has been known for 6 or 7 years that there has been a problem with the O-rings in that particular area, and it seems to me, did the current astronaut corps, were they advised, were they aware of the seriousness of—I think there was 12 or 14 flights where they had problems which they were able to ascertain afterward, with the O-ring seals, so forth, did the corps know that at all?

Captain YOUNG. No, sir, when we looked at the solid rocket motor for the first mission, STS-1, Bob Crippen and I went up to Thiokol, and we were briefed that there was no such thing, we weren't briefed that anybody knew anything about joint rotation. They explained to us you didn't even need the seals, because when the case expanded, it would seal against the metal to metal, you would have a metal to metal seal, and you could take the seals out

and didn't need either one of them, and there was some people complaining about having to put two seals in.

When we first heard about this, we said that we would look at the solid rocket motor qualification firing, and if they didn't have any trouble, we figured we were home free, where the solid rocket motor had a close reliability. It made a lot of sense. We had two seals in these factory joints, and the astronaut office had no knowledge of solid rocket motor seal programs from then on, nor even considered them, and neither did anybody in the mission operations at the Johnson Space Center or any other directorate at the Johnson Space Center, had any idea of the O-ring seal problems, to my knowledge.

Mr. SCHEUER. Would the chairman yield?

The Rogers Commission recommended that either the flag commander or a representative of the flight commander sit in on the flight readiness review which takes place 2 weeks before launch, and I assume all of you have endorsed in general the recommendations of the Rogers Commission?

Captain YOUNG. Yes, sir, and we sit in on the flight readiness reviews.

Mr. SCHEUER. You had two emergency meetings within like 14 hours of launch, one the night before with the Thiokol people, the problem of the subfreezing temperatures, and the problem of the seal.

Then, within an hour of scheduled flight time, before that, you had another meeting with the Rockwell people on the problem of the ice, and these were two almost emergency types of meetings, where the safety engineers had the most urgent concerns about the safety of the flight.

Don't you think we might extend the recommendations of the Rogers Commission, not only to include the flight commander in on the more or less routine flight readiness review, which took place 2 weeks before flight, but also include them in on any emergency meetings that might have taken place within 12 or 24 hours within the flight, and in the case of the second meeting with Rockwell within an hour of the flight?

Captain YOUNG. We could certainly put people in those kinds of meetings. I am not sure they have the technical expertise to really be able to say go or not go. We had a problem of our own on the flight, you know. The egress path we found out later was covered with ice, and from a crew standpoint, I don't think you would have wanted to launch where you can't, you know, where your path to the slot was covered with ice, you would not launch from that standpoint.

We could have made that input, but for crews to say whether a solid rocket motor seal is safe to fly or not safe to fly or whether the engine turbine blade is safe or not, you got to have engineering expertise to do that, and our people are trained to fly spaceships and they are trained very well, and they can work thousands of procedures with things they can do something about. But as far as technical expertise, to say go or no go on a technical issue of performance, you could have a gut feeling that it wouldn't be a good thing to do, you sure could have that and express those feelings at a meeting, but—

Mr. ROE. What I am trying to develop, we have a broad base from the beginning of the program now to the ongoing dynamics of the program. One of the issues we are talking about is what happened in management.

You folks as astronauts are going to fly this experimental craft. It is not an airplane, as you said yourself, and there are seven lives that are involved, and some of those people have got to at least have the feeling, I would assume, when they get into that spacecraft, that it is going to fly to the best of their knowledge.

Let me finish. What Major Slayton says is there was a dynamic that existed in the initial part of the program, and people were saying, should we fly or shouldn't we fly? The question is, should the astronaut corps be more into the upfront decisionmaking end of the situation?

Should you have the right to abort a flight? You are constantly, according to the chart in the Commission report, you are getting further and further pushed away from the decisionmaking, they are treating you like pilots.

I don't say that unkindly. All I am trying to get at is if you knew there was a problem with those O-rings, seven years, half of the flights that were flown that had a problem, would you have allowed that to fly that day?

Could you have done anything, as opposed to could you have said no way, we are not going to fly? Could you have done it?

Captain YOUNG. The rest of the agency, if they had been aware of this problem, we wouldn't have flown. We would have fixed it. If other people responsible in the management structure had the feeling this was a serious problem, we wouldn't have gone. We have to believe that, because there, on the orbiter, there are 1,500 criticality 1 items on the orbiter alone, on STS-1, those items are still there, and if the management system can't make sure those things are ready to fly, we can never fly again. If you have an astronaut saying every step of the way, don't fly because of this, that or this, where they have no expertise, it would be troublesome.

Mr. ROE. The Chair recognizes the gentleman from New Mexico.

Mr. LUJAN. Thank you very much, Mr. Chairman.

Welcome, all of you, to the committee. Captain Young, one of the things that is interesting that you said was that we now have people from the astronaut corps in different areas, Gibson looking at the engines, and Bob Crippen up here, and so on.

That is during the time when we are down that nobody is flying. Do you think, as one of the changes we ought to make, is to have astronauts in all of the different areas looking into them, and if so, what problems does that create with active astronauts when we are flying?

I guess maybe basically, you think that we ought to keep that up, having astronauts all over the place to look at things?

Captain YOUNG. While you are not flying, it is easy to do. It keeps people involved in interesting areas. Before we stopped flying, we had 11 or 12 flight crews, and were going to name three or four flight crews, a total of probably 70 people, 70 different people would be assigned to flight crews with an astronaut corps of, say, 90, and in that case, it is very difficult to assign everybody to an area unless you want people to work two jobs, and we have

some very good people in the astronaut office and many can work two jobs, but it is difficult when you are on a flight crew to work more than a flight crew job.

Mr. LUJAN. What we are saying is an effort ought to be made to have somebody from the astronaut corps involved in the different phases of it.

Captain YOUNG. Well, they are. We have the Deputy of Flight-crew Operations as an astronaut, and he goes to the flight readiness reviews and participates in the program requirements change control boards, but it is not to the level of detail that this group is agency-wide right now, and once you get back to flying, you probably wouldn't want to cover that, you are in more of a design process right now than in a flight process, and once you get back to operating a space shuttle, you wouldn't want people scattered all over the place.

Mr. LUJAN. What about graduating some guys into those desk positions, couldn't you do some of that, maybe?

Captain YOUNG. We could do that. Yes, sir, it is very hard to keep people around when they are not flying.

Mr. LUJAN. Yes, I can imagine. Let me follow up on your now-famous memo. Did you feel kind of looked down upon or antagonism, or anything, after that memo? How was it received, do you think?

Captain YOUNG. Well, Congressman, that was an internal memo, not scheduled for release. I was really trying to get people to think, which is the purpose of all the memos that I have ever written, but it was a result of going to meetings and findings that this attitude toward safety, since the accident, it looked like to me that a lot of people had watched this thing on the television and had not appreciated the effect it was going to have on the National Aeronautics and Space Administration. And the way we do business, and we had not changed our attitude about the way we operate in one little bit, so I wrote that memo, and it is like anything else, when you do that, I got a lot of letters from people all over the country that thought it was "atta boy," and a lot of letters from people who offered to take my job, because they wanted to fly the shuttle. And they told me what I could do with that memo.

Mr. LUJAN. What I was thinking of more than the general public's reaction, the encouragement or discouragement that someone in the astronaut corps may have from NASA itself for bringing up problems like that?

Did you feel like NASA was saying to you, you ought to keep your mouth shut if you feel that way, or thanks a lot for bringing out these points?

Captain YOUNG. No, NASA doesn't care. I don't think you write memos until you have exhausted all your other avenues, and I ran out of rope pretty fast many times, so that is what the problem is.

A month after the accident when people aren't turning things around, as serious as a matter as that was, something should have been done, and part of it was because the whole agency didn't have anybody, they were all busy investigating the accident, trying to get things squared away.

Mr. LUJAN. You had voiced these concerns before?

Captain YOUNG. Oh, yes, sir.

Mr. LUJAN. Same concerns. One final thing, you indicated that astronauts do attend the flight readiness review meetings that are held, along with those teleconferences that are being taped, and all of that.

Is the astronaut office plugged into that or not?

Captain YOUNG. On the L minus 1 briefing, the teleconference, we listen to it. The program manager always comes over to sit with the astronauts after the L minus 1 briefing for a couple of hours, and any inputs that anybody hears on the L minus 1, they discuss with the program manager.

Mr. LUJAN. Do you feel more comfortable—well, Kathy Sullivan said she wouldn't fly again for a long time. That is part of the press reports. Do you feel the same way?

Captain YOUNG. If we fix these design problems, I would fly again. I am scheduled to fly on space telescope.

Mr. LUJAN. You are talking about just the solid rocket booster seal?

Captain YOUNG. I think there are several other issues. The program manager mentioned the last time he was here, maybe a couple hundred that they are looking at, some of which are rather serious, design issues that we have an opportunity to take from a criticality 1 status and put in some other status, I would feel more comfortable about flying.

Mr. LUJAN. How many?

Captain YOUNG. I don't have them. Dick Truly can get the exact number.

Mr. LUJAN. I know there are 700 and some. But of the ones that have to be resolved, the joint, the brakes, the landing, those are the things that you are talking about?

Captain YOUNG. Yes, sir, and maybe a couple more besides.

Mr. LUJAN. One final question. I am concerned, and one of the things that you touched on, having guys all over the system looking at things like that, do you think we ought to perhaps start a new class type of astronaut with this kind of technical expertise that whose premier responsibility it is to, for example, if Commander Gibson wants to continue flying, and somebody to be over there looking at the engines, that either he doesn't fly as much, every once in a while as a prize, let him go up or something like that, but their primary responsibility is not flying, and more looking at the astronaut corps concerns, do you think that might be advantageous?

Captain YOUNG. Well, I think having astronauts to do that kind of work, and fly on occasion is a very expensive way to do astronauts. You can get real good engineers to do the same thing, a heck of a lot cheaper, and make just as good inputs.

NASA has a gracious plenty of those kinds of people around who are really responsible. In the main, you like to keep astronauts around to fly spaceships because that is their talent, and that is what they want to do, and it is very difficult to keep an active person like Hoot Gibson to be on the solid rocket motor booster, isn't that true, Hoot?

Mr. LUJAN. I can understand that, the reason he is in the astronaut corps is so he can fly.

Captain YOUNG. Yes, sir.

Mr. LUJAN. One short question.

You say people do attend the FRR's, and are involved in the teleconference, all of that sort of thing. Do you happen to know if the teleconference for 51-L was taped or not?

Captain YOUNG. No, sir, I would have no way to know that.

Mr. LUJAN. OK. Thank you, Mr. Chairman.

Mr. ROE. The Chair recognizes our distinguished chairman, Mr. Fuqua from Florida.

The CHAIRMAN. I apologize for not being able to be here. I am shuttling between two meetings, but in follow-up to the questions that have been asked, I would like to ask Jim McDivitt and Deke Slayton, you have been there, and you are not directly involved, how would you implement better communication between the astronaut office and the launch procedures and so forth, that has been recommended by the Rogers Commission, and as John Young pointed out, if I interpret what he says right is not good utilization of all the astronauts to have them run around and review all the safety procedures.

How would you two propose that that problem be addressed? I think very strongly myself that there should be closer involvement by the astronaut office in the review. I had questions on the last reorganization at Houston about that very problem, but how would you two propose that it be done?

Major SLAYTON. I would propose that they didn't operate too bad the way we started, have a flight crew operations director reporting directly to the center director, and the chief of that office was a senior astronaut, and that worked very well. We had an understanding within our organization down the line. An appropriate point, though, that John brought up, no matter how you do this, if you don't have the communication in the rest of the system relating to it, you can't make any better decisions than anybody else can.

The CHAIRMAN. In the most recent case, you would not have had that information?

Major SLAYTON. Exactly. It appears to be so. Equally important, try to get a little better communication between the astronaut corps and their management, you have to go back and look at the rest of NASA and the other centers, because it appears to me that is where the big problem lies in this particular incident, that the communication did not exist at the working level up through the chain of command, level 2 and level 1, because if those gentlemen had known on 28 July, or January, what they know today, they wouldn't have made the decision they made.

None of us would have, so there was a big lack of communication.

The CHAIRMAN. Jim.

General McDIVITT. I think I would recommend that the flight crew operations directorate be moved up to report to the center director as well as the flight operations director. I think both of those organizations are very key to flying, and having them go through another layer of management before they get to the Center Director creates a filter which is not necessary or desirable for either one of them. I think it also gets them on the same level as the engi-

neering organizations within the manned spacecraft center, and gives them better access to the program.

The CHAIRMAN. How about interfacing with the Associate Administrator for Space Transportation, in this case today it would be Admiral Truly?

General McDIVITT. It has to be done within the rigid framework NASA has. You have to be careful about going out of the chains and their normal institutional route is through the center director.

The programmatic group is through its program manager in Houston, the level two thing in Houston, and up to commander, or Admiral Truly.

There should be a caution about putting too much responsibility on astronauts, when they don't have the time to do it. Like the flight crew commander is very busy prior to flight and does not have time to spend a lot of his time involved in reviewing engineering decisions that have already been made by very professional people, and his concern is how am I going to remember all those things that I have to do to launch abort and all the other things, so I would caution you about burdening him.

There is a need for adequate representation of the astronaut office in those meetings. I don't know whether that exists today. From what John said, it sounds like it does. I would be cautious about overloading him with things which he can't handle. The other thing is, you've got to be careful that you don't put the astronauts in situations where they have less information available to them than the people who are already making the decisions. Quite frankly, when I was a crew commander, I had to rely on the people within flight crew operations directorate to represent me and the program office people to make the decisions that were far beyond the technical capabilities of my crew or the people in flight crew operations.

If it was a very detailed problem with respect to some small rocket engine, we needed rocket engineers, not generalists. I would be careful about getting people in positions where they are not adequately briefed or did not have the technical expertise.

It would appear to the rest of the organization that the responsibility now falls on the astronauts to make these decisions, and they look to them to make the decisions, where they should be making the decisions themselves. So I would advocate a very rigid structure, make sure there is an X on everybody's head who makes the decisions. If you don't have any communications or adequate communications, and people don't appreciate the seriousness of the problems through the organization, nobody can make a good decision.

Major SLAYTON. One philosophical point that needs to be brought out here that has not been so far and that is that the crew commanders and astronauts in general view things a little bit different than everybody else does to begin with, and you have to recognize that and be a little bit cautious.

In general, a crew commander if given a choice is willing to take more risk than is management. That has been the case in the past, and he is more likely to give you a "go," and you need somebody at a higher level that is willing to, on his behalf, willing to take the bull by the horns and have the guts to say "no go" on behalf of the

crew. We did have that before. That is a caution I would note here, because a crew commander, and we can understand it very easily, does not want to be put in the position of being the only guy that says, "hey, I don't want to go."

The CHAIRMAN. Did you have a comment, Hank?

Colonel HARTSFIELD. Yes, sir. I wanted to say that I feel that it is just like in our own Government, the buck stops at the White House or the Congress perhaps, but somewhere, but certainly above the level of the rest of us. I think that the decision to go or "no go" rightfully belongs with the upper management, and not, my personal opinion, not with the crew. The crew input should be felt very strong. I make an analogy. For example, in flight safety in the military, if you have a bad accident happen, material failure or something on the airplane, it is not the safety officer that grounds the airplane, it is the commander that does that, and he gets his advice from the safety side of the house, so I feel what we need to do is emphasize attention to operations and flight safety and that is what the astronauts can provide, is this overview of what flight officer is really all about and how to fly it, and then let the upper management take that viewpoint into account.

The CHAIRMAN. Well, that was a followup question I wanted to ask John Young.

John, you have written several memos, and in the course of your responsibility as chief of the Astronaut Office. Where do those memos go, and are they read, acted on?

Captain YOUNG. Pretty much all over the place. They go to our technical assistant in the Program Office, to my boss in Flight Operations Directorate, and places and each issue gets dealt with. I am not complaining about them not being dealt with.

The CHAIRMAN. No. The question I am asking is, does it get to the proper people, up to the Center Director, does it get—what level of management do they get to?

Captain YOUNG. I am pretty sure it does, because I sent one to the Technical Assistant to the Center Director so I am pretty sure he gets to see them if they think they are worthwhile looking at.

The CHAIRMAN. Who makes that decision, whether they are worthwhile looking at?

Captain YOUNG. That is a question—

The CHAIRMAN. If you write them, you think it is important.

Captain YOUNG. What we think is important to get the issues on paper so that people can look at them and think about them, that is important. There may be another way to do it. I just think, you can call them on the telephone and tell them the same thing, but folks tend to forget, being very busy and worrying about a million details.

The CHAIRMAN. But I guess what I am asking is, is it getting to the proper officials in the chain of command that can take appropriate action?

Captain YOUNG. I have seen some pretty pithy replies, so I imagine they are; yes, sir.

The CHAIRMAN. Whether or not they agree with you or not is not necessarily the point. The point is, the fact that it was called to their attention, then they ought to make a judgment decision about it.

Captain YOUNG. Yes, sir. Many of these things, as I say on the memos that got written following the accident that were released, that were internal, every one of those things either has a design number or is being talked about in mission rule reviews or being considered in the critical items list discussions or has a place in the program that is being looked at, and we are in all of those.

The CHAIRMAN. I was talking about ones you had written before, in the process of the operations.

If they had gone to the proper places, and received the proper considerations, not that everybody agrees or disagrees, but the fact that at least it was called to their attention?

Captain YOUNG. Congressman, before the accident I think the attitude of the agency was totally different in terms of being able to support the flight rate, in terms of being able to fly the payloads regularly, in terms of being able to turn things around, and I think part of the problem was we were starting to exceed all our resources.

We didn't have the ability to do all the things that we wanted to do and were trying to do. We wrote several items on those things such as spare parts, flight rates and people working too hard at the Cape, and things like that, and nobody was listening much because you know that NASA is a "can do" outfit. It can do anything it puts its mind to, and we were trying to do all those things, and I think people were thinking about them, but they didn't know any way to solve all those problems simultaneously. Now, we have a chance to solve them and I think that is what we are going to do and we are going to have to do it because you just can't fly machines without the spare parts and if you are working people 12 on and 12 off for months at a time, that is not a very safe way to operate and if your simulators don't hold up, you know, if you can't train more than 10 or 12 crews a year, it is hard to fly more than 10 or 12 flights a year, so we have to worry about those kinds of problems.

The Astronaut Office is a very strange group, because it does operate across all levels of, both management, and particularly down in the working levels. We have people out in the field running tests with hands-on technicians that do the job at the Cape and people in simulations at the Ames Research Center, and people working in the Shuttle Avionics Integration Laboratory checking out flight software, two shifts a day, 5, 7 days a week and people working in mission operations on flight rules all the time so we hear things from the working level people and maybe that is one of the reasons why we are always so—we are trying to get the word from those working people through the chain, maybe by passing a few steps or two so we can help the program.

That is the purpose of that kind of information transfer, but I think that the whole agency needs an internal communications system that does not count on the astronaut relaying the words because we had nobody on solid rocket motors, for example, and the people we got on engines, when somebody tells you something about a space shuttle main engine, they have got to be a whole lot smarter than the average pilot or astronaut before you can make a sensible answer out of those things.

Mr. ROE. The gentleman from New York, Mr. Scheuer.

1/2Mr. SCHEUER. Thank you, Mr. Chairman.

I want to follow up on this concept that I hear developing, that the answer lies to the problem that this awful accident, lies in better communications in the agency and not really in the involvement of the astronauts because they don't have the time or the technical expertise to handle the information.

First, let me say that from the information we got and the information that is in the Rogers' report, this information, the problems of the O-ring, the seal, the putty, was well known to all levels of NASA, and in that August briefing—well, let me quote from the NASA—from the Roger's report on page 148. Item 5. "The O-ring erosion history presented to level 1 at NASA headquarters in August 1985 was sufficiently detailed to require corrective action prior to the next flight."

They recommended elsewhere in the report a sustained level, an accelerated level of research and development into that problem. Now at that meeting, you had Michael Weeks, Deputy Associate Administrator the Deputy, and Jesse Moore, Associate Administrator for Space Flight, he participated in that meeting, and testified at the end of that meeting he briefed Jesse Moore, so there was information about that problem at all levels.

The problem was not just NASA headquarters not having the basic information. Let me rehearse those two emergency meetings, the night before the launch and the morning of the launch. The night before the launch with Morton Thiokol and the morning of the launch, minutes before the launch with Rockwell.

The safety engineers testified to us, before us, Mr. McDonald and Mr. Boisjoly—very terrific, impressive guys—they begged and pleaded with management, with NASA to defer this flight. They expressed to us what was clear outrage at the flip that had taken place in the burden of proof, whereas before, if they raised a significant question about safety, the flight was aborted. Now, they were told by Thiokol that they had to prove beyond a reasonable doubt that the flight was unsafe. They were bursting with frustration, and there was a lot of rage there and up here. I was a Greek and classics major in college, and by no means an expert in aeronautical engineering, but I was frustrated beyond belief and my colleagues were, too.

Don't you think that if a representative of the astronauts had sat in on these two emergency meetings, the night before launch, and an hour before launch, and had heard the deep, almost desperate concerns of those safety engineers, and it was not a technical matter, a flip in the burden of proof that was there since the seal in the O-ring, the sub-freezing temperature, the ice the morning of the launch were life-threatening conditions, it seems to me that you gentlemen had a thousand times the expertise that we have and you would have needed to perceive that something was rotten in Denmark, and that this launch should not go ahead.

I am at a loss to understand how you can say that you didn't have the time or the expertise to sit in on these two meetings, and that it wouldn't have made a difference. Of course, they were not invited; but my chairman says, of course, you were not invited, but we are talking about making the institutional changes in the system whereby you would have a representative at the 2-week

meeting before that, the routine flight review meeting, and at any subsequent emergency meetings affecting safety.

These were clearly emergency meetings the night before, the hour before, and for the life of me, I can't understand why you wouldn't urgently want to have the flight crew represented at emergency meetings of that kind.

It was not a problem of information going all the way up the line at NASA to headquarters in Washington, the record is perfectly clear on that.

Captain YOUNG. Well, that is certainly an interesting aspect to look at the thing for, Congressman. I think we could have astronauts at those kinds of meetings if they promise not to sleep nights and work all day, you can do such a thing. Those kinds of meetings go on at NASA before launch every hour of the day and night. We can put an astronaut in there, but what I believe is if the program manager had been in and heard those issues, that we would probably not have flown either.

Mr. SCHEUER. Excuse me, Captain Young, with due respect, and I have the utmost respect and admiration for all five of you. As a matter of fact, when the Members went to the last rollcall vote, we didn't talk about anything else other than what magnificent, superior Americans the five of you are, and we were busting out with pride about you, it is perfectly clear on this point that top management did have all this information, and these are hard questions, and there is no point in our trying to dodge the issue.

These were very flawed decisions by people who had all the necessary information and they simply made the wrong decisions. We are trying to look at how we can change the institutional structure of the decisionmaking to obviate the risk of that again.

It happened pitifully, tragically, and we don't want it to happen again. We want the Space Program to go ahead and to be first in space.

We don't want any tragedy of this kind to happen again, and wasting tragic lives, delaying the program for years.

Captain YOUNG. If an engine man comes up and says that engine is ready to fly and the turbine blades are a little cracked but we have run tests and we can show with a cracked turbine blades the engine pumps are not going to come apart and we have got to fly. Would an astronaut say no, you are not going to fly until you change the turbines, for example?

Mr. SCHEUER. If there is a significant opinion from safety engineers that this is not a safe vehicle to fly in, you certainly would have found that out. The safety engineers would have been unanimous in telling you, this flight was not safe at this time with the subfreezing temperature, with the ice on the launch, and with the problems of the O-ring, this was not a safe vehicle.

They were ultimately frustrated because they couldn't prove it beyond a reasonable doubt. They were enraged that they had to meet that new test suddenly thrust upon them by the Marshall leadership, by their own corporate headquarters that had been under pressure from Marshall headquarters, but don't you think if you had heard those safety engineers it would have concentrated your mind on the questions about the safety of that flight?

Colonel HARTSFIELD. I think it is very clear what the Commission has pointed out, that we have a flawed communication process there.

Mr. SCHEUER. No; I beg to differ with you.

The Commission makes it perfectly clear that NASA level 1 headquarters in August 1985 was sufficiently detailed. The history presented to the NASA level 1 headquarters in August 1985 was sufficiently detailed to require corrective action prior to the next flight.

The communications flaw, if there was one, was perhaps not involving the astronauts in vital decisions affecting their safety when if they had been there and heard from the safety engineers who were desperately concerned, they may well have made the decision not to fly, but you can't get around the fact that top—the top Washington headquarters of NASA, and Marshall, the Marshall/NASA officials had been briefed in detail about these problems in August?

Colonel HARTSFIELD. If you allow me, sir, the level 2 program manager, Mr. Aldrich, had no knowledge of these discussions going on and neither did anybody at JSC that was working with the problem.

Now, it is clear from the Commission's report that they are recommending things we certainly support 100 percent. We need to reorganize our management structure to not allow this to happen again and we need the safety. As I read the report, there were neither any NASA safety SR&QA people at these meetings and I think that is bad.

We have got to set in a type of system in which we have people that are directly concerned with operational and flight safety, and that these people are present at any time there are these kinds of discussions going on where there is a potential safety factor, but they have to also be attuned to the problem as it develops down in the bowels of the organization and that is what was missing.

Mr. SCHEUER. A safety ombudsman who would be tracking the progress of the flight all the way along the line, an independent inspector, general type of person. Yes, that was a recommendation.

While we are at it, are there any important questions which you felt that the Rogers' report did not address itself to sufficiently or adequately? Are there any other questions beyond the scope of the Rogers' Commission perhaps that you think our country ought to address and that this committee ought to address as part of its continuing oversight function over space flights?

Is there anything you think we ought to focus on and zero in on that has not been addressed before by the Roger's Commission?

General McDIVITT. I have not completely read the Roger's Commission report, but I think we have established a great history in space flight and done a lot of things.

I think that we are at a plateau right now that I have seen happen a couple of other times during the course of my experience at NASA, when we had the fire in 1967, and when the service module blew up on Apollo 13 on the way to the Moon.

In both of those cases we figured out what was wrong, fixed it and got on with the program. I don't know whether that is in the Rogers' report or not, I hope it is, but I would certainly recommend

we get on with it. We've got a lot of things left to do out there and for this country to be without a Space Program, both manned and unmanned, is ridiculous and we've to fix what we have got and get going.

Mr. SCHEUER. I couldn't agree with you more, in fact, this panel across party lines is unanimous, that we want to get ahead and be first in space again. We have a much more complicated problem than technology. This failure did not come from a failure of technology. It came from a flaw in the decisionmaking process, flawed judgment, flawed communications, flawed decisionmaking, and that is a lot tougher to address and we are determined to get to the bottom of it and if there is any question that was not addressed by the Rogers Commission that you think we ought to be looking at, please let us know sometime in the course of this morning's hearing.

Mr. ROE. The Chair recognizes——

Mr. SCHEUER. Can we hear from Major Slayton?

Major SLAYTON. As I understood what the Rogers Commission said, they addressed this particular problem and things that are related to it, and I think it needs to be made clear that there may be a whole lot of other things sitting out there that the Rogers' Commission did not look at and that needs to be looked at. If you are asking what needs to be done outside the Rogers Commission, a whole lot of things need to be done.

Mr. SCHEUER. Maybe you could submit a memo.

Major SLAYTON. 800 items on the critical list that need to all get reviewed and I suspect they are.

Mr. ROE. From a congressional point of view, we understand that thoroughly.

Again, I mentioned, the purpose of these hearings is not just to review exactly what happened with the O-rings from a technological point of view, but we are looking at the whole structure, because before the people or Congress can provide the funding, we got to know where we are going in a safe manner.

You as professionals in this field, if you have any further thoughts you want to express, you think things ought to be looked at that has not been addressed, it would be helpful if we knew that, on the whole process.

The Chair recognizes Mr. Volkmer.

Mr. VOLKMER. Thank you for being here, to the whole panel.

John, I was very interested in your comment that prior to 51-L, that you had in one of your memos pointed out the problems with the training and the flights, the parts problem, time schedules to meet the flights?

Captain YOUNG. Yes, sir. We are dealing directly, on terms of spare parts, we are doing a high turnover, and I talked to some Rockwell people in a confidential memorandum of one of theirs that said there was no way they could meet more than 12 flights a year with the spare parts that we had without doing excessive cannibalization.

What that meant to me was that we were being unrealistic about that, I saw the parts people at Kennedy Space Center, and they said come back in 6 months, which they were taking a lot of steps to turn that around. They have a system that can pick spare parts

out of the box. Yet the next time we couldn't find an unloader valve, there were three in the plant somewhere, but we took it off the vehicle to fix it. Spare parts was a problem. Crew training was a problem.

For 1986, we saw that we are going to need 220 hours a week in the month of October to train flightcrews. I was very interested in that because that is when our space telescope mission was going to fly. The people who were supporting the program said they would only be able to furnish 160 hours a week, and at that time we were not coming even close to doing that and it was difficult for me to see how we were going to get from A to B, particularly since we just switched contracts there in Houston, changed contracts from 22 contractors to one, and many of the people who were associated with old contracts, many of the key operational people, people who were interested in getting the job done didn't come across when we changed that contract, so that was a very serious problem, as far as we were concerned, to get the flight-crews trained.

You never want to sacrifice on-crew training, and we never have in any program I have been associated with because those people have a lot to do in space flight, and of course, I am sure the first time we ever had a crew-caused operational incident, the first person they will sack is the Chief of the Astronaut Office, but who cares about that?

That is not the purpose of crew training. It is to do the job right, in space, a job that needs to be done for the good of the country.

Mr. VOLKMER. What reaction did you get as a result of those memos?

Captain YOUNG. They said it was too bad we couldn't get the time, but we are going to fly the missions anyhow, and we just had to cannibalize because that was the only way to get the spare parts to support the vehicles, so it is a can do attitude, and we are going right down the road with the ability to do everything and we are not able to recognize what I call sort of grey limitations.

If the limitations are not black and white, the system keeps right on trucking.

Mr. VOLKMER. Attitudinal, wouldn't you say?

Captain YOUNG. Yes, sir, and somewhat an ability to recognize limitations, especially limitations.

Mr. VOLKMER. Assume we would within another 2 years have a third simulator. Where does that put us as far as crew training, number of flights a year?

Captain YOUNG. It depends on what kind of mission you are training for. If they are all about the same, you would probably support 12 to 15 flights a year in terms of crew training, that is what I think.

I could tell you 20 flights a year, but they are making assumptions about how rapidly you can turn people around, assumptions that we are unable to make at this time because we found that you can't fly people right as often as we thought we were going to be able to do.

Mr. VOLKMER. Is that an assumption also based on vis-a-vis generic flights?

Captain YOUNG. Yes, sir, pretty much.

Mr. VOLKMER. No payload changes?

Captain YOUNG. Not many payload changes close to launch.

Mr. VOLKMER. All right. The other thing that concerned me, and I thought I heard you right, and I wanted to check it with you to see, earlier in your conversation, I believe it was with the chairman, you mentioned that there were some proposals that were to take place that you had been informed of prior to 51-L, and doing away with the FRR's, and what else? Is that correct?

Captain YOUNG. That is all hearsay, a proposal to do away with the flight readiness reviews because we are getting so operational. When you get operational you start flying this thing in a hurry. One flight a month, if you are going to have flight readiness reviews you will have a staff of thousands of people preparing for flight readiness reviews. Thousands of hours of engineering work go into preparing for a flight readiness review.

Mr. VOLKMER. Does that give you any concern, if they were done away with?

Captain YOUNG. It would, except if you are operational, and doing your job right, the program manager is on top of all these issues so in theory you wouldn't need a flight readiness review, if he knows everything that is going to happen, and he is on top of this engine problem or that RCS problem, the flight readiness review in an operational system, ideally you wouldn't need to do one. You can see where they are coming from with that idea.

Mr. VOLKMER. But that means also that the astronaut crews are just going to have to—if that goes—are going to rely completely on other people as to the safety of the vehicle?

Captain YOUNG. Absolutely. And astronaut crews do rely on other people.

Mr. VOLKMER. I agree, but you would have to do it completely.

Captain YOUNG. You would rely on the system functioning the way it is supposed to work. And we have done that traditionally from day one. Nobody can rely even when they are flying that Atlas that the Atlas was put together right. They just couldn't do it. You have to rely on a lot of good people doing good work. The Space Shuttle Program work is incredibly laborious attention to detail in every face to every phase of the operation. That made the Mercury work, it is the only thing that made Apollo work and it is the only thing that will make the Space Shuttle Program work. We want to get back to that or it is not worth the effort, because we won't be successful at it.

Mr. VOLKMER. That is the way I want to get too. You have to stick to detail.

Captain YOUNG. Yes sir.

Mr. VOLKMER. It is also what I consider again attitudinal, because as I review the Commission's report on the FRR's on the O-rings and on the seal problem, that I find in there an attitude that constantly that you as astronauts, and management even at one level, didn't think it was much of a risk because it kept coming back whether it was acceptable. That is when it was presented that this was an acceptable thing. Is that correct?

Captain YOUNG. Yes sir. It was presented as acceptable in the 51-E flight readiness review that Captain Crippen attended. The way it was discussed, it wasn't discussed in a serious manner. It was not discussed as a serious problem, yes sir. It is hard when you

have communications if people are not going to make the issue serious, you know darn well the crew is going to fly. Because that is what the crews always want to do. They want to be ready to fly.

You shouldn't have to ask the crew commander within a week of launch if he should be going or not going because if that guy is not going we need to get somebody who is.

Mr. VOLKMER. One last question I want to ask you about and that goes back to some of the Commission's recommendations also that it should go—I guess the way I see it anyway—anybody that is going to be flying in the shuttle and that is the question of weather at Kennedy, and the changability and being able to land there at Kennedy. Can we ever come down to where by the time that you are NDR that you know it is going to be safe to land at Kennedy, there is not going to be a squall down there or winds aren't going to be crosswinds, a timeframe?

With the pleasant weather information that we have—let me ask you this. Do you as an individual, as an astronaut, do you feel comfortable with those conditions?

Captain YOUNG. Well, having to participate as a weather pilot down at the cape for many years and knowing the limitations of the space shuttle in terms of tile damage—and getting struck by lightning and it is a somewhat serious limitations—in crosswind capability and knowing the variability of short term weather predictions and not just at the cape, but if you go look at the southern United States right now, in the summertime, the ability to predict when a thunderstorm is going to build up and be raining in the morning or in the afternoon—you can take statistical weather and it shows you that in June, July, and August timeframe, at the Kennedy Space Center, you would probably have a 35-percent probability of not being able to launch in the afternoon over a 30-year timeframe, for example. But every now and then it is going to be the same way in the morning.

So you would be better off launching in the morning at the cape. But the ability to predict when a thunderstorm is going to form up is a very tough proposition. The ability to predict when a crosswind is going to exceed certain limits that you really placard it to as the short term is a tough proposition.

People say we are going to be able to do short term weather predictions, but it is tough. We have had flights in the shuttle trainer airplane where we have taken—I took Mr. Walt Williams out to give him a flight and there was a little old bitty thunderstorm 13 miles off the end of the runway at Kennedy. I said well, we will just go around and do a lot of flying here and show you how this thing works and 30 minutes later there were thunderstorms all over the place, and we couldn't land at either end of the runway. That is an unusual situation but it just shows the dynamic variability of the situation. The weather people said it was not going to be a serious matter.

So you think twice about wanting to land your space shuttle and take a chance, because you deorbit, you give a go, no go for de-orbit at about an hour and a half prior to touchdown and once you deorbit you are committed to that runway. So I think it would be troublesome with our limitations on both the tiles and crosswind limits and our current brake problems, which we are trying to fix, to

always say that you could land at the cape because I think weather predicting is a tough problem. It is not impossible, but it is just tough.

Mr. ROE. The time of the gentleman has expired.

The Chair recognizes the distinguished gentleman from Florida, Mr. Nelson.

Mr. NELSON. Thank you, Mr. Chairman.

Mr. Chairman, we are fortunate we have representatives from the Mercury and Gemini days here, from Apollo, we have in addition an STS-1 commander and we have the commander of the last successful mission of the space shuttle.

I want to direct my first question to Commander Gibson. When we were scrubbed on December 19, if I recall, the weather was somewhere around 41 degrees on that particular day. Do you have any recollection, either at the time or since, that there was any consideration going on among management or any of the contractors, about the question of the desirability of launching on December 19, in 41 degree weather?

Commander GIBSON. No sir, I don't recall any discussion at all along those lines regarding the temperature. I don't honestly remember exactly what the temperature was because at that point it really wasn't looked upon as an issue. So the answer would be no, I didn't hear it discussed at all.

Mr. NELSON. Captain Young, you were shaking your head.

Captain YOUNG. No sir. I hadn't heard a thing about it. I didn't know it was that cold that day either. That is really—

Mr. NELSON. Do you have any idea why, then, the temperature became an issue on the 51-L flight? It was obviously colder. It was 38 degrees at supposed launch time that particular time, although it had been a lot colder the night before. Do you have any idea, any information that you can share with us as to why, in the hours before the launch, temperature had become such a major concern there and not on the previous flights?

Commander GIBSON. Captain Young might be a little bit better able to shed some light on the 51-L, but I think in our case, it wasn't really discussed because we weren't approaching freezing. I think probably the freezing point and a lot of systems we have on the launch pad and the support facilities there on the pad were perhaps the big issue that tripped us to say what are the issues we ought to look at for a freezing temperature launch? Like I say, maybe Captain Young could amplify on the 51-L.

Mr. NELSON. You might want to check this out and see what you think. When 61-C finally launched on January 12 the temperature was somewhere up in the low fifties, if I recall. And they found in fact, there had been erosion on the O-rings. If I recall, it was something like four one-thousandths of an inch. That might have then triggered people to start saying January, why is it that it just eroded on this flight in January and previous to January 1985? And then they started thinking, was there a correlation between January, the temperature, and that might have led to the conversations before 51-L among the engineers. You all don't have any specific knowledge of any of that?

Commander GIBSON. No sir.

Just to add, apparently that day that they said we did have erosion, and as you mentioned, Mr. Congressman, we did have erosion in one of our aft joints and I believe we did have some erosion in both of our nozzle joints. We had that four one-thousandths of an inch erosion and that was known prior to 51-L but that did not trigger any conversation to relate 51-C to that, which is the flight the previous January.

Mr. NELSON. In the Presidential Commission report there is a chart on page 169 entitled "Simulation Training," of which it goes through for all of the several previous flights to 51-L. The day before launch date that the shuttle simulator training began, in comparison to what was considered to be the norm, of which the simulator training would begin, which would be 77 days prior to launch. I notice that your flight had the least amount of days. You started on minus 50 as compared to the previous flight, 51-B, indeed H-77, 51-A, looks like about 63. 51-J was about 85 days prior to launch in which they got into the simulator.

Can you share with us what was your feeling at the time and now that you reflect back upon the adequacies of the preparation for your crew, since you only had 50 days before launch to get into that simulator?

Commander GIBSON. Well, Mr. Congressman, as you know, that is a problem that we are continually fighting and it is key to the release data of the specific flight training load that we are going to get.

We had a rather fortunate situation with 61-C in that the type of things that we were doing, the satellite deployments and I should probably also add that even at the 50 days prior to launch we hadn't really finalized our payload yet—which is another whole separate problem. But the particular payloads that we were carrying and the particular satellites that we were carrying, allowed us to utilize other people's training loads and so we weren't in as bad a situation as this graph would depict, just beginning 50 days prior. We were able to accomplish a lot of our training just because we were plain lucky in this particular case, using other people's training loads.

Mr. NELSON. Have you seen a crunch in the crew training in those simulators?

Commander GIBSON. Yes sir, very definitely. And I think there is another chart in the Rogers Commission report that depicts that and it, of course, at the time the crew training load in the final 2 or 3 weeks prior to launch—and I am sure you remember it very well—but the crew time expands up to around 60 and 70 hours per week, because a lot of the things that we are trying to finalize and baseline early, just don't happen. They don't happen until the final 2 to 3 weeks leading up to launch. As a result, a lot of briefings and a lot of training get pushed into those final 2 to 3 weeks.

Colonel HARTSFIELD. In fact, I might add, if I may, sir—

Mr. NELSON. Please.

Colonel HARTSFIELD. At about the time of 51-L I had just put on the training hat for the office and was looking at how these training loads were going to be delivered. We were already seeing problems—either not reflected truly in that chart that shows when

they get the loads—for a couple of flights downstream, like 61-H, which at that time was supposed to come in in June.

We have in our training catalog a certain number of hours that are set aside to be done with the final flight load and flight specific software, and we had seen a point where if we did all that training after delivery of the load, based on projected data, the crew would have to train in one case 31 hours a week in the simulator, in another case 33 for the other flight. This was ridiculous. No crew can do that.

So for the first time, the training folks were wrestling with the idea, with this problem, that maybe for the first time we were going to have to say we can't launch because we don't have the crew training.

Mr. NELSON. John, did you want to add anything about that?

Captain YOUNG. It would certainly have been a new first because we never slipped crew training except for one time, to my knowledge, and that was a struggle.

Mr. NELSON. Jim.

One of the problems that takes place at a flight readiness review in L minus one debriefing is to find out if everything is ready to go. As a program manager we always had to have a report on whether the crew was ready to go, too. It was a vital part of the mission and they had to come up on line just as the spacecraft and all the other systems had to do.

Earlier, Deke mentioned that the astronaut office had to sometimes rein in the crews because they were more eager to go than maybe they should have been. I think it does put a burden on the head of the flight crew operations director to stand there and say is the crew really trained or not? As far as I know, it had never been a factor in any of the launches but I guess maybe it did at one time. So it is important that there is a spokesman for the crew. He is up there on top in a management position. He has access to all the other people and he can speak for them.

Mr. NELSON. Deke.

Major SLAYTON. Well, we had some similar problems earlier in the Gemini Program and we did slip Gemini 5 weeks for crew training. We were told by people in headquarters you can't do that but we did it anyway because we weren't going to go until we were ready. We also discussed in Apollo 11 we had the option of going on schedule or slipping a month, and we were very marginal on crew training then and we were on the verge of slipping that 1 month, but we got to the final couple days and decided to press on. I think those are the only cases I know of where we have gotten that tight on crew training.

Mr. NELSON. In your opinion, has there been a modus operandi within NASA that has excluded former astronauts or active astronauts from the management structure? Let's don't talk about it right now, because that was addressed in the Rogers Commission report and obviously Dick Truly is in now as very much a part of high management. Has there been some modus operandi within NASA that has excluded or has been a bias against putting astronauts into the management structure?

Jim.

General McDivitt. Mr. Congressman, as you know, I was the Apollo Spacecraft Program manager for 3 years and I didn't find any bias. I must say, though, during the time I was an astronaut, I spent a lot of time doing things in the program office that didn't have anything to do with astronauting, like doing contract reviews and spending a lot of time with little bits and pieces of the program that really didn't have anything to do with flying a spacecraft.

But I was welcome and had all the authority I needed, and all the support I needed when I got into that role and I am really pleased to see Dick Truly in that position or a management position now. I found that my astronaut background was a tremendous help to me, especially in the type of program that Apollo was where we were limited on the number of minutes or hours we had to make a decision when the spacecraft was flying.

As you know, when you are in route between here and the Moon and the Moon back to here, you can't stop, and when you start on down at the Moon, you can't stop either. The only time you have a chance to stop and rest is around the Earth and around the Moon.

So we were pressed into making a lot of decisions a lot quicker than we would like to make them and I found that the experience I had was a lot of help to me. But I didn't find any basic philosophical problem with me being in that position.

Mr. NELSON. Deke, did you ever see that bias in the agency?

Major SLAYTON. No, sir. I did not. I was in the management in the crew side up through the Skylab Program in Apollo and then subsequent to that I went into the program management. I managed the approach and landing test on the Shuttle and then was the orbital flight test manager on the first two flights.

So I had no problem at all. My role was a little bit different than Jim's. He was responsible for all the hardware and my boss was the hardware manager and I was the operations manager, so it was a little bit different role. But we certainly had no problem at all with any level of management supporting us and communicating with them.

Mr. NELSON. Let me ask you, Hoot, on your flight, you started using the nose wheel steering which would indicate that there would be less stress on the brakes because you are not using the brakes to steer. And you did not give a great deal of pressure on the brakes and yet I understand that there was significant damage to the brakes on your flight.

Commander GIBSON. Yes, sir. That is true. We had nearly a repeat from data that the engineers were telling us. We nearly had a repeat of the 51-K incident which was the landing in April of 1985 in Cape Canaveral that blew a tire.

Of course, this particular case, Mr. Congressman, is a perplexing one because they liked the deceleration profile. As you mentioned, we did not use an excessive amount of brake pressure.

We used essentially the exact braking profile that they were looking for and yet we sustained some stator damage in those brakes. We also had the nose gear steering available to us that I did utilize a little bit during the landing roll out that 51-D did not have. And in his case, this was Colonel Coe, had to use his brakes for steering also which put an additional load on it.

So we were more fortunate than him. We should have had a whole lot more margin over brake damage and we, in fact, did not.

Captain YOUNG. That gives you an indication of what kind of braking problems we have got to solve and we are doing that by improving the stators on the brake. But I would like to say Hoot did brake perfectly, just exactly the way they said was the best procedure for putting on the brakes on an airplane and it turned out that we ended up with brake damage at 36 million foot pounds per brake where a guarantee on the brakes is supposed to be 55 million foot pounds.

So we still have a problem here and it is in work to solve it. We are going for thicker stators and in a couple of years, new brakes.

Mr. NELSON. One of the other recommendations of the Commission is, quote, "make all efforts to provide a crew escape system for use during control gliding flight."

I assume that what that means is that if you got into a situation where you lost two engines after you dropped the SRB's, and you knew that you didn't have much chance of trying to ditch, that you would try to get into some controlled gliding mode so that the crew could bail out. Please give us the value of your experience as to whether or not that is possible as we look to the future of flight safety and launch abort and crew escape.

Colonel HARTSFIELD. Well, I firmly believe that we need such a system and I am convinced that it is not that difficult to provide. To try to provide a means to protect the crew throughout the flight envelope, I think, is unreasonable and I am not sure it is achievable totally.

As has been said many, many times, a certain amount of risk you have to accept. I do feel very strongly, in fact, I am convinced that this vehicle will not ditch worth a darn. I think it is going to tear up when it hits the water and you are going to lose the crew.

There are contingencies that we look at and we are trying for contingency aborts in case we lose more than one main engine during power flight that could force us into the water. I think we should pursue and are pursuing—we have got a group looking at it right now—a way to allow the crew to bail out in gliding flight or even be extracted.

There are some extraction systems like the Yankee systems that look very attractive at this point.

Mr. NELSON. What is that, Hank?

Colonel HARTSFIELD. It is a type of system that uses a tractor rocket to pull the crew person right out of the vehicle.

Mr. NELSON. To clear them from the tail or from the wings?

Colonel HARTSFIELD. Tail or the wings. One of the problems we are having to fight is how to miss the wing and the OHMSPOD if you could just jump out of the hatch. You can't run out of the top because you run into the vertical tail bent on the OHMSPOD. Bail out is a problem, but with the extraction system it looks like we may get around this.

We have a group that is looking at that now and, of course, in the office we are very hopeful we are going to come up with a system that will cover this area of our envelope. I think it is worth pursuing.

Mr. NELSON. Thank you.

Thank you, Mr. Chairman.

Mr. ROE. The Chair recognizes the distinguished gentleman from Texas, Mr. Andrews.

Mr. ANDREWS. Thank you, Mr. Chairman.

I would like to just follow up briefly on what Bill was touching on and that is the escape system. I would like just to get your overall view first about if you could pinpoint a few things that you think need to be changed right away in terms of a reasonable escape system, what would it be?

Hank, what are your thoughts about that? What is the most emergent thing that needs to be dealt with?

Colonel HARTSFIELD. Well, as I just said, I feel that we should pursue this bail out system and, as I say, a group is very active. Steve Nagel from our office is working on that group and heading it up, the part that is concerned with the bail out itself.

Some of the preliminary results look very promising. I think that we have got the kind of expertise in this country around different contracts that could give us a lot of help in that area and I think we could come up with a system that is not all that expensive that we could retrofit into the orbiter and give us some confidence that if we had some of these bad things happen to us, that we can at least save the crew.

And, as I say, I think we have got to wait and see what this group comes up with, but they are working on a tight schedule. I think within a month or so they are supposed to report back to Mr. Aldrich.

Mr. ANDREWS. Do I understand that it is your feeling that it is not realistic to assume that the crew or the vehicle would survive impact on the water under circumstances—

Colonel HARTSFIELD. I feel very strongly that the vehicle won't survive. I think it is going to brake up if it lands on any unprepared surface.

Captain YOUNG. It hits down about 200 knots and the Navy and the Air Force have no reported survivals of ditches that occurred at over 140 knots. So when you talk about kinetic energy, that is one-half MV squared, and as velocity goes up, things really start coming apart.

In order to get heavy weights into orbit, we had to design the system so it really doesn't have a high G cockpit like you provided for fighters or attack aircraft and it has a very low design for crash loads in both the payload bay and the forward nose part.

So those things theoretically will come apart when you hit the water because they are very low crash loads provided them. So even if everything did come out right and the crew was still alive in the cabin, I think the probability is the payload would be right up there in the cabin with them.

Mr. ANDREWS. Right.

Commander GIBSON. Mr. Congressman, if I can add to that, I think if you asked around within the astronaut office and asked what the general feeling was about a ditching, which is after a contingency abort, two or three engines out, I think you would find the general feeling is that we are not going to survive a ditching.

Mr. ANDREWS. You all don't take those life raft training exercises too seriously then, I gather?

Commander GIBSON. No, sir. I have to confess we really don't. Your question as to what the most immediate thing is, I think is, was hit right on the head by the Presidential Commission. I think their recommendation that said we ought to develop as quickly as we could a means to escape from a controllable sub-sonic orbiter, I think is the most immediate thing, so we have some recourse in the event of two engines out over ditching.

Mr. ANDREWS. Deke.

Major SLAYTON. I was going to comment there were some studies done—in fact, tests were run down at Langley Field in their water tank of shuttles ditching capacity. It ditches very nicely as a model. The dynamics of it are beautiful.

But as John said, the structural loads are fantastic and the probability is it is going to break up. That was the conclusion in that time frame.

Mr. LUJAN. Will the gentleman yield with one question in regard to that?

We are talking about an escape opportunity, but just for a very short period of time; isn't that correct? Because the first 2 minutes everybody agrees nothing could be done. And once you get into orbit—well, if you parachute out, you can't get down anyway.

So for how long a period are we talking about that you could use that escape hatch?

Colonel HARTSFIELD. Well, the oxygenators, again, that is loose in these engines, you could lose the engines late in the launch before you make orbit such that you don't have enough velocity to get to orbit and you are coming down in the Atlantic near the coast of Africa. For example, there would be a case where, this type of contingency abort we are going into the water, but with this kind of system we would have a chance of getting out of it. So in some respects if you look at it, it does cover quite a bit of the launch trajectory.

Mr. LUJAN. I am sorry. I don't want to take a lot of time, but how long can you glide subsonic, would you say?

Colonel HARTSFIELD. Well, as you now, it is not a very good glider, but—

Mr. LUJAN. There is a long ways to fall, too.

Colonel HARTSFIELD. The context we have looked at preliminarily is there is plenty of time to get the people out in glider flight.

If you consider that you have got to start getting them out say around 20, 25,000 feet, there is time to get everybody out before the orbiter strikes the water, get them out by 5,000 feet.

Mr. ANDREWS. Just to follow up, does that suggest that we would have to limit the number of payload specialists that we could have onboard? Can we have an ejection system that works, gives you that window of time that you need to get everybody out and still carry as many specialists onboard as we do now?

Colonel HARTSFIELD. That is part of the study that Steve Nagel is looking at and certainly it may turn out that we have a limit on crew size. But we are at this point—we have not reached that limit. We are looking at systems that can get a number of people out.

Mr. ANDREWS. Do you think it is reasonable to have seven? Could you speculate on whether or not you could do it with seven at this point?

Colonel HARTSFIELD. I would rather not. I think I would rather let this group come to their own conclusions.

Commander GIBSON. I think, Mr. Congressman, we are looking at kind of a two-part problem. The first one is let's address the, can we escape from gliding under control and then beyond that is there anything that we could develop that has capabilities that would help us further during the ASEAN phase. When we start to say what can we do with the particular escape systems, they say what are your particular requirements? Do you want Mach 4, Mach 6, Mach 10, and what altitude do you want to be protected against immediately for the rocket motor at the re-entry heating, so I think we probably are approaching this from two phases. One being the gliding, jumping out of it and there you could conceivably accommodate seven people. Ejection seats, I don't know exactly how we do that with seven people. But I think perhaps as we go far they are down the line we may be able to find some way of doing that and I think we may be able to find some larger envelope we can handle other than just gliding flight.

Mr. ANDREWS. Thank you.

Thank you, Mr. Chairman.

Mr. ROE. The Chair recognizes the distinguished gentleman from New Jersey, Mr. Torricelli.

Mr. TORRICELLI. Thank you, Mr. Chairman.

Let me suggest that I believe our five witnesses today have made a real contribution, in that they have suggested to us something we should have realized all along, and that is that no new structure within NASA is going to be sufficient, and consultations among NASA officials will never be enough, and what simply must be achieved is real trust, and that is, of those who are going to own, operate, fly, believe and need the shuttle, they are going to have to have trust in the judgments of those who are making decisions.

But I think one of the contributions that you helped us understand, in addition to the needs to have trust in NASA management and the technical people who work for them, is that so many of these issues are so incredibly complex, is that no crew could ever be assembled that would know all the engineering requirements of the shuttle, that they would be in a proper position to exercise vetoes or independent judgments about whether or not the shuttle should fly.

I have received some of those—I have reached some of those conclusions myself from comments that were made today, and I felt they were real contributions.

Let me say, in addition, as much as I was impressed by those comments, during the course of the Rogers Commission's deliberations, some comments were made, not surprisingly never attributed to different crews of the shuttle, suggesting that some of the civilians who had flown, including Members of Congress, teachers, prospective journalists, scientists, did not make noteworthy contributions to the flights.

Comments were made to some annoyance of their contribution and presence on the flight. Let me suggest this to you as members

of the astronaut corps. The shuttle belongs to the American people, and we all have different objectives for it, and not all even involves science.

There are reasons for having journalists, writers, poets, scientists on board the shuttle that may not be appreciated by the astronauts or some in NASA, but they are appreciated by many of the American people, and they are very real, and I only say that because as much as I think the astronauts made a real contribution to the deliberations of the Commission and to this committee, I think it is worth reminding yourselves of those things as those things go forward, and we all have different objectives.

Let me ask Deke something, we were in the Soviet Union together, and it is ironic now to note, and we stood watching the latest achievements of the Soviets with their space program, and with more than a little pride noted that our technology was superior, and while they were impressed by what they were doing, we really considered that we were not at all in the same league.

Well, that which we then saw as prospective science is now flying and ours which we marveled as being a real achievement is not, and ours is not. You have now seen NASA go through several generations of talent and of personnel.

Is the talent what it was? Do we have the same confidence in the best and the brightest of the American population, not just flying, design, leadership, not just at the top levels, but at mid-levels, should this committee be equally concerned about the talent we have in NASA as we are with the engineering that is being provided for NASA, as you have seen it evolve over these last number of years?

Major SLAYTON. That is a very good question, and I am not sure I am qualified to answer it. My opinion is, speaking of flight crews, probably the later groups, as we have gone along, have been more qualified than those of us who started.

We have gotten a higher level of excellence as we proceed on in this space program, because people have set being an astronaut as a goal at a very early age, and they have trained for it, and they are very competent to do that job.

Mr. TORRICELLI. What has come before this committee, judgments we share, is that people who are in these management positions have to be able to make judgments on extremely complex technical issues, and they may not be from their own fields of study.

No one in management could have been involved in all of these fields of study, and yet have to reach those judgments.

That is true now, and it was true before. Do we have personnel as best as possible in management positions indeed as good as they were when you were flying to reach those judgments?

Major SLAYTON. That was a point I was getting to, I think not only the astronaut corps, but in the rest of NASA, the same thing has happened. The younger engineers who come in to do the engineering jobs are more competent today than the people that started in the program.

Maybe the one thing that might be lacking, if you want to go the top level, is that in the early days, we had some guys evolve out of the military; and they had a different level of discipline, maybe involving people today that are more technically oriented and not as

capable of dealing with operational problems, but the technical competence in the agency is equal to what it was before and maybe even better.

What we are dealing with here is really a communications issue, and a management issue, but certainly not a technical competence issue. Some of that is understandable, I think, when you look at relationships between the centers and how the organization is structured; and you could say it could be restructured so you don't have intercenter jealousies interfering with the communications channel.

A lead center concept where level 2 is viewed by the other centers as being another center instead of having its headquarters' level is one reference I would make.

A lot of it in the management attitude; but again, my opinion is, you can make any organization work if you got the right people, and if you don't have the right people, I don't care how you organize it, it will not work, so you still end up dealing with individuals.

Mr. TORRICELLI. That is part of the point I had hoped to come out here. We are seeking the perfect system, the right arrangements of boxes, and personnel judgments, and in fact, no system will operate properly without the right people and indeed with the right people, even a badly flawed system will operate sufficiently.

Major SLAYTON. Precisely.

Mr. TORRICELLI. Let say finally, Mr. Chairman, having now acknowledged that I think a real contribution has been made here in the understanding that this will not be fixed by putting in new levels of management or bureaucracy, but rather by having trust among the component parts of NASA, there is one other thing that I think we can do, too, and that is—rather what you can do, too.

That is, the need to have the shuttle fly again, that there not be a national obsession in transforming the shuttle into a flying baby carriage. We will never achieve perfection and absolute safety.

Only you have the credibility to say that to the American people, and I think Mr. Cripeen may have said it best for us, and that is, if astronauts had this power in the past to stop launches, they would have taken risks that management would not.

The American people need to understand that. We are on the cutting edge of science. We are pushing the limits of technology. It will always be inherently dangerous. We need to know that, and need to understand there are risks to be taken, or America will never fly again, and only you can say it, or we are dismantling NASA now, and will do that too far and in understanding the risks, we are going to become obsessed with them.

I hope that is a contribution you continue to make as a group.

Thank you, Mr. Chairman.

Mr. ROE. I thank the gentleman.

I am going to recess until 1:30. We would appreciate it if you could all come back and meet with us at 1:30. We will do that, and we will have Mr. Lewis from Florida who will lead off at that point.

Following Mr. Torricelli's comments, I think it is important to get on the record and think about this, if you will, there seems to be an accelerated exodus of the astronauts leaving the system, and

we want to talk a little bit about that, and the general morale as you would see it within the corps itself.

We also want to talk about the pay level; in other words, have we backed up against the problem that the people who are participating both at management level, and in the astronaut corps, that the pay scales are forcing people to leave the system, so think about that, and we will start with those problems when we come back.

The committee will stand in recess until 1:30.

[Whereupon, at 12:15 p.m., the subcommittee recessed, to reconvene at 1:30 p.m., the same day.]

AFTERNOON SESSION

Mr. ROE. The committee will reconvene.

When we broke up for lunch, we were talking about really personnel matters, and I believe Mr. Torricelli had started that part of the discussion, and then we got to the point view as to what, there seems to be an extensive exodus from what we can understand beginning to take place on the astronauts leaving the agency.

That is one item. What is the morale of the agency at this moment, or are there more astronauts that will be leaving that you are aware of, and what should be done about it? Anybody want to start that off? What is your observation now?

I have a document that was under date of December 18, 1985, that came to Congressman Frank Wolf, in a response to our colleague, Frank Wolf, from John F. Murphy, vis-a-vis the personnel situations that they were observing in NASA.

I would like to add this document, by the way, to the hearings at this point. If there is no objection, so ordered.

[The information follows:]

C:MKK:jmb:C17382f

DEC 18 1985

Honorable Frank R. Wolfe
House of Representatives
Washington, DC 20515

Dear Mr. Wolfe:

This letter responds to your October 30, 1985, correspondence in which you requested information about recruiting and retaining top quality individuals for federal service. The situation at NASA is highlighted below. We will respond to the issues you raised in the order in which they were presented.

Caliber of Recruits:

Using grade point average (GPA) as a measure, the caliber of scientist and engineer "freshouts" (GS 7-9) that NASA has hired over the last three years has remained constant with an average GPA of 3.2 on a 4.0 scale. However, NASA management is concerned about the ability to attract graduates from this country's most prestigious universities.

We have conducted some analysis of NASA hires from schools identified as top ranking as listed in the May 1980 issue of "Engineering Education" (Enclosure A). As you will see, the number of freshouts we have been able to recruit from the top ten engineering schools has dropped from 11 percent in Fiscal Year (FY) 1983 to only 6 percent in FY 1985. Out of our 524 freshout hires in FY 1985, one student was hired from the Massachusetts Institute of Technology, none from Cal Tech, two from UCLA (Berkeley), and three from Stanford. In FY 1985, only 23 percent of our freshout hires came from the top 36 engineering schools on the list. In comparison, we hired 28 percent from this same group of schools in FY 1983 while Hewlett-Packard hired 40 percent from these schools.

In summary, although we have no real evidence of a decrease in the quality of our hires, there is a growing general perception that quality may be declining. Due to the technical and complex nature of our mission, it is a concern which we share with you.

The Caliber of People NASA Is Losing and Why They Are Leaving:

Between FY 1983 and FY 1985, NASA scientist and engineer losses for reasons other than retirement increased from 294 to 361

employees (Enclosure B). Most of our separations occurred at the GS-13 grade level and above and represent the loss of fully trained, experienced personnel. Of the 361 losses, nearly 25 percent indicated their resignation was due to a higher paying position. It is our perception that a greater number actually leave to accept higher paying positions but do not indicate that as the specific reason. We also believe that some personnel who retire also do so to accept higher paying positions, but we have no specific data on the numbers involved.

Recruiting Programs on Campus and the Success of NASA's Efforts:

Our eight field centers do on-campus college interviewing at more than 150 schools. However, planned campus visits are sometimes cancelled due to either a lack of student interest or a lack of NASA travel money.

Our private industry competitors often send numerous representatives to campuses prior to their interview dates in order to host various activities. They place full-color ads in campus newspapers and placement manuals and advertise through other on-campus media. Their financial resources allow them to do the type of marketing necessary to attract students to their interviewing schedules. Once the students are interviewed, our competitors have the resources to invite students to tour their facilities. Their salary offers often average between \$3,000-\$5,000 greater than NASA's.

Budgetary limits simply do not permit NASA to compete well in the open marketplace. Our field centers have no specified recruitment budgets, except those designed to cover travel expenses. There is no specific money for recruitment advertising, recruitment brochures, pre-recruitment on-campus programs or lectures, workshops, receptions, faculty luncheons or other activities to highlight NASA programs. Despite our best efforts, more than 40 percent of our employment offers to freshouts were declined in FY 1985. At our Ames Research Center in California, for instance, 55 percent of the offers were declined.

These declination rates, however, do not capture the magnitude of the problem since they reflect only those who turn down a formal employment offer. Far more students simply indicate that they are no longer interested in being considered once they compare

our salary offers with those offered to them by private industry. Although we have been unable to quantify the exact number, we firmly believe that only by adding the "no longer interested" responses to the 40 percent declination rate can one begin to realize the serious nature of the problem.

Difficulty in Filling Vacancies at NASA:

All of our field installations experience time delays in filling position vacancies. The major reasons for such delays are our high rate of declinations due to low starting salaries and the shortage of candidates in the job market. The following examples illustrate some of the delays.

Ames Research Center:

This past year the Ames Research Center (Ames), Moffett Field, California, experienced an increased emphasis on computer development and applications. Due to hiring difficulties, this need has largely gone unfilled. For example, ten senior-level computer related electronics engineering vacancies attracted only nine eligible candidates. This response occurred despite extraordinary recruiting efforts, including newspaper advertising and tech-fair participation. Of these nine candidates, three received offers. Two refused the salaries offered, although one eventually accepted an advance-in-hire rate comparable to a private company's offer. This inability to attract high quality candidates, despite extensive recruitment efforts, is attributed to the high demand for computer/engineering expertise, a shortage of high quality candidates, the high cost of living in the Silicon Valley (where Ames is located), and an inadequate government salary and benefits package.

The competition for engineers and those with computer skills at all levels is extremely keen in the Silicon Valley area. A local paper there stated that there were more than 900 major and small high-technology firms within commuting distance of Ames. Daily, there is an array of aggressive advertisements from private industry competitors in the "San Jose Mercury News." As an example, the Lockheed Missiles and Space Company (located adjacent to Ames) recruits extensively due to an increase in defense contracts. Reportedly, they hired almost 1,000 new college graduates last year. Their offer of \$37,000 to a Stanford graduate with a Master's degree in electronics engineering was substantially higher than Ames' offer of \$25,980.

At the Dryden Flight Research Facility, an element of Ames, recruitment for entry-level engineers has been difficult due to the \$5,000-\$10,000 salary gap that exists between private industry and the Federal Government, especially in that area of the country. The demand for qualified engineers in the Southern California area is high, especially with the increase in defense spending. This area is noted for a predominance of large aircraft manufacturers (i.e., Rockwell, Boeing, McDonnell-Douglas, and others). NASA is unable to compete with the salaries and benefits offered by these firms.

National Space Technology Laboratories:

Three computer/engineering positions at our National Space Technology Laboratories in Mississippi were advertised in November 1984. One of these positions was filled in April 1985, and the other two positions were filled in May 1985. Even though these positions were advertised locally and nationally, it took five to six months to fill them.

Kennedy Space Center:

At the Kennedy Space Center in Florida, recruitment for one entry-level engineering position was initiated in December 1984. Approximately 20 candidates were interviewed, and three indicated some interest in this position. Offers were extended to all three candidates; however, all three declined. Two of the declinations were due to the low salary being offered, and recruitment action for this position was eventually cancelled. As a result, an agency staffing need was not met.

In January 1984, recruitment for eight electronics engineering positions was initiated. As of May 1985, four of these positions remained unfilled. More than 30 offers were made during that 16-month period, and better than one-half of the candidates declined due to salary. At Kennedy, as well as other centers, the bulk of the mission related work is performed by contractor employees who work side-by-side with NASA employees. Therefore, candidates for employment with NASA often decline NASA offers because they can still work with the space program at the same location for a significantly higher contractor salary.

In closing, we must say that NASA shares your concern for the well being of our Nation's programs, and we welcome your support to remedy these difficulties, especially the difficulties that would impede NASA's progress toward accomplishing its unique mission. Hopefully, the information and perceptions we have shared in this letter will be useful to you.

Should you or your staff wish to discuss this matter further, please contact Ms. Christine Rodgers, Chief, Staffing and Employee Relations Policy, at NASA Headquarters. She may be reached by telephone at 453-2597.

Please let us know when we may be of further assistance to you.

Sincerely,

Original Signed By
John F. Murphy

John F. Murphy
Assistant Administrator
for Legislative Affairs

Enclosures

Attachment AENGINEERING SCHOOLSTOP TEN

	<u>NASA HIRES FY '83</u>	<u>NASA HIRES FY '84</u>	<u>NASA HIRES FY '85</u>	<u>HP 83</u>
1. MIT	6	5	1	20
2. U. of Ca. Berkeley	3	4	2	65
3. Stanford	4	4	3	49
4. Harvard	0	0	0	12
5. Illinois, Urbana	9	4	5	23
6. Michigan	6	4	8	19
7. Cal Tech	0	1	0	4
8. Ohio State	15	4	11	8
9. Purdue	11	7	3	30
10. Columbia	<u>0</u>	<u>0</u>	<u>0</u>	<u>4</u>
Totals	54	33	33	234
	$\frac{54}{516}=11\%$	$\frac{33}{291}=11\%$	$\frac{33}{524}=6\%$	$\frac{234}{1200}=20\%$

School rankings appeared in article "A Rational Method for Ranking Engineering Programs" Engineering Educations, May 1980.

ENGINEERING SCHOOLS2ND TEN

	<u>NASA HIRES FY '83</u>	<u>NASA HIRES FY '84</u>	<u>NASA HIRES FY '85</u>	<u>HP 83</u>
11. U. of PA	0	1	1	9
12. Carnegie Mellon	2	0	1	8
13. Wisconsin	5	0	2	26
14. Princeton	0	0	0	6
15. Texas	0	2	13	10
16. Cornell	0	0	0	16
17. Northwestern	1	0	3	9
18. Yale	0	0	1	3
19. Case Western Reserve	8	3	6	5
20. Iowa St.	<u>2</u>	<u>0</u>	<u>1</u>	<u>19</u>
Totals	20	6	28	111
	$\frac{20}{516}=4\%$	$\frac{6}{291}=2\%$	$\frac{28}{524}=5\%$	$\frac{111}{1200}=9\%$

ENGINEERING SCHOOLS

3RD TIER (16 SCHOOLS)

	<u>NASA HIRES FY '83</u>	<u>NASA HIRES FY ' 84</u>	<u>NASA HIRES FY '85</u>	<u>HP 83</u>
21. Minnesota	8	1	3	12
22. Ill. Inst. Tech	1	0	0	2
23. Georgia Tech	18	14	15	11
24. Lehigh	0	0	0	2
25. Pittsburgh	4	0	3	1
26. Texas A&M	8	9	13	13
27. Washington	2	0	0	23
28. VPI	14	3	16	8
29. Wash. U. (St. Louis)	0	0	0	6
30. Stevens Inst. Tech	0	0	0	1
31. Florida	4	2	5	5
32. U. of So. Cal.	2	0	0	9
33. RPI	6	2	5	7
34. UCLA	1	0	0	15
35. Utah	0	0	0	8
36. Oklahoma State	<u>0</u>	<u>0</u>	<u>1</u>	<u>7</u>
Totals	68	31	61	130
	$\frac{68}{516}=11\%$	$\frac{31}{291}=11\%$	$\frac{61}{524}=12\%$	$\frac{130}{1200}$

OVERALL % FROM TOP 36 ENGINEERING SCHOOLS

NASA's S&E FRESH OUT HIRES

FY '83 - 28%

FY '84 - 24%

FY '85 - 23%

Hewlett Packard 1983 - 40%

S&E FRESHOUT HIRE REPORT

FY '85

CENTER	AVG. GPA	FRESHOUT S&E HIRES	# FROM TOP TEN ENGR. SCHOOLS	# FROM 2ND TEN	# FROM 3RD TIER	TOTAL	% OF HIRES FROM THESE SCHOOLS
<u>OSSA</u>							
GSFC	3.2	95	1 (1%)	1	4	6	6/95 = 6%
<u>OAST</u>							
Ames	3.4	33	7 (21%)	1	1	9	9/33 = 27%
LaRC	3.3	26	1 (4%)	0	6	7	7/26 = 27%
LeRC	3.3	72	12 (17%)	9	6	27	27/72 = 38%
<u>OSF</u>							
JSC	3.2	105	6 (6%)	12	27	45	45/105 = 43%
KSC	3.2	56	3 (5%)	0	9	12	12/56 = 21%
MSFC	3.0	135	3 (2%)	5	8	16	16/135 = 12%
NSTL	3.5	2	0	0	0	0	-
AGENCY TOTAL	3.26	524	33 (6%)	28 (5%)	61 (12%)	122 (23%)	

Attachment E

NASA S+E Losses Excluding Retirements
(all grade levels)
FY '83 - FY '85

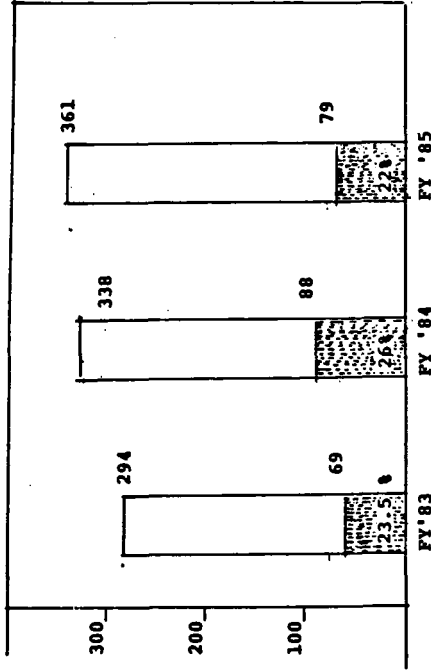

Legend: Clear bar reflects all losses, excluding retirements
Shaded bar shows losses for higher salary

Note: Percentages reflect number of employees who actually stated their reason for leaving was due to higher salary. Other separated employees may have done so for the same reason, but chose not to share their reason for leaving. Thus, the number of employees who left for higher paying jobs may be significantly higher than these figures indicate. Some retirees also left for higher paying positions, but we have no data on the number.

Mr. ROE. He says, however, NASA management is concerned about the ability to attract graduates from this county's most prestigious universities, the number of fresh-outs we have been able to recruit from the top 10 engineering schools has dropped from 11 percent in fiscal year 1983 and only 6 percent in 1985.

It further says, although we have no real evidence of decrease in the quality of our hires, there is a growing general perception that quality may be declining.

NASA scientists and engineering losses, for reasons other than retirement, increased from 294 to 361. He goes on and says, that where private industry is involved, their salary often averages between \$3,000 to \$5,000 greater than NASA's, and so forth.

He goes on to say that these declination rates, however, do not capture the magnitude of the problem since they reflect only those who turn down a formal employment offer.

Far more students indicate that they are no longer interested, so that came from the NASA folks, and that is their observations. I want to know what your observations are, if you want to tackle that.

Captain Young.

Captain YOUNG. We don't hire very young people to be astronauts. They require engineering degrees and scientific degrees, and the best qualified usually have doctor's degrees.

I don't think that the NASA has ever had any trouble getting the best people for the kind of work that we do in the Astronaut Office into the program.

A lot of people come in to be selected as astronauts and have an idea that we are doing something different besides engineering work, design work, flying work and minding payloads and some things that are not quite as glamorous as they see in the movies, like "The Right Stuff," but we don't have any problem whatsoever recruiting, and any time you want to recruit, you could get the best people out of the military services, out of the civilian service, and the kind of people that want to be astronauts, and do the kind of work that we do, are available, and they put in for the program every time we pick them.

We have an agreement with the military services on a case-by-case basis, that some people would probably want to be back to the military service to finish out their tours. In other words, before they retire, they would probably want to make general or admiral, and the way we are right now at the National Aeronautics and Space Administration, it would be very difficult to do that, because it is not a line-type organization, in research and development, so that is where that stands.

We expect to lose some more people, and we also expect that some of the more senior military people will retire and go into private service with companies.

Mr. ROE. You don't see this to be a problem at this point?

Captain YOUNG. No, I think it is to be expected, though, during the stand-down period, young people and very senior people who are not going to fly will go, will go into some other line of work, particularly military people, and this is because the military people who go to work directly for the Federal Government, at any reasonable pay rate between the comparison of the pay they could get

on the outside, and the pay they could make working for the Government will take a significant financial hit over what they could make, even if they could stay at the military service and work at NASA.

Mr. ROE. Should there be some other kind of added incentives in pay to keep the astronauts longer?

Captain YOUNG. If you want senior military people, like Dick Truly, an admiral, if you want senior military people to be in management positions, to be associated with NASA, because of the way the pay structure is, and I am just hypothesizing a solution to the problem, would be to provide a certain number of general or admiral billets and fill them with senior management astronauts.

That way, you could get them to stay and work for the National Aeronautics and Space Administration, and participate as senior management officials. That is the only way I could think of to do it.

It would probably take some incredible new law or something like that, which would be very troublesome, but that is the only way I see sort of legally to incentivize senior military people to stay and work at NASA as managers, because of the financial burden that they would take, if they can't stay in the military, they have to retire at a certain point in their military careers.

Mr. NELSON. Could I ask you to ask the opinion of General McDivitt? He is one of the few that, with his association with NASA, was promoted to a general officer, and just what John is saying has been a problem.

That is why Dick Truly, in part, left the active astronaut corps, because by going back in the military, he had a chance to take a command, get promoted to general officer status. Now, we have the benefit of him as an admiral, admirable admiral, as a matter of fact, coming back to NASA, but that is why he left the active astronaut corps.

Mr. ROE. Do you want to comment on that, General?

General McDIVITT. Yes, Mr. Chairman, I would. I would like to go back to when I first became an astronaut. I think Deke might have participated in this meeting with Congressman Teague when he was a subcommittee chairman for the Space Flight Subcommittee for this committee, and asked us at that time what we thought about the pay for astronauts.

The conclusion was for those people in the military, we ought to keep it at the same pay as the military. There may be a lot of guys on my left who don't like that idea, but the thought was, if you were a military officer, the things that you were doing as an astronaut were somewhat different but not totally different than all the other people in the military, and if you wanted to have a military career, you could progress through the ranks at the same pay as all the other people who took risks.

This is a risky job, was for me, being an astronaut, and there are a lot of people in the military who take tremendous risks, too, so we didn't feel that it was worth a disruption in the normal military structure to take, and pay special attention to astronauts.

So I served as an astronaut, and I think I made about—I was a captain when I started, I made about \$9,500 a year when I started.

I rose through the ranks of—I think lieutenant colonel, in the Astronaut Office. When I transferred over to Program Management, I went into a slot which didn't have an equivalent star rank associated with it, but there had been a lunar module program general who was an Air Force general, probably equivalent to a major general slot, and General Phillips had been a three-star general, so it was about a two-star slot if you wanted to slot it against a military equivalent.

I started there, I think, as a colonel, and I subsequently got promoted in that job to brigadier general. I went into that job because I wanted to get into management, and I had that opportunity, and it looked to me like the best aerospace management job that was going to happen this century, so I took it.

I didn't take it because of the pay, and the interesting thing was that being the program manager, I probably had—I didn't have any other military people at the time working in the program office, but I probably had about 75 of my top level people who worked for me making more money than I did.

I had the opportunity to retire, resign, whatever, and I had the opportunity after I retired to take a job with NASA in one of the excepted positions. I am not sure what they call them, but there are positions within the civil service part of the Government where you can collect your military retirement and also get civil service pay.

I had that opportunity, but I had elected at the time to do something else. I had sort of set out a career path for myself, which included flying until I decided it was time to quit, and when you are flying, there are probably three ways to leave the profession.

One is to get killed. One is to flunk your physical, and the other one is to quit at the time that you think it is appropriate to quit, so I see astronauts leaving is not necessarily a bad sign, but probably a good sign.

At some time, they have to do that, and it is better to control your own destiny at the time you would like to leave as to flunking your physical. I had a career plan, and I was going to fly until sometime undefined, and move into program management and then leave the military service and do something else, which is what I did, but I found that management job to be quite rewarding.

I was accepted earlier as an astronaut, also as a military officer, and I found no friction whatsoever. I had good support from the Air Force at the time. I am really pleased to see Admiral Truly come back and jump into a job like that, because it is important that the knowledge that they pick up grunting around as an astronaut and moving up through the ranks can be put to good use in management, and I would encourage that this be done.

But there is no way that a person in management can be a surrogate for the Astronaut Office, or representing the Astronaut Office. The only one guy who can do that is the guy who is running it, and when they jump into management, they have to go into management and do the management job that is expected.

Mr. ROE. Any further comments on these issues?

General McDivITT. Deke, do you want to add anything about that meeting we had 20, 30 years ago?

Major SLAYTON. We were looking at the concept of whether there shouldn't be a pay supplemental for the people in astronaut jobs and the relationship between the civil and the military. I think the right decision was made.

There are guys in the military that certainly take an equal risk with this, and there shouldn't be any discrimination, so nobody ever went into this business to make money. If they wanted to make money, they go do something else, and it is because it is a challenge, and you go do it.

Commander GIBSON. I will agree with what General McDivitt and Mr. Slayton said. Any of the guys who are doing what we are doing now is not because of the money involved, but because it is something we love to do, and I agree with General McDivitt, I think that we as military members of the Navy or the Air Force, as a commander or colonel or lieutenant colonel, are doing a hazardous job, but perhaps no more hazardous than what other members of the military are doing, and I think we should stay exactly where we are.

Mr. ROE. Captain Young.

Captain YOUNG. Don't misunderstand me. I don't think it is a pay situation. What I am saying is, one of the recommendations was to use astronauts in senior management positions more often, and if we are going to do that, the senior military people, before they can stay with NASA, the way the system is now, most of them will have to retire, and take a big pay cut at a time when they are trying to put their kids through college.

I think that would be very difficult for them to do, but if they wanted to get into management positions, they can no longer do that as a colonel or captain in their respective military service.

They are going to have to terminate their service with the Government or they are going back to their service like Dick Truly did to get into a senior management position, and that is what he did.

I don't think anybody is in the Astronaut Office for the pay associated with the job, or any time, as we have said many times, any time somebody doesn't want to be an astronaut, they are better to go out the door.

That is better for the Government and certainly much better for the whole space program.

Mr. ROE. The gentleman from Florida, Mr. Lewis.

Mr. LEWIS. Thank you, Mr. Chairman. I am a little bit confused. Right now, there are certain members of the astronaut corps who are career-blocked, as long as they stay in the corps. In other words, I believe the Navy, you can only go as high as captain?

Captain YOUNG. Yes, sir, that is correct. That will be true, in the Air Force, you will be up to colonel, and then if you went into management at NASA, you might get promoted, but it would be very unusual.

Mr. LEWIS. Do you think this restriction should be eliminated, so that you can—true, you are not taking any more greater risks than other people in the military, but you shouldn't be penalized for being an astronaut, which essentially you are, if you stay on the list to become an admiral or BG, you have to stay a captain for, say, 4 or 5 years, if you remained in the corps?

Captain YOUNG. The way things are now in the services, for people to advance in their service, the procedure is right now for them to return to their parent service to do that kind of advancement.

I am not saying that is wrong, but that is the situation. If you want to have astronauts as senior managers who are military people, some look at that kind of a system, ought to be looked at a little more, because when you put people in senior management positions, both their rank as a civil service person and their rank as a military person ought to be commensurate with their job responsibility.

Mr. LEWIS. I see.

Colonel HARTSFIELD. I think that is what was said about the limitations in the office. You can't be a pilot astronaut and be a general, the job doesn't call for it. To make flag rank in my mind, you have to have the responsibilities that are commensurate with the rank, so to be promoted and stay with NASA, I think you have got to be given a management job which is not in the Astronaut Office itself.

Mr. LEWIS. I would like to explore a little bit about the safety systems. I recognize it is an accepted fact that during the first 2 minutes of the flight, that it has been written off, nothing can be done. I also realize that there is a great difficulty in terminating the thrust of the rockets, that has to be done instantaneously, at the same time or else you torque and tear up the vehicle. But we did have an escape hatch, I believe it was in the Apollo Program and in the Mercury Program, is there some way we could be looking at a similar type of system so you could blow the crew cabin loose from the entire shuttle with an escape tower and then dump the tower, and deploy a shoot or something like that, or is this so cost-prohibitive we forget about it?

Captain YOUNG. One of the design concepts that is being looked at right now; but the present thoughts are that that is extremely expensive and extremely complicated and would be a complete redesign of whole space shuttle, and it just doesn't seem like a thing you can do if you ever want to fly the space shuttle before the 1990's, plus it costs you a whole lot in payload, and there are other ways, maybe even in first stage to achieve the same thing with an awful lot less, with an awful lot less change to the vehicle.

We are looking at techniques right now that use software on board that will allow you to lose one or two or three engines early on possibly, and make it back to the landing site.

It is some pretty sophisticated automatic programming, but since it is a flying machine, some of those things seem possible, and those things, coupled with escape systems. Technology in escape systems, has come a long way in the last 15 years. It is absolutely remarkable what has been going on in this country, and maybe some of those things will help us solve some of that problem in the first 2 minutes, as opposed to complete redesign of the whole piece of machinery.

Mr. LEWIS. As we have done in the past, isn't there a possibility that we could be looking at designs as we go and put them in the shuttle 2 or 3 years from now, or even a year or two from now?

I don't mean to freeze our schedule, until we would have a safe sort of system, I know we like to be safe constantly, but we know there is a calculated risk, and it is going to be there, but we could look at that down the pike.

Captain YOUNG. Congressman, you are absolutely right, and we could give you the information that is being briefed to some of our senior management this week, and with some of these designs that people are looking at, it will be a quite comprehensive, thorough review, and we have just started on it, and some of these ideas are really unusual and have a lot of thought behind them.

We would like for you to see them, but the complicated details of an escape system that tears up the whole orbiter, I don't remember just how that was put together and worked. We sure would be glad to brief you all on that later on.

Mr. LEWIS. That would be nice to have that. Let me ask you also, as we start flying once again, and as we progress, how far are we from making a night landing with instruments in the shuttle? How far away are we?

There is always going to be that possibility that we might have sufficient areas socked in, and you may not be able to come out of orbit to come to some of the auxiliaries, so how far away are we from making an instrument landing with the shuttle?

Commander GIBSON. You may recall we have made several night landings.

Mr. LEWIS. I understand. That was instrument timed, as well, but that doesn't happen anymore.

Commander GIBSON. We feel we are a fair ways away from an automatic landing or a landing under zero-zero weather conditions, a fair ways away from that kind of a capability, because of a lot of the dispersions and things that we see built into the vehicle's performance, it being able to do an automatic landing. We originally have done an automatic approach down to around 200 feet, and in general, we have not been as happy with the development and the progress in that particular area, in a number of areas, one of them being the crew's ability to monitor what is going on and intervene if something is not right. We don't have the correct displace to be able to watch what is going on and know when it is time for us to take over and not let the thing progress any farther, and we have significant dispersions, and the vehicle lands short of the runway, all of this comes from simulation. The vehicle many times will land short of the runway and other times half way down the runway. Automatic landing, we don't really feel that that is the wave of the future for the shuttle. I think we can possibly work on the weather minimums and work on crew training and reliability within the machine and better our averages at getting back, but we don't feel really that automatic landing is the way to go.

Mr. LEWIS. I see.

What kind of limitations do you feel should be placed on civilian flying, if any, when the shuttle starts flying again?

You touched on this earlier this morning, but I would like a little bit more clarification.

Captain Young or Colonel Hartsfield or someone?

Colonel HARTSFIELD. I am a civilian, and I am all for it.

I think there are some very positive aspects of flying. I will offer my personal opinion about this.

There are some career people not on the vehicle, specialists in payloads, the space labmissions. We are taking up a specially trained scientist to operate the experiments in the spacelab; and as I recall, Mr. Charley Walker of McDonnell-Douglas who made his first flight with me on 41-D, and his presence on board was called for because he had a complicated device to run and only he had the expertise to run it.

And in these cases, in my mind, it is very much justified to put these type people on board where they have a very strong crew function. There are other reasons that are at the pleasure of the administration to fly people and some of these programs I applaud.

I can see some good benefits coming out, like the teacher in space, the journalist in space, and these programs are very well laid out and competition to make it fair to everybody. And there are some other areas that I personally have reservations about, but it is agency policy, so I am a little reluctant to speak about—but in the area of commercial payload specialists—that, to me, is something that I personally don't approve of, but there is some good to be gained from it, perhaps.

In all of these cases, I think from the crew standpoint we need to integrate the crew early enough, and this is for all across the board, and by that I mean we need to get these people into the crew training cycle early enough, that we can get to know them and understand how they think and operate. And they can learn how we operate to build a crew, and after all, it is a team effort to fly one of these vehicles.

In the past, the way the program has been run with last minute switching around, payload specialists, in my opinion, that was not the way to operate. We were not given enough time to integrate those people fully into the crew, at least to my satisfaction, so in that light I do have some reservations about the program and the way it has worked in the past.

In some respects, since this was still, in my mind, not an operational vehicle in the traditional sense, still very much a R&D vehicle, that we may have been a little premature in bringing people on board, but that is a judgment call. You have to decide where along the line that it is appropriate to carry extra people.

Mr. LEWIS. I see. I think you have answered my questions honestly. I share the opinion with you. I just feel that there is a scientific need for civilian-type persons to go up in the shuttle for—at that point in time, or even in the past, that was the way to go.

I had another question.

Mr. ROE. I would now recognize the distinguished gentleman from California, Mr. Brown.

Mr. BROWN. Thank you, Mr. Chairman.

I have just one question, but with your indulgence I have a brief extraneous statement beforehand.

I have not been very diligent about attending these meetings with the full committee and I apologize for that.

It was not due to a lack of interest. It has been due to the——

Mr. ROE. George, pull your mike closer, please.

Mr. BROWN. It has been due to the demands of other committees, that I have certain responsibilities, too, and I have also a very high respect for the capability of the leadership of the other members of the committee who are here.

With that brief apology, gentlemen, may I ask just one question. This morning, I was chairing another subcommittee at which a former NASA official appeared who had been responsible years ago for quality improvement in the agency.

He was speaking in the broader context of the decline of emphasis on quality improvement through the American economy, but he pointed out that this had occurred in NASA also.

I would like to ask you to comment as to whether, in your observations, there has been a declining attention to the need to continually focus on quality improvement, and if that has been the case, are we taking adequate steps to remedy that situation in any of the actions recommended as a result of the Commission report?

I don't know who is the best one of you to answer that.

Commander GIBSON. We had perhaps an example of that on Captain Young's second shuttle flight which was the night flight of the shuttle and I guess it was not any intent to reduce the quality, but perhaps the level of the testing that we do with the shuttle also has changed a bit from what we did in Apollo. Apparently, during Apollo we tested every little subassembly, down to the little chips within the computers.

On Captain Young's flight, STS-9, they had a computer failure that was caused by a little ball within a part that wasn't tested by itself.

We went to testing assemblies as one large unit. In other words, we test the computer but not necessarily that little chip, so each little individual item down within the inner workings of the shuttle doesn't get tested to quite the degree and extent that they were years ago during Apollo, and in some instances, perhaps, that gives us a little bit less overall reliability than we might have had in the past.

But it was—I guess, it was a cost-saving measure that was done for the shuttle because of the financial constraints on development.

Mr. BROWN. I suspect a lot of what happened was due to a cost saving, and in hindsight we can see that it was a little bit shortsighted but quality improvement is a very broad concept and it requires the participation at every level of management, every level of operation.

It is a real commitment to making sure that you are constantly seeking ways to improve on the operation, and this is the aspect that bothers me about NASA, as well as about the American industry as a whole, that we are losing out because of a failure to focus on ways in which we can continue to improve in our quality control processes.

And if we have to shake up the whole organization in order to change the culture a little bit to focus on this, we probably ought to do it.

NASA is a critical organization in terms of the need for quality improvement at all times.

Colonel HARTSFIELD. Congressman Brown, some of that has taken place now. I know some people I am working closely with right

now in our office are very much involved in looking at our Life Cycle and Reliability Program, and Mr. Aldrich has directed all these things to come together.

For example, some of the original parts that went into the shuttle were designed for the 10-year lifetime, and the 10 years is coming up next year. Some of these things like tanks were built in 1977, so we are reaching the point where we are going to have to look at a lot of these things and extend the lifetime. And we are trying to pull together—the agency is, I know—a better organized Life Cycle Quality Assurance Improvement Program that I am not sure really existed like it should have in the past, but the focus is on that, and I feel very confident personally that we are going to do the right thing by that.

Mr. BROWN. We are going to have to find some ways to measure this. We use the term “quality control, quality assurance, quality improvement”.

You can't differentiate this from safety. It is the lack of adequate assurances as to quality that caused the safety programs, so the two are tightly tied together and we are going to have to take the necessary steps to change that situation.

Colonel HARTSFIELD. I don't think you would get an argument from any of us on that. We very much support that.

Mr. BROWN. Thank you. I have no further questions.

Mr. ROE. I thank the gentleman from California.

General Stafford has joined us, and we want to welcome you to our panel. We have had some excellent observations and responses from all of the witnesses.

We might want to take you at this point, if you have any initial thoughts you might want to express to the committee, and we will go on from there.

General Stafford.

General STAFFORD. It is an honor to be here today with my fellow colleagues and I regret I do not have a prepared statement since the call came in late last week, and I have been in the middle of a very hostile takeover attempt.

I am defending a corporation, and I arrived about 15 minutes ago in Washington, but I have a series of observations on the Commission's report.

The Commission did a very credible job under very difficult circumstances and all of them should be lauded for their performance in there.

In the letter transmittal from Chairman Rogers to President Reagan, it outlines a basic fundamental fact, “space flight”, or “the Commission recognizes that space flight has a risk associated with it that can not be totally eliminated.”

That is true of the past, present, or the future.

I will go into some highlights under the recommendation one, the design, it states that it is a faulty design in that seal and having reviewed it, I agree with that.

There are similarities, whether you look at the joints in a solid rocket motor or electrical system or a hydraulic system—the weakest points are always the connections and what can therefor be done to eliminate the connections, or simplify a system should be

done, and it is also important that you have an independent oversight as recommended with the National Research Council.

I have seen both in NASA, in the Air Force, people continue to try to fix a system or a design where it should maybe be started over or a new look taken, and this will give it a lot of credibility by using the National Research Council as an oversight.

In the second item, the shuttle management structure, I guess I was never comfortable with the lead center type of management structure, after having seen how satisfactorily Apollo worked.

I think it is, as to Dr. Jim Fletcher's credit, that he has assigned Gen. Sam Phillips who managed Apollo to give an overall review of NASA management and come up with his recommendations.

Basically, sir, both the Space Shuttle Program and the space station are so important to this country that we have to have the right management structure.

I am looking forward to the report that General Phillips—and he had Dale Myers to assist him—to see what they will do with the recommendations.

There are also recommendations that the functions of flight crew operations should be elevated in the NASA management.

I think this is a very important observation, and I will say that after the retirement of Dr. Robert Gilruth, that over a period of years the flight crew operations, directed, and the astronauts tended to be submerged under a level of bureaucracy and this should be corrected.

As years pass, people forget things, and a lot of people don't remember the fire about 19½ years ago. A few at this table do. We were very much involved.

In the same way, 25 years from now a lot of us won't be here to testify or not have this position, but I think it would be somewhat appropriate, sir, if in the language of the bill this year, that it would somewhat direct that this action take place, because you would like to have an organization that functions that is independent of personalities.

And so it is my recommendation that this would be into the law of the land, and down the road if somebody wanted to change it, they could show reason to change it.

With respect to astronauts in management, there has been a lot of good example of astronauts that are qualified that have progressed into various levels at management, both at NASA and in the Air Force, and this is a very valid recommendation of the Commission, that astronauts that are qualified to progress in management at NASA, and I would also say in the DOD.

The next item I will skip, three.

Four, the safety organization, I think it is very valid you have a separate safety organization, but safety does not rest with a safety organization but rests throughout the whole organization from top to bottom, and everybody has to be responsible for it.

The Air Force and the Navy have made remarkable strides over the years, sir, in reducing their operational accident rates, and a lot of that credit can be given to the Air Force and the Navy safety centers and the way they function, and this is a very valid recommendation and somewhat parallels what the Air Force and the Navy has done.

General STAFFORD. On category—I will go to land and safety, category No. 6. I guess I agree completely with John Young that until a lot of things are fixed on the shuttle that she only land at Edwards Air Force Base. I have landed hundreds of times at the Cape, thousands of times at Edwards and the lake beds around it and it is the largest, safest landing place in the world.

One of the major problems with the Cape, you can do a retrofire over Australia and by the time you get a small, puffy cumulus cloud can be a 30,000 or 40,000-foot thunderstorm over the runway and you are stuck with it. Also, if I am correct, Mr. Chairman, that runway at the Cape, at KSC, does not meet Air Force standards for safety and specifications, with respect to the shoulders and some of the overruns.

I think this needs to be corrected. I know Edwards Air Force Base, when I was commander there, we stabilized the overruns for 100 yards each way.

So the heaviest aircraft in the world can go off the runway and there is no problem within that 100 yards.

At the Cape there are deep ditches, and if a shuttle would go off the end and, say, a heavy weight abort return to the landing site, you could damage the shuttle very easily. To me, you have to stabilize both ends of those runways as far as you can go.

This is a standard Air Force practice. You survey every base and as far as you can go on both ends you stabilize the overruns of the runway.

The next issue on recommendation No. 7, launch abort, and crew escape. I am sure this has been discussed here this morning. In my own viewpoint, I reviewed Paul Weitz' testimony to the Commission on page 182. What I think Paul said—and John's testimony was on 184. I agree completely. There needs to be a positive means of crew escape out of the spacecraft orbiter.

This can be done. There is a lot of technology. The early ejection seats we had were SR-71 seats. Those were designed in the very early sixties. A lot of technology has gone forth.

There are things that have come out of Vietnam, like the Yankee system and a Lear jet. Where the flight test has been out of control, this Yankee system would get you out very quickly.

There are also helicopters that have used a similar type system. To me, there is absolutely no reason that you could not have an escape device for five people on that upper deck to get out from a subsonic flight, from subsonic, say, from 0.85 on down to zero velocity, even in a semicontrolled fashion.

This should really be a mandatory item, that a positive escape mechanism is put into the orbiter. Now, I guess one area that I read through the report on page 184, I disagree with my old friend Bob Crippen that nothing could have helped the crew in this instance.

That was my initial reaction, too, but after seeing the findings of the Commission, talking to the members of the Commission, it appears that structurally that crew module was pretty much intact when it hit the water and had they not lost cabin pressure up there, the positive escape mechanism could have possibly helped them survive that whole thing.

This, to me, is a very key issue, Mr. Chairman, that positive escape mechanisms be put into that orbiter, whatever time and money that it takes.

Item No. 8—

Mr. ROE. Just for clarity on that, General, I just want to back up on that point. That is your observation. Your observation is that perhaps if we had developed some type of a safety mechanism at that point that we might have been able to do something with that cabin, the one that we just lost, the *Challenger*?

General STAFFORD. Yes, sir. Reviewing the data and talking to some knowledgeable people, it appears the breakup of—the module was pretty much intact and stayed that way structurally. If the crew module had not lost pressure on that large drag on the flat back of it—it is similarly shaped like a reentry vehicle.

It would have stabilized in a somewhat random fashion and they would have had plenty of time at lower altitude to punch out. Even if they had lost pressure at higher altitude, with an oxygen mask they might have had the situation.

Originally I said nothing could have saved them but then looking as the facts came in from the investigation, I am firmly convinced that they might have had a chance.

Mr. ROE. A number of Members feel as you do, too—I think it is interesting to note everybody starts talking about the cost, the cost—the cost, as you pointed out, we don't know. We haven't finished the study, so we don't really know what the cost would be.

So I think that is a very good approach.

General STAFFORD. Yes, sir. I think this is a mandatory item before the next launch. Now, go back to a little bit of history that Deke remembers very well, when he was head of Flight Crew Operations and I was his assistant that in the design of the shuttle at one time without the crew's knowledge, the two ejection seats for the first flights were baselined out.

After we found out about it, we went back, we had a caucus, we talked to Dr. Gilruth and said without those seats, we don't fly the mission, that is it, period. So they put the seats back in.

At the same time, Dr. Rocco Petrone, we had many physicians in NASA still associated with the Space Program—talked to me about it and he was head of the Marshall Space Flight Center at the time and he said to me:

Tom, I don't understand why you don't have ejection seats in there when this issue was coming up. We will do the best we can to give a reliable propulsion system, but there is no way I can sign a piece of paper to ever guarantee 100 per cent safety.

So he said we needed ejection seats in it and ejection seats were put back in. On item No. 8—I am nearly finished here—on the flight rate, it says NASA must establish a flight rate that is consistent with its resources and, as I reviewed the data, and I talked to quite a few of the crewmembers even before the accident, it was obvious that there was a tremendous strain on the training system, particularly on the simulators. It appears those shuttle mission simulators were working three shifts a day, two for training and one for maintenance after that 6 to 7 days a week.

If you review the data on page 149 in the report, it shows a number of days before launch when they could even get on the

system, it is coming down like that. There is just not that many available days.

I also noted Hank Hartsfield's testimony on page 170 that they were reaching a point where they would have to call it quits, that just the crew would not be trained at that time.

Having managed simulators, worked with them for years, I understand completely the facts we are up against. I guess it was my recommendation, sir, that even for a launch mission profile of 12 per year, you probably will need a third crew station and also that simulator complex was spec'ed and designed in 1972.

It is old. It needs to be upgraded with respect to its computers, its data processing, so it will have more reliability, more flexibility for change out of software and less time for maintenance and that is one of the key items that I think we need.

There is another crew station and the upgrade of that total simulator complex. The other area under flight rate, as we look at the shuttle and the requirements for the national programs in the future, sir, like the space station and SDI and with only three orbiters available, I feel the system is probably stretched beyond what you could effectively use it as.

For example, you could have a blowing tire down the road and the tire could damage a wing. You could have had some type of fault and you could have one or two orbiters down. The space station is going to require at least 18 launches to assemble that station.

You are going to have SDI coming on and I don't think three orbiters will have, as I say, some of the minimum, national minimum requirements besides the DOD requirements.

We have some major long-lead items, major structural items that have already been built and it is my recommendation that we take these long lead, major items and integrate those together into a fourth orbiter.

One area that needs to be clarified. I have heard certain statements like, Why should we build another orbiter when we have new technology? This is probably referred to with respect to the national aerospace plane. Well, I have been on the senior steering committee of that under DARPA for over a year, sir, and the national aerospace plane—I know I have talked to certain members of the committee—is a great program but it is strictly a research program just like the X-15, and it is called the X-30.

There is no way should ever the national aerospace plane be confused with the replacement for an orbiter. It might be the technology for an orbiter maybe the year 2015 or 2020, but one of the major areas for flight rates in this is a construction of a fourth orbiter.

The last item, maintenance and safeguard, the Commission said definitely we should stop pulling parts out of one orbiter and put them to another. As I look down the table here, we are all fighter pilots, probably all have been associated with maintenance in some way, all know what a hangar queen is. That is when you take parts of one plane to try to repair the others.

You order a part for it. In the meantime, you need another part. And it looks like this was kind of the situation that was going on at the Cape. There is no doubt there needs to be adequate data for

logistics and funding for spare parts to meet a realistic launch profile, so you can do away with the hangar queen.

And that, in a short summary, sir, was my observations in going through the report.

Mr. ROE. Splendid. I want to follow up, but I am going to call on the distinguished gentleman from Pennsylvania first, but I do want to follow up and think about it a little bit. We are not going to get into too much policy today, but I do want to follow up on the situation you have generated—you all generated it—is that we are speaking of these really important improvements that we can make, the landing gear, the whole thing.

Then how is that going to go toward the time frame when we fly again. Do we have to retrofit all the things that are involved? I want to get into that.

The gentleman from Pennsylvania, Mr. Walker.

Mr. WALKER. Thank you, Mr. Chairman.

Can I assume that most people on this panel welcome the cancellation of the Centaur Program? Was there anybody who dissented from that in terms of the astronaut corps?

In other words, that was fairly widely seen as something which is positive in terms of the mission. I am getting shakes of heads that won't show up in the record.

General McDivitt. I have no opinion. I don't really know.

Mr. WALKER. OK. All right.

Second, General Stafford, you just talked a little bit about ejection seats and so on, the need for those. Some of us are concerned with regard to what would be needed for redesign on that when we look at the lower deck. Are you saying that there is a technology that would allow you to use ejection seats in the lower deck of the craft?

General STAFFORD. Mr. Walker, in my statement I said that it is certainly feasible with the type of technology we have for egress systems to have five people on the upper deck.

Now, the lower deck is a whole different situation and I just have not addressed that. What you have to then look at, sir, is, Do you need more than five people on a mission?

Mr. WALKER. Well, we really are getting in then to some questions about policy. If what we are saying is we would have to fly everyone on the upper deck, that you would limit your crew size substantially, it gets into questions of policy on space station then, on people that you would be—for instance, hauling to orbit on space station. You get into questions of people who are carrying out civilian missions, such as electrophoresis experiments, and a lot of that which are primarily the people you fly on your lower deck, and particularly for long duration flights there might be a need for more people.

In other words, we really will, if we decide to go that direction, we really will make more than simply a policy decision with regard to ejection seats as soon as you have limited yourself to the upper deck. You will make some key policy decisions as to what we are capable of doing in space in the next decade; isn't that true?

General STAFFORD. I guess that is true. I am going to have to defer to some of my colleagues who are more current. There are two large openings now from the lower to the upper deck and you

could possibly sequence some type of Yankee escape system out of that, but I know there are studies going on and I would defer to the study.

I made a positive statement, sir, at least five people can be effectively egressed out of that upper deck.

Mr. WALKER. OK. The idea of perhaps even having ejection seats for the lower deck is something that is being studied? Is that what the understanding is, Colonel Hartsfield?

Colonel HARTSFIELD. Yes. Part of the study that is going on now is to look at what you do with the middeck, how you get people out. They are looking at bailout systems for the middeck, as well as Yankee type extraction systems.

Mr. WALKER. Just like from my own perspective, it would be good to have an opinion from this group, since you span the space program all the way from Deke, with the Mercury 7 Program, and on up to the present time. Do any of you have an opinion as to the relative safety of space flight even given all the problems we have with *Challenger*, the relative safety aboard a space shuttle as compared to the early days of the Space Program, and as we progressed?

Major SLAYTON. I can give you one very precise data point. The Atlas, when we committed to fly it in the Mercury Program, had a probability of success of 0.8 which is one failure out of every five flights.

We only flew four, so we didn't test that. The shuttle, on the other hand, we are dealing with a level of 0.999 probability, or something in that ballpark, so I think that is the relative magnitude that we have come in terms of safety since 1959. But don't let me mislead you into thinking that it is still 100 percent safe. There will never be 100 percent safe vehicles.

Mr. WALKER. I think that is clearly the message that has to come through in everything that we do with the program. We have to understand that it is a risky business and is going to continue to be a risky business for as long as any of us can see out into the future.

But I think that it is also important, given some of the hard-hitting criticism that is just finally now being impacted with regard to the program that has had this failure, that we have made progress, it seems to me, in resolving some of the safety issues and have made it a somewhat less risky business for the future and hopefully are going to use what we learn in these hearings to continue to move in that direction.

General Stafford.

General STAFFORD. Mr. Walker, Dr. Lovelace, the outgoing and Acting Administrator, when the administrations changed, asked me to be on a safety review panel that included George Lowell, Les Hawkins, Bob Gilruth, to give him a feeling about launching the first shuttle that John and Crip flew on and then later on Jim Bakes and Chris Craft asked to be on another panel. Basically, by and large, it comes out that 85 percent of your risk is on launch.

The other 15 percent is mostly reentry because space by itself is a fairly benign environment but the main thing if you can protect for most of that launch space going out you have covered most of the items. But as Deke pointed out, the Atlas was not a very reli-

able vehicle, but they did have a launch space system that had the most reliability. We also did the same in Apollo.

We had some ejection seats and, thank God, we never used them. We came close, I think, one time, maybe twice. But in this case under the high risk area, which is your boost phase going out, unless you can get back to the landing site, you have nothing. As pointed out in Paul White's testimony to the Commission and verified, if you have to ditch the orbiter in water, it is probably going to break up and the same thing on rough terrain.

Mr. WALGREN. Well, of the additional 15 percent, I assume that a large portion of that, the risk involved is in the landing, too.

It is not unlike flight itself where takeoff and landing tends to be your two opportunities for the greatest problems.

General STAFFORD. That is correct, sir.

Mr. WALGREN. One other question a colleague of mine said he would like to ask and had to leave.

That is on the question of the SRB's at the present time. Is there any opinion among the group on two questions—first of all, on whether or not we ought to go to second sourcing for purposes of SRB's; and second, whether or not the nonsegmented booster is a better idea than sticking with the present segmented units?

Anybody have an opinion?

Commander GIBSON. Mr. Congressman, on both of those items the nonsegmented boosters, that is a proposal that is being looked at and has been looked at to some degree. We aren't very deeply into it yet. The redesign team is primarily right now looking at utilizing the existing hardware, seeing if we can do that, seeing if we can come up with a design that is usable and accomplishes all the recommendations that the presidential commission made.

But they are not very heavily looking at the unsegmented booster right now. I assume you mean the one that is poured in one piece.

Mr. WALGREN. Right.

Commander GIBSON. They are not looking at that one heavily now. That one has a lot of GSE ground support equipment concerns. It has some shipping concerns and things such as that. The redesign team, which is at Marshall, of course, has not really been chartered to look at that particular design heavily.

General STAFFORD.

General STAFFORD. Well, there are two areas. One is just in general competition and procurement. I know in the Air Force, once we decided to put pressure on Pratt & Whitney for a second fighter engine, General Electric engine, I was one of the two people that started that whole program.

Eventually, Pratt & Whitney's reliability went up a whole lot and their costs came down a lot. So, just from a basic procurement standpoint, I think a second source is definitely good.

With respect to the monolithic case, yes, there is no doubt there is probably GSE efforts on it, but as I pointed out, the fewer connections you have whether it is electrical or hydraulic, tends to be simpler.

Most of our ballistics missiles, the way we have had reliability is the only seals we have had in that is just at the top for the igniter and down at the nozzle.

Mr. WALGREN. I tend to agree with you in terms of competition. I do think it improves things.

The only question that I hear raised about the question of second sourcing here, though, if, in fact, you are going to go to a more unified safety structure, if you are going to improve your quality assurance program and have greater quality assurance out of NASA alone, it does stretch your resources then in order to provide quality assurance and safety inspection at two sources for your SRB's rather than just one.

Anybody see that as a problem?

General McDivitt.

General McDivitt. I will not answer as an astronaut but try sort of as somebody from the aerospace industry. It would be costly to facilitate. Somebody would have to pay for that. If you are going to build exactly the same design, that is one issue. If you are going to build two different designs, that is something else. If you have a competition between two distinctively different designs and pick a single source, then that is another issue.

I think you really have to look at what the objective is. I leave that to you, Mr. Congressman.

Mr. WALGREN. Thank you.

Thank you, Mr. Chairman.

Mr. ROE. I thank the gentleman.

I am going to call on Mr. Mineta next, but I want to start a little different course of events here for our members and for you folks.

We had not planned on getting into too much really broad-based policy. That is going to be following on our next step.

However, if you have listened to your own testimony you have brought up a number of points that are very important.

We have talked about many of the safety factors. We talked about the problems of the landing gear. We talked about an escape methodology and half a dozen other things that are things that could be done and could be done really right now.

I think that is a fair commentary to make and should be made.

In fact, I think somebody said we shouldn't fly unless we get that done, so we know that should be done.

The second point, I think we ought to clarify for the record the people of the country, and a lot of Members of Congress, think that we have three identically the same orbiters so as to say on the shelf now, and that is not accurate.

Am I correct on that, that the capability of the three remaining orbiters are not the same?

Captain Young, is that correct or not correct?

Captain YOUNG. *Columbia*, the first one built, has about, it seems—I can't remember the exact numbers—about 6,000 pounds of additional scar weight due to the development of flight instrumentation that was carried on the first flight, but the performance capabilities, except for that—sea-weight—of all the orbiters, are pretty much the same.

Although the configurations are different in places, we are standardizing a lot of that during the stand-down, and I think the performance capabilities of all three shuttles so far as anybody can tell is, you know, as far as a casual observer, is pretty much identical.

Mr. NELSON. May I follow that just with one comment?

Mr. ROE. Of course.

Mr. NELSON. That is following on General Stafford's comment.

Since much to do has been made out of the White House about whether or not the shuttle is old technology, I would suggest, Mr. Chairman, that we get these guys, who are the experts in flight, to tell us whether or not they think the space shuttle is old technology.

Mr. ROE. That is where I am leading. The matter before the Congress, as I see it to be decided, is many matters, but it boils down to two things.

First of all, there is no debate that we should be in space as quickly as possible, because the safety of the country depends upon it.

It is not a Buck Rogers thing at all. That is not the issue.

Anybody who feels otherwise just doesn't understand the order of magnitude involved. I think that is No. 1.

The question is, How to do that with the safety factors involved? There is a major debate taking place: Should we have a balanced fleet, manned, unmanned?

I think that has already been decided. The answer is yes to that. I think anybody with reason would understand that.

Now, the question remains, how long and what do we do about that shuttle?

The point that the gentleman from Florida was just making which I want to elucidate on, is one, the question comes up of the level of technology involved.

You mentioned it yourselves when you spoke a little bit about redoing the—computerizing the simulators and so forth.

Do you recall that issue?

So, you are saying that yourselves, that there is technology that is 10 years ago. We ought to be on with it. Let's get it going. What are we waiting for?

You see where I am coming from?

But the issue then comes back to priorities and that America should be doing and expending and allocating the resources to do this with, because allocation of the resources are absolutely critical at adequate levels if you are going to meet any of the kind of demands that have been placed in this whole system as we see it today.

We sit with a number of satellites, in effect, that have been designed specifically to go on the shuttle.

Now, if you don't fly the shuttles we have got hundreds of millions of dollars of satellites sitting someplace around that we can't use at this point.

They have either got to be reconfigured to go on an unmanned rocket or we have just got to sit and wait until we get back in.

So, we are sitting on, would you say, hundreds of millions of dollars' worth of—at least. OK. And the leadership of America is really severely questioned at this point as to these decisions we are about to make, both from the White House point of view and from the Congress itself.

So, in my judgment we have a short-range problem as to how quickly we can get the existing fleet back flying and then, the

longer range problem which we will get into in further hearings, which is the long-range policy decisions: Do we go to Mars; what do we do?

When you talk about getting the existing fleet up to par and getting the fourth orbiter into production, so to speak, there are a number of safety factors that are important ones, from your testimony and other people's testimony that has come out.

Therefore, there is a retrofit issue involved here. There is time and space. The common denominator is time and money, how we do this.

Then the question is—that is the debate, whether we are going to be flying a year from now or 2 years from now or 3 years from now.

Some place there is a series of decisions that have to be made, money, resources, so forth and so on, but then somebody has got to make the decision and the time element—how much of the safety work do we do that we know how to do?

You understand where I am trying to come from as to when we get back and flying again.

Do you have any—I guess, Captain, you are right up there in the middle of it now. What is your position?

Captain YOUNG. There is nothing in this country with wings on it that flies into or out of orbit that can carry 50,000 or 60,000 pounds up there and bring half of it back and use people in space.

The next time you open your automobile hood on your car and you are looking for 85 horsepower and you see 85,000 horsepower, you are looking at a high pressure fuel turbine in there. Don't press too hard on the accelerator; you will end up on the moon.

There is a lot of things in the space shuttle that are sort of old technology. We are talking about in later days putting in new computers because the technology is the late 1970's and we know we can build a computer with half the weight and twice the memory and twice the speed and use those new computers and new inertial systems and new electronics and new avionics.

I thought when we started all this that the space shuttle of the late 1970's would be a totally different machine from an avionic standpoint in the 1990's.

You are talking about in the future for the Space Shuttle Program with these very lightweight tiles on it that reenters and spends 20 minutes in temperature in excess of 2,000 degrees and it doesn't suffer any damage and lands reasonably where you want it to.

There is no other machine like it in the world.

So I think in terms of what it does, it is the most advanced technical system in the world. There are places where it suffers from old technology and we are trying to fix a lot of those areas.

In terms of going to totally new technology, as Tom was talking about, the aerospace plane and the other mechanisms, they are very good technical projects and very different ones. Knowing what I know about engines and knowing about heat protection, I think that the aerospace plane is a really good technical program, but it is a long way off. It is really tough and if we could get an aerospace plane in a couple or 3 years that would fly into orbit and carry 60,000 pounds up there and come back and land on a runway and

take off horizontally, that would be the way to go. But as Tom says, it is a long way off.

I think the idea of sticking with the space shuttle and doing as much as we can to advance it during the standdown time, which was being done, is the way for the country to go in the long run. I am not saying that just because I fly it. I just don't see any alternative that is reasonable to get done by 2 or 3 years from now.

Mr. ROE. Put on your negative hat. If Congress is going to ask this specific question—they are asking it and so are the American people—they are asking this one question: Why should we build the fourth orbiter? Why should we not go to advanced technology? That is what the American people are saying.

Why, in your role, in all of your roles, for that matter, both historically, previously and now, why should Congress spend \$3.2 billion or thereabouts to build a fourth orbiter and not take some other route at this point?

Captain YOUNG. Because the kind of thing that you want to do in the next 3 or 4 years with a new orbiter you are not going to be able to do with new technology in 10 years. It is about as simple as that. That is a lot of programs coming down the road that need access to space and the space shuttle orbiter gives it to us, and it gives it to us rapidly, more rapidly than those other kinds of things will do.

I wish I could say it was the other way around but it is not to be. It is really hard to go into a new program, build, for example, an ELV rapidly and get it up in the air in a year or two. It is tough.

Mr. WALKER. Mr. Chairman, if you would yield for a moment?

Mr. ROE. Sure. Just 1 second.

What I am trying to nail down, and it is so hard to get anybody to answer this—of the 3 weeks of hearing, I want to get on the record loud and clear, hey America, the reason that we have to do it is because of this reason. You are starting to answer it but people are timid. If we are going to hold—I will yield in 1 second—if we are going to hold our leadership role and that isn't the total answer, if we are going to hold our leadership role, if we are going to talk about the security of the Nation, then the only option we have before us is to do something. What is that option?

Pardon my enthusiasm but I am trying to get that loud and clear on the record somehow.

The gentleman from Pennsylvania.

Mr. WALKER. I wanted to point out, I think of us asking the question about the technology though I am not necessarily asking the question exactly the way you have posed it. The question is whether or not you need to use taxpayers resources to build a fourth orbiter or whether or not there are some other resources that can be used in order to pay for the fourth orbiter and you know, there may be a question as to whether or not you ought to finance it through other means rather than taxpayers dollars so that the taxpayers dollars can be reserved to go onto the next higher technology level such as the aerospace plane.

Mr. ROE. I have no objection to that at all. However we get the money I think that becomes almost—I don't mean it unkindly, it is very important, but the first and foremost point before us is why and when? Why should we have to do this? Many people have said

to me why are you people going to spend \$3.2 billion to do it? They have got three of them. Three ought to be plenty to do this job.

General STAFFORD. Perhaps, sir, I did not make my point clear when I discussed about the launch rates and resources. In my evaluation three just will not do the job supporting SDI, which needs certain manned missions, and space stations, which you need that to put it up. When you get down to three, with any problems at all, it just will not support the national means. That includes a lot of expendable launch vehicles, too.

Mr. ROE. Isn't the general saying that from as far as the program is concerned now, as we presently see it—never mind that the Soviets are talking about landing on Mars in 1992 in a report that they just printed—we are saying that in order to first of all, to launch the satellites that we have on the shelf both weatherization or whatever we are going there, the whole list of them, we have got to do something or wait. We are coming back and saying in the second point, as I see it, along the line, whether we are going to commercialize or anything else, we still have to deal with this technology. Isn't it also true that the space station itself sits and waits; and fourth—

Mr. NELSON. Would you yield?

Mr. ROE. Let's take the gentleman from Texas first.

Mr. ANDREWS. General Stafford, I want to commend your remarks. We have had weeks and weeks of testimony before the *Challenger* tragedy and certainly many afterward, about the administration's program in space, about the military's proposals for space, about NASA's proposals. We have heard many private citizens come in and talk about their efforts, what they want to do in outer space.

It is clear to this committee that without a fourth orbiter our space program will be severely hampered in our lifetime. There is just no question, as you stated, that we simply can't do all the things we want to do in this generation without orbiters. We can build a space station but we can't fully utilize that station without four. We can have space commercialization and try to compete with the French and the Soviets, but we can't do it as well as we need to without four.

The holdup right now is not this committee and not the Congress, but the White House. As long as we're in this time frame of indecisiveness we really run a risk of not being able to have four.

Mr. ROE. I just want to correct on point. If the gentleman would understand, I know you feel as enthusiastic as I do. I don't think we are prepared really to say who doesn't want to do what. I don't think we should be—we are not leveling blame on any individual for the accident. I don't think we should be leveling blame yet on decisionmaking. That doesn't mean I totally disagree with the gentleman, but—

Mr. ANDREWS. If the chairman would yield.

Mr. ROE. Let me just finish and then I will yield and give you all the time you want. What I want to nail down today, and intend to nail down, if it is the last damn thing I do in these hearings, is to have somebody come in and lay down what do we do positively? This isn't a NASA bashing committee. That is not our intent. Our

intent is to lay the fact out before the American people so they can make a decision.

I think the gentleman has eloquently portrayed it. I don't know what has happened to me today. It won't all come out at once. The point we would like to get generally from you folks, who have been pioneers, who are really running the show as far as the orbiter is involved, itself, and so forth, is that a general way we should be going.

Go ahead, General.

General McDivitt. The Apollo Program has been used as an example of how a good program ought to be run. The technology we used in the Apollo Program by the time we started landing on the Moon and for the years afterward that it flew, was not new technology a la 1970, but it was technology that was used when we designed it early in the 1960's. When I was running the program office I had a number of signs put on the walls of the program office that said the better is the enemy of the good. The meaning behind that was if we have a piece of equipment that's good enough to go to the Moon, let's not keep making it better and better and better, because if we do, we will never go to the Moon, we will just keep making it better.

If I had a radio that would transmit 350 to 400,000 miles adequately, the Moon only being 250,000 miles away, that was great. We should go ahead and use that. There were a lot of radio engineers who wanted to have one that went 10 million, 2 billion, or whatever and if we had done that, we would never have gotten to the Moon on time.

One of the major advantages of the Apollo programs was it worked against a time constraint. We were going to be on the Moon by 1970. That forced us into making decisions that got us someplace instead of optimizing things better and better and better.

As John so eloquently said, the shuttle does the job. It may need some update in avionics or some of the other things, and I heartily support that, but to start all over on a new airframe and a whole new set of techniques, we are going to see the space program not a year or two behind, as this tragedy probably will cause, but a decade behind because we are going to have to start all over again.

I think if we are going to fly in space, we ought to build some more shuttles and get on with it.

Mr. ROE. Is there anybody on the panel—and then I will defer to the gentleman from California—is there anybody on the panel that disagrees that we should build a fourth orbiter?

General McDivitt. Mr. Chairman, just a short time ago, we tried to decide whether we ought to have a fifth one.

Mr. ROE. I remember.

Major SLAYTON. Mr. Chairman, I am not disagreeing. I would just propose to you the preliminary data I am familiar with, being an outsider, would tell you that an orbiter realistically will not fly over three or four flights a year, any one of them. And so if you say I am now going to build a space station and if you look at the traffic models people have related to the space station alone, the requirements, a three orbiter fleet will not support a space station.

So to me, the conclusion is very obvious. If we are serious about doing the space station in this country, you can't do it with a three orbiter fleet. You are going to have to have four because that is a program that requires an orbiter.

There are a number of payloads sitting out there that do not have to go on an orbiter. They can be done equally well by other vehicles and in my opinion, they should be done by other vehicles and reserve the orbiter for things it alone can do, which are very large payloads that require manned interface and require recovery.

Mr. ROE. Is it reasonable to say—and then Mr. Mineta, you are next—is it reasonable to say, make this observation, that if we neglect going ahead with the fourth orbiter at this point, in view of the posture we have discussed and we were to design and redesign under “so-called advanced technology,” that we could lose as much as 10 years?

Major SLAYTON. I wouldn't even want to hazard a guess, but it is significant, obviously.

Mr. ROE. The gentleman from New York, Mr. Scheuer.

Mr. SCHEUER. Can I repeat the question you posed before we broke for lunch about the increasing rate of astronauts from the program. They did answer that?

I will go ahead. Can I ask you, continuing on this policy line, what are your 25-to-50-year goals for our space program? What national interest should we be trying to meet in the field of national security, in the field of economic development, in the field of advancing scientific knowledge for health, education, whatever purposes, and considering what those long term goals are, what is the best vehicle, what is the best system for us to be shooting for over the next quarter or half of a century to achieve those goals?

That is a very nebulous question, but we almost have to have some long range goals up here before we can solve the medium and short range problems. If we don't have our Iowa star out there, we are sort of making short term questions without a long term reference point, and that is dangerous.

Major SLAYTON. Well, sir, if I might take a shot at it, and other guys can follow up. In my opinion, the National Space Commission, which is run by Dr. Payne, and I have not reviewed that in total, but the summary of that appears to me to basically answer your question. I think they have tried very hard to lay down a 25-year plan and a 50-year plan and do exactly what you are proposing, to lay out a logical sequence, how do we get from where we are to where we think we want to be in that time frame?

I personally think it is a very well done document. I am sure, like all others, you can find things we would like to see changed. I will see what everybody thinks about it. In my opinion, it is a very good road map for precisely what you are referring to.

Colonel HARTSFIELD. I think I would agree with Deke on that. I haven't read the report in detail, but I did scan through it and it looks like it has done a very good job of laying out where we should be going. In my mind, these long term plans set the tenor of the research you are going to do to assure your preeminence in space. Now, that should be our goal.

In the near term, getting back to the other question, what we should be doing right now, I agree with everybody else. I don't

think that we can support what we have set out in there to do with three orbiters. If we really want to keep our position and move forward we are going to need that fourth orbiter. There are a lot of things out there that are going to be done that depend on the orbiter. That is taking the men and materials into space to do some basic research even before the shuttle comes along.

For example, the Europeans have a very well organized program of materials processing in space, and you know, we are seeing the lead taken away from us and that disturbs me very much. Our country ought to be the leader in this field. We ought to be providing the future initiatives and technologies and inviting the experimenters to come and do this work and let us insure our preeminence in space. And I think we need another orbiter to do that.

Getting back to the technology question of the orbiter, I couldn't agree with John more. We have a magnificent flying machine here. I have flown three different ones and they are all—getting back to the first question—they all fly about alike. I don't detect any difference in them. They are all wonderful machines. The basic airframe is good. I would like to make an analogy to the 38's we fly. They are 20-something years old now but we are still flying them. They are good machines.

There are C-47's that were build back before World War II still flying around. Sure, progress is being made. There is new technology. If you start right now, obviously you won't build a C-47, but it doesn't mean it still isn't a good machine for what it is being used for now, and you update the things you have to update. I think we need that kind of update with the orbiter as well, to make changes where the technology advances.

I also agree with Jim down there, better is the enemy of good. It can get you in a lot of trouble. You have got to be careful, but obviously technology does advance products and the companies that make them are no longer in business that provided the original equipment. So you have to do a little improvising, but it doesn't mean it can't be done and can't be done at a reasonable cost.

Mr. ANDREWS. Would you yield?

Mr. SCHEUER. Of course.

Mr. ANDREWS. I would like to go back, just to follow up on your comments, I don't think any of us are pointing fingers at anybody about the lack of a commitment on the fourth orbiter. But the truth is, we can have hearing after hearing, and that is what we have had. We can hear testimony days upon days of testimony, which we have had, about the need for the fourth orbiter.

What is so critical right now is we have got this window of time to strike, to start the commitment and set the agenda. No question about it, there is one thing the House of Representatives cannot do and that is set a space agenda. We can work on policy and work around the edges of what that agenda should be in terms of our budget, but the decision has to come from the administration on whether we have another orbiter or not. We can debate on how it should be paid for and we will, but until we have that decision made by the White House, then this program is going to linger and we are losing valuable time. That was my only point.

I think it is so critical that we urge the White House to make a decision about the orbiter and let's get on with the debate of how we pay for it.

Thank you.

Mr. SCHEUER. May I continue, Mr. Chairman?

Mr. ROE. Mr. Scheuer, the gentleman from New York.

Mr. SCHEUER. We have talked about the inordinate cost of the long term space program going up into tens if not hundreds—well hundreds of billions of dollars I suppose, and also the fact that we are not first in space and other countries, particularly the Soviets, according to the British, have a significant advantage on us. They are ahead in the technology race.

Major Slayton, you have had some hands-on experience working with the Soviets in the Soyuz mission. You must have a feeling in your blood and guts and in your central nervous system of what it is like to work with the Soviets in this ultrahigh-technology effort. Would you and any of the others who are interested in enhancing, think it might be worth your while to think about a joint effort, let's say, to get to Mars, or to achieve any of these long term 25, 50 goals? A joint effort perhaps with the Soviets, perhaps with the Soviets and the European consortium, perhaps with the Soviets and the European consortium and the Japanese on several grounds:

First, that we ought to divide up the costs. No country really can afford to do it all and do it right. If costs are absolutely stupendous.

Second of all, no country has a lock on technology and this is a case where the whole is certainly equal to the sum of its parts, and maybe is greater than the sum of the parts. Maybe the interaction of the scientists would achieve breakthroughs that no one of them separate could make. So you have a cost/benefit.

Then perhaps we might find that in working together we wouldn't, each of us, have to worry so much separately about the national security implications of being first in space, of getting there firstest with the mostest. We might decide that space is for all of us and that it ought to be a serene place and not a warlike place.

And fourth, from the point of view of science and technology, applications of what we learn to earth problems, the incredible advances in medical technology, in telecommunications, that we have already used for health and for education here on Earth as a result of space research, well, we could share that and that might be part of the glue that binds us together.

I see tremendous possibilities in a global effort to achieve these 25 to 50-year goals in space, and I know that this centrifugal force is tearing us apart and scatterizing, destroying joint efforts that are great, are there enough centripital forces drawing us to the center to counteract these centrifugal forces that are scatterizing us to the four winds?

Is it a desirable thing for the global competitors, based on enlightened self-interest and a feasible possibility, you have had the hands-on experience, and you must have a feeling in your central nervous system that this is doable, or are they the kind of people you might not want to make a commitment to work with over a quarter of a century?

Major SLAYTON. I am in favor of it. Tom and I worked with the Russians for about 3 or 4 years in preparation for the Apollo-Soyuz, and Tom was the commander of that crew.

In 1975, we recommended publicly at that time that we thought it would be a great idea to have a joint mission with the Russians, with the Mars exploration thing. We were over there last fall with Congressman Nelson and his committee, and pursued those same kinds of discussions with him, and I think we received a very favorable reception over there, in general.

They were hung up on making a trade for Star Wars, but other than that, they thought it was a good idea. Tom and I are going back there again next week, to get a little dialog with them, so my personal opinion is, you have got in a number of excellent points that are all in favor of a joint operation in the future, and I am a firm believer in that.

We take a small percentage of the money spent on defense budgets and plow it into joint missions, doing something constructive like that, it will be to everybody's benefit.

Mr. SCHEUER. General Stafford, you were the commander of that joint mission with the Soviets. Can we hear your views?

General STAFFORD. A lot can be done in a very positive sense. I will defer to the idea of taking it out of defense budget, Zeke's idea. A lot can be done. We were very well received. We accomplished a lot over there, and I am looking forward to going back over there with Deke.

When you look at the magnitude of a Mars mission, and I have a lot of experience working in joint projects, NATO people, Air Force, R&D, our experience was this, joint production was fine.

Joint R&D was extremely difficult, but on the other hand, like Apollo-Soyuz, each had their own vehicle development and developed a minor interface, it worked very well.

Mr. SCHEUER. Can you take a look at the whole panoply of R&D and divvy it up and assign big hunks of it, one hunk to the Europeans, one hunk to the Russians, one to us?

General STAFFORD. An entity like ESA would take and develop that with the Japanese, that is fine, and worry about the interface, assuming it meets a lot of specifications, but to try to integrate R&D across national boundaries has been a very difficult thing.

It is a good idea to go forward, but you have to use some judicial judgment in how you do go forward.

Major SLAYTON. The forcing function of having to do that has a whole lot of side benefits from a national standpoint.

Mr. SCHEUER. What would be the best way to get that process going among these four groups, the Russians, Japanese, the West German consortium, ourselves, perhaps the Canadians, five groups, what would be the best way of getting some collective thinking going as to how, A, the process of setting long-term goals could be established, and B, how the question of the enormously complicated and esoteric research could be established to design something and then finally, how the production responsibilities could be allocated?

What would be the mechanism by which these five groups would be thinking through these problems?

Major SLAYTON. Let me take one shot at it. In my opinion, the first step has to be to get a dialogue going with the Russians, and

today, you can't do that, because as I indicated earlier, they are holding everything we were proposing to them in that time frame hostage to Star Wars, so until you can break that logjam and get a dialogue going, you can't go anywhere with it, but presuming you get over that hump, dealing with those guys is not like talking to the Canadians, but we certainly know how to do it.

Once you get everybody in the same room, get around and jointly discuss goals from a technical point of view, instead of political. Obviously, the political ends up being the prime driver in the long haul.

Mr. SCHEUER. I know my time is up, Mr. Chairman, but as a parenthetical footnote, one of the great payoffs of such a collective effort would be that no one of the parties involved would have to worry about the other guy having Star Wars, because they would all have Star Wars and space would be a collective thing for all mankind, and not the property of any one nation that would threaten others.

However, you might describe the threat as reasonable or unreasonable, that would be one of the major payoffs.

Mr. ROE. If the gentleman would yield now to the distinguished gentleman from Florida, Mr. Nelson.

Mr. NELSON. Thank you, Mr. Chairman. This is a little sideline on this issue, but Tom and Deke are going over there again to Moscow, a follow-up to the reunion that we had when they had the 10-year reunion here in Washington, and Tom and Deke went over with our committee, had this marvelous reunion with the kosmonauts and their families, and it was on that occasion we saw things that Americans have not seen in 10 years, we went to Star City, their mission control, updated mission control, and so forth.

I throw this in because Tom told me this 2 days ago. Vance Brand was not able to go with us because his wife was having a baby, and he was a third member of the Apollo team, and in the Apollo-Soyuz dock-up.

The U.S. State Department is objecting to Vance Brand going to Moscow next week with Deke and Tom, because he is an active astronaut. I have asked John about this, and he doesn't see any particular problem.

Captain YOUNG. I said I don't know anything about it.

Mr. NELSON. OK, do you have a particular problem with it?

Captain YOUNG. I don't know anything about it. I would like to know what the State Department problem is, but I don't have any idea.

Mr. NELSON. Let's use this as a forum to try to get the message to the State Department which I have spoken to one State Department person, and we have called the State Department, let's see if we can't get Vance Brand on the way to pursue what seems to be a very promising area of discussion, and we might say that since the Summit in Geneva, there have been some positive signs on the question of space cooperation coming forth from the Soviets, and let's see if we can get that accomplished.

John, that was an accurate response by you. I didn't mean to put you on the spot there. I know you don't know anything about it, and maybe that says something about the system, too, that you

don't know anything about it, that it is the State Department doing that.

Mr. SCHEUER. Will my colleague yield?

Mr. NELSON. Certainly

Mr. SCHEUER. It seems to me that somebody over at the State Department is an avid reader of Mr. LeCarre, and some of the other writers in this genre of international spy mystery thrillers.

I remember having read something about snatches that were made, people impersonating other people, and if I were in the State Department and I wanted to conjure up a worst case theory, I could think of a possible scenario whereby it might be dangerous for us to send an astronaut over there who was active, privy to the most top secret, state of the art events going on here, and maybe they could have a mirror image of each one of the astronauts ready to snatch and replace, but unless you engage in that kind of fantasy, and in that kind of hysteria, I would be hard put to think of a legitimate reason for not sending a tough, sophisticated professional astronaut over there in the company of his colleagues and other American professionals to reason a bit, to rationalize a bit with their Russian equals, and I certainly would echo that feeling, Mr. Chairman, that this committee and you surely have a role in sitting down with the State Department, finding out what are their concerns, above and beyond the John LeCarre genre.

Mr. ROE. It is amazing they don't have any objection to sending Members of Congress.

Mr. SCHEUER. I would feel a little bit offended, to think that we would be—

Mr. ROE. I don't think you could be cloned.

Mr. Nelson.

Mr. NELSON. First of all, the issue we are discussing about the question of what is the appropriate technology for a replacement orbiter, the real question is how are we going to have American assured access to space for the duration of this century until such a new technology, aerospace plane, if it proves out, is operational, which is not until the next century, and so it seems that we have heard ample testimony here, despite the fact that you get frustrated from time to time, because the explanations, Mr. Chairman, are technical and we need it in black and white, that says we need it for this reason, and basically that reason is, assured access to space and in this particular case, this is our vehicle for manned access to space.

Now the question of the funding, we are talking about not \$3 billion or \$3.2, we are talking about around \$1.82 billion for the orbiter. The \$2.8 billion figure for a replacement cost came when you added all the things that were in *Challenger* and lost in the explosion which included the TDRSS satellite cradle, the manipulator arm, the space suits, upper stage, et cetera, so you are looking at a cost more of around \$2 billion for a replacement of a specific orbiter, and as we talk about this question of assured access, let us hasten to remember that the Soviets now have the third generation of space station up there which gives them that 24-hour presence 7 days a week for things that we look forward to, such as material processing which we can only get in snatches and bits now as we take a shuttle mission up, and then that question of the possibility

of new materials and new drugs, et cetera, all then folds into the question of the space station, and our ability to assemble it, to re-supply it, and then do all the other things, science as well as national security things, that have to go on a manned vehicle as a shuttle.

You come then, after all of those considerations, let the record show clearly, you come down to the bottom line for the sake of assured access to space you have to have a replacement for *Challenger*, and I hope that the record will reflect that and I thank you, Mr. Chairman, for raising that issue so we could have the record reflect it from this very distinguished and very articulate panel that we have before the committee today.

Thank you, Mr. Chairman.

Mr. ROE. I thank the gentleman from Florida for his eloquent remarks. We want to thank you—the distinguished gentleman from Pennsylvania.

Mr. WALKER. Mr. Chairman. We did have quite a discussion here a moment about sending Vance Brand to the Soviet Union. I think also we ought to ask some questions, but it does occur to this gentleman that far more than just spy novels, there might be some reason the State Department might have about sending an active astronaut versus two people who are in policy posts, and also at a time when our space program is in some trouble, that having an active astronaut in the Soviet Union might give them some propaganda value that having two former astronauts would not necessarily give them.

There may be some legitimate concerns that the State Department would have and I am willing to explore it, but suggest all they are doing is suggesting the spy novel scenarios, and so on, we maybe ought to ask the question rather than doing that kind of speculation here.

Thank you, Mr. Chairman.

Mr. ROE. I thank the gentleman from Pennsylvania. I want to thank you all for being with us and having the patience for sitting through what we are trying to rehash. I think you represent to America the people who really have been specially selected to fly the spacecraft, and that is what I want to call them, spacecrafts, so is what they are so the credibility of having you here today and making the observations you made, and of course, this will be photographed and sent throughout the Nation and what we are trying to achieve, what we are trying to do on this committee is to get the three branches, the three legs we talked about together.

You started now today on the policy issues. We feel that at least as far as this member is concerned, and I am sure most of the others, pretty well exhausted the technology relating specifically to the accident. We think we have done that. I think we have some additional work to do, as far as management issues are concerned, we need a little bit more work on that, and to get into the policy end of it, but what you have contributed today above and beyond the obvious excellent testimony is almost unanimous observation, and you come from different domains, if you like, at the particular stages at the moment, in order for America to move ahead and move ahead with dispatch, and to recapture or sustain our leadership, we have to go ahead with the fourth orbiter at least, and that

is one of the most important points that is emerging, and emerging from a credible group of witnesses.

Did you say something?

So having said that, we want to thank you for your patience, intelligence you have contributed greatly to the committee's deliberations, and if we need you again on some of the policy issues as they emerge, we will be calling you back.

The committee will stand adjourned, and we are working out schedules that we will be working on for when we return after July 4.

Thank you very much.

[Whereupon, at 3:25 p.m., the committee was adjourned.]

APPENDICES

JUNE 11 HEARING - APPENDIX #1

DON FUQUA, Florida, CHAIRMAN

ROBERT A. ROE, New Jersey
GEORGE E. BROWN, JR., California
JAMES H. SCHLEIER, New York
MARLYN LLOYD, Tennessee
TIMOTHY E. WIRTH, Colorado
DUDU WALDRIN, Pennsylvania
DAN GUCKENMAN, Kansas
ROBERT A. YOUNG, Missouri
HAROLD L. VOLKMER, Missouri
BILL NELSON, Florida
STAN LUNDE, New York
RALPH M. HALL, Texas
DAVE MCCURDY, Oklahoma
NORMAN Y. MINETA, California
MICHAEL A. ANDREWS, Texas
TIM VALENTE, North Carolina
HARRY B. NEED, Nevada
ROBERT G. TORRICELLI, New Jersey
FREDERICK C. BOUCHER, Virginia
TERRY BRUCE, Illinois
RICHARD W. STALLINS, Idaho
BART GORDON, Tennessee
JAMES A. TRAPICANT, JR., Ohio

U.S. HOUSE OF REPRESENTATIVES
COMMITTEE ON SCIENCE AND TECHNOLOGY
SUITE 2321 RAYBURN HOUSE OFFICE BUILDING
WASHINGTON, DC 20515
(202) 225-8371

July 15, 1986

MANUEL Lujan, Jr., New Mexico
ROBERT E. WALKER, Pennsylvania
F. JAMES SENSENBRENNER, JR., Wisconsin
CLAUDINE SCHNEIDER, Rhode Island
SHERWOOD L. BODENLERT, New York
TOM LEVY, Florida
CON RITTER, Pennsylvania
SID W. MORRISON, Washington
RON MACLACHLAN, California
JAN MEYERS, Kansas
ROBERT C. SMITH, New Hampshire
PAUL B. HENRY, Michigan
HARRIS W. FAWCETT, Illinois
WILLIAM W. COBEY, JR., North Carolina
JOE BARTON, Texas
D. FRENCH SLAUGHTER, JR., Virginia
DAVID S. MONSON, Utah

HAROLD F. HANSON
Executive Director
ROBERT C. KETCHUM
General Counsel
JOYCE GROSS FRENWALD
Republican Staff Director

64-295

Honorable Robert A. Roe
Committee on Science and Technology
U.S. House of Representatives
Washington, D.C. 20515

Dear Mr. Chairman:

During our June 11, 1986 hearing on the Space Shuttle Challenger accident I referred to four studies that had assessed the risk of failure of the solid fuel rocket booster. As you recall, I mentioned that between 1980 and 1985 NASA and the Air Force commissioned three studies on the odds of a shuttle booster failure. NASA came up with a much more optimistic figure after these studies were completed. At this point, Chairman Fuqua indicated that some question exists as to whether these studies had been commissioned by the Department of the Air Force or NASA. In light of the question raised by Mr. Fuqua, I have prepared the following for inclusion into the record immediately following our colloquy. Your cooperation in this matter is appreciated.

With every warm best wish,

Sincerely,

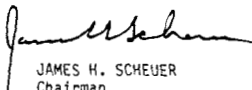

JAMES H. SCHEUER
Chairman
Subcommittee on Natural Resources,
Agriculture Research and Environment

JHS/Sdjs

Attachment

(625)

**COMMITTEE ON SCIENCE AND TECHNOLOGY
U.S. HOUSE OF REPRESENTATIVES
WASHINGTON, D.C. 20515**

July 15, 1986

MEMORANDUM

TO: Robert A. Roe, Chairman

FROM: James H. Scheuer, Chairman
Subcommittee on Natural Resources, Agriculture
Research and Environment

SUBJECT: Reports on probability estimates for space shuttle
failure

During our hearing on June 11, 1986, I questioned the NASA witnesses on three studies predicting the probability of space shuttle failures, including the solid rocket boosters. It was suggested that these studies were in fact commissioned by the Department of Energy. A review of this matter indicates that indeed the studies were commissioned by NASA and the Air Force (except the the fourth report, which was issued by NASA itself). The background is as follows:

1. In 1978 NASA asked the J.H. Wiggins Company to evaluate the safety implications of eliminating the range safety destruct system for the shuttle. (Contract NAS 10-9374). This work involved identifying shuttle failure modes from launch to main engine cutoff (MECO) and quantifying their probability of occurrence. This report was called "Space Shuttle Range Safety Hazards Analysis", Technical Report 81-1329 prepared for NASA Kennedy Space Center, July 1981. This work, which was not released for about 3 years after its completion, was followed by an additional J.H. Wiggins Company analysis that assigned probability numbers to shuttle failure modes from MECO to payload separation (TR No. 79-1359, October 11, 1979).
2. In December 1983 Sierra Energy and Risk Assessment (SERA) issued a report by R. K. Weatherwax and E. W. Colglazier. The report analyzed the Wiggins study and concluded that it seriously understated shuttle risks. SERA was a subcontractor to Teledyne Energy Systems, Inc. under a contract

MEMORANDUM TO
Robert A. Roe, Chairman
July 15, 1986
Page Two

to the Air Force Weapons Laboratory, Air Force Systems Command, Kirtland Air Force Base, NM, as part of their advisory capacity to the DOD representative to the Inter-agency Nuclear Safety Review Panel. (AFWL-TR-83-61) The panel was concerned with the risks of using a liquid hydrogen upper stage, known as Centaur, and a nuclear radioisotope powered interplanetary orbiter such as the Galileo mission to Jupiter. "Review of Shuttle/Centaur Failure Probability Estimates for Space Nuclear Mission Applications."

3. In December 1984 Sandia National Laboratories issued a report examining the two earlier reports. The report had been requested by the Air Force Weapons Laboratory as a continuation of the Air Force's independent evaluation of range safety. The Sandia report was prepared under Contract DE-AC04-76DP000789 for the U.S. Department of Energy at the request of the Air Force Weapons Laboratory. The Sandia report identified some areas in which more justification would improve the Wiggins' reports credibility and traceability. The Sandia report also concluded that SERA did not adequately support their conclusions that current probability estimates could be low by several orders of magnitude. "Review and Evaluation of Wiggins' and SERA's Space Shuttle Range Safety Hazards Reports for the Air Force Weapons Laboratory."
4. In February 15, 1985 NASA's Lyndon B. Johnson Space Center produced "Space Shuttle Data for Planetary Mission Radioisotope Thermoelectric Generator (RTG) Safety Analysis." (JSC 08116) The document analyzed the Galileo and Ulysses Spacecraft missions to be flown on the shuttle. The two planetary probes would use nuclear radioisotope generators for electrical power and Centaur liquid hydrogen fueled boosters to carry them from shuttle orbit into interplanetary space. NASA examined the potential impacts of catastrophic failures on the shuttle and its payload, in part using the J.H. Wiggins analyses to assign probabilities to these failure modes.

JUNE 11 HEARING - APPENDIX #2

Responses to written questions submitted by Chrm. Roe during the June 11, 1986, hearing.

Safety, Reliability, and Quality Assurance

QUESTION 1:

There is concern that NASA makes little distinction between safety engineering, reliability engineering and quality assurance activities at various levels within the Shuttle program. For example, the reporting at the Marshall Space Flight Center for safety, reliability and quality assurance is through the Engineering Directorate.

Do you regard this as appropriate? Should those who control Shuttle design and fabrication activities have authority over those who must certify that these activities are being performed appropriately?

ANSWER 1:

On July 8, 1986, NASA Administrator Dr. James C. Fletcher announced the establishment of the new Office of Safety, Reliability and Quality Assurance (SR&QA). Mr. George A. Rodney was appointed to head the office as Associate Administrator for SR&QA. He will report directly to the Administrator and will have authority throughout the agency. In that capacity he will address the concerns raised in this question. The objectives of the office are to ensure a NASA SR&QA program that monitors equipment status, design validation, problem analysis and system acceptability in agency-wide plans and programs.

The responsibilities of the Associate Administrator will include the oversight of safety, reliability and quality assurance functions related to all NASA activities and programs. In addition, he will be responsible for the direction of reporting and documentation of problems, problem resolution and trends associated with safety. Specific activities are to:

-- Ensure that SR&QA policies, plans, procedures and standards are established, documented, maintained, communicated and implemented.

-- Direct thorough, prompt and accurate investigation, reporting and analysis of all NASA mishaps, incidents and accidents and to ensure resolution of all investigation-related recommendations.

-- Ensure that a fully documented trend analysis program is conducted that includes accurate reporting of anomalies.

-- Ensure that SR&QA issues are fully considered during design reviews, flight readiness reviews, test readiness reviews, operational readiness reviews or equivalent formal reviews which are conducted prior to start up of operations for ground facilities, manned and unmanned launch operations, aircraft flight programs and acceptance testing of experimental facilities

and hardware having significant risk to persons or property.

-- Ensure that field installation SR&QA organizations are staffed with sufficient and qualified professional personnel to ensure accomplishment of assigned tasks.

QUESTION 2:

NASA has made the argument that the maturing of technology in the Shuttle program reduces that need for intensive quality and reliability control. Could you please explain this position?

Were cracks in the SSME's allowed more recently when originally no cracks were permitted? Has the number of inspections been reduced? For example has propellant X-rays been reduced relative to early flights? Is it perhaps time to revisit this issue and find ways and means to increase these activities as we proceed into the next phase of the Shuttle program?

ANSWER 2:

As noted in the answer to question number one, NASA's entire Safety, Reliability and Quality Control program will be reassessed by the recently named Associate Administrator. In response to your specific question about cracks in the SSME's, there are two types that occur and concern us.

1) Cracked Turbine Blades—Various cracks that are known to propagate fast have been and always will be unacceptable. A leading edge crack in a blade is an example of this type of crack. There are other cracks that take 10 to 20 tests to propagate to an unacceptable level. To be able to fly with the potential of these types of cracks, margin testing is performed. In other words, to be able to fly a turbine blade with a potential crack at 10 flights, we will take known cracked blades and test them for 20 flights. The airline industry has long had procedures to fly wings blades, etc. with known cracks, but they, like us, must demonstrate margin.

2) Cracked or Flawed Welds—The SSME has miles of welds and because an unending pursuit has been made to improve the welds and inspections, rarely does a problem weld slip through an inspection. The failure last year of a weld on engine 2308 has brought with it even better inspection techniques. All Class One welds are 100 percent x-rayed and inspected.

In summary, cracks in the SSME are no more tolerated now than they have been in the past. On the contrary, inspections to find cracks have increased in both quality and quantity over the life of the program.

With regard to your question about x-rays of propellant, early flight solid rocket motors were x-rayed. During the operational phase, the aft casting segments and any casting segment experiencing a design change or anomaly have been x-rayed.

QUESTION 3:

If NASA's quality control procedures were functioning throughout the Shuttle program, how is it possible that certain important certification procedures as they related to temperature effects on the SRB joints were improperly performed, and in many cases, not even accomplished, although quality assurance personnel signed documents that indicated that the tests were done?

ANSWER 3:

Early in the program, verification of the SRM to induced temperature requirements was planned through both analysis and test. Eventually, Morton Thiokol certified the joint for induced temperature through analysis only. In retrospect, this was inadequate. Additionally, when questioned by the NASA Data and Design Analysis Task Force during the accident investigation, they stated that the vertical flight environmental requirement had been misinterpreted for a storage requirement. Finally, NASA's acceptance of the certification was based on the specification for the O-ring material. It has an operating range between minus 30 and plus 500 degrees Fahrenheit. The acceptance should have been based on the performance of the entire joint at temperature extremes rather than the specification for this single component.

QUESTION 4:

What sort of certification tests should have been done in order to assure the program management that sufficient data was available to make a meaningful judgment on whether or not the solid rocket motor field joint would perform satisfactorily under the environmental conditions encountered?

ANSWER 4:

The Solid Rocket Motor redesign team is currently involved in a study to answer this question to ensure that the redesigned joint is properly certified to operate throughout the environmental conditions encountered. They will be assisted by an Oversight Committee and the National Research Council (NRC) Panel which includes well-known authorities in the field of propulsion, materials, structures, reliability, and aerospace engineering, as well as experts in related industrial technologies. The Oversight Committee and the NRC Panel will pass judgment on the SRM redesign team's findings.

QUESTION 5:

"How would you confirm that any redesign was an improvement over the present design? That is, what certification tests would be planned to assure that any redesign of the joint would not produce the catastrophic failure experienced by the Challenger?"

ANSWER 5:

The verification plan that is being implemented includes tests on subscale fixtures, full segments, and flight configuration solid

rocket motors. The subscale tests will be conducted on fixtures less than two feet in diameter simulating field joints primarily to evaluate sealing performance using various seal types and materials under wide temperatures and dimensional extremes. Other subscale tests will be conducted on small motors hot fired to evaluate seals, insulation, thermal behavior, etc., with varying tolerances. Full size joints will be tested to evaluate and develop joint environmental protection (temperature and rain) designs and to verify computer models of joint dynamic behavior. Three to five full size segments will be assembled into two shortened motors containing inert propellant. Small igniters will be installed in these shortened motors and fired to produce near identical pressure profiles as experienced during actual SRM ignition. These shortened motor tests will be used to evaluate the joint movement under dynamic conditions and the pressuring hot gas dynamic effect on the insulation gap and joint sealing capability. Appropriate full size segments will be assembled into a structural test article that will be subjected to flight loading conditions. Finally, four full scale motor static hot firings are planned to be tested either horizontally or vertically. All these tests, to be conducted over the SRM operational environment range coupled with detailed extensive analysis, will assure that the redesigned joint will not experience the failure experienced by the Challenger.

QUESTION 6:

"It is our understanding that Marshall has responsibility for reviewing proposals for a monolithic SRB design?"

ANSWER 6:

Yes, that is correct.

QUESTION 6A:

What is the status of these reviews, and what is your present feelings regarding the advisability to proceed into a monolithic design of an SRB?

ANSWER 6A:

MSFC has received an unsolicited proposal from Aerojet. This proposal is currently being assessed by the MSFC Procurement Office to determine the compatibility and acceptability of the proposal with the current procurement regulations. Since a technical and programmatic evaluation of this proposal has not been performed, MSFC is not able to respond to the question on advisability to proceed into a monolithic design of an SRB.

QUESTION 7:

"We understand that the monolithic SRB design would require at least three to four years of development and testing in order to certify its suitability for flights. What is your estimate of costs and schedule to produce a monolithic SRB design?"

ANSWER 7:

Based on historical experience on development of large Solid Rocket Motors (SRM), it is estimated a minimum of four years would be required to design/develop and qualify a monolithic Shuttle SRM. The current Shuttle SRM required approximately six years from initiation of the contract to completion of qualification. There would be some reduction in that time period on the basis of the experience gained during the Shuttle SRM development program assuming the development of a performance identical monolithic SRB design. Using the Shuttle SRM development cost as a basis for projecting the cost of developing a monolithic Shuttle SRM, the estimated cost would be \$500 - \$600 million in real year dollars. This very preliminary estimate is based on taking the Shuttle SRM cost and escalating that cost to the time frame for development of a monolithic Shuttle SRM.

QUESTION 7A:

"What facilities would be required to test such a design and do such facilities exist?"

ANSWER 7A:

A facility with capabilities similar to the current T-24 complex at Morton Thiokol (see Attachment 1, hereto) would be required. The only known existing facility with such capability is the Morton Thiokol facility at Wasatch, Utah. Even this facility would require modification to access the motor into the stand and handle the monolithic design, i.e., new cranes, air bearings, transporter, etc.

CertificationQUESTION 8:

"Prior to the first Space Shuttle Launch, George Hardy (the SRB Project Director) signed a verification statement that all SRB certification requirements had been met by Thiokol. Larry Mulloy (the then current SRB Project Director) signed a similar verification statement before the fifth Space Shuttle flight. On what basis were these verification statements signed?"

ANSWER 8:

The basis for the certification prior to the first flight was:

1) Project experience gained through the day-to-day involvement in the project development and qualification activities; but more importantly, the review and counsel derived from the Design Review and Certification process. This process consists of the Preliminary Requirements Review (PRR), Preliminary Design Review (PDR), Critical Design Review (CDR), and Design Certification Review (DCR). These reviews are conducted by teams of senior engineers from the contractor, MSFC and other NASA Centers. These teams report the result of their reviews to a Board chaired by the Project Manager and made up of senior engineers from MSFC, other Centers, and outside industry

Present Facility Description (T-24)

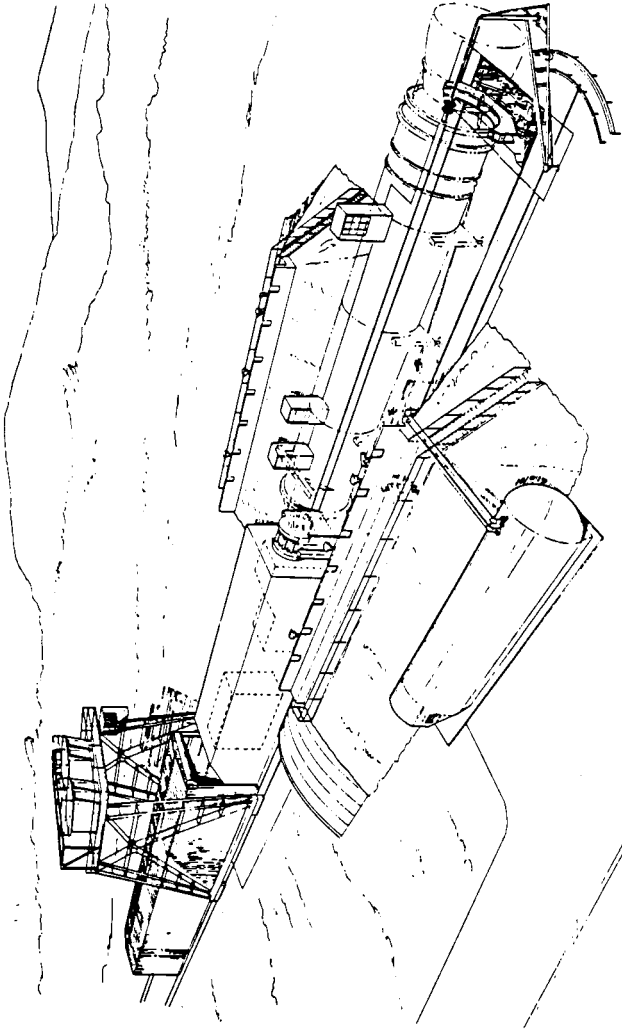

MORTON THIKOL, INC.
Space Division

A001972

ATTACHMENT 1

INFORMATION OF THIS PAGE WAS PREPARED TO SUPPORT AN ORAL PRESENTATION

Present Facility Description (Cont)

- **Reaction mass**
 - **20 x 59 x 18.5 ft high**
20,000,000 lb concrete
60-ton steel plates
Rear pit (20 x 10 x 15 ft deep)

- **Crane**
 - **200 ton at 39 ft hook height**
 - **5 ton at 29 ft hook height**

- **Environmental house**
 - **30 x 154 ft retractable**
 - **Temperature control--heat only (to 100°F)**

Present Facility Description (Cont)

- Quench (CO₂)
- Forward
- Aft
- 64,000 lb CO₂
- Purge
- Nitrogen
- Water deluge and sprinkling
- Skirt
- Hydrazine service cart
- Hydraulic service cart
- Handling
- Air bearings
- Rounding rings

MORTON THIOKOL, INC.
Space Division

INFORMATION OF THIS PAGE WAS PREPARED TO SUPPORT AN ORAL PRESENTATION

6

97004 1E

Present Facility Description (Cont)

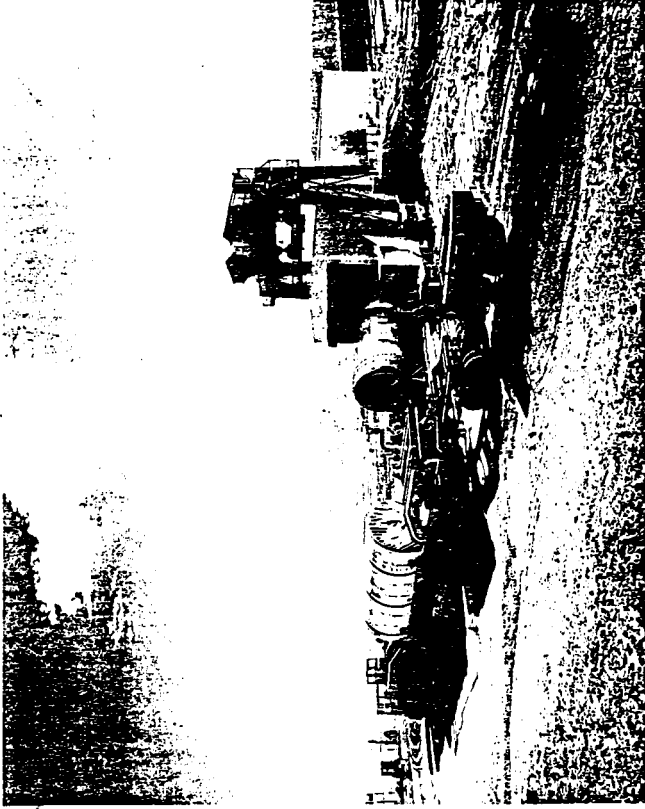

NS8869 1

8/7004

MORTON THIOKOL, INC.
Space Division

INFORMATION OF THIS PAGE WAS PREPARED TO SUPPORT AN ORAL PRESENTATION
AND CANNOT BE REPRODUCED COMPLETE WITHOUT THE ORAL PRESENTATION

Present Facility Description (Cont)

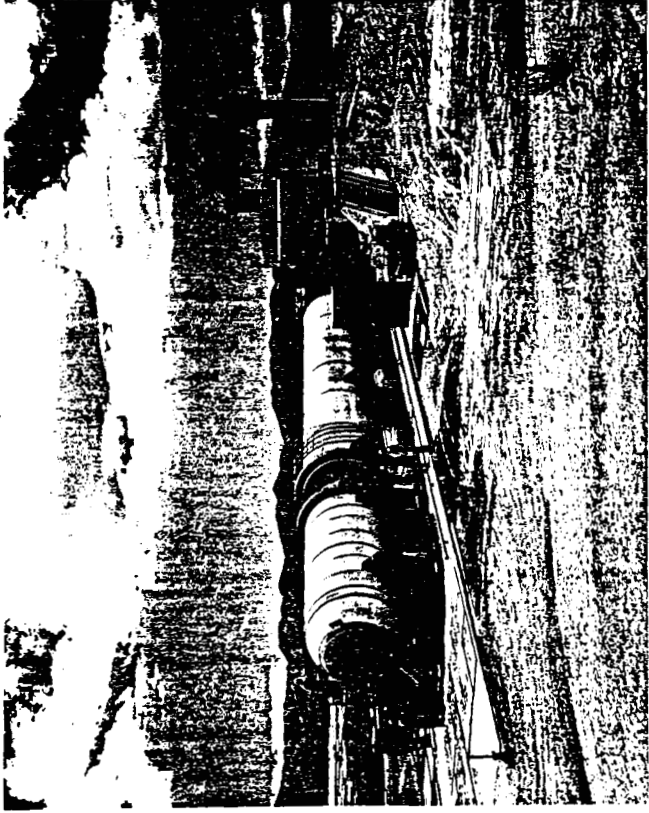

NS8857 1

9 7004

MORTON THIKOL, INC.
Space Division

INFORMATION OF THIS PAGE WAS PREPARED TO SUPPORT AN ORAL PRESENTATION
ON 11/17/77

Present Facility Description (Cont)

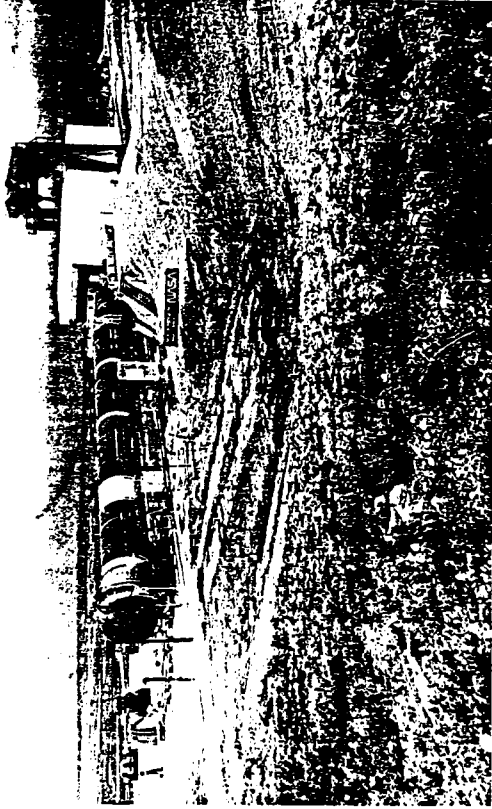

884589-7

81004

MORTON THIKOL, INC.
Space Division

INFORMATION ON THIS PAGE WAS PREPARED TO SUPPORT AN ORAL PRESENTATION
AT THE 1964 SPACE SYMPOSIUM, THE UNIVERSITY OF TEXAS AT AUSTIN

SRM Test Stand Force Measurements (Cont)

- Axial thrust
 - 4.6 M lb
 - Ten 460,000 lb load cells (five compression and five tension)
 - 3.5 M lb roll flexure
 - Verification load system
- Aft side load
 - 650K lb
 - Two 325K lb load cells
 - Full-calibration system
- Fwd side load
 - 150K lb
 - One load cell
 - Full-calibration system

SRM Forward Test Stand

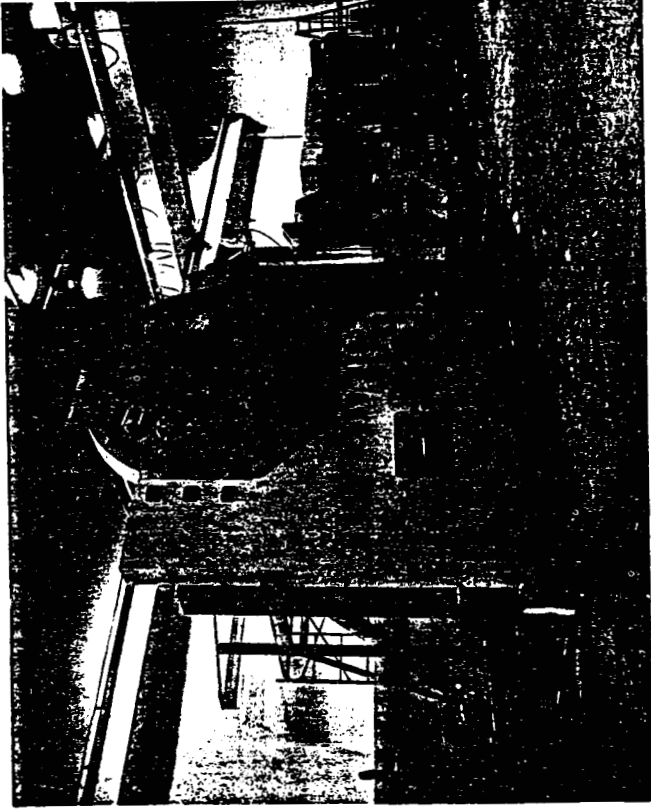

87004

MORTON THIKOL, INC.
Space Division

INFORMATION OF THIS PAGE WAS PREPARED TO SUPPORT AN ORAL PRESENTATION

SRM Aft Test Stand



NB7414.2

87004

MORTON THIKOL, INC.
Space Division

INFORMATION OF THIS PAGE WAS PREPARED TO SUPPORT AN ORAL PRESENTATION.

Present Instrumentation

• Digital	
• A system	128 channels
• B system	128 channels
• C system	128 channels
• D system	128 channels
Total	512

• FM	
Direct	8
Multiplex (2KC)	60
Single carrier (20KC)	30
Timing	8
Total	106

Total channels 618

MORTON THIKOVI, INC.
Space Division

INFORMATION OF THIS PAGE WAS PREPARED TO SUPPORT AN ORAL PRESENTATION

1A

87004 2D

Present Instrumentation (Cont)

Digital Instrumentation System

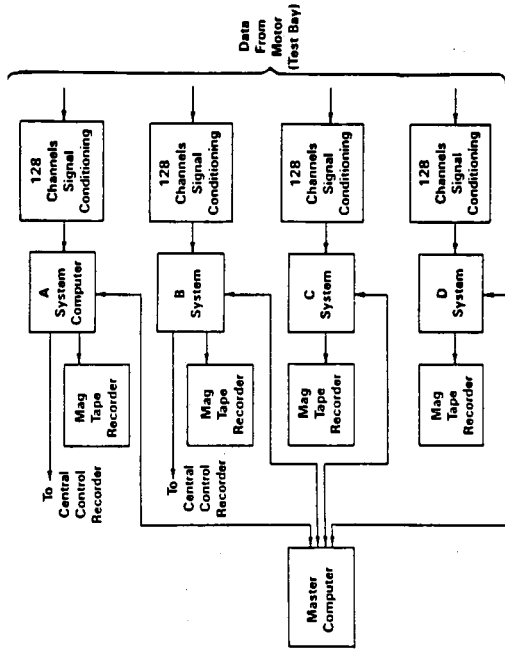

MORTON THOKOL, INC.
Space Division

INFORMATION OF THIS PAGE WAS PREPARED TO SUPPORT AN ORAL PRESENTATION

A001301

Present Instrumentation (Cont)

Digital Data System



N84398

8/70/4

MORTON THIKOL, INC.
Space Division

INFORMATION OF THIS PAGE WAS PREPARED TO SUPPORT AN ORAL PRESENTATION

Present Instrumentation (Cont)

FM and Control System

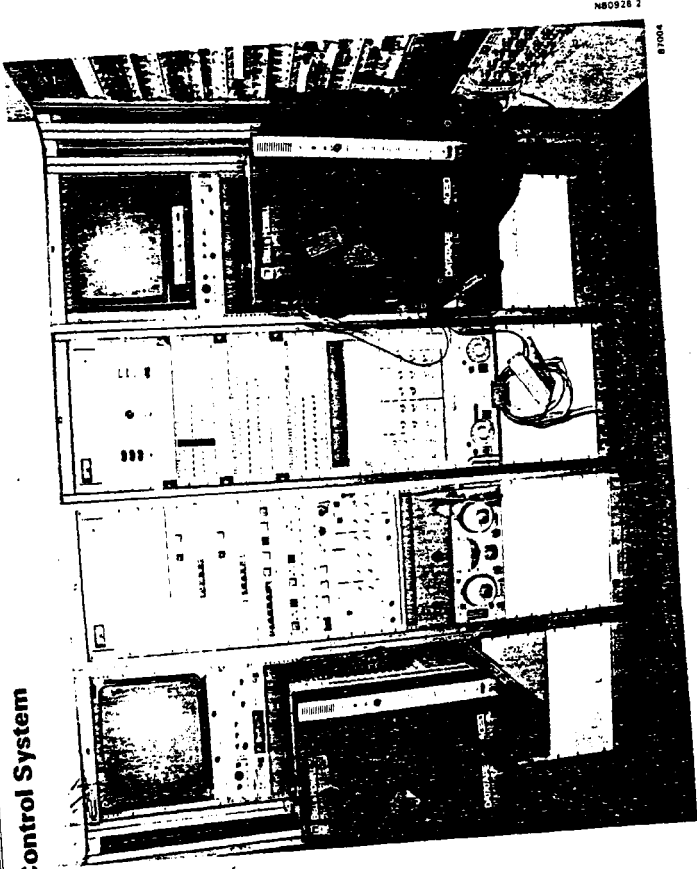

MORTON THIOKOL, INC.

Space Division

INFORMATION OF THIS SPACE WARE PRESENT TO SUPPORT AN ORAL PRESENTATION

and defense leaders. The objective of these reviews is to assure that the design is being developed and verified consistent with requirements and good engineering practices.

2) Formal certification by Morton Thiokol, Inc. (MTI) on the Certificate of Qualification (COQ) with supporting evidence documentation that the joint had been qualified to all contract requirements. This COQ and its evidencing documentation is reviewed and concurred in by the MSFC laboratories, approved by the Quality and Reliability Assurance Office and the SRM Chief Engineer. Based on these reviews and approvals, the Project Manager makes the final approval.

The basis for certification before the fifth flight was a Vehicle Certification Review for the lightweight SRM. In that review, only subsystems affected by the weight reduction were recertified. Other subsystems were certified by similarity to the STS-1 configuration and the basis for that certification was not re-evaluated.

Adequacy of Design

QUESTION 9:

"The Rogers Commission concluded that there was sufficient data in the August 19, 1985, briefing by Thiokol to NASA for NASA to suspend Space Shuttle flights until the problem was fixed. Yet, the Thiokol conclusions in that briefing stated that "analysis of existing data indicates that it is safe to continue flying (the) existing (joint) design". Why did Thiokol conclude this?

ANSWER 9:

The August 19, 1985, meeting was stimulated by incidence of o-ring erosion, and more specifically, the violation of the primary o-ring in the nozzle joint of STS-51B and the 0.032 in. erosion noted on the secondary o-ring of that nozzle joint. That condition was attributed to not detecting a bad primary seal because of the vacuum putty masking the 100 psig stabilization pressure during leak check of the nozzle. A detailed erosion analysis of the nozzle o-ring on STS-51B indicated that the primary o-ring never sealed at ignition in order to sustain the erosion observed. The o-ring erosion computer model accurately predicted the observed erosion as a combined jet impingement and blow-by erosion at ignition. This same model then predicted the erosion observed on the secondary face seal of the nozzle around the corner. The conclusion was that this condition would not be encountered again because proper corrective action had already been taken; all joints were being leak checked with a 200 psig stabilization pressure to prevent putty from masking the leak check allowing a bad seal to go undetected. It was also concluded that the STS-51B problem may be unique to the nozzle-to-case joint because the primary nozzle o-ring groove was considerably wider than the field joint (0.375 in. vs 0.305 in.) and the o-ring was also smaller (0.275 in. vs 0.280 in.), and therefore had farther to travel after the leak check had forced the primary o-ring into the wrong side of the o-ring groove.

The nozzle secondary face seal was considered to be a good seal under all conditions. Cold gas pressurization and hot gas erosion tests conducted with subscale hardware on full size o-rings indicated that primary o-rings in either nozzle or field joints could sustain up to 0.145 - 0.161 in. erosion before they would fail.

Based upon prior history from flight motors, the worst o-ring erosion noted in a field joint was 0.053 in. on STS-2 and excluding STS-51B, the worst jet impingement erosion noted on a flight nozzle was 0.068 in. on STS-51D.

This represented safety factors of 2.7 and 2.1, respectively, on erosion of the primary o-rings. Only one secondary o-ring ever sustained erosion. That was on STS-51B and that o-ring exhibited 0.032 in. erosion; 4.5 times greater erosion is needed for failure.

O-ring blow-by was less understood at that time and had been observed in a field joint on one flight STS-51C, and excluding STS-51B, on nozzles from just three flights, STS-6, STS-51C, and STS-51G. Two of these flights, STS-6 and STS-51C, had evidenced slight blow-by on the nozzle with no erosion. The blow-by observed on the field joint of STS-51C was attributed to the cold weather experienced prior to that flight which resulted in the coldest o-ring temperature (53°F) ever flown. This flight was preceded by the three coldest days in Florida history. STS-51C was considered to be the worst case condition which would not occur again. The conditions observed on STS-51C, although not desirable, were considered acceptable. The blow-by observed on the field joints of STS-51C resulted in the o-ring resiliency testing that showed that cold o-rings could not keep up with the joint opening.

It was because of this o-ring resiliency data that Morton Thiokol concluded that the field joint was most critical and that was highlighted on Page C-1 of the August 19, 1985, presentation under Primary Concerns - Field Joint - Joint deflection and secondary o-ring resiliency. Page C-2 showed that the bench testing conducted indicated that the o-ring was capable of maintaining contact with the metal parts for the initial phase (0-170 msec) of the ignition transient but not for the total gap opening. It was concluded that blow-by occurred early in the ignition transient (0-170 msec) during the seating phase of the primary o-ring. That is why there was never observed erosion on the secondary o-ring.

In the conclusions on Page D-15 of the August 19, 1985, presentation, it was noted that, "The primary o-ring in the field joint should not erode through, but if it leaks due to erosion or lack of sealing, the secondary seal may not seal the motor." On the next page, the first recommendation was: "The lack of a good secondary seal in the field joint is most critical and ways to reduce joint rotation should be incorporated as soon as possible to reduce criticality." The conclusion was that if the same condition was experienced in the field joint that had been observed on the STS-51B nozzle joint, the joint may not survive. In order to assure that condition doesn't happen again, it is

Primary Concerns

- Field joint--joint deflection and secondary O-ring resiliency
- Nozzle joint--circumferential gas flow near O-ring region
- Igniter Gask-O-Seal--seal overflow and related joint clamping due to bolt torque

MORTON THROKOL, INC.
 Wasatch Operations

C-11

0810 24C

INFORMATION ON THIS PAGE WAS PREPARED TO SUPPORT AN ORAL PRESENTATION
 AND CANNOT BE CONSIDERED COMPLETE WITHOUT THE ORAL DISCUSSION

Primary Concerns (Cont)

- Field joint--highest concern
 - Reclassification of SRM field joint from 1R to 1 was incorporated into the SRB CIL by Change No. 23 on 3 Feb 1983
 - Erosion penetration of primary seal requires reliable secondary seal for pressure integrity
 - Ignition transient (0 to 600 msec)
 - 0 to 170 msec: high probability of reliable secondary seal
 - 170 to 330 msec: reduced probability of reliable secondary seal
 - 330 to 600 msec: high probability of no secondary seal capability
 - Steady state--600 msec to 2 min
 - If erosion penetrates primary O-ring seal - high probability of no secondary seal capability
 - Bench testing showed O-ring not capable of maintaining contact with metal parts gap opening rate to MEOP
 - Bench testing showed capability to maintain O-ring contact during initial phase (0 to 170 msec) of transient
 - Undefined potential circumferential gas flow requires continued filling of joint gaps with vacuum putty - near term

MORTON THIOKOL, INC.
Walsatch Operations

C-2

04110 210

THE INFORMATION ON THIS PAGE WAS PREPARED TO SUPPORT AN ORCA PERFORMANCE AND CAPABILITY CONSIDERED COMPLETE WITHOUT THE ORCA DISCUSSION

General Conclusions

- All O-ring erosion has occurred where gas paths in the vacuum putty are formed
- Gas paths in the vacuum putty can occur during assembly, leak check, or during motor pressurization
- Improved filler materials or layout configurations which still allow a valid leak check of the primary O-rings may reduce frequency of O-ring erosion but will probably not eliminate it or reduce the severity of erosion
- Elimination of vacuum putty in a tighter joint area will eliminate O-ring erosion if circumferential flow is not present - if it is present, some baffle arrangement may be required
- Erosion in the nozzle joint is more severe due to eccentricity; however, the secondary seal in the nozzle will seal and will not erode through
- The primary O-ring in the field joint should not erode through but if it leaks due to erosion or lack of sealing the secondary seal may not seal the motor
- The igniter Gask-O-Seal design is adequate providing proper quality inspections are made to eliminate overflow conditions

MORTON THOMAS, INC.
Wasatch Operations

D-15

08110 29A

NO INFORMATION ON THIS PAGE WAS PREPARED TO SUPPORT AN ORCA PRESENTATION
AND SHOULD BE CONSIDERED CONFIDENTIAL WITHOUT THE ORCA DISCUSSION

necessary to eliminate any conditions that could prevent a primary o-ring from sealing during the first 170 msec. It was concluded that analysis of existing data indicates that is safe to continue flying the existing design as long as all joints were leak checked with a 200 psig stabilization pressure, are free of contamination in the seal areas and meet o-ring squeeze requirements. It was believed that if this was done, it would eliminate any potential of blow-by beyond 170 msec and the only problem that might be encountered is jet impingement erosion on the primary o-ring due to holes in the putty. This jet impingement was limited to the ignition transient of 600 msec and margins of safety greater than 2.0 for this condition had been demonstrated.

QUESTION 9A:

"Why did NASA not disagree?"

ANSWER 9A:

At the time of the August 19, 1985, briefing, seven flights and two ground test motors had experienced o-ring erosion plus other occurrence of heat affect and/or blow-by. Each of these observations had been analyzed in the Flight Readiness Review process and a rationale for flight established and accepted at Levels II and I. Based on Thiokol's conclusion that the joint was safe as long as there was a 200 psig leak check, no contamination and proper squeeze, NASA believed there was no basis for disagreement. However, had NASA recognized that a proviso regarding o-ring resiliency should have been included, the agency would have disagree.

QUESTION 10:

"Thiokol and Marshall first learned of the existence of "joint rotation" in a "hydroburst test" in 1977. However, throughout subsequent years, the two organizations could never agree on just how much rotation did occur. A final "referee" test was not concluded until after the 51-L accident."

o "Why did it take nine years for Thiokol and Marshall to set up the tests required to resolve this critical issue?"

ANSWER 10:

The first "joint rotation" was observed in the late 1977 hydroburst test where o-rings were extruded into the sealing gap. These tests indicated that the seal would work properly even with joint rotation. Since the sealing of the joint was secure even well above the performance requirements and all joint assemblies have leak checks, joint performance and calculation of o-ring squeeze continued to be accomplished with "worst-on-worst" design parameters. Later tests conducted with the structural test article (STA-1) in 1978 and 1979 indicated more joint rotation than was observed on the initial tests in 1977. Questions were raised relative to the validity of the instrumentation and data from STA-1 taken from a single location (through the leak check port) in a horizontal position. However, extrusion tests were

conducted which showed that the SRM joint would seal properly with an extrusion gap more than twice that observed on STA-1 with five times the maximum expected operating pressure.

Worst-on-worst dimensional tolerance analyses (thinnest tang, maximum clevis width, maximum o-ring groove, minimum thickness o-ring) with the measured gap opening from STA-1, also indicated it would be possible to lose the squeeze on the secondary o-ring. Because of this, the o-ring size was increased and joint tolerances were decreased to maximize o-ring squeeze and dimensional measurements of the clevis and tang were instituted on every flight set of motors to assure that adequate o-ring squeeze was maintained on both the primary and secondary o-rings to assure seal redundancy. For these reasons, joint rotation performance was considered adequate for flight even though the exact extent of rotation was still a controversy. To obtain additional data on the exact magnitude of joint rotation, measurements were taken at Morton Thiokol in vertical hydrotests at 12 percent over the maximum expected operating pressure, on flight hardware being processed through the refurbishment cycle. This course was followed in lieu of dedicating hardware to resolve the controversy. This data indicated less rotation than was measured on STA-1.

With the on-set of o-ring erosion problems, the referee test was implemented to resolve these differences and look at increasing the margin in the joint as well as determining the rotation at various locations around the entire joint rather than at only a single location. The referee test confirmed the smaller joint rotation values and also confirmed that these values were uniform around the joint.

The bottom line of why it took nine years, is that we thought the performance was adequate even though the exact magnitude of rotation was a controversy. Also, additional data were obtained by measuring flight hardware being processed through the refurbishment cycle. With the advent of o-ring erosion problems resolution took on a new emphasis in the context of increasing the margin in the joint; therefore, the referee test was devised. It should be noted the referee test was devised and preparations for the test were in process prior to STS 51-L.

QUESTION 11:

"How much of the Shuttle SRB design is based on the Titan design?" "Please explain or elaborate on the following:

- o Shuttle SRB tang and clevis are revised from the Titan.
- o Shuttle SRB tang is longer than on the Titan, thus contributing to more joint rotation on the Shuttle SRB than on the Titan.
 - Titan has only one seal, the Shuttle has two.
 - Titan insulation of one case fits tightly against the insulation of the adjacent case to form a more gas-tight fit than the Thiokol design.

- o It appears that a great deal of the Shuttle SRB design originated from the Titan. How much of the Shuttle testing was done by analysis based upon the Titan data base? Are the Titan and Shuttle SRB enough alike to result in reliable analyses?"

ANSWER 11:

At the time that design of the Shuttle SRB case segments was begun, the majority of experience with such designs had been developed by the Titan III SRB program. The Shuttle SRB design was, therefore, based on the Titan SRB design. However, the Shuttle dimensions were bigger and the loads were greater than Titan's. The Titan case segment dimensions are 120 inches in diameter by 120 inches long, while the Shuttle SRB segments are 146 inches in diameter and 164 inches long.

The tang and clevis arrangement on the Titan SRB was changed on the Shuttle SRB because state-of-the-art large forging fabrication capability would not provide enough material to permit machining of a clevis on the large one-piece weld-free forward dome and still provide for an integral forward skirt tang. As a result to this factor, a tang-down design was assessed.

It was found that assembly, reliability and safety were enhanced by the tang-down design. The tang-down design provides an advantage during assembly of the Shuttle SRM. The clevis, with its required field joint o-ring installation operation, is stationary; while the tang side of the joint, which requires no installation operations, is the one suspended from a crane.

The tang length on the Shuttle SRM casings was increased to accommodate loads and to enhance assembly operations. No data were available to the Shuttle program during the design of the SRB's on the Titan SRB joint rotation or on static-test hardware evaluations. The fact that the Titan had experienced heat affected areas of the o-rings during static tests were not known to MTI prior to the STS 51-L accident. Joint tolerances on both the Shuttle and Titan SRB's were essentially the same, although some allowance was made to accommodate Shuttle SRM horizontal assembly for static test.

Two o-rings were incorporated in the Shuttle SRB to provide redundancy and permit leak check of the assembled joints, features not possible with the Titan design. Titan joint insulation does have the interference but fit to allow for fabrication tolerances, while the SRB joint used putty filled gaps for tolerance allowance and to avoid placing extra long-term stress on case-to-insulation bonds.

The Titan and Shuttle SRB's are enough alike to result in reliable analyses when using Titan data as a base. Tang and clevis joints have been used in other motors than Titan, but Titan Solid Rocket Booster experience (120 inch diameter) with high strength steel (D6AC) was a natural to use as a base from which to scale up for the Shuttle SRB (146 inch diameter and also

D6AC). Higher loads and recoverability were two main additional factors of the Shuttle SRB structural analysis. Also, the new requirement of fracture toughness was unique to the Shuttle SRB case material and resulted in a refined analysis for reuse criteria, which included rehydroproof as part of refurbishment.

QUESTION 12:

"How many SR&QA personnel does Marshall have? By category?"

ANSWER 12:

Total - 84

Categories: Quality-46, Reliability-7,
Inspection Verification-25 and Secretarial-6

QUESTION 12A:

"When the o-ring maximum erosion was determined to be first 0.070, then 0.090, then 0.125 inches, was a safety officer consulted about whether this was an "acceptable risk"? Further, after the field joint's primary o-ring was designated a Criticality 1 and the secondary o-ring failed to seal, didn't safety personnel raise concern about the "risk"? Were safety personnel even aware of the erosion data from each flight?"

ANSWER 12A:

The Safety Director and the Director of the Reliability and Quality Assurance Office are members of the Flight Readiness Review (FRR) Board which accepted the rationale for each flight.

QUESTION 12B:

"Were reliability engineers ever consulted by Thiokol or Marshall with the continued use of o-ring when it was not performing as intended?"

ANSWER 12B:

When Morton Thiokol discovered the o-ring charring problem, Reliability Engineering was immediately contacted. They prepared reports and participated in monthly meetings where the problem and its corrective actions were discussed. They supplied input to the Flight Readiness Reviews (FRR) concerning FMEA/CIL (Failure Modes and Effects Analysis/Critical Items List) changes and COQ (Certification of Qualification) status. They also attended the SRM o-ring Task Force meetings when the task force was created, plus accumulating the data bank on each flight motor anomaly.

MTI Reliability Engineers were involved in the o-ring charring problem and they agreed with others at Morton Thiokol to continue the Space Shuttle Program while a design solution was in progress.

In the case of MSFC, Quality and Reliability Assurance personnel have been and are involved in the day-to-day activities of the

Project and were fully cognizant and involved in the o-ring charring problem and they agreed with others at NASA to the rationale for flight presented in the Flight Readiness Reviews (FRR).

QUESTION 13:

"Mr. Aldrich testified before the Commission that o-ring erosion was not considered to be an anomaly and, therefore, it was not logged and, accordingly, there are no anomaly reports that progress from one flight to the other.

- o Was o-ring erosion really not considered to be an anomaly? Why?
- o If it were considered an anomaly, wouldn't it have had to be reported to level II?
- o Did the action of putting the o-ring erosion problem on Marshall's Problem Reporting System (PAS) exempt Marshall from having to report to Level II about the problem? Is that why Marshall chose to put the o-ring erosion problem on the PASA rather than the PRACA (Problem Reporting and Corrective Action System)?"

ANSWER 13:

Mr. Aldrich, undoubtedly was referring to the fact that o-ring erosion was not reported on the Flight Test Anomaly List (FTAL) that is published as part of the Flight Evaluation Report. The SRB Project Office's definition of a flight anomaly for identification in the FTAL was limited to those anomalies that affected the powered flight performance of the SRB. the o-ring erosion was considered an anomaly; however, it did not meet the FTAL definition and was not included in the FTAL as part of the Flight Evaluation Report.

O-ring erosion was reviewed in the flight readiness process with Level II & I. In addition, the following anomaly reports were written on o-ring erosion and were included in the MSFC Problem Assessment System (PAS), PAS Numbers A07934, A08615, A08939, A09968, A08014, A08299, A08687, A09260, and A09288.

All o-ring erosion anomaly reports were reported to Level II through PAS. Prior to May 26, 1983, when Change 37 to Volume V of JSC Document 07700, Level II Program Definitions and Requirements (PDR), was implemented, MSFC PAS personnel reported all Criticality 1, 1R, 2 and 2R problems to Level II. Since that time, only system level problems (interface problems, common hardware problems and interproject hardware problems) are required to be reported. However, PAS personnel state that they continue to submit Criticality 1, 1R, 2, and 2R problems to Level II and that all o-ring erosion problems were submitted to Level II.

MSFC's Problem Assessment System (PAS) is the only active problem reporting and tracking system at MSFC. Problem Reporting and Corrective Action System (PRACA) is used at JSC and KSC in the

same manner that the PAS is used at MSFC. PRACA is not active at MSFC but an effort has been underway for some time to establish PRACA as a computerized intercenter problem reporting system. However, this has not been accomplished.

QUESTION 14:

In December 1982, the o-ring was redesignated a Criticality 1 from a Criticality 1R. Is Marshall required to inform Levels II and I about anomalies of Criticality 1 items?"

ANSWER 14:

JSC 08126A, Problem Reporting and Corrective Action (PRACA) System Requirements Document For Space Shuttle Program is not specific in the context of specifying reporting of Criticality 1 items. It does require that the Space Shuttle Program Office (SSPO) be informed of launch-constraints problems and resolutions for clearing constraints. A launch-constraint problem is defined as "a problem which, if it occurred in launch processing, flight, landing, or recovery, would have adverse safety or mission performance consequences". It also requires reporting of System Level Problems which are defined as problems occurring on flight common usage hardware or Space Shuttle inter-project accountable hardware and element physical interface hardware that occur during or subsequent to acceptance testing of a Line Replaceable Unit (LRU) or during certification testing. Prior to the issuance of Change Notice 37 on May 26, 1983, to Volume V of JSC Document 07700, which is the document that calls out JSC 08126A as the implementing document for the Shuttle Problem Reporting and Corrective System, the definition of a system level problem included problems occurring on Criticality 1, 1R, 2 and 2R hardware in addition to problems on common, inter-project and interface hardware. Change Notice 37 deleted Criticality 1, 1R, 2 and 2R from the definition of a reportable system level problem. Regardless of the specifics contained in JSC 08126A, all initial Problem Reports (PR) (see answer to Question 9) on o-ring problem were forwarded to the JSC (Level II) PRACA Data Center. In addition, all initial PR's and the monthly MSFC Problem Assessment System (PAS), Open Problem List (OPL) are distributed to the Director of Reliability, Maintainability and Quality Assurance, NASA Headquarters (Level I). Therefore, Level II and I should have been informed through the PAS system that the o-ring erosion problems were being encountered and were open problems since problems resolution reports had not been processed. In addition, as previously stated in the answer to Question 13, and in testimony before the Presidential Commission and Congressional Committees, the problems on o-ring and the rationale for clearing flights in light of these problems were presented to and approved by both Level I and II as part of the Flight Readiness Review (FRR) process.

QUESTION 14A:

"How often do you witness continuous anomalies of Criticality 1 items?"

ANSWER 14A:

One or two on every flight (for example, joint erosion, nozzle pocket erosion, turbine blades, turbo pump bearings, ullage pressure transducer problems).

QUESTION 14B:

"Would you say its unusual?"

ANSWER 14B:

No.

QUESTION 14C:

"Why didn't you feel it necessary to inform Levels II or I, or even your SR&QA people?"

ANSWER 14C:

Levels I and II and the Safety, Reliability and Quality Assurance people were informed as previously explained in the answers to Questions 13 and 14.

QUESTION 15:

"The Problem Reporting and Corrective Action document (JSC 08126A, paragraph 3.2d) requires project office to inform Level II of launch constraints. Why didn't Marshall (Mulloy) inform Level II?"

ANSWER 15:

The means of reporting and clearing problems which would impose launch constraints is through the FRR process. O-ring erosion was established as a launch constraint in the MSFC PAS system for 51-F and subsequent by the SRM Project Office. This problem was presented to Level II and Level I during the 51-F FRR and rationale for flight established and accepted. O-ring erosion continued to be identified as an open problem in the MSFC PAS system requiring further investigation before closure. In subsequent FRR's, previously established rationale for flight was assessed to identify any changes necessary to the established rationale. In the 51-L FRR, this issue was reported to Level II and I that there were "no findings from continuing analyses that changes previously established rationale for flight" (see attachment).

CERTIFICATION/VERIFICATION STATUS

<u>CATEGORY</u>	<u>REMARKS</u>	<u>FLIGHT CONSTRAINT</u>
1. CHANGES	PROPERLY CLASSIFIED AND APPROPRIATELY DISPOSITIONED	NO
2. NONCONFORMANCES	PROPERLY CLASSIFIED AND APPROPRIATELY DISPOSITIONED	NO
3. CERTIFICATES OF QUALIFICATION	NEW COOH ISSUED FOR CLASS I CHANGES	NO
4. HAZARDS	NO NEW HAZARDS	NO
5. ALERTS	NONE OPEN	NO
6. 1ST TIME WAIVERS	FIVE FIRST TIME WAIVERS IDENTIFIED (3 ASCENT/RECOVERY CRITICAL)	NO
7. FMEA/CIL CHANGES	CIL UPDATED FOR CLASS I CHANGES	NO
8. LIMITED LIFE SENSITIVE ITEMS	ALL HAVE LARGE MARGINS	NO
9. ASSEMBLY AND CHECKOUT PROCESS TO DATE	COMPLIANCE WITH OMRSD AND ICC'S VERIFIED BY LSS	NO
10. CONTINUING FAILURE ANALYSES	NO FINDINGS FROM CONTINUING ANALYSES THAT CHANGES PREVIOUSLY ESTABLISHED RATIONALE FOR FLIGHT.	NO



National Aeronautics and
Space Administration

Washington, D C
20546

JUNE 12 HEARING - APPENDIX #1

Reference: MDD:brb:C-194631

AUG 5 1986

Honorable Robert Roe
Acting Chairman
Committee on Science
and Technology
House of Representatives
Washington, DC 20515

Dear Mr. Chairman:

It is requested that the following clarification be included in the hearing record resulting from the June 12, 1986, hearing at which Dr. Fletcher testified on the Challenger accident.

In addition to the memorandum requested on page 149, line 3657 by Mr. Nelson, we are providing an explanation of actions take as a result of the August 19, 1985, meeting.

Although Level I did not send specific directions to MSFC after the August 19, 1985, meeting in Washington, D.C., the three caveats required for safety were completely and thoroughly implemented. Requests for additional information on the four topics, relative to the O-rings, as stated in Mr. Herr's letter of August 23 definitely indicate that Headquarters was not fully satisfied with the August 19 MTI presentation. This was also shown by Mr. Weeks testimony and by the testimony of Mr. John Thomas of Marshall Space Flight Center.

The first item of pressurizing the seal to 200 psi was implemented on all subsequent joints. As the Committee knows, the pressure was raised from 50 psi to 100 psi and, finally to 200 psi after extensive ground tests and postflight examinations showed that the putty could hold about 150 psi and therefore, 200 psi was required to insure the primary seal was effective as a seal even though it was moved in the groove to a reverse position.

Contamination has also been a concern for many years (perhaps as far back as the very beginning) in fact, the Dr. Williams/Lt. Gen. (Retired) Thomas Morgan Committee that reviewed the SRM design/certification prior to STS-1 (in late 1980) specifically, concerned themselves with contamination of the grease and O-ring lands. As Mr. John Thomas testified, there was evidence to indicate contamination had been very well controlled on all stacked SRMs (launches) including 51-L.

In regard to the third item, that of controlling the squeeze:
Mr. John Thomas testified that the squeeze requirements had been met on all of the SRM's that were examined (in post-mortem) and in particular 51-L squeeze specification requirements were fully met. In fact, the August 19, 1985 presentation concentrated on O-ring and joint deflection, but did not discuss or elude to the temperature problem (O-ring sensitivity to temperature variations).

I understand that this letter may be inserted in the transcript in the form of an appendix and referred to by footnote in the main text.

Sincerely,

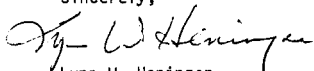

Lynn W. Heninger
Director, Congressional Liaison Division

JUNE 12 HEARING—APPENDIX #2

 <p>KSC SHUTTLE OPERATIONS</p>	<p>51-L DATA AND DESIGN ANALYSIS TASK FORCE</p>	<p>NAME: T. UTSWAN ORG. DATE: JUNE 12, 1986</p>
<p>PRE-LAUNCH ACTIVITIES TEAM</p>		

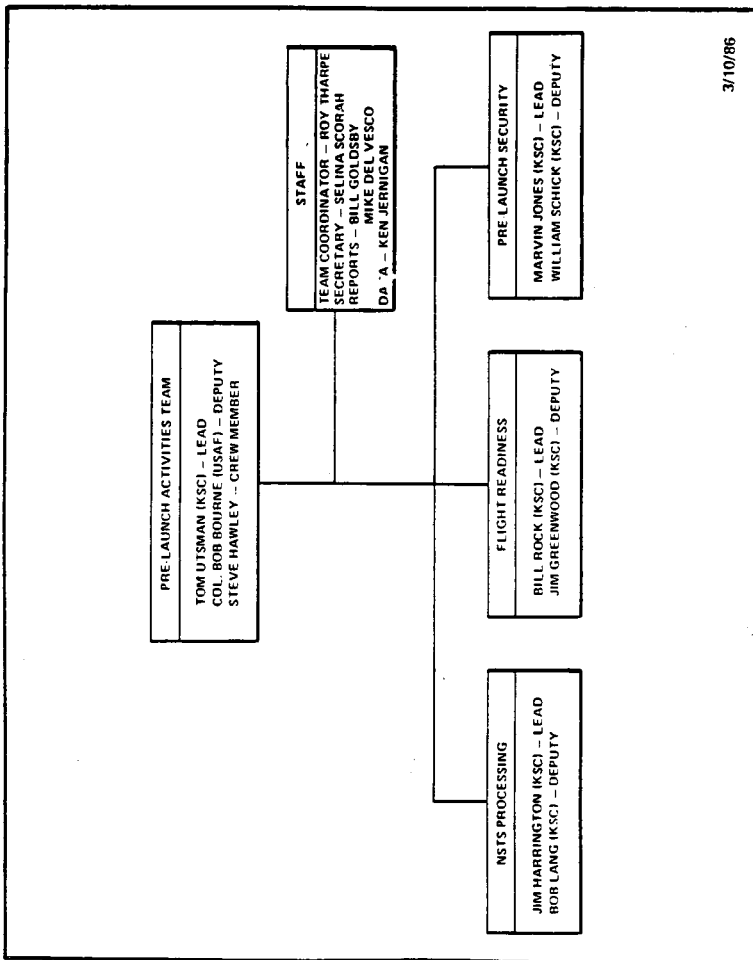



3/10/86

SG 7847

 <p>KSC SHUTTLE OPERATIONS</p>	<p>PRE-LAUNCH ACTIVITIES TEAM</p>	<p>NAME: T. UTSMAN ORG: DDATE DATE: JUNE 12, 1986</p>
<p style="text-align: center;"><u>MAJOR REVIEW EFFORT</u></p> <p>0 QUITE COMPREHENSIVE</p> <ul style="list-style-type: none"> - INVOLVED APPROX. 900 PEOPLE - INVOLVED ALL LEVELS (ENGINEERING MANAGEMENT DOWN THROUGH TECHNICIAN RANKS) - INVOLVED ALL DISCIPLINES (OPERATIONS, ENGINEERING, QUALITY, SAFETY) - INVOLVED NASA, AF AND CONTRACTOR ORGANIZATIONS <p>0 CONCLUSIONS</p> <ul style="list-style-type: none"> - SIGNIFICANT RELEVANT FINDINGS - OPERATIONAL PROCEDURES REQUIRING CORRECTION - PROCESSING PRACTICES THAT CAN BE IMPROVED <p>0 DOCUMENTED RESULTS</p> <ul style="list-style-type: none"> - 23 VOLUMES - 6000 PAGES 		

 <p>KSC SHUTTLE OPERATIONS</p>	<p>PRE-LAUNCH ACTIVITIES TEAM</p>	<p>NAME: T. UTSMAN ORG. DDATE DATE: JUNE 12, 1986</p>
<p style="text-align: center;"><u>NSIS PROCESSING REVIEW</u></p> <p>0 REVIEWED ALL FLIGHT HARDWARE PROCESSING ACTIVITY ASSOCIATED WITH THE 51-L MISSION, INCLUDING SRB JOINT MATE</p> <p>0 REVIEWED THE OPERATIONAL DOCUMENTATION ON ALL PRIMARY INTERFACES</p> <ul style="list-style-type: none"> - MLP - PAD-B (ACTIVATION/PERFORMANCE) - GSE - FACILITIES <p>0 REVIEWED PAYLOAD PROCESSING ACTIVITIES</p> <p>0 REVIEWED ACTIVITIES OF ICE/FROST TEAM</p> <p>0 REVIEWED ACTIVITIES OF DOD RANGE SUPPORT</p> <p>0 ANALYZED ANY DIFFICULTIES ENCOUNTERED DURING 51-L PROCESSING</p> <p>0 DOCUMENTED FINDINGS</p>		

 <p>KSC SHUTTLE OPERATIONS</p>	<p>PRE-LAUNCH ACTIVITIES TEAM</p>	<p>NAME: T. UTSMAN ORG: DDATE DATE: JUNE 12, 1986</p>
<p><u>NSTS PROCESSING REVIEW</u></p> <p><u>10 SUB-TEAMS REVIEWS</u></p> <ul style="list-style-type: none"> <input type="checkbox"/> SRR PROCESSING <input type="checkbox"/> SRR JOINT MATE <input type="checkbox"/> ET PROCESSING <input type="checkbox"/> ORBITER PROCESSING <input type="checkbox"/> PAD-B ACTIVATION <input type="checkbox"/> PAD-B FACILITY <input type="checkbox"/> ICE TEAM <input type="checkbox"/> PAYLOAD PROCESSING <input type="checkbox"/> INTEGRATED GROUND PROCESSING <input type="checkbox"/> RANGE SUPPORT 		

 KSC SHUTTLE OPERATIONS	PRE-LAUNCH ACTIVITIES TEAM	NAME: T. UTSWAN
		ORG: DDATE DATE: JUNE 12, 1986
<p><u>FINDING:</u> NO FACTORS CONTRIBUTING TO THE 51-L ACCIDENT WERE FOUND IN THE STS PROCESSING REVIEW</p> <ul style="list-style-type: none"> o THOROUGH ANALYSIS OF PROCESSING OPERATION <ul style="list-style-type: none"> - OVERALL PREPARATION - BUILD-UP - INTEGRATION (FACILITIES, GSE, FLIGHT HARDWARE) o EMPHASIS ON UNPLANNED EVENTS/PROBLEMS AND THE ASSOCIATED DOCUMENTATION o REVIEWED TO PROVIDE ENGINEERING, OPERATIONS, QUALITY AND SAFETY ASSESSMENTS OF PROCESSING o NEEDED OPERATIONAL IMPROVEMENTS IDENTIFIED 		

 <p>KSC SHUTTLE OPERATIONS</p>	<p>PRE-LAUNCH ACTIVITIES TEAM</p>	<p>NAME: T. UTSMAN ORG: DDAIF DATE: JUNE 12, 1986</p>
<p><u>FINDING:</u> THE WORK CONTROL DOCUMENTATION SYSTEM REQUIRES REVISION</p> <ul style="list-style-type: none"> o WORK CONTROL DOCUMENTATION SYSTEM HAS EVOLVED AS KEY TO VEHICLE CONFIGURATION CONTROL AND PROPER OPERATION <ul style="list-style-type: none"> - PROPER DEFINITION AND AUTHORIZATION OF WORK TO BE PERFORMED - ASSURANCE OF ADEQUATE WORK PERFORMANCE - TRACEABILITY o PROBLEMS UNCOVERED WITH WORK AUTHORIZATION DOCUMENTS <ul style="list-style-type: none"> - LACK OF TIMELY CLOSURE - POOR ANNOTATION OF DEVIATION STEPS - LACK OF TRACEABILITY - MISSING SIGNATURES - MISSING QUALITY CONTROL STAMPS (.25%) o SYSTEM REVIEW/REVISION INITIATED o COMPLIANCE TO BE ENHANCED <ul style="list-style-type: none"> - 'USER FRIENDLY' - TRAINING (EMPHASIS ON IMPORTANCE) - DISCIPLINE 		

 KSC SHUTTLE OPERATIONS	PRE-LAUNCH ACTIVITIES TEAM	NAME: T. UTSMAN
		ORIG. DDATE DATE: JUNE 12, 1986
<p>FINDING: LAUNCH COMPLEX 39B REQUIRES ADDITIONAL MODIFICATION</p> <ul style="list-style-type: none"> o AS ANTICIPATED, MODIFICATIONS TO CORRECT MINOR OPERATING PROBLEMS FOLLOWING FIRST USE WERE IDENTIFIED o PAD WATER SYSTEMS/FREEZE PLAN - DEFINITION OF MODIFICATIONS UNDERWAY o ADDITIONAL PAD "HARDENING" - DETAILED DESCRIPTIONS OF DAMAGE RECORDED DURING POST LAUNCH WALKDOWNS - 216 ITEMS (PANEL COVERS, CABLE TRAY COVERS, DOORS.....) CANDIDATES FOR HARDENING MODIFICATIONS o PAD A AND PAD B SYSTEM DIFFERENCES ARE BEING REVIEWED TO MINIMIZE PROCESSING PROBLEMS ENCOUNTERED DURING 51-L FLOW 		

 <p>KSC SHUTTLE OPERATIONS</p>	<p>PRE-LAUNCH ACTIVITIES TEAM</p>	<p>NAME: T. UTSMAN ORG: DDATE DATE: JUNE 12, 1986</p>
<p><u>FINDING:</u> MANPOWER LIMITATIONS DUE TO HIGH WORKLOAD CREATED SCHEDULING DIFFICULTIES AND CONTRIBUTED TO OPERATIONAL PROBLEMS</p> <ul style="list-style-type: none"> 0 HIGH WORKLOAD <ul style="list-style-type: none"> - FOUR ORBITERS - COMPLETION OF LAUNCH COMPLEX 39B - 'CANNIBALIZATION' OF PARTS - MULTIPLE LAUNCH ATTEMPTS (E.G., STS 61-C) 0 INCREASED TEST ACTIVITY COMPOUNDED SKILL DEMANDS <ul style="list-style-type: none"> - TEST CONDUCTORS - SENIOR ENGINEERS 0 MANPOWER INCREASE FOR SHORT-TERM CHALLENGE NOT WARRANTED 0 CURRENT PLANNING UNDERWAY TO MINIMIZE MANPOWER/SKILL MIX IMPACTS 		

 KSC SHUTTLE OPERATIONS	PRE-LAUNCH ACTIVITIES TEAM	NAME: T. UTSMAN
		REG. DDATE DATE: JUNE 12, 1986
<p><u>FINDING:</u> TEST TEAM ERRORS WERE FOUND THAT WERE CAUSED BY NOT FOLLOWING ESTABLISHED PROCEDURES</p> <ul style="list-style-type: none"> o MOST RELATED TO WORK CONTROL DOCUMENTATION SYSTEM - PREVIOUSLY DISCUSSED o NOT FOLLOWING STANDARD PRACTICE CAN PRODUCE SERIOUS ERRORS THAT GO UNDETECTED <ul style="list-style-type: none"> - MOST SIGNIFICANT - LH₂ ORBITER TO ET DISCONNECT VALVE OPENED - DID NOT FOLLOW STEPS REQUIRED BY DOCUMENTATION - FAILED TO RECORD OCCURRENCE LEADING TO LACK OF PROPER ASSESSMENT PRIOR TO LAUNCH o A PROGRAM WILL BE INITIATED TO <ul style="list-style-type: none"> - STRESS SERIOUSNESS OF ERRORS - REINFORCE THE NEED TO REPORT PROBLEMS ENCOUNTERED - IDENTIFY METHODS TO REDUCE INCIDENTS OF HUMAN ERROR 		

 <p>KSC SHUTTLE OPERATIONS</p>	<p>PRE-LAUNCH ACTIVITIES TEAM</p>	<p>NAME: T. UTSMAN ORG: DDATE DATE: JUNE 12, 1986</p>
<p><u>FINDING:</u> THE TEST REQUIREMENTS SYSTEM NEEDS REVISION</p> <ul style="list-style-type: none"> o OPERATIONS AND MAINTENANCE REQUIREMENTS SPECIFICATIONS DOCUMENTS ARE FLOW UNIQUE o CONTINGENCIES (E.G., COMPONENT REPLACEMENT) ALSO GENERATE NON-STANDARD OPERATIONAL/TEST REQUIREMENTS o PRESENT OPERATIONAL SCHEDULING PROCEDURES DO NOT ASSURE THAT REQUIRED TESTING IS ACCOMPLISHED IN A WELL-PLANNED FASHION o EFFORT HAS BEEN INITIATED TO CORRECT EXISTING OPEN LOOP TEST REQUIREMENT PLANNING SYSTEM 		

 KSC SHUTTLE OPERATIONS	PRE-LAUNCH ACTIVITIES TEAM	NAME: T. UTSMAN
		ORIG. DDATF DATE: JUNE 12, 1986
<p><u>FINDING:</u> THE ORBITER LOGISTICS SYSTEM SUPPORTING 51-L WAS INADEQUATE, CAUSING SIGNIFICANT LRU "CANNIBALIZATION"</p> <ul style="list-style-type: none"> o 45 OUT OF 300 PARTS REQUIRED FOR 51-L WERE "CANNIBALIZED" o OPERATIONAL IMPACTS RESULTING FROM "CANNIBALIZATION": <ul style="list-style-type: none"> - SIGNIFICANT INCREASE IN EFFORT DUE TO MULTIPLE INSTALLATION AND RETEST (BOTH VEHICLES) - SCHEDULE DISRUPTION - ADDED WORK AND PART UNAVAILABILITY - ADDITIONAL PHYSICAL ACTIVITY RESULTS IN INCREASED POTENTIAL FOR DAMAGE o EVALUATION OF METHODS TO MINIMIZE "CANNIBALIZATION" ARE UNDERWAY 		

 KSC SHUTTLE OPERATIONS	PRE-LAUNCH ACTIVITIES TEAM	NAME: T. UTSMAN
		ORIG. DDATE DATE: JUNE 12, 1986
<p><u>FINDING:</u> ADDITIONAL ANALYSIS WILL BE REQUIRED TO ASSESS THE ENVIRONMENTAL EFFECTS UPON LAUNCH CAPABILITY</p> <ul style="list-style-type: none"> o SOME LAUNCH COMPLEX 39R SYSTEMS PERFORMANCE MARGINAL DURING 51-L DUE TO BELOW FREEZING TEMPERATURES o LOW OPERATING TEMPERATURE EFFECTS ON SRR JOINTS NOT FULLY UNDERSTOOD o EXISTING INSTRUMENTATION AND ANALYTICAL MODELS NOT ADEQUATE TO DEFINE OPERATING ENVIRONMENT o IMPROVED VEHICLE AND FACILITY ENVIRONMENTAL ASSESSMENT CAPABILITY IS REQUIRED 		

 <p>KSC SHUTTLE OPERATIONS</p>	<p>PRE-LAUNCH ACTIVITIES TEAM</p>	<p>NAME: T. UTSMAN</p>
		<p>ORGI: DDATF</p> <p>DATE: JUNE 12, 1986</p>
<p>FINDING: ICE DEBRIS WAS GREATER THAN PREDICTED</p> <ul style="list-style-type: none"> o PRE-LAUNCH AERODYNAMIC ANALYSIS OF ICE TRAJECTORIES ACCOUNTED FOR <ul style="list-style-type: none"> - DRAG RETARDATION - LATERAL WIND VELOCITIES o PREDICTION METHODS DID NOT INCLUDE <ul style="list-style-type: none"> - EFFECTS OF PLUME ASPIRATION - PARTICLE REBOUND OFF MLP o PHOTOGRAPHIC DOCUMENTATION REVEALED <ul style="list-style-type: none"> - ICE RELEASED FROM RSS/FSS AFTER SSME IGNITION - ICE TRANSLATED FURTHER TOWARD VEHICLE THAN PREDICTED - SOME ICE IMPACTED LEFT HAND SRB - NO OBSERVED IMPACT TO ET OR CHALLENGER o ACCURATE PREDICTIONS OF ICE TRAJECTORIES REQUIRE CONSIDERATION OF ASPIRATION AND BETTER ICE RELEASE TIME ANALYSIS 		

 <p>KSC SHUTTLE OPERATIONS</p>	<p>PRE-LAUNCH ACTIVITIES TEAM</p>	<p>NAME: T. UTSMAN ORG: DDA/TF DATE: JUNE 12, 1986</p>
<p><u>FLIGHT READINESS REVIEW PROCESS</u></p> <ul style="list-style-type: none"> 0 ANALYZED THE POLICY, PROCEDURES, AND PLANS ASSOCIATED WITH THE STRUCTURED FLIGHT READINESS REVIEW AND CERTIFICATION PROCESS 0 EVALUATED THE 51-L FLIGHT READINESS REVIEW AND CERTIFICATION PROCESS, INCLUDING THE MISSION MANAGEMENT TEAM ACTIVITIES IMMEDIATELY PRECEDING LAUNCH 0 ADDRESSED SPECIFIC FLIGHT SAFETY ISSUES (SRM O-RING TEMPERATURE AND ICE DEBRIS CONCERNS) AS APPLIED TO THE FRR DECISION MAKING PROCESS 0 DOCUMENTED FINDINGS 		

 KSC SHUTTLE OPERATIONS	PRE-LAUNCH ACTIVITIES TEAM	NAME: T. UTSMAN
		ORG. DDATE DATE: JUNE 12, 1986
<p><u>FINDING:</u> THE 51-L FLIGHT READINESS REVIEW (FRR) PROCESS, INCLUDING THE MISSION MANAGEMENT TEAM (MMT) ACTIVITIES IMMEDIATELY PRIOR TO LAUNCH, WAS CONDUCTED CONSISTENT WITH NSTS FLIGHT CERTIFICATION POLICIES, PROCEDURES AND PRACTICES</p> <ul style="list-style-type: none"> o THE NSTS FRR PROCESS IS A DERIVATIVE OF NASA'S MANNED SPACEFLIGHT HISTORY o THE NSTS FRR PROCESS IS STRUCTURED TO ALLOW EFFECTIVE MANAGEMENT OF TECHNICAL MATTERS o 51-L FRR ACTIVITIES DID NOT DEVIATE FROM PREVIOUSLY CONDUCTED NSTS FRRS 		

 <p>KSC SHUTTLE OPERATIONS</p>	<p>PRE-LAUNCH ACTIVITIES TEAM</p>	<p>NAME: T. UTSMAN ORG: DDATE DATE: JUNE 12, 1986</p>
<p><u>FINDING:</u> THE STS 51-L FLIGHT READINESS REVIEW PROCESS DID NOT ADDRESS CRITICAL SRB FLIGHT SAFETY ISSUES</p> <ul style="list-style-type: none"> o FRR PROCESS IS PART OF A TOTAL MANAGEMENT SYSTEM COMPRISED OF MANY REVIEWS, BEGINNING EARLY IN THE DEVELOPMENT PROGRAM o THE ENGINEERING KNOWLEDGE BASE WHICH WAS DEVELOPED WAS INADEQUATE TO SUPPORT THE 51-L LAUNCH DECISION PROCESS o MANAGEMENT TOOLS, INCLUDING CRITICAL ITEMS LIST MANAGEMENT, DID NOT ADEQUATELY PROTECT AGAINST THE STS 51-L INCIDENT o NASA MANAGEMENT SYSTEM MUST BE REVIEWED TO BETTER UNDERSTAND IT'S TOTAL RELATIONSHIP TO THE LAUNCH DECISION PROCESS 		

 <p>KSC SHUTTLE OPERATIONS</p>	<p>PRE-LAUNCH ACTIVITIES TEAM</p>	<p>NAME: T. UTSMAN ORC: DDATE DATE: JUNE 12, 1986</p>
<p><u>FINDING:</u> COMMUNICATION DURING THE LAUNCH DECISION PROCESS WAS INADEQUATE</p> <ul style="list-style-type: none"> o KEY INDIVIDUALS' OBJECTIONS TO LAUNCH WERE NOT REGISTERED TO TOP NASA PROGRAM OFFICIALS - MORTON THIOKOL ENGINEERS CONCERNS DID NOT REACH THE NSTS PROGRAM MANAGER - NSTS PROGRAM MANAGER DID NOT KNOW THE DEPTHS OF THE ROCKWELL CONCERNS FOR ICE DEBRIS, NOR THAT THEY WERE RELATED TO FLIGHT SAFETY o BOTH INSTANCES PRESENT INADEQUATE COMMUNICATIONS AND AN AREA WHERE THE LAUNCH DECISION PROCESS REQUIRES REASSESSMENT 		

 KSC SHUTTLE OPERATIONS	PRE-LAUNCH ACTIVITIES TEAM	NAME: T. UTSMAN
		ORG: DDATE
		DATE: JUNE 12, 1986
<u>PRE-LAUNCH SECURITY</u>		
<ul style="list-style-type: none">0 ASSESSED SECURITY PROCEDURES0 REVIEWED SUPPORT OPERATIONS0 REVIEWED POST LAUNCH ACTIVITIES0 DOCUMENTED FINDINGS		

 <p>KSC SHUTTLE OPERATIONS</p>	<p>PRE-LAUNCH ACTIVITIES TEAM</p>	<p>NAME: T. UTSMAN ORG. DDATE DATE: JUNE 12, 1986</p>
<p><u>FINDING:</u> NO FACTORS CONTRIBUTING TO THE 51-L MISHAP WERE FOUND BY THE SECURITY ASSESSMENT</p> <ul style="list-style-type: none"> 0 PRE-LAUNCH SECURITY PROCEDURES UTILIZED WERE THOROUGHLY REVIEWED AND DETERMINED TO BE ADEQUATE 0 POST LAUNCH ACTIONS TAKEN INCLUDED <ul style="list-style-type: none"> - CLOSING SECURITY AREAS - IMPOUNDMENT OF RECORDS - SECURITY SEARCH OF LAUNCH AREA - INVESTIGATIVE ACTIVITIES 0 THE INQUIRY FOLLOWING THE ACCIDENT HAS NOT REVEALED ANY INFORMATION INDICATING THAT ANY INDIVIDUAL DELIBERATELY PERFORMED ANY MALEVOLENT ACT WHICH CONTRIBUTED TO THE 51-L MISHAP 		

 <p>KSC SHUTTLE OPERATIONS</p>	<p>PRE-LAUNCH ACTIVITIES TEAM</p>	<p>NAME: T. UTSMAN ORG: DDATE DATE: JUNE 12, 1986</p>
<p><u>FINDINGS:</u> METHODS TO IMPROVE NATIONAL RESOURCE PROTECTION (NRP) SHOULD BE REVIEWED</p> <ul style="list-style-type: none"> o THE EXISTING PRE-LAUNCH SECURITY SYSTEM IS PREDOMINANTLY DEPENDENT ON MANPOWER o MANPOWER INTENSIVE PROGRAMS DO NOT PROTECT AGAINST ALL THREATS POSTULATED AT KSC o THE PLANNING FOR IMPLEMENTATION OF NRP UPGRADES SHOULD BE REVIEWED 		

NASA

Johnson Space Center

**STS-51L DATA AND DESIGN ANALYSIS TASK FORCE
PHOTOGRAPHIC AND VIDEO SUPPORT TEAM**

PRESENTATION TO

HOUSE SCIENCE AND TECHNOLOGY COMMITTEE

JUNE 13

D. M. Germany

Vehicle Coordinate System



Johnson Space Center

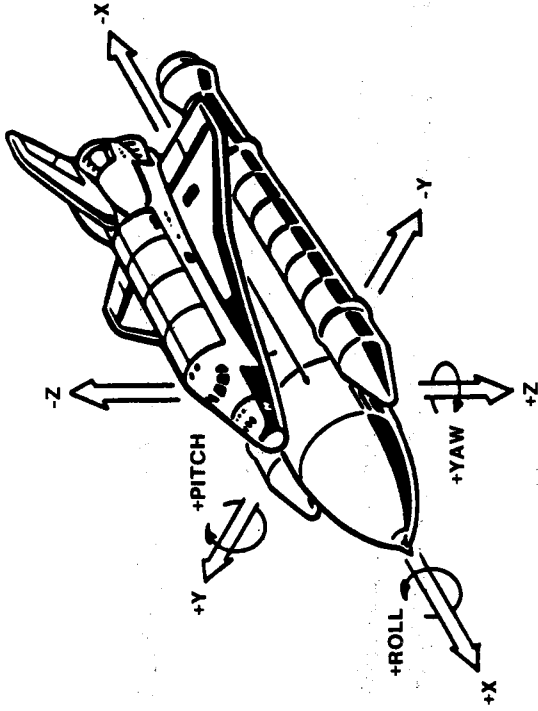



Johnson Space Center

STS 51-L Incident Investigation Integrated Events Timeline

6/04/86 1

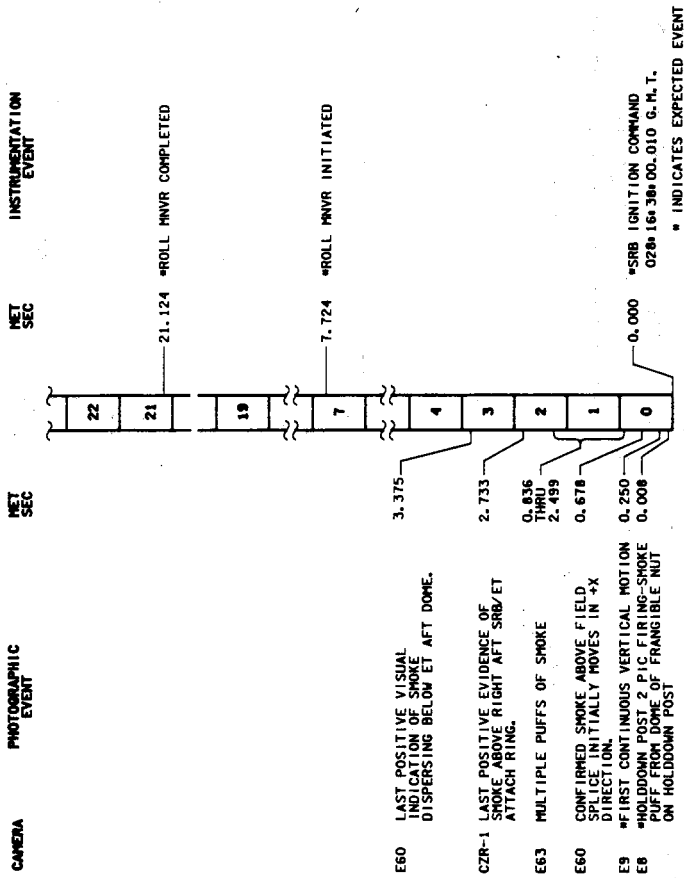



Johnson Space Center

STS 51-L Incident Investigation Integrated Events Timeline

6/04/86 2

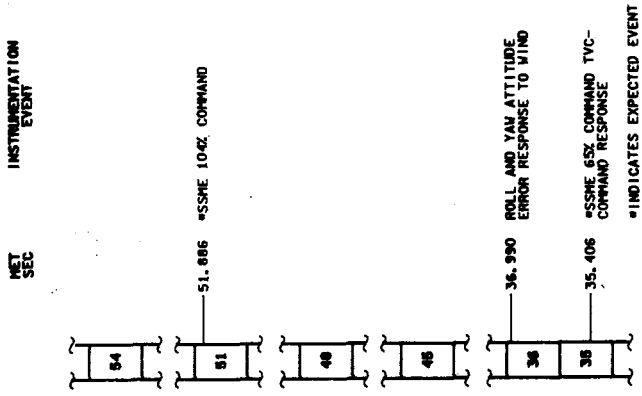



Johnson Space Center

STS 51-L Incident Investigation Integrated Events Timeline

6/04/86 3

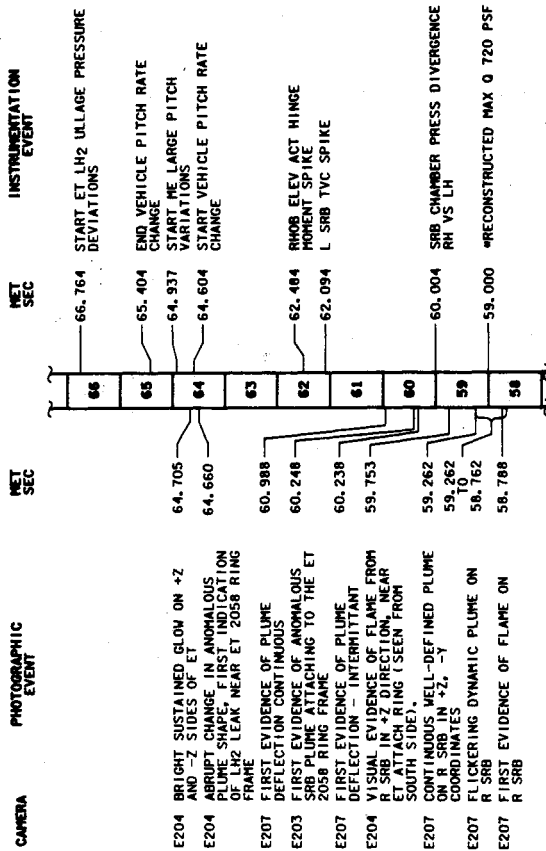

STS 51-L Incident Investigation Integrated Events Timeline

6/04/86 4

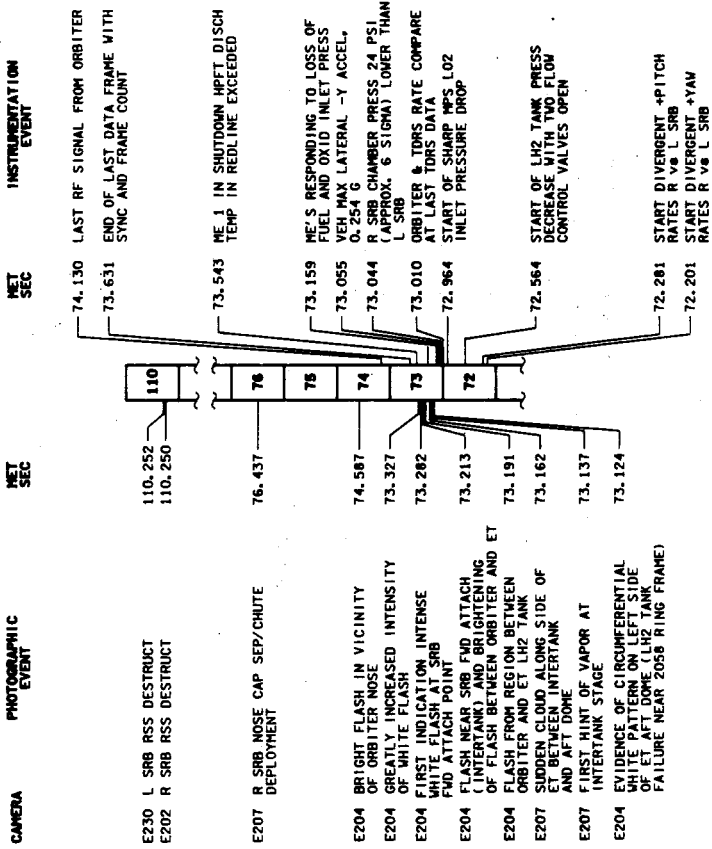

**Briefing For
House Committee On
Science and Technology**

June 12, 1986

DATE: 12 JUNE 86

SEARCH

RECOVERY

RECONSTRUCTION

690

EDWARD O'CONNOR, JR.
COLONEL, U.S. AIR FORCE

SEARCH, RECOVERY AND RECONSTRUCTION TEAM

TASK

- 0 LOCATE AND RECOVER 51-L FLIGHT COMPONENTS
- 0 ANALYZE RECOVERED COMPONENTS TO DEVELOP AN INDEPENDENT ANALYSIS OF FAILURE MODES

SEARCH, RECOVERY AND RECONSTRUCTION TEAM

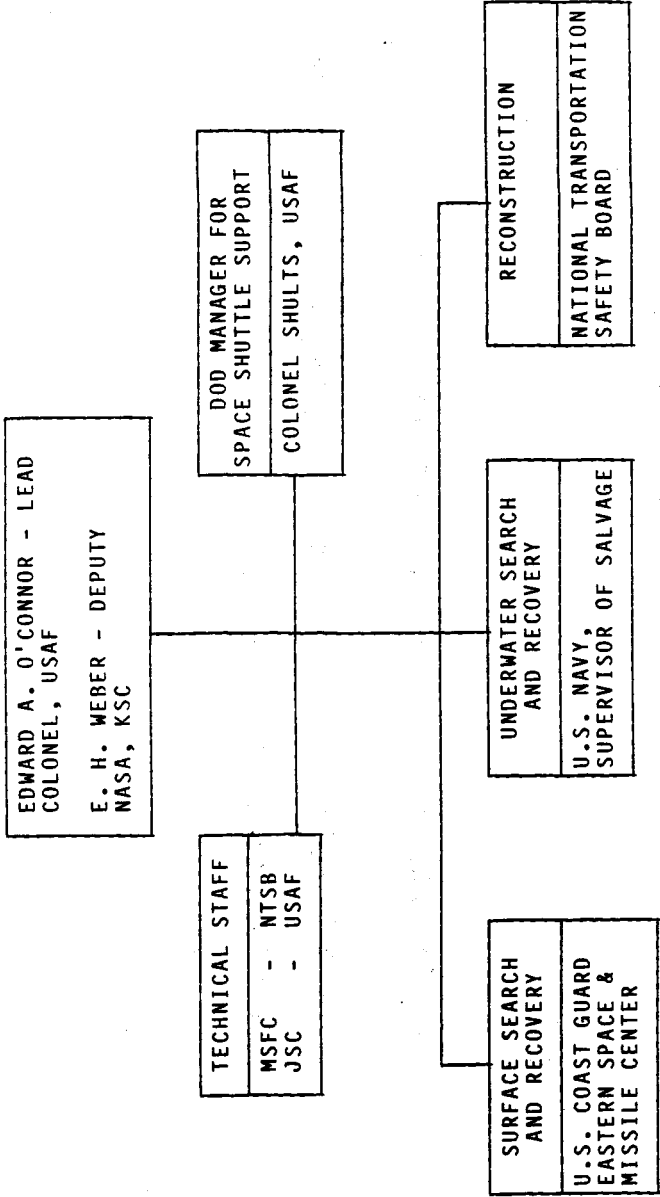

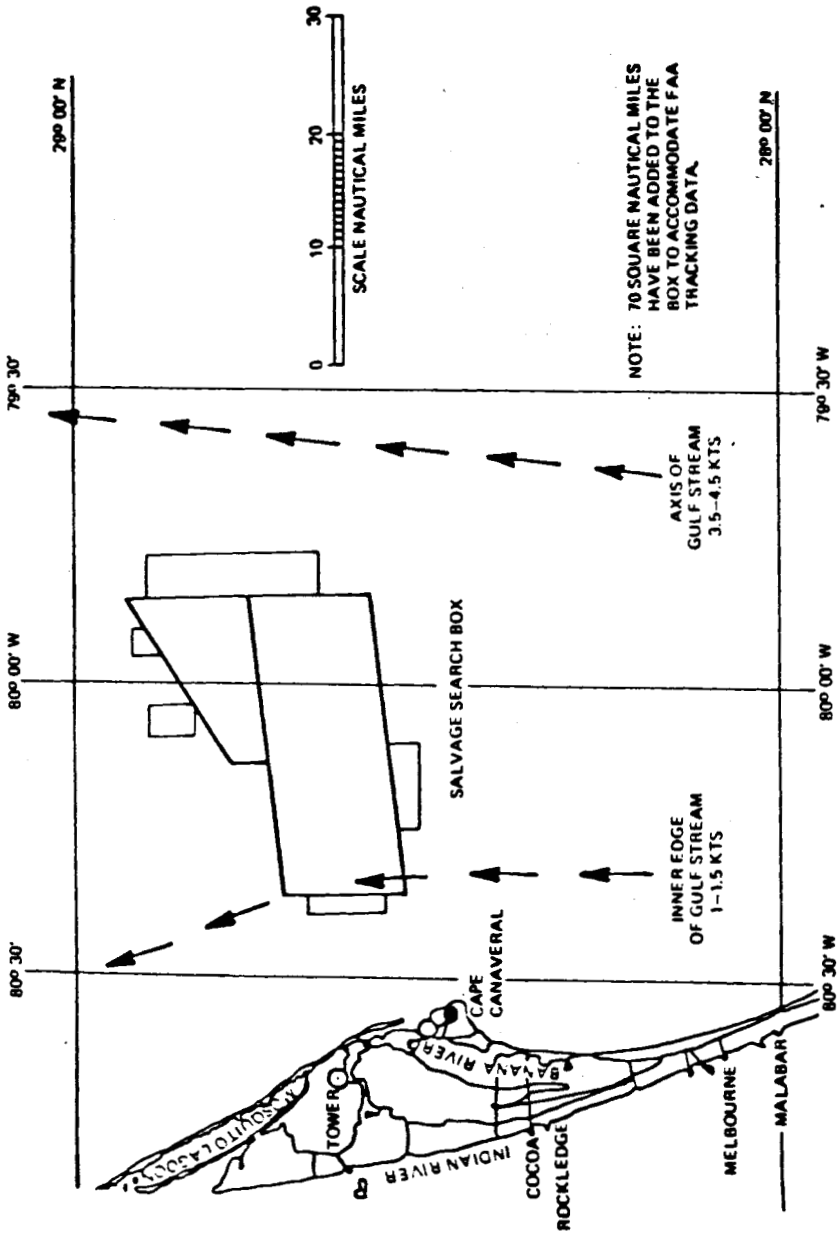

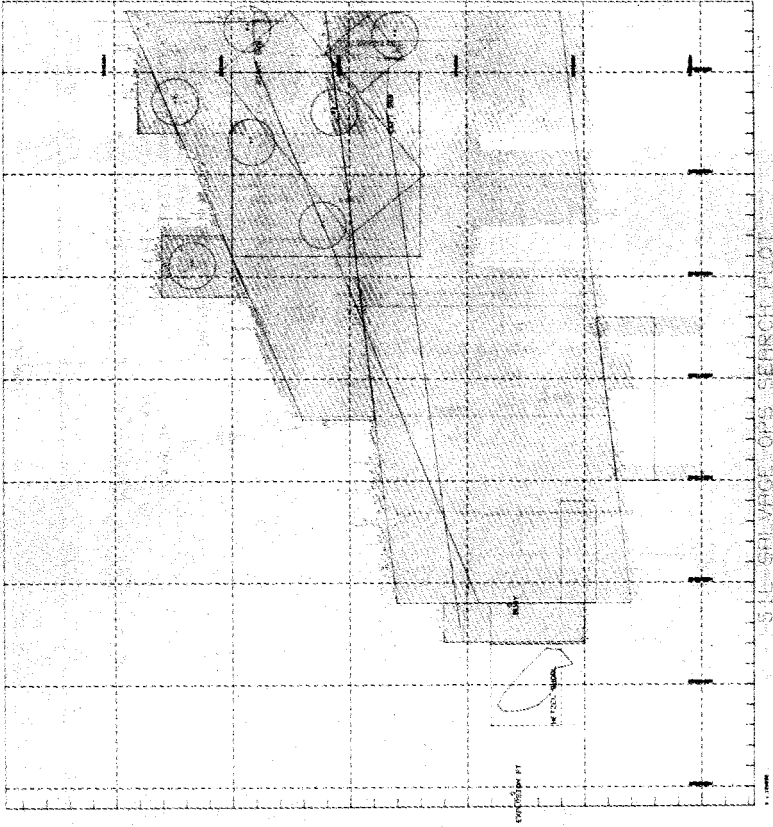

512-501 VACE OPS SEARCHER PL
110855 Jun 88
FOR OFFICIAL USE ONLY

ASSETS FOR SEARCH AND RECOVERY

SHIPS UTILIZED 33

OPERATING SHIP DAYS . . 944

695

AIRCRAFTS UTILIZED 22

SQUARE NAUTICAL MILES SEARCHED 429

MILES OF SONAR SEARCH 8125

SEARCH STATUS

0 SONAR MAPPING COMPLETED

429 SQUARE NAUTICAL MILES SEARCHED

0 CONTACT STATUS

6/12/86

CONTACTS MADE (SONAR) 804

CONTACTS INVESTIGATED 616

SHUTTLE COMPONENTS 120

SHUTTLE COMPONENTS RECOVERED 103

KEY ASSETS FOR RECOVERY OPERATIONS

- 0 SUPERVISOR OF SALVAGE
 - SALVAGE VESSELS WITH DIVERS
 - NUCLEAR RESEARCH SUBMARINE WITH UNDERWATER INVESTIGATIVE CAPABILITY (NR-1)

- 0 HARBOR BRANCH FOUNDATION
 - JOHNSON SEA LINKS I & II
- MANNED SUBMERSIBLES

- 0 STENA WORKHORSE
 - DYNAMICALLY STABILIZED PLATFORM

51-L RECOVERY STATUS

6/12/86

0	OVERALL VEHICLE:	25%
0	ORBITER:	35%
-	- MAIN PROPULSION SYSTEM:	75%
-	- CREW MODULE:	90%
0	INERTIAL UPPER STAGE:	90%
0	TDRSS:	<1%
0	EXTERNAL TANK:	21%
0	SOLID ROCKET BOOSTERS:	50%
0	SPARTAN HALLEY:	95%

51L COMPONENTS RECOVERED

ORBITER

0	PORTION OF FWD, MID & AFT FUSELAGE PANELS	0	PORTION OF VERT STAR
0	ET/ORBITER LO ₂ UMBILICAL	0	MAJORITY OF RIGHT WING
0	RUDDER SPEED BRAKE	0	PORTION OF LH AND RH OMS PODS
0	MAIN LANDING GEAR DOORS	0	NOSE LANDING GEAR
0	BODY FLAP	0	PORTION OF RMS
0	RIGHT ELEVON		
0	PORTION OF PAYLOAD BAY DOORS	<u>ET</u>	
0	PORTION OF PAYLOAD BAY RADIATORS	0	40-50% OF INTER TANK SKIN
0	LOWER SKIN PANELS	0	<1% OF LO ₂ TANK
0	PORTION OF AFT THRUST STRUCTURE	0	10-12% OF LH ₂ TANK
0	PORTION OF 3 MAIN ENGINES	0	NOSE CONE SKIN
0	PORTION OF BASE HEAT SHIELD	0	PORTION OF LO ₂ FEEDLINE
0	RIGHT AFT SIDE WALL	0	MAJORITY OF RANGE SAFETY
0	PORTION OF CREW MODULE		DESTRUCTION SYSTEM

51L COMPONENTS RECOVERED

SOLID ROCKET BOOSTERS

RIGHT HAND COMPONENTS

0 AFT SKIRT ASSEMBLY
0 FRUSTUM
0 PARACHUTE ASSEMBLY
0 SOLID ROCKET MOTOR CASE FRAGMENTS

LEFT HAND COMPONENTS

0 FRUSTUM
0 PARACHUTE ASSEMBLY
0 SOLID ROCKET MOTOR CASE FRAGMENTS

700

TOTAL WRECKAGE RECOVERED - 215,000 LBS.

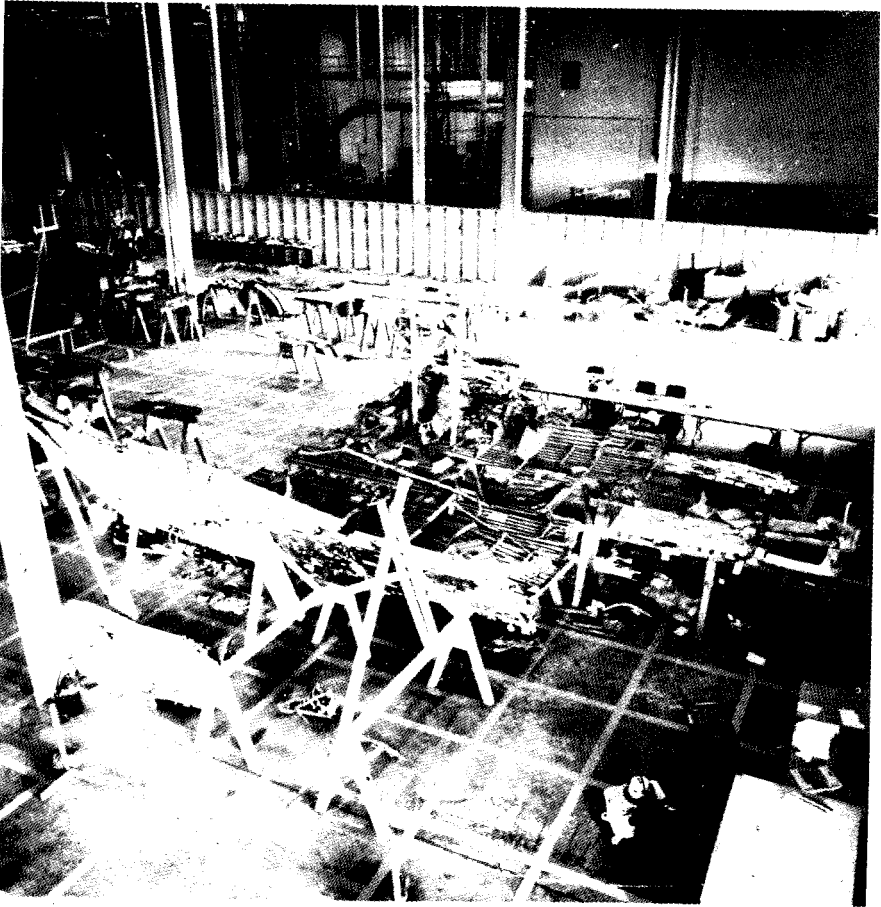

Orbiter Wreckage Layout

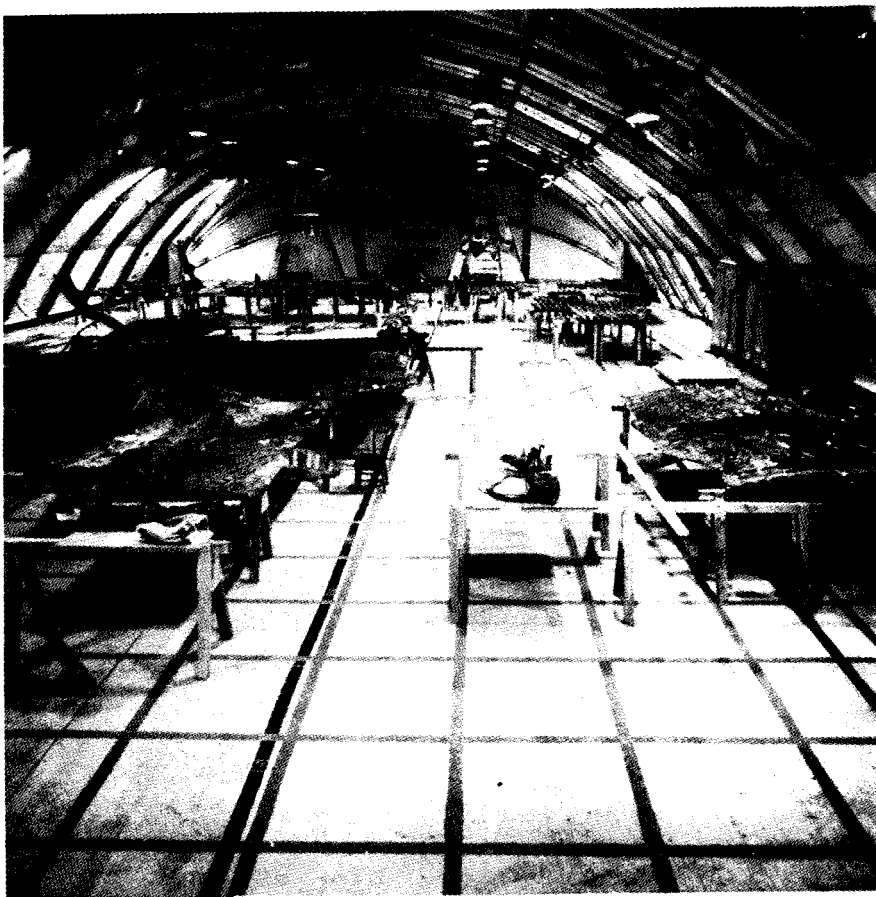

External Tank Wreckage Layout

RIGHT SOLID ROCKET BOOSTER RECOVERED COMPONENTS

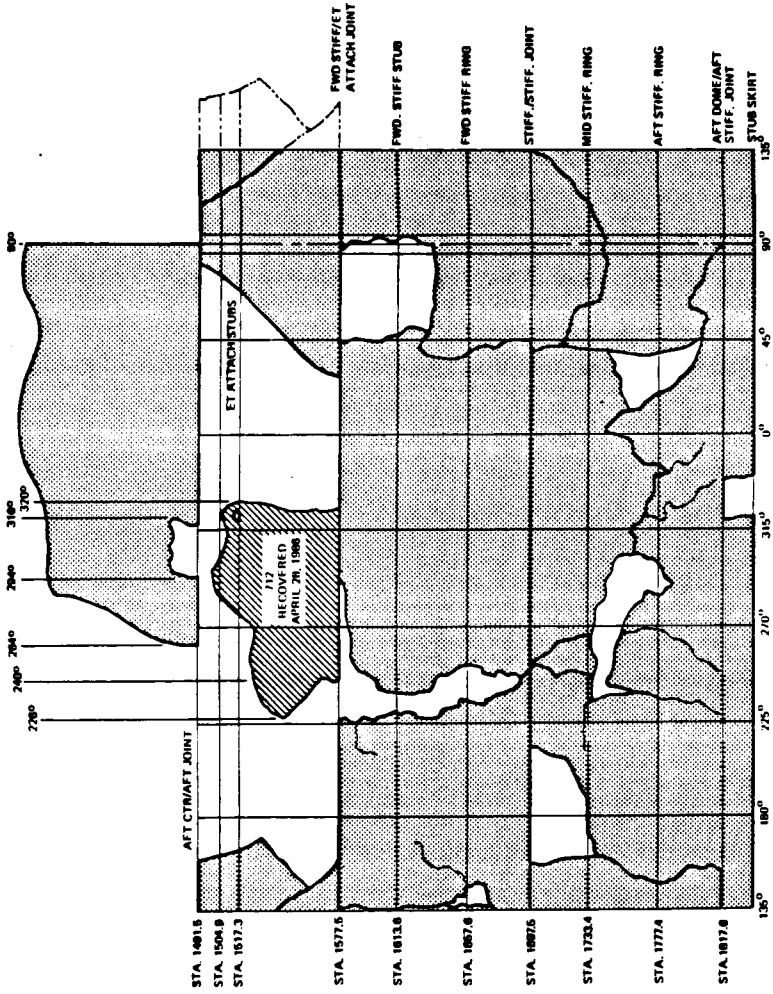

INSIDE VIEW
 RH SRB RECOVERED DEBRIS
 AFT SEGMENT

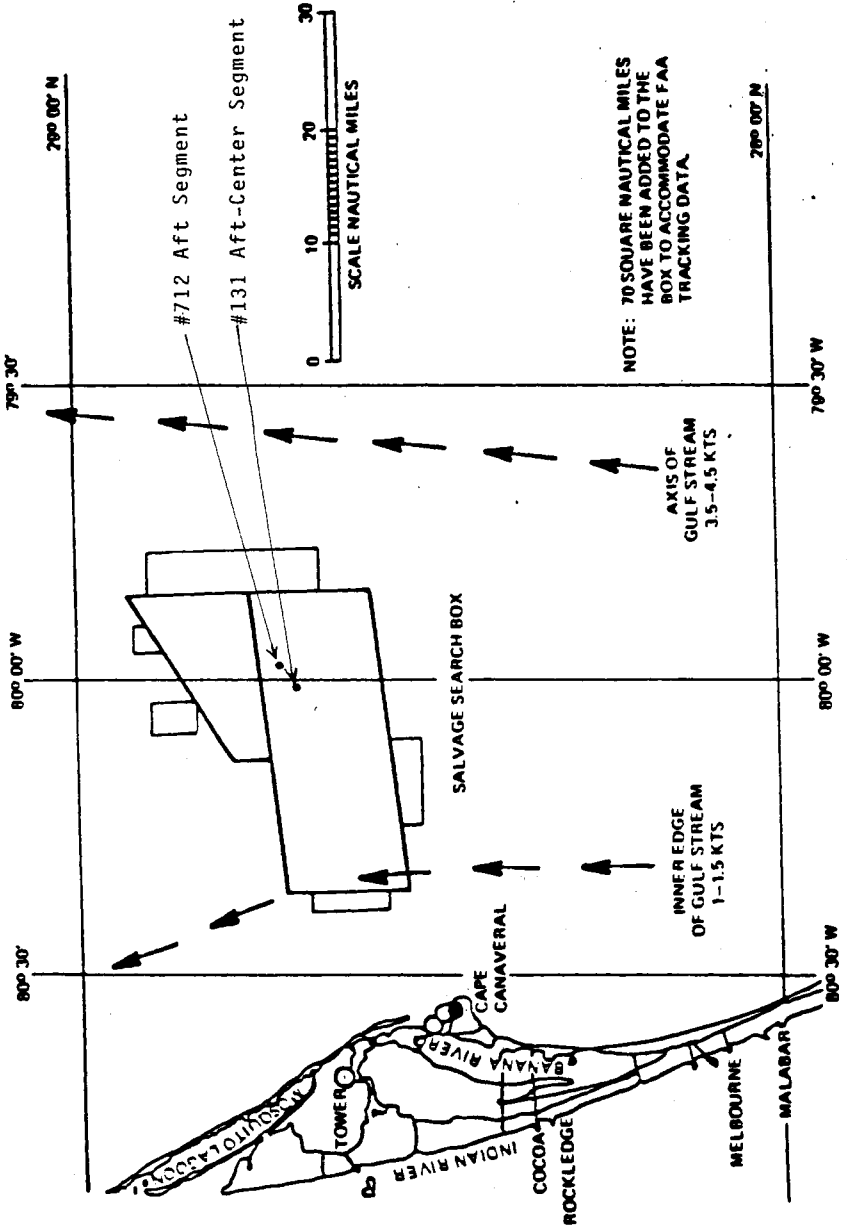

IDENTIFICATION OF FAILED RIGHT HAND SRM AFT CENTER SEGMENT

RIGHT HAND SOLID ROCKET MOTOR AFT CYLINDER; AFT CENTER SEGMENT (CONTACT 131)

706

- 0 PART NUMBER AND SERIAL NUMBER FOUND ON THE EXTERIOR SURFACE OF THE PART
- 0 BURNED OUT AREA WAS CONSISTENT WITH PHOTOGRAPHIC DATA (294° TO 316°)
- 0 CIRCUMFERENTIAL LOCATION WAS DETERMINED BY THE 0° ALIGNMENT SLOT ON THE TANG.



Right Hand SRM Segment
Showing Erosion From Hot
Propellant Gas (Upper Section)

IDENTIFICATION OF FAILED RIGHT HAND SRM AFT SEGMENT

RIGHT HAND SOLID ROCKET MOTOR ATTACH SEGMENT; AFT SEGMENT (CONTACT 712)

0 BUSHINGS FOUND INSTALLED IN THE AFT ATTACH STUB HOLES LOCATED AT 268 AND 269 DEGREES WERE TRACED THROUGH MANUFACTURING RECORDS. RECORDS INDICATED THAT BUSHINGS WERE USED TO REPAIR HOLES AT THE EXACT LOCATION AS FOUND ON THE RECOVERED PARTS

0 BURNED OUT AREA WAS CONSISTENT WITH PHOTO EVIDENCE (291° TO 318°)

0 CIRCUMFERENTIAL LOCATION WAS DETERMINED BY RELATIONSHIP BETWEEN UNMARKED ALIGNMENT SLOT IN THE TANG TO A UNIQUE HOLE PATTERN IN THE AFT ATTACH STUB. RELATIONSHIP PROVED THAT THE TANG ALIGNMENT SLOT WAS LOCATED AT 240°

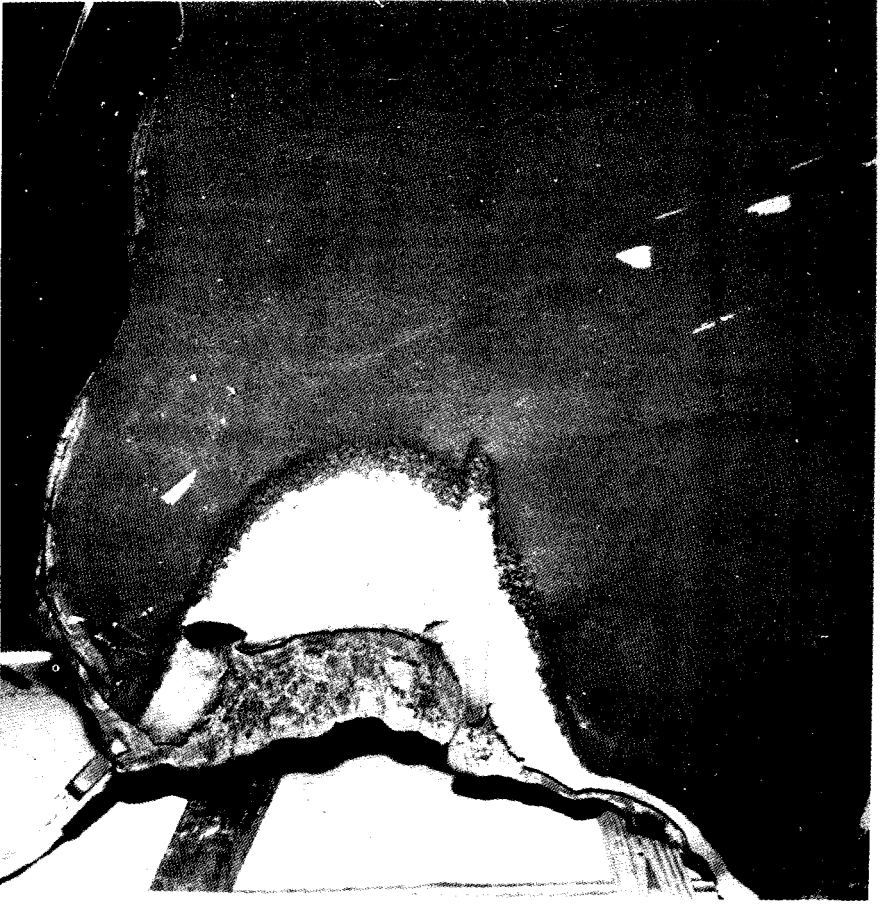

Right Hand SRM Segment
Showing Erosion From Hot
Propellant Gas (Lower Section)

RECOVERED SOLID ROCKET MOTOR ANALYSIS

CONCLUSIONS

0 LOCATION OF BURN-THROUGH CONSISTENT WITH FAILURE IN AREA OF RIGHT HAND SOLID ROCKET MOTOR AFT CENTER SEGMENT TO AFT SEGMENT FIELD JOINT.

0 NO EVIDENCE OF ANOMALOUS OPERATION IN OTHER AREAS OF LEFT HAND OR RIGHT HAND SOLID ROCKET MOTORS HAS BEEN IDENTIFIED.

0 INITIATING CAUSE OF BURN-THROUGH IN FIELD JOINT AREA CAN NOT BE DETERMINED FROM RECOVERED HARDWARE.

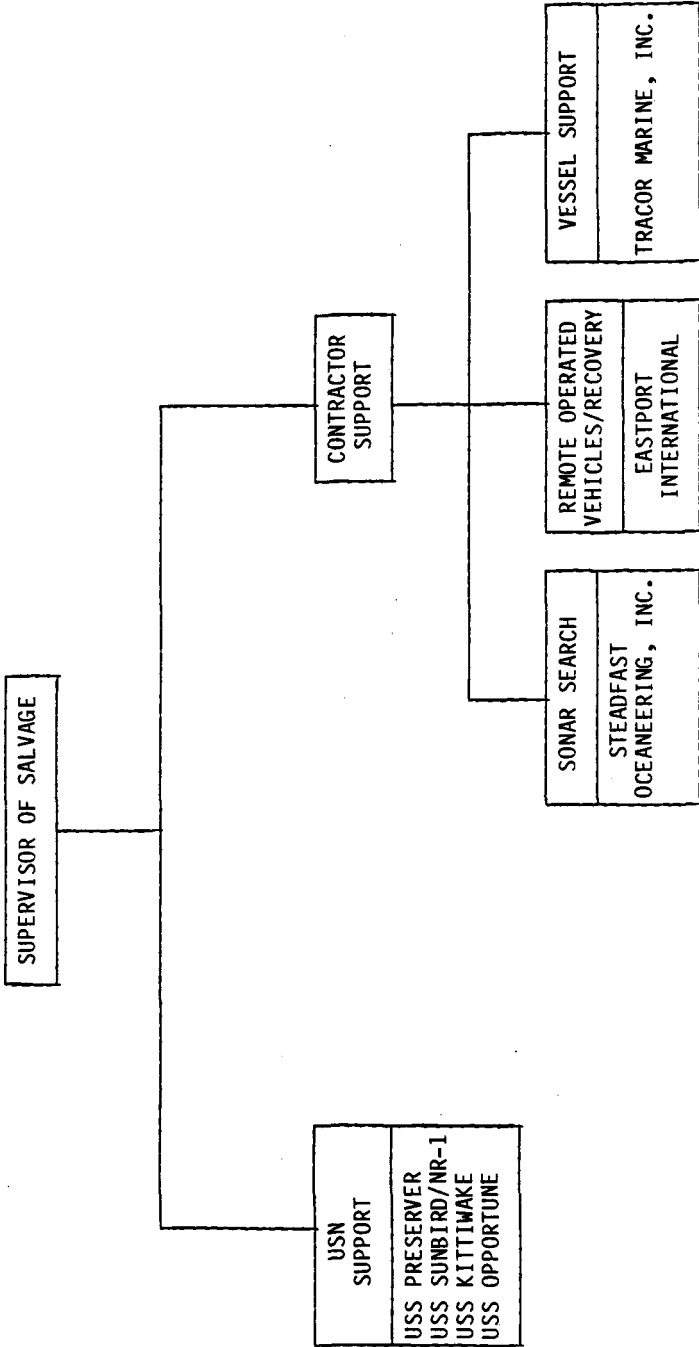

SUPERVISOR OF SALVAGE

THE FOLLOWING SALVAGE ASSETS ARE AVAILABLE WORLD WIDE FOR IMMEDIATE
RESPONSE UNDER DIRECTION OF THE SUPERVISOR OF SALVAGE (USN)

- ALL FLEET ASSETS -
- 0 SALVAGE VESSELS
 - AIR AND MIXED GAS DIVING CAPABILITY
 - SATURATION DIVING CAPABILITY
- 0 NR-1
 - LONG DURATION SAR CAPABILITY

- CONTRACTOR ASSETS -
- 0 SIDE SCAN SONAR SEARCH SYSTEMS AND ANALYSIS
- 0 PRECISION NAVIGATION SYSTEMS (GPS)
- 0 REMOTE OPERATED VEHICLES (ROVs)
- 0 EMERGENCY SHIP SALVAGE MATERIAL (ESSM) POOL

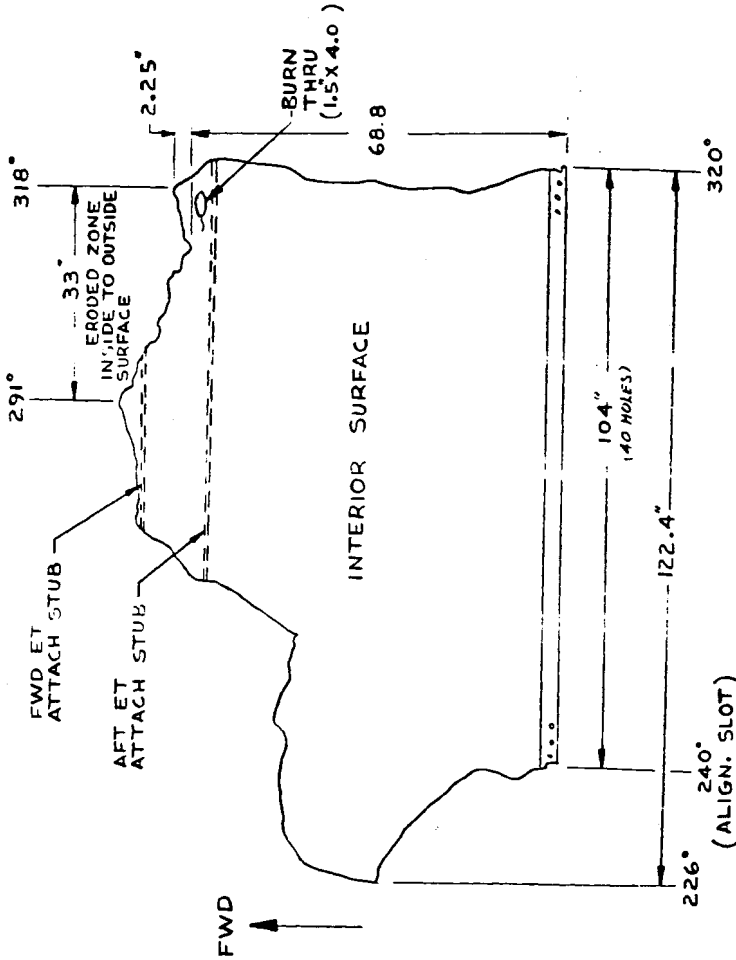

CONTACT # 712
 ATTACH SEGMENT
 P/N U50716-02
 S/N 000005R2

 <p>NASA Lyndon B. Johnson Space Center MISSION OPERATIONS DIRECTORATE</p>	<p>SUBJECT:</p>	<p>NAME: DAB/T. W. HOLLOWAY</p> <p>DATE: JUNE 12, 1986</p> <p>PAGE 1</p>
<p style="text-align: center;">MISSION PLANNING AND OPERATIONS TEAM</p>		

 <p>NASA Lyndon B. Johnson Space Center MISSION OPERATIONS DIRECTORATE</p>	<p>SUBJECT:</p>	<p>NAME: DAB/T. W. HOLLOWAY</p> <p>DATE: JUNE 12, 1986</p> <p>PAGE 2</p>
--------------------------------------------------------------------------------------------------------------------------------------------------------------------------------------	-----------------	-----------------------------------------------------------------------------------------------------------

**PRESIDENTIAL COMMISSION
ON THE
SPACE SHUTTLE CHALLENGER ACCIDENT**

**MEMBERS:
DR. RIDE*
MR. RUMMEL
MR. HOTZ
MR. ACHESON
*TEAM LEADER**

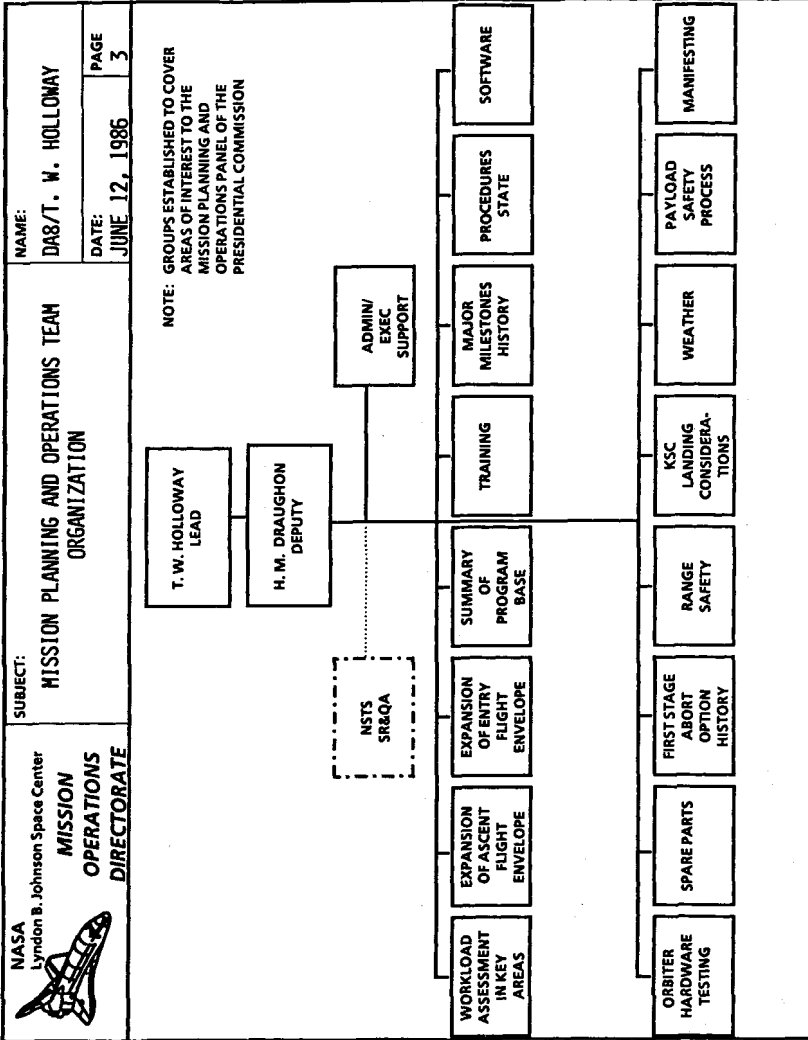



 <p>NASA Lyndon B. Johnson Space Center MISSION OPERATIONS DIRECTORATE</p>	<p>SUBJECT: MEETINGS OF MPOT WITH MPOF OF THE PRESIDENTIAL COMMISSION</p>	<p>NAME: DAB/T. W. HOLLOWAY</p> <p>DATE: JUNE 12, 1986</p> <p>PAGE 4</p>
<ul style="list-style-type: none"> ● MARCH 11, 1986 - GENERAL; STS 51-L PREPARATION; ABORT MODES ● MARCH 12, 1986 - SAFETY; MANIFESTING ● MARCH 20, 1986 - PLANNING AND SCHEDULES ● MARCH 24, 1986 - RANGE SAFETY; MILESTONE HISTORY; WEATHER FLIGHT RULES; RTLS RAIN DAMAGE ASSESSMENT ● MARCH 25, 1986 - SSME FAILURE CONTAINMENT, SR & QA ● MARCH 31, 1986 - TESTING; OPERATIONS BASE; PAYLOAD SAFETY; TRAINING; CREW PROCEDURES ● APRIL 7, 1986 - MSFC SR & QA (AT MSFC) ● APRIL 8, 1986 - WORKLOAD ASSESSMENT; SOFTWARE, MANIFESTING ● APRIL 9, 1986 - LANDING CONSIDERATIONS ● APRIL 14, 1986 - ASCENT ENVELOPE, FIRST STAGE ABORT OPTION HISTORY ● APRIL 15, 1986 - SR & QA 		

 <p>NASA Lyndon B. Johnson Space Center MISSION OPERATIONS DIRECTORATE</p>	<p>SUBJECT: HPOT PRELIMINARY REPORT CONTENT</p>	<p>NAME: DAB/T. W. HOLLOWAY</p> <p>DATE: JUNE 12, 1986</p> <p>PAGE 5</p>
<ul style="list-style-type: none"> ● BASE REPORT (FINDINGS/CONCLUSIONS) <ul style="list-style-type: none"> • SUMMARY NARRATIVE AND OTHER ADMINISTRATIVE FRONT MATERIAL • STS 51-L MISSION PLANNING AND PREPARATIONS (8/0) • STS 51-L MISSION OPERATIONS (5/0) • NSTS MISSION PLANNING (8/1) • NSTS MISSION OPERATIONS (12/6) • NSTS FLIGHT RATE AND FLIGHT SCHEDULING (11/3) • MAJOR FINDINGS AND CONCLUSIONS (11/4) ● APPENDICES <ul style="list-style-type: none"> • RANGE SAFETY REPORT • KSC LANDING CONSIDERATIONS REPORT • CREW ESCAPE SYSTEMS REPORT • ORBITER MAINTENANCE/INSPECTION SYSTEMS SUMMARY • EXECUTIVE SUMMARY OF FLIGHT SOFTWARE REVIEW • FLIGHTCREW INVOLVEMENT IN THE SPACE SHUTTLE PROGRAM • STS 51-L FLIGHT OPERATIONS TEAM SUMMARY REPORT 		

 <p>NASA Lyndon B. Johnson Space Center MISSION OPERATIONS DIRECTORATE</p>	<p>SUBJECT: MAJOR FINDINGS AND CONCLUSIONS</p>	<p>NAME: DAB/T. W. HOLLOWAY</p> <p>DATE: JUNE 12, 1986</p> <p>PAGE: 6</p>
<ul style="list-style-type: none"> • MAJOR FINDINGS <ul style="list-style-type: none"> • STS 51-L MISSION PLANNING AND PREPARATIONS <ul style="list-style-type: none"> - STS 51-L MANIFESTING, MISSION OPERATIONS, FLIGHTCREW PREPARATIONS, PRELAUNCH, AND LAUNCH WERE TYPICAL AND SATISFACTORY AND HAD NO EFFECT ON THE ACCIDENT • STS 51-L MISSION OPERATIONS <ul style="list-style-type: none"> - THERE WAS NO ACTION POSSIBLE THAT COULD HAVE RESULTED IN SURVIVAL OF THE STS 51-L CREW - THE RANGE SAFETY SYSTEM (RSS) DID NOT CONTRIBUTE TO THE ACCIDENT. THE ACTIONS OF THE RANGE SAFETY OFFICER WERE APPROPRIATE. A JOINT NASA/DOD REVIEW OF THE RSS IS APPROPRIATE AND PLANNED • NSTS MISSION PLANNING <ul style="list-style-type: none"> - THE OPERATIONS MAINTENANCE INSPECTION PROGRAM IS IMMATURE AND DOES NOT PROVIDE LEVEL II WITH ADEQUATE CLOSED LOOP OVERSITE. IT LACKS A COMPREHENSIVE SYSTEM TO TRACK AND AUDIT COMPLIANCE WITH ESTABLISHED REQUIREMENTS • NSTS MISSION OPERATIONS <ul style="list-style-type: none"> - THE CURRENT PROGRAM COMMITMENTS PRECLUDE DEVOTING ADEQUATE RESOURCES TO DEVELOPING A CAPABILITY TO SUPPORT AN INCREASED FLIGHT RATE 		

<p>NASA Lyndon B. Johnson Space Center</p>  <p>MISSION OPERATIONS DIRECTORATE</p>	<p>SUBJECT: MAJOR FINDINGS AND CONCLUSIONS (CON'T)</p>	<p>NAME: DA8/T. W. HOLLOWAY</p>	<p>DATE: JUNE 12, 1986</p> <p>PAGE 7</p>
<p>- AT THE TIME OF THE STS 51-L LAUNCH, KSC LANDINGS DID NOT CONSTITUTE AN UNREASONABLE SAFETY OF FLIGHT RISK BASED ON KNOWN FAILURES</p> <p>- STATISTICAL WEATHER AND FORECASTING UNCERTAINTIES HAVE RESULTED IN SEVERAL WEATHER WAIVE-OFFS AND DICTATE A NEED FOR MULTIPLE LANDING SITES FOR END-OF-MISSION</p> <p>- THE CURRENT LANDING AND DECELERATION SYSTEMS HAVE NOT DEMONSTRATED AN ADEQUATE MARGIN FOR ROUTINE KSC AND TAL ABORT OPERATIONS</p> <p>- THE PROGRAM CONSIDERED CREW ESCAPE NUMEROUS TIMES BUT BECAUSE OF LIMITED UTILITY, TECHNICAL COMPLEXITY, COST, SCHEDULE, AND PERFORMANCE IMPACTS, NO SYSTEMS WERE IMPLEMENTED</p> <p>- THE ASTRONAUT OFFICE PLAYS A SIGNIFICANT ROLE IN ALL ACTIVITIES ASSOCIATED WITH DEVELOPMENT, FLIGHT PREPARATION, AND FLIGHT EXECUTION, AND THEY OR THEIR MANAGEMENT ARE MEMBERS OF ALL MAJOR DECISION-MAKING BOARDS AND PANELS</p> <ul style="list-style-type: none"> • FLIGHT RATE AND SCHEDULING - 1985 MISSION OPERATIONS WERE SUCCESSFUL IN SPITE OF SIGNIFICANT REMANIFESTING PERTURBATIONS. HOWEVER, THE TRENDS INDICATED THAT THE MILESTONES REQUIRED TO SUPPORT PREPARATION FOR THE 1986 FLIGHT SCHEDULE WERE NOT BEING MET 			

 <p>NASA Lyndon B. Johnson Space Center MISSION OPERATIONS DIRECTORATE</p>	<p>SUBJECT: MAJOR FINDINGS AND CONCLUSIONS (CON'T)</p>	<p>NAME: DAB/T, W. HOLLOWAY</p> <p>DATE: JUNE 12, 1985</p> <p>PAGE 8</p>
<ul style="list-style-type: none"> ● MAJOR CONCLUSIONS <ul style="list-style-type: none"> ● THE NSTS PROGRAM SHOULD DEVELOP A BOTTOMS-UP STRATEGY FOR EXPANDING THE FLIGHT RATE. AS A START, RIGID MANIFESTING CRITERIA NEED TO BE ESTABLISHED AND ENFORCED ● AN INSPECTION AND MAINTENANCE PROGRAM SHOULD BE IMPLEMENTED THAT WILL ENSURE FLAWLESS PERFORMANCE OF CRITICAL SPACE SHUTTLE HARDWARE INTO THE 21ST CENTURY ● THE NSTS PROGRAM SHOULD FOCUS ATTENTION ON DEFINING AND PROVIDING AN ADEQUATE MARGIN FOR END-OF-MISSION AND INTACT ABORT LANDINGS. THIS INCLUDES BOTH GROUND FACILITIES AND FLIGHT HARDWARE ● THE NSTS PROGRAM SHOULD EVALUATE THE OPTIONS AND UTILITY OF PROVIDING CREW ESCAPE SYSTEMS AND AUGMENTING ORBITER ABORT MODES 		

 <p>NASA Lyndon B. Johnson Space Center MISSION OPERATIONS DIRECTORATE</p>	SUBJECT:	NAME: DAS/T. W. HOLLOWAY	DATE: JUNE 12, 1986	PAGE
<p>BACKUP CHARTS</p>				

 <p>NASA Lyndon B. Johnson Space Center MISSION OPERATIONS DIRECTORATE</p>	<p>SUBJECT: SUMMARY OF REPORT FINDINGS AND CONCLUSIONS</p>	<p>NAME: DA8/T, W. HOLLOWAY</p> <p>DATE: JUNE 12, 1986</p> <p>PAGE B1</p>
<ul style="list-style-type: none"> ● STS 51-L MISSION PLANNING AND PREPARATIONS <ul style="list-style-type: none"> • MANIFEST CHANGE TRAFFIC FOR STS 51-L WAS TYPICAL. SOME LATE SECONDARY CHANGES • MISSION OPERATIONS RECONFIGURATION PROCESS FOR STS 51-L WENT SMOOTHLY AFTER THE CARGO INTEGRATION REVIEW, EXCEPT FOR FLIGHT SPECIFIC TRAINING STARTING SLIGHTLY LATER THAN DESIRED (2 WEEKS) • FLIGHT PROCEDURES AND THEIR ASSOCIATED DOCUMENTATION WERE COMPLETE AND READY FOR FLIGHT. THE FLIGHT REQUIRED FEW NEW TECHNIQUES OR PROCEDURES • MISSION OPERATIONS PARTICIPATION IN LAUNCH SITE FLOW ACTIVITIES WAS TYPICAL AND ALL REQUIRED ACTIVITIES WERE COMPLETED • STS 51-L CREW AND FLIGHT CONTROL TEAM WERE FULLY TRAINED AND READY FOR FLIGHT ● STS 51-L MISSION OPERATIONS <ul style="list-style-type: none"> • OPERATIONS TEAM PRELAUNCH ACTIVITIES WERE TYPICAL WITH SOME DELAYS ENCOUNTERED AND PROBLEMS SOLVED • NO ORBITER ANOMALIES PRIOR TO THE ACCIDENT WERE SEEN IN "REAL-TIME" OR IN THE RECONSTRUCTED FLIGHT WHICH WOULD HAVE INDICATED TO THE FLIGHT CONTROL TEAM THAT THE ACCIDENT WAS IMMINENT • FLIGHT SOFTWARE PERFORMED AS REQUIRED AND DID NOT CONTRIBUTE TO THE ACCIDENT • THERE WAS NO SURVIVABLE ABORT OPTION AVAILABLE FOR THE STS 51-L FAILURE • THE ACTIONS OF THE RANGE SAFETY OFFICER WERE APPROPRIATE AND DID NOT CONTRIBUTE TO THE ACCIDENT 		

 <p>NASA Lyndon B. Johnson Space Center MISSION OPERATIONS DIRECTORATE</p>	<p>SUBJECT: SUMMARY OF REPORT FINDINGS AND CONCLUSIONS (CONT 'd)</p>	<p>NAME: DAB/T. W. HOLLOWAY</p> <p>DATE: JUNE 12, 1986</p> <p>PAGE B2</p>
<ul style="list-style-type: none"> • INSTRUMENTATION PLANNING • THE CURRENT SHUTTLE MISSION SIMULATOR CAN SUPPORT 12 TO 15 FLIGHTS PER YEAR • THE CURRENT FLEET OF THREE SHUTTLE TRAINING AIRCRAFT CAN SUPPORT 17 FLIGHTS PER YEAR • CREW WORKLOAD IN THE LAST WEEKS BEFORE FLIGHT IS HIGH. LATE DELIVERY OF SOFTWARE AND PROCEDURES AGGRAVATES THE SITUATION • SECONDARY PAYLOADS AND PAYLOAD SPECIALISTS SHOULD BE STABILIZED AT L-5 MONTHS TO AVOID UNACCEPTABLE IMPACTS TO FOLLOW ON ACTIVITIES • LATE CHANGES TO A MISSION ADVERSELY IMPACT ACTIVITIES SUPPORTING DOWNSTREAM MISSIONS • NASA HAS NO FORMAL AGREEMENT WITH PAYLOAD DEVELOPERS TO ALLOW ACTIVE AUDITS OF COMPLIANCE WITH PAYLOAD SAFETY REQUIREMENTS • THE NORMAL PAYLOAD SAFETY PROCESS FAILED TO IDENTIFY POTENTIALLY SERIOUS SINGLE POINT FAILURES IN THE CENTAUR UPPER STAGE • THE OPERATIONAL MAINTENANCE AND INSPECTION PLAN IS IMMATURE, LACKS AN ACTIVE AUDIT SYSTEM, AND DOES NOT PROVIDE ADEQUATE CLOSED LOOP OVERSIGHT. THE SYSTEM SHOULD BE MODIFIED TO INSURE FLAWLESS PERFORMANCE INTO THE NEXT CENTURY 		

 <p>NASA Lyndon B. Johnson Space Center MISSION OPERATIONS DIRECTORATE</p>	<p>SUBJECT: SUMMARY OF REPORT FINDINGS AND CONCLUSIONS (CONT'D)</p>	<p>NAME: DA8/T. W. HOLLOWAY</p> <p>DATE: JUNE 12, 1986</p> <p>PAGE B3</p>
<p>● NSTS MISSION OPERATIONS</p> <ul style="list-style-type: none"> • OPERATIONS CAPABILITY DEMONSTRATED TO DATE IS SATISFACTORY, THOUGH SHORT OF THE MATURE OPERATIONS GOALS ORIGINALLY ESTABLISHED • A HIGH LEVEL OF OPERATIONS PREPAREDNESS WAS DEMONSTRATED BY THE REPEATED ABILITY OF MISSION OPERATIONS TEAM TO CONDUCT SUCCESSFUL FLIGHTS IN SPITE OF PERIODIC MAJOR ANOMALIES (STS 41-A, 41-C, 41-D, 51-F, ETC.) • FLIGHT SUPPORT AT JSC IN JANUARY OF 1986 WAS CHARACTERIZED BY A REDUCED NUMBER OF QUALIFIED PERSONNEL DEALING WITH AN INCREASING FLIGHT RATE, A TRANSITION TO A SINGLE SUPPORT CONTRACTOR, AND A TRANSITION TO A PRODUCTION ORIENTED SYSTEM • THE PROGRAM COMMITMENT FOR 1986 PRECLUDED DEVELOPING THE CAPABILITY TO HANDLE AN INCREASING FLIGHT RATE • THE PROGRAM SHOULD CONSTRAIN THE FLIGHT RATE TO PROVIDE SUFFICIENT RESOURCES TO DEVELOP FULL OPERATIONAL CAPABILITY • THE QUESTION OF WHETHER A RANGE SAFETY SYSTEM IS APPROPRIATE FOR THE SHUTTLE WILL BE ADDRESSED BY A JOINT DOD/NASA REVIEW OF THE TOTAL RANGE SAFETY SUBJECT • LAUNCH AND LANDING WEATHER CRITERIA HAVE BEEN DEVELOPED OVER MANY YEARS THROUGH AN ITERATIVE PROCESS AND APPEAR TO BE WELL FOUNDED • KSC WEATHER IS DYNAMIC AND SUBJECT TO RAPID CHANGES. THIS REQUIRES CONSERVATIVE WEATHER DECISIONS 		

 <p>NASA Lyndon B. Johnson Space Center</p>	<p>SUBJECT:</p> <p>SUMMARY OF REPORT FINDINGS AND CONCLUSIONS (CONT'D)</p>	<p>NAME:</p> <p>DA8/T. W. HOLLOWAY</p>
<p>MISSION OPERATIONS DIRECTORATE</p>		<p>DATE:</p> <p>JUNE 12, 1986</p>
<p>PAGE</p> <p>B4</p>		

- THE OPERATIONS TEAM SHOULD CONTINUE TO MAKE OVERLY CONSERVATIVE WEATHER DECISIONS. ACCURATE, LOCALIZED WEATHER FORECASTING CAPABILITY WOULD HELP REDUCE THE REQUIRED AMOUNT OF CONSERVATISM
- THE PROGRAM WILL ALWAYS NEED TO HAVE MULTIPLE END-OF-MISSION LANDING SITES DUE TO WEATHER UNCERTAINTIES
- AT THE TIME OF THE STS 51-L LAUNCH, KSC LANDINGS DID NOT CONSTITUTE AN UNREASONABLE RISK BASED ON KNOWN CREDIBLE SYSTEMS FAILURES
- THE PROGRAM SHOULD ESTABLISH SYSTEM PERFORMANCE CRITERIA THAT MUST BE MET IF ROUTINE KSC LANDINGS ARE TO BE PLANNED. ROUTINE KSC LANDINGS SHOULD ONLY BE RESUMED AFTER THESE CRITERIA ARE MET
- KSC SHOULD CONTINUE TO BE SUPPORTED AS AN ALTERNATE LANDING SITE FOR END-OF-MISSION
- THE CURRENT LANDING AND DECELERATION SYSTEMS HAVE NOT SHOWN ADEQUATE MARGINS TO SUPPORT ROUTINE KSC OR TAL LANDINGS
- THE PROGRAM MUST MAINTAIN AND BE SUCCESSFUL WITH ITS DESIGN PHILOSOPHY OF PREVENTING FIRST STAGE FAILURES
- THE ASTRONAUT OFFICE PLAYS A SIGNIFICANT ROLE IN ALL MAJOR DECISION MAKING BOARDS AND PANELS
- THE PROGRAM DID NOT IMPLEMENT A CREW ESCAPE SYSTEM BECAUSE OF LIMITED UTILITY, COST, TECHNICAL COMPLEXITY, AND/OR PERFORMANCE IMPACT
- THE PROGRAM SHOULD REEVALUATE THE UTILITY OF CREW ESCAPE SYSTEMS AND SHOULD EVALUATE AUGMENTING ABORT MODES FOR LOSS OF TWO MAIN ENGINES

 <p>NASA Lyndon B. Johnson Space Center MISSION OPERATIONS DIRECTORATE</p>	<p>SUBJECT: SUMMARY OF REPORT FINDINGS AND CONCLUSIONS (CONT'D)</p>	<p>NAME: DAB/T. W. HOLLOWAY</p> <p>DATE: JUNE 12, 1986</p> <p>PAGE B5</p>
<ul style="list-style-type: none"> ● FLIGHT RATE AND FLIGHT SCHEDULING <ul style="list-style-type: none"> • ALL CANDIDATE MANIFEST CHANGES ARE EVALUATED BY AND AGREED TO BY ALL PARTIES THAT MUST SUPPORT THEM • SCHEDULE IMPACTS IN 1985 CAUSED BY MANIFEST CHANGES WERE ACCOMMODATED BY USING THE TIME MADE AVAILABLE BY CANCELED FLIGHTS • LATE MANIFEST CHANGES TO SECONDARY OR MIDDECK PAYLOADS CAN DIVERT RESOURCES FROM PRIMARY FLIGHT OPERATIONS • UNWORKABLE FLIGHTS SHOULD NOT BE CARRIED ON THE MANIFEST WHEN IDENTIFIED • EXTERNALLY GENERATED CHANGES WHICH AFFECT THE RECONFIGURATION PROCESS ARE A SIGNIFICANT SOURCE OF SCHEDULE IMPACTS • THE PRODUCTION PROCESS AND METHODS TO MONITOR IT SHOULD CONTINUE TO BE UPDATED. A FORECASTING TOOL TO PREDICT THE IMPACT OF PROPOSED MANIFEST CHANGES SHOULD BE IMPLEMENTED. THE OPERATIONS ORGANIZATION SHOULD WORK TO DESIGN A SIMPLE METHOD OF HANDLING REASONABLE MANIFEST CHANGES • HISTORICALLY, LAUNCH DATE SLIPS HAVE PROVIDED NEEDED SCHEDULE RELIEF TO THE RECONFIGURATION PROCESS 		

 <p>NASA Lyndon B. Johnson Space Center MISSION OPERATIONS DIRECTORATE</p>	<p>SUBJECT: SUMMARY OF REPORT FINDINGS AND CONCLUSIONS (CONT'D)</p>	<p>NAME: DAB/T. W. HOLLOWAY</p> <p>DATE: JUNE 12, 1986</p> <p>PAGE 86</p>
<ul style="list-style-type: none"> • AT THE TIME OF STS 51-L, PROJECTIONS FOR 1986 INDICATED MAJOR MILESTONES IN PREPARING FOR FUTURE FLIGHTS WOULD NOT BE MET. WITHOUT LAUNCH SLIPS, THE AMOUNT OF TIME FOR FLIGHT UNIQUE TRAINING WOULD HAVE BEEN LESS THAN REQUIRED • LAUNCHES SHOULD BE SLIPPED IF MAJOR MILESTONES CANNOT BE MET. MANIFEST "CATCH UP" OPPORTUNITIES SHOULD BE PROVIDED PERIODICALLY IN THE FLIGHT SCHEDULE • CUSTOMER REQUIREMENTS FOR PAYLOAD SPECIALISTS SHOULD BE DEFINED AT LEAST 5 MONTHS PRIOR TO LAUNCH • THE JSC OPERATIONS ORGANIZATIONS ARE NOT SYSTEMATICALLY OR REGULARLY OVERWORKED AND ARE NOT GENERALLY REQUIRED TO WORK WEEKENDS EXCEPT DURING MISSIONS • PERSONNEL GENERALLY CAN AND DO TAKE LEAVE AT TRADITIONAL HOLIDAY PERIODS • MANAGEMENT UNDERSTANDS AND PLANS FOR THE EFFECT OF FLIGHT RATE ON WORKLOAD 		

PRESENTATION BY

JOHN W. THOMAS

DEPUTY, ACCIDENT ANALYSIS TEAM

DATA AND DESIGN ANALYSIS TASK FORCE

NATIONAL AERONAUTICS AND SPACE ADMINISTRATION

BEFORE THE

COMMITTEE ON SCIENCE AND TECHNOLOGY

HOUSE OF REPRESENTATIVES

730

T-0

JUNE 12, 1986

ACCIDENT ANALYSIS PROCESS

H-077

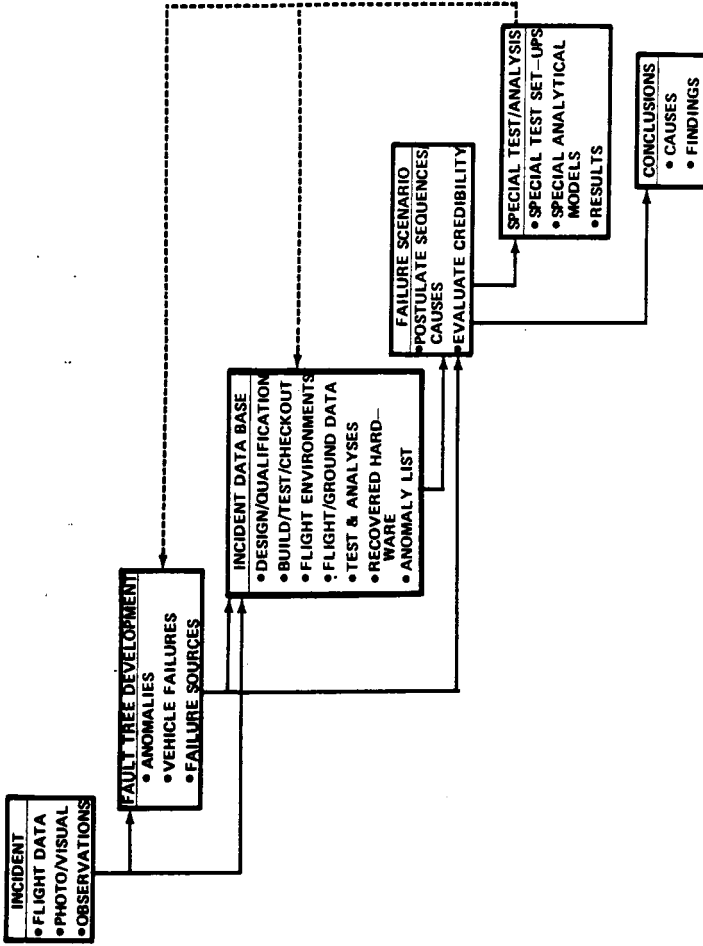

T-1

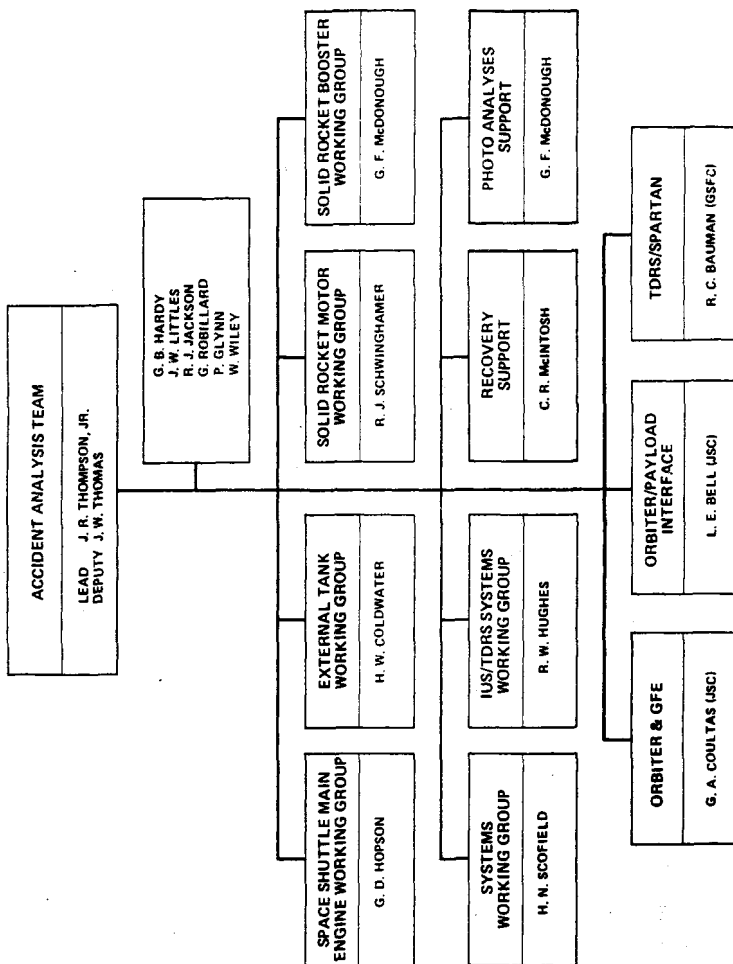

Figure 1.0.1 Accident Analysis Team Organization

STS 51-L INVESTIGATION SCHEDULE

	JAN				FEB				MAR				APR				MAY															
	3	4	1	2	3	4	1	2	3	4	1	2	3	4	1	2	3	4	1	2												
<ul style="list-style-type: none"> ● TEAMS/BOARDS/COMMISSION <ul style="list-style-type: none"> - MSFC CONTINGENCY INVESTIGATION TEAMS - NASA INTERIM BOARD - PRESIDENTIAL COMMISSION - NASA TASK FORCE TEAM ● PRESENTATIONS/BRIEFINGS <ul style="list-style-type: none"> - INTERIM BOARD CHAIRMAN - COMMISSION - TASK FORCE & COMMISSION MEMBERS - ADMINISTRATOR ● TASK FORCE REPORT <ul style="list-style-type: none"> - PRELIMINARY ISSUE - UPDATES WITH CHANGE NOTICES 					28 ●	3 ●			3 ▼	6 ▼	13 ▼	KSC					6 ●	KSC	21 ▼	26 ▼	10 ▼	15 ▼					9 ▼	12 ▼			22 ▼	

SUMMARY FINDINGS

- 0 RIGHT SRM AFT FIELD JOINT LEAKED HOT COMBUSTION GAS
- 0 HOT GAS LEAK WEAKENED AND/OR PENETRATED ET HYDROGEN TANK
- 0 HYDROGEN TANK BREACH AND/OR RIGHT SRB ROTATION INTO ET INTERTANK LED TO TOTAL VEHICLE STRUCTURAL BREAKUP
- 0 NO OTHER STS 51-L SHUTTLE ELEMENT OR THE PAYLOAD CONTRIBUTED TO THE CAUSE OF THE SRM JOINT LEAK

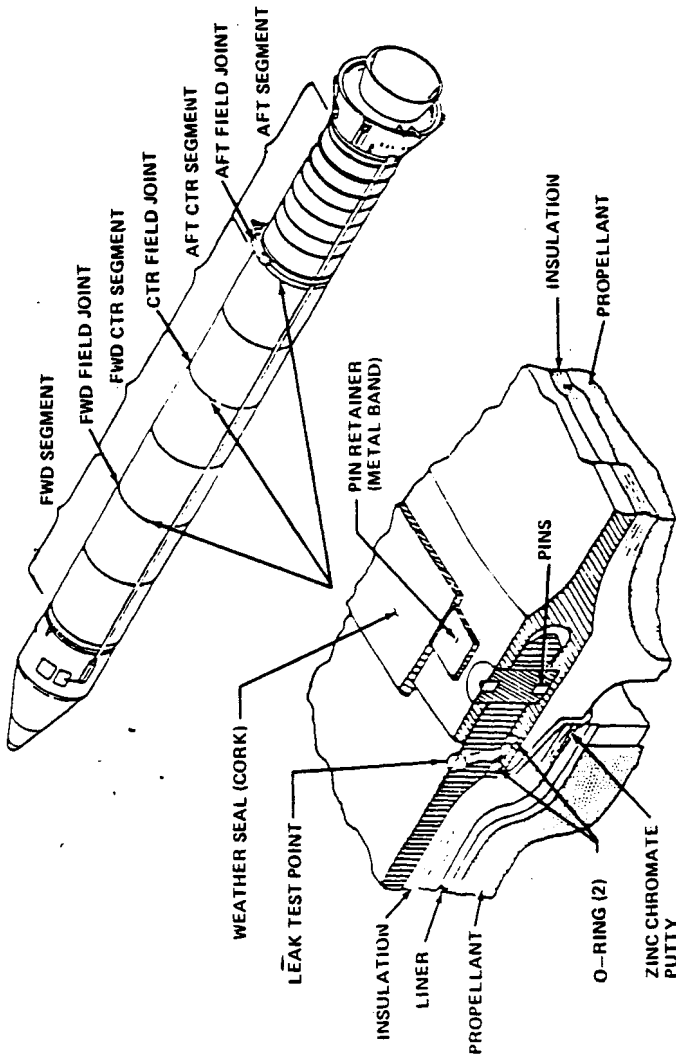

Solid Rocket Motor and Typical Field Joint

AFT SEGMENT/AFT CENTER SEGMENT FIELD JOINT CONFIGURATION

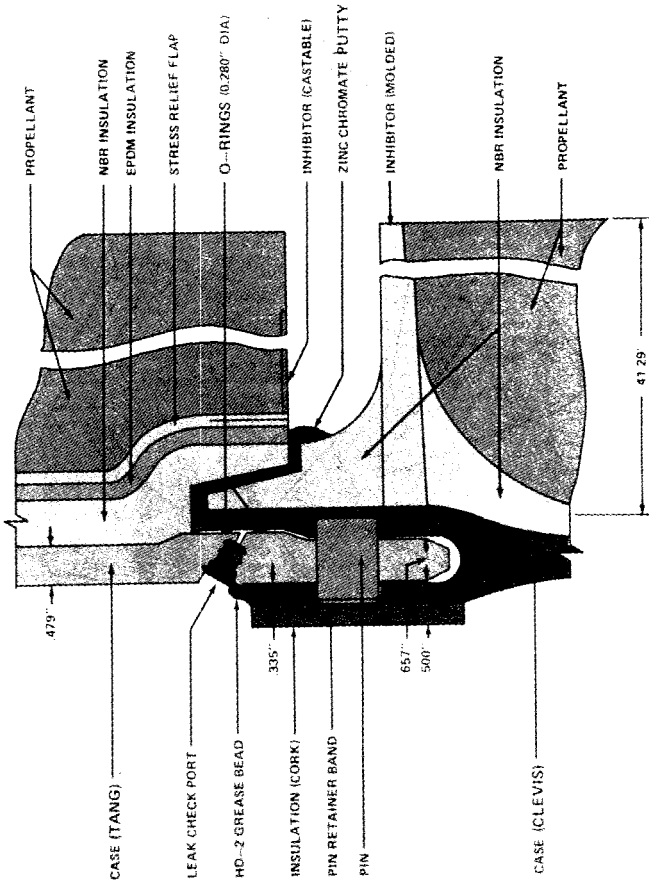

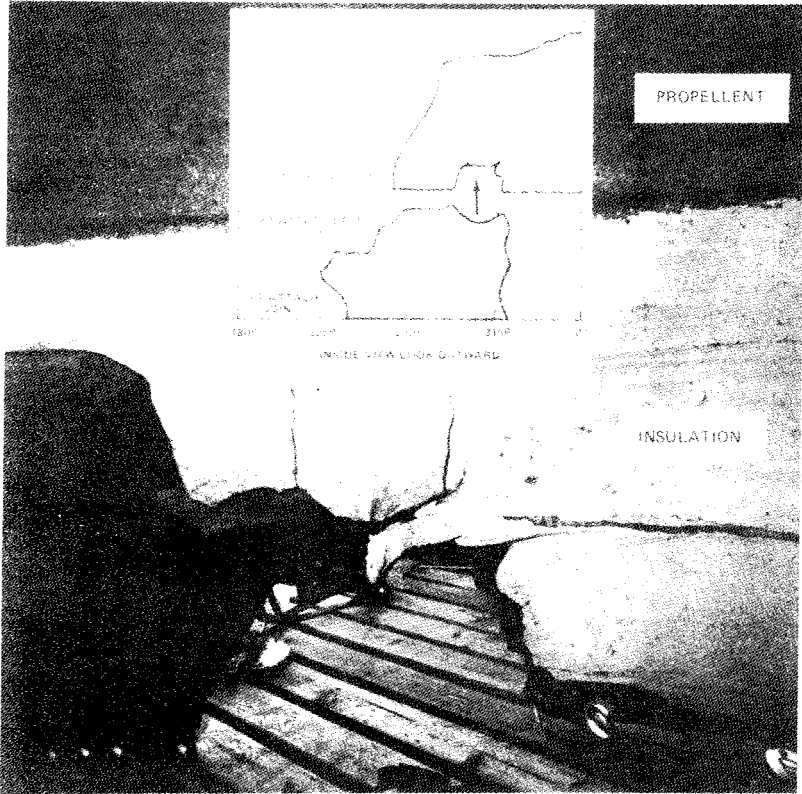

Reversed Portion of SRM Aft Center Segment

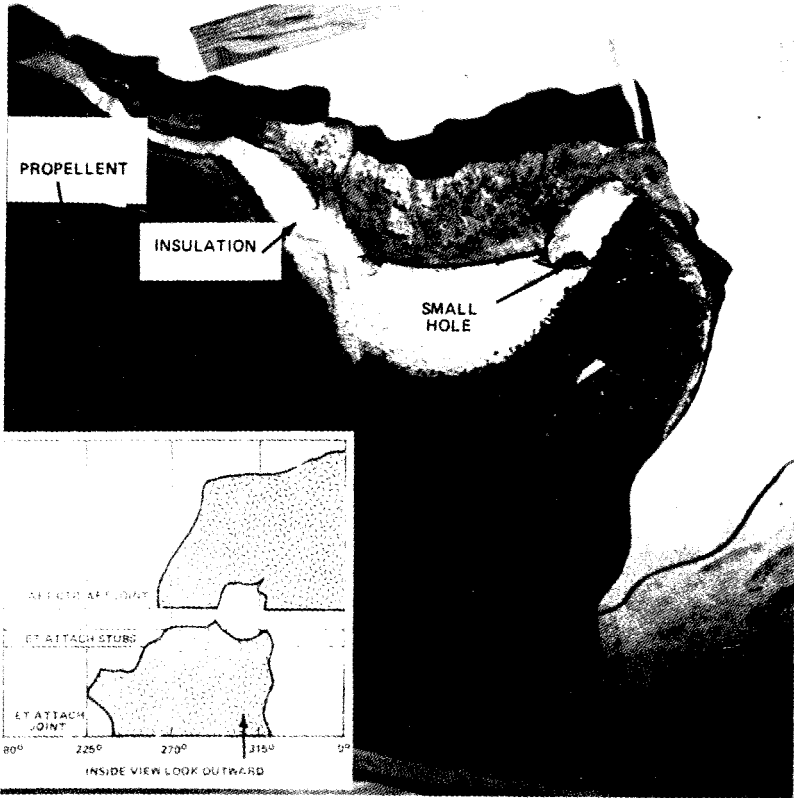

Recovered Portion of SRM Aft Segment

T-8

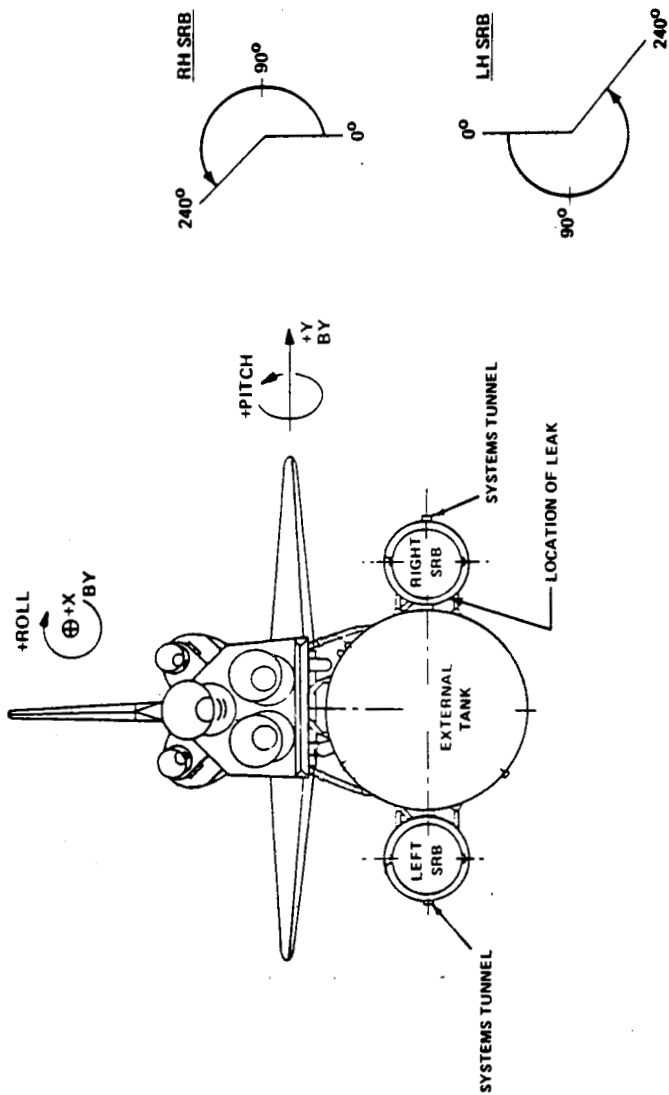

STS 51-L RIGHT SRM LEAK LOCATION

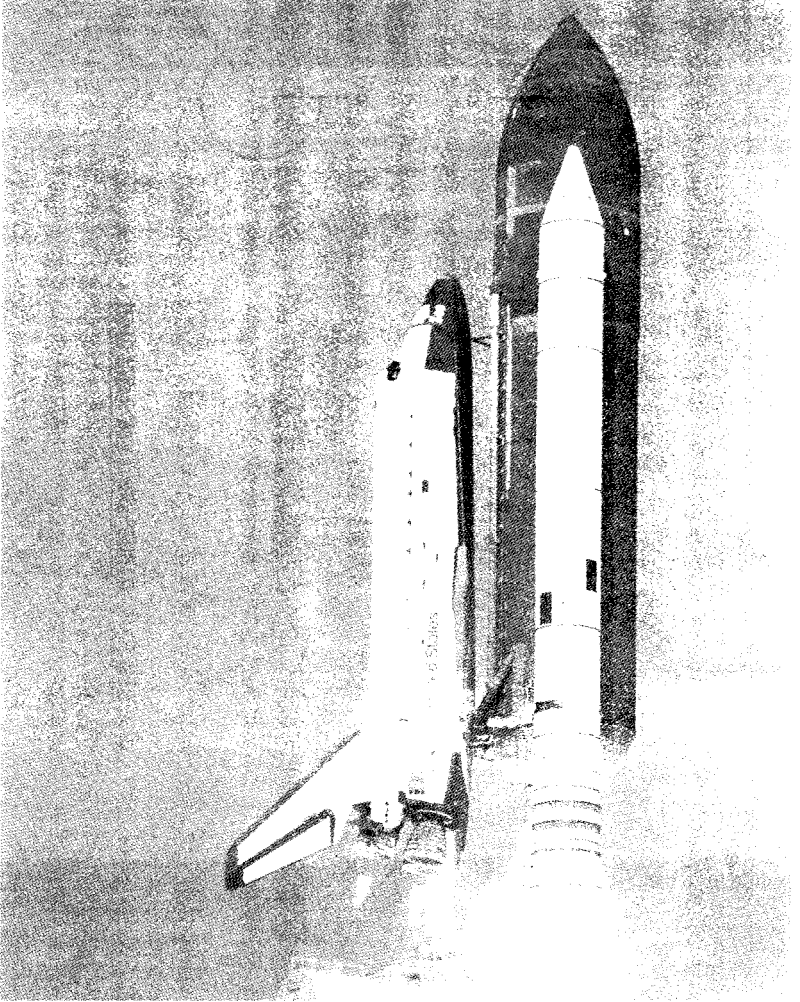

T-10

H-075

51-L FAULT TREE

REV A 3/10/86
REV B 3/31/86
REV C 5/6/86

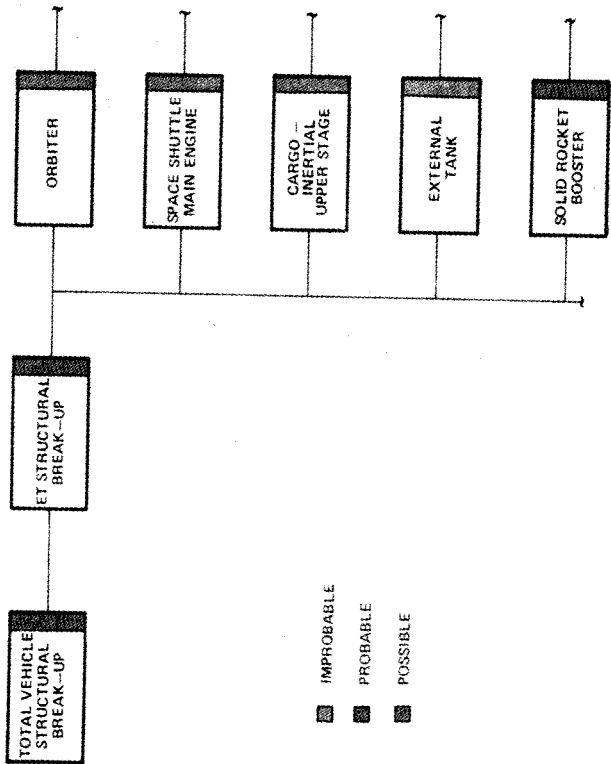

- ▨ IMPROBABLE
- ▣ PROBABLE
- ▤ POSSIBLE

T-11

CS 074

S-I-F FAILURE TREE

REV. A 3/10/86

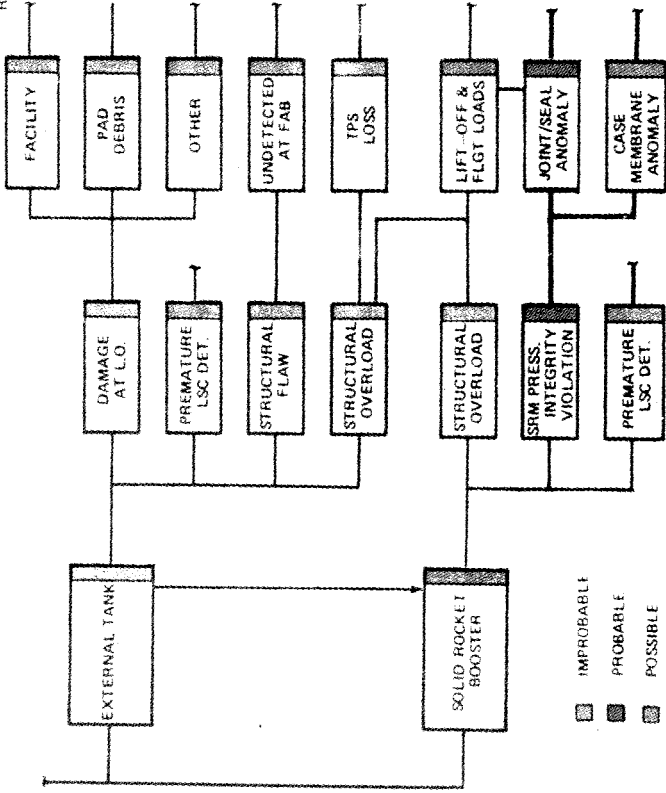

[Light Gray Box] IMPROBABLE
 [Dark Gray Box] PROBABLE
 [Medium Gray Box] POSSIBLE

T-12

SRM JOINT FAILURE

CONTRIBUTING MECHANISMS

- 0 GAP OPENING DUE TO JOINT DYNAMICS AND MOTOR PRESSURE
- 0 JOINT TEMPERATURE AT LAUNCH
 - o O-RING RESILIENCY
 - o ICE IN JOINT
- 0 JOINT DAMAGE/CONTAMINATION AT ASSEMBLY
- 0 O-RING SQUEEZE AFTER MATING - STATIC O-RING COMPRESSION
- 0 PUTTY PERFORMANCE
 - o PRESSURE HOLDING CAPABILITY - PRESSURE ACTUATION TIMING
 - o ASSEMBLY BLOWHOLES - O-RING EROSION

ASSESSMENT OF CONTRIBUTING MECHANISMS

GAP OPENING DUE TO JOINT DYNAMICS AND MOTOR PRESSURE

ANALYSES AND TESTS ESTABLISHED GAP OPENING FOR ALL JOINTS FOR STS 51-L

GAP OPENING LESS FOR AFT FIELD JOINTS THAN FORWARD JOINTS

GAP OPENING PROBABLE CONTRIBUTOR IN COMBINATION WITH OTHER FACTORS

RIGHT SRM AFT FIELD JOINT DELTA GAP OPENING

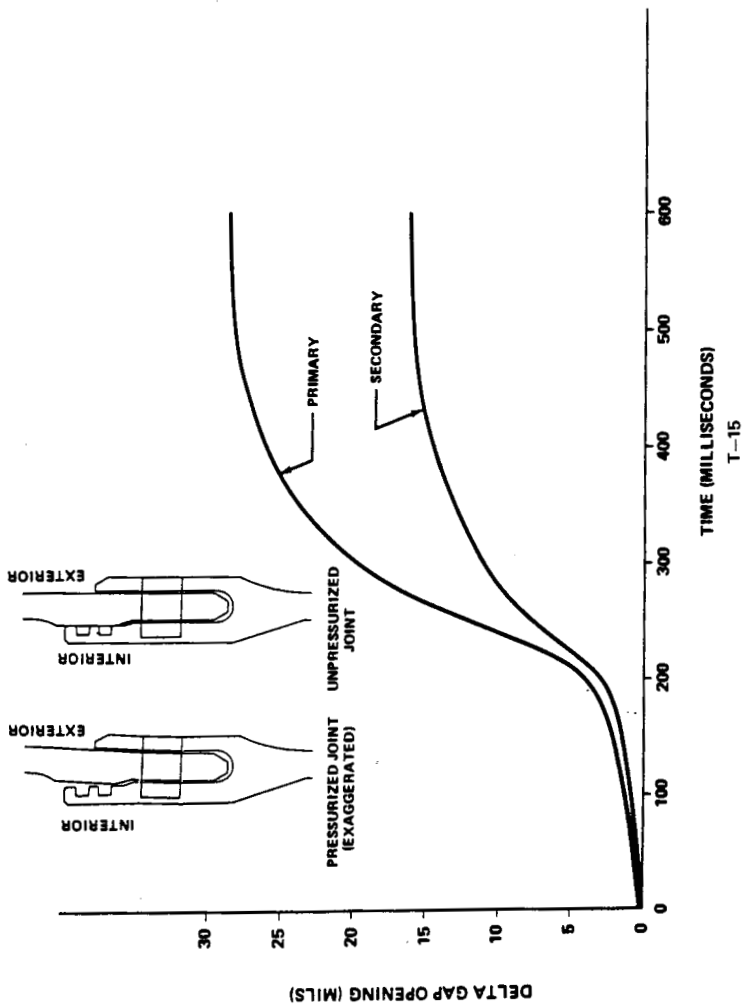

ASSESSMENT OF CONTRIBUTING MECHANISMS

JOINT TEMPERATURE AT LAUNCH

- 0 TESTS SHOW O-RING RESILIENCY SIGNIFICANTLY DECREASED AT STS 51-L JOINT TEMPERATURES
 - 0 COLD O-RING WILL NOT TRACK GAP OPENING RATE WITHOUT PRESSURE ASSIST
- 0 ANALYSIS AND TESTS INDICATE POSSIBILITY OF ICE UNSEATING SECONDARY O-RING
- 0 TESTS SHOW FAILURE OF SECONDARY O-RING TO SEAL WITH ICE IF PRIMARY O-RING VIOLATED
- 0 ALL SIX STS 51-L JOINTS HAD AREAS AT OR NEAR TEMPERATURE OF FAILED JOINT
- 0 JOINT TEMPERATURE PROBABLE CONTRIBUTOR IN COMBINATION WITH OTHER FACTORS

SRB AFT JOINT TEMPERATURE FOR SIS 51-L

747

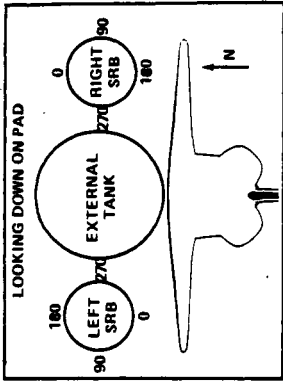

NOTE:
SIMILAR TEMPERATURES
FOR FORWARD JOINTS

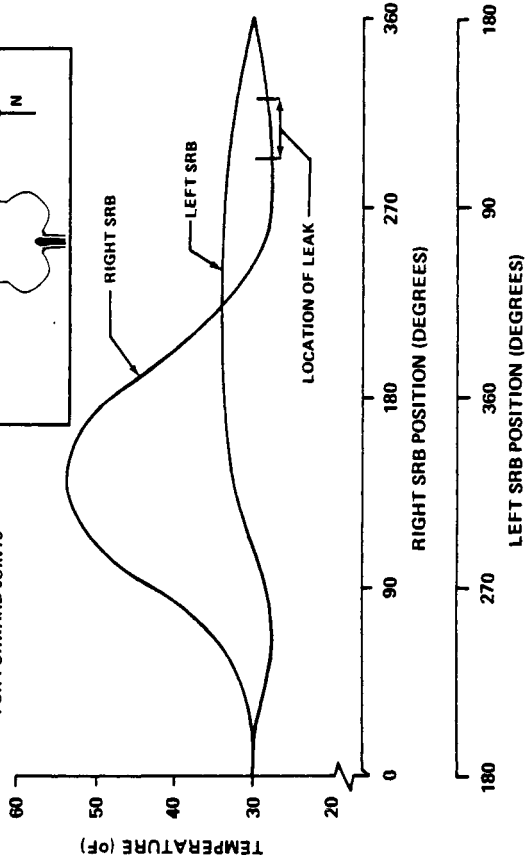

T-17

ASSEMBLY OF CONTRIBUTING MECHANISMS

JOINT DAMAGE/CONTAMINATION AT ASSEMBLY

- 0 RIGHT HAND AFT SRM JOINT MOST DIFFICULT STS 51-L JOINT
- 0 ANALYSIS SHOWS ASSEMBLY STRESSES NOT DETRIMENTAL
- 0 TESTS SHOWED POTENTIAL TO GENERATE CONTAMINATION
- 0 SOME LIMITED EXPERIENCE OF O-RING DAMAGE IN GROUND TEST
- 0 ASSEMBLY DAMAGE/CONTAMINATION POSSIBLE BUT NOT PROBABLE AT THE RIGHT HAND AFT FIELD JOINT

51-L FIELD JOINTS

H-638

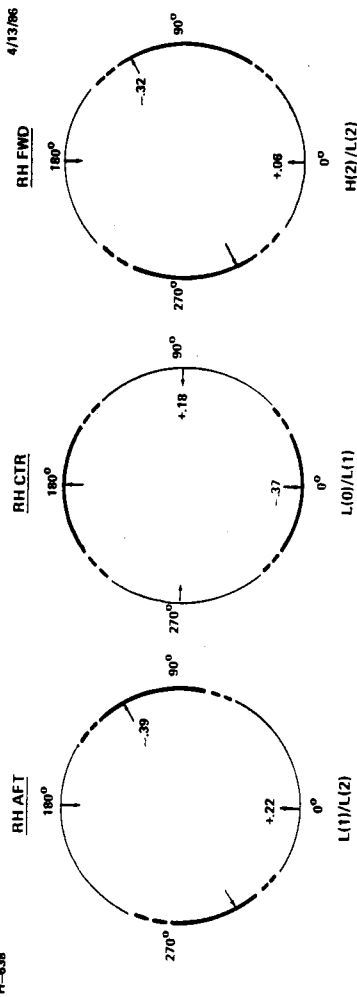

4/13/86

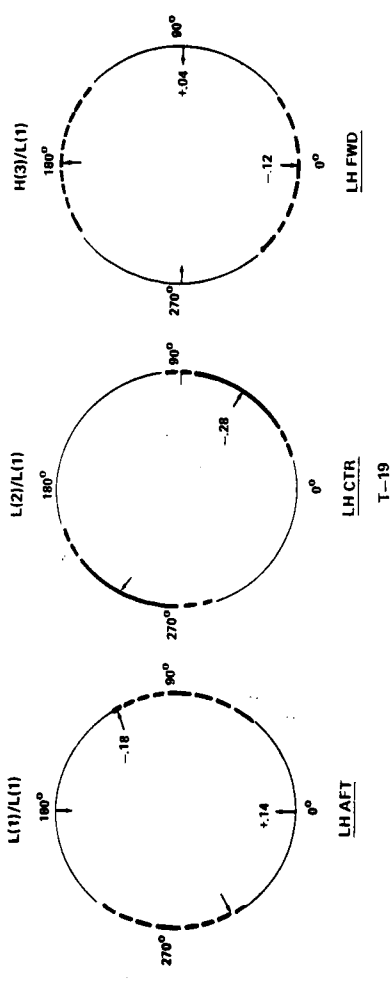

T-19



ASSESSMENT OF CONTRIBUTING FACTORS

O-RING SQUEEZE AFTER MATING

- 0 LOCATION OF RIGHT SRM AFT FIELD JOINT COMBUSTION GAS LEAK COINCIDED WITH APPROXIMATE LOCATION OF MAX INTERFERENCE--TANG TO INNER CLEVIS LEG
 - 0 THESE CONDITIONS COULD PRODUCE MAX O-RING SQUEEZE
- 0 TESTS SHOW O-RING SQUEEZE MAGNITUDE IMPORTANT TO SEALING PERFORMANCE WHEN PRESSURE APPLIED AT MOTOR IGNITION--MAXIMUM SQUEEZE LIMITS PRESSURE ASSIST
 - 0 INITIAL GAP 0.020" JOINT SEALS AT 10°F
 - 0 INITIAL GAP 0.010" JOINT SEALS AT 25°F
 - 0 INITIAL GAP 0.004" JOINT FAILS AT 25°F
- 0 TESTS SHOW MARGINAL SEAL CAPABILITY AT 50°F WITH 0.004" INITIAL GAP AND PRESSURE TO O-RINGS DELAYED
- 0 FOUR OF SIX STS 51-L JOINTS HAD DIMENSIONS AT MATING WHICH COULD RESULT IN MAXIMUM SQUEEZE
- 0 POTENTIAL DIMENSIONAL CHANGES (DIAMETRICAL) WITH USES MAY AGGRAVATE MAX SQUEEZE CONDITION
- 0 MAXIMUM SQUEEZE IS PROBABLE CONTRIBUTOR IN COMBINATION WITH OTHER FACTORS

COMPARISON OF O-RING SEALING TEST RESULTS				
INITIAL GAP (MILS) TEMP (°F)	PRESSURE AT MOTOR IGNITION		DELAYED PRESSURE ACTIVATION	
	4	20	4	20
70	Green	Green	Green	Green
60	Green	Green	Green	Green
55	Green	Green	Green	Green
50	Yellow	Yellow	Yellow	Yellow
40	Yellow	Yellow	Yellow	Yellow
25	Yellow	Yellow	Yellow	Yellow
10	Red	Red	Red	Red
0	Red	Red	Red	Red
-10	Red	Red	Red	Red

LEGEND:

-  GREEN: SEALS WITH NO LEAKAGE OR BLOW-BY
-  YELLOW: SEALS WITH LEAKAGE AND/OR BLOW-BY
-  RED: DOES NOT SEAL

ASSESSMENT OF CONTRIBUTING MECHANISMS

PUTTY PERFORMANCE

- 0 TESTS SHOWED POTENTIAL FOR PUTTY TO DELAY O-RING PRESSURIZATION DURING IGNITION TRANSIENT--BUT PERFORMANCE IS VARIABLE
- 0 FLIGHT HARDWARE DISASSEMBLY CONFIRMED PRESENCE OF BLOW HOLES IN 16 OF 138 JOINTS
- 0 DESTACKING STS 61-6 SHOWED SEVERAL BLOW HOLES THAT CAN CONCENTRATE HOT GAS FLOW AND CAUSE O-RING EROSION
- 0 TESTS CONFIRMED THAT DELAYED PRESSURE ACTUATION COULD RESULT IN FAILURE TO SEAL:
 - 0 OVER THE RANGE OF POTENTIAL STS 51-L SQUEEZE CONDITIONS
 - 0 AT STS 51-L TEMPERATURES
- 0 PUTTY IS A PROBABLE CONTRIBUTOR IN COMBINATION WITH OTHER FACTORS

CONCLUSIONS

- 0 NO SINGLE ACCIDENT CAUSING MECHANISM COULD BE DISCERNED
- 0 DAMAGE/CONTAMINATION AT MATING IMPROBABLE
- 0 MECHANISM ACTING IN COMBINATION MOST PROBABLE CAUSE
 - o GAP OPENING
 - o MAXIMUM O-RING SQUEEZE
 - o LOW TEMPERATURE
 - O-RING RESILIENCY
 - ICE IN JOINT
 - o PUTTY VARIABILITY
- 0 SRM JOINT MUST BE REDESIGNED

JUNE 12 HEARING—APPENDIX #3

Responses to written questions submitted by Chairman Roe during the June 12, 1986, hearing at which Dr. Fletcher testified.

SRB Case ReuseQUESTION A-1:

- a. When did you learn that the SRB cases have been expanding after the first three or four proof tests?

Why did you not know this sooner?

- b. Why are the cases expanding?

Is it not true that since the test pressures are below the "elastic limit" of the steel in the cases, they should not be expanding as they appear to be?

Does the fact that the cases are expanding mean that the true formulation of the steel used in making the cases may be different from what the manufacturer says it is?

- c. What does all of this mean about the reusability of SRB cases?
- d. After each use, are reusable hardware components tested to the same degree as a new component would be tested?

Are criticality 1 and 1R components tested to a more exacting and complete standard than other hardware components?

ANSWER A-1:

- a. The first real knowledge of SRM case "growth" after reuse, was not fully established until after MTI conducted "growth testing" on two steel case samples during the early spring of 1986. Whether or not the case growth totally ceases after the initial three or four pressure cycles has also not been totally explored by MTI or MSFC, but is currently underway.

Case growth may not have been known in finite dimensional terms until the date stated above, but it had been suspected by both MSFC and MTI engineers for some time prior to that. All pressure vessels tend to "grow" to some degree whenever they are proof pressure tested above the design operating limit. The degree of growth of the SRM cases was not fully characterized until "case growth" became a part of the overall "O-ring" seal and joint rotation concern.

- b. As stated above, all pressure vessels, metal or filament construction, expand by some finite amount depending on the amount of design margin (safety factor and design life) originally designed into the pressure vessel.

The normal proof pressure seen by the case membrane (i.e., 1.2 x 1004 psig) is well below the "elastic limit" of the D6AC steel material. However, the cyclic growth characteristic of this material for repeated pressure cycles have not been fully determined for this material at this time. MSFC and MTI are

taking a thorough look at the basic billet material specifications and raw material traceability, as well as the heat treatment of the cases at the vendor level.

- c. At the present time, the MTI/MSFC assessment of the potential impact from the case growth problem would not be significant and the cases can be reused. In the worst case this would require that used cases be grouped into lots of like number of reuses (2x, 3x, 4x, etc., reuses) and mated and flown with cases of like pressure exposures rather than intermixing of new and reused cases as has been done in the recent past.
- d. After each use, all SRM steel cases are refurbished via a series of visual inspections, non-destructive evaluation (NDE), pressure testing and returned to inventory for casting of motors. During the refurbishment cycle, the reused case segments are pressure tested to 1.12 times operating pressure. All new and refurbished SRM components are tested to the specific requirements (specifications) of that particular element whether they are criticality 1 or 1R.

Personnel

QUESTION A-2:

- a. What have your employee losses been in the past five years? (Please detail losses by specialty in the scientific and technical areas.)

What reasons for leaving have been given by departing personnel?

Specifically, has salary been important as a reason for leaving?

- b. What employees do you expect to lose over the next ten years, either due to retirement or normal attrition? (Again, please estimate losses by specialty in scientific and technical areas.)

What difficulties do you anticipate in replacing these people?

- c. What personnel do you expect to add to your agency's workforce as part of your response to the loss of the Challenger?

What difficulties do you anticipate in hiring these people?

- d. Are there any critical personnel specialities which you have particular difficulty hiring and retaining?

To what extent are personnel management policies, and in particular salary, a problem in this area?

ANSWER A-2:

- a. Listed below are NASA's employee losses for the past five years:

	<u>NASA Losses FY 1981-1986</u>					
	<u>FY</u> <u>1981</u>	<u>FY</u> <u>1982</u>	<u>FY</u> <u>1983</u>	<u>FY</u> <u>1984</u>	<u>FY</u> <u>1985</u>	<u>FY</u> <u>1986*</u>
<u>Total</u>	<u>1838</u>	<u>1556</u>	<u>1176</u>	<u>1530</u>	<u>1494</u>	<u>1169</u>
<u>Non AST</u> <u>Engineers</u>	<u>32</u>	<u>26</u>	<u>13</u>	<u>19</u>	<u>9</u>	<u>5</u>
<u>AST</u> <u>Engineers</u>	<u>665</u>	<u>503</u>	<u>386</u>	<u>576</u>	<u>569</u>	<u>457</u>
<u>Life</u> <u>Scientists</u>	<u>6</u>	<u>6</u>	<u>0</u>	<u>3</u>	<u>2</u>	<u>4</u>
<u>Technicians</u>	<u>261</u>	<u>207</u>	<u>161</u>	<u>156</u>	<u>204</u>	<u>180</u>

* FY 1986 data as of June 30, 1986

The major cause of losses has consistently been retirements. Our average losses due to retirement for the period covered were 50.0 percent. This rate has varied from lows of 46.9 percent in FY 1982 and FY 1983 to a high of 59 percent so far in FY 1986.

To the extent that employees so indicate, an average of 17.1 percent of our losses have been for higher pay. However, we also know, but have no quantitative data, that many retirees leave NASA for higher paying jobs in industry.

- b. Assuming that our experience in the next ten years will not be significantly different from our FY 1981-1986 experience, we would expect our total losses to be 15,000 to 18,700. As best we can determine breakdowns would be approximately:

Non AST Engineers	180-224
AST Engineers	5400-6700
Life Scientists	30-37
Technicians	1750-1950

The difficulties we would expect to experience in replacing these people are similar to the current difficulties we outline in the next two questions.

- c. As part of our response to the Roger's Commission recommendations, we would primarily expect to add personnel with skills and expertise in program management, contract oversight, safety reliability and quality assurance and the state-of-the-art of scientific and engineering backgrounds essential to major redesigns of the solid rocket boosters and other Shuttle-related hardware. We anticipate two primary difficulties in hiring these people. First, we are concerned

about acquiring the personnel resources we need in a timely manner if we must do this within current Federal hiring procedures, and secondly, we are concerned that our salary structure is not sufficiently flexible and competitive to attract the very best talent our Nation has to offer. Timely staffing with top quality personnel is critical to the recovery process and the continuing excellence of the United States Space Program.

- d. NASA benefits from nation-wide direct hire authority for GS-800 engineering positions through the GS-11 level at all of our field installations and through GS-12 at some locations. However, in spite of this authority, we are experiencing difficulty in recruiting entry-level engineers largely due to salary. Our documentation shows that NASA's acceptance rate for entry-level engineers from March 31, 1985, to March 31, 1986, declined to 39 percent from a level of 46 percent for the preceding two years. This is 16.7 percent below our 56 percent rate in FY 1983. Additionally, at GS-7 (our primary entry level), our acceptance rate was only about 26 percent.

Currently the Government pays GS-7 recent college graduates in all engineering disciplines a special salary rate \$23,170. This is the statutory maximum under the current special salary rate provisions. At the same time, our private sector competitors are offering these graduates an average salary of \$27,000 to \$29,000 depending on the engineering discipline. It would take approximately a 20 percent increase for us to match our competitors. However, absent a legislative change, the most we could offer in the next year would be the percentage increase to the General Schedule (perhaps two or three percent in January 1987).

A continuing infusion of recent college graduates is critical to the continued success of NASA's mission, and accomplishing this has become increasingly difficult. Inadequate salaries are an equally significant problem at the executive levels in the agency.

For occupations and grade levels other than engineering, NASA must use the Office of Personnel Management staffing process. This mechanism is generally recognized as slow, cumbersome, and unable, in many cases, to provide high quality candidates. NASA has a unique mission which requires it to maintain a strong in-house technical capability and strong support staff. Our ability to accomplish this is hampered by the system under which we operate.

JUNE 18 HEARING - APPENDIX #1

MORTON THIOKOL, INC.

James A. Robertson
Vice President
Government Relations

July 9, 1986

Mr. Robert C. Ketcham
General Counsel
U.S. House of Representatives
Committee on Science and Technology
Suite 2321 Rayburn House Office Building
Washington, D. C. 20515

Dear Mr. Ketcham:

In your letter to Mr. U. E. Garrison of June 19, 1986 you included a number of questions which you asked Morton Thiokol to answer for the Committee record. We have reviewed these questions and answered them to the best of our ability and I have enclosed them herein in accordance with your request. You will note that we re-stated the question in each case to insure clarity.

I hope that this response satisfies the needs of the Committee and if you have any further questions, we would be pleased to respond.

Sincerely,

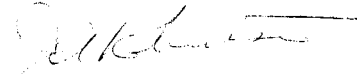

JAR/bbc

Enclosure

RECORDED
1986
COMMITTEE ON SCIENCE AND TECHNOLOGY

CONGRESSIONAL QUESTIONS FOR MORTON THIOKOL, 23 JUNE 1986

ISSUE NO. 1 - INADEQUATE DESIGN OF FIELD JOINT

1. Who designed the field joint for use on the Solid Rocket Motor (SRM)?

Answer: Morton Thiokol designed the field joint of the SRM. It was patterned after the Titan Booster joint. Morton Thiokol submitted the design for review and approval to NASA/MSFC at several phases in the development program. NASA recommended or directed design changes which were incorporated in the final design that was approved by NASA.

2. What were the design parameters for this joint? In terms of materials, operating temperatures, pressure gradients, and structural loadings?

Answer: Structural materials of the joint met the design parameters of high strength and fracture toughness dictated by load analysis of the loads data book furnished by NASA. Fracture mechanics tests were conducted to cover the low end of the operating temperature limit of 40°F. No initial design advantage was taken for the decreasing pressure gradient down the length of the motor and all joints were designed for the maximum expected operating pressure (MEOP). Military and state of the art material and processing specifications were used.

3. The design of the joint appears to be extremely sensitive to close dimensional tolerances. What provision was made in the design to accommodate the use of "construction type" equipment, such as cranes, under artificial lighting conditions?

Answer: All handling loads, conditions, and equipment expected at KSC were investigated and allowed for in the original design. Evidence from the recent 61G destacking at KSC shows that the joint design is not extremely sensitive to close dimensional tolerances. The joints always fit together, horizontally and vertically. Available equipment, particularly cranes are not "construction type," but are high quality units originally built and used on the Apollo Program and capable of redesign assembly. The cranes used for SRM assembly are equipped with precise operating controls meeting the joint design requirements for mating and pinning.

4. Did the operating temperature design specifications recognize that freezing temperatures were not unusual in Florida?

Answer: NASA's operating temperature specification did not address freezing temperatures.

5. What safety margins were specifically incorporated in the design-specifications with regard to temperature?

Answer: NASA prepared the specification. There are no temperature safety margins specifically incorporated or identified in the specification.

6. With regard to temperature and turbulence, was Thiokol aware that the Shuttle was designed to fly missions in a wide range of climatic conditions or was it Thiokol's understanding that the Shuttle was a fair weather vehicle?

Answer: Morton Thiokol understood that the Shuttle was designed to be assembled and prepared for launch in a wide range of climatic conditions. We understood that launch would occur between the motor operating temperature range of 40°F - 90°F. The design load requirements which were provided by NASA accounted for these conditions for launch, boost and SRB recovery. We also understood that elements of the Space Shuttle including the SRM's would have to withstand even more severe climate conditions during storage, handling, transportation, and on pad locations.

7. Was prototype SRM built and tested? If so, what scale was this prototype built to?

Answer: A series of full-scale prototypes were built and tested in support of the SRM design development. Structural tests, vibration tests, burst tests and static tests all used full scale hardware.

8. How was the joint tested prior to acceptance for use in the SRM? Describe the test equipment used in the conduct of this test?

Answer: With the concurrence and/or direction of NASA, we conducted all of the following tests: Initial full-scale axial structural joint tests were conducted at the U.S. Bureau of Reclamation 5-million pound pull test facility at Denver during the summer of 1975. Pull test data of the five-hole joint specimens produced a structural safety factor of over 2.0, even with cyclic and special defect testing.

Special instrumentation of the first three hydroproof tests of each of five case segment configurations provided early confirmation of the joint. Static tests, structural flight loading tests and test to failure hydro burst (with preburst cyclic pressurization) were conducted for joint acceptance.

O-ring extrusion tests were conducted in February of 1977 to show sealing of 0.066 inch gaps at 2,000 psi. Further tests were run in October 1980 with 0.125 inch gap up to 5000 psi.

9. What instrumentation was used in the test to obtain data?

Answer: Thousands of strain gages and displacement transducers were used in the acceptance tests, in addition to pressure recording requirement.

10. What specific data was derived from these tests and how did it compare with the design criteria?

Answer: Gages around the pin holes, on the tang and clevis legs, across the joint and into the membrane area were used for confirmation and refinement of the detailed stress analyses performed. The stresses and strains in the joint measured in the tests confirmed that the factors of safety required were met even with overloads. All structural performance tests exceeded performance requirements.

11. Did the tests indicate the behavior which is referred to as "joint rotation"?

Answer: Yes.

12. When were these tests conducted?

Answer: The first evidence of "joint rotation" behavior was noted in the standard weight burst testing in September 1977 after the first DM-I static test in July.

The structural flight load tests started in July 1978 and joint rotation was noted during testing into 1979. The lightweight case joint testing at MEOP and up to 1.4 MEOP were conducted in September 1980 and was followed by the burst test.

A series of twelve segment hydroproof tests had controlled measurements of joint rotation taken in 1982 and 1983 at the time of DM-5, DM-6, QM-4 static tests and STS-5 and STS-6 flights.

13. When Thiokol, at first objected on January 27 to the 51L launch due to cold temperatures, specifically, what was the basis for that objection? What effect did the engineers at Thiokol think the temperatures forecasted would have on the field joint?

Answer: The concern expressed was that the O-rings' capability to seal would be reduced. The basis for this position was: (1) the excessive soot blowby past the primary seal found on two of the STS-51C field joints after the January 1985 launch. This vehicle was launched after several of the coldest days in Kennedy Space Center history and the calculated O-ring temperature at the time of launch was lower than on any other flight vehicle up to that time; (2) the O-ring resiliency test data at temperatures from 50°F to 100°F showed that the O-rings became more sluggish at lower temperatures. Though no pressure was applied to the O-rings during the resiliency tests, the engineers felt that the chance of blowby or leakage would be increased.

Some engineers believed that the temperatures could affect the joint sealing capability, which could result in anomalies ranging from soot blowby past the primary O-ring to leakage past and erosion indications on both seals.

14. What tests had Thiokol performed on the O-ring material before the accident? What were the results of these tests?

Answer: There are 21 reports and presentations which contain data from O-ring material tests. These included resiliency, compression set, extrusion, and erosion rate. These documents have been provided to the Presidential Commission on the Space Shuttle Challenger Accident and are available from the National Archives.

15. In the design, what function was the putty supposed to perform? Was it supposed to keep the heat off the O-rings?

Answer: Yes, it was intended to keep the heat away from the seals.

16. At the time of design, was it envisioned that the putty would act as a piston to compress the air in the joint and thus "seal" the primary O-ring?

Answer: Yes.

17. What tests had Morton Thiokol performed on the putty material before the accident? What were the results of these tests? What was the moisture content of this material prior to such tests?

Answer: The material has been widely used in many different solid rocket motors since 1958. There are nine reports and presentations which contain data from specific Shuttle Program putty material tests including heat and erosion resistance, consistency, resistance to pressure and chemical properties. The moisture content was not measured prior to the tests. All of these documents have been provided to the Presidential Commission on the Space Shuttle Challenger Accident and are available from the National Archives.

18. Was Thiokol aware of the hygroscopic nature of the putty? While Utah is dry, "the Cape" is very humid? How did Thiokol provide for this difference in selecting the putty and in testing it?

Answer: Morton Thiokol became aware of the hygroscopic nature of the putty as we worked with it during development. MTI performed tests at controlled temperature and humidity levels representative of the environment at KSC and found the putty tack and stiffness to be affected by humidity. In order to minimize the effects of humidity, improved packaging methods were incorporated and the allowable exposure time of the putty to the natural environment was limited.

The Randolph putty was used in the Castor IV and Patriot solid rocket motors manufactured at Morton Thiokol's Huntsville, Alabama division. These motors, made in a humid climate and aged for up to 50 months, were fired successfully. That experience, together with bench test data which also showed the Randolph putty's performance to be comparable to the previously qualified Fuller O'Brien putty, was the basis for selecting the Randolph putty for the SRM program. The Randolph putty was used in the DM-5 and QM-4 static test motors prior to using it in the STS-8 flight motors and all subsequent flight motors.

19. What are the differences in the behavior of the putty in humid conditions as compared to the normally dry conditions found in Utah? That is, what happens to the adhesive properties, viscosity, compressibility and thermal properties?

Answer: The Randolph putty tends to become dry, less tacky, and stiffer in a less humid environment. It becomes more tacky and less stiff in a more humid environment. The thermal properties would not degrade because the asbestos filler does not leach out when the putty is humidified. Viscosity and compressibility have been measured by MTI, but not on putty conditioned in a humid environment.

ISSUE NO. 2 - FAILURE TO CORRECT FAULTY DESIGN

1. When were the first casings made that incorporated this design?

Answer: The first SRM case segments were fabricated in the summer of 1976 for use in the first static test in July 1977.

2. Why was the design changed from that of the Titan SRM? Were there deficiencies in that design? What were they? Why was the Shuttle joint design inverted from that of the Titan, which obviously permits the increase of rain water?

Answer: The Titan case segment dimensions are 120 inch diameter by 120 inches long, while the SRM segments have a 146 inch diameter and are 164 inches long. Joint tolerances were essentially the same, although some allowance was made to accommodate the SRM horizontal assembly for static test. There were no structural deficiencies in either design. Recognizing this is a man-rated system, two O-rings were incorporated in the Shuttle SRM to provide redundancy and to allow leak check of the assembled joints. The Titan SRM had only one O-ring.

The clevis/tang was inverted from Titan because state-of-the-art large case forging fabrication would not accommodate a clevis on the large, one-piece weld-free forward dome with an integral forward skirt tang. Also, assembly reliability and safety were found to be enhanced because of stationary clevis O-ring installation rather than on a suspended clevis.

3. When did personnel at Morton Thiokol first become aware that there were problems with the design of the field joint on the SRM?

Answer: In September, 1977, a cyclic pressure test combined with a "hydrobust" exhibited joint rotation. There never have been any structural deficiencies identified in the present joint design.

4. What was the nature of those problems as understood at that time?

Answer: It was noted that the seal gap opened upon pressurization. The extent of the movement was not great enough to lose pressure at the required 1.4 MEOP of 1310 psi, but it did prevent burst of the steel case due to leakage at 1483 psi (1.58 MEOP).

5. What action was taken to correct the problems? Was NASA notified of them? When, and by what means? Was it a formal letter to the Contracting Officer?

Answer: Joint design tolerances were tightened and extrusion tests were run which verified sealing of 0.125 inch gaps up to 5000 psi. O-ring diameter was increased and O-ring material quality was increased. All design changes were made with the concurrence and approval of NASA through the formal change system. NASA was initially informed of the intended tolerance changes by letter in December 1977.

6. Was a formal letter ever sent to NASA advising them of the design deficiencies? When?

Answer: NASA was furnished copies of the test reports and kept informed in frequent technical interchange meetings as well as quarterly program reviews.

7. Did NASA ever formally respond and if so what was the nature of the response?

Answer: No written formal recognition or response was exchanged. Continuing technical discussions and analysis were conducted and further testing was planned and conducted.

8. Did Morton Thiokol agree with the response?

Answer: See the above answer.

9. When was the "joint rotation" problem first recognized?

Answer: We recognized rotation in September 1977.

10. Was this "joint rotation" problem aggravated by switching to light weight steel SRM cases?

Answer: The pressurizations and hydroburst of the lightweight case in September 1980 indicated a slight increase in "joint rotation" at proof pressure causing the gap to increase from 0.038 inch to 0.042 inch. From a structural aspect, the lightweight case burst at 1545 psi with a 1.67 safety factor.

11. When the casings were changed, was it submitted to a configuration control board?

Answer: Yes, all changes to the baseline (NASA approved) SRM flight design are reviewed and approved by the NASA Level III Configuration Control Board after review by a Morton Thiokol Level IV Board.

12. Who was on that board at the time the submission was made?

Answer: The members of the then-existing NASA Level III CCB are unknown at this time.

13. When was the submission made?

Answer: Lightweight cylinder drawing #1U50717 was submitted to the Morton Thiokol Level IV CCB 10 September 1979, lightweight attach drawing #1U50716 on 6 December 1979 and lightweight stiffener drawing #1U50715 on 6 December 1979. This change was approved by NASA on 9 December 1981.

14. What consideration did the field joint receive in configuration control board reviews?

Answer: The field joint, as well as all other attributes of the lightweight case configuration, was reviewed in the Morton Thiokol Level IV Board for total impact on performance, cost, safety, quality, reliability and schedules. The factors considered by the NASA Level III Board are unknown to Morton Thiokol.

15. Was any consideration given to redesign the field joint at that time? If not, why not?

Answer: No redesign of the joint was considered necessary to meet the program requirements. The joint hardware was all interchangeable and all production tooling was fabricated to process the acceptable joint configuration. No structural joint problem existed that warranted redesign.

16. In August 1985, when the field joint was redesigned, and when new forgings were ordered, was that a Thiokol decision or was the action taken at NASA's direction?

Answer: We began efforts to phase in the capture feature early in 1985. In anticipation of the Buy III contract, Morton Thiokol instructed segment suppliers to order the larger billets in June, 1985.

In July 1985, verbal approval was given by NASA engineers to pursue the steel case capture feature. Formal direction to obtain capture feature billets was given by Morton Thiokol to Rohr on 5 August 1985. NASA released drawings of steel case cylinders with a capture feature tang in October 1985.

17. If NASA directed the action, was this covered by a contract change order?

Answer: No formal change order has been provided by NASA.

18. Was this design change to be incorporated in the steel casings or was this a "long lead" procurement for the filament wound casings?

Answer: The design change was for steel case setments.

19. Was the new design for the field joints ever intended for use on the steel casings?

Answer: Yes, steel case capture cylinders have been the goal since early 1985.

ISSUE NO. 3 - POSSIBLE CONTRIBUTING CAUSES BEYOND FAULTY O-RINGS

1. What do you believe caused the large quantities of "black smoke" at 0.678 seconds after ignition?

Answer: We believe the black smoke at 0.678 seconds was caused by combustion gases flowing around (blow-by) the field joint O-rings. The combustion gas flow path would encounter O-ring material, grease, and putty thus creating black smoke.

2. While very slight it would appear that the rotation of the joint places a tensile strain on the NBR insulation near the joint. What is the elasticity of the NBR at 28°F and how was this tested?

Answer: The strain capability for NBR at 28°F is 50% which is many times larger than any strains induced in the rubber due to joint rotation. The strain capability is determined using an Instron Tensile Test with a crosshead speed of 20.0 inches per minute.

3. How can the insulation be burned so quickly (in 0.678 sec) considering its thickness and the fact that it is supposedly designed to protect the steel casing all the way through propellant "burn-out."

Answer: The field joint insulation thickness is such that it could not be burned through in 0.678 seconds. However, minor burning of insulation surfaces adjacent to the joint can occur as hot gas flows into the joint. There is no indication insulation adversely affected Challenger.

4. According to various reports, the NBR insulation and the propellant are inspected visually. Is this the only method of inspecting these materials? In "Quality Assurance" circles, what is the accepted degree of reliance that can be put on "visual inspection"?

Answer:

Insulation - Yes. Visual inspection is the only method used to inspect insulation adjacent to the field joint. Away from the joint region ultrasonic and X-ray techniques are used to examine insulation and bondline integrity.

Evaluation of fired motors has shown visual inspection in this area to be a reliable indicator of insulation bond.

Generally, direct inspection methodology i.e., non-destructive testing, lab testing or standard measuring instruments are preferred over visual inspections, if desired results can be obtained with a practical, reliable method. In the case of SRM and insulation to steel unbond inspections at the field joints (edge unbonds), no practical reliable NDT method has been developed to date.

Answer:

Propellant - A visual inspection is not the only method of propellant inspection. Other techniques are radiographic inspection, mechanical properties testing, and burn-rate testing. Visual inspection is considered as a totally reliable Quality Assurance technique for the propellant grain.

5. Doesn't the propellant frequently crack when "cold soaked" during the manufacturing process?

Answer: There has never been an instance of a thermally induced crack on a SRM segment.

6. At ignition, what would be the effect of a crack through the propellant to the NBR insulation at a field joint?

Answer: A propellant crack through to the insulation would cause an unplanned burning surface which would cause a measurable difference in burning between the two sides.

7. How was the propellant inspected for the SRM that failed? How many people were on the inspection team? Who was the QA person and what documentation did he or she sign indicating that there were no cracks in the propellant or the insulation?

Answer:

Insulation - There were three separate visual inspections, two at MTI in Utah and one at KSC. The insulation inspection team at MTI involved three persons. The insulation inspection at KSC involved two persons. The MTI insulation inspection team included MTI Quality Assurance and Air Force Quality Assurance. The KSC insulation inspection team included MTI Quality Assurance and NASA Quality Assurance.

The MTI inspection team signed the shop traveler and inspection plan. The KSC inspection team signed the planning log sheet.

Answer:

Propellant - The segments underwent the following QA inspections: Visual inspection at casting pits, X-ray of aft segment cutback area, visual inspection at final assembly, prior to storage and shipment, visual inspection prior to installation of shipping covers, and visual inspection at KSC.

Each propellant inspection team consisted of two to four people. In each case at least one Morton Thiokol Quality Engineer and at least one government QA representative were present, and at the end of each inspection, the shop traveler or inspection plan was signed.

8. What is the ductility of the propellant and how was it measured, assuming that a standard "impact test" would be impossible?

Answer: Ductility is not a measured parameter on SRM propellant.

9. What are the healing characteristics of the propellant at ambient and at elevated temperatures?

Answer: SRM propellant does not exhibit healing characteristics, using the definition of healing as reuniting of separated propellant surfaces.

10. What thermal data do you have that could answer the question of crack propagation as a function of the propellant's thermal properties and as a function of the vibration of the SRM at ignition?

Answer: Test data over a range of 0° to 145°F is used to characterize the propellant. This data is then analyzed for crack propagation using fracture mechanics techniques. The grain has been analyzed for thermal cooldown to 32°F.

Vibration loads are very small in comparison to thermal loads, and are not included in fracture mechanics grain analysis.

11. What data are there that would indicate what thermal gradient the fuel could withstand before cracking and specifically whether the low temperature of the fuel on January 28 could cause a crack? Could such a crack provide a "burn-path" that could lead to a failed joint or even a possible failed casing?

Answer: The propellant is characterized using test data, and the propellant grain is then structurally analyzed using the data as input to the analysis. Conditions of one such structural analysis were a motor conditioned to 32°F followed by a five day -30°F temperature soak with 30 MPH winds. The analysis showed no indication of propellant cracking. Therefore, the low temperature of the propellant on January 28 would not have caused a crack.

However, a propellant crack could provide a burn-path that could lead to a failed joint or casing.

12. Given a radial crack in the propellant extending to the insulation, what data is there that would support or refute the burning of NBR insulation under such a condition?

Answer: The NBR at the base of the crack would be exposed to an environment similar to that observed in the forward segment fin regions where the material affected rate (insulation erosion rate) is approximately 4 mils/sec. Based upon a minimum insulation thickness of 0.4 in. in this area, a burn through would not occur before 93 seconds.

There is no evidence of such a crack.

ISSUE NO. 4 - FUEL CRACKING

1. Given this potential defect, and assuming that a crack were to develop, do you have data that suggest what would happen to the thermal insulation material (NBR) and the casing? Could these materials withstand the combustion temperatures of the fuel?

Answer: The NBR at the base of the crack would be exposed to an environment similar to that observed in the forward segment fin regions where the material affected rate (insulation erosion rate) is approximately 4 mils/sec.

The insulation material when exposed to the combustion gas temperatures will erode at approximately 4 mils/sec and insulation survival time would be based on the insulation thickness at the base of the crack.

2. Do you have thermal data on SRB fuel that could answer the question of crack propagation as a function of the fuel's thermal and mechanical environment?

Have you generated experimental test data that would indicate what kind of temperature differential the fuel can withstand before it cracks, and whether or not these cracks can serve as fuel burn paths that could lead to the casing or the field joint?

Answer: Propellant crack propagation potential is analyzed using fracture mechanics techniques. This analysis is based on thermal data and mechanical properties of the propellant. Grain structural analyses have been performed for a thermal gradient down to -30°F; and a temperature soak of 32°F with no indication of propellant cracking in either case. However, a propellant crack, could serve as propellant burn-paths that could lead to the casing or the field joint.

3. Even if such test data exists and even if you have complete confidence in your analysis of temperature effects on the fuel, do you plan to perform additional tests as part of your redesign efforts?

Answer: We are always attempting to enlarge our data base on SRM propellant properties and testing. As new techniques become available, they will be incorporated to provide a better overall characterization of the propellant.

ISSUE NO. 5 - FULL SCALE TESTING OF SEAL PERFORMANCE AND REDESIGNED JOINT

1. It is our understanding that NASA has undertaken a program at their Langley Research Center to obtain baseline data on the sealing characteristics of various materials, including the Vitron material used for the SRB O-rings.

Are you familiar with this activity and are you participating in it?

Answer: Morton Thiokol is familiar with the NASA activity at the Langley Research Center. Parallel studies using different subscale test apparatus are in progress at Marshall Space Flight Center and at Morton Thiokol. Progress on the Langley studies is communicated by MSFC personnel to Morton Thiokol.

2. How will the information obtained from these studies be used in the joint redesign?

Answer: The seal/seal material selected for joint redesign must follow any dynamic movement of the joint during all phases of motor operation without allowing any gas leakage. The Langley, MSFC, and Morton Thiokol studies will identify the seal materials that will best seal the redesigned joint over the required temperature range.

3. (a) These Langley tests are scaled down versions of the actual joint configuration, but we understand that MTI plans some full scale tests of the O-ring seals and joints. Could you describe these tests for us?

Answer: With the approval of NASA, full scale tests of the O-ring seals and case field joints will be accomplished with full scale hardware in a configuration called the Joint Environmental Simulator (JES). The JES consists of a forward dome, two case cylinders, an ET attach segment and an aft dome/port dome assembly. This vertically tested assembly provides two "typical" case field joints for testing. The motor contains an inert propellant simulation of the propellant grain. A live propellant cartridge is used to provide hot gas pressurization of the test assembly at the same rate experienced in an SRM motor. Joint geometry, joint deflections, and temperature at the seals is faithfully reproduced in this short duration test. Extensive instrumentation monitors the joint rotation, temperature, and pressure at the seals.

3. (b) What is the cost and schedule for this test program?

Answer: The JES tests are scheduled at a one per month rate starting in July 1986. NJES tests at a one per month rate are scheduled to start in October 1986. The total number of JES and NJES tests in this program depend on the degree or success and the number of concepts carried through full scale evaluation. Costing studies have not been completed. They will depend upon the number of tests required.

3. (c) How will the results be used in the joint design?

Answer: The JES and NJES tests will be used to verify that the redesigned joint/seal will work in full scale hardware at simulated motor conditions. Final verification will be accomplished in full scale static test motors.

4. (a) What design features are you investigating?

Answer: A number of design features are being evaluated in the JES and NJES. Some of the major features are:

- (1) Features limiting or eliminating joint rotation.
- (2) Features that provide pressure actuation of the seal but eliminate any circumferential flow in the slot that could increase the heating rate at the joint seal.
- (3) Characteristics of the seal/seal material to reproducibility affect a pressure seal under all conditions of motor operation and over the required temperature range.

4. (b) Are you getting outside assistance (from NASA or others) in your joint redesign efforts?

Answer: MSFC is conducting a parallel and independent re-design effort for the joints and seals. In addition, Morton Thiokol has secured the services of a number of individual consultants and outside companies to support the redesign.

4. (c) Do you believe that you are under pressure to complete the redesign to meet NASA's planned July, 1987 date to refly the Shuttle?

Answer: The SRM must be redesigned to satisfy a number of stringent design and safety criteria. The design must be verified and certified through numerous subscale and full scale tests. This process, which must satisfy Morton Thiokol, NASA, and the NRC Design Overview Panel, will be accomplished as soon as possible commensurate with Safety and Reliability requirements of the Program.

ISSUE NO. 6 - QUESTIONS FROM MARILYN LLOYD

1. The Rogers' Commission report noted that in all the testimony they received that NASA's safety staff was never mentioned. They go on to say that no witness related the approval or disapproval of the reliability engineers, and none expressed the satisfaction or dissatisfaction of the quality assurance staff. The report also notes that no one thought to invite a safety representative or reliability or quality assurance engineer to the January 27, 1986 teleconference between Marshall and Thiokol. My question is, gentlemen, didn't you find this strange or unusual? Did anybody make a statement or a comment as to why such individuals were not present at these critical decision points?

Answer: The original question on 27 January 1986 was, "will the predicted cold temperatures at and prior to the time of launch have an impact on the solid rocket motor?" This is a question of design. Therefore, the program office called Project Engineering which has the responsibility to oversee all efforts within the engineering disciplines on the Space Shuttle SRM program, and Design Engineering, which ultimately had to answer the temperature question.

Safety and quality were involved throughout design, manufacture, shipment and assembly.

Since the issue of the moment did not concern the quality of the parts or how they were inspected, Quality Engineering personnel were not called to attend the meetings, held throughout the day. Reliability Engineering and System Safety personnel have a broader responsibility to assess failure modes, criticalities, and effects and to determine hazards associated with the design, its manufacture and use. As Reliability and Safety engineers analyze the design, they consult with and provide their results to the Design Engineer, who is the expert on all phases of the design. Thus the Design Engineer is the single person to provide the technical judgment on the design, since he understands all facets of the design, including the failure modes and effect, and the safety issues.

ISSUE NO. 7 - QUESTIONS FROM MR. VOLKMER

1. Isn't it true Mr. McDonald, that one of the problem reports you signed (PAS A09288) shows that launch constraints had been issued on Flight 51-F to 61-B?

Answer: Mr. McDonald did not sign PAS A09288. That document is prepared by NASA MSFC. The problem report did indicate that this was a launch constraint. As we testified to the Rogers' Commission, neither Mr. McDonald nor anyone else at MTI was made aware of this launch constraint.

2. What specific areas have resulted from your redesign meetings at Marshall June 9-11?

Answer: The redesign meetings included a review of the criteria for redesigning the case field joints and the case to nozzle joint. Several joint concepts were reviewed with methods for minimizing joint rotation. In addition various seal concepts and insulation concepts for these critical joints were reviewed. No selections have been made.

3. Do you feel Marshall or other NASA personnel are pushing you to choose a design before you have finished your evaluation?

Answer: Marshall may wish us to "choose" a design before evaluation can be completed. And they are aware that we may have some unusable hardware fabricated if later evaluation indicates that the selected designs are inadequate. We are conducting alternate concepts in parallel, and we have to accept the risk that early decisions affecting hardware may have to be modified or scrapped later. This is the only practical approach to minimizing schedule delays. Further, the costs that may be incurred in this type of approach are small compared to the costs associated with the added down time of the Shuttle program.

ISSUE NO. 8 - QUESTIONS CONCERNING COUNTDOWN PROCEDURES

1. How does Thiokol participate in the countdown?

Answer: Morton Thiokol does not participate in the launch countdown. Management and technical observers are present in the launch control center Firing Room No. 2 (backup Firing Room) in the event that their services are needed during the countdown.

2. Where was Mr. McDonald on January 28? Who was he talking to?

Answer: At the time of the launch, Mr. McDonald was sitting at a console listening to the countdown on a headset, adjacent to the MSFC Console in Firing Room No. 2 with Carver Kennedy of MTI's Shuttle Processing Contractor Operations. Mr. Mauldin of NASA-Marshall Space Flight Center (MSFC) was at the MSFC console.

3. Are the hardware contractors polled at T-minus 9 minutes by the launch director?

Answer: Morton Thiokol is not polled at T-9 minutes. We do not know if other hardware contractors are polled. The launch director can question Morton Thiokol at any time during the countdown.

4. Were Thiokol personnel asked to sit in on the discussion regarding Rockwell's concerns about ice on the pad? The SRB might have been vulnerable to damage.

Answer: No. Morton Thiokol personnel were not asked to sit on the discussion concerning ice on the pad.

5. (a) Why did Thiokol apparently have difficulty understanding NASA certification test procedures and quality control requirements as compared to other major system contractors for the external tank and orbiter (including the SSME's)?

Answer: We believe the question is directed toward the understanding of temperature specification, since that is the only area of confusion on any element of the SRB. Morton Thiokol has no difficulty in understanding our contractually-applicable specifications. Thiokol has not reviewed the specifications of the other contractors and therefore cannot comment on their requirements.

5. (b) Is the SRB a more difficult system to certify than the others?

Answer: With regards to temperature conditioning, the SRB is much more difficult to certify than the others. The 1.1 million pounds of solid propellant in the 126 foot long SRB is a massive rubber insulator which would take literally weeks to condition to low temperatures in a large environmentally controlled building prior to static test.

5. (c) Are NASA's specifications on the SRB less succinct than on the other major system components?

Answer: We do not have access to or know what the specifications are on the other major system components.