

Healthy Lawn

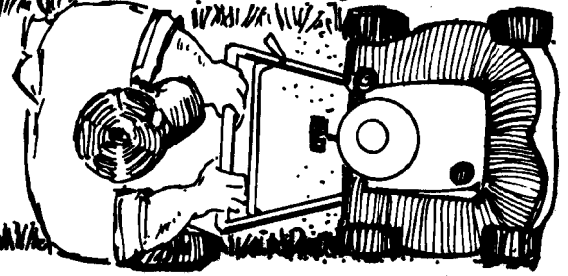

Healthy Environment

Caring for Your Lawn in an Environmentally Friendly Way



United States
Environmental Protection
Agency

Washington DC 20460

HEALTHY LAWN, HEALTHY

Caring for Your Lawn in an Environmentally Friendly Way



Printed on Recycled Paper

Picture a healthy green lawn: perfect for lounging, great for ball games and cookouts, a real asset to your home. But did you know that your lawn—and how you take care of it—can also help the environment? 🌸 Healthy grass provides feeding ground for birds, who find it a rich source of insects, worms, and other food. Thick grass prevents soil erosion, filters contaminants from rainwater, and absorbs many types of airborne pollutants, like dust and soot. Grass is also highly efficient at converting carbon dioxide to oxygen, a process that helps clean the air. 🌸 Caring for your lawn properly can both enhance its appearance and contribute to its environmental benefits. You don't have to be an expert to grow a healthy lawn. Just keep in mind that the secret



ENVIRONMENT

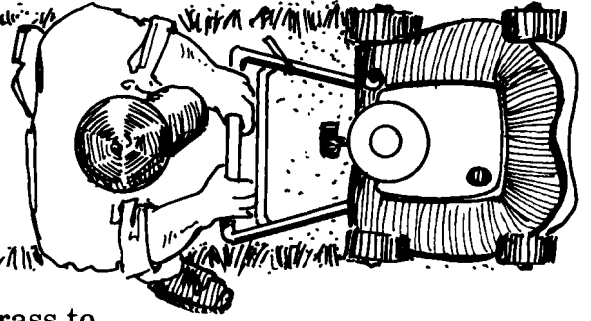

is to work with nature. This means creating conditions for grass to thrive and resist damage from weeds, disease, and insect pests. It means setting realistic goals for your lawn, whether you or a professional lawn care service will be doing the work. And if you choose to use pesticides, it means using them with care so as to get the most benefit and reduce any risks. 🌸 Caring for your lawn in an environmentally sensible way can have a bigger impact than you might think. Your lawn is only a small piece of land, but all the lawns across the country cover a lot of ground. That means you and your lawn care activities, along with everyone else's, can make a difference to the environment. And that's why taking care of the environment begins in our own backyards.

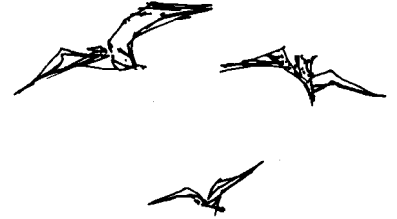

Working With Nature: A Preventive Health Care Program For Your Lawn

To start, think about lawn care as a **preventive** health care program, like one you would use to keep up your own health. The idea is to prevent problems from occurring so you don't have to treat them. As they say, an ounce of prevention is worth a pound of cure. A healthy lawn can out-compete most weeds, survive most insect attacks, and fend off most diseases—before these problems ever get the upper hand.

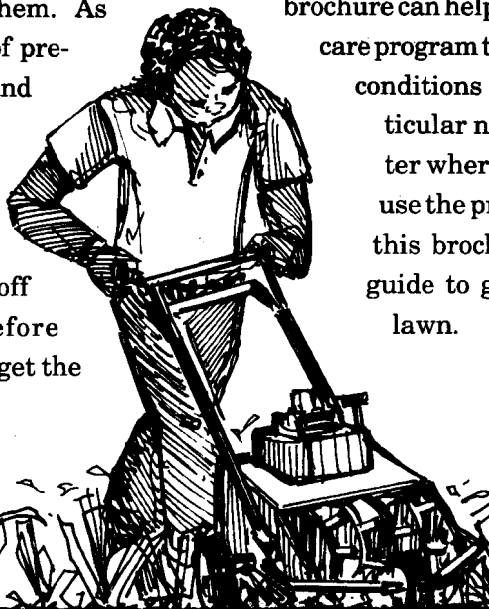

Your lawn care program should be tailored to local conditions—the amount of rainfall you get, for example, and the type of soil you have. The sources listed at the back of this brochure can help you design a lawn care program that suits both local conditions and your own particular needs. But no matter where you live, you can use the program outlined in this brochure as a general guide to growing a healthy lawn.

A preventive health care program for your lawn should have the following steps:

1. Develop healthy soil
2. Choose a grass type that thrives in your climate
3. Mow high, often, and with sharp blades
4. Water deeply but not too often
5. Correct thatch build-up
6. Set realistic goals

1. Develop Healthy Soil

Good soil is the foundation of a healthy lawn. ***To grow well, your lawn needs soil with good texture, some key nutrients, and the right pH, or acidity/alkalinity balance.***

Start by checking the texture of your soil to see whether it's heavy with clay, light and sandy, or somewhere in between. Lawns grow best in soil with intermediate or "loamy" soils that have a mix of clay, silt, and sand. Whatever soil type you have, you can probably improve it by periodically adding organic matter like compost, manure, or grass clippings. Organic matter helps to lighten a predomi-

nantly clay soil and it helps sandy soil retain water and nutrients.

Also check to see if your soil is packed down from lots of use or heavy clay content. This makes it harder for air and water to penetrate, and for grass roots to grow. To loosen compacted soil, some lawns may need to be aerated several times a year. This process involves pulling out plugs of soil to create air spaces, so water and nutrients can again penetrate to the grass roots.

Most lawns need to be fertilized every year, because they need more nitrogen, phosphorus, and potassium

than soils usually contain. These three elements are the primary ingredients found in most lawn fertilizers. It's important not to over-fertilize—you could do more harm to your lawn than good—and it's best to use a slow-release fertilizer that feeds the lawn slowly. It's also important to check the soil's pH. Grass is best able to absorb nutrients in a slightly acidic soil, with a pH of 6.5 to 7.0. ***Soil that is too acidic can be "sweetened" with lime; soil that's not acid enough can be made more "sour" by adding sulfur.***

Have your soil tested periodically to see whether it needs more

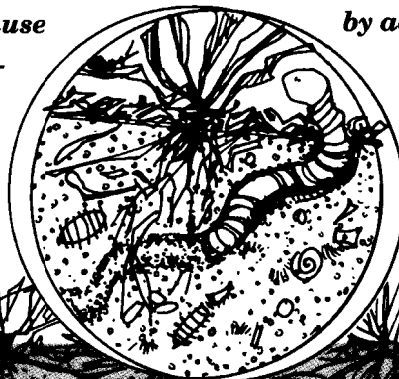

organic matter or the pH needs adjusting. Your county extension agent (listed in your phone book under county government) or local nursery should be able to tell you how to do this. These experts can also help you choose the right fertilizer, compost, and other “soil amendments,” and they can advise you about aerating if your soil is compacted. If a professional service takes care of your lawn, make sure it takes these same steps to develop good soil. There’s no getting around it: your lawn’s health is only as good as the soil it grows in.



2. Choose A Grass Type That Thrives In Your Climate

The right type of grass—one that suits your needs and likes the local weather—will always give better results. Grasses vary in the type of climate they prefer, the amount of water and nutrients they need, their resistance to pests, their tolerance for shade, and the degree of wear they can withstand.

If you are putting in a new lawn, it will be worth your while to do some research to identify the best grass type for your needs.

If you’re working with an established lawn that fails to thrive despite proper care, you might consider replanting with a different type of grass.

Why struggle to grow grass that’s susceptible to fungal disease if you live in a humid climate? Or a water-loving species if you live in an area with water shortages? Grass that is well-adapted to your area will grow better and resist local pests and diseases better.

New grass varieties and mixtures come out on the market every year.

Ask your county extension agent or another one of the sources listed in this brochure for recommendations.

3. Mow High, Often and With Sharp Blades

Mowing high—that is, keeping your lawn a bit long—will produce stronger, healthier grass with fewer pest problems.

Longer grass has more leaf surface to take in sunlight. This enables it to grow thicker and develop a deeper root system, which in turn helps the grass survive drought, tolerate insect damage, and fend off diseases. Longer grass also shades the soil surface keeping it cooler, helping it retain moisture, and

making it difficult for weeds to germinate and grow.

A lawn's ideal length will vary with the type of grass, but many turf grass species are healthiest when kept between 2-1/2 and 3-1/2 inches. The ruler at the back of this brochure will help you judge the best mowing height for your grass variety. You may have to readjust your mower—most are set too low.

It's also important to mow with sharp blades to prevent tearing and injuring the grass. And it's best to

mow often, because grass adjusts better to frequent than infrequent mowing. ***The rule of thumb is to mow often enough that you never cut more than one-third of the height of the grass blades.*** Save some time *and* help your lawn and the environment by leaving short clippings on the grass—where they recycle nitrogen—rather than sending them in bags to the landfill.

You don't have to grow a foot-high meadow to get good results. Just adding an inch will give most lawns a real boost.

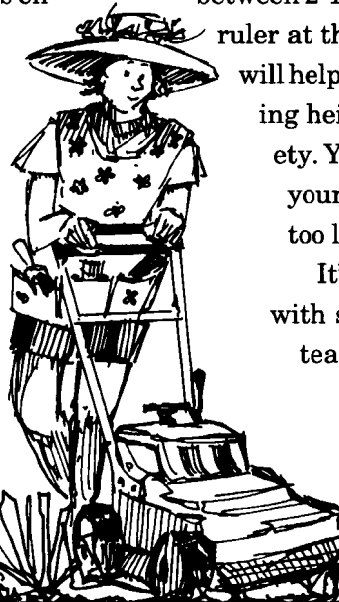

4. Water Deeply But Not Too Often

Watering properly will help your lawn grow deep roots that make it stronger and less vulnerable to drought. Most lawns are watered too often but with too little water. ***It's best to water only when the lawn really needs it, and then to water slowly and deeply.*** This trains the grass roots down. Frequent shallow watering trains the roots to stay near the surface, making the lawn less able to find moisture during dry periods.

Every lawn's watering needs are unique: they depend on local

rainfall, the grass and soil type, and the general health of the lawn. But even in very dry areas, no established home lawn should require daily watering.

Try to water your lawn in a way that imitates a slow, soaking rain, by using trickle irrigation, soaker hoses, or other water-conserving methods. It's also best to water in the early morning, especially during hot summer months, to reduce evaporation. Apply about an inch of water—enough that it soaks 6–8 inches into

the soil. Then let the lawn dry out thoroughly before watering it again.

The best rule is to water only when the lawn begins to wilt from dryness--when the color dulls and footprints stay compressed for more than a few seconds.



5. Correct Thatch Build-Up

All grass forms a layer of dead plant material, known as thatch, between the grass blades and the soil. When thatch gets too thick—deeper than one-half inch—it prevents water and nutrients from penetrating to the soil and grass roots. Some grasses tend to form a thick layer of thatch. **Overuse of fertilizer can also create a heavy layer of thatch.**

You can reduce thatch by raking the lawn or using a machine that slices through the thatch layer to break it up. Sprinkling a thin layer of topsoil or compost over the lawn will also help.

In a healthy lawn, microorganisms and earthworms help keep the thatch layer in balance by decomposing it and releasing the nutrients into the soil.

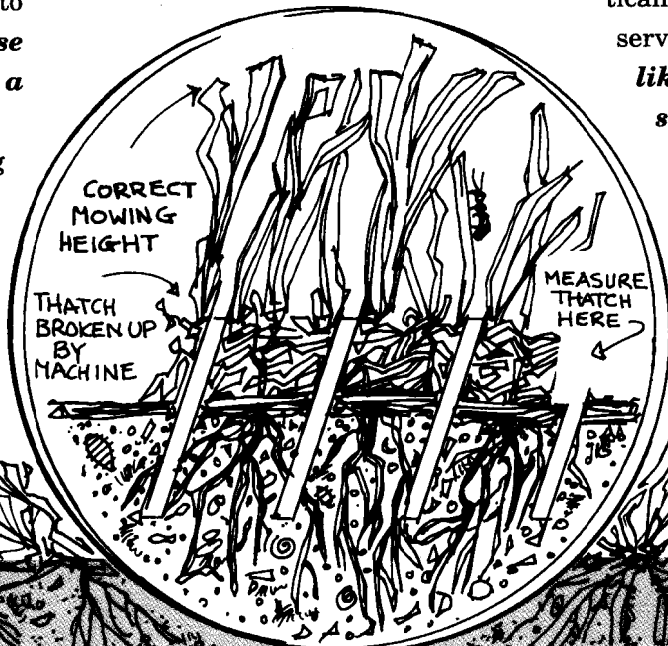

6. Set Realistic Goals

Setting realistic goals will allow you to conduct an environmentally sensible lawn care program. It's probably not necessary to aim for putting-green perfection. Did you know that a lawn with 15 percent weeds can look practically weed-free to the average observer? ***Even a healthy lawn is likely to have some weeds or insect pests. But it will also have beneficial insects and other organisms that help keep pests under control.***

Also realize that grass just can't grow well in certain spots. Why fight a losing battle

with your lawn, when you have other options? At the base of a tree, for example, you might have better luck with wood chips or shade-loving ornamental plants like ivy, periwinkle, or pachysandra. If your climate is very dry, consider converting some of your lawn to dry-garden landscaping. It could save time, money, and water resources.

What Is IPM?

Integrated Pest Management is essentially common-sense pest control. IPM is not a new concept; some forms of it have been practiced for centuries.

IPM involves the carefully managed use of three different pest control tactics—biological, cultural, and chemical—to get the best long-term results with the least disruption of the environment. Biological control means using natural enemies of the pest, like lady bugs to control aphids. Cultural or horticultural control in-

volves the use of gardening methods, like mowing high to shade out weeds. Chemical control involves the judicious use of pesticides.

IPM is a highly effective approach that minimizes the use of pesticides and maximizes the use of natural processes. Lawn care professionals who use IPM should have a sophisticated understanding of the ecosystem of your turf and the available pest control tactics. Home gardeners can also practice IPM by following the steps outlined in this brochure.

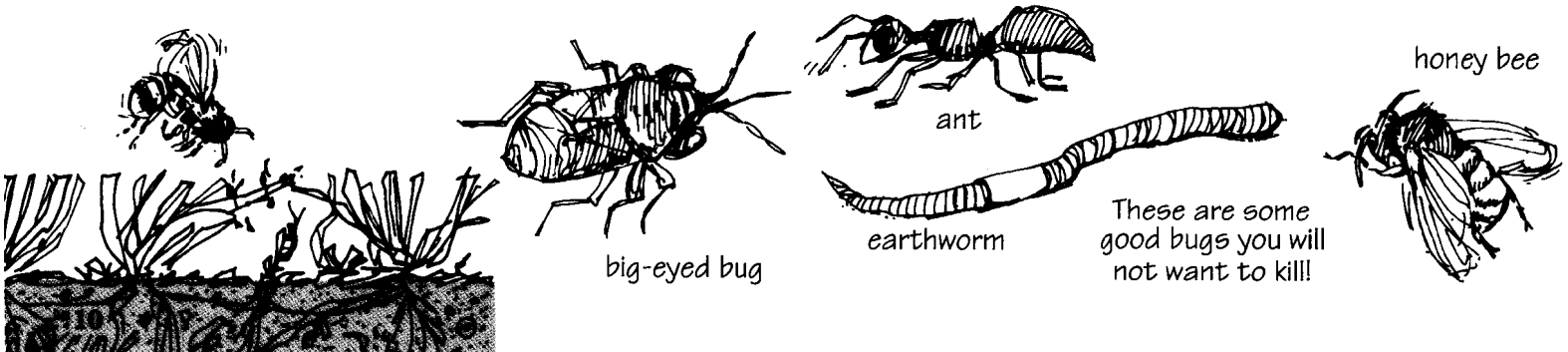

big-eyed bug

ant

earthworm

honey bee

These are some good bugs you will not want to kill!

IPM*

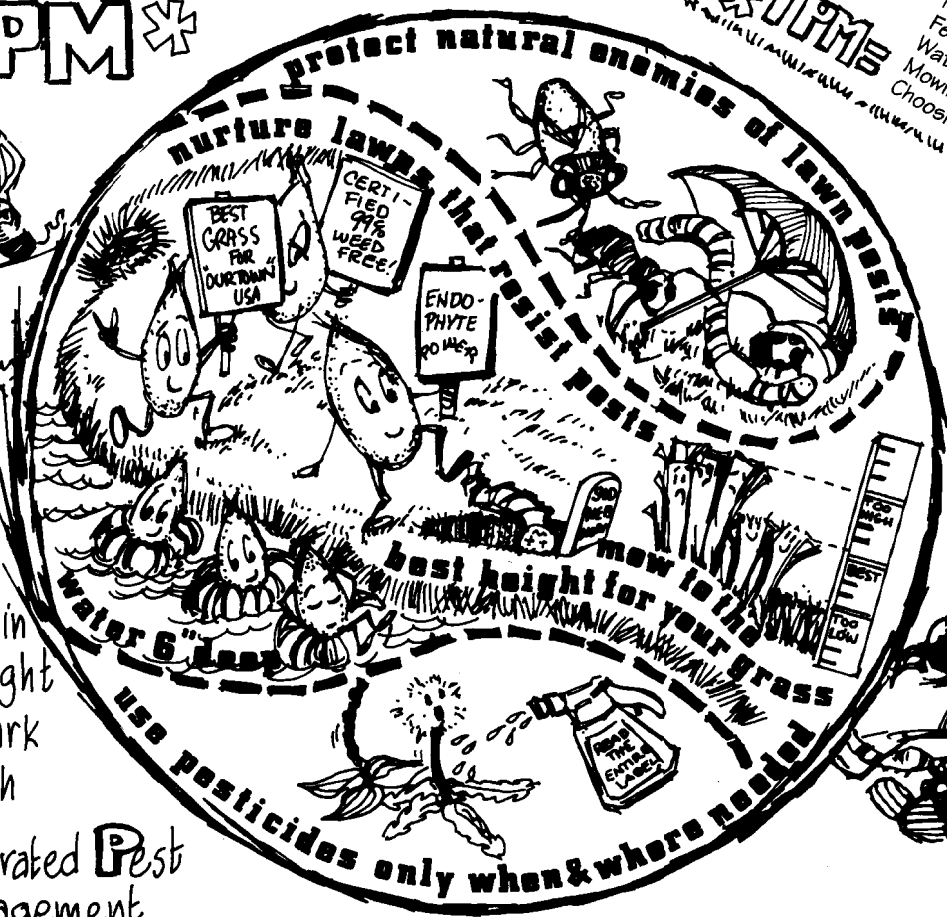

*IPM

- Protecting the Environment
- Fertilizing only when Needed
- Mowing Properly
- Choosing Best Pest Control Methods
- Aerating
- Setting Thresholds
- Monitoring
- Dethatching



you're in
the right
Ballpark
with

*
Integrated **P**est
Management

Tips For Using Pesticides

Sometimes, even with good lawn care practices, weather conditions or other factors can cause pest problems to develop. Pesticides can help control many lawn pests. But pesticides have risks as well as benefits, and it's important to use them properly.

The chemicals we call pesticides include insecticides, herbicides, and fungicides. These products are designed to kill or control pest insects, weeds, and fungal diseases. Pesticides can be very effective. But don't be tempted to rely solely on pesticides as a quick-fix solution to any lawn problem. Serious, ongoing pest problems are often a sign that your lawn is

not getting everything it needs. In other words, the pests may be a symptom of an underlying problem. You need to correct the underlying problem to reduce the chance that the pest will reappear.

All pesticides are toxic to some degree. This means they can pose some risk to you, to your children and pets, and to any wildlife that venture onto your lawn—especially if these chemicals are overused or carelessly applied. Pesticides can also kill earthworms and other beneficial

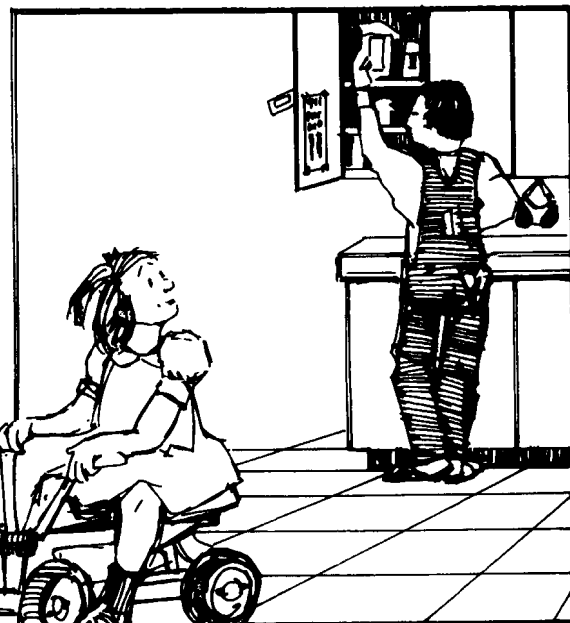

Store pesticides out of children's reach in a locked cabinet or garden shed.

organisms, disrupting the ecological balance of your lawn.

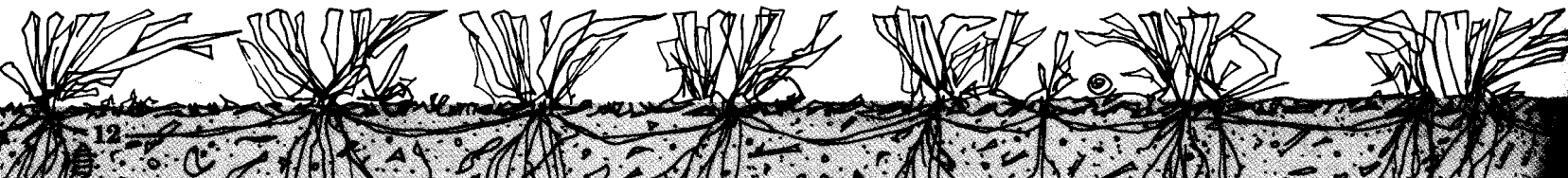

When Spraying, Protect



your skin



your eyes



your lungs

Wash this clothing separately
before using it again.

Before Using Any Pesticide, Be Sure To Review These Basic Rules

1. Take safety precautions. Never assume a pesticide is harmless.

- Read the entire label and follow its instructions. Use only the amount directed, at the time and under the conditions specified, and for the purpose listed.
- Be sure to wear any protective clothing—like gloves, long sleeves, and long pants—indicated on the label. Wash this clothing separately before using it again.
- Keep children and pets away from pesticides, and make sure no one goes on a treated lawn for at least the time prescribed by the pesticide label.
- Remember to follow any state or local requirements for posting your treated lawn or notifying your neighbors that a pesticide has been applied.
- Store and dispose of pesticides properly, according to the label directions and any state and local regulations.

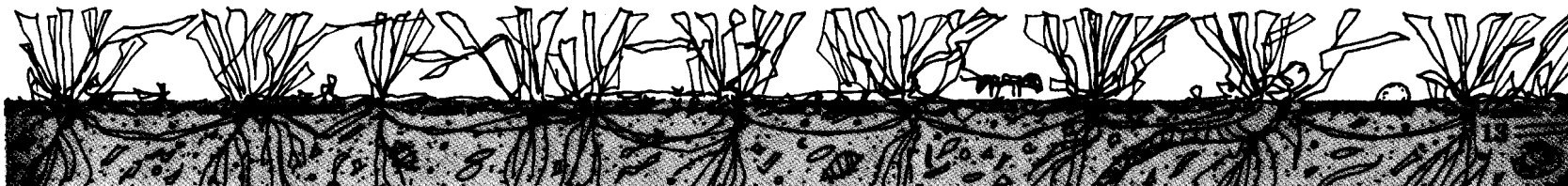

2. Use pesticides to minimize pests, not eradicate them. The latter is often impossible and unnecessary.
3. Be sure you have accurately identified the pest so you can choose the best pesticide for the job and use it most effectively. Obtain professional advice from your county extension agent or a local expert.
4. Spot treat whenever possible. In most cases, it isn't necessary to treat the whole lawn with pesticides if the problem is confined to certain areas. Spraying more than necessary is wasteful and can be environmentally damaging.

If you have questions about a pesticide, call EPA's toll-free National Pesticide Telecommunications Network (1-800-858-7378). For general information on minimizing pesticide risks, call or write EPA for a free copy of the *Citizen's Guide to Pesticides*. The number to call is 703-305-5017; the address is: EPA, Office of Pesticide Programs, Field Operations Division, H7506C, 401 M Street, S.W., Washington, D.C. 20460.



Choosing A Lawn Care Service

Many people choose to hire a professional company to help maintain their lawn. Lawn care companies offer a range of services, from fertilizing and pest control to aerating, mowing, and renovation.

Lawn care companies should follow the same healthy lawn program outlined in this brochure. They should also follow the same precautions for minimizing pesticide risks.

How can you be sure that a service will do these things? Start by asking questions like these:

Q. Is the company licensed?

A. Nearly all states require lawn care companies to be licensed. The qualifications for obtaining a license vary from state to state, but having a license is one indication that the company is reputable and operating legally.

Q. Does the company have a good track record?

A. Ask neighbors and friends who have dealt with the company if they were satisfied with the service they received. Call the Better Business Bureau or the state or local consumer protection office listed in your phone

book; have they received any complaints about the company? Determine from the state pesticide regulatory agency if the company has a history of violations.

Q. Is the company affiliated with a professional lawn care association?

A. Affiliation with a professional association helps members to stay informed of new developments in the lawn care field.

Q. Does the company offer a variety of pest management approaches? Does it apply pesticides on a set schedule or only when they are really needed? Does it use integrated pest management, or "IPM"—an approach that

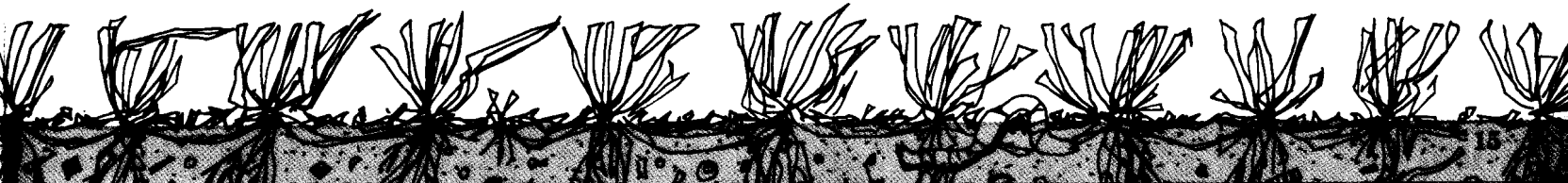

often reduces pesticide use by combining it with other, non-chemical methods of pest control?

A. More and more lawn companies are offering integrated pest management (IPM) in response to public concern about pesticides. Be aware that IPM is a general term and that companies may use it to describe a wide range of activities. Find out exactly what a company means if it says it uses IPM.

Q. Is the company willing to help you understand your lawn's problems and the solutions?

A. Lawn services generally apply fertilizers and pesticides. But you may be the one who mows and waters—and poor watering and mowing practices can lead to disappointing results. The



company should tell you how it plans to take care of your lawn, and advise you about the work you need to do to keep your lawn in good shape.

Q. Will the company tell you what pesticides it applies to your lawn and why, and what health and environmental risks may be presented by their use?

A. You have a right to this information. If asked, the company should readily supply it. All pesticides sold legally in the United States are registered by EPA, but such registration is *not* a guarantee of safety. Ask to see a copy of pesticide labels to make sure they bear an EPA registration number, and to review the directions that should be followed. If the company can't answer your questions about the chemicals it uses, call NPTN (1-800-858-7378) for more information.

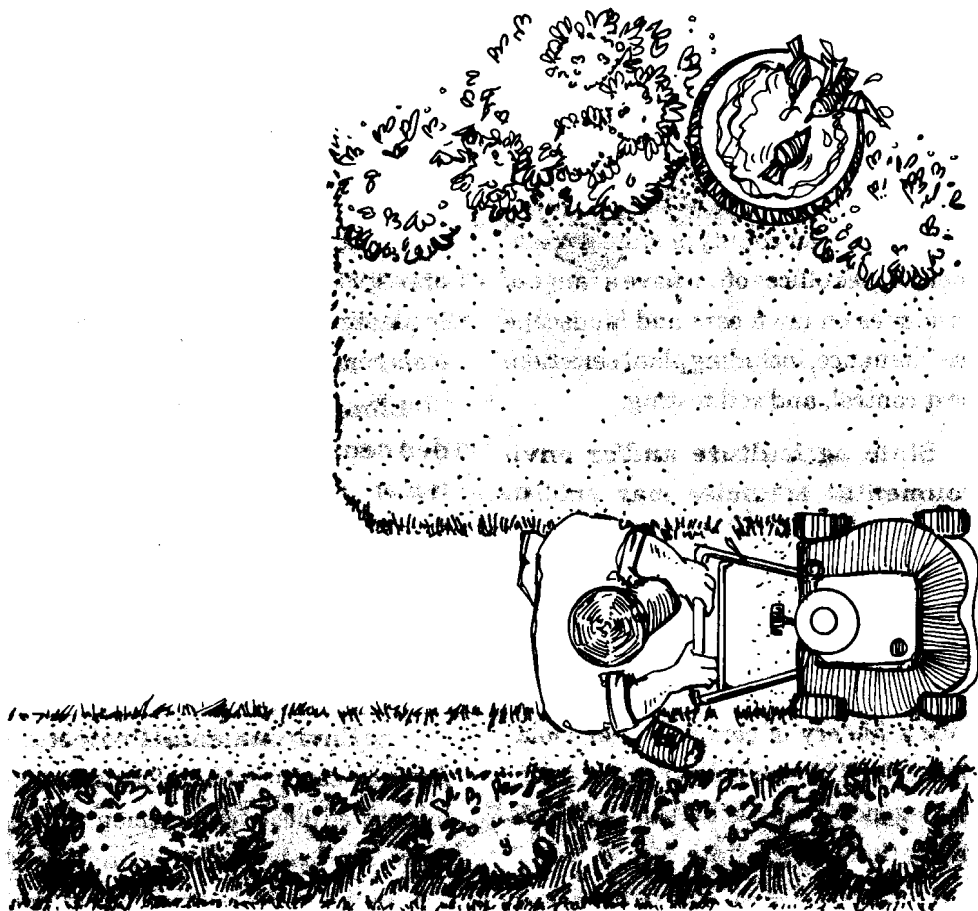

For More Information

Affiliated with the Land Grant university in each state is a system of **County Cooperative Extension Offices**. Usually listed in the telephone directory under county or state government, these offices often have a range of resources on lawn care and landscape maintenance, including plant selection, pest control, and soil testing.

State agriculture and/or environmental agencies may publish information on pests and pest management strategies. The state pesticide regulatory agency can provide information on pesticide regulations, and may also have information on companies with a history of complaints or violations. NPTN (see below) can identify the agency responsible for pesticide regulation in each state.

The **National Pesticide Telecommunications Network** is a toll-free, 24-hour information service that can be reached by calling 1-800-858-7378 or by FAX at 806-743-3094. The operators can provide a wide range of information about the health effects of pesticides, and provide assistance in dealing with pesticide-related emergencies.

Libraries, bookstores, and garden centers usually have a wide selection of books that discuss lawn care and other aspects of landscape management. Garden centers may also have telephone hotlines or experts available on the premises to answer your gardening questions.

The **Environmental Protection Agency** can provide information on integrated pest management strategies for lawn care. Write EPA's

Office of Pesticide Programs, Field Operations Division (H7506C), 401 M St., S.W., Washington, D.C. 20460.

Some **suppliers of lawn care products** can provide helpful tips, answer questions, and help identify problems. Look for information/hotline numbers on product packaging.

The **Bio-Integral Resource Center (BIRC)**, a non-profit organization formed in 1978 through an EPA grant, has information on least-toxic methods for lawn care. BIRC's address is: P.O. Box 7414, Berkeley, CA 94707.

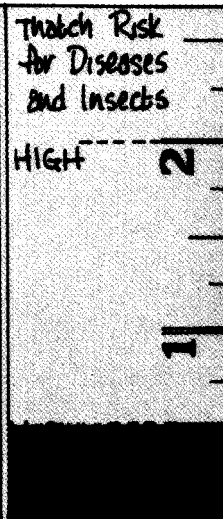
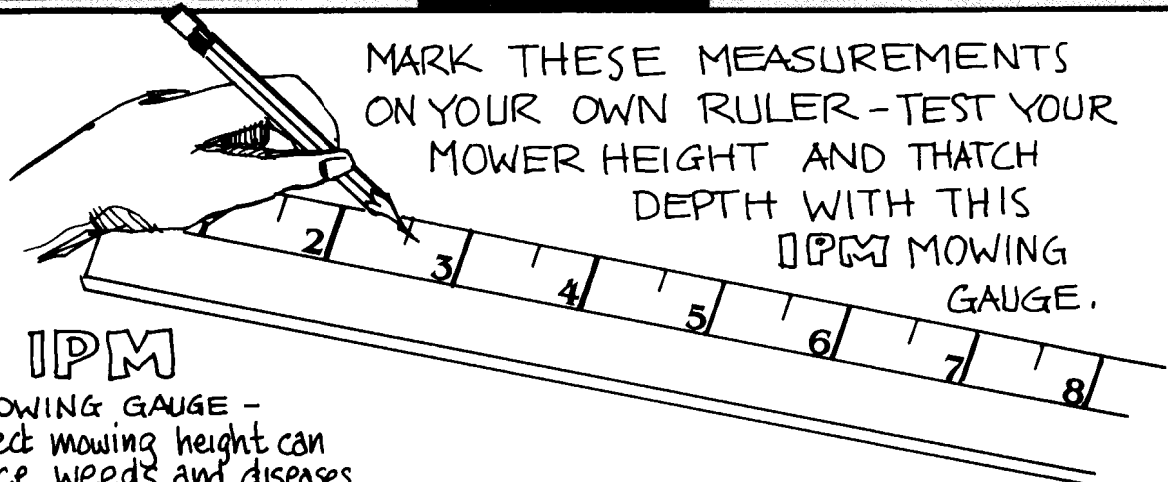
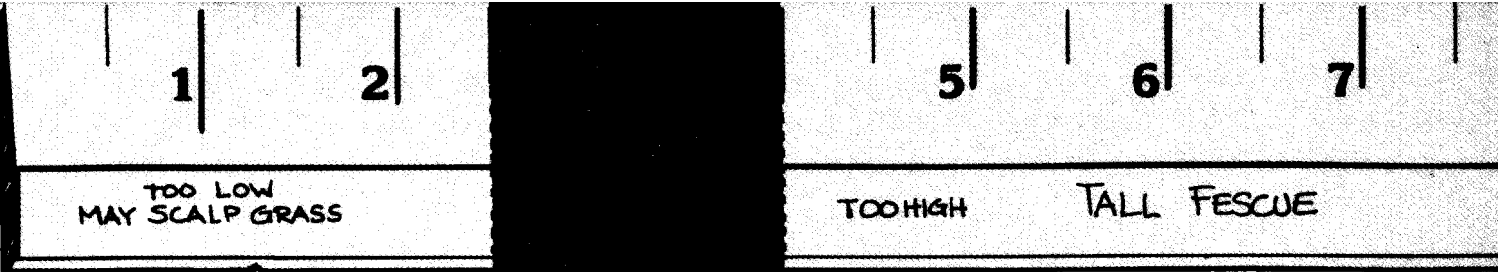

IPM

-MOWING GAUGE -
 correct mowing height can
 reduce weeds and diseases
 by 50 to 80%.

